

Keysight 3458A Multimeter

Calibration
Manual

Notices

Copyright Notice

© Keysight Technologies 1988 - 2021
No part of this manual may be reproduced in any form or by any means (including electronic storage and retrieval or translation into a foreign language) without prior agreement and written consent from Keysight Technologies as governed by United States and international copyright laws.

Manual Part Number

03458-90017

Edition

Edition 10, September 15, 2021

Printed in:

Printed in Malaysia

Published by:

Keysight Technologies
Bayan Lepas Free Industrial Zone,
11900 Penang, Malaysia

Technology Licenses

The hardware and/or software described in this document are furnished under a license and may be used or copied only in accordance with the terms of such license.

Declaration of Conformity

Declarations of Conformity for this product and for other Keysight products may be downloaded from the Web. Go to <http://www.keysight.com/go/conformity>. You can then search by product number to find the latest Declaration of Conformity.

U.S. Government Rights

The Software is “commercial computer software,” as defined by Federal Acquisition Regulation (“FAR”) 2.101. Pursuant to FAR 12.212 and 27.405-3 and Department of Defense FAR Supplement (“DFARS”) 227.7202, the U.S. government acquires commercial computer software under the same terms by which the software is customarily provided to the public. Accordingly, Keysight provides the Software to U.S. government customers under its standard commercial license, which is embodied in its End User License Agreement (EULA), a copy of which can be found at <http://www.keysight.com/find/sweula>. The license set forth in the EULA represents the exclusive authority by which the U.S. government may use, modify, distribute, or disclose the Software. The EULA and the license set forth therein, does not require or permit, among other things, that Keysight: (1) Furnish technical information related to commercial computer software or commercial computer software documentation that is not customarily provided to the public; or (2) Relinquish to, or otherwise provide, the government rights in excess of these rights customarily provided to the public to use, modify, reproduce, release, perform, display, or disclose commercial computer software or commercial computer software documentation. No additional government requirements beyond those set forth in the EULA shall apply, except to the extent that those terms, rights, or licenses are explicitly required from all providers of commercial computer software pursuant to the FAR and the DFARS and are set forth specifically in writing elsewhere in the EULA. Keysight shall be under no obligation to update, revise or otherwise modify the Software. With respect to any technical data as defined by FAR 2.101, pursuant to FAR 12.211 and 27.404.2 and DFARS 227.7102, the U.S. government acquires no greater than Limited Rights as defined in FAR 27.401 or DFAR 227.7103-5 (c), as applicable in any technical data.

Warranty

THE MATERIAL CONTAINED IN THIS DOCUMENT IS PROVIDED “AS IS,” AND IS SUBJECT TO BEING CHANGED, WITHOUT NOTICE, IN FUTURE EDITIONS. FURTHER, TO THE MAXIMUM EXTENT PERMITTED BY APPLICABLE LAW, KEYSIGHT DISCLAIMS ALL WARRANTIES, EITHER EXPRESS OR IMPLIED, WITH REGARD TO THIS MANUAL AND ANY INFORMATION CONTAINED HEREIN, INCLUDING BUT NOT LIMITED TO THE IMPLIED WARRANTIES OF MERCHANTABILITY AND FITNESS FOR A PARTICULAR PURPOSE. KEYSIGHT SHALL NOT BE LIABLE FOR ERRORS OR FOR INCIDENTAL OR CONSEQUENTIAL DAMAGES IN CONNECTION WITH THE FURNISHING, USE, OR PERFORMANCE OF THIS DOCUMENT OR OF ANY INFORMATION CONTAINED HEREIN. SHOULD KEYSIGHT AND THE USER HAVE A SEPARATE WRITTEN AGREEMENT WITH WARRANTY TERMS COVERING THE MATERIAL IN THIS DOCUMENT THAT CONFLICT WITH THESE TERMS, THE WARRANTY TERMS IN THE SEPARATE AGREEMENT SHALL CONTROL.

Safety Information

CAUTION

A CAUTION notice denotes a hazard. It calls attention to an operating procedure, practice, or the like that, if not correctly performed or adhered to, could result in damage to the product or loss of important data. Do not proceed beyond a CAUTION notice until the indicated conditions are fully understood and met.

WARNING

A WARNING notice denotes a hazard. It calls attention to an operating procedure, practice, or the like that, if not correctly performed or adhered to, could result in personal injury or death. Do not proceed beyond a WARNING notice until the indicated conditions are fully understood and met.

KEYSIGHT TECHNOLOGIES WARRANTY STATEMENT

KEYSIGHT PRODUCT: 3458A multimeter

DURATION OF WARRANTY: 1 year

- 1** Keysight Technologies warrants Keysight hardware, accessories and supplies against defects in materials and workmanship for the period specified above. If Keysight receives notice of such defects during the warranty period, Keysight will, at its option, either repair or replace products which prove to be defective. Replacement products may be either new or like-new.
- 2** Keysight warrants that Keysight software will not fail to execute its programming instructions, for the period specified above, due to defects in material and workmanship when properly installed and used. If Keysight receives notice of such defects during the warranty period, Keysight will replace software media which does not execute its programming instructions due to such defects.
- 3** Keysight does not warrant that the operation of Keysight products will be interrupted or error free. If Keysight is unable, within a reasonable time, to repair or replace any product to a condition as warranted, customer will be entitled to a refund of the purchase price upon prompt return of the product.
- 4** Keysight products may contain remanufactured parts equivalent to new in performance or may have been subject to incidental use.
- 5** The warranty period begins on the date of delivery or on the date of installation if installed by Keysight. If customer schedules or delays Keysight installation more than 30 days after delivery, warranty begins on the 31st day from delivery.
- 6** Warranty does not apply to defects resulting from (a) improper or inadequate maintenance or calibration, (b) software, interfacing, parts or supplies not supplied by Keysight, (c) unauthorized modification or misuse, (d) operation outside of the published environmental specifications for the product, or (e) improper site preparation or maintenance.
- 7** TO THE EXTENT ALLOWED BY LOCAL LAW, THE ABOVE WARRANTIES ARE EXCLUSIVE AND NO OTHER WARRANTY OR CONDITION, WHETHER WRITTEN OR ORAL, IS EXPRESSED OR IMPLIED AND KEYSIGHT SPECIFICALLY DISCLAIMS ANY IMPLIED WARRANTY OR CONDITIONS OF MERCHANTABILITY, SATISFACTORY QUALITY, AND FITNESS FOR A PARTICULAR PURPOSE.







- 8** Keysight will be liable for damage to tangible property per incident up to the greater of \$300,000 or the actual amount paid for the product that is the subject of the claim, and for damages for bodily injury or death, to the extent that all such damages are determined by a court of competent jurisdiction to have been directly caused by a defective Keysight product.
- 9** TO THE EXTENT ALLOWED BY LOCAL LAW, THE REMEDIES IN THIS WARRANTY STATEMENT ARE CUSTOMER'S SOLE AND EXCLUSIVE REMEDIES. EXCEPT AS INDICATED ABOVE, IN NO EVENT WILL KEYSIGHT OR ITS SUPPLIERS BE LIABLE FOR LOSS OF DATA OR FOR DIRECT, SPECIAL, INCIDENTAL, CONSEQUENTIAL (INCLUDING LOST PROFIT OR DATA), OR OTHER DAMAGE, WHETHER BASED IN CONTRACT, TORT, OR OTHERWISE. FOR CONSUMER TRANSACTIONS IN AUSTRALIA AND NEW ZEALAND: THE WARRANTY TERMS CONTAINED IN THIS STATEMENT, EXCEPT TO THE EXTENT LAWFULLY PERMITTED, DO NOT EXCLUDE, RESTRICT OR MODIFY AND ARE IN ADDITION TO THE MANDATORY STATUTORY RIGHTS APPLICABLE TO THE SALE OF THIS PRODUCT TO YOU.

U.S. Government Restricted Rights

The Software and Documentation have been developed entirely at private expense. They are delivered and licensed as “commercial computer software” as defined in DFARS 252.227- 7013 (Oct 1988), DFARS 252.211-7015 (May 1991) or DFARS 252.227-7014 (Jun 1995), as a “commercial item” as defined in FAR 2.101(a), or as “Restricted computer software” as defined in FAR 52.227-19 (Jun 1987)(or any equivalent agency regulation or contract clause), whichever is applicable. You have only those rights provided for such Software and Documentation by the applicable FAR or DFARS clause or the Keysight standard software agreement for the product involved.

Safety Symbols

The following symbols on the instrument and in the documentation indicate precautions which must be taken to maintain safe operation of the instrument.

 Direct current (DC)	 Alternating current (AC)
 WARNING, RISK OF ELECTRIC SHOCK.	 Instruction manual symbol affixed to Alternating current (AC) product. Indicates that the user must refer to the manual for specific WARNING or CAUTION information to avoid personal injury or damage to the product.
 Indicates the field wiring terminal that must be connected to earth ground before operating the equipment – protects against electrical shock in case of fault.	 Frame or chassis ground terminal—typically connects to the equipment's metal frame.

Safety Considerations

Read the information below before using this instrument.

The following general safety precautions must be observed during all phases of operation, service, and repair of this instrument. Failure to comply with these precautions or with specific warnings elsewhere in this manual violates safety standards for design, manufacture, and intended use of the instrument. Keysight Technologies assumes no liability for the customer's failure to comply with these requirements.

WARNING

- **Ground the equipment:** For Safety Class 1 equipment (equipment having a protective earth terminal), an uninterruptible safety earth ground must be provided from the mains power source to the product input wiring terminals or supplied power cable.
 - **DO NOT** operate the product in an explosive atmosphere or in the presence of flammable gases or fumes.
 - **For continued protection** against fire, replace the line fuse(s) only with fuse(s) of the same voltage and current rating and type. **DO NOT** use repaired fuses or short-circuited fuse holders.
 - **Keep away from live circuits:** Operating personnel must not remove equipment covers or shields. Procedures involving the removal of covers or shields are for use by service-trained personnel only. Under certain conditions, dangerous voltages may exist even with the equipment switched off. To avoid dangerous electrical shock, **DO NOT** perform procedures involving cover or shield removal unless you are qualified to do so.
 - **DO NOT operate damaged equipment:** Whenever it is possible that the safety protection features built into this product have been impaired, either through physical damage, excessive moisture, or any other reason, **REMOVE POWER** and do not use the product until safe operation can be verified by service-trained personnel. If necessary, return the product to Keysight for service and repair to ensure that safety features are maintained.
-

WARNING

- **DO NOT service or adjust alone:** Do not attempt internal service or adjustment unless another person, capable of rendering first aid and resuscitation, is present.
 - **DO NOT substitute parts or modify equipment:** Because of the danger of introducing additional hazards, do not install substitute parts or perform any unauthorized modification to the product. Return the product to Keysight for service and repair to ensure that safety features are maintained.
 - **Measuring high voltages is always hazardous:** ALL multimeter input terminals (both front and rear) must be considered hazardous whenever inputs greater than 42V (dc or peak) are connected to ANY input terminal.
 - **Permanent wiring of hazardous voltage** or sources capable of delivering greater than 150 VA should be labeled, fused, or in some other way protected against accidental bridging or equipment failure.
 - **DO NOT** leave measurement terminals energized when not in use.
 - **DO NOT** use the front/rear switch to multiplex hazardous signals between the front and rear terminals of the multimeter.
-

Waste Electrical and Electronic Equipment (WEEE) Directive

This instrument complies with the WEEE Directive marking requirement. This affixed product label indicates that you must not discard this electrical or electronic product in domestic household waste.

Product category:

With reference to the equipment types in the WEEE directive Annex 1, this instrument is classified as a “Monitoring and Control Instrument” product.

The affixed product label is as shown below.



Do not dispose in domestic household waste.

To return this unwanted instrument, contact your nearest Keysight Service Center, or visit <http://about.keysight.com/en/companyinfo/environment/takeback.shtml> for more information.

Sales and Technical Support

To contact Keysight for sales and technical support, refer to the support links on the following Keysight websites:

- www.keysight.com/find/3458A
(product-specific information and support, software and documentation updates)
- www.keysight.com/find/assist
(worldwide contact information for repair and service)

THIS PAGE HAS BEEN INTENTIONALLY LEFT BLANK.

Table of Contents

Keysight Technologies WARRANTY STATEMENT	3
U.S. Government Restricted Rights	5
Safety Symbols	6
Safety Considerations	7
Waste Electrical and Electronic Equipment (WEEE) Directive	9
Product category:	9
Sales and Technical Support	9
1 3458A Calibration Introduction	
Introduction	20
Calibration Adjustment Interval	21
Calibration Security	21
Security code	21
Changing the security code	21
Hardware lock-out of calibration	23
Number of calibrations	23
Monitoring for CAL violations	24
Monitoring Calibration Constants	25
2 Operational Verification Tests	
Introduction	28
Operational Tests	29
Required equipment	29
Preliminary steps	29
2-wire ohms function offset test	30
4-wire ohms function gain test	31
DC voltage function gain test	32
DC voltage function offset test	33
3 Adjustment Procedures	
Introduction	36

Required Equipment	37
Preliminary Adjustment Procedure	38
Front Terminal Offset Adjustment	40
Rear Terminal Offset Adjustment	41
DC Gain Adjustment	42
Resistance and DC current adjustment	43
AC Adjustment	46

4 Performance Verification Tests

Introduction	54
Required equipment	54
Test card	54
Calibration cycle	55
Test considerations	55
General test procedure	57
DC Voltage Performance Tests	60
Required equipment	60
Preliminary steps	60
DC voltage function offset test	61
DC voltage function gain test	62
Analog AC voltage performance tests	65
Required equipment	65
Preliminary steps	65
AC voltage test procedure	66
DC Current Performance Tests	68
Required equipment	68
Preliminary steps	68
DC current function offset test	69
DC current function gain test	70
Ohms Performance Tests	72
Required equipment	72
Preliminary steps	72
2-wire ohms function offset test	73

4-wire ohms function offset test	73
4-wire ohms function gain test	74
Frequency Counter Performance Tests	76
Required equipment	76
Preliminary steps	76
Frequency counter accuracy test	76

5 Command Summary

Introduction	84
ACAL	86
CAL	88
CAL?	90
CALNUM?	104
CALSTR	105
REV?	107
SCAL	108
SECURE	111
TEMP?	113
TEST	114

A Specifications

B Electronic Calibration of the 3458A (Product Note 3458A-3)

Introduction	118
Saving Calibration Time and Money	119
The basis for auto-calibration	119
Offset adjustments	121
DC gain adjustments	121
Resistance and DC current adjustments	122
AC flatness and gain adjustments	123
One-time adjustments	125
Traceability	125
Summary	126

Externally derived calibration constants 126

THIS PAGE HAS BEEN INTENTIONALLY LEFT BLANK.

List of Figures

Figure 3-1	4-terminal short	39
Figure 3-2	DC gain adjustment connections	43
Figure 3-3	Resistance and DC current adjustment connections	45
Figure 3-4	Characterizing the adjustment setup	48
Figure 3-5	AC adjustment connections	49
Figure 4-1	General test procedure	59

THIS PAGE HAS BEEN INTENTIONALLY LEFT BLANK.

List of Tables

Table 4-1	Offset performance tests	61
Table 4-2	DCV gain performance tests	63
Table 4-3	AC performance tests	67
Table 4-4	Current offset performance tests	69
Table 4-5	DCI gain performance tests	70
Table 4-6	OHMF gain performance tests	74

THIS PAGE HAS BEEN INTENTIONALLY LEFT BLANK.

1 3458A Calibration Introduction

Introduction	20
Calibration Adjustment Interval	21
Calibration Security	21
Monitoring Calibration Constants	25

Introduction

This manual provides operation verification procedures, adjustment procedures, and performance verification procedures for the 3458A multimeter.

WARNING

The information contained in this manual is intended for the use of service-trained personnel who understand electronic circuitry and are aware of the hazards involved. Do not attempt to perform any of the procedures outlined in this section unless you are qualified to do so.

The manual contains five chapters and two appendixes.

Chapter 1: Introduction describes the manual contents and calibration security features of the 3458A.

Chapter 2: Operational Verification provides a short test procedure to verify that the multimeter is functioning properly.

Chapter 3: Adjustment Procedure gives the procedures for adjusting the multimeter to obtain best accuracy.

Chapter 4: Performance Verification is comprised of test procedures used to verify that all parts of the instrument are functioning properly and within specification. This chapter contains Test Cards for recording the results of each test.

Chapter 5: Command Summary provides an alphabetical summary of commands that are used in adjusting and performance testing the 3458A.

Appendix A: 3458A Technical Specifications

Appendix B: Electronic Calibration of the 3458A, Product Note 3458A-3

Calibration Adjustment Interval

The instrument should be calibrated on a regular interval determined by the accuracy requirements of your application. A 1-year interval is adequate for most applications. Accuracy specifications are warranted only if calibration is made at regular calibration intervals.

Calibration Security

The calibration security feature of the 3458A allows the person responsible for calibration to enter a security code to prevent accidental or unauthorized calibration (CAL) or autocalibration (ACAL). The SECURE command is used to change the security code of the 3458A.

Security code

The security code is an integer from $-2.1E-9$ to $2.1E9$. If the number specified is not an integer, the multimeter rounds it to an integer value. The multimeter is shipped from the factory with its security code set to 3458. Specifying 0 for the new_code in the SECURE command disables the security feature making it no longer necessary to enter the security code to perform a calibration or autocal.

Changing the security code

The security code is changed with the SECURE command which has the following syntax:

```
SECURE old_code, new_code [,acal_secure]
```

The procedure for changing the security code is as follows:

- 1 Access the SECURE command. (Press the blue SHIFT key, then the S menu key. If using the full command menu use the ↓ scroll key to display the SECURE command).
- 2 Enter the old security code, the delimiter (,) and the new security code. If you want to control the auto calibration of the multimeter, enter another delimiter (,) and the acal_secure parameter ON. The instrument is shipped from the factory with the security code set to 3458 and the acal_secure parameter set to ON (security code required to do an acal).

3 Press the Enter key. The instrument will now respond to the new security code.

In the event the security code is unknown, the security feature can be disabled to permit a new code to be entered. Perform the following procedure to disable the current unknown security code and enter a known code:

- a** Turn the instrument off and remove the line cord and all external inputs to the 3458A.
- b** Remove the top cover.
 - i** Remove both rear handle brackets with a #2 Pozidrive.
 - ii** Remove the rear bezel by loosening the four #15 TORX screws.
 - iii** With the back of the instrument facing you, remove the #10 TORX screw securing the top cover to the right side.
 - iv** Remove the top cover.
- c** Change the position of jumper JM600 on the 03458-66505 assembly, or option 001 03458-66515 assembly from the left position to the right position (front of instrument facing you).
- d** Reconnect the power and turn the instrument on.
- e** Access the SECURE command (Press the blue SHIFT key then the S MENU key. Use the ↓ scroll key if in the full command menu to display the SECURE command).
- f** Enter the number 0 followed by the delimiter (,) and the security code you want to use.
- g** Press the ENTER key.
- h** Turn the instrument off, disconnect power, and return jumper JM600 to the left position (front of instrument facing you).
- i** Replace the top cover and reconnect power. The instrument will now respond to the new security code you just entered.

NOTE

When jumper JM600 is in the right position, the security feature is disabled (i.e. old_code = 0). It is possible to calibrate the instrument without entering a security number under these conditions. If a new security number (new_code of SECURE command) is not entered while the jumper is in the right position the original number will again be in effect when jumper JM600 is returned to the left position.

Hardware lock-out of calibration

You can set jumper J132 on the 03458-66505 or -66515 (option 001) assembly to require removing the instrument cover and repositioning this jumper whenever adjustments (CAL command) are to be made. Use the following procedure to set hardware “lock-out” of the CAL and ACAL commands.

- 1** Remove the instrument top cover as described in steps a and b of the previous section.
- 2** With the instrument front facing you, set jumper J132 to the right position. Neither the CAL or ACAL command can be executed when the jumper is in this position even when the correct security code is entered.
- 3** Replace the top cover.

To perform an adjustment with the CAL command or do an auto-calibration with the ACAL command, you must remove the top cover and set jumper J132 to the left position (instrument front facing you). You may attach a seal to the top cover that must be broken to remove the cover indicating if unauthorized access to the hardware has occurred.

Number of calibrations

You can monitor the number of times calibration has been performed (CAL and ACAL combined if ACAL is secured by the SECURE command) by using the CALNUM? command. CALNUM? (calibration number query) returns a decimal number indicating the number of times the multimeter has been unsecured and adjusted. The number of calibrations is stored in cal-protected memory and is not lost when power is removed. The calibration number is incremented by 1 whenever the multimeter is unsecured and a CAL. (or ACAL if secured) is executed. If autocal is secured, the calibration number is also incremented by 1 whenever an autocal is performed; if unsecured, autocal does not affect the calibration number.

NOTE

The multimeter was adjusted before it left the factory. This has incremented the calibration number. When you receive the multimeter, read the calibration number to determine the initial value you start with. The procedure for reading the number of calibrations is presented after this note.

Read the number of calibrations with the following procedure:

- 1** Access the CALNUM? command. In the full command menu, press the blue SHIFT key then the C menu key. Use the ↓ scroll key to display the CALNUM? command. (Full command menu is obtained by pressing the blue SHIFT key, the “menu” key, the ↑ scroll key, and ENTER key.)
- 2** Press the ENTER key.
- 3** The display indicates CALNUM and the current number of calibrations.

Monitoring for CAL violations

You can use the CALSTR command in conjunction with the CALNUM? command to monitor for calibration (CAL) violations. After each authorized calibration has taken place, use the CALNUM? command to access the current number of calibrations as described in the previous section. Store this number in the calibration string (must be done remotely) with the CALSTR command i.e. OUTPUT 722;“CALSTR 'calnum = 270””. At any later time, you can execute the CALNUM? and CALSTR? commands and compare the two calibration numbers. If the CALNUM is greater than the CALSTR entry, calibration security has been violated and unauthorized adjustments performed.

The following example illustrates monitoring for CAL violations:

- 1** After adjustments are performed, execute CALNUM?. Display shows “CALNUM 270”
- 2** Remotely execute OUTPUT 722;“CALSTR 'CALNUM=270””
- 3** At a later time you can verify if CAL has been violated by executing CALNUM? and CALSTR shift? to see if CALNUM is greater than that stored in CALSTR.

Monitoring Calibration Constants

Each time you do an ACAL, most calibration constants are recalculated. Executing an ACAL ALL recalculates 197 of the 253 calibration constants. The remaining constants (such as internal reference and offset constants) are externally derived and not changed by an ACAL. Periodically you may want to monitor a particular constant and track its movement within the lower and upper limits (see CAL? command, cal_item parameter). This may give you an indication of the calibration cycle you want to establish for your 3458A. Information on the externally derived calibration constants and the 197 internally derived calibration constants is presented on the last page of [Appendix B](#). Detailed information about each constant appears in the CAL? command located in [Chapter 5, "Command Summary"](#).

WARNING

- Only qualified, service trained personnel who are aware of the hazards involved should remove or install the multimeter or connect wiring to the multimeter. Disconnect the multimeter's power cord before removing any covers, changing the line voltage selector switches, or installing or changing the line power fuse.
 - Measuring high voltage is always hazardous. All multimeter input terminals (both front and rear) must be considered as hazardous whenever inputs in excess of 42 V are connected to any terminal. Regard all terminals as being at the same potential as the highest voltage applied to any terminal.
 - Keysight Technologies recommends that the wiring installer attach a label to any wiring having hazardous voltages. This label should be as close to the input terminals as possible and should be an eye-catching color, such as red or yellow. Clearly indicate on the label that high voltages may be present.
-

CAUTION

- The current input terminals (I) are rated at ± 1.5 A peak with a maximum non-destructive input of < 1.25 A RMS. Current inputs are fuse protected. The multimeter's input voltage ratings are:

	Rated input	Maximum non-destructive input
HI to LO Input:	± 1000 V peak	± 1200 V peak
HI/LO Ω Sense to LO Input:	± 200 V peak	± 350 V peak
HI to LO Ω Sense:	± 200 V peak	± 350 V peak
LO Input to Guard:	± 200 V peak	± 350 V peak
Guard to Earth Ground:	± 500 V peak	± 1000 V peak
HI/LO Input, HI/LO Ω Sense, or I terminal to earth ground:	± 1000 V peak	± 1500 V peak
Front terminals to rear terminals:	± 1000 V peak	± 1500 V peak

- The multimeter will be damaged if any of the above maximum non-destructive inputs are exceeded.

2 Operational Verification Tests

Introduction	28
Operational Tests	29

Introduction

This section contains Operational Verification Tests which provide an abbreviated method of testing the operation and accuracy of the unit. The Operational Verification Tests are designed to provide a 90% confidence that the 3458A is operational and meets the specifications listed in [Appendix A](#).

Operational Verification Tests perform a three point verification. These three points are the basis for all internal electronic adjustments (see the section titled [The basis for auto-calibration in Appendix B, "Electronic Calibration of the 3458A \(Product Note 3458A-3\)"](#)). Prior to the three point test, a self test verifies that all calibration constants are within their upper and lower limits, an indicator of proper operation.

Operational Tests

Required equipment

The following equipment or its equivalent is required for these operational tests.

- Stable DC voltage/resistance standard (Fluke 5700A or equivalent)
- Transfer standard DMM (3458A Opt. 002 within 90 days of CAL)
- Low thermal short (copper wire)
- Low thermal test leads (such as Keysight 11053A, 11174A, or 11058A)

NOTE

- **Equipment required for the adjustment procedures can be used for operational tests since the three-point test verifies the external adjustment points of the adjustment procedure.**
- **To have your transfer standard 3458A OPT. 002 calibrated to 90 day specifications, contact your Keysight Technologies sales and service office.**

Preliminary steps

- 1** Verify that the DC voltage/resistance standard is properly warmed up.
- 2** The 3458A requires a 4 hour warm-up period. If this has not occurred turn the instrument ON and allow it to warm up before proceeding.
- 3** The internal temperature of the 3458A under test must be within 5 °C of its temperature when last calibrated. Use the TEMP? command to obtain the current internal temperature and compare it to the calibration temperature obtained by executing the command CAL? 59 for DCV and CAL? 60 for OHMS. You can use the ← and → scroll keys to view entire CAL? message. Record the temperatures on the Test Card.
- 4** If the instrument self test has not been run, make certain all inputs are disconnected and execute the TEST function. The display must read “SELF TEST PASSED”.
- 5** Execute the ACAL OHMS function. This auto calibration will take approximately ten minutes to complete.
- 6** Configure the transfer standard DMM as follows:

- OHM
 - NDIG 8
 - NPLC 100
 - TRIG SGL
- 7** Configure the DMM under test as follows:
- OHM
 - NDIG 8
 - NPLC 100
 - TRIG SGL

2-wire ohms function offset test

This procedure operation verifies 2-wire ohms offset for both the front and rear terminals.

- 1** Connect a low thermal short across the 3458A front HI and LO terminals (see [Figure 3-1](#) on page 39).
- 2** Verify that the Terminals switch is in the Front position.
- 3** Set the 3458A under test to the 10 Ω range (function = OHM). Allow five minutes for the range relays to thermally stabilize.
- 4** Execute Trig from the front panel **two times** and use the Operational Test Card to record the offset reading. Reading must be less than the limit specified on the test card.
- 5** Remove the short from the front panel input terminals and connect it to the rear input HI and LO terminals.
- 6** Change the Terminals switch to the Rear position.
- 7** Allow 5 minutes for thermal stabilization.
- 8** Execute Trig from the front panel **two times** and record the rear terminal offset reading on the Operational Test Card. Reading must be less than the limit specified on the test card. If reading is greater than the limit, refer to [Chapter 3](#) to make adjustments.
- 9** Remove the short from the rear input terminals.

4-wire ohms function gain test

The following procedure verifies the gain of the ohms function. The 10 k Ω point is used for internal electronic calibration using ACAL. The procedure requires alternately connecting the transfer standard DMM and then the 3458A under test to the resistance verification standard as described in the [Chapter 4](#) section titled [General test procedure](#).

- 1 Connect the resistance standard to the transfer standard DMM 4-wire ohms front input terminals.
- 2 Set the Terminals switch of both DMMs to the Front position.
- 3 Set the range of the transfer standard DMM to 10 k Ω (function = OHMF).
- 4 Set the range of the 3458A under test to 10 k Ω (function = OHMF).
- 5 Set the resistance standard to 10 k Ω .
- 6 Execute Trig from the front panel **two times** and read the value of the resistance standard as measured with the transfer standard DMM and record this reading in the "Transfer standard reading" column of the ohms gain operational test card.
- 7 Remove the connection between the transfer standard DMM and the resistance standard.
- 8 Connect the resistance standard to the 4-wire ohms input terminals of the 3458A under test.
- 9 Execute Trig from the front panel **two times** and read the value as measured with the 3458A under test and record this value in the "Unit under test reading" column of the 4-wire ohms function gain operational test card.
- 10 Calculate and record in the column provided, the difference (absolute value) between the transfer standard DMM reading and the unit under test reading for the test.
- 11 If the difference calculated is greater than the specified limits, refer to [Chapter 3, "Adjustment Procedures"](#), to make adjustments.
- 12 Disconnect the resistance standard from the 3458A input terminals.

DC voltage function gain test

The following procedure verifies the 10 V input on the 10 V range. This test verifies the gain of the DC voltage function and checks the point used for internal adjustments by ACAL. The procedure requires alternately connecting the transfer standard DMM and then the 3458A under test to the DC verification source as described in the general test description of [Chapter 4, "Performance Verification Tests"](#).

- 1** Execute the ACAL DCV command using the front panel "Auto Cal" key and scroll keys. This auto calibration will take approximately two minutes to complete.
- 2** Configure the transfer standard DMM as follows:
 - DCV
 - NDIG 8
 - NPLC 100
 - Trig SGL
- 3** Configure the DMM under test as follows:
 - DCV
 - NDIG 8
 - NPLC 100
 - Trig SGL
- 4** Set the range of the transfer standard DMM to 10 V (function = DCV).
- 5** Set the range of the 3458A under test to 10 V (function = DCV).
- 6** Connect the DC voltage source to the transfer standard DMM.
- 7** Set the DC voltage source to 10 V.
- 8** Execute Trig SGL and read the output of the DC voltage source as measured with the transfer standard DMM and record this reading in the "Transfer standard reading" column of the DC voltage operational test record.
- 9** Remove the connection from the transfer standard DMM to the DC voltage source.
- 10** Connect the 3458A under test to the DC voltage source.

- 11** Execute Trig SGL and read the value as measured with the 3458A under test and record this value in the “Unit under test reading” column of the DC voltage operational test record.
- 12** Connect the DC voltage source to the transfer standard DMM.
- 13** Repeat steps 8 through 11 for a –10 V DC voltage source output.
- 14** Calculate, and record in the column provided, the difference (absolute value) between the transfer standard DMM reading and the unit under test reading.
- 15** If the difference calculated is greater than the specified limits, refer to [Chapter 3, "Adjustment Procedures"](#) to make adjustments.

DC voltage function offset test

This procedure tests the DCV offset voltage specification on the 10 V range. This reading and the 10 V and –10 V readings from the previous DCV gain test are used to do a turnover check of the A-D converter and verify its linearity.

- 1** Connect a low thermal short across the front panel HI and LO input terminals of the DMM under test (see [Figure 3-1](#) on page 39).
- 2** Set the range of the 3458A under test to 10 V.
- 3** Let the instrument sit for five minutes before taking a reading to allow the short and relays to thermally stabilize.
- 4** Execute Trig and record the offset reading on the Test Card.

Turnover check

The turnover check is a calculation using the unit under test readings from tests 4, 5, and 6 on the Test Card. This check verifies the linearity of the A-to-D converter which is fundamental to the 3458A's calibration technique. Calculate the following:

$$(\text{UUT Reading \#4}) - (\text{UUT Reading \#6}) = A$$

$$(\text{UUT Reading \#5}) - (\text{UUT Reading \#6}) = B$$

If the A-to-D converter is linear, the difference in the absolute values of A and B will be less than or equal to 4 μV .

OPERATIONAL TEST CARD - 1 YEAR LIMITS

Keysight Model 3458A Multimeter

Serial number _____ Test performed by _____
 CAL? 60 _____ Date _____
 TEMP? _____
 Difference _____ (must be less than 5 degrees C)
 Perform an ACAL OHMS

Test #	3458A input	3458A range	Transfer standard reading	Unit under test reading	Difference	Limit (Std)	Limit (Opt 002)	Pass	Fail
--------	-------------	-------------	---------------------------	-------------------------	------------	-------------	-----------------	------	------

2-wire ohms function offset test

1	Short	10 Ω	N/A	_____	N/A	00.25007	00.25007	_____	_____
				(Front terminals)					
2	Short	10 Ω	N/A	_____	N/A	00.25007	00.25007	_____	_____
				(Rear terminals)					

4-wire ohms function gain test

3	10 kΩ	10 kΩ	_____	_____	_____	00.000142	00.000142	_____	_____
---	-------	-------	-------	-------	-------	-----------	-----------	-------	-------

CAL? 59 _____
 TEMP? _____
 Difference _____ (must be less than 5 degrees C)
 Perform an ACAL DCV

DC voltage function gain test

4	10V	10V	_____	_____	_____	00.0000892	00.0000624	_____	_____
5	-10V	10V	_____	_____	_____	00.0000892	00.0000624	_____	_____

DC voltage function offset test

6	Short	10V	N/A	_____	N/A	00.0000023	00.0000023	_____	_____
---	-------	-----	-----	-------	-----	------------	------------	-------	-------

3 Adjustment Procedures

Introduction	36
Required Equipment	37
Preliminary Adjustment Procedure	38
Front Terminal Offset Adjustment	40
Rear Terminal Offset Adjustment	41
DC Gain Adjustment	42
AC Adjustment	46

Introduction

This section contains procedures for adjusting the 3458A multimeter. The 3458A uses closed-box electronic adjustment. No potentiometers or other electro-mechanical adjustments are used and the complete adjustment is done without removing any of the multimeter's covers. Only a voltage standard, a resistance standard, a low-thermal short, and an AC signal source are needed to perform all of the adjustments. This chapter contains the following adjustment procedures.

- 1** Front Terminal Offset Adjustment
- 2** Rear Terminal Offset Adjustment
- 3** DC Gain Adjustment
- 4** Resistance and DC Current Adjustment
- 5** AC Adjustment

You must perform the adjustments in the order presented in this chapter. All of the adjustments can be performed in approximately one hour (you must allow 4 hours of warm-up time from the time power is applied to the multimeter before performing any adjustments). Whenever adjusting the multimeter, always perform the adjustments numbered 1 through 4 in the above list. Adjustment number 5 (AC Adjustment) is required only once every 2 years or whenever the 03458-60502 or 03458-66503 PC assembly has been replaced or repaired. Product Note 3458A-3 in [Appendix B](#) discusses the purpose of each adjustment in detail.

An Adjustment Record is located at the back of this chapter. You should make photocopies of this record and complete the record whenever the multimeter is adjusted. The record contains information such as the date, which adjustments were performed, the calibration number, and the multimeter's adjustment temperature. You can then file the adjustment records to maintain a complete adjustment history for the multimeter.

Required Equipment

You will need the following equipment to perform the adjustments:

- A low-thermal 4-terminal short for the offset adjustments (this is typically a bent piece of copper wire as shown in [Figure 3-1](#) on page 39).
- 10 VDC Voltage Standard--Fluke 732A or equivalent (for the DC Gain Adjustment).
- 10 k Ω Resistance Standard--Fluke 742-10 K or equivalent (for the Resistance and DC Current Adjustment).
- AC Source-Keysight 3325A Synthesizer/Function Generator or equivalent (for the AC adjustment).

The resultant accuracy of the multimeter depends on the accuracy of the equipment used, the thermal characteristics of the short, and the type of cabling used. We recommend high impedance, low dielectric absorption cables for all connections.

Preliminary Adjustment Procedure

Perform the following steps prior to adjusting the 3458A:

- 1** Select the adjustment area. You can adjust the 3458A on the bench or in a system cabinet. The temperature of the adjustment environment should be between 15 °C and 30 °C. The more thermally stable the environment is, the more accurate the adjustment.
- 2** Connect the 3458A to line power and turn the multimeter on. Refer to *“Installing the Multimeter” in Chapter 1 of the 3458A User’s Guide* for information on setting the line voltage switches and installing the line power fuse.
- 3** Remove all external input signals from the front and rear input terminals.
- 4** Select the DCV function (use the DCV key) and the 100 mV range (repeatedly press the down arrow key until the range no longer- changes). (Refer to *Chapter 2 of the 3458A User’s Guide* for more information on front panel operation.)
- 5** Set the front panel Terminals switch to the Front position.
- 6** Allow the multimeter to warm up for 4 hours from the time power was applied. (At this point, you can connect the 4-terminal short to the front terminals as shown in [Figure 3-1](#) on page 39 to prepare for the Front Terminal Offset Adjustment.)

Figure 3-1 4-terminal short

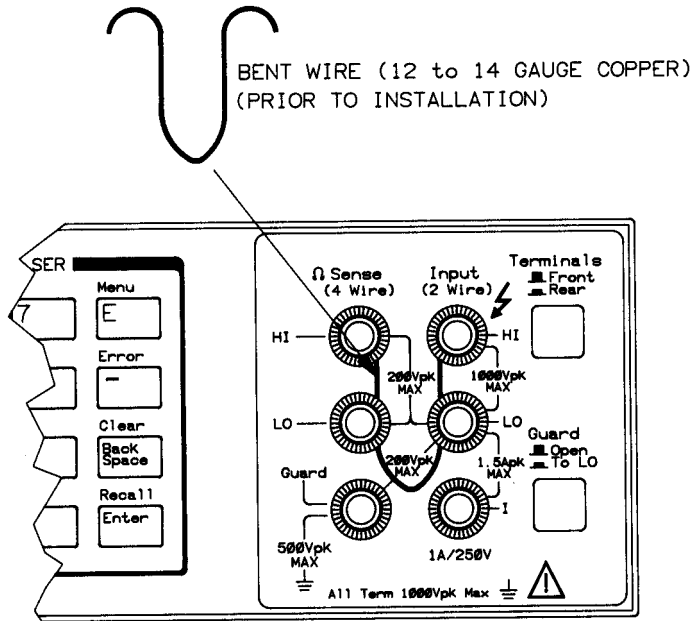

Front Terminal Offset Adjustment

This adjustment uses an external 4-terminal short. The multimeter makes offset measurements and stores constants for the DCV, DCI, OHM, and OHMF functions. These constants compensate for internal offset errors for front terminal measurements.

Equipment required: A low-thermal short made of 12 or 14 gauge solid copper wire as shown in [Figure 3-1](#) on page 39.

- 1 Make sure you have performed the steps described previously under “Preliminary Adjustment Procedures”.
- 2 Connect a 4-terminal short across the front panel HI and LO Input terminals and the HI and LO Ω Sense terminals as shown in [Figure 3-1](#) on page 39.
- 3 After connecting the 4-terminal short, allow 5 minutes for thermal equilibrium.

NOTE

Take precautions to prevent thermal changes near the 4-wire short. You should not touch the short after it is installed. If drafts exist, you should cover the input terminals/short to minimize the thermal changes.

- 4 Execute the CAL 0 command. The multimeter automatically performs the front terminal offset adjustment and the display shows each of the various steps being performed. This adjustment takes about 5 minutes. When the adjustment is complete, the multimeter returns to displaying DC voltage measurements.

Rear Terminal Offset Adjustment

This adjustment compensates for internal offset errors for rear terminal measurements.

- 1 Connect the 4-terminal short to the rear terminals.
- 2 Set the front panel Terminals switch to Rear.
- 3 After connecting the 4-terminal short, allow 5 minutes for thermal equilibrium.

NOTE

Take precautions to prevent thermal changes near the 4-wire short. You should not touch the short after it is installed. If drafts exist, you should cover the input terminals/short to minimize the thermal changes.

- 4 Execute the CAL 0 command. The multimeter automatically performs the rear terminal offset adjustment and the display shows each of the various steps being performed. This adjustment takes about 5 minutes. When the adjustment is complete, the multimeter returns to displaying DC voltage measurements.
- 5 Remove the 4-terminal short from the rear terminals.

DC Gain Adjustment

In this adjustment, the multimeter measures the standard voltage using its 10 V range. The multimeter then adjusts its gain so that the measured value agrees with the standard's exact value (specified using the CAL command). The multimeter then measures its 7 V internal reference voltage using the 10 V range and stores both the 10 V gain adjustment constant and the value of the internal 7 V reference. This adjustment also automatically performs the DCV autocalibration with computes DC gain constants.

Equipment required: A DC voltage standard capable of providing 10 VDC (the resultant accuracy of the 3458A depends on the accuracy of the voltage standard).

NOTE

Voltage standards from 1 V DC to 12 V DC can be used for this procedure. However, using a voltage standard <10 V DC will degrade the multimeter's accuracy specifications.

- 1 Select the DC Voltage function.
- 2 Set the front panel Terminals switch to Front.
- 3 Connect the voltage standard to the multimeter's front panel HI and LO Input terminals as shown in Figure 3-2. If using a Guard wire (as shown in Figure 3-2), set the Guard switch to the Open position. If not using a Guard wire, set the Guard switch to the To LO position.
- 4 Execute the CAL command specifying the exact output voltage of the standard. For example, if the standard's voltage is 10.0001 VDC, execute CAL 10.0001. The multimeter automatically performs the DC gain adjustment and the display shows each of the various steps being performed. This adjustment takes about 2 minutes. When the adjustment is complete, the multimeter returns to displaying DC voltage measurements.
- 5 Disconnect the voltage standard from the multimeter.

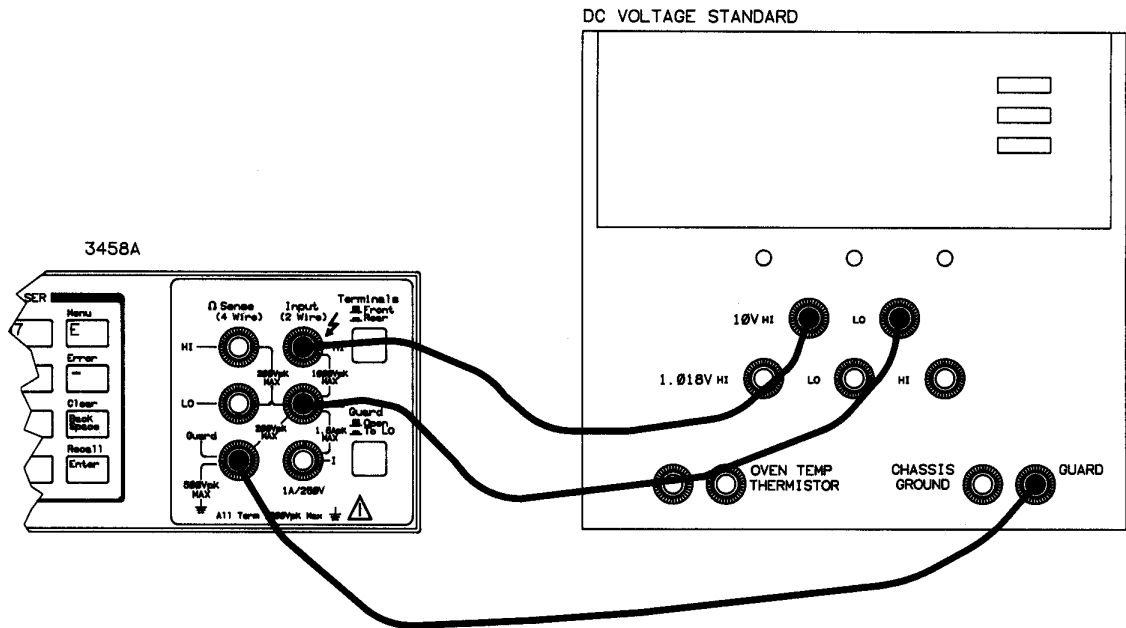

Figure 3-2 DC gain adjustment connections

Resistance and DC current adjustment

This adjustment calculates gain corrections for the resistance and DC current ranges. The DC Gain Adjustment must be performed prior to this adjustment because this adjustment relies on the values calculated by the DC Gain Adjustment.

NOTE

When offset compensated ohms is enabled (OCOMP ON command), the default delay time used by the multimeter for this adjustment is 50 ms (50 ms is the settling time used after the current source is switched on or off). For most resistance standards and cabling, this provides adequate settling time for the measurements made during the adjustment. If, however, the resistance standard and/or cabling has slow transient response or high dielectric absorption you should specify a longer delay. You can determine this experimentally prior to performing the following adjustment by measuring the resistance standard using a 50 ms delay and then measuring it using a much longer delay (e.g., 1 second). If the two measurements are significantly different, you should use a longer delay in the adjustment procedure. You must specify the longer delay using the DELAY command prior to executing the CAL command (step 5). For example, to specify a 200 ms delay execute: DELAY 200E-3. The multimeter will then use the specified delay in the adjustment. If a value of less than 50 ms is specified, the multimeter will automatically use a delay of 50 ms. Do not specify a delay longer than 60 seconds; a delay >60 seconds will adversely affect the adjustment.

Equipment required: A 10 k Ω resistance standard (the resultant accuracy of the multimeter depends on the accuracy of the resistance standard used).

NOTE

Resistance standards from 1 k Ω to 12 k Ω can be used for the procedure. However, using a resistance standard <10 k Ω will degrade the multimeter's accuracy specifications.

- 1 Select the 4-wire ohms measurement function (use the shifted OHM key).
- 2 Execute the OCOMP ON command (use the front panel Offset Comp Ω key).

NOTE

You can perform this adjustment with offset compensation disabled (OCOMP OFF command). This eliminates the settling time requirement (DELAY command) when dealing with high dielectric absorption in the adjustment setup (see note at the beginning of this adjustment). However, with offset compensation disabled, any offset voltages present will affect the adjustment. For most applications, we recommend enabling offset compensation for this adjustment.

- 3 Set the front panel Terminals switch to Front.
- 4 Connect the resistance standard to the multimeter's front panel HI and LO Input and HI and LO Sense terminals as shown in Figure 3-3. If using a Guard wire (as shown in Figure 3-2), set the Guard switch to the Open position. If not using a Guard wire, set the Guard switch to the To LO position.
- 5 Execute the CAL command specifying the exact value of the resistance standard. For example, if the standard's value is 10.003 k Ω , execute CAL 10.003E3. The multimeter automatically performs the resistance and DC current adjustment and the display shows each of the various steps being performed. This adjustment takes about 12 minutes. When the adjustment is complete, the multimeter returns to displaying resistance readings.
- 6 Disconnect the resistance standard from the multimeter.
- 7 Execute the ACAL AC command (use the AUTO CAL key). This autocalibrates the multimeter's AC section since the following AC Adjustment is normally performed only once every two years or whenever the 03458-66502 or 03458-66503 PC Assembly has been replaced or repaired. The AC autocalibration takes about 2 minute to complete.

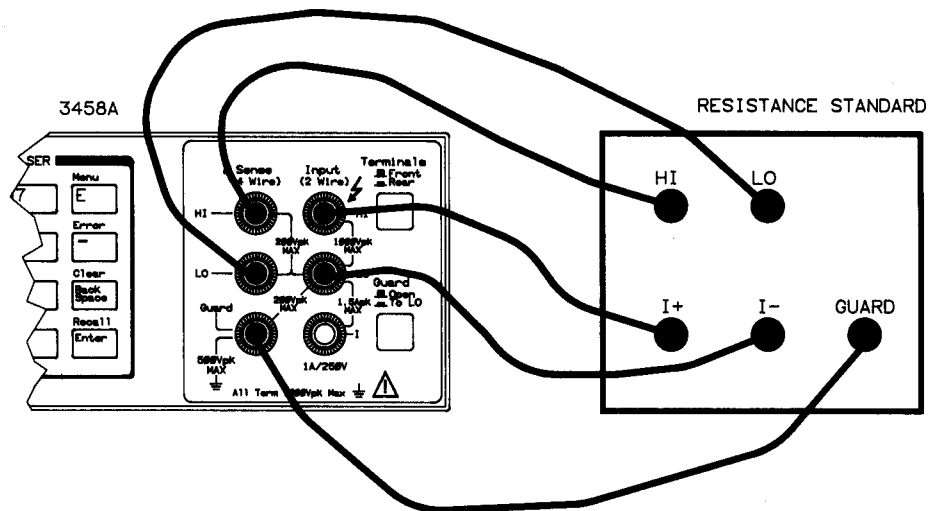

Figure 3-3 Resistance and DC current adjustment connections

AC Adjustment

This adjustment is only required once every two years or whenever the 03458-66502 PC Assembly or the 03458-66503 PC Assembly has been replaced or repaired. This adjustment sets the internal crystal frequency for the frequency and period measurement functions: adjusts the attenuator and amplifier high frequency response; and adjusts the Time Interpolator timing accuracy. Following this adjustment, the internal circuits have constant gain versus frequency.

Equipment required:

- Keysight 3325A Synthesizer/Function Generator or equivalent.
- 3 V Thermal Converter, Ballantine 1395A-3 or equivalent.
- 1 V Thermal Converter, Ballantine 1395A-1 or equivalent.
- 0.5 V Thermal Converter, Ballantine 1395A-0.4 or equivalent.
- 50 Ω BNC cable (keep this cable as short as possible)
- 50 Ω resistive load (typically a 50 Ω carbon composition or metal film resistor).
- BNC to Banana Plug Adapter--Keysight 1251-2277 or equivalent.

CAUTION

In the following procedure, the output voltage of the synthesizer is adjusted with the thermal converters in-circuit. Thermal converters are typically easily damaged by voltage overload. Use extreme care to ensure the voltage applied to the thermal converters does not exceed the thermal converter's maximum voltage rating.

Procedure

In the following procedure, steps 1 through 12 characterize the frequency flatness of the synthesizer and cabling configuration. The equipment setting determined from this characterization are then used in the remaining steps to precisely adjust the multimeter.

NOTE

The voltages referenced in this procedure are 3 V, 1 V and 100 mV rms for the SCAL 10, SCAL 1, and SCAL .1 commands, respectively. If necessary, you can use any value between 3 V and 10 V rms wherever 3 V is referenced, 300 mV to 1 V rms wherever 1 V is referenced, and 30 mV to 100 mV wherever 100 mV is referenced (make sure not to exceed the voltage rating of the thermal converters). (You still execute the SCAL 10, SCAL 1, and SCAL.1 commands regardless of the rms voltage value used). Whenever making low-level measurements, take precautions to minimize noise and interference in the test setup. Refer to **Test considerations** in **Chapter 4** for more information.

- 1 Execute the ACAL AC command. Following the autocal, execute the RESET command.
- 2 Set the front panel Terminals switch to Front. Set the Guard switch to the To LO position.
- 3 Set the synthesizer to deliver a 3 V rms sinewave at a frequency of 100 kHz. Connect the synthesizer, the 3 V thermal converter, and the multimeter as shown in Figure 3-4. Record the exact DC voltage measured by the multimeter on Line A of the Adjustment Record.

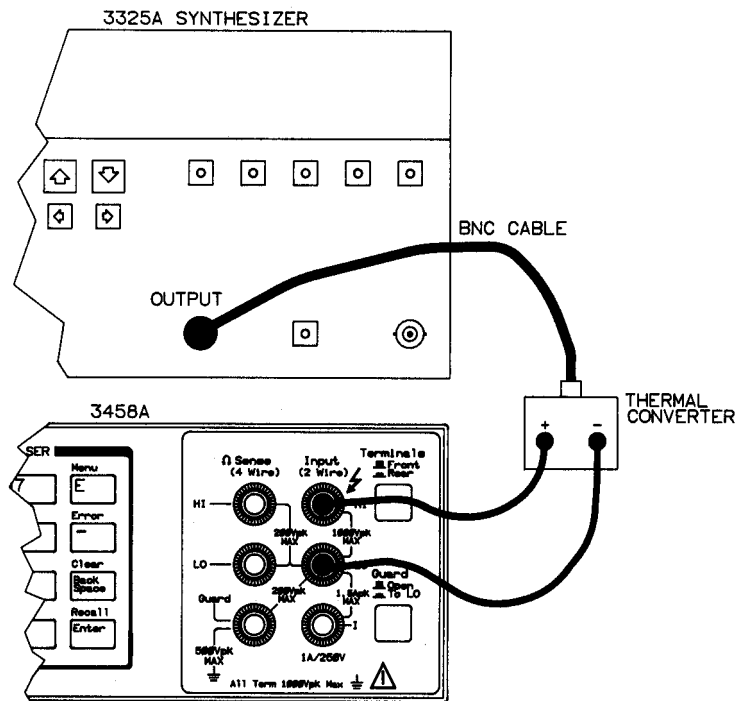

Figure 3-4 Characterizing the adjustment setup

- 4 Set the synthesizer to deliver a 3 V rms sinewave at a frequency of 2 MHz. Adjust the synthesizer's output voltage until the voltage displayed on the multimeter is within 0.2% of the voltage recorded on Line A. Record the synthesizer's voltage setting on Line C of the Adjustment Record.
- 5 Set the synthesizer to deliver a 3 V rms sinewave at a frequency of 8 MHz. Adjust the synthesizer until the voltage displayed on the multimeter is within 0.2% of the voltage recorded on Line A. Record the synthesizer's voltage setting on Line D of the Adjustment Record.
- 6 Set the synthesizer to deliver a 1 V rms sinewave at a frequency of 100 kHz. Replace the 3 V thermal converter with the 1 V thermal converter. Record the exact DC voltage measured by the multimeter on Line E of the Adjustment Record.

- 7 Set the synthesizer to deliver a 1 V rms sinewave at a frequency of 8 MHz. Adjust the synthesizer until the voltage displayed on the multimeter is within 0.2% of the voltage recorded on Line E. Record the synthesizer's voltage setting on Line F of the Adjustment Record.
- 8 Set the synthesizer to deliver a 100 mV rms sinewave at a frequency of 100 kHz. Replace the 1 V thermal converter with the 0.5 V thermal converter. Record the exact DC voltage measured by the multimeter on Line G of the Adjustment Record.
- 9 Set the synthesizer to deliver a 100 mV rms sinewave at a frequency of 8 MHz. Adjust the synthesizer until the voltage displayed on the multimeter is within 0.2% of the voltage recorded on Line G. Record the synthesizer's voltage setting on Line H of the Adjustment Record.
- 10 Disconnect the thermal converter and connect the synthesizer, 50 Ω resistive load, and multimeter as shown in Figure 3-5.

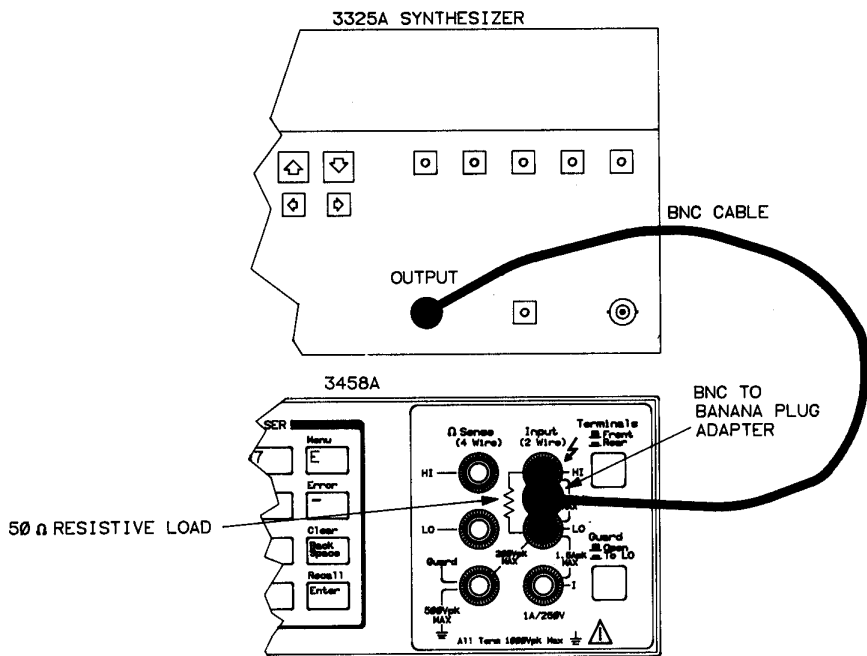

Figure 3-5 AC adjustment connections

3 Adjustment Procedures

- 11** Set multimeter to ACBAND 10, 2E6. Set the synthesizer to output 3 V rms at 100 kHz. Execute the SCAL 1E5 command. The multimeter automatically performs the adjustment. When the adjustment is complete, the multimeter returns to displaying DC voltage readings.
- 12** Without changing the synthesizer settings, execute the SCAL 10 command as shown on Line B of the Adjustment Record.
- 13** Set multimeter to ACBAND 10, 10E6. Set the synthesizer to the voltage and frequency shown on Line C of the Adjustment Record. Execute the SCAL command as shown on Line C of the Adjustment Record.
- 14** Repeat step 13 for each synthesizer setting, multimeter ACBAND setting and SCAL command shown on Lines D through H on the Adjustment Record.
- 15** Disconnect all equipment from the multimeter.
- 16** Execute the ACAL AC command.

3458A ADJUSTMENT RECORD

Adjusted by _____

Date _____

3458A serial number or other device ID number _____

Previous calibration number (CALNUM? command) _____ (record this number *before* adjusting the multimeter)Adjustments performed^[a]:

Perform an ACAL OHMS

1. ____ Front terminal offset adjustment
2. ____ Rear terminal offset adjustment
3. ____ DC gain adjustment (DCV standard uncertainty = _____)
4. ____ Resistance and DC current adjustment (resistance standard uncertainty = _____)
5. ____ AC adjustment

	Multimeter reading	Synthesizer setting	AC source frequency	Multimeter ACBAND setting	Execute command	Adjustment description
Line A	_____ V	3 V	100 kHz	ACBAND 10, 2E6	SCAL 1E5	Frequency adjustment
Line B		3 V	100 kHz	ACBAND 10, 2E6	SCAL 10	Low-freq. voltage reference
Line C		_____ V	2 MHz	ACBAND 10, 10E6	SCAL 10	Time interpolator and flatness
Line D		_____ V	8 MHz	ACBAND 10, 10E6	SCAL 10	Flatness adjustment
Line E	_____ V	1 V	100 kHz	ACBAND 10, 2E6	SCAL 1	Low-freq. voltage reference
Line F		_____ V	8 MHz	ACBAND 10, 10E6	SCAL 1	Flatness adjustment
Line G		100 mV	100 kHz	ACBAND 10, 2E6	SCAL 0.1	Low-freq. voltage reference
Line H		_____ V	8 MHz	ACBAND 10, 10E6	SCAL 0.1	Flatness adjustment

Internal adjustment temperature (TEMP? command) ____ °C

Calibration number (CALNUM? command) _____ (record this number *after* adjusting the multimeter)

Calibration secured _____ Unsecured _____

[a] Always perform the above adjustments numbered 1 through 4; adjustment number 5 is only required once every 2 years or whenever the 03458-66502 or 03458-66503 PC Assembly has been replaced or repaired.

THIS PAGE HAS BEEN INTENTIONALLY LEFT BLANK.

4 Performance Verification Tests

Introduction	54
DC Voltage Performance Tests	60
Analog AC voltage performance tests	65
DC Current Performance Tests	68
Ohms Performance Tests	72
Frequency Counter Performance Tests	76

Introduction

This chapter contains performance tests designed to verify that the 3458A multimeter is operating within the specifications listed in [Appendix A](#). The Performance Tests are performed without access to the interior of the instrument.

Required equipment

The equipment required for the performance tests is listed below. Equipment other than that recommended can be used as long as the specifications of the substituted equipment is equivalent to that recommended.

- Fluke 5700A AC/DC Standard
- Keysight 3325A Function Generator/Frequency Synthesizer
- Transfer standard DMM (3458A Opt. 002 within 90 days of CAL)
- Low thermal short (see Figure 3-1 on page 39)
- Low thermal test leads (such as Keysight 11053A, 11174A, or 11058A)
- Shielded test leads (such as Keysight 11000-60001)

NOTE

To have your transfer standard 3458A Opt. 002 calibrated to 90 day specifications, contact your Keysight Technologies sales and service office.

Test card

Results of the performance tests may be tabulated on the appropriate Test Card located at the end of the test procedures. Make copies of the Test Cards for performance test tabulations and retain the originals to copy for use in future performance testing. The Test Cards list all of the tested functions and the acceptable limits for the test results.

Calibration cycle

The frequency of performance verification depends on the instrument's usage and the environmental operating conditions. To maintain 24 hour or 90-day specifications, the instrument should be checked at these intervals by a metrology lab with test capability for these accuracies. For normal operation, it is recommended you perform performance verification every year.

Test considerations

This section discusses many of the major problems associated with low-level measurements. Many of the measurements in this manual fall into this category. It is beyond the scope of this manual to go into great detail on this subject. For more information, refer to a textbook dealing with standard metrology practices.

- Test leads: Using the proper test leads is critical for low-level measurements. We recommend using cable or other high impedance, low dielectric absorption cable for all measurement
- Connections. It is important to periodically clean all connection points (including the multimeter terminals) using a cotton swab dipped in alcohol.
- Noise Rejection: For DC voltage, DC current, and resistance measurements, the multimeter achieves normal mode noise rejection (NMR)^[1] for noise at the A/D converter's reference frequency (typically the same as the power line frequency) when the integration time is ≥ 1 power line cycles. You can specify integration time in terms of power line cycles (PLCs) using the NPLC command. For maximum NMR of 80dB, set the power line cycles to 1000 (NPLC 1000 command).
- Guarding: Whenever possible, make measurements with the multimeter's Guard terminal connected to the low side of the measurement source and the Guard switch set to the Open position (guarded measurements). This provides the maximum effective common mode rejection (ECMR).
- Thermoelectric Voltages (Thermal EMF): This is a common source of errors in low-level measurements. Thermal EMF occurs when conductors of dissimilar metals are connected together or when different parts of the circuit being measured are at different temperatures. Thermal EMF can become severe in high-temperature environments. To minimize thermal EMF, minimize the

[1] Normal mode noise rejection is the multimeter's ability to reject noise at the power line frequency from DC voltage, DC current, or resistance measurements.

number of connections: use the same type of metal for all connections; minimize the temperature variations across the measurement wiring: try to keep the multimeter and the wiring at the same temperature: and avoid high-temperature environments whenever possible.

- Electromagnetic Interference (EMI): This type of interference is generally caused by magnetic fields or high levels of radio frequency (RF) energy. Magnetic fields can surround all types of equipment operating off of AC line power, especially electric motors. RF energy from nearby radio or television stations or communications equipment can also be a problem. Use shielded wiring whenever the measurement setup is in the presence of high EMI. If possible, move farther away or turn off sources of high EMI. It may be necessary to test in a shielded room.
- Ground Loops: Ground loops arise when the multimeter and the circuit under test are grounded at physically different points. A typical example of this is when a number of instruments are plugged into a power strip in an equipment rack. If there is a potential difference between the ground points, a current will flow through this ground loop. This generates an unwanted voltage in series with the circuit under test. To eliminate ground loops, ground all equipment/ circuits at the same physical point.
- Internal Temperature: The internal temperature of the 3458A under test must be within 5°C of its temperature when last adjusted. If the multimeter's temperature is not within 5°C first check the multimeter's fan operation and clean the filter. Also, make sure that you adjust the operating environment such that the ambient temperature is at or very near 25°C . You will achieve the best results if you maintain your environment close to 25°C . If you choose to verify performance when the temperature is not within 5°C , you must recalculate all test limits based on the temperature variation beyond the 5°C limitation. The published test limits were calculated without additional temperature coefficient errors added.

General test procedure

The following performance tests utilize a transfer standard DMM to precisely measure the verification source. The transfer standard DMM recommended is an 3458A option 002 (high stability) that is within a 90-day calibration. The verification source is first measured by the transfer standard DMM and then connected to the unit under test. The general test procedure is as follows:

A. Performed one time prior to testing (preliminary steps)

- 1 Verify that the Verification Source is properly warmed up.
- 2 The 3458A requires a 4 hour warm-up period. Verify that the transfer standard DMM and the 3458A unit under test (UUT) are properly warmed up.
- 3 The internal temperature of the 3458A under test must be within 5 degrees C of its temperature when last adjusted (CAL 0, CAL 10, and CAL 10K). These temperatures can be determined by executing the commands CAL? 58, CAL? 59, CAL? 60.
- 4 If the instrument self test has not been run, verify all inputs are disconnected and execute the TEST function. The display must read "SELF TEST PASSED".

B. Repeated for each function and range tested

- 5 Execute the ACAL command for the function being tested on both the transfer standard and the unit under test (UUT).
- 6 Configure the transfer DMM as specified in each test.
- 7 Configure the DMM under test as specified in each test.
- 8 Connect the Verification source to the transfer standard DMM and determine the source output (see Figure 4-1 (A)). Record this value on the Test Card under "Transfer Standard Reading".
- 9 Disconnect the Verification Source from the transfer standard DMM and connect it to the 3458A under test (see Figure 4-1 (B)). Record this value on the Test Card under "Unit Under Test Reading".
- 10 Calculate the difference between the transfer standard DMM reading and the UUT reading. Record the absolute value (ignore sign) of the difference on the Test Card under "Difference".

- 11** Compare this difference to the allowable difference specified on the Test Card. If less than the specified difference, note that the test passed. If greater than the specified difference, note that the test failed.

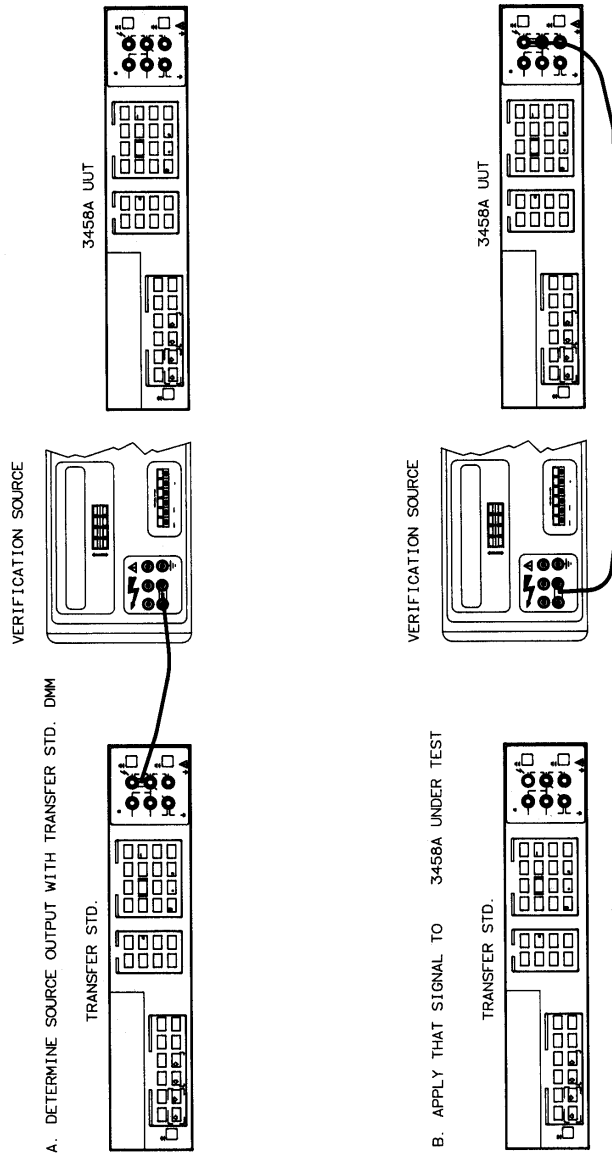

Figure 4-1 General test procedure

DC Voltage Performance Tests

Required equipment

The following equipment or its equivalent is required for these performance tests.

- Stable DC voltage source (Fluke 5700A or equivalent)
- Transfer standard DMM (3458A Opt. 002 within 90 days of CAL)
- Low thermal short (copper wire)
- Low thermal test leads (such as Keysight 11053A, 11174A, 11058A)

Preliminary steps

- 1** Verify that the DC source is properly warmed up.
- 2** The 3458A requires a 4-hour warm-up period. If this has not been done, turn the instrument ON and allow it to warm up before proceeding.
- 3** The internal temperature of the 3458A under test must be within 5 degrees C of its temperature when last adjusted. Use the TEMP? command to obtain the current internal temperature and compare it to the calibration temperature obtained by executing the command CAL? 59. Record the temperatures obtained on the **DC VOLTAGE TESTS** test card.
- 4** If the instrument self test has not been run, make certain all inputs are disconnected and execute the TEST function. The display must read "SELF TEST PASSED".
- 5** Execute the ACAL DCV command on both the transfer standard DMM and the UUT using the front panel "Auto Cal" key and scroll keys. This auto calibration will take approximately two minutes to complete.
- 6** Configure the transfer standard DMM as follows:
 - DCV
 - NDIG 8
 - NPLC 100
 - Trig SGL
- 7** Configure the DMM under test as follows:

- DCV
- NDIG 8
- NPLC 100
- Trig SGL

DC voltage function offset test

The following procedure tests the offset voltage specification with the input terminals shorted. A low-thermal short must be used to minimize thermally induced errors. Also, you must allow five minutes before making the first measurement to allow for thermal stabilization of the range relays.

- 1** Connect a low thermal short across the front panel HI and LO input terminals of the DMM under test (see Figure 3-1 on page 39).
- 2** Set the range of the 3458A under test as specified in [Table 4-1](#).
- 3** Let the instrument sit for five minutes before taking the first reading to allow the range relay and short to thermally stabilize. NOTE: The thermal stabilization achieved for the 100 mV range is present for the 1V and 10V ranges since these ranges use the same relays. The range relays are opened for the 100V and 1000V ranges and therefore, have no thermal impact on the measurement.
- 4** Execute Trig and record the offset reading (absolute value) for each range listed in [Table 4-1](#) and on the [DC VOLTAGE TESTS](#) Test Card provided at the end of this chapter.

Table 4-1 Offset performance tests

Offset test number	DMM range
1	100 mV
2	1 V
3	10 V
4	100 V
5	1000 V

- 5 If any of the offset readings are greater than the limits specified on the **DC VOLTAGE TESTS** Test Card, the instrument should be adjusted. Refer to **Chapter 3, "Adjustment Procedures"**, to make adjustments.
- 6 Remove the short from the front panel terminals.
- 7 Connect the low thermal short across the rear panel HI and LO input terminals and repeat steps 2 through 5. Remove the short from the rear panel terminals when complete.

DC voltage function gain test

The following is a step-by-step procedure for all test points that verify gain of the DC voltage function. The procedure requires alternately connecting the transfer standard DMM and then the 3458A under test to the DC voltage source as described in the general test description.

- 1 Set the output of the DC voltage source to standby/off and short the HI and LO output terminals of the source using a shorting strap.
- 2 Connect the leads of a shielded low-thermal EMF cable from the source output terminals to the Input HI and LO terminals of the transfer standard DMM.
- 3 Connect the Guard terminal of the voltage source to the guard terminal of the DMM.
- 4 Set the range of the DMM to 100 mV. Wait five minutes for the DMM to thermally stabilize.
- 5 Set MATH NULL on the transfer standard DMM.
- 6 Execute Trig SGL to trigger the NULL reading.
- 7 Remove the EMF cable leads from the DMM and connect them to the HI and LO Input terminals 3458A under test. Connect the Guard terminal of the voltage source to the guard terminal of the 3458A under test.
- 8 Set the range of the 3458A under test to 100 mV. Wait five minutes for the 3458A under test to thermally stabilize.
- 9 Set MATH NULL on the 3458A under test and execute Trig SGL to trigger the NULL reading
- 10 REMOVE THE SHORTING STRAP FROM THE VOLTAGE SOURCE HI and LO OUTPUT TERMINALS.

Connect the output of the voltage source to the HI and LO Input terminals of the transfer standard DMM. With the DMM range set to 100 mV, set the output of the voltage source to 100 mV. Wait five minutes for the transfer standard DMM to thermally stabilize.

NOTE

The thermal stabilization achieved for the 100 mV range is present for the 1V and 10V ranges since these ranges use the same relays. The range relays are opened for the 100V and 1000V ranges and therefore, have no thermal impact on the measurement.

- 11 Execute Trig SGL and read the output of the voltage source as measured with the transfer standard DMM and record this reading in the “Transfer standard reading” column of the DC VOLTAGE TESTS test card.
- 12 Move the connection from the transfer standard DMM HI and LO Input terminals to the HI and LO Input terminals of the 3458A under test.
- 13 Execute Trig SGL and read the value as measured with the 3458A under test and record this value in the “Unit under test reading” column of the DC voltage Test Record.
- 14 Repeat steps 11 through 14 for each of the remaining DC voltage test points specified in [Table 4-2](#).

Table 4-2 DCV gain performance tests

DC gain test number	DMM range	Source output
1	100 mV	100 mV
2	1 V	1 V
3	10 V	1 V
4	10 V	-1 V
5	10 V	-10 V
6	10 V	10 V
7	100 V	100 V
g ^[a]	1000 V	1000 V

[a] NOTE: After completing test 8, decrease the 1000 V verification source output to 0 V before disconnecting.

- 15** After all DC gain tests have been performed, calculate and record in the column provided. The difference (absolute value) between the transfer standard DMM reading and the unit under test reading for each of the test points.
- 16** If any of the differences calculated are beyond the specified limits, refer to [Chapter 3, "Adjustment Procedures"](#), to make adjustments.

Analog AC voltage performance tests

Required equipment

The following list of equipment is required to test the analog AC performance of the 3458A.

- Stable AC voltage source (Fluke 5700A or equivalent).
- Transfer Standard DMM (3458A Opt. 002 within 90 days of Cal.)
- Shielded test leads terminated with dual banana plugs (such as Keysight 11000-60001).

Preliminary steps

- 1** Make certain that the AC source is properly warmed up.
- 2** The 3458A requires a 4 hour warm up period. If this has not been done, turn the instrument ON and allow it to warm up.
- 3** Execute the ACAL AC function on both the transfer standard DMM and the UUT. This auto calibration will take approximately 1 minute to complete.
- 4** If the instrument Self Test has not been run, make certain all inputs are disconnected and execute the TEST function. The display must read “SELF TEST PASSED”.
- 5** Configure the transfer standard DMM as follows:
 - ACV
 - SETACV SYNC
 - ACBAND 10,2E6
 - RANGE10
 - RES .001
 - TRIG SGL
 - LFILTER ON
- 6** Configure the DMM under test as follows:
 - ACV

- SETACV ANA
- ACBAND 10,2E6
- RANGE10
- RES .01
- TRIG SGL
- LFILTER ON

AC voltage test procedure

The following is a step-by-step procedure for all test points in the AC performance verification section. The procedure requires alternately connecting the transfer standard DMM and then the 3458A under test to the AC source. Because of this and because the accuracy of AC coupled measurements does not suffer due to small thermal induced offsets, the test connection can be made using shielded test leads terminated with dual banana plugs. Refer to the general test procedure for test connections.

- 1** Connect the AC voltage source to the transfer standard DMM.
- 2** Set the range of the transfer standard DMM as specified in [Table 4-3](#).
- 3** Set the range of the 3458A under test as specified in [Table 4-3](#).
- 4** Set the AC source to the voltage level and frequency specified in [Table 4-3](#).
- 5** Execute Trig SGL and read the output of the AC source as measured with the transfer standard DMM and record this reading in the “Transfer standard reading” column of the [AC VOLTAGE TESTS](#) Test Card.
- 6** Remove the connection from the transfer standard DMM to the AC source.
- 7** Connect the 3458A under test to the AC source.
- 8** Execute Trig SGL and read the value as measured with the 3458A under test and record this value in the “Unit under test reading” column of the [AC VOLTAGE TESTS](#) Test Card.
- 9** Repeat steps 1 through 8 for each of the remaining AC voltage test points as specified in [Table 4-3](#).

Table 4-3 AC performance tests

AC test number	DMM range	Source level	Source frequency
1	100 mV	100 mV	1 kHz
2	1 V	1 V	1 kHz
3	10 V	1 V	1 kHz
4	10 V	10 V	20 Hz
5	10 V	10 V	1 kHz
6	10 V	10 V	20 kHz
7	10 V	10 V	100 kHz
8	10 V	10 V	1 MHz
9	100 V	100 V	1 kHz
10 ^[a]	1000 V	700 V	1 kHz

[a] NOTE: After completing test 10, reduce the ACV standard voltage to 0 V before disconnecting.

- 10** After all AC voltage tests have been performed, calculate and record in the column provided, the difference between the transfer standard DMM reading and the unit under test reading for each of the test points.
- 11** If any of the differences calculated are greater than the specified limits, refer to [Chapter 3, "Adjustment Procedures"](#), to make adjustments.

DC Current Performance Tests

Required equipment

The following equipment or its equivalent is required for these performance tests.

- Stable DC current source (Fluke 5700A or equivalent)
- Transfer standard DMM (3458A Opt. 002 within 90 days of CAL)
- Low thermal test leads (such as Keysight 11053A, 11174A, or 11058A)

Preliminary steps

- 1** Verify that the DC current source is properly warmed up.
- 2** The 3458A requires a 4 hour warm-up period. If this has not been done, turn the instrument ON and allow it to warm up before proceeding.
- 3** The internal temperature of the 3458A under test must be within 5 degrees C of its temperature when last adjusted. The current internal temperature is obtained by executing TEMP?. Compare this temperature to the calibration temperature obtained by executing the command CAL? 60. Record these temperatures on the **DC CURRENT TESTS** Test Card.
- 4** If the instrument self test has not been run, make certain all inputs are disconnected and execute the TEST function. The display must read "SELF TEST PASSED".
- 5** Execute the ACAL OHMS function on both the transfer standard DMM and the UUT. This auto calibration will take approximately ten minutes to complete.
- 6** Configure the transfer standard DMM as follows:
 - DCI
 - NDIG 8
 - NPLC 100
 - Trig SGL
- 7** Configure the DMM under test as follows:
 - DCI
 - NDIG 8

- NPLC 100
- Trig SGL

DC current function offset test

The following procedure tests the DC current offset specifications with the input terminals open.

- 1 Set the 3458A under test to the DC Current Function (DCI).
- 2 Set the range of the 3458A under test as specified in [Table 4-4](#).
- 3 Let the instrument sit for 5 minutes to allow the range relays to thermally stabilize.
- 4 Execute Trig and record the absolute value of the offset reading of each range listed in [Table 4-4](#) on the **DC CURRENT TESTS** Test Card provided at the end of this section.

Table 4-4 Current offset performance tests

Offset test number	DMM range
1	100 μ A
2	1 mA
3	10 mA
4	100 mA
5	1 A

- 5 If the offset tests are out of specification, perform another ACAL before performing step 6 below.
- 6 If any of the offset readings are beyond the limits specified in the Test Record, the instrument should be adjusted. Refer to [Chapter 3, "Adjustment Procedures"](#) to make adjustments.

DC current function gain test

The following is a step-by-step procedure for all test points that performance verify gain of the DC current function. The procedure requires alternately connecting the transfer standard DMM and then the 3458A under test to the DC verification source as described in the section titled **General test procedure**.

- 1 Connect the DC current source to the transfer standard DMM I and LO input terminals using low thermal test leads.
- 2 Set the range of the transfer standard DMM as specified in **Table 4-5**.
- 3 Set the range of the 3458A under test as specified in **Table 4-5**.
- 4 Set the DC source to the current level specified in **Table 4-5**.
- 5 Execute Trig SGL and read the output of the DC current source as measured with the transfer standard DMM and record this reading in the “Transfer standard reading” column of the **DC CURRENT TESTS** Test Card.
- 6 Remove the connection from the transfer standard DMM to the DC current source.
- 7 Connect the DC current source to the 3458A under test HI and LO input terminals.
- 8 Execute Trig and read the value as measured with the 3458A under test and record this value in the “Unit under test reading” column of the **DC CURRENT TESTS** Test Card.
- 9 Repeat steps 1 through 8 for each of the remaining DC current test points as specified in **Table 4-5**.

Table 4-5 DCI gain performance tests

DCI gain test number	Source and DMM range	Source output
1	100 μ A	100 μ A
2	1 mA	1 mA
3	10 mA	10 mA
4	100 mA	100 mA
5	1 A	1 A

- 10** After all DC current gain tests have been performed, calculate and record in the column provided, the difference (absolute value) between the transfer standard DMM reading and the unit under test reading for each test point.
- 11** If any of the differences calculated are beyond the specified limits, refer to [Chapter 3, "Adjustment Procedures"](#), to make adjustments.
- 12** Reduce the output of the DC Current Source and disconnect it from the 3458A input terminals.

Ohms Performance Tests

Required equipment

The following list of equipment is required to test the ohms performance of the 3458A.

- Stable resistance standard (Fluke 5700A or equivalent)
- Transfer standard DMM (3458A Opt. 002 within 90 days of CAL)
- Low thermal short (copper wire)
- Low thermal test leads (such as Keysight 11053A, 11174A, or 11058A)

Preliminary steps

- 1** Verify that the resistance standard is properly warmed up.
- 2** The 3458A requires a 4-hour warm-up period. If this has not been done, turn the instrument ON and allow it to warm up before proceeding.
- 3** The internal temperature of the 3458A under test must be within 5 degrees C of its temperature when last ohms adjusted. The current internal temperature can be obtained by executing TEMP?. Compare this temperature to adjustment temperature obtained by executing the command CAL? 60 and record both temperatures on the **OHMS TESTS** Test Card.
- 4** If the instrument self test has not been run, make certain all inputs are disconnected and execute the TEST function. The display must read “SELF TEST PASSED”.
- 5** If you have just performed DCI tests, you have done an ACAL OHMS which takes approximately ten minutes to complete. Compare the TEMP? temperatures recorded on the **DC CURRENT TESTS** and **OHMS TESTS** Test Cards. If they differ by more than 1°C, execute ACAL OHMS again. If DCI tests have not been done previously, execute ACAL OHMS.
- 6** Configure the transfer standard DMM as follows:
 - OHMF
 - NDIG 8
 - NPLC 100

- OCOMP ON
 - Trig SGL
- 7** Configure the DMM under test as follows:
- OHM
 - NDIG 8
 - NPLC 100
 - OCOMP ON
 - Trig SGL

2-wire ohms function offset test

The following procedure verifies the front and rear terminal ohms offset.

- 1** Connect a low thermal short across the front panel HI and LO input terminals of the 3458A under test as shown in Figure 3-1 on page 39.
- 2** Set the 3458A under test to the 10 Ω range. Allow 5 minutes for the range relays to thermally stabilize.
- 3** Execute Trig and use the **OHMS TESTS** Test Card to record the offset reading.
- 4** Remove the short from the front panel input terminals.
- 5** Connect the low thermal short across the rear panel HI and LO input terminals and repeat steps 2 and 3. Remove the short from the terminals when complete.

4-wire ohms function offset test

This procedure verifies the front and rear terminal ohms offset.

- 1** Connect a low thermal short across the rear terminals of the 3458A as shown for the front terminals in Figure 3-1 on page 39.
- 2** On the 3458A under test, select 4-wire ohms and the 10 Ω range by executing OHMF, 10.
- 3** Execute Trig and use the **OHMS TESTS** Test Card to record the offset reading.
- 4** Remove the short from the rear panel input terminals.
- 5** Connect the low thermal short across the front input terminals and repeat steps 2 and 3. Remove the short from the terminals when complete.

4-wire ohms function gain test

The following is a step-by-step procedure for all test points that performance verify gain of the ohms function. The procedure requires alternately connecting the transfer standard DMM and then the 3458A under test to the resistance verification source as described in the section titled **General test procedure**.

- 1 Connect the resistance standard to the transfer standard DMM 4-wire ohms front input terminals.
- 2 Set the range of the transfer standard DMM as specified in **Table 4-6**.
- 3 Set the range of the 3458A under test as specified in **Table 4-6**.
- 4 Set the resistance standard to the ohms level specified in **Table 4-6**.
- 5 Execute Trig and read the output of the resistance standard as measured with the transfer standard DMM and record this reading in the “Transfer standard reading” column of the **OHMS TESTS** Test Card.
- 6 Remove the connection from the transfer standard DMM to the resistance standard.
- 7 Connect the resistance standard to the front panel 4-wire ohms input terminals of the 3458A under test.
- 8 Execute Trig *two times* and read the value as measured with the 3458A under test and record this value in the “Unit under test reading” column of the **OHMS TESTS** Test Card.
- 9 Repeat steps 1 through 8 for each of the remaining resistance test points as specified in **Table 4-6**.

Table 4-6 OHMF gain performance tests

OHMF gain test number	Source and DMM range	Source output
1	10 Ω	10 Ω
2	100 Ω	100 Ω
3	1 k Ω	1 k Ω
4	10 k Ω	10 k Ω
5	100 k Ω	100 k Ω

Table 4-6 OHMF gain performance tests

OHMF gain test number	Source and DMM range	Source output
6	1 M Ω	1 M Ω
7 ^[a]	10 M Ω	10 M Ω

[a] NOTE: At 10 M Ω , leakage current from the Sense leads introduce additional uncertainty in the measurement. This uncertainty, however, is accounted for in the published performance test limit. For best accuracy and consistency across calibration sites and environments, Test 7 can be performed using a 2-wire ohms measurement. The performance test limit remains the same for both 4-wire and 2-wire measurements of 10 M Ω .

- 10 After all OHMF gain tests have been performed, calculate and record in the column provided, the difference (absolute value) between the transfer standard DMM reading and the unit under test reading for each of the test points.
- 11 If any of the differences calculated are beyond the specified limits, refer to [Chapter 3, "Adjustment Procedures"](#) to make adjustments.
- 12 Disconnect the resistance standard from the 3458A input terminals.

Frequency Counter Performance Tests

Required equipment

The following equipment is required for testing the frequency counter performance of the 3458A.

- Stable frequency source (Keysight 3325A Frequency Synthesizer or equivalent)
- Shielded test leads, BNC to dual banana plug (such as Keysight 11001-60001)

Preliminary steps

- 1 Verify that the frequency source is properly warmed up.
- 2 The 3458A requires a 4-hour warm-up period. If this has not been done, turn the instrument ON and allow it to warm up before proceeding.
- 3 If the instrument self test has not been run, make certain all inputs are disconnected and execute the TEST function. The display must read “SELF TEST PASSED”.
- 4 Configure the DMM under test as follows:
 - FREQ
 - Trig SGL
 - FSOURCE ACDCV
 - LEVEL 0,DC

Frequency counter accuracy test

- 1 Execute FSOURCE ACDCV (specifies the type of signal to be used as the input signal for frequency measurement).
- 2 Set the Frequency Standard to output a 1 volt p-p, 1 Hz sine-wave. Record the exact Frequency Standard Value on the **FREQUENCY TESTS** Test Card. Connect the output of the Frequency Standard to the HI and LO input terminals of the 3458A under test.
- 3 Execute Trig and record the Unit Under Test Reading on the **FREQUENCY TESTS** Test Card.

- 4 Subtract the 1 Hz Unit Under Test Readings from the 1 Hz Frequency Standard Value. Record the difference on the **FREQUENCY TESTS** Test Card.
- 5 Change the Frequency Standard to 10 MHz and record the exact Frequency Standard Value on the **FREQUENCY TESTS** Test Card. Execute Trig, and record the Unit Under Test Reading on the **FREQUENCY TESTS** Test Card.
- 6 Subtract the 10 MHz Unit Under Reading from the 10 MHz Frequency Standard Value. Record the difference on the **FREQUENCY TESTS** Test Card.
- 7 If either of the differences are beyond the limits specified, the instrument should be adjusted. See **Chapter 3, "Adjustment Procedures"** to make adjustments.

PERFORMANCE TEST CARD - 1 YEAR LIMITS

Keysight Model 3458A Multimeter

Serial number _____ Test performed by _____
 Date _____

DC VOLTAGE TESTS

CAL? 59 _____
 TEMP? _____
 Difference _____ (must be less than 5 degrees C)
 Perform an ACAL DCV

Test #	3458A input	3458A range	Transfer standard reading	Unit under test reading	Difference	Limit (Std)	Limit (Opt 002)	Pass	Fail
Offset test (NOTE: Math null is disabled)									
1	Short	100 mV	N/A	___ / ___	N/A	000.00106 mV	000.00106 mV	___	___
2	Short	1 V	N/A	___ / ___	N/A	0.00000106 V	0.00000106 V	___	___
3	Short	10 V	N/A	___ / ___	N/A	00.0000023 V	00.0000023 V	___	___
4	Short	100 V	N/A	___ / ___	N/A	000.0000036 V	000.0000036 V	___	___
5	Short	1000 V	N/A	___ / ___	N/A	0000.000010 V	0000.000010 V	___	___

Gain test

1	100 mV	100 mV	___	___	___	000.00212 mV	000.00188 mV	___	___
2	1 V	1 V	___	___	___	0.00000998 V	0.00000740 V	___	___
3	1 V	10 V	___	___	___	00.0000111 V	00.0000085 V	___	___
4	-1 V	10 V	___	___	___	00.0000111 V	00.0000085 V	___	___
5	-10 V	10 V	___	___	___	00.0000892 V	00.0000624 V	___	___
6	10 V	10 V	___	___	___	00.0000892 V	00.0000624 V	___	___
7	100 V	100 V	___	___	___	000.001114 V	000.000853 V	___	___
8	1000 V	1000 V	___	___	___	0000.02396 V	0000.01934 V	___	___

PERFORMANCE TEST CARD - 1 YEAR LIMITS

Keysight Model 3458A Multimeter

Serial number _____

Test performed by _____

Date _____

AC VOLTAGE TESTS
Perform an ACAL AC

Test #	3458A input	3458A range	Transfer standard reading	Unit under test reading	Difference	Limit (Std)	Limit (Opt.002)	Pass	Fail
1	100 mV, 1 kHz	100 mV	_____	_____	_____	000.0250 mV	000.0250 mV	_____	_____
2	1 V, 1 kHz	1 V	_____	_____	_____	0.000250 V	0.000250 V	_____	_____
3	1 V, 1 kHz	10 V	_____	_____	_____	00.000096 V	00.000096 V	_____	_____
4	10 V, 20 Hz	10 V	_____	_____	_____	00.01338 V	00.01338 V	_____	_____
5	10 V, 1 kHz	10 V	_____	_____	_____	00.00250 V	00.00250 V	_____	_____
6	10 V, 20 kHz	10 V	_____	_____	_____	00.00272 V	00.00272 V	_____	_____
7	10 V, 100 kHz	10 V	_____	_____	_____	00.05372 V	00.05372 V	_____	_____
8	10 V, 1 MHz	10 V	_____	_____	_____	00.55450 V	00.55450 V	_____	_____
9	100 V, 1 kHz	100 V	_____	_____	_____	000.0364 V	000.0364 V	_____	_____
10	700 V, 1 kHz	1000 V	_____	_____	_____	0000.544 V	0000.544 V	_____	_____

PERFORMANCE TEST CARD - 1 YEAR LIMITS

Keysight Model 3458A Multimeter

Serial number _____ Test performed by _____
 Date _____

DC CURRENT TESTS

CAL? 59 _____
 TEMP? _____
 Difference _____ (must be less than 5 degrees C)
 Perform an ACAL OHMS

Test #	3458A input	3458A range	Transfer standard reading	Unit under test reading	Difference	Limit (Std)	Limit (Opt 002)	Pass	Fail
Offset test (NOTE: Math null is disabled)									
1	Open	100 µA	N/A	_____	N/A	000.000095 µA	000.000095 µA	_____	_____
2	Open	1 mA	N/A	_____	N/A	0.0000065 mA	0.0000065 mA	_____	_____
3	Open	10 mA	N/A	_____	N/A	00.000065 mA	00.000065 mA	_____	_____
4	Open	100 mA	N/A	_____	N/A	000.000065 mA	000.000065 mA	_____	_____
5	Open	1 A	N/A	_____	N/A	0.0000115 A	0.0000115 A	_____	_____

Gain test

1	100 µA	100 µA	_____	_____	_____	000.000356 µA	000.000356 µA	_____	_____
2	1 mA	1 mA	_____	_____	_____	0.0000323 mA	0.0000323 mA	_____	_____
3	10 mA	10 mA	_____	_____	_____	00.0000323 mA	00.0000323 mA	_____	_____
4	100 mA	100 mA	_____	_____	_____	000.000489 mA	000.000489 mA	_____	_____
5	1 A	1 A	_____	_____	_____	0.0001349 A	0.0001349 A	_____	_____

PERFORMANCE TEST CARD - 1 YEAR LIMITS

Keysight Model 3458A Multimeter

Serial number _____

Test performed by _____

Date _____

OHMS TESTS

CAL? 59 _____

TEMP? _____

Difference _____ – (must be less than 5 degrees C)

Perform an ACAL OHMS

Test #	3458A input	3458A range	Transfer standard reading	Unit under test reading	Difference	Limit (Std)	Limit (Opt 002)	Pass	Fail
2-wire function offset test									
1	Short	10 Ω	N/A	___ / ___	N/A	00.25007 Ω	00.25007 Ω	___	___
4-wire function offset test (rear terminals)									
1	Short	10 Ω	N/A	___ / ___	N/A	00.00007 Ω	00.00007 Ω	___	___
4-wire function gain test									
1	10 Ω	10 Ω	___	___	___	00.00028 Ω	00.00028 Ω	___	___
2	100 Ω	100 Ω	___	___	___	000.00231 Ω	000.00231 Ω	___	___
3	1 kΩ	1 kΩ	___	___	___	0.0000142 kΩ	0.0000142 kΩ	___	___
4	10 kΩ	10 kΩ	___	___	___	0.0000142 kΩ	0.0000142 kΩ	___	___
5	100 kΩ	100 kΩ	___	___	___	0.0000142 kΩ	0.0000142 kΩ	___	___
6	1 MΩ	1 MΩ	___	___	___	0.0000209 MΩ	0.0000209 MΩ	___	___
7	10 MΩ	10 MΩ	___	___	___	00.000703 MΩ	00.000703 MΩ	___	___
7[a]	10 MΩ	10 MΩ	___	___	___	00.000703 MΩ	00.000703 MΩ	___	___

PERFORMANCE TEST CARD - 1 YEAR LIMITS

Keysight Model 3458A Multimeter

Serial number _____

Test performed by _____

Date _____

FREQUENCY TESTS

Test #	3458A input	3458A range	Transfer standard reading	Unit under test reading	Difference	Limit (Std)	Limit (Opt 002)	Pass	Fail
1	1 Hz	N/A	_____	_____	_____	±0.000500 Hz	±0.000500 Hz	_____	_____
2	10 MHz	N/A	_____	_____	_____	±0.001100 MHz	±0.001100 MHz	_____	_____

5 Command Summary

Introduction	84
ACAL	86
CAL	88
CAL?	90
CALNUM?	104
CALSTR	105
REV?	107
SCAL	108
SECURE	111
TEMP?	113
TEST	114

Introduction

This section provides an alphabetical summary of commands that are used in calibrating the 3458A (adjustments or performance verification). Detailed command reference pages for each command are also included in this chapter.

ACAL	Autocal. Instructs the multimeter to perform one or all of its automatic calibrations.
CAL	Calibration. Calibrates the internal 7 V reference to an external 10V standard (CAL 10) followed by an ACAL DCV. It also calibrates the internal 40 k Ω reference to an external 10 k Ω standard (CAL 10E3) followed by an ACAL OHMS. Offset for the front and rear terminals are also calculated (CAL 0).
CAL?	Calibration query. Returns one of four values for the calibration constant specified; the initial (nominal) value, low limit, high limit, or actual value of the specified constant.
CALNUM?	Calibration number query. Returns a decimal number indicating the number of times the multimeter has be adjusted.
CALSTR	Calibration string (remote only). Stores a string in the multimeter's nonvolatile calibration RAM. Typical uses for this string include the date or place of adjustment/verification, technician's name, or the scheduled date for the next adjustment.
REV?	Revision query. Returns two numbers separated by a comma. The first number is the multimeter's outguard firmware revision. The second number is the inguard firmware revision.
SCAL	Service calibration. Adjusts the AC section of the instrument. Calculates the corrections to accurately measure frequency and calibrates the ac ranges.
SECURE	Security code. Allows the person responsible for calibration to enter a security code to prevent accidental or unauthorized adjustment or autocalibration.

TEMP?	Temperature query. Returns the multimeter's internal temperature in degrees Centigrade.
TEST	Self-test. Causes the multimeter to perform a series of internal self-tests. If all constants are within their lower and upper limits, the self-test passes.

ACAL

Description

Autocal. Instructs the multimeter to perform one or all of its automatic calibrations.

Syntax

ACAL [*type*][,*security_code*]

type

The *type* parameter choices are:

<i>type</i> Parameter	Numeric query equivalent	Description
ALL	0	Performs the DCV, AC, and OHMS autocal
DCV	1	DC voltage gain and offset (see first Remark)
AC	2	ACV flatness, gain, and offset (see second Remark)
OHMS	4	OHMS gain and offset (see third Remark)

security_code

When autocal is secured, you must enter the correct security code to perform an autocal (when shipped from the factory, autocal is secured with the security code 3458). When autocal is not secured, no security code is required. Refer to the SECURE command for more information on the security code and how to secure or unsecure autocal.

Remarks

- Since the DCV autocal applies to all measurement functions, you should perform it before performing the AC or OHMS autocal. When ACAL ALL is specified, the DCV autocal is performed prior to the other autocal.
- The AC autocal performs specific enhancements for ACV or ACDCV (all measurement methods), ACI or ACDCI, DSAC, DSDC, SSAC, SSSDC, FREQ, and PER measurements.

- The OHMS autocal performs specific enhancements for 2- or 4-wire ohms, DCI, and ACI measurements.
- Always disconnect any AC input signals before you perform an autocal. If you leave an input signal connected to the multimeter, it may adversely affect the autocal.
- The autocal constants are stored in continuous memory (they remain intact when power is removed). You do not need to perform autocal simply because power has been cycled.
- The approximate time required to perform each autocal routine is:

ALL: 14 minutes

DCV: 2 minutes and 20 seconds

AC: 2 minutes and 20 seconds

OHMS: 10 minutes

- If power is turned off or the **Reset** button is pushed during an ACAL, an error is generated. You must perform an ACAL ALL to recalculate new calibration constants.
- **Related commands:** CAL, SCAL, SECURE

Example

```
OUTPUT 722;"ACAL ALL,3458" !RUNS ALL AUTOCALS, SECURITY CODE IS 3458!  
(FACTORY SECURITY CODE SETTING)
```

CAL

Description

Calibration. Calibrates the internal 7 V reference to an external 10V standard (CAL10) and does the equivalent of ACAL DCV. Also calibrates the internal 40 K reference to an external 10 K standard (CAL 10E3) and does the equivalent of ACAL OHMS. Alternate CAL standard values can be used as described in the first remark. It also calculates the offset for the front and rear terminals (CAL 0).

Syntax

`CAL value [,security _ code]`

value

Specifies the value of the adjustment source that will be used to adjust the multimeter. For highest accuracy, 10 V and 10 K ohm standards are recommended and the *value* sent must be the exact output value of the adjustment source. If the 10 V source actually outputs 10.0001, then specify a value of 10.0001 in the CAL command.

security_code

When a security code is set to a number other than 0 by the SECURE command, you must enter the correct security code to perform a CAL. If CAL is not secured (security code = 0), no security code is required to execute CAL. Refer to the SECURE command for more information on the security code and how to secure the calibration of the 3458A.

Remarks

- For highest accuracy, the value sent with the CAL command must exactly equal the actual output value of the adjustment source. It is recommended that 10V be used for CAL 10 and 10 K ohms be used for CAL 10E3. *NOTE: Any standard value between 1 V and 12 V or 1 k Ω and 12 k Ω can be used. A value less than 10 V or less than 10 k Ω will introduce additional uncertainty to the multimeter's accuracy specifications. For example, a 1 V DC standard can be used instead of 10 V (you would execute CAL 1.0000). A 1 k Ω standard can be used instead of 10 k Ω (you would execute CAL 1E3). Each case degrades the accuracy specifications of the instrument.*

- For highest accuracy when performing a CAL 0, a four-point short must be used. Also, CAL 0 must be performed twice, once for the front terminals and again for the rear terminals. You must manually switch the terminals to be calibrated using the front panel switch.
- It is recommended that the OCOMP command be executed prior to adjusting with the 10 K source and OCOMP be set to ON. This will account for any thermals and result in a more accurate adjustment.
- **Related commands:** ACAL, SCAL, SECURE

Example

```
OUTPUT 722; "CAL 10.0011" !DCV ADJUSTMENT SOURCE = 10.0011 VOLTS
OUTPUT 722;"OCOMP ON"
OUTPUT 722:"CAL 10000.001" !RESISTANCE ADJUSTMENT SOURCE = 10000.001
OHMS
```

CAL?

Description

Calibration query. Returns a string containing one of four values for the calibration constant specified; the initial (nominal) value, low limit, high limit, or actual value of the specified constant. The returned string also contains a description of the constant. This command is in the full command menu; it is not in the short command menu.

Syntax

`CAL? const_id [,cal_item]`

cal_item

Specifies which of the four calibration constant values is to be returned. The *cal_item* parameter choices are:

<i>cal_item</i>	Description
0	Initial (nominal) value
1	Actual value ^[a]
3	Upper limit
5	Lower limit

[a] The default for *cal_item* is the actual value.

const_id

Specifies the identifier number for the calibration constant of interest. Each *const_id* and the associated calibration constant description is listed below.

const_id	Description	Constant derived from
1	40 K Reference	External gain adjustment
2	7 V Reference	External gain adjustment
3	dcv zero front 100 mV	External zero adjustment
4	dcv zero rear 100 mV	
5	dcv zero front 1 V	
6	dcv zero rear 1 V	
7	dcv zero front 10 V	
8	dcv zero rear 10 V	
9	dcv zero front 100 V	
10	dcv zero rear 100 V	
11	dcv zero front 1 kV	
12	dcv zero rear 1 kV	
13	ohm zero front 10	
14	ohm zero front 100	
15	ohm zero front 1 K	
16	ohm zero front 10 K	
17	ohm zero front 100 K	
18	ohm zero front 1 M	
19	ohm zero front 10 M	
20	ohm zero front 100 M	
21	ohm zero front 1 G	

5 Command Summary

const_id	Description	Constant derived from
22	ohm zero rear 10	
23	ohm zero rear 100	
24	ohm zero rear 1 K	
25	ohm zero rear 10 K	
26	ohm zero rear 100 K	
27	ohm zero rear 1 M	
28	ohm zero rear 10 M	
29	ohm zero rear 100 M	
30	ohm zero rear 1 G	
31	ohmf zero front 10	
32	ohmf zero front 100	
33	ohmf zero front 1 K	
34	ohmf zero front 10 K	External zero adjustment
35	ohmf zero front 100 K	
36	ohmf zero front 1 M	
37	ohmf zero front 10 M	
38	ohmf zero front 100 M	
39	ohmf zero front 1 G	
40	ohmf zero rear 10	
41	ohmf zero rear 100	
42	ohmf zero rear 1 K	
43	ohmf zero rear 10 K	
44	ohmf zero rear 100 K	
45	ohmf zero rear 1 M	
46	ohmf zero rear 10 M	

const_id	Description	Constant derived from
47	ohmf zero rear 100 M	External zero adjustment
48	ohmf zero rear 1 G	
49	offset ohm 10	
50	offset ohm 100	
51	offset ohm 1 K	
52	offset ohm 10 K	
53	offset ohm 100 K	
54	offset ohm 1 M	
55	offset ohm 10 M	
56	offset ohm 100 M	
57	offset ohm 1 G	
58	cal 0 temperature	Internal temperatures at time of last CAL adjustment
59	cal 10 temperature	
60	cal 10 K temperature	
61	vos dac (Dac count to zero boot-strap amp Q7, U12) -External zero adj	
62	dci zero rear 100 nA	ACAL OHMS
63	dci zero rear 1 μ A	
64	dci zero rear 10 μ A	
65	dci zero rear 100 μ A	
66	dci zero rear 1 mA	
67	dci zero rear 10 mA	
68	dci zero rear 100 mA	
69	dci zero rear 1 A	
70	dcv gain 100 mV	

5 Command Summary

const_id	Description	Constant derived from
71	dcv gain 1 V	-ACAL DCV
72	dcv gain 10 V	
73	dcv gain 100 V	
74	dcv gain 1 kV	
75	ohm gain 10	-ACAL OHMS
76	ohm gain 100	
77	ohm gain 1 K	
78	ohm gain 10 K	
79	ohm gain 100 K	
80	ohm gain 1 M	
81	ohm gain 10 M	
82	ohm gain 100 M	
83	ohm gain 1 G	
84	ohm ocomp gain 10	-ACAL OHMS
85	ohm ocomp gain 100	
86	ohm ocomp gain 1 K	
87	ohm ocomp gain 10 K	
88	ohm ocomp gain 100 K	
89	ohm ocomp gain 1 M	
90	ohm ocomp gain 10 M	
91	ohm ocomp gain 100 M	
92	ohm ocomp gain 1 G	
93	dci gain 100 nA	
94	dci gain 1 μ A	
95	dci gain 10 μ A	

const_id	Description	Constant derived from
96	dci gain 100 μ A	ACAL OHMS
97	dci gain 1 mA	
98	dci gain 10 mA	
99	dci gain 100 mA	
100	dci gain 1 A	
101	precharge dac	ACAL OHMS
102	mc dac (dac settings to minimize charge coupling from input fets)	
103	high speed gain	
104	il (OFF leakage of ohmmeter current source)	
105	il2 (input leakage correction used on 1 M Ω and higher)	
106	rin (value of 10 M Ω attenuator RP7)	
107	low aperture	ACAL DCV
108	high aperture	
109	high aperture slope .01 PLC	
110	high aperture slope .1 PLC	
111	high aperture null .01 PLC	
112	high aperture null .1 PLC	
113	underload dcv 100 mV	ACAL DCV
114	underload dcv 1 V	
115	underload dcv 10 V	

5 Command Summary

const_id	Description	Constant derived from
116	underload dcv 100 V	-ACAL DCV
117	underload dcv 1000 V	
118	overload dcv 100 mV	-ACAL DCV
119	overload dcv 1 V	
120	overload dcv 10 V	
121	overload dcv 100 V	
122	overload dcv 1000 V	
123	underload ohm 10	-ACAL OHMS
124	underload ohm 100	
125	underload ohm 1 K	
126	underload ohm 10 K	
127	underload ohm 100 K	
128	underload ohm 1 M	
129	underload ohm 10 M	
130	underload ohm 100 M	
131	underload ohm 1 G	
132	overload ohm 10	
133	overload ohm 100	
134	overload ohm 1 K	
135	overload ohm 10 K	
136	overload ohm 100 K	
137	overload ohm 1 M	
138	overload ohm 10 M	
139	overload ohm 100 M	

const_id	Description	Constant derived from
140	overload ohm 1 G	
141	underload ohm ocomp 10	
142	underload ohm ocomp 100	
143	underload ohm ocomp 1 K	
144	underload ohm ocomp 10 K	
145	underload ohm ocomp 100 K	
146	underload ohm ocomp 1 M	
147	underload ohm ocomp 10 M	
148	underload ohm ocomp 100 M	
149	underload ohm ocomp 1 G	
150	overload ohm ocomp 10	
151	overload ohm ocomp 100	
152	overload ohm ocomp 1 K	ACAL OHMS
153	overload ohm ocomp 10 K	
154	overload ohm ocomp 100 K	
155	overload ohm ocomp 1M	
156	overload ohm ocomp 10 M	
157	overload ohm ocomp 100 M	
158	overload ohm ocomp 1 G	
159	underload dci 100 nA	
160	underload dci 1 μ A	
161	underload dci 10 μ A	
162	underload dci 100 μ A	
163	underload dci 1 mA	

5 Command Summary

const_id	Description	Constant derived from	
164	underload dci 10 mA	-ACAL OHMS	
165	underload dci 100 mA		
166	underload dci 1 A		
167	overload dci 100 nA		
168	overload dci 1 μ A		
169	overload dci 10 μ A		
170	overload dci 100 μ A		
171	overload dci 1 mA		
172	overload dci 10 mA		
173	overload dci 100 mA		
174	overload dci 1 A		
175	acal dcv temperature		-Last ACAL temperatures
176	acal ohm temperature		
177	acal acv temperature		
178	ac offset dac 10 mV	-ACAL AC	
179	ac offset dac 100 mV		
180	ac offset dac 1 V		
181	ac offset dac 10 V		
182	ac offset dac 100 V		
183	ac offset dac 1 kV		
184	acdc offset dac 10 mV		
185	acdc offset dac 100 mV		
186	acdc offset dac 1 V		

const_id	Description	Constant derived from
187	acdc offset dac 10 V	
188	acdc offset dac 100 V	
189	acdc offset dac 1 kV	
190	acdc offset dac 100 μ A	
191	acdc offset dac 1 mA	
192	acdc offset dac 10 mA	
193	acdc offset dac 100 mA	
194	acdc offset dac 1 A	
195	flatness dac 10 mV	
196	flatness dac 100 mV	
197	flatness dac 1 V	
198	flatness dac 10 V	
199	flatness dac 100 V	ACAL AC
200	flatness dac 1 kV	
201	level dac dc 1.2 V	
202	level dac dc 12 V	
203	level dac ac 1.2 V	
204	level dac dc 12 V	
205	dcv trigger offset 100 mV	
206	dcv trigger offset 1 V	
207	dcv trigger offset 10 V	
208	dcv trigger offset 100 V	
209	dcv trigger offset 1000 V	

5 Command Summary

const_id	Description	Constant derived from
210	acdcv sync offset 10 mV	
211	acdcv sync offset 100 mV	
212	acdcv sync offset 1 V	
213	acdcv sync offset 10 V	
214	acdcv sync offset 100 V	
215	acdcv sync offset 1 kV	
216	acv sync offset 10 mV	
217	acv sync offset 100 mV	
218	acv sync offset 1 V	
219	acv sync offset 10 V	
220	acv sync offset 100 V	
221	acv sync offset 1 kV	-ACAL AC
222	acv sync gain 10 mV	
223	acv sync gain 100 mV	
224	acv sync gain 1 V	
225	acv sync gain 10 V	
226	acv sync gain 100 V	
227	acv sync gain 1 kV	
228	ab ratio	
229	gain ratio	
230	acv ana gain 10 mV	
231	acv ana gain 100 mV	

const_id	Description	Constant derived from
232	acv ana gain 1 V	ACAL AC
233	acv ana gain 10 V	
234	acv ana gain 100 V	
235	acv ana gain 1 kV	
236	acv ana offset 10 mV	
237	acv ana offset 100 mV	
238	acv ana offset 1 V	
239	acv ana offset 10 V	
240	acv ana offset 100 V	
241	acv ana offset 1 kV	
242	rmsdc ratio	
243	sampdc ratio	
244	aci gain	
245	freq gain	
246	attenuator high frequency dac	
247	amplifier high frequency dac 10 mV	
248	amplifier high frequency dac 100 mV	
249	amplifier high frequency dac 1 V	
250	amplifier high frequency dac 10 V	

const_id	Description	Constant derived from
251	amplifier high frequency dac 100 V	SCAL
252	amplifier high frequency dac 1 kV	
253	interpolator	

Remarks

Related commands: ACAL, CAL, SCAL

Example

The following two program examples query the calibration constants. The first program returns an individual response while the second program lists all 253 calibration constants. The parameter "T" in each program specifies the *cal_item* which calls for the initial value, lower limit, upper limit, or actual value.

Return an individual calibration constant (#2).

```

10 PRINTER IS 701
20 DIM A$ [100]
30 T=3                               !Specifies the cal_item
40 PRINT "Cal item=", T
50 OUTPUT 722;"QFORMAT ALPHA"       !Enables alpha/numeric query response
60 OUTPUT 722;"CAL? 2", T           !Queries constant #2
70 ENTER 722;A$
80 PRINT A$
90 END

```

Return the entire set of calibration constants.

```

10 PRINTER IS 701
20 DOM A$ [100]
30 T=3                               !Specifies the cal_item

```

```
40  FOR N=1 TO 253
50  PRINT "Cal item=", T
60  PRINT "CONST =", N
70  OUTPUT 722;"QFORMAT ALPHA"
80  OUTPUT 722;"CAL?";N,T
90  ENTER 722; A$
100 PRINT A$
110 NEXT N
120 END
```

CALNUM?

Description

Calibration Number Query. Returns a decimal number indicating the number of times the multimeter has been adjusted.

Syntax

CALNUM?

Remarks

- The calibration number is incremented by 1 whenever the multimeter is unsecured and adjusted. If autocal is secured, the calibration number is also incremented by 1 whenever an autocal is performed; if unsecured, autocal does not affect the calibration number.
- The calibration number is stored in cal-protected memory and is not lost when power is removed.
- The multimeter was adjusted before it left the factory which increments the CALNUM. When you receive the multimeter, read the calibration number to determine its initial value.
- **Related commands:** CAL. CALSTR. SCAL

Example

```

10 OUTPUT 722;"CALNUM?"           !READS CALIBRATION NUMBER
20 ENTER 722;A                     !ENTERS RESPONSE INTO COMPUTER
30 PRINT A                          !PRINTS RESPONSE
40 END

```

CALSTR

Description

Calibration String (remote only). Stores a string in the multimeter's nonvolatile calibration RAM. Typical uses for this string include the date or place of calibration, technician's name, last CALNUM value, or the scheduled date for the next calibration.

Syntax

`CALSTR string[,security_code]`

string

This is the alpha/numeric message that will be appended to the calibration RAM. The *string* parameter must be enclosed in single or double quotes. The maximum string length is 75 characters (the quotes enclosing the string are not counted as characters).

security_code

When the calibration RAM is secured (SECURE command) you must include the *security_code* in order to write a message to the calibration RAM. (You can always read the string using the CALSTR? command regardless of the security mode). Refer to the SECURE command for information on securing and unsecuring the calibration RAM.

Remarks

- **Query Command.** The CALSTR? query command returns the character string from the multimeter's calibration RAM. This is shown in the second example below.
- **Related commands:** CAL, CALNUM?, SCAL, SECURE

Examples

CALSTR

```
OUTPUT 722; "CALSTR 'CALIBRATED 04/02/1987; temp(C)=43.1'"
```

5 Command Summary

CALSTR?

10 DIM A\$[80]	!DIMENSION STRING VARIABLE
20 OUTPUT 722; "CALSTR?"	!READ THE STRING
30 ENTER 722;A\$!ENTER STRING
40 PRINT A\$!PRINT STRING
50 END	

REV?

Description

Revision Query. Returns two numbers separated by a comma. The first number is the multimeter's outguard firmware revision. The second number- is the inguard firmware revision.

Syntax

REV?

Example

```
10 OUTPUT 722; "REV?"           !READ FIRMWARE REVISION NUMBERS
20 ENTER 722; A,B               !ENTER NUMBERS
30 PRINT A,B                     !PRINT NUMBERS
40 END
```

SCAL

Description

Service Calibration. Adjusts the AC sections of the instrument. Calculates the corrections to accurately measure frequency and adjusts the ac ranges. The SCAL command is located in the full command menu.

NOTE

The SCAL command is used in the **AC Adjustment** procedure of **Chapter 3** and the procedure must be performed in the order specified.

Syntax

```
SCAL value [,security_code]
```

value

Specifies the value of the adjustment source that will be used to do the service adjustment of the multimeter. Valid choices for *value* are 1E5, 10, 1, and 0.1. 1E5 performs a frequency calibration while 10, 1, and 0.1 do ac range adjustment.

security_code

When a security code is set to a number other than 0 by the SECURE command, you must enter the correct security code to perform an SCAL. If SCAL is not secured (security code = 0), no security code is required to execute SCAL. Refer to the SECURE command for more information on the security code and how to secure the adjustment of the 3458A.

Remarks

- The SCAL command is in the full menu; it is not in the short menu.
- With a 100 kHz input, SCAL 1E5 calculates the constants allowing the multimeter to indicate 100 kHz.
- SCAL 10, SCAL 1, and SCAL 0.1 do ac range calibration calculating high frequency dac and interpolator constants.
- For fastest calibration with SCAL, the multimeter can be left in the DCV function.

- With a 100 kHz input, ACBAND is set to ACBAND 10, 2E6.
- With 2 MHz and 8 MHz inputs, ACBAND is set to ACBAND 10, 10E6.
- **Related commands:** ACAL, CAL, SECURE

Example

OUTPUT 722;"SCAL 1E5"

!Adjusts for frequency

OUTPUT 722;"SCAL 10"

!Adjusts range

OUTPUT 722;"SCAL 1"

OUTPUT 722;"SCAL 0.1"

SECURE

Description

Security Code. Allows the person responsible for adjustment to enter a security code to prevent accidental or unauthorized adjustment or autocalibration (autocal).

Syntax

`SECURE old_code, new_code [,acal_secure]`

old_code

This is the multimeter's previous security code. The multimeter is shipped from the factory with its security code set to 3458.

new_code

This is the new security code. The code is an integer from $-2.1E-9$ to $2.1E9$. If the number specified is not an integer, the multimeter rounds it to an integer value.

acal_secure

Allows you to secure autocalibration. The choices are:

acal_secure parameter	Numeric query equivalent	Description
OFF	0	Disables autocal security; no code required for autocal
ON	1	Enables autocal security; the security code is required to perform autocal (see ACAL for example).

Power-on acal_secure = Previously specified value (OFF is the factory setting).

Default acal_secure = OFF.

Remarks

- Specifying 0 for the *new_code* disables the security feature making it no longer necessary to enter the security code to perform an adjustment or autocal.

- The front panel's **Last Entry** key will not display the codes used in a previously executed SECURE command.
- In the event that the secure code is lost or unknown by the user, a procedure is presented in [Chapter 1](#) (section titled [Changing the security code](#)) that allows for unsecuring the instrument after removal of the top cover.
- **Related commands:** ACAL. CAL. CALNUM?. CALSTR. SCAL

Examples

Changing the code

```
OUTPUT 722;"SECURE 3458,4448,ON" !CHANGE FACTORY SECURITY CODE TO 4448,  
!ENABLE AUTOCAL SECURITY
```

Disabling security

```
OUTPUT 722;"SECURE 3458,0" !DISABLES SECURITY FOR ADJUSTMENT AND  
AUTOCAL
```

TEMP?

Description

Temperature Query. Returns the multimeter's internal temperature in degrees Centigrade.

Syntax

TEMP?

Remarks

- Monitoring the multimeter's temperature is helpful to determine when to perform autocalibration.
- **Related commands:** ACAL, CAL, CALSTR

Example

```
10 OUTPUT 722; "TEMP?"           !READ TEMPERATURE
20 ENTER 722; A                   !ENTER RESULT
30 PRINT A                         !PRINT RESULT
40 END
```

TEST

Description

Causes the multimeter to perform a series of internal self-test.

Syntax

TEST

Remarks

- Always disconnect any input signals before you run self-test. If you leave an input signal connected to the multimeter, it may cause a self-test failure.
- If a hardware error is detected, the multimeter sets bit 0 in the error register and a more descriptive bit in the auxiliary error register. The display's **ERR** annunciator illuminates whenever an error register bit is set. You can access the error registers using ERRSTR? (both registers'), ERR? (error register only) or AUXERR? (auxiliary error register only).
- **NOTE:** The internal self-test checks all calibration constants and verifies they are within the lower and upper limits.
- **Related commands:** AUXERR?, ERR?, ERRSTR?

Example

```
OUTPUT 722;"TEST"           !RUNS SELF-TEST
```

A Specifications

For the specifications and characteristics of the 3458A multimeter, refer to the datasheet at <http://literature.cdn.keysight.com/litweb/pdf/5965-4971E.pdf>.

THIS PAGE HAS BEEN INTENTIONALLY LEFT BLANK.

B Electronic Calibration of the 3458A (Product Note 3458A-3)

Introduction	118
Saving Calibration Time and Money	119
Summary	126

Introduction

A voltmeter has four basic functional blocks.

The input signal must first pass through some type of signal conditioner. For a DC input voltage, the signal conditioner may consist of an attenuator for the higher voltage ranges and a DC amplifier for the lower ranges. If the input signal is an AC voltage, an RMS converter changes the AC signal to an equivalent DC value. By supplying a DC current, an ohms converter changes resistance to a DC voltage. In nearly all cases, the input signal conditioner converts the unknown quantity to a DC voltage that is within the range of the A-to-D converter.

The job of the A-to-D converter is to take a pre-scaled DC voltage and convert it to digits. A-to-D converters are single range DC voltage devices. Some take a 1 V full-scale input while others take a 10 V full-scale input. For this reason, the signal conditioner must attenuate higher voltages and amplify lower voltages to give the voltmeter a selection of ranges.

Let's take an example. Suppose we apply 250 V AC to a voltmeter with an A-to-D converter that requires a 1 V DC input. The AC signal is attenuated on the 1000 V AC range and converted to a DC voltage equal to 0.25 V. The final reading appears as "250.0 V AC." (In general, AC in the 3458A multimeter uses 2 V full-scale.)

These first two building blocks govern the voltmeter's basic characteristics such as its number of digits, its ranges, and its sensitivity. The A-to-D converter governs a voltmeter's

speed, resolution, and, in some cases, its ability to reject noise.

The logic block manages the flow of information and the correct sequence of various internal functions. The logic also acts as a communicator with the outside world. Specifically, the logic manages the outward flow of digital information and accepts programming instructions from other devices. The display communicates visually the result of a measurement. In selecting a voltmeter to fill a specific application, these building blocks combine to give the instrument its specific performance characteristics.

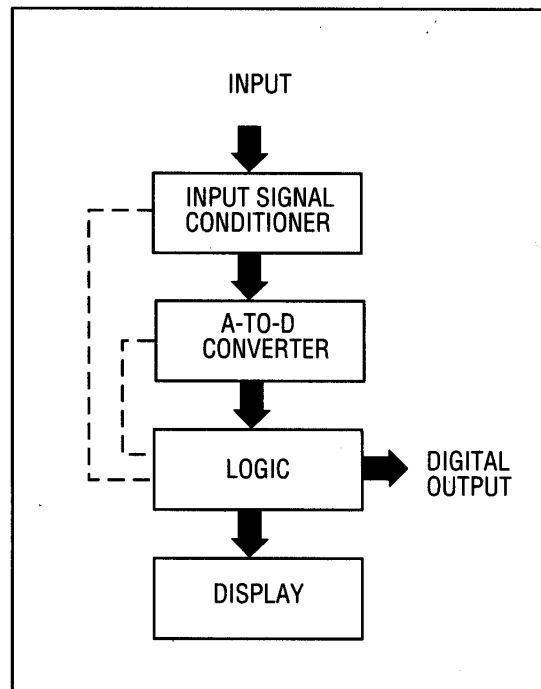

Saving Calibration Time and Money

The increasing accuracy required of today's instrumentation tends to increase complexity and cost of maintaining calibration of these instruments. In an effort to reduce the cost and complexity of calibration, the 3458A multimeter reduces the number of external reference standards required for calibration. All functions and ranges require only one external DC voltage standard and only one external resistance standard.

Many of the external reference standards traditionally maintained and used by metrology laboratories for calibration (for example, resistive networks and DC-to-AC transfer devices) are being replaced with internal circuitry and algorithms that can achieve comparable results. With the 3458A multimeter, all adjustments are electronic - there are no potentiometers in this instrument.

For many applications, you can substantially increase the time between calibrations, saving costs. For example, the standard 3458A multimeter is as accurate at the end of a year as most multimeters are at the end of a day.

In systems, rack temperatures are typically more than 40°C and have wide temperature variations. Auto-calibration of the 3458A multimeter improves measurement accuracy under these circumstances.

The end result is that the 3458A multimeter measures DC and AC with unmatched accuracy, precision, and speed, while avoiding the usual high cost of maintaining such an instrument.

The basis for auto-calibration

Only three external inputs are needed as the basis for all normal adjustments:

- Four-wire short
- 10 V DC voltage standard
- 10 k Ω resistance standard

Normal calibration, described below, provides traceability of all functions, ranges, and internal reference standards to the two external standards. An additional auto-calibration process adjusts the 3458A multimeter using internal reference standards that are traceable to the external standards via the normal calibration process. Thus invoking auto-calibration at any time produces exemplary accuracy over a long time frame and over widely varying operating temperatures.

Multimeter designers and users have always had to cope with how to reduce offset and gain error introduced into measurements by internal circuits of the multimeter. These errors constantly change because component characteristics vary with time, temperature, humidity, and other environmental conditions. Early multimeters reduced internal errors by adjusting the value of key components. The use of adjustable components had two major drawbacks. First, making adjustments often required removing the multimeter's covers. Unfortunately, removing the covers changed the temperature within the multimeter. Second, adjustable components were often a major contributor to drift that caused inaccuracies.

With the emergence of non-volatile memory, multimeters were designed with few or no adjustable components. Instead, microprocessors were used to calculate a gain

and offset correction for each function and range. These correction constants were then stored in non-volatile memory and used to correct the errors of the internal circuitry. Calibration was improved because covers were removed during calibration and the multimeter's internal circuits required no adjustable components.

The 3458A goes beyond these techniques by conveniently correcting errors due to time or environmental variations. Adjustments primarily consist of offset and gain constants, although all other errors are considered. A patent pending technique prevents the loss of calibration constants in non-volatile memory.

The analog-to-digital converter's linearity and transfer accuracy are fundamentally important to the calibration technique used in the 3458A multimeter. The linearity of the analog-to-digital converter gives the instrument the ability to measure the ratio of two DC voltages at state-of-the-art accuracies. In other words, this converter maintains its accuracy over the entire measurement range, without any internal adjustments. The speed of the analog-to-digital converter allows an internal DC to AC transfer of accuracy, again state-of-the-art.

The analog-to-digital converter achieves this performance using a patented technique known as "multislope integration." This technique uses charge balancing, where the charge from the input signal is canceled by charge injected from reference signals. Multi-slope integration also allows the integration aperture to be changed so that measurement resolution can be traded for measurement speed.

Measurements using a Josephson junction standard confirm linearity of the

analog-to-digital converter design. These measurements reveal integral linearity below 0.1 parts per million and differential linearity of 0.02 parts per million. This performance, incidentally, is comparable to a Kelvin-Varley divider.

The only errors not removed in the 3458A multimeter calibration are drifts of the internal voltage reference and the internal resistance standard. The internal reference voltage has an average drift during its first 90 days of less than 2 parts per million. As shown in Figure 1, the three sigma points are less than 4 parts per million. For DC volt transfer measurements, the 3458A multimeter's short-term stability is within 0.1 parts per million of reading.

The internal reference resistor has a specified drift of 5 parts per million per year and a temperature coefficient of 1 part per million per Celsius degree.

Auto-calibration adjusts for time and temperature drifts in the rest of the circuitry, relative to these internal references.

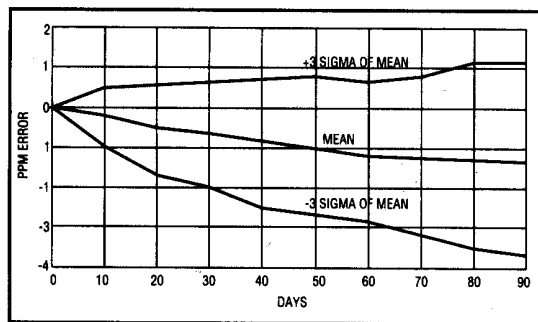

Figure 1.

This plot shows stability with time of the reference voltage standard used in the 3458A multimeter.

Offset adjustments

To remove offset errors of internal circuits, the multimeter internally connects a short in place of the input terminals and measures the offset. Normal measurements of signals on the input terminals subtract this offset to give the correct reading. The only offset errors not removed by this approach are thermocouple offsets along the path from the input terminals to the point that is switched to the internal short.

These errors require a four-wire short on both the front and rear input terminals (switch selected). With these external inputs, one command, CAL 0, executes zero offset measurements that result in additional offset calibration constants to correct subsequent readings.

Other multimeters use this approach to removing offset errors. The 3458A multimeter simply makes improvements by using more stable components, again minimizing time and environmental errors.

DC gain adjustments

Gain adjustments of all five DC voltage ranges (100 mV full-scale to 1000 V full-scale) require only one external DC voltage standard. The DC voltage input path, shown in Figure 2, requires three adjustments, potentially. The product, represents the calibration gain used on any given range.

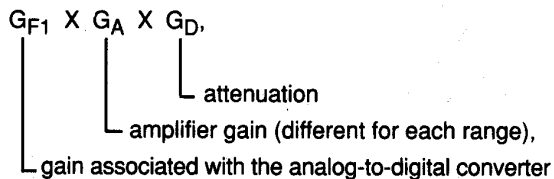

Internal tolerance limits for each gain adjustment are factory set. A gain value outside the associated tolerance indicates a malfunctioning instrument. Therefore, as the gain adjustments are being computed, the instrument checks the value of each gain adjustment and flags errors accordingly.

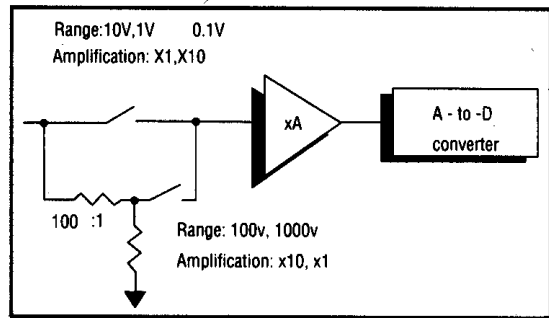

Figure 2.

The DC input path to the analog-to-digital converter is either through an amplifier only or through an additional resistive attenuator, depending on the range used.

The user enters the exact value of the external 10 V DC voltage standard (for example, "CAL 10"). The following sequence, performed automatically by the 3458A multimeter, determines gain constants for all ranges:

- 1 Measure the external "10 V" standard on the 10 V range.
- 2 Create the gain adjustment for the 10 V range using the ratio of the measured and actual values.
- 3 Measure accuracy of the internal reference voltage relative to the external standard, and store the difference as a reference adjustment. (When subsequently invoked, auto-calibration uses this stored value to re-determine all gain adjustment constants).

Gain adjustments are now made for all other DC voltage ranges.

- 4 Using the input path for the 10 V range, accurately measure 1 V generated internally.

Linearity of the measurement circuits allows a measurement that accurately reflects the actual 1 V output. In other words, we transfer traceable accuracy from the 10 V range to all other ranges.

The lower ranges use amplifiers to condition the input for the 10 V full-scale analog-to-digital converter. Each amplifier used requires a gain constant, G_A , to adjust normal readings. The following process determines these constants.

- 5 In the 1 V range, measure the same 1 V previously measured with the 10 V range.
- 6 Calculate a 1 V range gain adjustment so that the two measurements agree. Note that neither the precise value nor the long-term stability of the internal 1 volt source are important. The internal 1 volt source need only be stable for the time it takes to measure it twice.
- 7 Using the adjusted 1 V range, accurately measure 0.1 V generated internally.
- 8 Measure the same 0.1 V using the 100 mV range.
- 9 Calculate a 100 mV range gain adjustment so that the two measurements agree.

Normal 100 V and 1000 V range measurements use a 100:1 resistor network to attenuate the input. To correct errors introduced by this network, we apply zero volts to the input. Then, we apply 10 V and measure the actual value. Finally, we measure 0.1 V, with the zero error removed, and compute the gain adjustment constant.

Input voltages greater than 100 V (1000 V range) create a self-heating error in the resistor network, as shown in Figure 3. This easily identified error is simply specified as part of the instrument's published error. Additional measurements result in constants to compensate for switching transients and leakage currents.

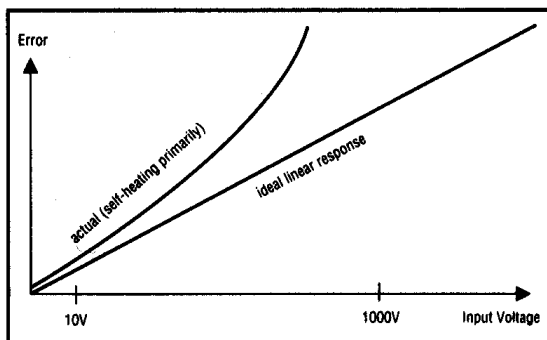

Figure 3. On the 1000 V range, nonlinear self-heating errors of the 100:1 resistive attenuator are noticeable.

Resistance and DC current adjustments

Calibration of all resistance (nine ranges from 10 Ω to 1 G Ω) and DC current ranges (eight ranges from 100 nA to 1 A) requires only one external resistance standard. Resistance is measured by applying a known current through the unknown resistance and measuring the voltage across it. Current is measured by applying the unknown current through a known shunt resistor and measuring the voltage across it. The process explained previously has already corrected errors in the DC voltage input path. Measuring the actual values of the current sources and shunt resistors results in the

additional information needed to adjust resistance and current measurements.

Both current and resistance are calibrated concurrently. For resistance measurements, a current source provides 500 nA to 10 mA, depending on the measurement range. Current measurements use shunt resistor values that vary from 0.1 Ω to 545.2 k Ω .

The user enters the exact value of the external 10 kilohm standard (for example, "CAL 10E3"). The following sequence, performed automatically by the 3458A multimeter, determines adjustment constants for all ranges of resistance and DC current:

- 1 Make a four-wire offset-compensated measurement of the external "10 k Ω " using the 10 k Ω range.
- 2 Use the ratio of the measured and actual values as the 10 k Ω range calibration constant (current source adjustment for the 10 k Ω range).
- 3 Measure the internal reference resistor relative to the external standard, and store the difference as a reference adjustment. (When subsequently invoked, auto-calibration uses this stored value to re-determine adjustment constants.)
- 4 Use the calibrated internal reference resistor to adjust current source values used for other resistance ranges.
- 5 Use calibrated current sources to adjust shunt resistor values used for DC current measurements.

Leakage currents for resistance measurements and offsets produced with shunt resistors for current measurements are additional sources of error. Adjustment of these errors is simply a

matter of measuring and storing the results as adjustment constants.

AC flatness and gain adjustments

Routine calibration of AC voltage and current functions requires no external AC standards. To accurately measure AC signals, the internal circuits must have constant gain versus frequency of the input signal. An Keysight Technologies patented technique electronically adjusts the entire AC section, shown in Figure 4. This technique first adjusts frequency response flatness of the AC attenuator network, then adjusts gains of the RMS converter and track-and-hold amplifier.

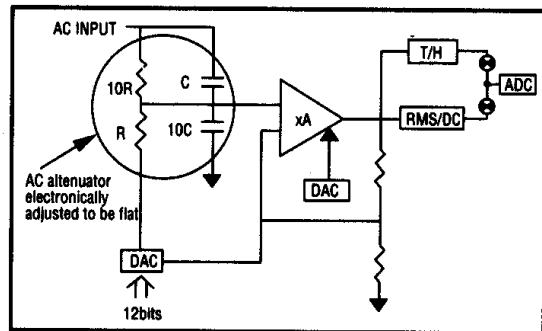

Figure 4.

The AC input paths are first adjusted for flatness. Later, in the normal calibration process, gain adjustments are made.

Similar to the adjustment of an oscilloscope probe, proper adjustment of the AC attenuator network produces a maximally flat response to a step input voltage, as shown in Figure 5. A circuit that responds to a step input with an undistorted step output has constant gain versus frequency

of the input signal, which can be shown using Fourier transform theory.

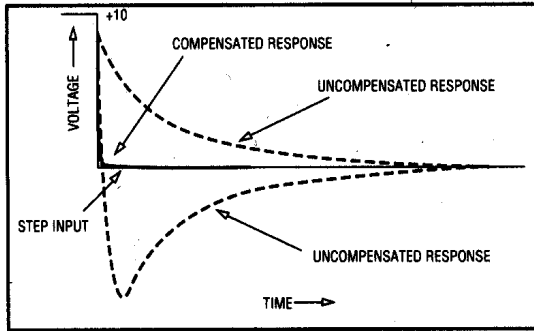

Figure 5.

The frequency response of the AC attenuator is adjusted based on two readings taken at specific delays after application of a step input. Shown in this drawing are two different uncompensated responses representing under shoot and overshoot.

The 3458A multimeter produces the required step input voltage. Then, its analog-to-digital converter samples the attenuator output. These measurement results determine constants used to control the output of the flatness adjusting DAC. Control of the DAC output effectively changes the resistance in one leg of the attenuator to produce the desired maximally flat response. Calibration constants are separately determined for each AC range.

AC converters normally have turnover errors. A standard metrology practice is to use \pm signals to correct these errors. A shorter time between samples of these \pm signals reduces $1/f$ noise. Thus the 3458A multimeter samples at a higher rate to give $1/f$ rejection, as indicated in Figure 6.

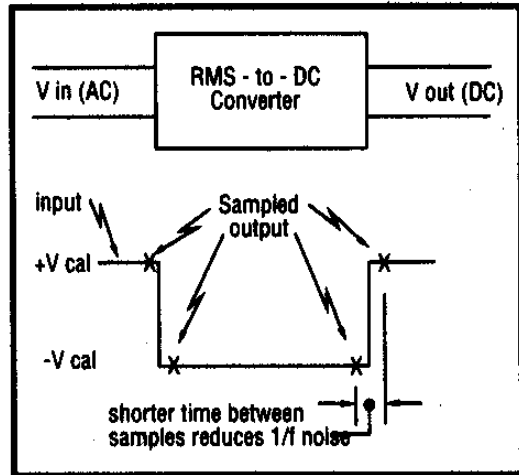

Figure 6.

Positive and negative signals are internally provided to eliminate turnover errors. This input is also sampled at a higher rate to reject $1/f$ noise.

These signals are applied to the RMS converter and track-and- hold amplifier paths. Attenuated or amplified levels produce inputs appropriate for each of six AC voltage ranges. The 3458A multimeter measures the correct values of these DC levels with the DC input path that has already been calibrated. These known values are compared with the measured gains of the RMS converter and track-and-hold amplifier paths. Gain constants are the result of transferring accuracy between ranges, as discussed under DC gain adjustments.

Gain of the RMS converter is non-linear at one-tenth full scale. This non-linearity is effectively an offset corrected by applying the chopped DC levels at one-tenth the full-scale voltage.

One-time adjustments

The following electronic adjustments are only performed once at the factory or following repair of the circuitry involved.

- 1** Determine the actual frequency value of the crystal used for frequency and period measurements.
- 2** Adjust time base interpolator accuracy.
- 3** Adjust high frequency response of the AC attenuator and amplifier by transfer of accuracy at 100 kHz to 2 MHz and 8 MHz.

Traceability

The above methods result in all functions and ranges being traceable to one or both of the internal reference standards. These internal standards are, in turn, traceable to the external standards. The problem is knowing the uncertainty to which they are traceable. The answer lies in knowing the maximum uncertainty of each transfer measurement made. The dominant sources of transfer uncertainty are the linearity errors of the internal circuits and the noise of each measurement. Each transfer measurement contributes some error. With multiple transfers between ranges, the error is cumulative.

However, the excellent short-term stability of the internal references and the superior linearity of the analog-to-digital converter minimizes these errors. For example, the cumulative transfer error for the 3458A multimeter is less than 1 part per million on the lower three DC volt ranges.

All calibration transfer errors and noise errors are included in the published accuracy specifications of the 3458A multimeter.

Summary

Electronic internal calibration of the 3458A multimeter simplifies and shortens the calibration time, while maintaining accuracy and traceability. This multimeter removes all drift errors, with the exception of the internal reference standard drift errors. As a result, the scheme relies on the excellent stability of the reference voltage and resistor, and superb linearity of the analog to-digital converter.

Depending on the application, auto-calibration using the internal reference standards results in one or more of the following benefits:

- Improved measurement accuracy
- Extended time between calibrations
- Extended operating temperature range
- Reduced errors resulting from other environmentally- caused errors, such as circuit changes with humidity

These benefits are especially significant when compared with earlier generation multimeters used in metrology, electronic test, and many other demanding applications.

There are a total of 253 calibration constants stored in the 3458A multimeter (these constants can be queried). Of these constants, only 44 are routinely determined from external measurements.

Externally derived calibration constants

Offset Constants:

- DC volts, 0.1 V to 10 V ranges, Front and rear input terminal paths; 6 offset constants
- Two-wire resistance, 10 Ω to 1 G Ω ranges, Front and rear input terminal paths; 18 offset constants
- Four-wire resistance, 10 Ω to 1 G Ω ranges, Front and rear input terminal paths; 18 offset constants

Internal Reference Constants:

- Voltage - value of internal reference voltage; 1 constant
- Resistance - value of internal reference resistor; 1 constant

Of the remaining 209 calibration constants in the instrument, 6 are determined through one-time external calibrations. These constants provide adjustments for frequency and period measurements, time base interpolation, and the high frequency (beyond 2 MHz) AC response.

Six additional constants are provided for user convenience. These constants record the temperature of the last offset calibration, last external voltage standard calibration, last external resistance standard calibration, last auto-calibration of DC, last auto-calibration of AC, and last auto-calibration of resistance.

The remaining 197 constants are determined through internal ratio transfer measurements as previously described. These constants are also updated each time auto-calibration (ACAL ALL) is executed, reducing time, temperature, or environmentally-induced drift errors. This capability enhances measurement accuracies over extended time intervals and operating temperature ranges.



This information is subject to change without notice. Always refer to the Keysight website for the latest revision.

© Keysight Technologies 1988 - 2021
Edition 10, September 15, 2021

Printed in Malaysia



03458-90017

www.keysight.com