

EL30000 Series DC Electronic Loads



Notices	4
Copyright Notice	4
Manual Part Number	4
Edition	4
Published by	4
Warranty	4
Technology Licenses	4
U.S. Government Rights	5
Third Party Licenses	5
Waste Electrical and Electronic Equipment (WEEE)	5
Declarations of Conformity	5
Safety Information	6
1 Service and Maintenance	7
Specifications and Characteristics	8
General Information	8
Types of service available	8
Obtaining repair service (worldwide)	8
Repackaging for shipment	8
Cleaning and handling	8
Troubleshooting	9
Self-Test Procedures	9
User Replaceable Parts	9
Battery Replacement	10
Replacing the Battery	10
Disassembly	11
Removing the front panel	11
Removing/Installing the knob	12
Installing the strap handler	12
Removing/Installing the GPIB module (EL34143A and EL34243A only)	12
2 Verification and Adjustments	13
Performance Verification	14
Recommended test equipment	14
Test considerations	14
Measurement techniques	15
Verification Test Setup	15
Constant Voltage (CV) verification	16
Constant Current (CC) verification	17
Constant Resistance (CR) verification	19
Constant Power (CP) verification	22
Test Record Forms	24
Test record form - Keysight EL33133A	24
Test record form - Keysight EL34143A	26
Test record form - Keysight EL34243A	28
Calibration Adjustment Procedures	30
Closed-case electronic calibration	30
Calibration interval	30
Calibration adjustment process	30
Calibration security	30
Calibration count	31
Calibration message	31

Saving calibration data	32
Calibration auto save	32
Calibration Test Setup	32
Calibration procedure	33
Save the calibration data	37

Notices

Copyright Notice

© Keysight Technologies 2020, 2021

No part of this manual may be reproduced in any form or by any means (including electronic storage and retrieval or translation into a foreign language) without prior agreement and written consent from Keysight Technologies as governed by United States and international copyright laws.

Manual Part Number

EL34243-90008

Edition

Edition 1, July 5, 2021

Published by

Keysight Technologies
Bayan Lepas Free Industrial Zone
11900 Bayan Lepas, Penang
Malaysia

Warranty

THE MATERIAL CONTAINED IN THIS DOCUMENT IS PROVIDED “AS IS,” AND IS SUBJECT TO BEING CHANGED, WITHOUT NOTICE, IN FUTURE EDITIONS. FURTHER, TO THE MAXIMUM EXTENT PERMITTED BY APPLICABLE LAW, KEYSIGHT DISCLAIMS ALL WARRANTIES, EITHER EXPRESS OR IMPLIED, WITH REGARD TO THIS MANUAL AND ANY INFORMATION CONTAINED HEREIN, INCLUDING BUT NOT LIMITED TO THE IMPLIED WARRANTIES OF MERCHANTABILITY AND FITNESS FOR A PARTICULAR PURPOSE. KEYSIGHT SHALL NOT BE LIABLE FOR ERRORS OR FOR INCIDENTAL OR CONSEQUENTIAL DAMAGES IN CONNECTION WITH THE FURNISHING, USE, OR PERFORMANCE OF THIS DOCUMENT OR OF ANY INFORMATION CONTAINED HEREIN. SHOULD KEYSIGHT AND THE USER HAVE A SEPARATE WRITTEN AGREEMENT WITH WARRANTY TERMS COVERING THE MATERIAL IN THIS DOCUMENT THAT CONFLICT WITH THESE TERMS, THE WARRANTY TERMS IN THE SEPARATE AGREEMENT SHALL CONTROL.

Technology Licenses

The hardware and/or software described in this document are furnished under a license and may be used or copied only in accordance with the terms of such license.

U.S. Government Rights

The Software is “commercial computer software,” as defined by Federal Acquisition Regulation (“FAR”) 2.101. Pursuant to FAR 12.212 and 27.405-3 and Department of Defense FAR Supplement (“DFARS”) 227.7202, the U.S. government acquires commercial computer software under the same terms by which the software is customarily provided to the public. Accordingly, Keysight provides the Software to U.S. government customers under its standard commercial license, which is embodied in its End User License Agreement (EULA), a copy of which can be found at <http://www.keysight.com/find/sweula>. The license set forth in the EULA represents the exclusive authority by which the U.S. government may use, modify, distribute, or disclose the Software. The EULA and the license set forth therein, does not require or permit, among other things, that Keysight: (1) Furnish technical information related to commercial computer software or commercial computer software documentation that is not customarily provided to the public; or (2) Relinquish to, or otherwise provide, the government rights in excess of these rights customarily provided to the public to use, modify, reproduce, release, perform, display, or disclose commercial computer software or commercial computer software documentation. No additional government requirements beyond those set forth in the EULA shall apply, except to the extent that those terms, rights, or licenses are explicitly required from all providers of commercial computer software pursuant to the FAR and the DFARS and are set forth specifically in writing elsewhere in the EULA. Keysight shall be under no obligation to update, revise or otherwise modify the Software. With respect to any technical data as defined by FAR 2.101, pursuant to FAR 12.211 and 27.404.2 and DFARS 227.7102, the U.S. government acquires no greater than Limited Rights as defined in FAR 27.401 or DFAR 227.7103-5 (c), as applicable in any technical data.

Third Party Licenses

Portions of this software are licensed by third parties including open source terms and conditions. For more information, please contact Keysight support, <https://www.keysight.com/find/assist>.

Waste Electrical and Electronic Equipment (WEEE)

This product complies with the WEEE Directive marking requirement. The affixed product label (see below) indicates that you must not discard this electrical/electronic product in domestic household waste.

Product category: With reference to the equipment types in the WEEE directive Annex 1, this product is classified as “Monitoring and Control instrumentation” product. Do not dispose in domestic household waste.

To return unwanted products, contact your local Keysight office, or see

about.keysight.com/en/companyinfo/environment/takeback.shtml for more information.



Declarations of Conformity

Declarations of Conformity for this product and for other Keysight products may be downloaded from the Web. Go to <https://regulations.about.keysight.com/DoC/default.htm>. You can then search by product number to find the latest Declaration of Conformity.

Safety Information

CAUTION

A CAUTION notice denotes a hazard. It calls attention to an operating procedure, practice, or the like that, if not correctly performed or adhered to, could result in damage to the product or loss of important data. Do not proceed beyond a CAUTION notice until the indicated conditions are fully understood and met.

WARNING

A WARNING notice denotes a hazard. It calls attention to an operating procedure, practice, or the like that, if not correctly performed or adhered to, could result in personal injury or death. Do not proceed beyond a WARNING notice until the indicated conditions are fully understood and met.

1 Service and Maintenance

Specifications and Characteristics

General Information

Troubleshooting

Self-Test Procedures

User Replaceable Parts

Battery Replacement

Disassembly

This chapter provides the specifications and service information on cleaning, troubleshooting, repair, and replaceable parts of the EL30000 Series. This chapter also explains how to assemble and disassemble the EL30000 Series.

Specifications and Characteristics

NOTE

For the characteristics and specifications of the EL30000 Series DC electronic load, refer to the datasheet at <https://www.keysight.com/my/en/assets/3120-1430/datasheets/EL30000-Series.pdf>.

General Information

Types of service available

If your instrument fails during the warranty period, Keysight Technologies will repair or replace it under the terms of your warranty. After your warranty expires, Keysight offers repair services at competitive prices. You also have the option to purchase a service contract that extends the coverage after the standard warranty expires.

Obtaining repair service (worldwide)

To obtain service for your instrument, contact your nearest Keysight Technologies Service Center. They will arrange to have your unit repaired or replaced, and can provide warranty or repair-cost information where applicable. Ask the Keysight Technologies Service Center for shipping instructions, including what components to ship. Keysight recommends that you retain the original shipping carton for return shipments.

Repackaging for shipment

Ensure the following to ship the unit to Keysight for service or repair:

- Attach a tag to the unit identifying the owner and indicating the required service or repair. Include the model number and full serial number.
- Place the unit in its original container with appropriate packaging material.
- Secure the container with strong tape or metal bands.
- If the original shipping container is unavailable, use a container that will ensure at least 10 cm (4 in.) of compressible packaging material around the entire instrument. Use static-free packaging materials.

Keysight suggests that you always insure your shipments.

Cleaning and handling

Cleaning

To prevent electrical shock, disconnect the instrument from AC mains power and disconnect all test leads before cleaning. Clean the outside of the instrument using a soft, lint-free, cloth slightly dampened with water.

- Do not use detergent or solvents.
- Do not attempt to clean internally.

If required, contact a Keysight Technologies Sales and Service office to arrange for proper cleaning to ensure that safety features and performance are maintained.

Electrostatic Discharge (ESD) precautions

Almost all electrical components can be damaged by electrostatic discharge (ESD) during handling. Component damage can occur at electrostatic discharge voltages as low as 50 V.

The following guidelines will help prevent ESD damage during service operations:

- Disassemble instruments only in a static-free work area.
- Use a conductive work area to reduce static charges.
- Use a conductive wrist strap to reduce static charge accumulation.
- Minimize handling.
- Keep replacement parts in original static-free packaging.
- Remove all plastic, foam, vinyl, paper, and other static-generating materials from the immediate work area.

Troubleshooting

Before troubleshooting or repairing the instrument, make sure the failure is in the instrument rather than any external connections. Also make sure that the instrument was accurately calibrated within the last year (see [Calibration Adjustment Procedures > Calibration Interval](#) for details).

Perform the following verifications if the unit is inoperative:

- Verify that the ac power cord is connected to the electronic load.
- Verify that the front-panel power switch is depressed.
- Verify the power-line voltage setting.

Self-Test Procedures

Refer to *EL30000 Series User's Guide* for details.

User Replaceable Parts

You can find the instrument support part list at Keysight's Test & Measurement Parts Catalog <http://www.keysight.com/find/parts>.

Battery Replacement

WARNING

SHOCK HAZARD

Only qualified, service-trained personnel who are aware of the hazards involved should remove instrument covers. Always disconnect the power cable and any external circuits before removing the instrument cover. Some circuits are active and have power for a short time even when the power switch is turned off.

The internal battery powers the real-time clock. The primary function of the clock is to provide a time stamp for the internal file system. If the battery fails, the clock and time stamp function will not be available. No other instrument functions are affected.

Under normal use at room temperature, the lithium battery has a life expectancy between seven and ten years. Note that battery life will be reduced if the instrument is stored for a prolonged period at temperatures above 40 degrees Celsius.

The battery type is Panasonic CR 2032.

Replacing the Battery

1. **Remove the front panel.**
2. The battery is located at the front panel PC board.
3. Use a flat-bladed screwdriver and carefully pry up on the side of the battery.



4. Install the new battery. Make sure that the positive side (+) is facing up. Place the battery under the small spring clips closest to the ribbon cable connector, then push down on the opposite end of the battery to seat the battery (see red arrow below). The top of the small spring clips should be visible after the battery is seated (see red circle below).

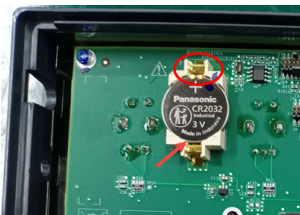

5. Replace the top cover when finished.
6. Reset the date and time.

NOTE



Properly dispose of the old battery in accordance with local laws and regulations.

Disassembly



Tools required

Items	Torque value
T20 Torx driver	21 in.lbs
Pozi M4 bit	9.0 in.lbs

Removing the front panel

Steps	Instructions	Visual
1.	Remove the side trims from the front panel.	
2.	Remove four Pozi screws from the front panel using a Pozi M4 bit.	
3.	Pull out the front panel	
4.	To install back the front panel, perform the above steps in reverse order.	

Removing/Installing the knob

Steps	Instructions	Visual
1.	Pull out the knob to remove the knob from the front panel.	
2.	To install back the knob, push the knob back in the shaft. NOTE: Make sure to follow the shaft orientation before pushing the knob.	

Installing the strap handler

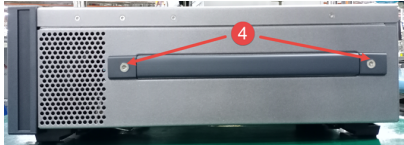
Steps	Instructions	Visual
1.	Insert the stainless steel belt into the PVC strap.	
2.	Insert the stainless steel gaskets to both side of the stainless steel belt.	
3.	Cover both side with the plastic cap.	
4.	Secure both side of the strap handle with 2 (M5*10) screws.	

Removing/Installing the GPIB module (EL34143A and EL34243A only)

Refer to the *EL30000 Series User's Guide* for details.

2 Verification and Adjustments

Performance Verification

Test Record Forms

Calibration Adjustment Procedures

This chapter contains the performance verification procedures which verify that the EL30000 Series is operating within its published specifications. This chapter also provides information on adjustments performed after a performance verification fails.

Performance Verification

Performance verification ensures that the instrument performs within the specifications stated in the data sheet (<http://literature.cdn.keysight.com/litweb/pdf/3120-1430EN.pdf>)

Recommended test equipment

The test equipments recommended for the performance verification and adjustment procedures are listed below. If the exact instrument is not available, use the accuracy requirements shown to select substitute calibration standards.

Type	Specification	Recommended model
Digital multimeter	Readout: 6 1/2 digits Basic DC Accuracy: 0.0035%	Keysight 34465A or equivalent
Current monitor	10 A (1 Ω), TC = 4 ppm/°C 100 A (0.01 Ω), TC = 4 ppm/°C	Guildline 9230A-10 Guildline 9230A-100
Power Supplies	150 V, 60 A, 350 W minimum	Keysight N7977A (160 V, 12.5 A) and Keysight N7971A (20 V, 100 A)

Test considerations

- Ensure that the calibration ambient temperature is stable at 23 °C \pm 5 °C.
- Ensure ambient relative humidity is less than 70%.
- Allow a 30 minutes warm-up period before verification or calibration.
- Keep cables as short as possible, consistent with the impedance requirements.
- Performance verification and calibration procedure can be performed either through front panel or rear panel input.

CAUTION The tests should be performed by qualified personnel. During performance verification tests, hazardous voltages may be present at the outputs of the power supply.

Measurement techniques

Voltmeter

To ensure that the values read by the voltmeter during both the verification procedure and the calibration procedure are not affected by the instantaneous measurement of the AC peaks of the output current ripple, make several DC measurements and average them.

Current-monitoring resistor

The 4-terminal current shunt is used to eliminate output current measurement error caused by voltage drops in the load leads and connections. It has special current-monitoring terminals inside the load connection terminals. Connect the voltmeter directly to these current-monitoring terminals.

Power Supply

The power supply is used to supply power for both verification and calibration procedure.

Verification Test Setup

Front panel connection

Connect all leads to the input terminals as shown in the following figure.

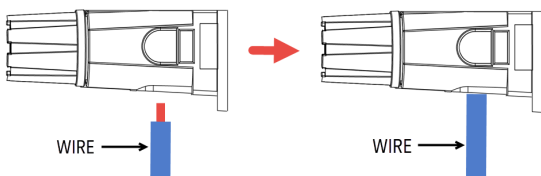

The following figures show the verification test set-ups. Connect all leads to the input terminal as shown below.

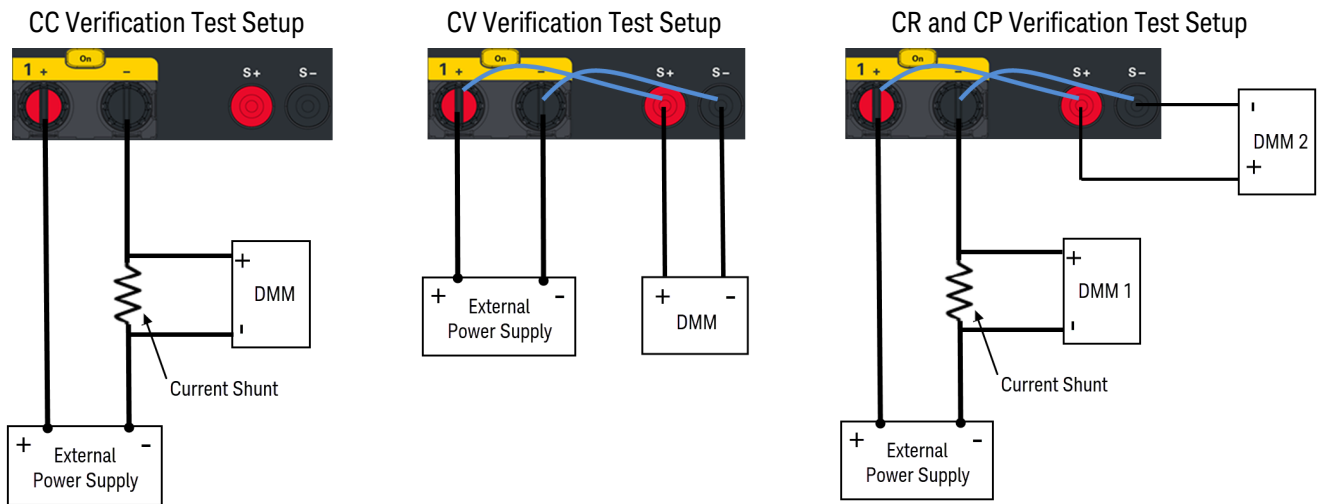

Constant Voltage (CV) verification

Voltage programming and readback accuracy

This test verifies that the voltage programming and the LAN, USB, or GPIB readback functions are within specifications. Note that the readback values over the remote interface should be identical to those displayed on the front panel, but with maximum resolution.

This test verifies that the voltage programming and measurement functions are within specifications.

High range

1. Turn off the electronic load.
2. Connect a DMM across the sense terminals and an external power supply across the input terminals (see **CV Test Setup**)
3. Turn on the electronic load and program the load settings as described in the test record form for “Voltage Programming & Readback - High range, Minimum voltage”. Turn on the power supply and program it to the power supply settings described in the test record form.
4. Turn the load input on. The load status should be “CV” and the input current should be close to power supply current.
5. Record the voltage reading from the DMM and the voltage measured over the interface. The readings should be within the limits specified in the test record form for the appropriate model under “Voltage Programming & Readback - High range, Minimum voltage”.
6. Program the load settings as described in the test record form for “Voltage Programming & Readback - High range, Maximum voltage”.
7. Record the voltage reading from the DMM and the voltage measured over the interface. The readings should be within the limits specified in the test record form for the appropriate model under “Voltage Programming & Readback - High range, Maximum voltage”.

Low range

8. Program the load settings as described in the test record form for “Voltage Programming & Readback - Low range, Minimum voltage”. Turn on the power supply and program it to the power supply settings described in the test record form.
9. Turn the load input on. The load status should be “CV” and the input current should be close to power supply current.
10. Record the voltage reading from the DMM and the voltage measured over the interface. The readings should be within the limits specified in the test record form for the appropriate model under “Voltage Programming & Readback - Low range, Minimum voltage”.
11. Program the load settings as described in the test record form for “Voltage Programming & Readback - Low range, Maximum voltage”.
12. Record the voltage reading from the DMM and the voltage measured over the interface. The readings should be within the limits specified in the test record form for the appropriate model under “Voltage Programming & Readback - Low range, Maximum voltage”.

Constant Current (CC) verification

Current programming and readback accuracy

Test category = performance, calibration

This test verifies that the current programming and measurement functions are within specifications.

High range

1. Turn off the electronic load.
2. Connect a DMM, current shunt, and an external power supply across the input terminals (see **CC Test Setup**). Connect the DMM directly across the current shunt.
3. Turn on the electronic load and program the load settings as described in the test record form for “Current Programming & Readback, High range, Minimum current”. Turn on the power supply and program it to the power supply settings described in the test record form.
4. Turn the load input on. The load status should be “CC” and the input voltage should be close to power supply current.
5. Divide the voltage drop (DMM reading) across the current shunt by the shunt resistance to convert to amps and record this value (lin). Also record the current measured over the interface. The readings should be within the limits specified in the test record form for the appropriate model under “Current Programming & Readback - High range, Minimum current”.
6. Program the load settings as described in the test record form under “Current Programming & Readback, High range, Maximum current”.
7. Divide the voltage drop (DMM reading) across the current shunt by the shunt resistance to convert to amps and record this value (lin). Also record the current reading measured over the interface. The readings should be within the limits specified in the test record form for the appropriate model under “Current Programming & Readback - High range, Maximum current”.

Medium range (EL34143A and EL34243A only)

8. Program the load settings as described in the test record form under “Current Programming & Readback - Medium range, Minimum current”.
9. Divide the voltage drop (DMM reading) across the current shunt by the shunt resistance to convert to amps and record this value (lin). Also record the current reading measured over the interface. The readings should be within the limits specified in the test record form for the appropriate model under “Current Programming & Readback, Medium range, Minimum current”.
10. Program the load settings as described in the test record form under “Current Programming & Readback - Medium range, Maximum current”.
11. Divide the voltage drop (DMM reading) across the current shunt by the shunt resistance to convert to amps and record this value (lin). Also record the current reading measured over the interface. The readings should be within the limits specified in the test record form for the appropriate model under “Current Programming & Readback, Medium range, Maximum current”.

Low range

12. Program the load settings as described in the test record form under “Current Programming & Readback - Low range, Minimum current”.
13. Divide the voltage drop (DMM reading) across the current shunt by the shunt resistance to convert to amps and record this value (lin). Also record the current reading measured over the interface. The readings should be within the limits specified in the test record form for the appropriate model under “Current Programming & Readback, Low range, Minimum current”.
14. Program the load settings as described in the test record form under “Current Programming & Readback - Low range, Maximum current”.
15. Divide the voltage drop (DMM reading) across the current shunt by the shunt resistance to convert to amps and record this value (lin). Also record the current reading measured over the interface. The readings should be within the limits specified in the test record form for the appropriate model under “Current Programming & Readback, Low range, Maximum current”.

Constant Resistance (CR) verification

Resistance programming and readback accuracy

Test category = performance

This test verifies that the resistance programming is within specification. The programmed resistance values are checked by recording the voltage across the current monitor resistor and the input voltage (voltage at the modules + and – sense terminals), then calculating the resistance as follows;

Resistance = Input Voltage / (voltage across current monitor / monitor resistor value)

The Resistance value must then be converted to Siemens by inverting the value: $S = 1/R$

1. Turn off the electronic load.
2. Connect a DMM, current shunt, and an external power supply across the input terminals (see **CR Test Setup**). Connect the DMM directly across the current shunt. Connect "DMM 2" across the sense terminals.
3. Turn on the electronic load.

Ultra-High range (EL34143A and EL34243A only)

4. Program the load settings as described in the test record form for “Resistance Programming - Ultra-High range, Minimum resistance”. Turn on the power supply and program it to the power supply settings described in the test record form.
5. Turn the load input on. The load status should be “CR”.
6. Divide the voltage drop (DMM reading) across the current shunt by the shunt resistance to convert to amps and record this value (lin).
7. Calculate the resistance value as follows: $R = V_{in}/I_{in}$. V_{in} is the voltage measured by the second DMM. Convert the input resistance (R) to Siemens by inverting the value: $S = 1/R$. The value in Siemens should not exceed value listed in the test record under “Resistance Programming - Ultra-High range, Minimum resistance”.
8. Program the load settings as described in the test record form under “Resistance Programming - Ultra-High range, Maximum resistance”. Program the power supply to the power supply settings described in the test record form.
9. Divide the voltage drop (DMM reading) across the current shunt by the shunt resistance to convert to amps and record this value (lin).
10. Calculate the resistance value as follows: $R = V_{in}/I_{in}$. V_{in} is the voltage measured by the second DMM. Convert the input resistance (R) to Siemens by inverting the value: $S = 1/R$. The value in Siemens should not exceed value listed in the test record under “Resistance Programming - Ultra-High range, Maximum resistance”.

High range

11. Program the load settings as described in the test record form for “Resistance Programming - High range, Minimum resistance”. Turn on the power supply and program it to the power supply settings described in the test record form.
12. Turn the load input on. The load status should be “CR”.

13. Divide the voltage drop (DMM reading) across the current shunt by the shunt resistance to convert to amps and record this value (lin).
14. Calculate the resistance value as follows: $R = V_{in}/I_{in}$. V_{in} is the voltage measured by the second DMM. Convert the input resistance (R) to Siemens by inverting the value: $S = 1/R$. The value in Siemens should not exceed value listed in the test record under “Resistance Programming - High range, Minimum resistance”.
15. Program the load settings as described in the test record form under “Resistance Programming - High range, Maximum resistance”. Program the power supply to the power supply settings described in the test record form.
16. Divide the voltage drop (DMM reading) across the current shunt by the shunt resistance to convert to amps and record this value (lin).
17. Calculate the resistance value as follows: $R = V_{in}/I_{in}$. V_{in} is the voltage measured by the second DMM. Convert the input resistance (R) to Siemens by inverting the value: $S = 1/R$. The value in Siemens should not exceed value listed in the test record under “Resistance Programming - High range, Maximum resistance”.

Medium range

18. Program the load settings as described in the test record form for “Resistance Programming - Medium range, Minimum resistance”. Program the power supply to the power supply settings described in the test record form.
19. Divide the voltage drop (DMM reading) across the current shunt by the shunt resistance to convert to amps and record this value (lin).
20. Calculate the resistance value as follows: $R = V_{in}/I_{in}$. V_{in} is the voltage measured by the second DMM. Convert the input resistance (R) to Siemens by inverting the value: $S = 1/R$. The value in Siemens should not exceed value listed in the test record under “Resistance Programming - Medium range, Minimum resistance”.
21. Program the load settings as described in the test record form under “Resistance Programming - Medium range, Maximum resistance”. Program the power supply to the power supply settings described in the test record form.
22. Divide the voltage drop (DMM reading) across the current shunt by the shunt resistance to convert to amps and record this value (lin).
23. Calculate the resistance value as follows: $R = V_{in}/I_{in}$. V_{in} is the voltage measured by the second DMM. Convert the input resistance (R) to Siemens by inverting the value: $S = 1/R$. The value in Siemens should not exceed value listed in the test record under “Resistance Programming - Medium range, Maximum resistance”.

Low range

24. Program the load settings as described in the test record form for “Resistance Programming - Low range, Minimum resistance”. Program the power supply to the power supply settings described in the test record form.
25. Divide the voltage drop (DMM reading) across the current shunt by the shunt resistance to convert to amps and record this value (lin).
26. Calculate the resistance value as follows: $R = V_{in}/I_{in}$. V_{in} is the voltage measured by the second DMM. Convert the input resistance (R) to Siemens by inverting the value: $S = 1/R$. The value in Siemens should not exceed value listed in the test record under “Resistance Programming - Low range, Minimum resistance”.
27. Program the load settings as described in the test record form under “Resistance Programming - Low range, Maximum resistance”. Program the power supply to the power supply settings described in the test record form.

28. Divide the voltage drop (DMM reading) across the current shunt by the shunt resistance to convert to amps and record this value (I_{in}).
29. Calculate the resistance value as follows: $R = V_{in}/I_{in}$. V_{in} is the voltage measured by the second DMM. Convert the input resistance (R) to Siemens by inverting the value: $S = 1/R$. The value in Siemens should not exceed value listed in the test record under "Resistance Programming - Low range, Maximum resistance".

Constant Power (CP) verification

Power programming and readback accuracy

Test category = performance

This test verifies that the power programming and measurement functions are within specifications.

High range

1. Turn off the electronic load.
2. Connect a DMM, current shunt, and an external power supply across the input terminals (see **CP Test Setup**). Connect the DMM directly across the current shunt. Connect "DMM 2" across the sense terminals.
3. Turn on the electronic load and program the load settings as described in the test record form for "Power Programming - High range, Minimum power". Turn on the power supply and program it to the power supply settings described in the test record form.
4. Turn the load input on. The load status should be "CP".
5. Divide the voltage drop (DMM reading) across the current shunt by the shunt resistance to convert to amps and record this value (I_{in}). Also record the current measured over the interface.
6. Calculate the power as follows: $P = I_{in} \times V_{in}$. V_{in} is the voltage measured by the second DMM. The readings should be within the limits specified in the test record form for the appropriate model under "Power Programming & Readback - High range, Minimum power".
7. Program the load settings as described in the test record form under "Power Programming - High range, Maximum power". Program the power supply to the power supply settings described in the test record form.
8. Divide the voltage drop (DMM reading) across the current shunt by the shunt resistance to convert to amps and record this value (I_{in}). Also record the current measured over the interface.
9. Calculate the power as follows: $P = I_{in} \times V_{in}$. V_{in} is the voltage measured by the second DMM. The readings should be within the limits specified in the test record form for the appropriate model under "Power Programming & Readback - High range, Maximum power".

Medium range

10. Program the load settings as described in the test record form for "Power Programming - Medium range, Minimum power". Program the power supply to the power supply settings described in the test record form.
11. Divide the voltage drop (DMM reading) across the current shunt by the shunt resistance to convert to amps and record this value (I_{in}). Also record the current measured over the interface.
12. Calculate the power as follows: $P = I_{in} \times V_{in}$. V_{in} is the voltage measured by the second DMM. The readings should be within the limits specified in the test record form for the appropriate model under "Power Programming & Readback - Medium range, Minimum power".
13. Program the load settings as described in the test record form for "Power Programming - Medium range, Maximum power". Program the power supply to the power supply settings described in the test record form.
14. Divide the voltage drop (DMM reading) across the current shunt by the shunt resistance to convert to amps and record this value (I_{in}). Also record the current measured over the interface.

15. Calculate the power as follows: $P = I_{in} \times V_{in}$. V_{in} is the voltage measured by the second DMM. The readings should be within the limits specified in the test record form for the appropriate model under “Power Programming & Readback - Medium range, Maximum power”.

Low range

16. Program the load settings as described in the test record form for “Power Programming - Low range, Minimum power”. Program the power supply to the power supply settings described in the test record form.
17. Divide the voltage drop (DMM reading) across the current shunt by the shunt resistance to convert to amps and record this value (I_{in}). Also record the current measured over the interface.
18. Calculate the power as follows: $P = I_{in} \times V_{in}$. V_{in} is the voltage measured by the second DMM. The readings should be within the limits specified in the test record form for the appropriate model under “Power Programming & Readback - Low range, Minimum power”.
19. Program the load settings as described in the test record form for “Power Programming - Low range, Maximum power”. Program the power supply to the power supply settings described in the test record form.
20. Divide the voltage drop (DMM reading) across the current shunt by the shunt resistance to convert to amps and record this value (I_{in}). Also record the current measured over the interface.
21. Calculate the power as follows: $P = I_{in} \times V_{in}$. V_{in} is the voltage measured by the second DMM. The readings should be within the limits specified in the test record form for the appropriate model under “Power Programming & Readback - Low range, Maximum power”.

Test Record Forms

Test record form - Keysight EL33133A

Test record form - Keysight EL34143A

Test record form - Keysight EL34243A

Test record form - Keysight EL33133A

Keysight EL33133A		Record Number: _____	Date: _____
Description	Lower Limits	Results	Upper Limits
Constant Voltage (CV) Tests			
Voltage Programming & Readback - High range			
Minimum voltage:	1.48455 V	_____	1.51545 V
Voltage measured over interface:	$V_{in} - 15.45$ V	_____	$V_{in} + 15.45$ V
Maximum voltage:	149.94 V	_____	150.06 V
Voltage measured over interface:	$V_{in} - 60$ mV	_____	$V_{in} + 60$ mV
Voltage Programming & Readback - Low range			
Minimum voltage:	0.145755 V	_____	0.154245 V
Voltage measured over interface:	$V_{in} - 4.245$ mV	_____	$V_{in} + 4.245$ mV
Maximum voltage:	14.9913 V	_____	15.0087 V
Voltage measured over interface:	$V_{in} - 8.7$ mV	_____	$V_{in} + 8.7$ mV
Constant Current (CC) Tests			
Current Programming & Readback - High range			
Minimum current:	0.49255 A	_____	0.50745 A
Current measured over interface:	$I_{in} - 7.45$ mA	_____	$I_{in} + 7.45$ mA
Maximum current:	39.9728 A	_____	40.0272 A
Current measured over interface:	$I_{in} - 27.2$ mA	_____	$I_{in} + 27.2$ mA
Current Programming & Readback - Low range			
Minimum current:	0.049155 A	_____	0.050845 A
Current measured over interface:	$I_{in} - 0.845$ mA	_____	$I_{in} + 0.845$ mA
Maximum current:	3.99718 A	_____	4.00282 A
Current measured over interface:	$I_{in} - 2.82$ mA	_____	$I_{in} + 2.82$ mA
Constant Resistance (CR) Tests			
Resistance Programming - High range			
Minimum resistance:	8.19 mS	_____	11.81 mS
Maximum resistance:	0 S	_____	2.05025 mS
Resistance Programming - Medium range			
Minimum resistance:	83.9 mS	_____	116.1 mS
Maximum resistance:	0 S	_____	16.8008 mS
Resistance Programming - Low range			
Minimum resistance:	19.82 S	_____	20.18 S
Maximum resistance:	0 S	_____	0.193367 S

To be continued on next page...

Keysight EL33133A		Record Number: _____	Date: _____
Description	Lower Limits	Results	Upper Limits
Constant Power (CP) Tests			
Power Programming & Readback - High range			
Minimum power:	0 W	_____	3.0012 W
Power measured over interface:	$P_{in} - 1.2012 \text{ W}$	_____	$P_{in} + 1.2012 \text{ W}$
Maximum power:	248.3 W	_____	251.7 W
Power measured over interface:	$P_{in} - 1.4 \text{ W}$	_____	$P_{in} + 1.4 \text{ W}$
Power Programming & Readback - Medium range			
Minimum power:	0 mW	_____	300.12 mW
Power measured over interface:	$P_{in} - 150.12 \text{ mW}$	_____	$P_{in} + 150.12 \text{ mW}$
Maximum power:	24.83 W	_____	25.17 W
Power measured over interface:	$P_{in} - 170 \text{ mW}$	_____	$P_{in} + 170 \text{ mW}$
Power Programming & Readback - Low range			
Minimum power:	1.984 mW	_____	38.016 mW
Power measured over interface:	$P_{in} - 18.016 \text{ mW}$	_____	$P_{in} + 18.016 \text{ mW}$
Maximum power:	4.978 W	_____	5.022 W
Power measured over interface:	$P_{in} - 22 \text{ mW}$	_____	$P_{in} + 22 \text{ mW}$

Test Description	EL33133A Settings	Power Supply Settings
Voltage Programming & Readback - High Range, Minimum voltage:	CV mode; 1.5 V; 4W sense	5 V; 0.667 A
Voltage Programming & Readback - High Range, Maximum voltage:	CV mode; 150 V; 4W sense	160 V; 1.667 A
Voltage Programming & Readback - Low Range, Minimum voltage:	CV mode; 0.15 V; 4W sense	7 V; 6.667 A
Voltage Programming & Readback - Low Range, Maximum voltage:	CV mode; 15 V; 4W sense	20 V; 16.667 A
Current Programming & Readback - High Range, Minimum current:	CC mode; 0.5 A	2 V; 1 A
Current Programming & Readback - High Range, Maximum current:	CC mode; 40 A	6.25 V; 50 A
Current Programming & Readback - Low Range, Minimum current:	CC mode; 0.05 A	20 V; 1 A
Current Programming & Readback - Low Range, Maximum current:	CC mode; 4 A	62.5 V; 5 A
Resistance Programming - High range, Minimum resistance:	CR mode; 100 Ω ; 4W sense	150 V; 2 A
Resistance Programming - High range, Maximum resistance:	CR mode; 4000 Ω ; 4W sense	150 V; 1 A
Resistance Programming - Medium range, Minimum resistance:	CR mode; 10 Ω ; 4W sense	50 V; 8 A
Resistance Programming - Medium range, Maximum resistance:	CR mode; 1250 Ω ; 4W sense	150 V; 1 A
Resistance Programming - Low range, Minimum resistance:	CR mode; 0.05 Ω ; 4W sense	2 V; 45 A
Resistance Programming - Low range, Maximum resistance:	CR mode; 30 Ω ; 4W sense	15 V; 1 A
Power Programming & Readback - High Range, Minimum power:	CP mode; 1.5 W; 4W sense	3 V; 1 A
Power Programming & Readback - High Range, Maximum power:	CP mode; 250 W; 4W sense	150 V; 2 A
Power Programming & Readback - Medium Range, Minimum power:	CP mode; 0.15 W; 4W sense	2.5 V; 1 A
Power Programming & Readback - Medium Range, Maximum power:	CP mode; 25 W; 4W sense	150 V; 1 A
Power Programming & Readback - Low Range, Minimum power:	CP mode; 0.02 W; 4W sense	1.25 V; 0.5 A
Power Programming & Readback - Low Range, Maximum power:	CP mode; 5 W; 4W sense	5 V; 1.5 A

Test record form – Keysight EL34143A

Keysight EL34143A		Record Number: _____	Date: _____
Description	Lower Limits	Results	Upper Limits
Constant Voltage (CV) Tests			
Voltage Programming & Readback - High range			
Minimum voltage:	1.4847 V	_____	1.5153 V
Voltage measured over interface:	$V_{in} - 15.3 \text{ mV}$	_____	$V_{in} + 15.3 \text{ mV}$
Maximum voltage:	149.955 V	_____	150.045 V
Voltage measured over interface:	$V_{in} - 45 \text{ mV}$	_____	$V_{in} + 45 \text{ mV}$
Voltage Programming & Readback - Low range			
Minimum voltage:	0.14697 V	_____	0.15303 V
Voltage measured over interface:	$V_{in} - 3.03 \text{ mV}$	_____	$V_{in} + 3.03 \text{ mV}$
Maximum voltage:	14.994 V	_____	15.006 V
Voltage measured over interface:	$V_{in} - 6 \text{ mV}$	_____	$V_{in} + 6 \text{ mV}$
Constant Current (CC) Tests			
Current Programming & Readback - High range			
Minimum current:	0.4878 A	_____	0.5122 A
Current measured over interface:	$I_{in} - 9.8 \text{ mA}$	_____	$I_{in} + 9.8 \text{ mA}$
Maximum current:	59.964 A	_____	60.036 A
Current measured over interface:	$I_{in} - 33.6 \text{ mA}$	_____	$I_{in} + 33.6 \text{ mA}$
Current Programming & Readback - Medium range			
Minimum current:	0.09796 A	_____	0.10204 A
Current measured over interface:	$I_{in} - 1.84 \text{ mA}$	_____	$I_{in} + 1.84 \text{ mA}$
Maximum current:	5.9956 A	_____	6.0044 A
Current measured over interface:	$I_{in} - 4.2 \text{ mA}$	_____	$I_{in} + 4.2 \text{ mA}$
Current Programming & Readback - Low range			
Minimum current:	0.04985 A	_____	0.05015 A
Current measured over interface:	$I_{in} - 0.14 \text{ mA}$	_____	$I_{in} + 0.14 \text{ mA}$
Maximum current:	0.59963 A	_____	0.60037 A
Current measured over interface:	$I_{in} - 0.36 \text{ mA}$	_____	$I_{in} + 0.36 \text{ mA}$
Constant Resistance (CR) Tests			
Resistance Programming - Ultra-High range			
Minimum resistance:	3.596 mS	_____	4.404 mS
Maximum resistance:	0 S	_____	410.01 μ S
Resistance Programming - High range			
Minimum resistance:	6.49 mS	_____	13.51 mS
Maximum resistance:	0 S	_____	3.75 mS
Resistance Programming - Medium range			
Minimum resistance:	81.9 mS	_____	118.1 mS
Maximum resistance:	0 S	_____	18.801 mS
Resistance Programming - Low range			
Minimum resistance:	19.75 S	_____	20.25 S
Maximum resistance:	0 S	_____	0.263367 S

To be continued on next page...

Keysight EL34143A		Record Number: _____	Date: _____
Description	Lower Limits	Results	Upper Limits
Constant Power (CP) Tests			
Power Programming & Readback - High range			
Minimum power:	0.3988 W	_____	3.6012 W
Power measured over interface:	$P_{in} - 1.5012 W$	_____	$P_{in} + 1.5012 W$
Maximum power:	348.19 W	_____	351.81 W
Power measured over interface:	$P_{in} - 1.71 W$	_____	$P_{in} + 1.71 W$
Power Programming & Readback - Medium range			
Minimum power:	0.03982 W	_____	0.56018 W
Power measured over interface:	$P_{in} - 260.18 mW$	_____	$P_{in} + 260.18 mW$
Maximum power:	34.719 W	_____	35.281 W
Power measured over interface:	$P_{in} - 281 mW$	_____	$P_{in} + 281 mW$
Power Programming & Readback - Low range			
Minimum power:	15.988 mW	_____	24.012 mW
Power measured over interface:	$P_{in} - 3.012 mW$	_____	$P_{in} + 3.012 mW$
Maximum power:	7.9912 W	_____	8.0088 W
Power measured over interface:	$P_{in} - 7.8 mW$	_____	$P_{in} + 7.8 mW$

Test Description	EL34143A Settings	Power Supply Settings
Voltage Programming & Readback - High Range, Minimum voltage:	CV mode; 1.5 V; 4W sense	5 V; 0.667 A
Voltage Programming & Readback - High Range, Maximum voltage:	CV mode; 150 V; 4W sense	160 V; 2.333 A
Voltage Programming & Readback - Low Range, Minimum voltage:	CV mode; 0.15 V; 4W sense	7 V; 6.667 A
Voltage Programming & Readback - Low Range, Maximum voltage:	CV mode; 15 V; 4W sense	20 V; 23.333 A
Current Programming & Readback - High Range, Minimum current:	CC mode; 0.5 A	2 V; 1 A
Current Programming & Readback - High Range, Maximum current:	CC mode; 60 A	5.833 V; 65 A
Current Programming & Readback - Medium Range, Minimum current:	CC mode; 0.1 A	10 V; 1 A
Current Programming & Readback - Medium Range, Maximum current:	CC mode; 6 A	58.333 V; 10 A
Current Programming & Readback - Low Range, Minimum current:	CC mode; 0.05 A	2 V; 1 A
Current Programming & Readback - Low Range, Maximum current:	CC mode; 0.6 A	58.333 V; 1 A
Resistance Programming - Ultra-High range, Minimum resistance:	CR mode; 250 Ω ; 4W sense	90 V; 1 A
Resistance Programming - Ultra-High range, Maximum resistance:	CR mode; 100000 Ω ; 4W sense	150 V; 1 A
Resistance Programming - High range, Minimum resistance:	CR mode; 100 Ω ; 4W sense	150 V; 2 A
Resistance Programming - High range, Maximum resistance:	CR mode; 4000 Ω ; 4W sense	150 V; 1 A
Resistance Programming - Medium range, Minimum resistance:	CR mode; 10 Ω ; 4W sense	50 V; 8 A
Resistance Programming - Medium range, Maximum resistance:	CR mode; 1250 Ω ; 4W sense	150 V; 1 A
Resistance Programming - Low range, Minimum resistance:	CR mode; 0.05 Ω ; 4W sense	3 V; 65 A
Resistance Programming - Low range, Maximum resistance:	CR mode; 30 Ω ; 4W sense	15 V; 1 A
Power Programming & Readback - High Range, Minimum power:	CP mode; 2 W; 4W sense	7.5 V; 1 A
Power Programming & Readback - High Range, Maximum power:	CP mode; 350 W; 4W sense	150 V; 2.5 A
Power Programming & Readback - Medium Range, Minimum power:	CP mode; 0.3 W; 4W sense	7.5 V; 0.5 A
Power Programming & Readback - Medium Range, Maximum power:	CP mode; 35 W; 4W sense	30 V; 2 A
Power Programming & Readback - Low Range, Minimum power:	CP mode; 0.02 W; 4W sense	1.5 V; 0.1 A
Power Programming & Readback - Low Range, Maximum power:	CP mode; 8 W; 4W sense	15 V; 1 A

Test record form – Keysight EL34243A

Keysight EL34243A		Record Number: _____	Date: _____
Description	Lower Limits	Results	Upper Limits
Constant Voltage (CV) Tests			
Voltage Programming & Readback - High range			
Minimum voltage:	1.4847 V	_____	1.5153 V
Voltage measured over interface:	$V_{in} - 15.3 \text{ mV}$	_____	$V_{in} + 15.3 \text{ mV}$
Maximum voltage:	149.955 V	_____	150.045 V
Voltage measured over interface:	$V_{in} - 45 \text{ mV}$	_____	$V_{in} + 45 \text{ mV}$
Voltage Programming & Readback - Low range			
Minimum voltage:	0.14697 V	_____	0.15303 V
Voltage measured over interface:	$V_{in} - 3.03 \text{ mV}$	_____	$V_{in} + 3.03 \text{ mV}$
Maximum voltage:	14.994 V	_____	15.006 V
Voltage measured over interface:	$V_{in} - 6 \text{ mV}$	_____	$V_{in} + 6 \text{ mV}$
Constant Current (CC) Tests			
Current Programming & Readback - High range			
Minimum current:	0.4878 A	_____	0.5122 A
Current measured over interface:	$I_{in} - 9.8 \text{ mA}$	_____	$I_{in} + 9.8 \text{ mA}$
Maximum current:	59.964 A	_____	60.036 A
Current measured over interface:	$I_{in} - 33.6 \text{ mA}$	_____	$I_{in} + 33.6 \text{ mA}$
Current Programming & Readback - Medium range			
Minimum current:	0.09796 A	_____	0.10204 A
Current measured over interface:	$I_{in} - 1.84 \text{ mA}$	_____	$I_{in} + 1.84 \text{ mA}$
Maximum current:	5.9956 A	_____	6.0044 A
Current measured over interface:	$I_{in} - 4.2 \text{ mA}$	_____	$I_{in} + 4.2 \text{ mA}$
Current Programming & Readback - Low range			
Minimum current:	0.04985 A	_____	0.05015 A
Current measured over interface:	$I_{in} - 0.14 \text{ mA}$	_____	$I_{in} + 0.14 \text{ mA}$
Maximum current:	0.59963 A	_____	0.60037 A
Current measured over interface:	$I_{in} - 0.36 \text{ mA}$	_____	$I_{in} + 0.36 \text{ mA}$
Constant Resistance (CR) Tests			
Resistance Programming - Ultra-High range			
Minimum resistance:	3.596 mS	_____	4.404 mS
Maximum resistance:	0 S	_____	410.01 μ S
Resistance Programming - High range			
Minimum resistance:	6.49 mS	_____	13.51 mS
Maximum resistance:	0 S	_____	3.75 mS
Resistance Programming - Medium range			
Minimum resistance:	81.9 mS	_____	118.1 mS
Maximum resistance:	0 S	_____	18.801 mS
Resistance Programming - Low range			
Minimum resistance:	19.75 S	_____	20.25 S
Maximum resistance:	0 S	_____	0.263367 S

To be continued on next page...

Keysight EL34243A		Record Number: _____	Date: _____
Description	Lower Limits	Results	Upper Limits
Constant Power (CP) Tests			
Power Programming & Readback - High range			
Minimum power:	0.3988 W	_____	3.6012 W
Power measured over interface:	$P_{in} - 1.5012 W$	_____	$P_{in} + 1.5012 W$
Maximum power:	298.22 W	_____	301.78 W
Power measured over interface:	$P_{in} - 1.68W$	_____	$P_{in} + 1.68W$
Power Programming & Readback - Medium range			
Minimum power:	39.82 mW	_____	560.18 mW
Power measured over interface:	$P_{in} - 260.18 mW$	_____	$P_{in} + 260.18 mW$
Maximum power:	29.722 W	_____	30.278 W
Power measured over interface:	$P_{in} - 278 mW$	_____	$P_{in} + 278 mW$
Power Programming & Readback - Low range			
Minimum power:	15.988 mW	_____	24.012 mW
Power measured over interface:	$P_{in} - 3.012 mW$	_____	$P_{in} + 3.012 mW$
Maximum power:	6.9918 W	_____	7.0082 W
Power measured over interface:	$P_{in} - 7.2 mW$	_____	$P_{in} + 7.2 mW$

Test Description	EL34243A Settings	Power Supply Settings
Voltage Programming & Readback - High Range, Minimum voltage:	CV mode; 1.5 V; 4W sense	5 V; 0.667 A
Voltage Programming & Readback - High Range, Maximum voltage:	CV mode; 150 V; 4W sense	160 V; 2 A
Voltage Programming & Readback - Low Range, Minimum voltage:	CV mode; 0.15 V; 4W sense	1 V; 6.667 A
Voltage Programming & Readback - Low Range, Maximum voltage:	CV mode; 15 V; 4W sense	20 V; 20 A
Current Programming & Readback - High Range, Minimum current:	CC mode; 0.5 A	2 V; 1 A
Current Programming & Readback - High Range, Maximum current:	CC mode; 60 A	5 V; 65 A
Current Programming & Readback - Medium Range, Minimum current:	CC mode; 0.1 A	10 V; 1 A
Current Programming & Readback - Medium Range, Maximum current:	CC mode; 6 A	50 V; 10 A
Current Programming & Readback - Low Range, Minimum current:	CC mode; 0.05 A	20 V; 1 A
Current Programming & Readback - Low Range, Maximum current:	CC mode; 0.6 A	50 V; 1 A
Resistance Programming - Ultra-High range, Minimum resistance:	CR mode; 250 Ω ; 4W sense	85 V; 1 A
Resistance Programming - Ultra-High range, Maximum resistance:	CR mode; 100000 Ω ; 4W sense	150 V; 1 A
Resistance Programming - High range, Minimum resistance:	CR mode; 100 Ω ; 4W sense	150 V; 2 A
Resistance Programming - High range, Maximum resistance:	CR mode; 4000 Ω ; 4W sense	150 V; 1 A
Resistance Programming - Medium range, Minimum resistance:	CR mode; 10 Ω ; 4W sense	50 V; 8 A
Resistance Programming - Medium range, Maximum resistance:	CR mode; 1250 Ω ; 4W sense	150 V; 1 A
Resistance Programming - Low range, Minimum resistance:	CR mode; 0.05 Ω ; 4W sense	3 V; 65 A
Resistance Programming - Low range, Maximum resistance:	CR mode; 30 Ω ; 4W sense	15 V; 1 A
Power Programming & Readback - High Range, Minimum power:	CP mode; 2 W; 4W sense	15 V; 1 A
Power Programming & Readback - High Range, Maximum power:	CP mode; 300 W; 4W sense	30 V; 12 A
Power Programming & Readback - Medium Range, Minimum power:	CP mode; 0.3 W; 4W sense	7.5 V; 0.5 A
Power Programming & Readback - Medium Range, Maximum power:	CP mode; 30 W; 4W sense	150 V; 1 A
Power Programming & Readback - Low Range, Minimum power:	CP mode; 0.02 W; 4W sense	0.25 V; 0.5 A
Power Programming & Readback - Low Range, Maximum power:	CP mode; 7 W; 4W sense	12 V; 1 A

Calibration Adjustment Procedures

This chapter includes calibration adjustment procedures for Keysight EL30000 Series Electronic Load. Instructions are applicable for performing the procedures from either the front panel or a controller over the LAN, USB, or GPIB.

NOTE

Perform the verification tests before calibrating your instrument. If the instrument passes the verification tests, the unit is operating within its calibration limits and does not need to be re-calibrated.

Closed-case electronic calibration

The instrument uses closed-case electronic calibration; no internal mechanical adjustments are required. The instrument calculates correction factors based on reference signals that you apply and stores the correction factors in non-volatile memory. This data is not changed by cycling power, *RST, or SYSTem:PRESet.

Calibration interval

The recommended calibration interval for Keysight EL30000 series electronic load is one year.

Calibration adjustment process

The following general procedure is recommended to complete a full calibration adjustment.

1. Adhere to the test considerations. See [Performance Verification > Test considerations](#) for details.
2. Perform the performance verification tests to characterize the instrument. See [Performance Verification](#) for details.
3. Unsecure the instrument for calibration. See [Calibration security](#) for details.
4. Perform the calibration procedures. See [Calibration procedure](#) for details.
5. Secure the instrument against the calibration. See [Calibration security](#) for details.
6. Take note of the security code and calibration count in the instrument's maintenance records.
7. Perform the performance verification tests to verify the calibration.

Calibration security

The instrument has a calibration passcode to prevent accidental or unauthorized calibration. When you receive your power supply, it is secured by a default passcode. The default passcode is 0. The security code cannot be changed by a power cycle or *RST.

You can enter a passcode of up to 9 digits.

You can change the passcode from both front panel and remote interface.

From the front panel:

1. Press **Utilities** > **Test / Setup** > **Calibration** > **Change Passcode**
2. Enter your desired passcode and press **Done**.

From the remote interface:

To change a new passcode to 12345:

CAL:SEC:CODE 12345

NOTE

To change a forgotten passcode to a new passcode, you can turn on the instrument after shorting CAL SECURE jumper J10 on the front panel board as shown below and send CAL:SEC:CODE <code> to change the passcode.

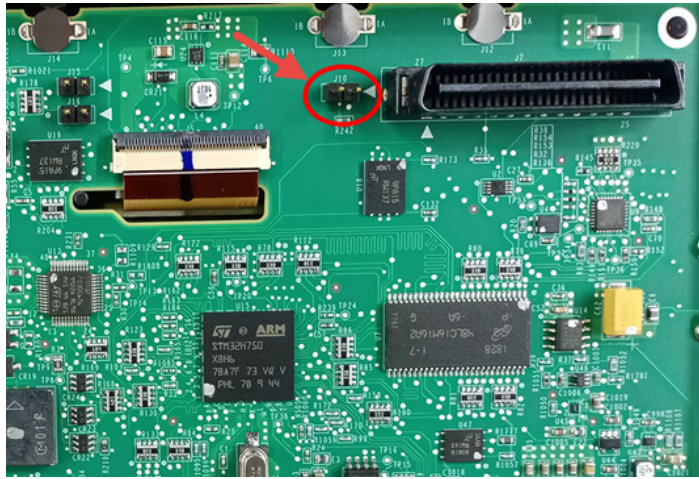

Calibration count

The instrument counts the number of times it has saved calibration data. Your instrument was calibrated at the factory; when you receive your instrument, read and record the initial count. You can only read the calibration count by sending the CAL:COUNT? query, and the calibration count is not change by a power cycle or *RST.

If Auto Save is enabled, the count increments when you exit the calibration state. To avoid double counting, do not manually save the count with Auto Save enabled.

Calibration message

You can use the CALibration:STRing command to store a message of up to 40 characters in calibration memory. For example, you could store the last calibration date, the calibration due date, or contact information for the person responsible for calibration. The calibration message is not affected by a power cycle or *RST.

You can only store the calibration message when the instrument is unsecured, but you can execute the CALibration:STRing? query regardless of whether the instrument is secured. A new calibration message overwrites the previous message, and messages over 40 characters are truncated.

Saving calibration data

You must always save new calibration data before cycling instrument power or leaving the calibration state with the Auto Save feature off. To save calibration data, send CAL:SAVE or save the calibration data from the front panel.

Calibration auto save

The instrument includes a calibration Auto Save feature. This feature automatically saves the calibration data to non-volatile memory and increments the calibration count when you exit the calibration state.

To enable or disable the CAL auto Save feature, send CAL:ASAV ON or CAL:ASAV OFF. To query the CAL auto Save state, send CAL:ASAV?

Calibration Test Setup

Front panel connection

Connect all leads to the output terminals as shown in the following figure.

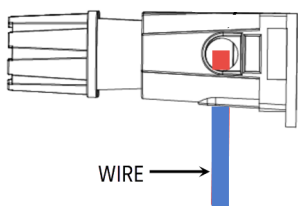

The following figures show the calibration test set-ups. Connect all leads to the input terminal as shown below.

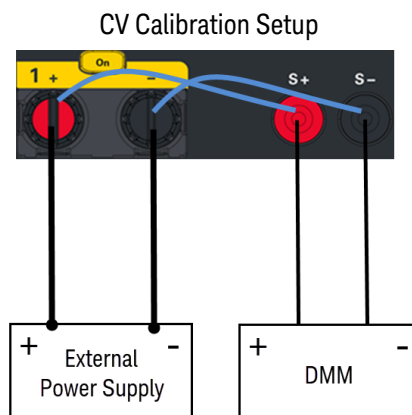
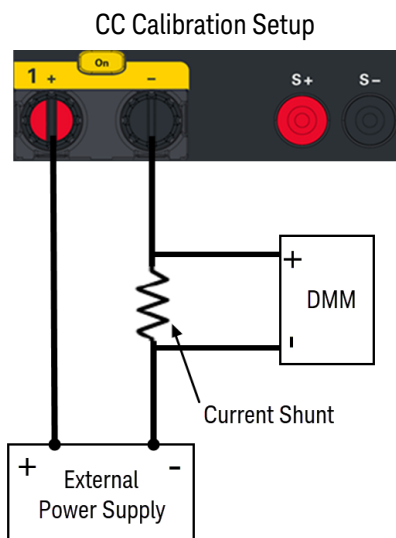

Calibration procedure

Enter the calibration state

To begin the calibration procedure, you must enter the calibration state.

Step	Front Panel	SCPI
1	Press Utilities > Test / Setup > Calibration . Enter the default passcode (default passcode is 0). Press Login to enter the calibration page.	CAL:SEC:STAT 0, <code>
2	To change a forgotten passcode to a new passcode, you can turn on the instrument after shorting CAL SECURE jumper J10 on the front panel board and send scpi command to change the passcode.	CAL:SEC:CODE <code>

Calibrate voltage

High range

Let the unit sit with input ON for one minute before performing calibration.

Connect an external power supply to the load input terminals. Set the power supply to 150 V with a current limit of 1 A. Connect a DMM capable of handling 150 V in parallel with the unit's input (see **CV Cal Setup**). Turn on the output of the power supply.

Step	Front Panel	SCPI
1	Press Perform Calibration and select the input for calibration. Press Cal Volt . Select High range and press Next .	CAL:VOLT:LEV MIN, (@chanlist)
2	Measure the input voltage (low point) with the DMM. Note: Wait 3 minutes for the voltage to stabilize before measuring the voltage with DMM.	
3	Enter the measured value, and press Next .	CAL:VOLT <reading>, (@<channel>)
4	Measure the input voltage (high point) with the DMM. Note: Wait 3 minutes for the voltage to stabilize before measuring the voltage with DMM.	
5	Enter the measured value, and press Next .	CAL:VOLT <reading>, (@<channel>)
6	Read DONE or FAIL on the display.	(wait 30 seconds) SYST:ERR?
7	Press Cal Save .	CAL:SAVE

Low range

Let the unit sit with input ON for one minute before continuing.

Set the power supply to 15 V with a current limit of 1 A. Turn on the output of the power supply.

Step	Front Panel	SCPI
1	Press Perform Calibration and select the input for calibration. Press Cal Volt . Select Low range and press Next .	CAL:VOLT:LOW LEV MIN, (@chanlist)
2	Measure the input voltage (low point) with the DMM. Note: Wait 2 minutes for the voltage to stabilize before measuring the voltage with DMM.	
3	Enter the measured value, and press Next .	CAL:VOLT:LOW <reading>, (@<channel>)
4	Measure the input voltage (high point) with the DMM. Note: Wait 3 minutes for the voltage to stabilize before measuring the voltage with DMM.	CAL:VOLT:LOW:LEV MAX, (@chanlist)
5	Enter the measured value, and press Next .	CAL:VOLT:LOW <reading>, (@<channel>)
6	Read DONE or FAIL on the display.	(wait 30 seconds) SYST:ERR?
7	Press Cal Save .	CAL:SAVE

Calibrate current

High range

Let the unit sit with input ON for one minute.

Connect an external power supply to the load's input terminals with below configuration:

- EL33133A: Set power supply to 3 V with a current limit of 40 A.
- EL34143A/EL34243A: Set power supply to 3 V with a current limit of 60 A.

Connect a current shunt resistor in series with the unit's input and a DMM to measure the voltage across the shunt (see **CC Cal Setup**). Turn on the input of the power supply.

Step	Front Panel	SCPI
1	Press Perform Calibration and select the input for calibration. Press Cal Curr . Select High range and press Next .	CAL:CURR:LEV POINT1, (@<channel>)
2	Measure the input current (POINT 1) with the DMM. Note: Wait 5 minutes for the current to stabilize before measuring the voltage drop at the shunt resistor and calculate the shunt current ($I=V/R$).	
3	Enter the calculated data, and press Next .	CAL:CURR <reading>, (@<channel>)
4	Measure the input current (POINT 2) with the DMM. Note: Wait 5 minutes for the current to stabilize before measuring the voltage drop at the shunt resistor and calculate the shunt current ($I=V/R$).	CAL:CURR:LEV POINT2, (@<channel>)
5	Enter the calculated data, and press Next .	CAL:CURR <reading>, (@<channel>)
4	Measure the input current (POINT 3) with the DMM. Note: Wait 5 minutes for the current to stabilize before measuring the voltage drop at the shunt resistor and calculate the shunt current ($I=V/R$).	CAL:CURR:LEV POINT3, (@<channel>)
5	Enter the calculated data, and press Next .	CAL:CURR <reading>, (@<channel>)
4	Measure the input current (POINT 4) with the DMM. Note: Wait 5 minutes for the current to stabilize before measuring the voltage drop at the shunt resistor and calculate the shunt current ($I=V/R$).	CAL:CURR:LEV POINT4, (@<channel>)
5	Enter the calculated data, and press Next .	CAL:CURR <reading>, (@<channel>)
4	Measure the input current (POINT 5) with the DMM. Note: Wait 5 minutes for the current to stabilize before measuring the voltage drop at the shunt resistor and calculate the shunt current ($I=V/R$).	CAL:CURR:LEV POINT5, (@<channel>)
5	Enter the calculated data, and press Next .	CAL:CURR <reading>, (@<channel>)
6	Read DONE or FAIL on the display.	(wait 30 seconds) SYST:ERR?
7	Press Cal Save .	CAL:SAVE

Medium range (EL34143A and EL34243A only)

Allow the unit to sit with input ON for one minute before continuing.

Set the power supply to 3 V with a current limit of 6 A. Turn on the output of the power supply.

Step	Front Panel	SCPI
1	Press Perform Calibration and select the input for calibration. Press Cal Curr. Select Mid range and press Next .	CAL:CURR:LEV:MID MIN, (@<channel>)
2	Measure the input current (low point) with the DMM. Note: Wait 3 minutes for the current to stabilize before measuring the voltage drop at the shunt resistor and calculate the shunt current ($I=V/R$).	
3	Enter the calculated data, and press Next .	CAL:CURR:MID <reading>, (@<channel>)
4	Measure the input current (high point) with the DMM. Note: Wait 3 minutes for the current to stabilize before measuring the voltage drop at the shunt resistor and calculate the shunt current ($I=V/R$)	CAL:CURR:LEV:MID MAX, (@<channel>)
5	Enter the calculated data, and press Next .	CAL:CURR:MID <reading>, (@<channel>)
6	Read DONE or FAIL on the display.	(wait 30 seconds) SYST:ERR?
7	Press Cal Save .	CAL:SAVE

Low range

Allow the unit to sit with input ON for one minute before continuing.

- EL33133A: Set power supply to 3 V with a current limit of 4 A to prevent overcurrent to the DUT after calibration completed.
- EL34143A/EL34243A: Set power supply to 3 V with a current limit of 0.6 A.

Turn on the output of the power supply.

Step	Front Panel	SCPI
1	Press Perform Calibration and select the input for calibration. Press Cal Curr. Select Low range and press Next .	CAL:CURR:LEV:LOW MIN, (@<channel>)
2	Measure the input low range current (low point) with the DMM. Note: Wait 2 minutes for the current to stabilize before measuring the voltage drop at the shunt resistor and calculate the shunt current ($I=V/R$)	
3	Enter the calculated data, and press Next .	CAL:CURR:LOW <reading>, (@<channel>)
4	Measure the input low range current (high point) with the DMM. Note: Wait 2 minutes for the current to stabilize before measuring the voltage drop at the shunt resistor and calculate the shunt current ($I=V/R$)	CAL:CURR:LEV:LOW MAX, (@<channel>)
5	Enter the calculated data, and press Next .	CAL:CURR:LOW <reading>, (@<channel>)
6	Read DONE or FAIL on the display.	(wait 30 seconds) SYST:ERR?
7	Press Cal Save .	CAL:SAVE

Calibrate current limit

Let the unit sit with input ON for one minute.

Connect an external power supply to the load's input terminals with below configuration:

- EL33133A: Set power supply to 3 V with a current limit of 40 A.
- EL34143A/EL34243A: Set power supply to 3 V with a current limit of 60 A.

Connect a current shunt resistor in series with the unit's input and a DMM to measure the voltage across the shunt (see **CC Cal Setup**). Turn on the input of the power supply.

Step	Front Panel	SCPI
1	Press Perform Calibration and select the input for calibration. Press Cal Curr and press Next .	CAL:CURL:LEV MIN, (@<channel>)
2	Measure the input current (low point) with the DMM. Note: Wait 1 minute for the current to stabilize before measuring the voltage drop at the shunt resistor and calculate the shunt current ($I=V/R$)	
3	Enter the calculated data, and press Next .	CAL:CURL <reading>, (@<channel>)
4	Measure the input current (high point) with the DMM. Note: Wait 1 minute for the current to stabilize before measuring the voltage drop at the shunt resistor and calculate the shunt current ($I=V/R$)	
5	Enter the calculated data, and press Next .	CAL:CURL <reading>, (@<channel>)
6	Read DONE or FAIL on the display.	(wait 30 seconds) SYST:ERR?
7	Press Cal Save .	CAL:SAVE

Save the calibration data

To save calibration data, go to the 'CAL Save' menu to save the calibration data or enable the 'Auto Save' feature. With Auto Save, calibration data will be saved when the user exits the calibration menu.

After completing the voltage, current and current limit calibrations, save the calibration data before exiting the calibration state, or simply exit the calibration state if Auto Save is on.

To save the CAL data: CAL:SAVE

To enable the CAL Auto Save: CAL:ASAVE ON

To exit CAL State: CAL:SEC:STAT 1 <code>



This information is subject to change without notice.

© Keysight Technologies 2020, 2021
Edition 1, July 5, 2021
Printed in Malaysia



EL34243-90008

www.keysight.com