

# Keysight N8480 Series Power Sensors

Operating and  
Service Guide

# Notices

## Copyright Notice

© Keysight Technologies 2003 - 2020  
No part of this manual may be reproduced in any form or by any means (including electronic storage and retrieval or translation into a foreign language) without prior agreement and written consent from Keysight Technologies as governed by United States and international copyright laws.

## Manual Part Number

N8481-90000

## Edition

Edition 19, October 22, 2020

## Printed in:

Printed in Malaysia

## Published by:

Keysight Technologies  
Bayan Lepas Free Industrial Zone,  
11900 Penang, Malaysia

## Technology Licenses

The hardware and/or software described in this document are furnished under a license and may be used or copied only in accordance with the terms of such license.

## Declaration of Conformity

Declarations of Conformity for this product and for other Keysight products may be downloaded from the Web. Go to <http://www.keysight.com/go/conformity>. You can then search by product number to find the latest Declaration of Conformity.

## U.S. Government Rights

The Software is “commercial computer software,” as defined by Federal Acquisition Regulation (“FAR”) 2.101. Pursuant to FAR 12.212 and 27.405-3 and Department of Defense FAR Supplement (“DFARS”) 227.7202, the U.S. government acquires commercial computer software under the same terms by which the software is customarily provided to the public. Accordingly, Keysight provides the Software to U.S. government customers under its standard commercial license, which is embodied in its End User License Agreement (EULA), a copy of which can be found at <http://www.keysight.com/find/sweula>. The license set forth in the EULA represents the exclusive authority by which the U.S. government may use, modify, distribute, or disclose the Software. The EULA and the license set forth therein, does not require or permit, among other things, that Keysight: (1) Furnish technical information related to commercial computer software or commercial computer software documentation that is not customarily provided to the public; or (2) Relinquish to, or otherwise provide, the government rights in excess of these rights customarily provided to the public to use, modify, reproduce, release, perform, display, or disclose commercial computer software or commercial computer software documentation. No additional government requirements beyond those set forth in the EULA shall apply, except to the extent that those terms, rights, or licenses are explicitly required from all providers of commercial computer software pursuant to the FAR and the DFARS and are set forth specifically in writing elsewhere in the EULA. Keysight shall be under no obligation to update, revise or otherwise modify the Software. With respect to any technical data as defined by FAR 2.101, pursuant to FAR 12.211 and 27.404.2 and DFARS 227.7102, the U.S. government acquires no greater than Limited Rights as defined in FAR 27.401 or DFAR 227.7103-5 (c), as applicable in any technical data.

## Warranty

THE MATERIAL CONTAINED IN THIS DOCUMENT IS PROVIDED “AS IS,” AND IS SUBJECT TO BEING CHANGED, WITHOUT NOTICE, IN FUTURE EDITIONS. FURTHER, TO THE MAXIMUM EXTENT PERMITTED BY APPLICABLE LAW, KEYSIGHT DISCLAIMS ALL WARRANTIES, EITHER EXPRESS OR IMPLIED, WITH REGARD TO THIS MANUAL AND ANY INFORMATION CONTAINED HEREIN, INCLUDING BUT NOT LIMITED TO THE IMPLIED WARRANTIES OF MERCHANTABILITY AND FITNESS FOR A PARTICULAR PURPOSE. KEYSIGHT SHALL NOT BE LIABLE FOR ERRORS OR FOR INCIDENTAL OR CONSEQUENTIAL DAMAGES IN CONNECTION WITH THE FURNISHING, USE, OR PERFORMANCE OF THIS DOCUMENT OR OF ANY INFORMATION CONTAINED HEREIN. SHOULD KEYSIGHT AND THE USER HAVE A SEPARATE WRITTEN AGREEMENT WITH WARRANTY TERMS COVERING THE MATERIAL IN THIS DOCUMENT THAT CONFLICT WITH THESE TERMS, THE WARRANTY TERMS IN THE SEPARATE AGREEMENT SHALL CONTROL.

## Safety Information

### CAUTION

















A CAUTION notice denotes a hazard. It calls attention to an operating procedure, practice, or the like that, if not correctly performed or adhered to, could result in damage to the product or loss of important data. Do not proceed beyond a CAUTION notice until the indicated conditions are fully understood and met.

### WARNING

A WARNING notice denotes a hazard. It calls attention to an operating procedure, practice, or the like that, if not correctly performed or adhered to, could result in personal injury or death. Do not proceed beyond a WARNING notice until the indicated conditions are fully understood and met.

## Safety Symbols

The following symbols on the instrument and in the documentation indicate precautions which must be taken to maintain safe operation of the instrument.

	Direct current (DC)		Alternating current (AC)
	Off (mains supply)		On (mains supply)
	Caution, risk of electric shock		Caution, risk of danger (refer to this manual for specific Warning or Caution information)
	Earth (ground) terminal		Frame or chassis (ground) terminal
	Protective earth (ground) terminal		Equipment protected throughout by double insulation or reinforced insulation
	Both direct and alternating current		Out position of a bi-stable push control
	Caution, hot surface		In position of a bi-stable push control
	Three-phase alternating current		Equipotentiality
	<p>This symbol indicates that a device, or part of a device, may be susceptible to electrostatic discharges (ESD) which can result in damage to the product.</p> <p>Observe ESD precautions given on the product, or its user documentation, when handling equipment bearing this mark.</p>		

## Safety Considerations

Read the information below before using this instrument.

The following general safety precautions must be observed during all phases of operation, service, and repair of this instrument. Failure to comply with these precautions or with specific warnings elsewhere in this manual violates safety standards for design, manufacture, and intended use of the instrument. Keysight Technologies assumes no liability for the customer's failure to comply with these requirements.

### WARNING

Before connecting the power sensor to other instruments ensure that all instruments are connected to the protective (earth) ground. Any interruption of the protective earth grounding will cause a potential shock hazard that could result in personal injury.

---

### CAUTION

- Use the instrument with the cables provided.
  - Repair or service that is not covered in this manual should only be performed by qualified personnel.
-

## Environmental Conditions

The N8480 Series is designed for indoor use and in an area with low condensation. The table below shows the general environmental requirements for this instrument.

Environmental condition	Requirement
Temperature	Operating condition - 0 °C to 55 °C
	Storage condition - -40 °C to 70 °C
Humidity	Operating condition - Up to 95% RH at 40 °C
	Storage condition - Up to 90% RH at 65 °C (non-condensing)
Altitude	Operating condition - Up to 4,600 meters (15,000 feet)
	Storage condition - 7,620 meters (25,000 feet)

## Regulatory Information

The N8480 Series complies with the following Electromagnetic Compatibility (EMC) compliances:

### EMC compliance

- IEC 61326-1:2005/EN 61326-1:2006
- Canada: ICES/NMB-001:2004
- Australia/New Zealand: AS/NZS CISPR11:2004

## Regulatory Markings

	<p>The CE mark is a registered trademark of the European Community. This CE mark shows that the product complies with all the relevant European Legal Directives.</p>		<p>The RCM mark is a registered trademark of the Australian Communications and Media Authority.</p>
<p><b>ICES/NMB-001</b></p>	<p>ICES/NMB-001 indicates that this ISM device complies with the Canadian ICES-001. Cet appareil ISM est conforme a la norme NMB-001 du Canada.</p>		<p>This instrument complies with the WEEE Directive (2002/96/EC) marking requirement. This affixed product label indicates that you must not discard this electrical or electronic product in domestic household waste.</p>

# Waste Electrical and Electronic Equipment (WEEE) Directive 2002/96/EC

This instrument complies with the WEEE Directive (2002/96/EC) marking requirement. This affixed product label indicates that you must not discard this electrical or electronic product in domestic household waste.

## Product category

With reference to the equipment types in the WEEE directive Annex 1, this instrument is classified as a “Monitoring and Control Instrument” product.

The affixed product label is as shown below.



Do not dispose in domestic household waste.

To return this unwanted instrument, contact your nearest Keysight Service Center, or visit <http://about.keysight.com/en/companyinfo/environment/takeback.shtml> for more information.

## Sales and Technical Support

To contact Keysight for sales and technical support, refer to the support links on the following Keysight websites:

- [www.keysight.com/find/xxxx](http://www.keysight.com/find/xxxx)  
(product-specific information and support, software and documentation updates)
- [www.keysight.com/find/assist](http://www.keysight.com/find/assist)  
(worldwide contact information for repair and service)



# Table of Contents

Safety Symbols	3
Safety Considerations	4
Environmental Conditions	5
Regulatory Information	6
EMC compliance	6
Regulatory Markings	7
Waste Electrical and Electronic Equipment (WEEE) Directive	
2002/96/EC	8
Product category	8
Sales and Technical Support	8
<b>1 Introduction</b>	
General Information	16
Initial inspections	16
Accessories shipped with the instrument	16
Original packaging	17
Power meter and sensor cable requirements	17
Interconnection and calibration	18
Recommended calibration interval	20
Temperature sensitivity	20
Operating instructions	20
Modulation effect	22
Torque	22
Overview of the N8480 Series Power Sensors	24
N8485A power sensor	27
N8487A power sensor	27
N8488A power sensor	28
B-models and H-models information	28
Waveguide-models information	29
Options	30
Power Meter Firmware Compatibility	31

Power Meter Configuration Changes	32
Measurement Accuracy and Speed	33
Measurement considerations	33
<b>2 Specifications and Characteristics</b>	
<b>3 Service</b>	
Cleaning	38
Connector care	38
Principle of Operations	39
Performance Test	40
Linearity performance test	40
Standing wave ratio (SWR) and reflection coefficient (Rho) performance test	40
Zero set performance test	41
Replaceable Parts	43
Troubleshooting	50
Repair	51
Disassembly/Reassembly Procedures	52
Disassembly procedure	52
Reassembly procedure	52

## List of Figures

Figure 1-1	Connecting a sensor cable to power meter	18
Figure 1-2	Connecting waveguide flange to the N8486AQ power sensor	21
Figure 1-3	N8480 Series power sensor simplified block diagram	26
Figure 1-4	N8485A power sensor with adapter	27
Figure 1-5	N8487A power sensor with adapter	27
Figure 1-6	N8488A power sensor with adapter	28
Figure 1-7	Auto-averaging settings	32
Figure 3-1	Illustrated parts breakdown	44
Figure 3-2	Removing the power sensor shell	52

THIS PAGE HAS BEEN INTENTIONALLY LEFT BLANK.

## List of Tables

Table 1-1	power sensor cable options	17
Table 1-2	RF connector type, wrench size, and torque values	22
Table 1-3	Power range in range setting	25
Table 1-4	Power meter firmware	31
Table 3-1	Replaceable parts list for standard N8480 Series power sensors	45
Table 3-2	Replaceable parts list for N8480 Series power sensors with Option CFT	47
Table 3-3	Replacement part list for adapters used on the N8480 Series power sensors	49

THIS PAGE HAS BEEN INTENTIONALLY LEFT BLANK.

# 1 Introduction

General Information	16
Overview of the N8480 Series Power Sensors	24
Power Meter Firmware Compatibility	31
Power Meter Configuration Changes	32
Measurement Accuracy and Speed	33

This chapter contains information about initial inspection and overview of the Keysight N8480 Series power sensors.

## General Information

This guide contains information about the initial inspection, connections, specifications, operation, and performance tests of the N8480 Series power sensors.

### Initial inspections

- 1 Inspect the shipping container for damage. Signs of damage may include a dented or torn shipping container or cushioning material that shows signs of unusual stress or compacting.
- 2 Carefully remove the contents from the shipping container and verify that your order is complete.

#### NOTE

- If the shipping container or packaging material is damaged, it should be kept until the contents have been checked mechanically and electrically. If there is mechanical damage, notify the nearest Keysight Technologies office. Keep the damaged shipping materials (if any) for inspection by the carrier and Keysight representative. If required, you can find a list of Keysight Sales and Service Offices on the last page of this guide.
  - Ensure you have read and understand the preceding safety information before proceed.
- 

### Accessories shipped with the instrument

The following item is shipped with every purchase of N8480 Series power sensors:

- Certificate of Calibration

Verify that any options ordered are included with the shipment by checking the packing list included with the shipment.



## Original packaging

Containers and materials identical to those used in the factory packaging are available through Keysight Technologies office. If the instrument is being returned to Keysight Technologies for servicing, attach a tag indicating the type of service required, return address, model number, and serial number. Also mark the container FRAGILE to assure careful handling. In any correspondence, refer to the instrument by model number and serial number.

## Power meter and sensor cable requirements

Table 1-1 lists the length of cable option for the N8480 Series power sensors.

**Table 1-1** power sensor cable options

power sensor cable option	Description	Supported power meter
<b>11730 Family Sensor Cables (Grey)</b>		
11730A	1.5 m (5-ft) cable length	EPM Series power meters
11730B	3 m (10-ft) cable length	
11730C	6.1 m (20-ft) cable length	
11730D	15.2 m (50-ft) cable length	
11730E	30.5 m (100-ft) cable length	
11730F <sup>[a]</sup>	61 m (200-ft) cable length (operate up to 45 °C)	
<b>E9288 Family Sensor Cables (Blue)</b>		
E9288A	1.5 m (5-ft) cable length	EPM Series power meters <sup>[a]</sup> EPM-P Series power meters
E9288B	3 m (10-ft) cable length	
E9288C	10 m (31-ft) cable length	

**Table 1-1** power sensor cable options (continued)

power sensor cable option	Description	Supported power meter
<b>N1917 Family Sensor Cable Adapter</b>		
N1917A	1.5 m (5-ft) cable length	P-Series power meters
N1917B	3 m (10-ft) cable length	
N1917C	10 m (31-ft) cable length	
N1917D	1.8 m (6-ft) cable length	

[a] Only applicable for E4418B and E4419B power meters.

## Interconnection and calibration

Connect one end of the supported sensor cable to the N8480 Series power sensor and connect the other end of the cable to the power meter’s channel input. Allow approximately four seconds for the power meter to download the data from the power sensor’s EEPROM.



**Figure 1-1** Connecting a sensor cable to power meter

**NOTE**

- For B-models power sensors, you must disconnect the attached attenuator before connecting it to the power meter for zero and calibration.
  - The waveguide-models power sensors have two inputs:
    - Type-N connector – for a 50 MHz 1 mW calibration signal generated by the power meter
    - Waveguide flange – to be connected to the test port during actual measurement.
- 

**CAUTION**

For power sensors with Type-N connector, connect the power sensor to the power meter by turning the nut only. The power sensor can be damaged if the torque is applied to the power sensor's body.

---

**WARNING**

Before connecting the power sensor to other instruments, ensure that all instruments are connected to the protective (earth) ground. Any interruption of the protective earth grounding will cause a potential shock hazard that could result in personal injury.

---

To carry out a zero and calibration cycle required by the power meter, refer to the respective power meter's *User's Guide* for details of the power sensor's zero and calibration procedures.

For new connections and measurements below  $-25$  dBm (applicable for N8487A with serial number MY48700101 to MY54089999 and N8488A with serial number MY50230001 to MY54089999 only), it is recommended to perform the following steps.

- 1 Connect the power sensor to the test port.
- 2 Allow the power sensor to settle for at least 20 minutes with no RF power.
- 3 Perform zeroing with the power sensor still connected to the test port.

**NOTE**

It is recommended to perform frequent zeroing when performing measurements below  $-25$  dBm.

---

## Recommended calibration interval

Keysight Technologies recommends a one year calibration cycle for the N8480 Series power sensors.

## Temperature sensitivity

The sensitivity of the power sensor is influenced by ambient temperature. The sensor should be recalibrated at each change in temperature to obtain the most accurate results. The sensor has a built-in temperature compensation that ensures the accuracy of measurement carried out within 0 to 55 °C, refer to the datasheet for details. For measurement below -25 dBm, it is recommended to re-apply zero procedure when there has been a temperature variation of more than  $\pm 5$  °C since the last zeroing.

## Operating instructions

To operate the power sensors, refer to the operating instructions in the respective power meter's *User's Guide*.

**CAUTION****For N8486AQ power sensor only.**

When connecting the waveguide flange to the power sensor, make sure you follow the following procedures to avoid any damage to the precision waveguide flange:

- 1 Torque the waveguide flange's screws to <math><3.75\text{ lb-in}</math> (maximum).
- 2 Insert the two screws as indicated in [Figure 1-2](#) located at the side of the flange. Insert the remaining two screws to either side of the flange. Tighten the four screws until finger tight.
- 3 Tighten the flange using a calibrated torque wrench by going back and forth between each screws that are opposite to each others. Tighten each screw with a small incremental torque until the desired torque is achieved.

If you are using the hex ball driver, hold the driver with your thumb and forefinger to avoid excess torque. You must extremely careful not to over-torque when using the hex ball driver, and do not fully torque one screw before tightening the others.



Insert this screw, and the one opposite (hidden under the instrument) as shown in the diagram.

**Figure 1-2** Connecting waveguide flange to the N8486AQ power sensor

## Modulation effect

When measuring RF or microwave sources that are modulated at the chopper frequency (nominally 440 Hz), at the first or second harmonic or submultiples of the chopper frequency, beat notes may occur. Unless these beat notes are exactly the chopper frequency, they can usually be eliminated by averaging (filtering) since the amplitudes are plus and minus the actual power. These frequencies may also be avoided by changing the modulation frequency slightly, if possible.

Refer to the respective power meter's *User's Guide* for information on setting the averaging (filtering).

## Torque

**Table 1-2** shows the connector type (for connection to DUT) for the power sensor models. A torque wrench must be used to tighten these connectors. Only use a wrench set to the correct torque value.

**Table 1-2** RF connector type, wrench size, and torque values

Model	Option	RF connector	Wrench size	Torque value
N8481A	N8481A-100	Type-N (male)	3/4 inch open end	12 lb-in
	N8481A-200	APC-7		
N8482A	N8482A-100	Type-N (male)		
N8481B	N8481B-100			
N8482B	N8482B-100			
N8481H	N8481H-100			
N8482H	N8482H-100			
N8485A	N8485A-100	3.5 mm (male)	20 mm open end	8 lb-in
N8487A	N8487A-100	2.4 mm (male)	5/16 inch open end	8 lb-in
N8488A	N8488A-100	1.85 mm (male)	4/5 inch open end	8 lb-in

**Table 1-2** RF connector type, wrench size, and torque values (continued)

Model	Option	RF connector	Wrench size	Torque value
N8486AQ	N8486AQ-100	Waveguide Flange UG-383/U	3/32 inch Balldriver-Hex <sup>[a]</sup>	3.75 lb-in
N8486AR	N8486AR-100	Waveguide flange UG-599/U	3/32 inch Balldriver-Hex <sup>[a]</sup>	3.75 lb-in

[a] Balldriver is used to tighten the screws, instead of the connector.

## Overview of the N8480 Series Power Sensors

The N8480 Series power sensors are high accuracy thermocouple power sensors that allow direct measurement of RF or microwave power through the heating effect it has on a terminating load. All calibration data for the N8480 Series power sensors is stored in EEPROM<sup>[1]</sup> and is downloaded to the power meter when the sensor is connected. In terms of functionality and performance, they<sup>[2]</sup> replace and surpass the popular 8480 thermocouple power sensors.

The N8480 Series power sensors are used for measuring the average power supplied by an RF or microwave source or a device-under-test (DUT). In use, the power sensor is connected to the RF or microwave source and to a compatible power meter. The N8480 Series power sensors are compatible with the EPM Series power meters (E4418B, E4419B, N1913A, and N1914A), EPM-P Series power meters (E4416A and E4417A), and P-Series power meters (N1911A and N1912A) only. The N8480 Series power sensors place a 50  $\Omega$  load on the RF or microwave source. The power meter indicates the power dissipated in this load in mW or dBm.

The N8480 Series power sensors consist of four sensor model types with respective power range:

- A-models (-35 dBm to +20 dBm)
  - N8481A, N8482A, N8485A, N8487A, and N8488A<sup>[3]</sup>
- B-models (-5 dBm to +44 dBm)
  - N8481B and N8482B
- H-models (-15 dBm to +35 dBm)
  - N8481H and N8482H
- Waveguide-models (-35 dBm to +20 dBm)
  - N8486AQ and N8486AR

[1] The calibration factor table stored in the EEPROM is not applicable for N8480 Series power sensors with Option CFT.

[2] Except for N8488A power sensor. The N8488A power sensor is a newly introduced high frequency sensor. It is not meant to replace any of the existing 8480 thermocouple power sensors.

[3] Option CFT is not available for the N8488A power sensor.



**NOTE**

For B-models power sensors, the calibration factor data is valid only when the sensor is used with the supplied attenuator.

**Table 1-3** Power range in range setting

Sensor	Range setting	Lower range	Upper range
N8481/2/5/7/8A and N8486AQ/AR excluding Option CFT	AUTO (Default)	-35 dBm to -1 dBm	-1 dBm to +20 dBm
	LOWER	-35 dBm to -1 dBm	-
	UPPER <sup>[a]</sup>	-	-30 dBm to +20 dBm
N8481/2B excluding Option CFT	AUTO (Default)	-5 dBm to +29 dBm	+29 dBm to +44 dBm
	LOWER	-5 dBm to +29 dBm	-
	UPPER <sup>[a]</sup>	-	0 dBm to +44 dBm
N8481/2H excluding Option CFT	AUTO (Default)	-15 dBm to +17 dBm	+17 dBm to +35 dBm
	LOWER	-15 dBm to +17 dBm	-
	UPPER <sup>[a]</sup>	-	-10 dBm to +35 dBm

[a] Recommended for pulse signals measurement with period of more than one second.

The N8480 Series power sensors (excluding Option CFT) measure power levels from -35 dBm to +44 dBm (316 nW to 25.1 W), at frequencies from 100 kHz to 67 GHz, and have two independent power measurement range (upper and lower range).

Meanwhile, the N8480 Series power sensors with Option CFT (except for N8488A) only measure power levels from -30 dBm to +44 dBm (1  $\mu$ W to 25.1 W) in single range. Similar to the E-Series power sensors, the N8480 Series power sensors are also equipped with EEPROM to store sensor's characteristics such as model number, serial number, linearity, temperature compensation, calibration factor, and so forth.

This feature ensures the correct calibration data is applied by any compatible power meter connected with a N8480 Series power sensor and to ensure the accuracy of the measurements.

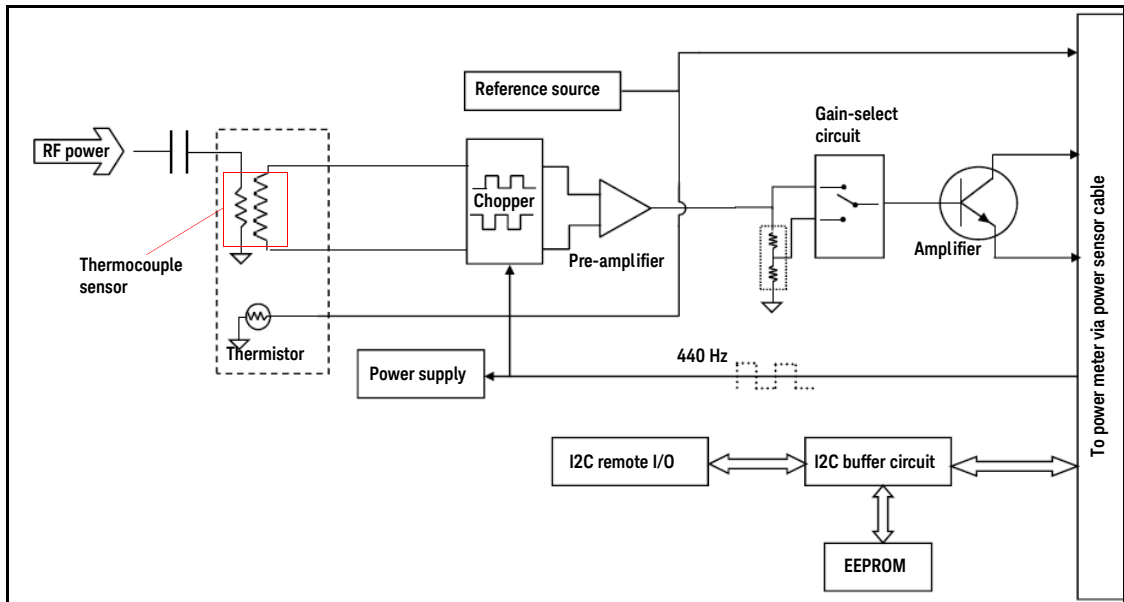

**Figure 1-3** N8480 Series power sensor simplified block diagram

Figure 1-3 illustrates a basic power sensor block diagram for thermocouple power sensing elements. From the RF or microwave signal input, the thermocouple detector mounts generate a very low voltage – in the order of nV. As the DC voltage is very low, it requires amplification before it can be transferred to the power meter on the standard cables.

The amplification is provided by an input amplifier assembly that consists of a balanced chopper and an AC coupled low-noise amplifier. The DC voltage is routed through gold wires to the chopper circuit, which converts the low-level DC voltage to an AC voltage. To do this, the chopper is controlled by a 440 Hz square-wave generated by the power meter (the chop signal). The result is an AC output signal proportional to the DC input. The AC signal is then amplified to a relatively high-level AC signal that can be routed to the power meter by standard cables (Keysight 11730 Series cables are available up to 61 meters from  $-5^{\circ}\text{C}$  to  $45^{\circ}\text{C}$ ).

## N8485A power sensor

The N8485A power sensor is fitted with 3.5 mm (m) connectors as standard. To convert the 3.5 mm (m) connector for calibration, an adapter (3.5 mm (f) to Type-N (m)) is included with the power sensor. See [Figure 1-4](#).



**Figure 1-4** N8485A power sensor with adapter

### NOTE

The 3.5 mm to Type-N adapter is intended for the use of 1 mW, 50 MHz power reference of the power meter only. Its function as a calibration reference may be compromised if it is used for other purpose.

## N8487A power sensor

The N8487A power sensor is fitted with 2.4 mm (m) connector as standard. To convert the 2.4 mm (m) connector for calibration, an adapter (2.4 mm (f) to Type-N (m)) is included with the power sensor. See [Figure 1-5](#).



**Figure 1-5** N8487A power sensor with adapter

### NOTE

The 2.4 mm to Type-N adapter is intended for the use of 1 mW, 50 MHz power reference of the power meter only. Its function as a calibration reference may be compromised if it is used for other purpose.

## N8488A power sensor

The N8488A power sensor is calibrated to measure power levels in 10 MHz to 67 GHz frequency range. This sensor is functional up to 70 GHz; with typical specifications ranging from 67 GHz to 70 GHz.

The N8488A power sensor is fitted with 1.85 mm (m) connector as standard. To convert the 1.85 mm (m) connector for calibration, an adapter (2.4 mm (f) to Type-N (m)) is included with the power sensor. See [Figure 1-6](#).



**Figure 1-6** N8488A power sensor with adapter

### NOTE

- The 2.4 mm to Type-N adapter is intended for the use of 1 mW, 50 MHz power reference of the power meter only. Its function as a calibration reference may be compromised if it is used for other purpose.
- According to *IEEE Standard for Precision Coaxial 1.85 mm Slash Sheet*, the 1.85 mm (m) connector is compatible with the 2.4 mm (f) connector. Hence, the adapter (2.4 mm (f) to Type-N (m)) can be used to convert the 1.85 mm (m) connector for calibration.

## B-models and H-models information

The B-models (with 30 dB removable attenuator) or H-models (with 20 dB attenuator) power sensor is a calibrated combination of an attenuator assembly and a sensor assembly.

The attenuator and sensor assemblies are calibrated as a set and must be used together when a specified accuracies are to be obtained. These combination is referred to as a power sensor.

**NOTE****For B-models power sensors only**

- Removal of D-ring from the sensor assembly will void the warranty.
  - The D-ring that is available on the input connector; located on the sensor is used to prevent the sensor from being connected to a high power source when an attenuator is not attached. The sensors must only be connected to the power meter for calibration or to a high power attenuator for any RF measurements.
- 

**WARNING**

- For B-models power sensors only. The high power attenuator contains a substrate of beryllium oxide. Beryllium oxide in powder form is a hazardous material and may be harmful to your health if inhaled. Do not perform any operation on the beryllium oxide that might generate dust.
  - Defective attenuator should be returned to Keysight Technologies for proper disposal.
- 

## Waveguide-models information

The waveguide power sensors (excluding Option CFT) measure power levels from -35 dBm to +20 dBm at frequencies from 26.5 GHz to 50 GHz. They consist of a multi-stepped coax which adapt the 50 W thermocouple impedance to the desired waveguide impedance, and hence provide a very low SWR up to 40 or 50 GHz.

## Options

### N8481A Option 200

The N8481A power sensor is fitted with Type-N (m) connector as standard. Users can choose the sensor to be fitted with APC-7 connector by choosing the Option 200.

### N8485A Option 033

The N8485A power sensor with Option 033 is calibrated to measure power levels in the 10 MHz to 33 GHz frequency range.

---

**NOTE**

The N8485A Option 033 power sensor is fitted with a 3.5 mm (m) connector.

---

### N8480 Series power sensors with Option CFT

The N8480 Series power sensors with Option CFT covers  $-30$  dBm to  $+20$  dBm in a single power range and allows users to use the calibration factor in two methods:

- manually enter the calibration factor for a particular frequency prior to make a measurement; or
- manually enter the sensors calibration factor table and select the frequency of the signal to be measured

The calibration factor data is provided on the label attached to the power sensor's cover. This calibration factor is used to make frequency dependent efficiency correction and it is unique to each sensors.

For Option CFT specifications and characteristics, see [Chapter 2, "Specifications and Characteristics."](#)

**NOTE**

- The calibration factor table stored in the EEPROM is not applicable for the N8480 Series power sensors with Option CFT.
  - Please refer to the respective power meter's *User's Guide* on how to make a measurement using the calibration factor table.
-

## Power Meter Firmware Compatibility

Before using the N8480 Series power sensors, make sure the power meter is using the latest firmware as shown in [Table 1-4](#). This is to ensure that the power meter is compatible with N8480 Series power sensors.

**Table 1-4** Power meter firmware

Power meter	Model number	Compatible firmware revision
EPM Series power meters	E4418B	A1.09.01 and above
	E4419B	A2.09.01 and above
	N1913A	A.01.00 and above
	N1914A	
EPM-P Series power meters	E4416A	A1.05.01 and above
	E4417A	A2.05.01 and above
P-Series power meters	N1911A	A.05.02 and above
	N1912A	

For detailed information on the firmware installation, refer to the respective power meter Web site located at [www.keysight.com](http://www.keysight.com) under **Technical Support > Drivers & Software > Firmware Update**.

## Power Meter Configuration Changes

The Keysight EPM Series, EPM-P Series, or P-Series power meters recognize the Keysight N8480 Series power sensor when it is connected. The N8480 Series power sensors (excluding Option CFT) calibration data is automatically read by the power meter. In addition, the auto-averaging settings shown in [Figure 1-7](#) are also automatically configured.

	N8481/2/5/7/8A N8486AQ/AR	N8481/2B	N8481/2H	Maximum sensor power	Resolution setting			
					1	2	3	4
0 dBm		30 dBm	20 dBm		1	1	2	8
-1 dBm		29 dBm	17 dBm		2	2	4	32
-10 dBm		20 dBm	10 dBm		2	2	4	32
-20 dBm		10 dBm	0 dBm		2	2	16	256
-30 dBm		0 dBm	-10 dBm		2	8	128	128
					4	64	256	512
				Minimum sensor power				

**Figure 1-7** Auto-averaging settings

**NOTE**

These values are valid only for the power meter channel connected to a Keysight N8480 Series power sensor. Averaging settings can also be manually configured. Refer to the respective power meter's *User's Guide* for information on setting the averaging (filtering).



## Measurement Accuracy and Speed

The power meter has no internal ranges. The only ranges you can set are those of the Keysight N8480 Series power sensors and other Keysight E-Series power sensors. With a Keysight N8480 Series power sensor (excluding Option CFT) or E-Series power sensor, the range can be set either automatically or manually. Use autoranging when you are not sure of the power level you are about to measure.

### Measurement considerations

While autoranging is a good starting point, it is not ideal for all measurements. Signal characteristics such as crest factor or duty cycle may cause the power meter to select a range which is not the optimum configuration for your specific measurement needs. Signals with average power levels close to the range switch point require you to consider your needs for measurement accuracy. When measuring pulse signals, you are recommended to select manual filtering. This allows you to choose the averaging to cover the many periods of the pulse signal instead of having it determined by measurement noise. Selecting manual filtering also changes the behavior of the autoranging to help prevent frequency range changes due to pulses. For a very long pulse periods (more than one second), it may be better to select UPPER range as this will prevent any possibility of range changes upsetting the measurement.

THIS PAGE HAS BEEN INTENTIONALLY LEFT BLANK.

## 2 Specifications and Characteristics

For the characteristics and specifications of the N8480 Series Power Sensors refer to the datasheet at

<http://literature.cdn.keysight.com/litweb/pdf/5989-9333EN.pdf>

THIS PAGE HAS BEEN INTENTIONALLY LEFT BLANK.

# 3 Service

Cleaning	38
Principle of Operations	39
Performance Test	40
Replaceable Parts	43
Troubleshooting	50
Repair	51
Disassembly/Reassembly Procedures	52

This chapter contains information about principle of operations, troubleshooting, and repair of the Keysight N8480 Series power sensors.

## Cleaning

Use a clean, damp cloth to clean the body of the N8480 Series power sensors.

### Connector care

A solution of pure isopropyl or ethyl alcohol can be used to clean connectors but make sure to keep in mind on its flammable nature.

#### CAUTION

- **The RF connector bead deteriorates when contacted with any chlorinated or aromatic hydrocarbon such as acetone, trichlorethane, carbon tetrachloride, and benzene.**
  - **Do not attempt to clean connectors with anything metallic such as pins or paper clips.**
- 

Clean the connector only at a static free workstation. Electrostatic discharge to the center pin of the connector will render the power sensor inoperative.

Clean the connector face by first using a blast of compressed air. If the compressed air fails to remove contaminants, use a cotton swab dipped in isopropyl or ethyl alcohol. If the swab is too big, use a round wooden toothpick wrapped in a lint free cloth dipped in isopropyl or ethyl alcohol.

## Principle of Operations

The A1 module assembly (refer to [Figure 3-1](#)) on the Keysight N8480 Series power sensors provides a 50  $\Omega$  load to the RF signal applied to the power sensor. A thermocouple assembly in the bulkhead converts the applied RF to produce DC voltages which vary with the RF power across the 50  $\Omega$  load.

The low-level DC voltages from the bulkhead assembly are amplified before they are transferred on standard cables to the power meter. The amplification is provided by an input amplifier assembly which consists of a chopper (sampling gate) and an input amplifier. The chopper circuit converts the DC voltages to AC voltages. The chopper is controlled by a 440 Hz square wave generated by the power meter. The amplitude of the sampling gate output is a 440 Hz square wave which varies with the RF power input. The 440 Hz AC output is applied to an amplifier which provides the input to the power meter.

The Keysight EPM Series, EPM-P Series, or P-Series power meters automatically detects the power sensor when a Keysight N8480 Series power sensor is connected and downloads the correction data from the sensor's EEPROM. The auto-averaging settings are also configured automatically for use with Keysight N8480 Series power sensors. This configures the power meter to operate over the range with that particular sensor's unique correction data applied.

## Performance Test

### Linearity performance test

For the N8480 Series power sensors, the linearity test together with the complete performance verification test is available in the Test Management Environment (TME) platform. Please refer to the TME N7850A Calibration Application for the details.

### Standing wave ratio (SWR) and reflection coefficient (Rho) performance test

This section does not establish preset SWR test procedures since there are several test methods and different equipment available for testing the SWR or reflection coefficient. Therefore, the actual accuracy of the test equipment must be accounted for when measuring against instrument specifications to determine a pass or fail condition.

To check the calibration factor, the power sensor should be compared with another recently calibrated power sensor. The source should be leveled with a reference coupler that has low SWR and high directivity to monitor or level the incident power.

For calibration factor and error analysis, refer to *Keysight Application Note AN1449-1 to AN1449-4 (Part 1 to Part 4), "Fundamentals of RF and Microwave Power Measurement"*.

#### NOTE

#### **Waveguide power sensors only (N8486AR and N8486AQ)**

While the flange of the N8486AR is similar to the one described in MIL F-3922/54C-003, the N8486AQ is modified to mate with the greater precision of MIL-3922/67B-006 flanges. The true position of the holes relative to each other are held to a diameter tolerance of 0.0254 mm (0.001 in). The holes are held to 1.664 mm (0.0655 in) minimum diameter while the pins are held to 1.61 mm (0.0634 in) maximum diameter.

---



## Zero set performance test

This performance test is carried out to verify that a minimal amount of residual offset error is present after zeroing has been performed. The offset error is caused by contamination from several sources including the noise of the device-under-test (DUT) itself. Zero set is the difference between the power levels indicated by the DUT, after executing zeroing and the true zero power. Ideally, this difference should be zero.

This performance test requires a compatible Keysight power meter with the DUT and a computer with the Keysight IO Libraries Suite installed.

System specification:  $\pm 25$  nW, tested at 50 MHz

Recommended power meter: N1913A, N1914A

### Procedure

- 1 Connect the DUT (N8480 Series) to the power meter (N1913A) as shown in the following diagram. Then, launch the Keysight IO Libraries Suite on the computer.

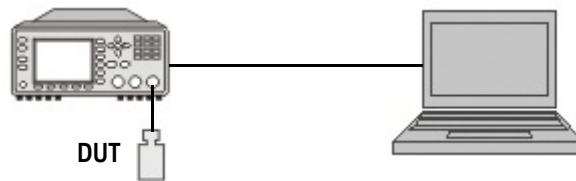

- 2 Warm up the DUT for approximately an hour.
- 3 Launch the Interactive IO on the Keysight IO Libraries Suite to send SCPI commands to the DUT.
- 4 Reset the power meter to a known state by sending a `*RST` command, followed by a `SYST:PRES` command to pre-set the power meter's output to its default value.
- 5 Perform zeroing for the DUT by sending `CAL:ZERO:AUTO ONCE` and calibration for the DUT by sending `CAL:AUTO ONCE`.
- 6 Set the frequency of the DUT to 50 MHz by sending `FREQ 50MHz`.
- 7 Enable auto-averaging for the DUT by sending `AVER:COUN:AUTO ON`.

- 8** Change the power measurement unit of the DUT to watt by sending "UNIT:POW W".
- 9** Disconnect the DUT from the power meter 1 mW calibrator.
- 10** Choose the high range first by sending "SENS1:POW:AC:RANG 1".
- 11** Perform zeroing for the DUT by sending "CAL:ZERO:AUTO ONCE".
- 12** Set the DUT to the single trigger mode by sending "INIT:CONT OFF".
- 13** Read the noise level of the DUT by sending "READ?" and then record the reading.
- 14** Repeat **step 13** for 10 times and then calculate the mean value of the readings.
- 15** Choose the lower range next by sending "SENS1:POW:AC:RANG 0" and repeat **step 11** to **step 14**.
- 16** Compare the calculated mean value to the system specification. If the test fails, refer to "Repair" on page 51.

## Replaceable Parts

Figure 3-1 illustrates the parts breakdown of the N8480 Series power sensors that identifies all the replaceable parts. If you want to order a part, quote the Keysight part number, specify the quantity required, and address the order to the nearest Keysight office.

### NOTE

- If you are located within United States, you are advised to order directly from the Keysight Parts Center in Roseville, California.
  - Ask your nearest Keysight office for ordering information and forms for the “Direct Mail Order System”. Information such as toll free telephone number will be provided.
-

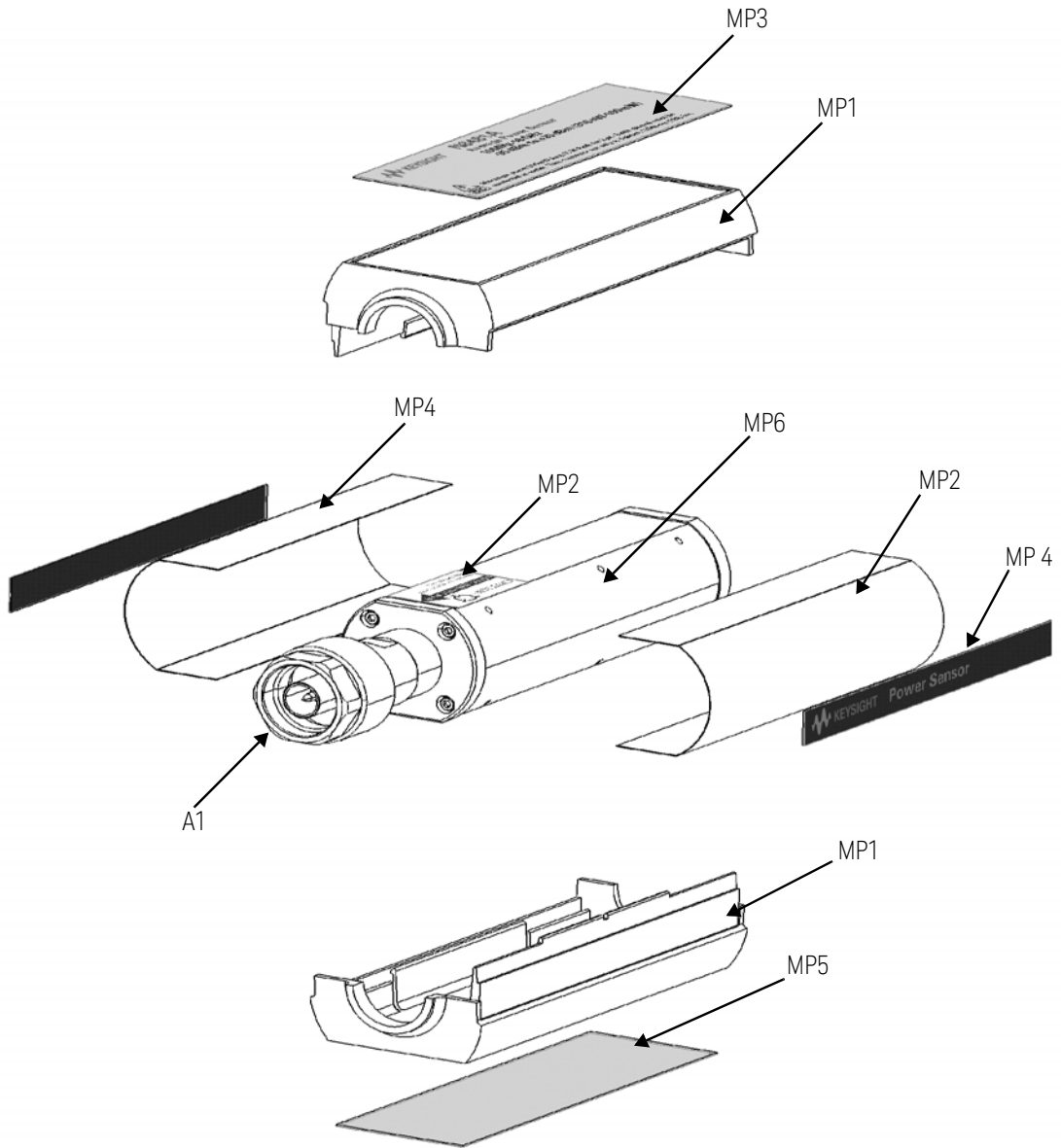

**Figure 3-1** Illustrated parts breakdown

**Table 3-1** Replaceable parts list for standard N8480 Series power sensors

Reference designation	Option	Part number	Quantity	Description
<b>A1</b>				
N8481A	N8481A-100	N8481-60007	1	N8481A (Type-N) replacement module
	N8481A-200	N8481-60008	1	N8481A (APC-7) replacement module
N8482A	N8482A-100	N8482-60002	1	N8482A (Type-N) replacement module
N8485A	N8485A-100	N8485-60002	1	N8485A (3.5 mm) replacement module
N8485A	N8485A-033	N8485-66005	1	N8485A (option 033) replacement module
N8487A	N8487A-100	N8487-60005	1	N8487A (2.4 mm) replacement module
N8488A	N8488A-100	N8488-60006	1	N8488A (1.85 mm) replacement module
N8481B	N8181B-100	N8481-60012	1	N8481B (Type-N) replacement module
N8482B	N8482B-100	N8482-60008	1	N8482B (Type-N) replacement module
N8481H	N8481H-100	N8481-60014	1	N8481H (Type-N) replacement module
N8482H	N8482H-100	N8482-60010	1	N8482H (Type-N) replacement module
N8486AR	N8486AR-100	N8486-60010	1	N8486AR (Waveguide flange UG-599/U) replacement module
N8486AQ	N8486AQ-100	N8486-60008	1	N8486AQ (Waveguide flange UG-383/U) replacement module

**Table 3-1** Replaceable parts list for standard N8480 Series power sensors (continued)

Reference designation	Option	Part number	Quantity	Description
<b>Chassis Parts</b>				
MP1	-	E9321-40001	2	Plastic shell
MP2	-	E9321-00001	2	Shield
MP3	-	N8481-84301	1	Label-ID top (N8481A)
MP3	-	N8482-84301	1	Label-ID top (N8482A)
MP3	-	N8485-84301	1	Label-ID top (N8485A)
MP3	-	N8485-84303	1	Label-ID top (N8485A Option 033)
MP3	-	N8487-84301	1	Label-ID top (N8487A)
MP3	-	N8488-84301	1	Label-ID top (N8488A)
MP3	-	N8486-84301	1	Label-ID top (N8486AR)
MP3	-	N8486-84302	1	Label-ID top (N8486AQ)
MP3	-	N8481-84302	1	Label-ID top (N8481B)
MP3	-	N8482-84302	1	Label-ID top (N8482B)
MP3	-	N8481-84303	1	Label-ID top (N8481H)
MP3	-	N8482-84303	1	Label-ID top (N8482H)
MP4	-	N8481-84304	2	Label-Side
MP5	-	N8481-84305	1	Label-Cert. bottom
MP6	-	00346-80011	1	Label-Information

**Table 3-2** Replaceable parts list for N8480 Series power sensors with Option CFT

Reference designation	Option	Part number	Quantity	Description
<b>A1</b>				
N8481A	N8481A-100	N8481-60009	1	N8481A (Type-N) replacement module, CFT Option
	N8481A-200	N8481-60010	1	N8481A (APC-7) replacement module, CFT Option
N8482A	N8482A-100	N8482-60007	1	N8482A (Type-N) replacement module, CFT Option
N8485A	N8485A-100	N8485-60003	1	N8485A (3.5 mm), replacement module, CFT Option
N8485A	N8485A-033	N8485-66506	1	N8485A (option 033) replacement module, CFT Option
N8487A	N8487A-100	N8487-60006	1	N8487A (2.4 mm) replacement module, CFT Option
N8481B	N8181B-100	N8481-60013	1	N8481B (Type-N) replacement module, CFT Option
N8482B	N8482B-100	N8482-60009	1	N8482B (Type-N) replacement module, CFT Option
N8481H	N8481H-100	N8481-60015	1	N8481H (Type-N) replacement module, CFT Option
N8482H	N8482H-100	N8482-60011	1	N8482H (Type-N) replacement module, CFT Option
N8486AR	N8486AR-100	N8486-60011	1	N8486AR (Waveguide flange UG-599/U) replacement module, CFT Option
N8486AQ	N8486AQ-100	N8486-60009	1	N8486AQ (Waveguide flange UG-383/U) replacement module, CFT Option

**Table 3-2** Replaceable parts list for N8480 Series power sensors with Option CFT (continued)

Reference designation	Option	Part number	Quantity	Description
<b>Chassis Parts</b>				
MP1	-	E9321-40001	2	Plastic shell
MP2	-	E9321-00001	2	Shield
MP3	-	N8481-84307	1	Label-ID top (N8481A)
MP3	-	N8482-84306	1	Label-ID top (N8482A)
MP3	-	N8485-84302	1	Label-ID top (N8485A)
MP3	-	N8485-84304	1	Label-ID top (N8485A Option 033)
MP3	-	N8487-84302	1	Label-ID top (N8487A)
MP3	-	N8486-84303	1	Label-ID top (N8486AR)
MP3	-	N8486-84304	1	Label-ID top (N8486AQ)
MP3	-	N8481-84310	1	Label-ID top (N8481B)
MP3	-	N8482-84309	1	Label-ID top (N8482B)
MP3	-	N8481-84311	1	Label-ID top (N8481H)
MP3	-	N8482-84310	1	Label-ID top (N8482H)
MP4	-	N8481-84304	2	Label-Side
MP5	-	N8481-84306	1	Label ID Certification Bottom - CFT Option
MP6	-	00346-80011	1	Label-Information



**Table 3-3** Replacement part list for adapters used on the N8480 Series power sensors

Model	Part number	Quantity	Description
N8485A	08485-60005	1	3.5 mm to N(m) Coax Adapter
N8487A	08487-60001	1	2.4 mm to N(m) Coax Adapter

## Troubleshooting

Troubleshooting information is intended to first isolate the power sensor, cable, or power meter as the defective component. When the power sensor is isolated, an appropriate sensor module must be used for repair. See [Table 3-1](#) and [Table 3-2](#).

If error message 241 or 310 is displayed on the power meter, suspect a power sensor failure. Error 241 will occur if the power sensor is missing. A supported cable must be used to connect the N8480 Series power sensors to a power meter.

If no error message is displayed, but a problem occurs when making a measurement, try replacing the cable from the power meter to the power sensor. If the problem still exists, try using a different power sensor to determine if the problem is in the power meter or in the power sensor.

Electrostatic discharge will render the power sensor inoperative. Do not, under any circumstances, open the power sensor unless you and the power sensor are in a static free environment.

## Repair

There is no serviceable parts inside the N8480 Series power sensors. If the power sensor is defective, send it back to the nearest Keysight Service Center for repair. The entire “module” of the defective power sensor will be replaced with an appropriate replacement module listed in [Table 3-1](#) and [Table 3-2](#).

## Disassembly/Reassembly Procedures

### Disassembly procedure

Disassemble the power sensor by performing the following steps:

- 1 Disassemble the power sensor only in a static free workstation. Electrostatic discharge renders the power sensor inoperative.
- 2 At the rear of the power sensor, insert the blade of a screwdriver between the plastic shells (See [Figure 3-2](#)). To prevent damage to the plastic shells use a screwdriver blade as wide as the slot between the two shells.
- 3 Pry alternately at both sides of the connector until the plastic shells are apart. Remove the shells and the magnetic shields.



**Figure 3-2** Removing the power sensor shell

### Reassembly procedure

Replace the magnetic shields and the plastic shells. Snap the plastic shells together.



This information is subject to change without notice. Always refer to the Keysight website for the latest revision.

© Keysight Technologies 2003 - 2020  
Edition 19, October 22, 2020

Printed in Malaysia



N8481-90000

[www.keysight.com](http://www.keysight.com)