

User's Guide

Keysight Technologies FieldFox Analyzers

N9912A

Notices

© Keysight Technologies, Inc. 2015-2021

No part of this manual may be reproduced in any form or by any means (including electronic storage and retrieval or translation into a foreign language) without prior agreement and written consent from Keysight Technologies, Inc. as governed by United States and international copyright laws.

Trademark Acknowledgments

Manual Part Number

N9912-90001

Edition

Edition 2, May 2021

Supersedes: April 2021

Printed in USA/Malaysia

Published by:
Keysight Technologies
1400 Fountaingrove Parkway
Santa Rosa, CA 95403

Warranty

THE MATERIAL CONTAINED IN THIS DOCUMENT IS PROVIDED "AS IS," AND IS SUBJECT TO BEING CHANGED, WITHOUT NOTICE, IN FUTURE EDITIONS. FURTHER, TO THE MAXIMUM EXTENT PERMITTED BY APPLICABLE LAW, KEYSIGHT DISCLAIMS ALL WARRANTIES, EITHER EXPRESS OR IMPLIED WITH REGARD TO THIS MANUAL AND ANY INFORMATION CONTAINED HEREIN, INCLUDING BUT NOT LIMITED TO THE IMPLIED WARRANTIES OF MERCHANTABILITY AND FITNESS FOR A PARTICULAR PURPOSE. KEYSIGHT SHALL NOT BE LIABLE FOR ERRORS OR FOR INCIDENTAL OR CONSEQUENTIAL DAMAGES IN CONNECTION WITH THE FURNISHING, USE, OR PERFORMANCE OF THIS DOCUMENT OR ANY INFORMATION CONTAINED HEREIN. SHOULD KEYSIGHT AND THE USER HAVE A SEPARATE WRITTEN AGREEMENT WITH WARRANTY TERMS

COVERING THE MATERIAL IN THIS DOCUMENT THAT CONFLICT WITH THESE TERMS, THE WARRANTY TERMS IN THE SEPARATE AGREEMENT WILL CONTROL.

Technology Licenses

The hardware and/or software described in this document are furnished under a license and may be used or copied only in accordance with the terms of such license.

U.S. Government Rights

The Software is "commercial computer software," as defined by Federal Acquisition Regulation ("FAR") 2.101. Pursuant to FAR 12.212 and 27.405-3 and Department of Defense FAR Supplement ("DFARS") 227.7202, the U.S. government acquires commercial computer software under the same terms by which the software is customarily provided to the public.

Accordingly, Keysight provides the Software to U.S. government customers under its standard commercial license, which is embodied in its End User License Agreement (EULA), a copy of which can be found at

<http://www.keysight.com/find/sweula>

The license set forth in the EULA represents the exclusive authority by which the U.S. government may use, modify, distribute, or disclose the Software. The EULA and the license set forth therein, does not require or permit, among other things, that Keysight: (1) Furnish technical information related to commercial computer software or commercial computer software documentation that is not customarily provided to the public; or (2) Relinquish to, or otherwise provide, the government rights in excess of these rights customarily provided to the public to use, modify, reproduce, release, perform, display, or disclose commercial computer software or commercial computer software

documentation. No additional government requirements beyond those set forth in the EULA shall apply, except to the extent that those terms, rights, or licenses are explicitly required from all providers of commercial computer software pursuant to the FAR and the DFARS and are set forth specifically in writing elsewhere in the EULA. Keysight shall be under no obligation to update, revise or otherwise modify the Software. With respect to any technical data as defined by FAR 2.101, pursuant to FAR 12.211 and 27.404.2 and DFARS 227.7102, the U.S. government acquires no greater than Limited Rights as defined in FAR 27.401 or DFAR 227.7103-5 (c), as applicable in any technical data.

Safety Notices

CAUTION

A **CAUTION** notice denotes a hazard. It calls attention to an operating procedure, practice, or the like that, if not correctly performed or adhered to, could result in damage to the product or loss of important data. Do not proceed beyond a CAUTION notice until the indicated conditions are fully understood and met.

WARNING

A **WARNING** notice denotes a hazard. It calls attention to an operating procedure, practice, or the like that, if not correctly performed or adhered to, could result in personal injury or death. Do not proceed beyond a WARNING notice until the indicated conditions are fully understood and met.

Contacting Keysight

Assistance with test and measurements needs and information on finding a local Keysight office are available on the Web at: <http://www.keysight.com/find/assist>

If you do not have access to the Internet, please contact your Keysight field engineer.

In any correspondence or telephone conversation, refer to the Keysight product by its model number and full serial number. With this information, the Keysight representative can determine whether your product is still within its warranty period.

Where to Find the Latest Information

Documentation is updated periodically. For the latest information about these products, including instrument software upgrades, application information, and product information, browse to one of the following URLs, according to the name of your product:

<http://www.keysight.com/find/fieldfox>

To receive the latest updates by email, subscribe to Keysight Email Updates at the following URL:

<http://www.keysight.com/find/MyKeysight>

Information on preventing instrument damage can be found at:

www.keysight.com/find/PreventingInstrumentRepair

Is your product software up-to-date?

Periodically, Keysight releases software updates to fix known defects and incorporate product enhancements. To search for software updates for your product, go to the Keysight Technical Support website at:

www.keysight.com/find/fieldfoxsupport

A.08.25 Firmware Release Updates (N991xA/2xA/3xA with serial number prefixes <5607)

For customers upgrading FieldFox firmware, the following is a list of changes from the previous release:

Updated LAN IP behavior:

[“LAN Settings” on page 18-18](#)

Other updates:

- pulse measurement mode offset value limit
- differential measurement impedance format calculation
- Recall functionality (N9912A only)

A.09.50 Firmware Release Updates (Also, applies to N9912A units with serial number prefixes ≥ 5607)

For customers upgrading FieldFox firmware, the following is a list of changes from the previous release:

Added Real-Time Spectrum Analysis (RTSA) Mode - (**Option 350 does not apply to N9912A**)

Contents

1. Overview

Options and Features	1-1
Accessories	1-3
FieldFox Manuals, Software, and Supplemental Help	1-4
Conventions that are used in the Manual	1-4
Safety Notes	1-5

2. Preparing for Initial Use of Your New FieldFox

Check the Shipment	2-1
Meeting Power Requirements for the AC/DC Adapter	2-1
Install the Lithium-Ion Battery	2-2
Battery Usage	2-2
FieldFox ON/OFF Settings	2-3
Power Button LED Status	2-4
FieldFox High Temperature Protection	2-4
How to monitor the internal FieldFox temperature:	2-4
Temperature Control Mode	2-5
High-Temp Shut down	2-5
Avoid Overpowering the FieldFox	2-5
Take the FieldFox Tour	2-7
Front Panel	2-7
Top Panel	2-10
Side Panel	2-10
Screen Tour	2-12
How to Enter Numeric Values	2-14
Multiplier Abbreviations	2-14
Connector Care	2-15

3. CAT (Cable and Antenna Test) Mode

CAT Mode Settings	3-3
How to select CAT Mode	3-3
Measurement Selection	3-3
Quick Settings Table	3-4
Frequency Range	3-5
Scale Settings	3-5
Averaging	3-6
Smoothing	3-7
Single or Continuous Measure	3-7

Contents

Resolution (Number of Data Points)	3-8
Sweep Time	3-8
Output Power	3-9
Interference Rejection	3-10
Coupled Frequency	3-11
Return Loss Measurements	3-12
How to Measure Return Loss	3-12
1-Port Cable Loss Measurements	3-12
How to make a 1-port Cable Loss Measurement	3-13
2-Port Insertion Loss Measurements	3-14
4. DTF (Distance to Fault) Measurements	
How to make DTF Measurements	4-18
DTF Measurement Settings	4-19
DTF Settings Table	4-19
DTF Measurement (Format)	4-19
DTF Start and Stop Distance	4-20
Frequency Mode	4-20
Coupled Frequency	4-21
Cable (Correction) Specifications	4-22
Window Settings	4-25
DTF Units	4-25
Calculated DTF values	4-26
About Alias Faults	4-26
5. NA (Network Analyzer) Mode	
NA Mode Settings	5-3
Measurement Selection	5-3
Parameter Conversion	5-3
Multi-Trace Configurations	5-4
Quick Settings	5-5
Calibration Settings	5-6
Format	5-7
Frequency Range	5-8
Scale Settings	5-8
Magnitude Offset	5-9
Electrical Delay	5-10
Phase Offset	5-10
Averaging	5-11
IF Bandwidth	5-12
Smoothing	5-12

Single or Continuous Measure	5-13
Resolution (Number of Data Points)	5-13
Sweep Time	5-14
Output Power	5-14
System Impedance (Z0)	5-15
Port Extensions	5-16
Velocity Factor	5-17
S21 Transmission Measurements	5-17
Big Marker Display States (A and B)	5-18
Increase Dynamic Range	5-20
6. Time Domain – Option 010	
Overview	6-3
Time Domain (Transform) Settings	6-4
Transform Settings Table	6-4
Frequency Range and Points	6-4
Stimulus (Mode)	6-5
Set Frequency Lowpass	6-5
Start/Stop Time	6-5
Distance Units	6-6
Window Layout	6-6
Transform Window	6-6
Line Loss and Velocity Factor	6-7
Data Chain	6-8
Trace Settings	6-9
Transform Enable	6-9
Gate Enable	6-9
Gating	6-10
How to make Time Domain Gating settings	6-10
Start, Stop, Center, and Span Gate Times	6-10
Gating Type	6-10
7. Calibration for NA, CAT, and VVM Modes	
Why and When to Calibrate	7-2
Why and When to Calibrate	7-2
Definitions	7-2
Preset Calibration (also known as CalReady)	7-3
QuickCal	7-3
O, S, L Cal	7-5
Normalize	7-6
Interpolation	7-7

Contents

Cal ON ? – Questionable Accuracy	7-8
Compatible Mode Calibrations	7-8
Compatible 1-port and 2-port Calibrations	7-8
Save the Calibration	7-9
Verifying Calibration and Jumper Cable Integrity	7-10
Verify a Calibration	7-10
Test the Jumper Cable	7-10
Calibration Method Summary	7-11
8. SA (Spectrum Analyzer) Mode	
SA Mode Settings	8-4
How to select SA Mode	8-4
Frequency Range	8-4
Radio Standard	8-6
Custom Radio Standards	8-6
Channel Selection	8-7
Scale and Units	8-8
External Gain	8-10
Attenuation Control	8-10
Preamplifier Control (Opt 235)	8-11
Check for Compressed Measurements	8-11
Field Strength Measurements	8-12
Using the Antenna/Cable Editor	8-13
Tune & Listen (AM/FM)	8-16
Independent Source	8-18
Resolution Bandwidth (Res BW)	8-20
Video Bandwidth (Video BW)	8-21
Sweep Type	8-21
Sweep Acquisition	8-22
Very Long Sweep Times	8-23
Zero Span Measurements	8-23
Triggering	8-25
Single / Continuous / Restart	8-27
Points	8-27
Trace Display States	8-28
Average Type	8-29
Average Count	8-29
Detection Method	8-30
Display Line	8-31
Noise Marker	8-32
Band/Interval Power Marker	8-33
Frequency Counter at Marker	8-34

Audio Beep at Marker Power	8-35
Meas UNCAL Error	8-35
Old Data Indicator (*)	8-35
Channel Measurements	8-37
Radio Standards and Channel Measurements	8-37
Measurement Preset	8-37
Averaging	8-37
Traces	8-38
Channel Power (CHP)	8-38
9. Interference Analyzer (SA Mode) – Option 236	
Spectrogram and Waterfall Displays	9-2
Spectrogram Display	9-2
Common Settings for Waterfall and Spectrogram	9-3
Record/Playback	9-7
10. Channel Power Meter Mode – Option 311	
CPM Settings	10-3
How to select Reflection Mode	10-3
Frequency/Span/Step	10-3
Radio Standard	10-4
Attenuation	10-4
11. Power Meter Mode (Option 302)	
Supported Power Sensors	11-2
Supported Power Sensors	11-2
How to Connect the Power Sensor	11-2
Power Meter Settings	11-3
How to select Power Meter Mode	11-3
Average / Peak	11-3
Zeroing	11-3
Frequency	11-4
Source Control	11-4
Scale	11-5
Relative and Offset Power Measurements	11-6
Display Units	11-6
Resolution	11-6
Averaging	11-7
Single or Continuous Measure	11-7
Step Detection Mode	11-8
Limits	11-8

12. Frequency Offset Using Power Sensor (FOPS) – Option 208	
Overview	12-3
FOPS Settings	12-5
How to select Power Meter (USB Sensor)	12-5
Measurement Selection	12-5
Sweep Type and Frequency	12-6
Power Sensor Settling	12-8
Sweep Settings	12-8
Amplitude Markers	12-9
Trace Math	12-9
13. Pulse Measurements Mode – Option 330	
Supported Power Sensors	13-3
Switching between Pulse Measurement Mode and Power Meter Mode	13-3
How to Connect the Power Sensor	13-3
Pulse Measurement Settings	13-4
How to select Pulse Measurement Mode	13-4
Measurement Selection	13-4
Frequency / Time	13-4
Zoom Window	13-5
Scale	13-6
Averaging	13-6
Video Bandwidth	13-7
Single or Continuous Measure	13-7
Resolution	13-8
Triggering	13-8
Marker Settings	13-11
Amplitude Markers	13-11
Marker Search	13-12
Auto Analysis	13-13
Pulse Top	13-14
Grid	13-14
Trace Memory	13-14
14. VVM (Vector Voltmeter) Mode – Option 308	
Overview	14-3
VVM Mode Settings	14-4
How to select VVM Mode	14-4
Measurement Selection	14-4
Frequency Selection	14-4
Display Resolution	14-5

IF Bandwidth	14-5
Output Power	14-5
Averaging	14-7
Single or Continuous Measure	14-7
VVM Calibration	14-8
Zeroing	14-8
1-Port Cable Trimming Measurements	14-9
How to make a 1-Port Cable Trimming Measurement	14-9
2-Port Transmission Measurements	14-11
How to make a 2-Port Transmission Measurement	14-11
15. Channel Scanner (SA Only and Option 312)	
Using Channel Scanner	15-1
How to Set Up Channel Scanner	15-2
How to Define a Channel and Use Channel Scanner	15-4
16. Data Analysis Features	
All about Markers	16-2
How to create Markers	16-2
How to move a Marker after it is created	16-2
About Delta Markers	16-3
Marker Table	16-4
Coupled Markers (NA Mode)	16-5
Marker Colors	16-6
Marker Trace (CAT and NA Modes)	16-6
Marker Trace (SA Mode)	16-6
Marker Format	16-7
Searching with Markers	16-7
What Is a 'Peak'	16-10
Marker Functions	16-12
SA Marker Functions	16-13
All about Limit Lines	16-14
How to Create Fixed Limit Lines	16-14
Relative Limit Lines	16-15
Build From Trace	16-16
Limit Options	16-17
How to Save and Recall Limits	16-17
All about Trace Math	16-19
How to display data and memory traces	16-19
How to perform Trace Math	16-19
About Math Operations	16-20

17. File Management

Saving and Recalling Files.	17-2
Save Files.	17-2
Recall Files.	17-4
Set File Type and Select Device	17-5
Manage Files	17-7
Manage Folders.	17-8
Edit Keywords	17-9
Prefixes for Filenames	17-10
Printing.	17-11
How to print the current screen or a saved file	17-11

18. System Settings

Run/Hold	18-2
How to perform a single sweep while in Hold	18-2
Preset.	18-3
How to Preset the FieldFox.	18-3
User Preset.	18-3
How to set User Preset	18-4
How to recall User Preset	18-4
Volume Control	18-4
How to set FieldFox Volume Control	18-5
Display Settings.	18-5
Display Brightness.	18-5
Display Colors	18-5
Trace Width.	18-6
Title	18-6
Edit Keywords	18-7
Full Screen Mode.	18-7
Preferences	18-7
Quick Settings Table	18-7
Save and Reset Preferences	18-8
Language.	18-9
Startup Mode.	18-9
Battery Saver.	18-10
File folders	18-10
System Configuration	18-11
Options (Licensing)	18-11
GPS	18-12
Frequency Reference Source	18-15
Security Level	18-16

Date and Time, Format, and Time Zone Settings	18-16
LAN Settings.	18-18
Power ON	18-19
FieldFox Package Installer (N9912A units with serial number prefixes ≥ 5607 Only)	18-20
Service Diagnostics	18-22
System Information	18-22
19. Using the Mini-USB Port to send SCPI Commands and Queries (N9912A units with serial number prefixes ≥ 5607 Only)	
Mini-USB Connection to PC with IO Libraries	19-1
20. Working with the Lithium-Ion Battery	
Viewing the Battery Charge Status	20-1
Service Diagnostics–Battery Screen	20-2
Built-In Battery Gauge	20-2
Charging the Battery	20-3
Internal Charging with the AC/DC Adapter	20-3
Using the External Battery Charger (N9910X-872)	20-5
Reconditioning Battery.	20-6
Battery Care	20-6
Maximizing Battery Life	20-6
Lithium-Ion Battery Disposal	20-7
21. Safety Considerations	
For the FieldFox	21-2
For the AC/DC Adapter	21-4
For the External Battery Charger (N9910X-872).	21-6
For the Battery	21-6
Battery Protective Functions	21-7
Active Protection	21-7
Passive Protection	21-8
Batteries: Safe Handling and Disposal	21-9
Environmental Requirements	21-9
Electrical Requirements	21-9
Electrostatic Discharge (ESD) Precautions	21-9
FieldFox Markings.	21-11
Battery Markings	21-12
Packaging Markings	21-13
AC/DC Adapter Markings.	21-13

Contents

Certification and Compliance Statements	21-14
Certification	21-14
Manufacturer's Declaration	21-14
Declaration of Conformity	21-14
EMC	21-15
Safety	21-15
South Korean Class A EMC Declaration	21-15
Acoustic Statement (European Machinery Directive)	21-15
A: Connector Care Review	A-1
B: Specifications/Data Sheet	B-3
C: Instrument Calibration	
How Often Should Calibrate My Instrument?	C-4
How do I Get an Instrument Calibration?	C-4
What Are My Choices of Instrument Calibration?	C-5
D: Korean Battery Safety Translation	D-2
E: Keysight Software End-User Licensing Agreement (EULA)	E-6

1 Overview

Options and Features

Table 1-1 Models

Options and Features	Learn more
<p>Cable and Antenna Test (CAT) Mode</p> <ul style="list-style-type: none"> – 2 MHz to 4 GHz (Option 104) – 2 MHz to 6 GHz (Option 106) <p>Measurements:</p> <ul style="list-style-type: none"> – Distance-to-fault (DTF) – DTF & Return Loss – Return Loss (dB) – VSWR – DTF (VSWR) – Cable Loss (1-Port) – Insertion loss (2-Port) (Option 110) 	CAT Mode on page 3-3
<p>Transmission Measurement (Option 110)</p>	CAT Mode on page 3-3 NA Mod on page 5-3
<p>QuickCal (Option 111)</p> <p>Built-in cal kit. Industry first!</p>	Cal on page page 3-3
<p>Spectrum Analyzer (SA) Mode</p> <p>General purpose measurements for basic monitoring and troubleshooting.</p> <ul style="list-style-type: none"> – 100 kHz to 4 GHz (Option 230) – 100 kHz to 6 GHz (Option 231) – Preamplifier for Spectrum Analyzer (Option 235) – Interference Measurements (Option 236) 	SA Mode on page 8-4 On page 8-11 On page 9-1
<p>Channel Power Meter Mode (Option 311)</p> <p>No Power Meter required</p>	On page 10-1

Table 1-1

Models

Options and Features	Learn more
<p>Power Meter Mode (Option 302)</p> <p>Use with Keysight External USB Power Sensors</p>	<p>Power Meter Mode on page 11-1</p>
<p>Network Analyzer (NA) Mode (Option 303)</p> <ul style="list-style-type: none"> – 2 MHz to 4 GHz (Option 104) – 2 MHz to 6 GHz (Option 106) – Vector 1-port (Standard) – Scalar 2-port (Option 110) <p>Measurements:</p> <ul style="list-style-type: none"> – S11 Reflection (several formats) – S21 Transmission (several formats) (Option 110) – A receiver – R receiver 	<p>NA Mode on page 5-1</p>
<p>Vector Voltmeter (VVM) Mode (Option 308)</p> <p>Measure electrical length</p> <p>Measurements:</p> <ul style="list-style-type: none"> – 1-Port Cable Trimming (Mag and Phase) – 2-Port Transmission (Magnitude only) 	<p>VVM Mode on page 14-1</p>
<p>Designed for Field Environment</p> <ul style="list-style-type: none"> – Lightweight 6.2 lbs (2.8 kg) including battery – Rugged, weather resistant shell with no fan/vents – Daylight viewable 6.5" (16.5 cm) color LCD – Backlit keys for night use – Integrated kickstand – Configurable hand and shoulder straps – Softcase for carrying all gear – Quick Reference Guide with laminated pages 	
<p>Slots for removable USB Flash Drive and standard Card</p>	<p>Save / Recall on page 17-2</p>

Table 1-1

Models

Options and Features	Learn more
<ul style="list-style-type: none"> – Expands internal storage – Useful for file transfer – Flash Drive and standard SD Card not included – FieldFox release 4.0 supports standardSDHC (high-capacity) Card 	
<p>Battery or AC Power</p> <ul style="list-style-type: none"> – Rechargeable Li-Ion battery with ~4 hr life – easily removable battery – AC/DC adapter – External battery charger (N9910X-872) 	<p>On page 14-1</p>
<p>FieldFox Data Link Software</p> <ul style="list-style-type: none"> – Easily manage files and compile reports – Reads data from the FieldFox and plots traces – Help file included with the software installation – Download the latest version of the software at http://www.keysight.com/find/fieldfox 	
<p>Additional Features</p> <p>Menus localized to 7 languages</p>	<p>Languages on page 18-9</p>

Accessories

The following accessories are included with every FieldFox*. Spare accessories can be ordered at any time.

Table 1-2 Accessories

Accessory Part Number	Description
N9910X-873	AC/DC Adapter (except for US/Canada)
N9910X-870	Lithium-Ion Battery
N9910X-877	AC/DC Adapter for US / Canada only
N9910X-880	Soft-case w/ Backpack & Shoulder Strap
N9910X-890	User's Guide (printed copy)

Table 1-2 Accessories

Accessory Part Number	Description
N9910X-891	Quick Reference Guide (printed copy)

NOTE

Although not supplied, a USB keyboard CAN be used with the FieldFox.

To see a complete list of accessories that are available for the FieldFox, please visit: <http://www.keysight.com/find/fieldfox>.

FieldFox Manuals, Software, and Supplemental Help

The following manuals and software are available for the FieldFox. For the very latest versions, please visit the FieldFox support website at: www.keysight.com/find/fieldfoxsupport

Check the manual revision on the last page of each manual.

- **User’s Guide** – This manual, included with shipment.
- **Quick Reference Guide** – Printed copy with laminated pages for outdoor use included with shipment.
- **Supplemental Online Help** – Concepts and Reference information.
<http://na.support.keysight.com/fieldfox/help/SupHelp/FieldFox.htm>
- **FieldFox Data Link Software and Help** – Free download.
- **Service Guide** – Free download.
- **Firmware Updates** – Check to see if you have the latest FieldFox firmware.

Conventions that are used in the Manual

- **Hardkey** indicates a front panel button. The functionality of these buttons does not change.

The six Softkey menus change dynamically and follow these color conventions:

- **Softkey** Blue indicates an available setting.
- **Softkey** Green indicates a change in menu level when selected.
- **Softkey** Black indicates the default or selected setting.
- **Softkey** Yellow indicates an active entry in process.
- **Softkey** Grey indicates a key that is NOT available.

Safety Notes

The following safety notes are used throughout this manual. Familiarize yourself with each of the notes and its meaning before operating this instrument. More pertinent safety notes for using this product are located in [Chapter 21, “Safety Considerations”, on page 21-1](#).

CAUTION

Denotes a hazard. It calls attention to a procedure that, if not correctly performed or adhered to, would result in damage to or destruction of the product. Do not proceed beyond a caution note until the indicated conditions are fully understood and met.

WARNING

Denotes a hazard. It calls attention to a procedure which, if not correctly performed or adhered to, could result in injury or loss of life. Do not proceed beyond a warning note until the indicated conditions are fully understood and met.

2 Preparing for Initial Use of Your New FieldFox

Check the Shipment

When you receive your FieldFox, check the shipment according to the following procedure:

1. Inspect the shipping container for damage. Signs of damage may include a dented or torn shipping container or cushioning material that indicates signs of unusual stress or compacting. If not damaged, save the packaging material in case the FieldFox needs to be returned
2. Carefully remove the contents from the shipping container, and verify that the standard accessories and your ordered options are included in the shipment according to the Box Contents List
3. For any question or problems, refer to **“Contacting Keysight”**.

Meeting Power Requirements for the AC/DC Adapter

Voltage:	100 VAC to 250 VAC
Frequency:	50 Hz to 60 Hz
Current:	1.25 A (100 VAC) to 0.56 A (250 VAC)

The AC/DC adapter supplied with the analyzer is equipped with a three-wire power cord, in accordance with international safety standards. The power cable appropriate to the original product shipping location is included with the FieldFox.

Various AC power cables are available from Keysight that are unique to specific geographic areas. You can order additional AC power cables that are correct for use in different areas. For the power cord part number information please visit: <http://www.keysight.com/find/fieldfox>

Install the Lithium-Ion Battery



Step	Notes
1. Open the battery door	Push the button on the battery compartment door while sliding the door outward.
2. Insert the battery.	The terminals end of the battery is inserted into the compartment.
3. Close the battery door.	Slide the battery compartment door upwards until it latches.

Battery Usage

When you receive your FieldFox, the lithium-ion battery is not installed, and it is partially charged to approximately 40% to preserve battery life. A lithium-ion battery has no memory effect, so it can be used partially charged, as shipped.

A fully charged battery will power your FieldFox for about four hours, so if you plan to use it for this long, you should fully charge the battery.

NOTE

The FieldFox will shut down to prevent the battery from discharging to a level that is damaging. If this occurs, charge the battery either internally or externally.

Learn more about the lithium-ion battery in [Chapter 20, “Working with the Lithium-Ion Battery”](#).

Battery charge status is viewable:

-  In the upper-right corner of the screen.
- On the Battery screen. To access the screen, select **System**, **Service**, **Diagnostics**, and **Battery**.

- On the battery. Open the FieldFox battery compartment door to view the battery LCD.

To conserve battery power:

- Use **Run/Hold** to single-trigger a measurement when needed. **Hold** is shown on the display.
- Press **System** then **Display** then **Brightness**. Use the **▲▼** arrows, the rotary knob, or numeric keypad to adjust the brightness to dim the FieldFox display as much as possible.
- Briefly press the power button to switch to Standby mode when the FieldFox is not being used. Press again to restore power. All current settings are preserved.

NOTE

When powered by the battery only, the FieldFox can stay in Standby mode for a maximum of four hours and then it powers off automatically. When the relative battery charge drops by about 20%, the FieldFox will power off to preserve the remaining charge.

To recharge a battery:

Use ONLY a FieldFox charger to recharge a battery.

- The battery can be fully charged while in the FieldFox in about 4 hours with the FieldFox either ON or OFF.
- The battery can be fully charged externally using the external battery charger (Opt 872) in about 4 hours.
- When the battery is removed, the FieldFox can still be powered by the AC/DC adapter.

FieldFox ON/OFF Settings

NOTE

The FieldFox power button shut down/standby sequence includes a 10 second counter that allows you to either choose a softkey to immediately initiate the action (**Standby**/**Shut down**/**Restart***), or to let the countdown counter expire after 10 seconds then perform the action.

*Restart can only be enabled via the **Restart** softkey.

- To turn power **ON**, briefly press the power button. Boot-up takes about 1 minute.
- To switch to **Standby** mode (low battery drain), briefly press the power button. See the Note above concerning Stand By.

Preparing for Initial Use of Your New FieldFox FieldFox High Temperature Protection

- To turn Power **OFF** (very low battery drain), press and hold the power button. Data and instrument state are NOT automatically saved when the FieldFox is powered OFF. Learn how to save data and instrument state in [Chapter 17, “File Management”, on page 17-1](#). See the Note above concerning Shut down.
- To restart FieldFox, press the power button and press **Restart**. See the **Note** above concerning Restart.
- Press **Cancel** to exit the power down sequence.
- You can also access the power down softkey menu choices (**Stand by**, **Shut down**, **Restart**, and **Cancel**) by using the **Mode** hardkey:
- Press **Mode**.
 - Then **More**.
 - Then **Shut down**.
- You can make a setting to automatically **Power ON** the FieldFox when a power source is connected. Learn how on [“Power ON” on page 18-19](#).

Power Button LED Status

Solid green	Power is ON
Blinking green	FieldFox in Stand By mode
Blinking amber	Battery charging
Blinking amber and green	Stand By mode and battery charging
Not lit	Power is Off and battery is not charging

FieldFox High Temperature Protection

The following features prevent degradation or damage in the event of high internal temperatures in the FieldFox.

NOTE

Do NOT store the FieldFox in the soft-case while powered ON or in Standby mode.

How to monitor the internal FieldFox temperature:

- Press **System**, then **Service Diagnostics**.
- Then **Internal Temperatures**.

- The temperature at which the following events occur is the average of the RF1, RF2, SB1, SB2 temperatures. These temperatures come from internal sensors embedded within FieldFox.

Temperature Control Mode

At approximately 73°C, the FieldFox enters Temperature Control mode by reducing display intensity and measurement speed. This should decrease the internal temperature which preserves measurement accuracy and maintains the long-term reliability of the FieldFox.

When entering Temperature Control mode, save your instrument state and data that you want to keep.

When the temperature drops to approximately 71°C, normal operating settings are restored.

NOTE

Measurement speed specifications do NOT apply in Temperature Control Mode.

High-Temp Shut down

In extreme situations, Temperature Control mode may not stop an increase in the FieldFox internal temperature. At approximately 75°C, High-Temperature Shut down will engage and turn OFF the FieldFox.

Just prior to shut down, the FieldFox will display a warning of imminent shut down.

Avoid Overpowering the FieldFox

The FieldFox can be damaged with too much power or voltage applied. Exceeding the maximum RF power levels shown below will cause an ADC Over Range message to appear on the screen.

CAUTION

Maximum Input Voltages and Power:

- RF OUT Connectors: ± 50 VDC, +23 dBm RF
 - RF IN: ± 50 VDC, +27 dBm RF
 - DC Input: 19 VDC, 4 ADC
 - Learn more about Maximum power and voltages in the FieldFox Data Sheet on [page B-3](#).
-

NOTE

Very often, coaxial cables and antennas build up a static charge, which, if allowed to discharge by connecting to the FieldFox, may damage the instrument input circuitry. To avoid such damage, it is recommended to dissipate any static charges by temporarily attaching a short to the cable or antenna prior to attaching to the FieldFox.

Take the FieldFox Tour

Front Panel

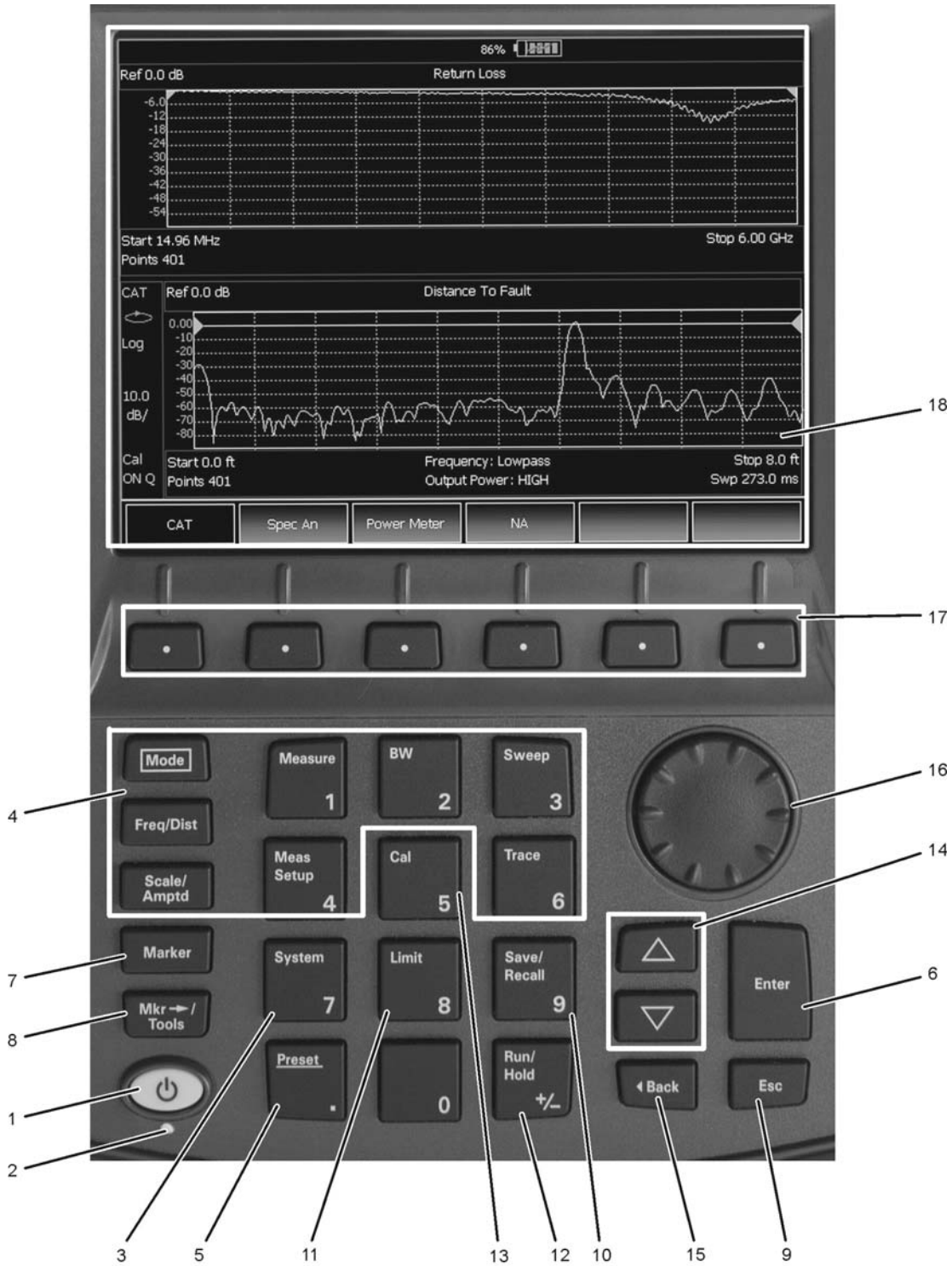

N9912_001_401

Preparing for Initial Use of Your New FieldFox
Take the FieldFox Tour

No.	Caption	Description	Learn More:
1	Power	ON: press momentarily. STAND BY: with FieldFox power ON, press briefly. OFF: press and hold until the FieldFox shuts off (about 4 seconds).	“FieldFox ON/OFF Settings” on page 2-3
2	LED	Not lit: FieldFox OFF, not charging Green: FieldFox ON. Charging status indicated by battery icon on screen Orange, flashing: FieldFox STAND BY Orange, intensity increasing, flashing slowly: FieldFox OFF, charging	“Power Button LED Status” on page 2-4
3	System	Displays a sub-menu for system setup	Chapter 18, “System Settings”, on page 18-1
4	Function keys	Includes: Freq/Dist , Scale/Amptd , BW , Sweep , Trace , Meas Setup , Measure , and Mode .	Refer to specific Mode.
5	Preset	Returns the analyzer to a known state	“How to Preset the FieldFox” on page 18-3
6	Enter	Confirms a parameter selection or configuration	--
7	Marker	Activates marker function	“All about Markers” on page 16-2
8	Mkr-->Tools	Displays a sub-menu for marker functions	“All about Markers” on page 16-2
9	Esc	Exits and closes the dialog box or clears the character input	--
10	Save/Recall	Saves the current trace or recalls saved data from memory	“Saving and Recalling Files” on page 17-2

Preparing for Initial Use of Your New FieldFox
Take the FieldFox Tour

No.	Caption	Description	Learn More:
11	Limit	Sets limit lines for quick Pass/Fail judgment	“All about Limit Lines” on page 16-14
12	Run/Hold	Toggles between free Run and Hold/Single operation.	“Run/Hold” on page 18-2
13	Cal	Displays a sub-menu for calibration functions	“Calibration Method Summary” on page 7-11
14	Arrow keys	Increases or decreases a value or setting.	--
15	◀Back	Returns to the previous menu selection.	--
16	Rotary knob	Highlights an item for selection, or enables incremental changes to values.	--
17	Softkeys	Allows selection of settings for configuring and performing measurements, and for other FieldFox functions.	--
18	Screen	Transflective screen, viewable under all lighting conditions. If you are using your FieldFox in direct sunlight, you do not need to shield the display from the sunlight. In bright lighting conditions, the display is brighter and easier to read when you allow light to fall directly on the screen. Alternative color modes exist that maximize viewing in direct sunlight conditions, as well as other conditions such as nighttime work.	“Screen Tour” on page 2-12

NOTE

Clean the Transflective screen with gentle and minimal wiping using Isopropyl alcohol applied to a lint-free cloth.



Top Panel







Caption	Descriptions	Learn More:
RF Output	For CAT and NA measurements, use to make reflection measurements. Maximum: ± 50 VDC, +23 dBm RF	“CAT Mode Settings” on page 3-3 “NA Mode Settings” on page 5-3
Ext Trig/Ext Ref	External Reference connector to connect to an external frequency reference. Maximum: 5.5 VDC.	“SA Mode Settings” on page 8-4
RF In	For CAT and NA mode, use to make transmission measurements. For SA use to make all measurements. Maximum: ± 50 VDC, +27 dBm RF.	“Frequency Reference Source” on page 18-15 “Triggering” on page 8-25

Side Panel



Connector	Description	Learn More
	<p>Ethernet cable connector to read trace data using the FieldFox Data Link Software and connect to the FieldFox remotely.</p> <p>Download the latest version of the software at: www.keysight.com/find/fieldfoxsupport</p>	
	<p>On the N9912A units with serial number prefixes ≥ 5607, the mini-USB port can be connected to your PC's standard USB port to send SCPI commands.</p>	<p>Chapter 19, “Using the Mini-USB Port to send SCPI Commands and Queries (N9912A units with serial number prefixes ≥ 5607 Only)”, on page 19-1</p>

Preparing for Initial Use of Your New FieldFox
Take the FieldFox Tour

Connector	Description	Learn More
	DC power connector used to connect to the AC/DC adapter. Maximum: 19 VDC, 4 ADC.	“Triggering” on page 8-25
	Micro Secure Digital slot. Use to extend the memory of the FieldFox.	“Saving and Recalling Files” on page 17-2
	Standard USB connector used to connect a power sensor for Power Meter Mode. Also used to save files to a USB flash drive. Use of Keyboard and Mouse is NOT supported.	--
	Audio output jack for use with SA Mode Tune and Listen.	“Saving and Recalling Files” on page 17-2

Screen Tour

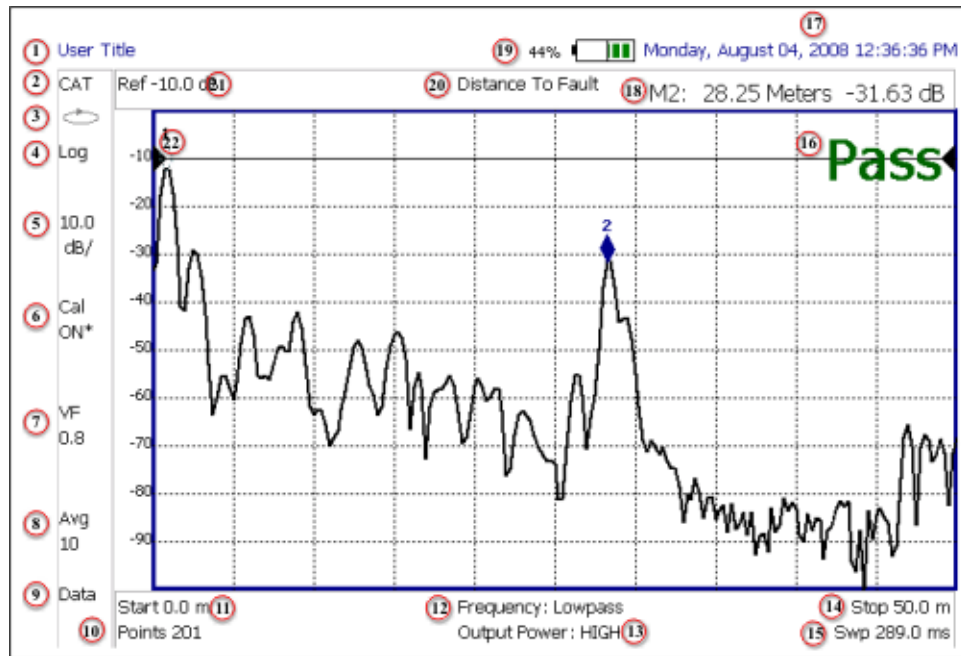

Caption	Description	Learn More:
1	Title – write your own text here	“Title” on page 18-6
2	Current Mode	--
3	Run / Hold	“Run/Hold” on page 18-2
4	Display Format	Mode dependent
5	Scale/division	Mode dependent
6	Calibration Status (CAT and NA) Detection Method (SA)	“Cal ON ? – Questionable Accuracy” on page 7-8
7	Velocity Factor (Fault Meas)	“About Velocity Factor and Cable Loss” on page 4-22
8	Averaging Status and Count	Mode dependent
9	Data / Mem Display (CAT and NA) Step / FFT (SA)	“All about Limit Lines” on page 16-14 “Resolution Bandwidth (Res BW)” on page 8-20
10	Resolution Setting	Mode dependent
11	Measurement Start Freq or Distance	Mode dependent

Preparing for Initial Use of Your New FieldFox
Take the FieldFox Tour

Caption	Description	Learn More:
12	Bandpass / Lowpass setting (Fault Meas) IF BW in NA Mode	“DTF Measurement Settings” on page 4-19
13	Output Power Level (CAT and NA)	“Output Power” on page 3-9
14	Measurement Stop Freq or Distance	Mode dependent
15	Actual Sweep Time	Mode dependent
16	Limit Line Status	“All about Limit Lines” on page 16-14
17	Time and Date	“Date and Time, Format, and Time Zone Settings” on page 18-16
18	Marker Readout	“All about Markers” on page 16-2
19	Battery Status	“Viewing the Battery Charge Status” on page 20-1
20	Measurement Type (CAT and NA)	--
21	Reference Level	Mode dependent
22	Reference Position	Mode dependent

How to Enter Numeric Values

Many settings on the FieldFox require the entry of numeric values.

How to enter numeric values

Use any combination of the following keys:

- Numeric 0–9 keys, along with the polarity (+/-) key.
- Up/Down arrow keys to increment or decrement values.
- Rotary knob to scroll through a set of values.
- **Back** erases previously entered values.
- **Esc** exits data entry without accepting the new value.

To complete the setting, press **Enter** or a different **softkey** or **hardkey**.

Multiplier Abbreviations

Many times after entering numeric values, a set of multiplier or suffix softkeys are presented. The following explains the meaning of these abbreviations.

Select Frequency multipliers as follows:

- **GHz** Gigahertz (1e9 Hertz)
- **MHz** Megahertz (1e6 Hertz)
- **KHz** Kilohertz (1e3 Hertz)
- **Hz** Hertz

Select Time multipliers as follows:

- **s** Seconds
- **ms** milliseconds (1e-3)
- **us** microseconds (1e-6)
- **ns** nanoseconds (1e-9)
- **ps** picoseconds (1e-12)

Connector Care

- Never store connectors, airlines, or calibration standards loose in a box. This is a common cause of connector damage.
- Install protective end caps when connectors are not in use.
- Keep connector temperature the same as the test instrument. Holding the connector in your hand or cleaning connector with compressed air can significantly change the temperature. Wait for connector temperature to stabilize before using in calibration or measurements.
- Do not touch the mating plane surfaces. Natural skin oils and microscopic particles of dirt are difficult to remove from these surfaces.
- Do not set connectors contact-end down on a hard surface. The plating and mating plane surfaces can be damaged if the interface comes in contact with any hard surface.
- Wear a grounded wrist strap and work on a grounded, conductive table mat. This helps protect the analyzer and devices from electrostatic discharge (ESD).
- Refer to **“Connector Care Review” on page A-1**.

CAUTION

Because of the very small and precise mechanical tolerances of mmWave connectors, minor defects, damage, and dirt can significantly degrade repeatability and accuracy. In addition, a dirty or damaged connector can destroy connectors that are mated to it. For this reason, NEVER use a damaged connector. See also

http://na.support.keysight.com/pna/connectorcare/Connector_Care.htm

Preparing for Initial Use of Your New FieldFox
Connector Care

3 CAT (Cable and Antenna Test) Mode

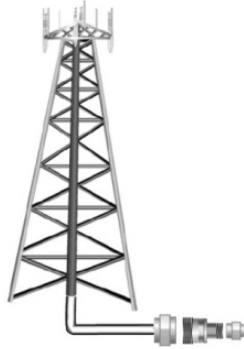

CAT Mode is typically used to test an entire transmission system, from the transmitter to the antenna. This process is sometimes referred to as Line Sweeping.

CAT Mode is similar to NA (Network Analyzer) Mode. Learn more in the Supplemental Online Help:

<http://na.support.keysight.com/fieldfox/help/SupHelp/FieldFox.htm>

CAT Mode Distance to Fault measurements are discussed in **Chapter 4, "DTF (Distance to Fault) Measurements."**

In this Chapter

"Measurement Selection" on page 3-3

"Quick Settings Table" on page 3-4

"Frequency Range" on page 3-5

"Scale Settings" on page 3-5

"Averaging" on page 3-6

"Smoothing" on page 3-7

"Single or Continuous Measure" on page 3-7

"Resolution (Number of Data Points)" on page 3-8

"Sweep Time" on page 3-8

"Output Power" on page 3-9

"Interference Rejection" on page 3-10

"Coupled Frequency" on page 3-11

Procedures

“Return Loss Measurements” on page 3-12

“1-Port Cable Loss Measurements” on page 3-12

“2-Port Insertion Loss Measurements” on page 3-14

“DTF (Distance to Fault) Measurements” on page 4-17

See Also

“Calibration for NA, CAT, and VVM Modes” on page 7-1

“All about Markers” on page 16-2

“All about Limit Lines” on page 16-14

“All about Trace Math” on page 16-19

Making 75 Ω (ohm) Measurements at the FieldFox Supplemental Online Help:
<http://na.support.keysight.com/fieldfox/help/SupHelp/FieldFox.htm>

CAT Mode Settings

Select CAT Mode before making any setting in this chapter.

How to select CAT Mode

- Press **Mode**.
- Then **CAT**.

Measurement Selection

How to select a CAT Mode Measurement

Learn more about the following measurements in the Supplemental Online Help: <http://na.support.keysight.com/fieldfox/help/SupHelp/FieldFox.htm>

Press **Measure 1**.

Then choose one of the following: These softkeys also appear after CAT Mode is selected.

- **Distance To Fault** 1-port reflection measurement that uses Inverse Fourier Transform (IFT) calculations to determine and display the distance to, and relative size of, a fault or disruption in the transmission line. Units are in return loss format, expressed as a positive number in dB, unless the measurement selected is DTF (VSWR). Learn more about DTF Measurements refer to **Chapter 4, “DTF (Distance to Fault) Measurements.”**
- **Return Loss & DTF** Displays both a Return Loss measurement and a DTF measurement. Use this format to display the frequency settings that are used to make the DTF measurement. The frequency range settings for these two measurements can be coupled or uncoupled. Learn more on **page 3-11**.

Calibrations are applied to both traces

When in Hold mode and Single sweep is performed, only the active trace is triggered. Use the **▲▼** arrows to activate a trace

- **Return Loss** 1-port reflection measurement that displays the amount of incident signal energy MINUS the amount of energy that is reflected. The higher the trace is on the screen, the more energy being reflected back to the FieldFox. Learn how to measure Return Loss in **“Return Loss Measurements” on page 3-12**.
- **VSWR** (Voltage Standing Wave Ratio – also known as SWR) 1-port reflection measurement that displays the ratio of the maximum reflected voltage over the minimum reflected voltage. The higher the trace is on the screen, the more energy being reflected back to the FieldFox.
- **DTF (VSWR)** Distance to Fault in VSWR format.

- **Cable Loss (1-Port)** 1-port reflection measurement that displays the loss of a transmission line. Learn more on [page 3-12](#).
- **Insertion Loss (2-Port)** (Option 110 ONLY) 2-port transmission measurement that accurately displays the loss through a cable or other device in dB. Both ends of the cable must be connected to the FieldFox. NO phase information is included in this measurement. Learn more at [“2-Port Insertion Loss Measurements” on page 3-14](#).
- **DTF (Lin)** Distance to Fault in Linear format.
- **TDR (Lin rho)** The Y-axis of the display is linear, real, unitless values. A trace without reflections shows as 0 (zero). Maximum reflections from an open or short show as 1.
- **TDR (ohm)** The Y-axis of the display is impedance (ohms).
- **TDR & DTF** TDR and DTF are displayed.

Quick Settings Table

Both CAT and NA Modes allow you to view and change most relevant settings from a single location. All of these settings are discussed in this chapter and, unless otherwise noted, ALL of these settings can also be made using the standard softkey menus.

How to view and change Quick Settings

- Press **Meas Setup 4**.
- Then **Settings**.
- Press **Next Page** and **Previous Page** to view all settings. If these softkeys are NOT available, then all available settings fit on one page.
- To change a setting:
 - Use the **▲▼** arrows to highlight a setting.
 - Then press **Edit**. The current setting changes to **yellow**.
 - Some settings require you to press a softkey to change the value. Otherwise, use the numeric keypad, **▲▼** arrows, or rotary knob to change the value.
 - When finished changing a value, press **Done Edit**.
- Press **Dock Window** to relocate the Settings table to a position relative to the trace window. The Dock Window setting persists through a Preset. Choose from the following
 - **Full** (Default setting) Only the Settings table is shown on the screen. The trace window is temporarily not shown
 - **Left** The Settings table is shown to the left of the trace window

- **Bottom** The Settings table is shown below the trace window
- When finished changing ALL settings, press **Done** to save your settings

Frequency Range

Set the range of frequencies over which you would like to make CAT Mode measurements.

When the frequency range is changed after a calibration is performed, the cal becomes interpolated. Learn more in [“Interpolation” on page 7-7](#).

How to set Frequency Range

- Press **Freq/Dist**.
- Then choose from the following
 - **Start** and **Stop** frequencies - beginning and end of the sweep.
 - **Center** and **Span** frequencies - the center frequency and span of frequencies (half on either side of center).
- Follow each setting by entering a value using the numeric keypad, **▲▼** arrows, or the rotary knob.
 - After using the keypad, select a multiplier key. Learn about multiplier abbreviations in [Chapter 2, “Multiplier Abbreviations.”](#)
 - After using the **▲▼** arrows or the rotary knob, press **Enter**. The amount of frequency increment is based on the current span and can NOT be changed in CAT Mode.

Scale Settings

Adjust the Y-axis scale to see the relevant portions of the data trace. The Y-axis is divided into 10 graticules.

This setting can be changed at any time without affecting calibration accuracy.

How to set Scale

- Press **Scale / Amptd**.
- Then choose from the following three methods:
 1. **Autoscale** Automatically adjusts the Y-axis to comfortably fit the Min and Max amplitude of the trace on the screen.
 2. **Autoscale All** Autoscales all of the traces on the screen, useful only for dual-trace configurations.
 3. Set Scale, Reference Level, and Reference Position:

- **Scale** Manually enter a **scale per division** to view specific areas of the trace.
 - **Ref Level** Manually set the value of the reference line. Enter a negative value by pressing **Run/Hold (+/-)** either before or after typing a value.
 - **Ref Position** Manually set the position of the reference line. Values must be between **0 (TOP line)** and **10 (BOTTOM line)**.
4. Set Top and Bottom graticule values. The scale per division is calculated.
- **Top** to set the value of the Top graticule.
 - **Bottom** to set the value of the Bottom graticule.
 - Enter a negative value by pressing **Run/Hold (+/-)** either before or after typing a value.

Scale annotation on the FieldFox screen

Reference Line = red arrow

Ref Level = -40 dB

Ref Position = 1

Scale = 2 dB per division

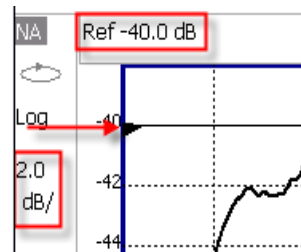

Averaging

Trace Averaging helps to smooth a trace to reduce the effects of random noise on a measurement. The FieldFox computes each data point based on the average of the same data point over several consecutive sweeps.

Average Count determines the number of sweeps to average; the higher the average count, the greater the amount of noise reduction.

An average counter is shown in the left edge of the screen as **Avg N**. This shows the number of previous sweeps that have been averaged together to form the current trace. When the counter reaches the specified count, then a 'running average' of the last **N** sweeps is displayed. Average Count = 1 means there is NO averaging.

This setting can be changed at any time without affecting calibration accuracy.

NOTE

Averaging is often used to increase the dynamic range of a measurement. To achieve the highest dynamic range, select NA mode and reduce the IF Bandwidth setting. Learn more about dynamic range in [“Increase Dynamic Range” on page 5-20](#).

How to set Trace Averaging

- Press **BW 2**.
- Then **Average N** where **N** is the current count setting.
- Enter a value using the numeric keypad. Enter 1 for NO averaging.
- Press **Enter**.
- While Trace Averaging is in process, press **Sweep 3** then **Restart** to restart the averaging at 1.

Smoothing

Trace smoothing averages a number of adjacent data points to smooth the peak-to-peak noise values on a displayed trace. The number of adjacent data points that are averaged is known as the smoothing aperture. Aperture is set by specifying a percentage of the X-axis span.

Trace smoothing does NOT significantly increase measurement time.

Smoothing can be used with any CAT format.

When enabled, **Smo** appears on the FieldFox screen.

How to set Smoothing

- Press **BW 2**.
- Then **Smoothing ON OFF**.
- Then **Sm. Aperture** and enter a value between 0 and 25 (percent) using the numeric keypad.
- Press **Enter**.

Single or Continuous Measure

This setting determines whether the FieldFox sweeps continuously or only once each time the **Single** button is pressed. Use **Single** to conserve battery power or to allow you to save or analyze a specific measurement trace.

This setting can be changed at any time without affecting calibration accuracy.

How to set Single or Continuous

- Press **Sweep 3**.

- Then choose one of the following:
 - **Single** Automatically sets Continuous OFF and causes FieldFox to make ONE sweep, then hold for the next Single key press. Hold is annotated in the upper left corner of the display when NOT sweeping, and changes to an arrow --> while the sweep occurs
 - **Continuous** Makes continuous sweeps. This is the typical setting when battery power is not critical.

You can also use **Run / Hold +/-** to toggle between Single and Continuous.

Resolution (Number of Data Points)

Data points are individual measurements that are made and plotted across the X-axis to form a trace. Select more data points to increase measurement resolution. However, more data points require more time to complete an entire measurement sweep

When the Resolution is changed after a calibration is performed, the cal becomes interpolated. Learn more in **“Interpolation” on page 7-7**.

How to set Resolution

- Press **Sweep 3**.
- Then **Resolution**.
- Then choose one of the following:
101 | 201 | 401 | 601 | 801 | 1001 | 1601 | 4001 | 10001.
- Using SCPI, Resolution can be set to any number of points between 3 and 10001. See the Programming Guide at <http://na.support.keysight.com/fieldfox/help/>

Sweep Time

The fastest possible sweep time is always used as the default setting. Use the **Min Swp Time** setting to slow the sweep time when measuring long lengths of cable.

Learn more in the FieldFox Supplemental Help at:

<http://na.support.keysight.com/fieldfox/help/SupHelp/FieldFox.htm>

The actual sweep time is shown on the FieldFox screen. See **“Take the FieldFox Tour” on page 2-7**. To increase the sweep time, enter a value that is higher than the actual sweep time. The increase will not be exactly the amount that you enter, as the actual sweep time is the composite of many factors.

NOTE

Measurement speed specifications do NOT apply in Temperature Control Mode. Learn more in **“FieldFox High Temperature Protection” on page 2-4**.

How to set Sweep Time

- Press **Sweep 3**.
- Then **Min Swp Time**.
- Enter a value using the numeric keypad.
- Press a multiplier key. Learn more in [“Multiplier Abbreviations” on page 2-14](#).

Output Power

Set the power level out of the FieldFox to High, Low, or manually set power level to a value between High and Low.

Generally, the high power setting is used when measuring passive, high-loss devices to place the signal farther from the noise floor. However, for devices that are sensitive to high power levels such as amplifiers, use the Low power setting.

For best measurement accuracy, use the Manual power setting at -15 dBm. After calibration, the power level can be decreased for amplifiers, or increased for higher dynamic range.

CAUTION

Power Level settings in this mode will NOT change Power Level settings in other modes. To help prevent damage to your DUT, use caution when changing modes with your DUT connected to the FieldFox test ports.

How to set Output Power

- Press **Meas Setup 4**.
- Then **Power**.
- Then **Output Power**.
 - **High** (Default setting) Sets output power to the maximum achievable power at all displayed frequencies. Please see [“Specifications/Data Sheet” on page B-3](#) for expected power levels.
 - **Low** Sets output power to approximately -27 dBm,
 - **Man** Set output power to an arbitrary value,
 - Then press **Nominal Power**.
 - Then enter a value using the numeric keypad, the **▲▼** arrows, or the rotary knob.

- Press **Enter**.

NOTE

Nominal here means: a general, descriptive term or design parameter. It is not tested and not covered by the product warranty.

In FieldFox's with FW <A.08.15, the Nominal Output displayed on the bottom right side of the display indicates a range of low and high power values. Your actual measured output power could be a little lower or a little higher. Refer to [Figure 3-1](#).

If you have the USB power sensor feature (Option 302) you can measure the actual output power for your measurement. Refer to page [Chapter 11, "Power Meter Mode \(Option 302\)."](#)

Figure 3-1

Nominal Output Power



Interference Rejection

Use this setting when you suspect that other signals in the area are interfering with a measurement. Interference may look like a spike or lack of stability in the measurement trace. While monitoring a measurement at a specific frequency, toggle this setting between ON and OFF. If the measurement result decreases while ON, then there is an interfering signal in the area. Continue to make measurements with Interference Rejection ON. However, this will slow the measurement speed.

Once enabled, up to SIX sweeps may be required before the interfering signal is neutralized.

This setting can be changed at any time without affecting calibration accuracy.

How to set Interference Rejection

- Press **Meas Setup 4**.
- Then **Interference Rejection [current setting]**.
- Then choose from the following:
 - **Off** No interference rejection and fastest possible sweep speed
 - **Minimum** The lowest level of Interference rejection.
 - **Medium** The medium level of Interference rejection.

- **Maximum** The highest level of Interference rejection.

Coupled Frequency

This setting, especially useful for a Return Loss & DTF measurement, allows both measurements to have different frequency ranges.

How to set Coupled Frequency

With a Return Loss & DTF measurement present:

- Press **Meas Setup 4**.
- Select the DTF measurement (Tr2) using the  arrows.
- Then choose from the following:
 - **Coupled Freq ON** - Both the Return Loss and DTF traces have the same frequency range settings.
 - **Coupled Freq OFF** (default setting) - Both traces are allowed to have individual frequency range settings. When set to OFF:
 - The Return Loss measurement frequency settings are made in the usual manner. Learn how at **“Frequency Range” on page 3-5**. When a new Start or Stop frequency is selected, Coupled Frequency is automatically set to OFF.
 - The DTF measurement is made using the frequencies as determined by the **DTF Frequency Mode** setting. Learn more in **“DTF Measurement Settings” on page 4-19**.

Return Loss Measurements

Return loss can be thought of as the absolute value of the reflected power compared to the incident power.

When measuring an OPEN or SHORT, all incident power is reflected and approximately 0 dB return loss is displayed.

When measuring a LOAD, very little power is reflected and values of 40 dB to 60 dB are displayed.

The minus sign is usually ignored when conveying return loss. For example, a component is said to have 18 dB return loss, rather than -18 dB.

How to Measure Return Loss

- Connect the jumper cable or any adapter used to connect the device under test (DUT).
- Select **Preset** then **Preset** Returns the FieldFox to known settings
- Select **Mode** then **CAT** (Cable and Antenna Test)
- Then **Return Loss** (Default measurement).
- Press **Freq/Dist** and enter **Start** and **Stop** frequency values of the measurement.
- Press **Meas Setup 4** then **Settings** to make appropriate settings before calibrating.
- Disconnect the jumper cable or DUT and press **Cal 5** then follow the calibration prompts.
- Reconnect the jumper cable or DUT.
- The return loss trace is displayed on the FieldFox screen.

1-Port Cable Loss Measurements

While all cables have inherent loss, weather and time will deteriorate cables and cause even more energy to be absorbed by the cable. This makes less power available to be transmitted.

A deteriorated cable is not usually apparent in a Distance to Fault measurement, where more obvious and dramatic problems are identified. A Cable Loss measurement is necessary to measure the accumulated losses throughout the length of the cable.

A 2-port Insertion Loss measurement is usually more accurate than a 1-port Cable Loss measurement. However, to perform a 2-port Insertion Loss measurement, both ends of the cable must be connected to the FieldFox, and the FieldFox must have option 110 installed.

NOTE

In high-loss conditions, a Cable Loss measurement becomes 'noisy' as the test signal becomes indistinguishable in the FieldFox noise floor. This can occur when measuring a very long cable and using relatively high measurement frequencies. To help with this condition, use High Power (page 3-9) and Averaging (page 3-6).

How to make a 1-port Cable Loss Measurement

1. Press **Preset** then **Preset..**
2. Then **More** then **Cable Loss (1-Port)**.
3. Connect the cable to be tested.
4. Press **Freq/Dist** and enter **Start** and **Stop** frequency values of the measurement.
5. Press **Sweep 3** then **Min Swp Time**. Increase the Sweep Time until a stable trace is visible on the screen. The amount of time that is required increases with longer cable lengths. Learn more in the **Supplemental Online Help**: <http://na.support.keysight.com/fieldfox/help/SupHelp/FieldFox.htm>
6. Remove the cable to be tested.
7. Press **Cal 5**, then **QuickCal** or **OSL**.
8. Follow the prompts to perform calibration at the end of the jumper cable or adapter. Learn more about Calibration in **Chapter 7, "Calibration for NA, CAT, and VVM Modes"**, on page 7-1.
9. Connect the cable to be tested.

NOTE

Low-level standing waves (also known as 'ripple') which may be visible in reflection measurements, can hide the actual loss of the cable. Steps 10 through 13 can minimize the ripple. Perform the measurement with and without steps 10 through 13 and choose the method with the least amount of ripple.

10. Connect a LOAD at the end of the cable to be tested. This limits the reflections to faults that are located in the cable under test.
11. Press **Trace 6** then **Math and Memory** then **Data->Mem** to store the trace into Memory.
12. Remove the LOAD and leave the end of the cable to be tested open.

13. Press **Data Math** then **Data – Mem**. The ripple in the measurement is removed. These minor imperfections in the cable should not be considered in the Cable Loss measurement.

14. Use **Averaging** to remove random noise from high-loss measurements. Press **BW 2** then **Average**.

The displayed trace shows the Cable Loss values in one direction through the cable. A Return Loss measurement would show the loss for both down the cable and back. Therefore, a Cable Loss measurement is the same as a Return Loss measurement divided by 2.

The average Cable Loss across the specified frequency range is shown on the screen below the graticules.

2-Port Insertion Loss Measurements

A 2-port Insertion Loss measurement, available with option 110, is used to measure the loss through a DUT (device under test) – or cable – over a specified frequency range. The FieldFox signal source is transmitted out the RF OUT connector, through the DUT, and into the RF IN connector. Both ends of the DUT must be connected to the FieldFox, either directly or indirectly using the cable used in the normalization cal.

‘Insertion’ loss simply means **loss** through a device, usually expressed in dB. It is exactly the same measurement as “S21 Transmission” in NA Mode.

2-port Insertion Loss measurements are generally more accurate than 1-port Cable Loss measurements.

NOTE

A Normalization Cal is REQUIRED for making accurate 2-port CAT or NA measurements. Learn **“Normalize” on page 7-6**.

For highest accuracy, when measuring the DUT also attach any cable or adapter that was used in the normalization cal.

How to make a 2-port Insertion Loss Measurement

- Press **Mode** then **CAT**.
- Then **More** then **Insertion Loss (2-Port)**.
- Press **Freq/Dist** and enter **Start** and **Stop** frequency values of the measurement.
- Press **Sweep 3**, then select a **Resolution** setting.
- Press **Cal 5**, then press **Normalization**. Learn more in **“Normalize” on page 7-6**.
- Connect the DUT and view the insertion loss measurement results.

CAT (Cable and Antenna Test) Mode
2-Port Insertion Loss Measurements

When measuring very long lengths of cable, it may be necessary to increase the sweep time. Learn how on [page 3-8](#). Learn why in the **Supplemental Online Help**:

<http://na.support.keysight.com/fieldfox/help/SupHelp/FieldFox.htm>

CAT (Cable and Antenna Test) Mode
2-Port Insertion Loss Measurements

4 DTF (Distance to Fault) Measurements

CAT Mode **Distance to Fault** (DTF) measurements are generally used to locate problems, or faults, in a length of cable or transmission line. In this chapter, the cable to be tested is referred to as the DUT (Device Under Test).

Settings that are NOT unique to DTF measurements are documented in the [Chapter 3, "CAT \(Cable and Antenna Test\) Mode."](#)

In this Chapter

["How to make DTF Measurements" on page 4-18](#)

["DTF Settings Table" on page 4-19](#)

["DTF Measurement \(Format\)" on page 4-19](#)

["DTF Start and Stop Distance" on page 4-20](#)

["Frequency Mode" on page 4-20](#)

["Coupled Frequency" on page 4-21](#)

["Cable \(Correction\) Specifications" on page 4-22](#)

["Window Settings" on page 4-25](#)

["DTF Units" on page 4-25](#)

["Calculated DTF values" on page 4-26](#)

["About Alias Faults" on page 4-26](#)

Optional settings

["All about Trace Math" on page 16-19](#)

["All about Limit Lines" on page 16-14](#)

["Saving and Recalling Files" on page 17-2](#)

Trace Math is NOT available in DTF Measurements.

How to make DTF Measurements

Before starting, you may need the following:

- Jumper cable or adapter to connect the beginning of the DUT to the FieldFox.
- LOAD with correct connector type and gender to terminate the end of the DUT (if possible).
- The known length and cable type of the DUT. If the cable type is not known, then the Cable Loss (dB/Meter) and Velocity Factor of the DUT are required.

1. Connect any necessary jumper cable or adapter to the FieldFox RF OUT port. Do NOT connect the DUT.
2. Press **Preset** then **Preset** to return the FieldFox to the default settings.
3. Then **Mode** then **CAT**.
4. Then **DTF**.
5. Press **Freq/Dist**, then **Stop Distance** and enter the length of the DUT. You can optionally set the Start Distance
6. Press **Cal 5** and follow the Cal prompts. Learn all about calibration in [Chapter 7](#).
7. Disconnect any components or antenna that should NOT be measured and connect a LOAD at the end of the DUT.
8. Press **Meas Setup 4** then **DTF Cable Specifications**.
9. Either press **Recall Coax Cable**, or enter **Velocity Factor** and **Cable Loss** of the DUT.
10. Connect the start end of the DUT to the FieldFox.
11. Press **Meas Setup 4** then **Settings** then **Next Page**. If the **Alias-free Range** setting is False, then you may see Alias faults on the screen. Learn more on [page 4-26](#).

DTF Measurement Settings

DTF Settings Table

You can set and view all of the DTF settings, including some calculated values, on the DTF Settings table. Learn about the calculated values in **“Calculated DTF values” on page 4-26.**

How to make settings on the DTF settings table

- Press **Meas Setup 4**.
- Then **Settings**.
- Press **Next Page** and **Previous Page** to view all settings.
- To change a setting:
 - Use the **▲▼** arrows or rotary knob to highlight a setting.
 - Numeric settings can be changed by pressing numbers using the numeric keypad. Then press Enter or select a suffix if available.
 - Other settings require you to press **Edit**, then press a softkey to change the value.
 - When finished changing a value, press **Done Edit**.
- Press **Dock Window** to relocate the Settings table to a position relative to the trace window. The Dock Window setting persists through a Preset. Choose from the following:
 - **Full (Default setting)** Only the Settings table is shown on the screen. The trace window is temporarily not shown.
 - **Left** The Settings table is shown to the left of the trace window.
 - **Bottom** The Settings table is shown below the trace window.
- When finished changing ALL settings, press **Done** to save your settings.

DTF Measurement (Format)

You can select from 3 different DTF Formats.

- Press **Measure 1**.
- Then choose from:
 - **Distance to Fault (dB)** Faults are displayed on the Y-axis in return loss format, expressed as a positive number in dB.
 - **DTF (VSWR)** Faults are displayed on the Y-axis in SWR. Learn more about SWR at the FieldFox Supplemental Online Help: <http://na.support.keysight.com/fieldfox/help/SupHelp/FieldFox.htm>

DTF (Distance to Fault) Measurements DTF Measurement Settings

- **More** then **DTF (Lin)** Faults are displayed on the Y-axis in linear (unitless) format.

DTF Start and Stop Distance

In DTF measurements, you set the physical length of cable or other device to be tested. The FieldFox calculates the frequency range of the measurement from this distance. The longer the cable to be tested, the lower the frequencies that are used. You can also set the frequencies manually using the Frequency Mode [Bandpass] setting.

How to set Start and Stop Distance

- With a DTF measurement present, press **Freq/Dist**.
- Then choose from the following:
 - **Start Distance** Enter a value using the numeric keypad, the **▲▼** arrows, or the rotary knob, then **Enter**. By default, the Start Distance is set to 0 Meters. This means that the measurement will display faults starting at the point at which calibration standards are connected.
 - **Stop Distance** Enter a value between the start distance and 5 km (or 16,404 ft.) using the numeric keypad, the **▲▼** arrows, or the rotary knob, then **Enter**.

Frequency Mode

All DTF measurements are made with frequency settings and, using Inverse Fourier Transform (IFT), the time and distance to faults are calculated.

NOTE

The start and stop frequencies for the measurement are always annotated on the screen below the start and stop distances.

How to set Frequency Mode

With a DTF measurement present,

- Press **Meas Setup 4**.
- Then **Frequency Mode**.
- Choose one of the following:
 - **Lowpass Mode** The frequency range of a DTF measurement is set automatically based on the Start and Stop Distances. Use Lowpass mode when the DUT is a cable ONLY.

- **Bandpass Mode** (Default setting) The frequency range of a DTF measurement is set manually. Use Bandpass mode when the DUT contains a diplexer or other filtering device which does not pass some frequencies.

Typically, you will set the frequency range of the measurement to the passband of the filter. However, you may also want to test the ability of the filter to reject unwanted frequencies. In this case, set the frequency range to include those frequencies which the filter may not be adequately rejecting.

When the DTF frequencies are set manually, they may not be the optimum frequencies for measuring the distance to fault. The distance may no longer be alias-free. Learn more about alias-free range on [page 4-26](#).

How to manually set Frequencies in Bandpass Mode

- Press **Freq/Dist**.
- Then **Min Start Freq** and type the start frequency to use for the DTF measurement.
- Then **Max Stop Freq** and type the stop frequency to use for the DTF measurement.
- OR
- Press **More**.
- Then **Max Freq Span** and type the frequency range to use for the DTF measurement.
- Then **Center Frequency** and type the center frequency of the range to use for the DTF measurement.

These settings specify the minimum and maximum frequencies to be used for the DTF measurement. These exact frequencies may not be used, but a narrower frequency range may be used that will still pass through the bandpass filter.

To see the frequencies that are used in the DTF measurement, press **Meas Setup 4** then **Settings** then **Next Page**. The calculated Start and Stop frequencies determine the exact frequency range being used.

Coupled Frequency

When a Return Loss & DTF measurement is present, this setting allows you to have different frequency ranges for each measurement. Learn more on [page 3-11](#).

Cable (Correction) Specifications

By default, the FieldFox does NOT correct DTF measurements to account for the inherent loss of a cable. However, to make more accurate DTF measurements, the Cable Loss and Velocity Factor values should be considered.

About Velocity Factor and Cable Loss

- Velocity Factor is a property of the physical material of a cable. A VF of 1.0 corresponds to the speed of light in a vacuum, or the fastest VF possible. A polyethylene dielectric cable has $VF = 0.66$ and a cable with PTFE dielectric has $VF = 0.7$.
- Cable Loss is specified in dB/meter. In addition to the length of the cable, loss is also directly proportional to the frequency of the signal that passes through the cable.

The following is an example showing how DTF cable correction works:

The DUT is a 100 meter transmission cable. The Cable Loss value is 1 dB/meter. This means that a signal traveling ONE WAY through the cable will lose 10 dB of power ($100 \text{ m} * 1 \text{ dB/m}$). Because the FieldFox performs this measurement with 1 port, the test signal travels down the cable and then back, for a total loss of 20 dB.

After a calibration has been performed, for the purpose of illustrating this point, connect an OPEN to the end of the cable – a maximum-sized fault – for 100% reflection of the 300 MHz test signal.

Without compensation for the loss of the cable, a -20 dB response would be visible at 100 meters, which is the OPEN at the end of the DUT. This is from 10 dB of loss through the cable in each direction.

With compensation for the loss using the manufacturer's specification, the FieldFox compensates the trace as though the signal traveling through 100 meters was increased by $+20$ dB. Therefore the response will show 0 dB for 100% reflection.

How to enter Cable Loss and Velocity Factor

Cable Loss and Velocity factor can be entered using one of the following methods:

- Manually enter cable loss and velocity factor for the measurement.
- Select or create a cable file which contains the cable loss and velocity factor.

With a DTF measurement present:

- Press **Meas Setup 4**.
- Then **DTF Cable Specifications**.
- Select **Cable Corr**.

DTF (Distance to Fault) Measurements
DTF Measurement Settings

- **Auto** Use Cable Loss and Velocity Factor values from a Cable file. See “How to Edit, Save, and Recall a Cable File” below. This will overwrite a manually-entered value.
- **Man** (Default setting) Manually enter a value for Cable Loss and Velocity Factor.
- Then:
 - **Velocity Factor** Using the numeric keypad, enter a value between 0.01 and 1. Then press **Enter**.
 - **Cable Loss** Using the numeric keypad, enter a positive Cable Loss value in dB/m, then press **Enter**.

How to Edit a Cable File

The FieldFox includes many predefined cable files with the manufacturer’s specifications. You can edit these files or create new cable files using the following procedure or using the FieldFox Data Link Software. Learn more at: www.keysight.com/find/fieldsfoxsupport

The Cable correction data survives a Mode Preset and Preset.

With a DTF measurement present:

- Press **Meas Setup 4**.
- Then **DTF Cable Specifications**.
- Then **Edit/Save/Recall Cables**.
- Press **New** then **Yes** to clear all data from the existing DTF Cable table and reset header information to default settings.
- Then **Edit Cable** to open the Cable Editor.
- Then use the **▲▼** arrows to select a field,
 - When editing Cable Description information, press **Edit** then modify the selected field using the FieldFox labeler.
 - When editing Frequency/Loss pairs, enter numbers using the numeric keypad, then select a frequency suffix. Then **Enter**. Learn more about “How the Freq/Loss pairs are applied” below.
- Optionally choose from the following:
 - **Previous / Next Page** Quickly scrolls through pages of Freq/Loss data.
 - **Add Data** Add a blank Freq/Loss pair to the table,
 - **Delete/Clear** then:
 - **Delete Row** Remove the selected Freq/Loss pair from the table.

- Press **Clear All** then **Yes**. Remove all Freq/Loss pairs from the table and resets header information to default settings.
- Press **Done** to close the Cable Editor.

How to Save or Recall a Cable

- Press **Save Cable** to save your changes to the specified Storage Device. Enter a filename using the FieldFox labeler (learn more in **“How to use the FieldFox labeler” on page 17-3**). Learn more about Cable files below.
- Press **Recall Cable** to load a Cable file from the specified Storage Device
- **Storage Device** Changes the device used to save or recall Cable files. This is a different setting from the Save/Recall Storage Device setting. Choose from Internal (default setting), **USB** (must be connected) or **SD card**.

About Cable files

- Cable files are saved to, and recalled from, the **Cables** folder. If the folder does not already exist on a USB or SD card, it is created automatically before storing the file.
- Cable files are stored as *.xml files. Existing cable files that are preloaded into the FieldFox firmware can be overwritten. Your edited file will NOT be overwritten when firmware is updated.

How the Freq/Loss pairs are applied

When the cable file contains one Freq/Loss pair, that correction value is applied to the entire displayed frequency span.

When the cable file contains two or more Freq/Loss pairs, the Loss value that is used is interpolated from the Freq/Loss pairs and the DTF center frequency. For example, using a cable file with the following Freq/Loss pairs:

1 GHz: 0.1 dB/m

2 GHz: 0.2 dB/m

The center frequency for the measurement is determined from the calculated (Stop – Start) frequency values (seen on the second page of DTF Settings):

Calculated Start = 2.0 MHz

Calculated Stop = 3.598 GHz

Center Freq = 1.80 GHz

The Loss value for the measurement is interpolated from the Freq/Loss pairs at the Center Freq:

1 GHz = 0.1 dB/m

DTF (Distance to Fault) Measurements DTF Measurement Settings

1.8 GHz = 0.18 dB/m

2 GHz = 0.2 dB/m

The correction for loss at 5 meters in one direction: $0.18 \text{ dB/m} * 5\text{m} = 0.9 \text{ dB}$.

All DTF measurements correct for loss for travel down the DUT and back, so double the correction: $0.9 \text{ dB} * 2 = 1.8 \text{ dB}$.

Window Settings

Window settings provide the ability to choose between optimizing DTF measurements for resolving closely-spaced faults or for the ability to measure low-level faults.

How to select Window settings

- Press **Meas Setup 4**.
- Then **Settings**.
- Then press **▲|▼** arrows to move to the Window row.
- Then press **Edit**.
- Then press **Window** and choose from the following:
 - **Maximum (Optimized for dynamic range)** the noise floor is lowered to provide the ability to measure low-level responses. (Default setting)
 - **Medium** – Compromise between Min and Max window settings.
 - **Minimum** – Best Response Resolution, providing the ability to resolve between two closely-spaced responses.
- Then press **Done Edit**.
- Again press **Done**.

DTF Units

The DTF Units setting is available ONLY on the DTF Settings table.

By default, X-axis units for DTF measurement settings are displayed in Meters.

- Select DTF Units.
- Then Choose from:
 - M (meters)
 - Feet

Calculated DTF values

Press [Next Page](#) on the DTF Settings Table to view the following **calculated Values** noted on the FieldFox screen with c - <setting>

Start Frequency – Start frequency that is used to calculate DTF.

Stop Frequency – Stop frequency that is used to calculate DTF.

Range Resolution. Indicates the accuracy of the distance to fault measurement. For example, with range resolution of 500 mm, if the distance to fault is 10 meters, this value could be inaccurate by +/- 500 mm or between 9.5 to 10.5 meters. This value is calculated from frequency span / resolution (points).

Response Resolution, not displayed, indicates the distance that could be between two faults and still show as separate faults. Learn more in [“Window Settings” on page 4-25](#).

Maximum Distance. The distance that could be viewed with the current settings. Defined by: $V_f * c * Points / (2 * Bandwidth)$ where:

- V_f = velocity factor
- c = speed of light
- Points = resolution
- Bandwidth = frequency range

Alias-free Range (On/Off)

- On = No Alias images
- Off = Alias images may appear in the response.

About Alias Faults

An alias fault is not a true device response. An alias fault appears because of the method used to convert frequency to time.

On the DTF Settings page (above) the c - Alias-free Range = Off setting indicates alias images MAY appear on the screen.

Shorter stop distances (less than 10 meters) and a higher resolution (1001 points) will be **more** likely to result in **Alias-free Range = Off**.

When the Alias-free Range = Off, the following procedure will help to determine if a response is true or an alias response:

1. Put a marker on the response in question and note the distance to the fault.
2. Change the start or stop distance.

DTF (Distance to Fault) Measurements

DTF Measurement Settings

A true fault response will not move in distance. That is, if a true fault is present at 10.3 meters, changing the stop distance from 15 m to 20 m will not move the fault; the fault will remain at 10.3 meters. However, an alias response will appear to move.

An un-terminated cable (with NO perfect load at the end) will show faults that appear to be beyond the end of the cable. These are NOT alias faults. These faults appear as the signal reflects off the open at the end of the cable and travels back down the cable toward the connection at the FieldFox.

Re-reflections are measured at the FieldFox as mirror images of the original faults. The largest fault is the open end of the cable. To avoid confusion, set the Stop distance shortly after that fault.

DTF (Distance to Fault) Measurements
DTF Measurement Settings

5 NA (Network Analyzer) Mode

Learn more about NA Mode measurements in the FieldFox Supplemental Online Help:

<http://na.support.keysight.com/fieldfox/help/SupHelp/FieldFox.htm>.

In this Chapter

- “Measurement Selection” on page 5-3
- “Parameter Conversion” on page 5-3
- “Quick Settings” on page 5-5
- “Calibration Settings” on page 5-6
- “Format” on page 5-7
- “Frequency Range” on page 5-8
- “Scale Settings” on page 5-8
- “Magnitude Offset” on page 5-9
- “Electrical Delay” on page 5-10
- “Phase Offset” on page 5-10
- “Averaging” on page 5-11
- “IF Bandwidth” on page 5-12
- “Smoothing” on page 5-12
- “Single or Continuous Measure” on page 5-13
- “Resolution (Number of Data Points)” on page 5-13
- “Sweep Time” on page 5-14
- “Output Power” on page 5-14
- “System Impedance (Z0)” on page 5-15
- “Port Extensions” on page 5-16
- “Velocity Factor” on page 5-17

“S21Transmission Measurements” on page 5-17

“Increase Dynamic Range” on page 5-20

See Also

“Why and When to Calibrate” on page 7-2

“All about Markers” on page 16-2

“All about Limit Lines” on page 16-14

“All about Trace Math” on page 16-19

Learn how to make 75Ω (ohm) Measurements in the Supplemental Online Help:

<http://na.support.keysight.com/fieldfox/help/SupHelp/FieldFox.htm>

NA Mode Settings

Select NA Mode before making any setting in this chapter.

How to select NA Mode

- Press **Mode**.
- Then **NA**.

Measurement Selection

How to measure S-parameters

1. Press **Measure 1**
2. Press choose from the following:
 - **S11** 1-port reflection measurement.
 - **S21** 2-port transmission measurement. Requires Opt 110. Learn how to make this measurement on [More](#)
 - **More**. These measurement are typically used as diagnostic tools for service personnel.
 - **A** Measurement of the A receiver.
 - **R1** measurement of the R1 receiver.

NOTE

The A and R1 receiver measurements are NOT corrected for absolute power. They are only useful for making relative measurements. The Y-Axis and markers are labeled in dB - NOT dBm. Specifically, R1 does NOT indicate the actual power levels out of the source port. The actual power level is close to the typical output power of +5 dBm (High power) and -25 dBm (Low power).

Learn more about raw receiver measurements in the FieldFox Supplemental Online Help:

<http://na.support.keysight.com/fieldfox/help/SupHelp/FieldFox.htm>

Parameter Conversion

In NA Mode ONLY, converts the active S-parameter trace to an equivalent impedance (Z), admittance (Y), or reciprocal 1/S-parameter

How to select parameter conversions

- Press **Measure 1**.
- Then select an S-parameter
- Then **More**.
- Then **Conversion**.

- Then choose from the following:
 - **Off** (default) No conversion is performed.
 - **Z Conv (--)** or **Y Conv (--)** Perform conversion for impedance (Z) or admittance (Y). Then choose from the following for either:
 - **Auto** The displayed S-parameter is converted to the appropriate Z or Y parameter: Refl for S11 and S22; Trans for S21 and S12. When the S-parameter is changed, the appropriate conversion changes automatically.
 - **Refl** The displayed S-parameter is converted to Z or Y reflection, regardless of whether the S-parameter is reflection (S11 or S22) or transmission (S21 or S12).
 - **Trans** The displayed S-parameter is converted to Z or Y transmission, regardless of whether the S-parameter is reflection (S11 or S22) or transmission (S21 or S12).
 - **1/S** The displayed S-parameter is converted to 1/S-parameter.

Multi-Trace Configurations

In NA Mode you can display multiple traces on the FieldFox screen.

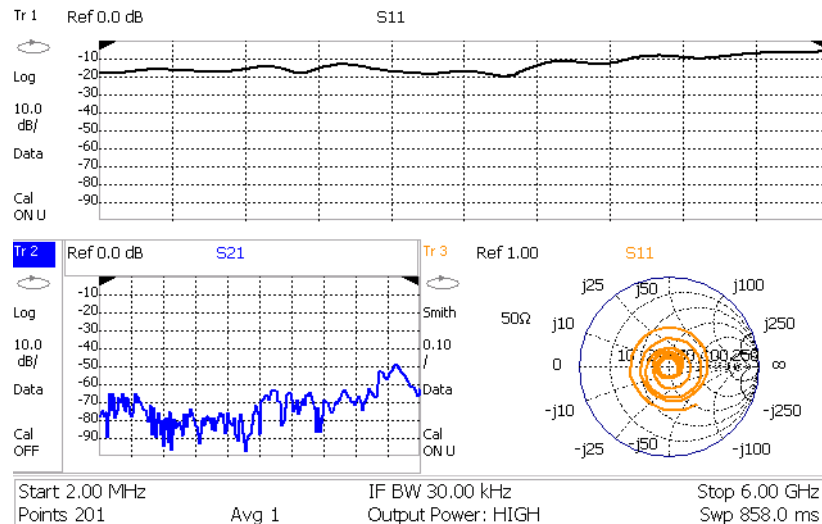

The graphic above shows a x3H configuration. Tr2 is the ACTIVE trace as indicated by the highlighted **Tr2**.







Trace Setting Notes

- The Frequency Range, IF BW, Resolution, Average, and Output Power settings are common for all displayed traces.
- All other trace settings, such as measurement, format, and limit lines, are applied individually to the ACTIVE trace in the same manner as when a single trace is present.

- By default, a marker is created on ALL traces. However, they can be created individually by disabling Coupled Markers. Learn more in “**Coupled Markers (NA Mode)**” on page 16-5.

How to select a multi-trace configuration

- Press **Trace 6**.
- Then **Num of Traces**.
- Then choose from the following:
The default measurements depend on the options that are installed

	x1	1 trace standard configuration
	x2	2 traces overlaid on a single graticule
	x2H	2 traces on separate graticules
	x3H	3 traces on separate graticules
	x3	3 traces overlaid on a single graticule
	x4H	4 traces on separate graticules

How to activate a trace in order to change a setting

- Use the  arrows **OR**
- Press **Trace 6** then select **Trace 1**, **Trace 2**, **Trace 3**, or **Trace 4**. Only traces that are shown can be activated.

How to maximize the viewing of the active trace

- Press **System 7**.
- Then **Full Screen**.
- Press any key to return to the standard display.

Quick Settings

Both CAT and NA Modes allow you to view and change most relevant settings from a single location. All of these settings are discussed in this chapter and, unless otherwise noted, ALL of these settings can also be made using the standard softkey menus.

How to view and change Quick Settings

- Press **Meas Setup 4**.
 - Then **Settings**.
 - Press **Next Page** and **Previous Page** to view all settings. If these softkeys are NOT available, then all available settings fit on one page.
 - To change a setting:
 - Use the **▲▼** arrows to highlight a setting.
 - Then press **Edit**. The current setting changes to **yellow**.
 - Some settings require you to press a softkey to change the value. Otherwise, use the numeric keypad, **▲▼** arrows, or rotary knob to change the value.
 - When finished changing a value, press **Done Edit**.
 - Press **Dock Window** to relocate the Settings table to a position relative to the trace window. The Dock Window setting persists through a Preset. Choose from the following:
 - **Full (Default setting)** Only the Settings table is shown on the screen. The trace window is temporarily not shown.
 - **Left** The Settings table is shown to the left of the trace window.
 - **Bottom** The Settings table is shown below the trace window.
- When finished changing ALL settings, press **Done** to save your settings.

Calibration Settings

NA Mode has a page specifically for making settings that pertain to Port Extensions, including Velocity Factor and Media Type.

Learn more in **“Port Extensions” on page 5-16**.

Learn how to calibrate beginning in **“Why and When to Calibrate” on page 7-2**.

NOTE

The N9912A does NOT support Media Type: Waveguide.

How to view and change Calibration Settings

- Press **Meas Setup 4**.
- Then **Calibration Settings**.
- Make these settings in the same manner as Quick Settings in the previous section.

Format

Select the display format in which to present measurement results. This setting can be changed at any time without affecting calibration accuracy.

NOTE

Learn more about Display Formats in the FieldFox Supplemental Online Help:

<http://na.support.keysight.com/fieldfox/help/SupHelp/FieldFox.htm>

The marker on screen readout can be changed to formats other than the display format. Learn more in “**Marker Functions**” on page 16-12.

How to select a NA Format

- Press **Measure 1**.
- Then **Format [current setting]**.
- Then choose from the following:
 - **Log Magnitude** Displays magnitude in dB
 - **Linear** Displays positive values only. Y-axis: Unitless (U) for ratioed measurements; Watts (W) for unratioed measurements.
 - **VSWR** Used mainly for S11 and S22. Displays unitless reflection data.
 - **Phase** Displays phase in degrees. The trace ‘wraps’ every 360 degrees, from +180 to –180, for easy scaling.
 - **Smith** Used mainly for S11 and S22, which are plotted on a Smith Chart. Displays series resistance and reactance.
 - **More** then...
 - **Polar** (S11 Only). Displays magnitude and phase of the reflection coefficient.
 - **Group Delay** Used mainly (S11) only. Displays propagation time (in seconds) from the RF port to the point where it is reflected, and back to the A receiver. The aperture setting is the frequency range/(number of points – 1). Use Smoothing as the Group Delay aperture.
 - Learn how to set Smoothing aperture on “**Smoothing**” on page 5-12.
 - Learn more about Group Delay measurements at the FieldFox Supplemental Online Help:
<http://na.support.keysight.com/fieldfox/help/SupHelp/FieldFox.htm>

- **Unwrap Phase** Same as Phase, but without 180 degree wrapping.

NOTE

Phase is unwrapped by comparing the phase from one data point to the next. If the phase difference between two data points is greater than 180 degrees, or if the phase of the first data point is greater than 180 degrees from DC, then the phase measurement is probably NOT accurate. To ensure that the phase measurement is accurate, increase the resolution setting. When making a narrow band measurement, reduce the start frequency for the unwrapped phase measurement to ensure the first data point is less than 180 degrees from DC.

Frequency Range

Set the range of frequencies over which you would like to make measurements.

When the frequency range is changed after a calibration is performed, the cal becomes interpolated. Learn more in [“Interpolation” on page 7-7](#).

How to set Frequency Range

This can be done in two ways:

- Press **Freq/Dist**.
- Then choose from the following:
 - **Start** and **Stop** frequencies – Specify the beginning and end of the sweep.
 - **Center** and **Span** frequencies – Specify the center frequency and span of frequencies (half on either side of center).
- Follow each by entering a value using the numeric keypad, the **▲▼** arrows, or the rotary knob.
- After using the **▲▼** arrows or the rotary knob, press **Enter**. The increment setting of the arrows is based on the current span and can NOT be changed in NA Mode.
- After using the keypad, select a multiplier key. Learn more in [“Multiplier Abbreviations” on page 2-14](#).

Scale Settings

Adjust the Y-axis scale to see the relevant portions of the data trace. The Y-axis is divided into 10 graticules.

This setting can be changed at any time without affecting calibration accuracy.

How to set Scale

- Press **Scale / Amptd**.

- Then choose from the following methods:
 - **Autoscale** Automatically adjusts the Y-axis to comfortably fit the Min and Max amplitude of the trace on the screen.
 - **Autoscale All** Autoscales all of the traces on the screen, useful only for multi-trace configurations.
- 3.Set Scale, Reference Level, and Reference Position
 - **Scale** Manually enter a scale per division to view specific areas of the trace.
 - **Ref Level** Manually set the value of the reference line. Enter a negative value by pressing **Run/Hold (+/-)** either before or after typing a value.
 - **Ref Position** Manually set the position of the reference line. Values must be between 0 (TOP line) and 10 (BOTTOM line)

Scale annotation on the FieldFox screen

- Reference Line = red arrow
- Ref Level = -40 dB
- Ref Position = 1
- Scale = 2 dB per division

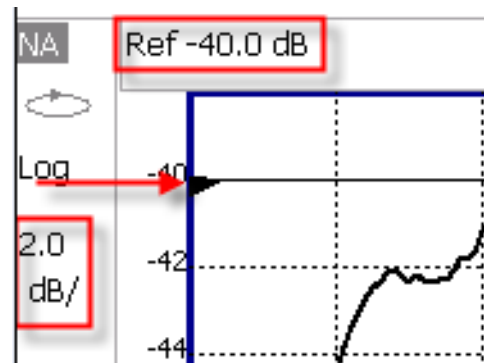



Magnitude Offset

Magnitude Offset allows you to offset the magnitude (not phase) data by a fixed and/ or sloped value in dB. If the display format is Linear Magnitude or Real (unitless), the conversion from dB is performed and the correct amount of offset is implemented.

The Magnitude offset setting affects only the active trace.

How to set Magnitude Offset

- Press **Scale / Amptd**.
- Then **More**.
- Then **Magnitude Offset** - Offsets the entire data trace by the specified value.

- Then enter a positive or negative offset value in dB using the numeric keypad, the  arrows, or the rotary knob. Press a multiplier key. Learn about **“Multiplier Abbreviations” on page 2-14.**
- And/or press **Slope** - Offsets the data trace by a value that changes linearly with frequency. The offset slope begins at 0 Hz. and continues to the stop frequency. The offset value at the start frequency is then calculated from 0 Hz.
- Then enter a positive or negative offset slope value in dB/GHz using the numeric keypad, the  arrows, or the rotary knob. Press a multiplier key. Learn about **“Multiplier Abbreviations” on page 2-14.**

Electrical Delay

Electrical delay is a mathematical function that simulates a variable length of lossless transmission line. Use the electrical delay feature to compensate for the linear phase shift through a device and view only the deviation from linear phase of the device.

You can set the electrical delay independently for each measurement trace. To apply an electrical delay to all measurement traces, use Port Extensions. Learn how in **“Port Extensions” on page 5-16.**

Learn how to set Phase formats in **page 5-7.**

How to set Electrical Delay

- Press **Scale / Amptd.**
- Then **More.**
- Then **Electrical Delay.**
- Enter a time value using the numeric keypad, the  arrows, or the rotary knob.
- Press a multiplier key. Learn about multiplier abbreviations in **“Multiplier Abbreviations” on page 2-14.**

Electrical Delay can also be set using the **Mkr->Delay** feature. Learn how on **“Marker Functions” on page 16-12.**

Phase Offset

Phase format is available only with S11 measurements.

Phase offset mathematically adjusts the phase measurement by a specified amount, up to 360°. Use this feature in the following ways:

Improve the display of a phase measurement. This is similar to the way you would change the reference level in an amplitude measurement. Change the phase response to center or align the response on the screen.

Emulate a projected phase shift in your measurement. For example, if you know that you need to add a cable and that the length of that cable will add a certain phase shift to your measurement, you can use phase offset to add that amount and simulate the complete device measurement.

You can set the phase offset independently for each measurement trace.

How to set Phase Offset

- Press **Scale / Amptd**.
- Then **More**.
- Then **Phase Offset**.
- Enter a value in degrees using the numeric keypad, the **▲▼** arrows, or the rotary knob. Press **Enter**.

Averaging

Averaging helps to reduce the effects of random noise on a measurement. You specify the number of measurements to be averaged. The more measurements averaged, the greater the amount of noise reduction. An average counter is shown in the left edge of the screen as **Avg <n>** where <n> is the number of measurements that are averaged.

Averaging can be set before or after calibration. When set before calibration, each calibration standard is measured <n> times and averaged. More time is needed to perform the calibration, but there will be less noise in the resulting error terms which means that subsequent measurements will also have less noise. In addition, noise is further reduced by continuing to average after calibration.

How to set Averaging

- Press **BW 2**.
- Then **Average <n>** where <n> is the number of measurements to average.
- Enter a value using the numeric keypad. Enter 1 for NO averaging.
- Press **Enter**.
- Then **Average Mode** Choose from the following:
 - **Sweep** - Each data point is based on the average of the same data point being measured over <n> consecutive sweeps. The average counter shows the number of previous sweeps that have been averaged together to form the current trace. When the counter reaches the specified count, then a 'running average' of the last <n> sweeps is displayed.

- **Point** - Each data point is measured <n> times and averaged before going to the next data point. On subsequent sweeps, averaging restarts by measuring each data point again <n> times. The average counter is not updated because data is not displayed until all the averages have been applied.
- **Point averaging is usually faster than sweep averaging.** However, you may need to increase the Point Average count to obtain the same level of noise reduction as with sweep averaging.
- While averaging is in process, press **Sweep 3** then **Restart** to restart the averaging at 1.

IF Bandwidth

The FieldFox converts the received signal from its source to a lower intermediate frequency (IF). The bandwidth of the IF bandpass filter is adjustable. Reducing the IF receiver bandwidth reduces the effect of random noise on a measurement. However, narrower IF bandwidths cause longer sweep times.

How to set IF BW

- Press **BW 2**.
- Then **IF BW**.
- Then choose from the following:
- **300 Hz** | **1 kHz** | **3 kHz** | **10 kHz** | **30 kHz**

Smoothing

Trace smoothing averages a number of **adjacent** data points to smooth the peak-to-peak noise values on a displayed trace. The number of adjacent data points that are averaged is known as the smoothing aperture. Aperture is set by specifying a percentage of the X-axis span.

Trace smoothing does NOT significantly increase measurement time.

Smoothing is used in Group Delay measurements, although it can be used with any NA format EXCEPT Polar or Smith Chart. Learn more about NA Mode formats, including Group Delay, in **“Format” on page 5-7**.

When enabled, **Smo** appears on the FieldFox screen.

How to set Smoothing

- Press **BW 2**.
- Then **Smoothing ON OFF**.
- Then **Sm. Aperture** and enter a value between 0 and 25 (percent) using the numeric keypad.

- Press **Enter**.

Single or Continuous Measure

This setting determines whether the FieldFox sweeps continuously or only once each time the **Single** button is pressed. Use Single to conserve battery power or to allow you to save or analyze a specific measurement trace.

This setting can be changed at any time without affecting calibration accuracy.

How to set Single or Continuous

- Press **Sweep 3**.
- Then choose one of the following:
 - **Single** Automatically sets Continuous OFF and causes FieldFox to make ONE measurement, then hold for the next Single key press. When a data trace is displayed, the entire trace is measured, then holds. The Hold annotation changes to an arrow --> while the measurement occurs.
 - **Continuous** Makes continuous sweeps. This is the typical setting when battery power is not critical.
- You can also use **Run / Hold +/-** to toggle between Single and Continuous.

Resolution (Number of Data Points)

Data points are individual measurements that are made and plotted across the X-axis to form a trace. Select more data points to increase measurement resolution. However, more data points also takes more time to complete an entire measurement sweep.

When the Resolution is changed after a calibration is performed, the cal becomes interpolated. Learn more in **“Interpolation” on page 7-7**.

How to set Resolution

- Press **Sweep 3**.
- Then **Resolution**.
- Then choose from the following:
101 | **201** | **401** | **601** | **801** | **1001** | **1601** | **4001** | **10001**.
- Using SCPI, Resolution can be set to ANY number of points between 3 and 10001. See the Programming Guide at <http://na.support.keysight.com/fieldfox/help/Programming/webhelp/FFProgrammingHelp.htm>

Sweep Time

The fastest possible sweep time is always used as the default setting. Use the Min Swp Time setting to slow the sweep time when measuring long lengths of cable. Learn more at the FieldFox Supplemental Online Help:

<http://na.support.keysight.com/fieldfox/help/SupHelp/FieldFox.htm>

The actual sweep time is shown on the FieldFox screen. See the Screen Tour on **“Screen Tour” on page 2-12**. To increase the sweep time, enter a value that is higher than the actual sweep time. The increase will not be exactly the amount that you enter, as the actual sweep time is the composite of many factors.

NOTE

Measurement speed specifications do NOT apply in Temperature Control Mode. Learn more in **“Temperature Control Mode” on page 2-5**.

How to set Sweep Time

- Press **Sweep 3**.
- Then **Min Swp Time**.
- Enter a value using the numeric keypad.
- Press a multiplier key. Learn about multiplier abbreviations in **“Multiplier Abbreviations” on page 2-14**.

Output Power

Set the power level out of the FieldFox to High, Low, or manually set power level to a value between High and Low.

Generally, the high power setting is used when measuring passive, high-loss devices to place the signal farther from the noise floor. However, for devices that are sensitive to high power levels such as amplifiers, use the Low power setting.

For best measurement accuracy, use the Manual power setting at -15 dBm. After calibration, the power level can be decreased for amplifiers, or increased for higher dynamic range.

CAUTION

Power Level settings in this mode will NOT change Power Level settings in other modes. To help prevent damage to your DUT, use caution when changing modes with your DUT connected to the FieldFox test ports.

How to set Output Power

- Press **Meas Setup 4**.
- Then **Output Power**.

- **High** (Default setting) Sets output power to the maximum achievable power at all displayed frequencies. Please see the FieldFox Specifications ([page B-3](#)) for expected power levels.
- **Low** Sets output power to approximately -27 dBm.
- **Man** Set output power to an arbitrary value.
- Then press **Nominal Power**.
- Then enter a value using the numeric keypad, the **▲▼** arrows, or the rotary knob.
- Press **Enter**.

NOTE

Nominal here means: a general, descriptive term or design parameter. It is not tested and not covered by the product warranty.

The Nominal Output displayed on the bottom right side of the display indicates a range of low and high power values. Your actual measured output power could be a little lower or a little higher.

If you have the USB power sensor feature (Option 302) you can measure the actual output power for your measurement. Refer to [“Power Meter Mode \(Option 302\)”](#) on page 11-1.

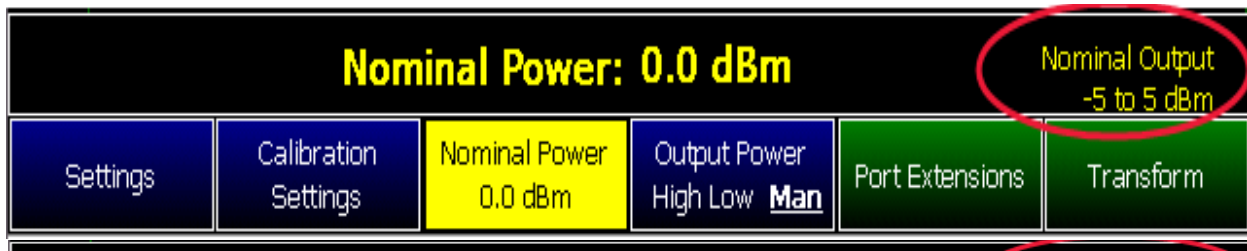

System Impedance (Z0)

To accurately view data presented in Smith Chart format, first set the System Impedance.

Learn how to select Smith Chart format in [“Format”](#) on page 5-7.

Learn how to make 75Ω measurements at the FieldFox Supplemental Online Help: <http://na.support.keysight.com/fieldfox/help/SupHelp/FieldFox.htm>

How to set System Impedance

- Press **Meas Setup 4**.
- Then **Settings**.
- Then scroll to System **Z0** and press **Edit**.
- Then type either **50** or **75** and press **Enter**.

Port Extensions

Port extensions allow you to electrically move the calibration reference plane on either port 1 after you have performed a calibration.

Phase measurements, and therefore Port Extensions, are NOT available on port 2.

Why use Port Extensions

Use port extensions if you are unable to perform a calibration directly at your device because the location is not accessible. Perform a calibration at a convenient place, then use port extensions to compensate for the time delay (phase shift) to the desired reference plane. On the FieldFox, port extensions does not compensate for the loss of the additional electrical length, nor any mismatch errors beyond the calibration reference plane.

Also use port extensions if you have already performed a calibration, and then decide that you need to add a length of transmission line in the measurement configuration. Use port extensions to “tell” the FieldFox that you have added the length to a specific port.

Port extensions and Electrical Delay differ in the following ways:

- Electrical delay is applied to a specific trace.
- Port extensions are applied to specific trace.

Port Extensions and Electrical Delay can be set independently. When both are set, the delay adds together. Learn more about Electrical Delay in [“Electrical Delay” on page 5-10](#).

How to apply Port Extensions

- Press **Meas Setup 4**.
- Then **Port Extensions**.
- Then **Port Extensions ON**.
- Then **Port1 Extension**.
- Then enter time value using the numeric keypad, the **▲▼** arrows, or the rotary knob. Press **Enter** or select a seconds (time) multiplier.

You can also set Port Extensions by pressing **Meas Setup 4** then **Calibration** (settings).

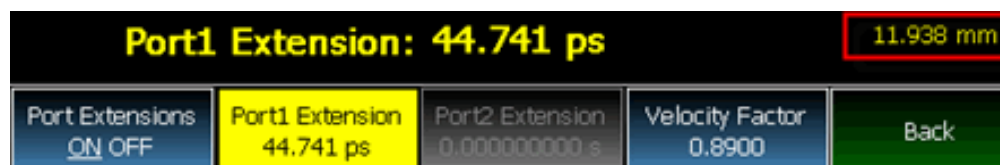

While setting Port Extension, the physical length of the extension, at the current Velocity Factor setting, is visible to the right (red box in above image).

Velocity Factor

The electrical delay or port extension value is entered as delay, or **electrical length**, in units of time.

Entering the velocity factor causes the FieldFox to accurately display the equivalent **physical length** in meters (NOT available in feet) that corresponds to the entered electrical delay.

Velocity factor is the ratio of the velocity of wave propagation in a coaxial cable to the velocity of wave propagation in free space. This velocity depends on the relative permittivity of the cable dielectric (ϵ_r).

$$\text{Velocity factor} = 1/\sqrt{\epsilon_r}$$

VF = 0.66 corresponds to wave propagation through a polyethylene dielectric.

VF = 1.0 (default setting) corresponds to wave propagation through free space (a vacuum).

How to set Velocity Factor

- Press **Meas Setup 4**.
- Then **Port Extensions**.
- Then **Velocity Factor**.
- Then enter a value between 0.1 and 1 using the numeric keypad, then press **Enter**.

You can also set Velocity Factor by pressing **Meas Setup 4** then **Calibration (settings)**.

S21Transmission Measurements

An S21 Transmission measurement, available with option 110, is used to measure the loss through a DUT – or cable – over a specified frequency range. The FieldFox signal source is transmitted out the RF OUT connector, through the DUT, and into the RF IN connector. Both ends of the DUT must be connected to the FieldFox.

An S21 measurement is exactly the same measurement as “2-Port Insertion Loss” in CAT Mode.

NOTE

A Normalization Cal is REQUIRED when making 2-port CAT or NA measurement.

For highest accuracy, when measuring the DUT also attach any cable or adapter that was used in the normalization cal.

How to make an S21 Transmission Measurement

1. Press **Node** then **NA** then **S21 Transmission**.
2. Press **Freq/Dist** and enter **Start** and **Stop** frequency values of the measurement.
3. Press **Sweep 3** then select a **Resolution** setting.
4. Press **Cal 5** then press **Normalization**. Perform normalization as explained on [page 7-6](#).
5. Connect the DUT and view the transmission measurement results.

When measuring very long lengths of cable, it may be necessary to increase the sweep time. Learn how in [“Sweep Time” on page 3-8](#). Learn why at the FieldFox Supplemental Online Help:

<http://na.support.keysight.com/fieldfox/help/SupHelp/FieldFox.htm>

Big Marker Display States (A and B)

This feature, available ONLY in NA Mode, allows you to view up to three Big or Super Big marker readouts. This is done by using up to two different display states called A and B. Each display state is comprised of the settings listed below. When the Big Readout setting is toggled through A and B, these display states are recalled.

How to create Big Marker Display States

To have big readouts, markers MUST be created using the following procedure.

If you have already set up your display and do not want to lose it, then save the current state to a state file. Learn how in [“State Files” on page 17-4](#). The following procedure will overwrite your display state.

- Press **Mkr ->/ Tools**.
- Then **Big Readout**.
 - **A or B** - The A or B display state is recalled. If none have been defined, then the default display state is recalled.
 - **OFF** - The B display state is visible but without the Big Marker Readout.
- With A or B selected, then press **Edit Big Marker (A or B)**.
- Then edit the following display state settings:
 - **Num Traces** – Choose the Multi-Trace configuration x1, x2, or x3. Only Overlaid configurations are allowed. Learn more in [“Multi-Trace Configurations” on page 5-4](#).
 - **Font Size** – Choose either Big or Super Big. Super Big marker readout #3 will cover some of the measurement grid.

- **Trace Settings** – For each possible trace (1, 2, and 3) select from the following:
 - **Measurement** – S-Parameter or Receiver measurement to display. **S11** is default. Learn more in [“Measurement Selection” on page 5-3](#).
 - **Meas Format – Log** is default. Learn more in [“Format” on page 5-7](#).
 - **Band width (ON)** – Marker readout for marker bandwidth search. OFF is default. Learn how to set BW parameters in [“How to Search with Markers” on page 13-12](#).
- **Big Readout** – For each marker readout (1, 2, and 3), select from the following:
 - **Marker #** – Enter a number from 1 to 6 to create the marker. 1 is created by default.
 - **Trace #** – The marker# is created on this trace. Tr1 is selected by default. The corresponding Num Traces must first be selected. For example, to create a marker on Trace 3, first select Num Traces = x3.
 - **Format** – Format for the marker readout. Select Default to make the marker readout format the same as the display format. Default is selected by default.
 - **Mkr Tracking** – ON: Select the parameter to track on the standard Marker Search menu. OFF is selected by default. When set to ON, Peak tracking is set by default. Learn about Marker Tracking in [“Searching with Markers” on page 16-7](#).
 - **State** – Choose from Normal, Delta, or OFF. The default marker (1) is created in Normal. Learn more in [“Marker Functions” on page 16-12](#).
 - **Enabled** – Turns the Big Readout of the corresponding marker ON and OFF. The default marker (1) is set ON by default.

Notes:

- To move a marker, press **Marker**, then **Marker**, then scroll to the marker number to be moved. The new marker position can NOT be saved with the A or B display state.
- Settings that are NOT listed above are NOT affected by the recalled display states.
- Changes to the above settings outside the Big Readout menu will be overwritten when Big Readout (A or B) is selected. For example, suppose the display format for the B state is Log. If you change the display format to Lin using the standard menu (Meas 1, Format), the setting will show on the display. But if you then use the Big Readout (A | B | OFF) setting, when B is recalled, the Lin setting will be overwritten with the original Log setting.

Increase Dynamic Range

Dynamic range is the difference between maximum input power to the FieldFox receiver (without compressing the receiver), and the minimum measurable power (noise floor). Measurement accuracy is increased when the DUT response is at least 10 dB above the noise floor. For a measurement to be valid, input signals must be within these boundaries.

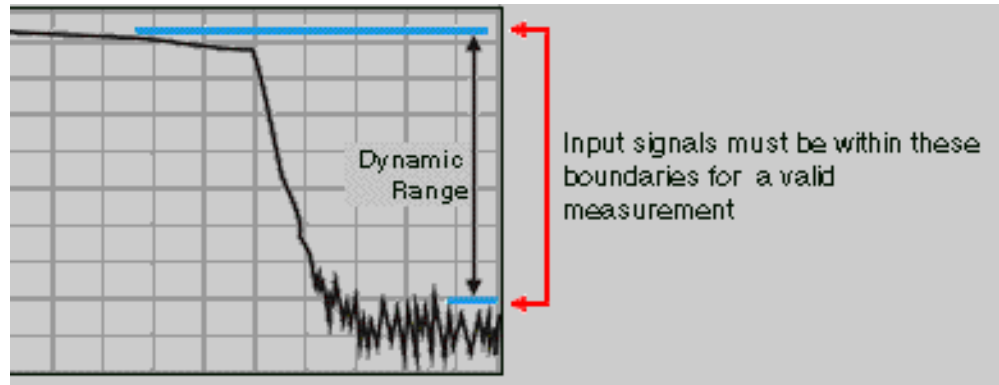

The following settings will increase the dynamic range of your NA mode measurement.

- Increase Power Level: Press **Meas 4** then **Output Power High**.
- Lower the IFBW: Press **BW 2** then **IF BW**.
- Increase Averaging: Press **BW 2** then **Average**.

The following procedure MAY increase the dynamic range of your NA mode measurement. The results you see will depend on the performance of your DUT.

With an S21 trace active:

1. With RF OUT (port-2) open, press **Trace 6** then **Math and Memory** then **Data->Mem**.
2. Re-connect the DUT.
3. Press **Data Math** then **Data-Mem**.

6 Time Domain – Option 010

With NA Mode, Time Domain Reflectometry (Opt 010), frequency information is used to calculate and display measurements with time as the horizontal display axis. The response values appear separated in time allowing a different perspective of the test device's performance and limitations.

NA Mode settings that are NOT unique to Time Domain are documented in [Chapter 5, "NA \(Network Analyzer\) Mode", on page 5-1](#).

In This Chapter

["Overview" on page 6-3](#)

Time Domain (Transform) Settings

["Transform Settings Table" on page 6-4](#)

["Frequency Range and Points" on page 6-4](#)

["Stimulus \(Mode\)" on page 6-5](#)

["Set Frequency Lowpass" on page 6-5](#)

["Start/Stop Time" on page 6-5](#)

["Distance Units" on page 6-6](#)

["Window Layout" on page 6-6](#)

["Transform Window" on page 6-6](#)

["Line Loss and Velocity Factor" on page 6-7](#)

["Data Chain" on page 6-8](#)

Trace Settings

["Transform Enable" on page 6-9](#)

["Gate Enable" on page 6-9](#)

Gating Settings

“Start, Stop, Center, and Span Gate Times” on
page 6-10

“Gating Type” on page 6-10

Overview

In normal NA Mode operation, the FieldFox measures the characteristics of a test device as a function of frequency. With Time Domain (opt 010), frequency information is used to calculate the inverse Fourier transform and display measurements with time on the horizontal display axis. The response values appear separated in time, allowing a different perspective of the test device's performance and limitations.

The graphic below compares the same cable reflection measurement data in both the frequency and time domain. The cable has two bends. Each bend creates a mismatch or change in the line impedance.

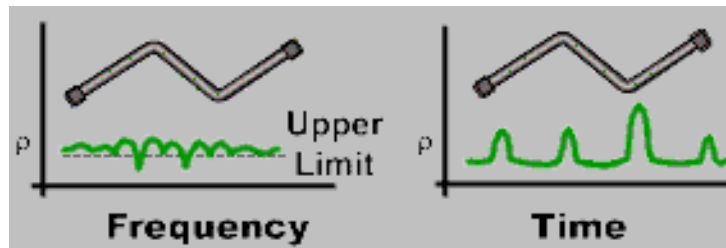

The frequency domain of an S11 measurement shows reflections caused by mismatches in the cable. It is impossible to determine where the mismatches physically occur in the cable.

The Time Domain response shows both the location and the magnitude of each mismatch. The responses indicate that the second cable bend is the location of a significant mismatch. This mismatch can be gated out, allowing you to view the frequency domain response as if the mismatch were not present. Learn more about gating in **“Gating” on page 6-10**.

Markers that are created on a Time Domain trace can be used to pinpoint the distance of the mismatch from the reference plane.

For more information on Time Domain theory, see <http://literature.cdn.keysight.com/litweb/pdf/5989-5723EN.pdf>

Time Domain (Transform) Settings

You can set and view most of the Time Domain settings on the Transform Settings table.

Transform Settings Table

The following settings (from Transform Stimulus Settings to Data Processing) are listed in the order they appear on the Transform Settings menu selection.

How to make settings on the Transform settings table

- Press **Meas Setup 4**.
- Then **Transform**.
- Then **Transform Settings**.
- Press **Next Page** and **Previous Page** to view all settings.
- To change a setting:
 - Use the **▲▼** arrows or rotary knob to highlight a setting.
 - Numeric settings can be changed by pressing numbers using the numeric keypad. Then press Enter or select a suffix if available.
 - Some settings allow you to press **Edit** to toggle the value. Other settings require that you then press a softkey to change the value.
 - When finished changing a value, press **Done Edit**.
- Press **Dock Window** to relocate the Settings table to a position relative to the trace window. The Dock Window setting persists through a Preset. Choose from the following:
 - **Full (Default setting)** Only the Settings table is shown on the screen. The trace window is temporarily not shown.
 - **Left** The Settings table is shown to the left of the trace window.
 - **Bottom** The Settings table is shown below the trace window.
- When finished changing ALL settings, press **Done** to save your settings.

Frequency Range and Points

Like CAT mode, all Time Domain measurements are made in the frequency domain and, using Inverse Fourier Transform (IFT), time is calculated. Select the frequency range from which Time Domain measurements are calculated. Increasing the data points will improve measurement resolution. However, more data points will usually result in slower sweep updates.

Set frequency range and points before selecting Stimulus Mode.

Stimulus (Mode)

- There are three variations on how the Time Domain transform algorithm is applied to the frequency domain measurement. Each method has a unique application.
- **Lowpass Impulse** - Highest resolution. Most useful for seeing small responses in devices that pass low frequencies, such as cables.
- **Lowpass Step** - Easiest to identify inductive and capacitive discontinuities in devices that pass low frequencies such as cables.

In both Lowpass modes, frequencies down to DC and negative frequencies are extrapolated. Therefore, when either Lowpass mode is selected, Set Freq.Low Pass is automatically applied to adjust the start frequency. Learn more about Set Frequency Lowpass below.

When the Start Frequency or resolution is changed AFTER selecting a Lowpass mode, then Stimulus mode is set to Band Pass and Transform is disabled.

- **Bandpass** - Easiest method - can be used with any frequency sweep. Most useful for measuring band limited devices such as filters and DC blocked cables. This mode does NOT show capacitive and inductive reactance. For the same frequency span and number of points, band pass mode has twice the impulse width, which hides closely spaced responses degrading the response resolution.

Set Frequency Lowpass

NOTE

This setting is made automatically when either Lowpass mode is selected.

USE ONLY IN LOW PASS MODES. When this setting is made, the start frequency is adjusted to be harmonics of the start frequency. Start frequency is computed by the following formula:

Low Pass Start Frequency = Stop Frequency / Number of points.

Start/Stop Time

The following settings adjust the **display resolution**, allowing you to zoom IN or OUT on a response. When the start or stop time is updated, they may be automatically adjusted to limit the display to one alias-free response on either side of zero time.

How to set Start and Stop time

- Press **Measure 4**.
- Then **Transform**.
- Then **Transform Start Stop**.

- Then choose from:
 - **Start** Sets the transform start time that is displayed on the FieldFox screen.
 - **Stop** Sets the transform stop time that is displayed on the FieldFox screen.

NOTE

Zero (0) seconds is always the calibration reference plane. Negative values are useful if moving the reference plane.

Distance Units

When markers are present on a Time Domain trace, marker X-axis values are shown both in units of time (seconds) and distance. Select the units in which the marker distance data is presented.

Distance Units are also used when setting Time Domain Line Loss. Learn more in [“Line Loss and Velocity Factor” on page 6-7](#).

Choose from: m (meters), or Feet.

Window Layout

This setting is used to create additional traces, or select a new layout for traces that are already created,

Choose from: x1, x2, x2H, x3H, x4H.

Learn more about [“Multi-Trace Configurations” on page 5-4](#).

Transform Window

There are abrupt transitions in a frequency domain measurement at the start and stop frequencies, causing overshoot and ringing in a Time Domain response. The Window setting reduces the abruptness of the frequency domain transitions. This causes you to make a trade off in the Time Domain response.

The Window setting applies to ALL traces.

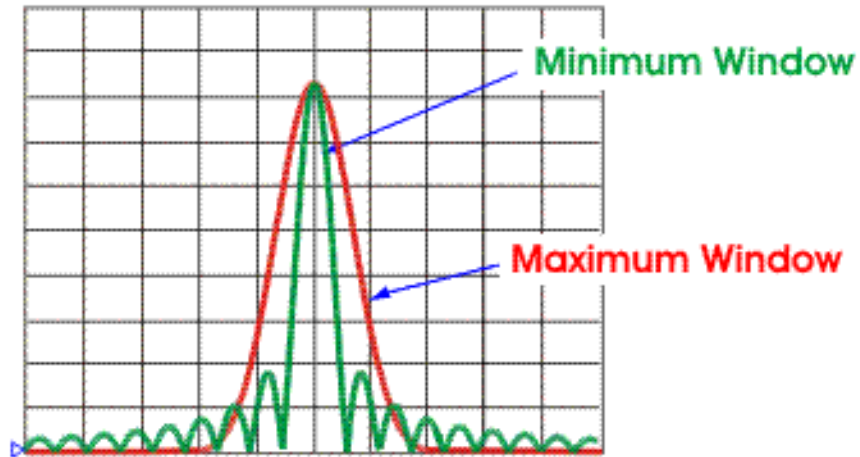

How to make Window setting

- Press **Measure 4**.
- Then **Transform**.
- Then **More**.
- Then **Transform Window**.
- A settings table appears that allows you to navigate and select the following settings. These settings are made exactly like those made on the Transform Settings table. Learn how in “**Transform Settings Table**” on **page 6-4**.

NOTE

Any of the following four methods can be used to make this same Window setting. Impulse Width values are calculated from the frequency span and Kaiser Beta value.

1. Window	Min	Medium	Max
2. Percent	0	50	100
3. Kaiser Beta	0	6.50	13.00
4. Impulse Width	100.455 ps	168.501 ps	231.284 ps

Line Loss and Velocity Factor

By default, the FieldFox does NOT correct Time Domain measurements to account for the inherent loss of a cable. However, to make more accurate measurements, Line Loss and Velocity Factor should be considered.

About Velocity Factor and Line Loss

- Velocity Factor is a property of the physical material of a cable. A VF of 1.0 corresponds to the speed of light in a vacuum, or the fastest VF possible. A polyethylene dielectric cable has VF = 0.66 and a cable with PTFE dielectric has VF = 0.7.
- Line Loss is specified in dB/m (or ft). In addition to the length of the cable, loss is also directly proportional to the frequency of the signal that passes through the cable.

The following is an example showing how Line Loss works:

The DUT is a 100 meter transmission cable. The Line Loss value is 1 dB/meter. This means that a signal traveling ONE WAY through the cable will lose 10 dB of power (100 m * 1dB/m). Because the FieldFox performs this measurement with 1 port, the test signal travels down the cable and then back, for a total loss of 20 dB.

For the purpose of illustrating this point, connect an OPEN to the end of the cable – a maximum-sized fault - for 100% reflection of the 300 MHz test signal.

Without compensation for the loss of the cable, a -20 dB response would be visible at 100 meters, which is the OPEN at the end of the DUT. This is from 10 dB of loss through the cable in each direction.

With compensation for the loss using the manufacturer's specification, the FieldFox compensates the trace as though the signal traveling through 100 meters was increased by +20 dB. Therefore the response will show 0 dB for 100% reflection.

Data Chain

This setting, available only on the Transform Settings Table, reverts to the default when the FieldFox is Preset. Choose from the following:

- **Standard** – The normal FieldFox data processing chain. Transform calculations are performed AFTER error correction and trace math.
- **8510** – The data processing chain used by the Keysight 8510 network analyzer. Transform calculations are performed BEFORE error correction and trace math. Learn more at the FieldFox Supplemental Online Help website:

<http://na.support.keysight.com/fieldfox/help/SupHelp/FieldFox.htm>

Trace Settings

The following two settings apply to specific traces.

Transform Enable

Enable Time Domain transform for the specific trace.

- Select the trace.
- Press **Measure Setup 4**.
- Then **Transform**.
- Then choose from:
 - **On** Trace displays Time Domain data.
 - **Off** Trace displays frequency domain data.

Gate Enable

Enable Gating for the specific trace.

- Select the trace.
- Press **Measure 4**.
- Then **Transform**.
- Then choose from:
 - **On** Trace displays Time Domain data.
 - **Off** Trace displays frequency domain data.

Gating

Perhaps the most beneficial feature of Time Domain transform is the Gating function. When viewing the Time Domain response of a device, the gating function can be used to “virtually” remove undesired responses. You can then simultaneously view a frequency domain trace as if the undesired response did not exist. This allows you to characterize devices without the effects of external devices such as connectors or adapters.

Gating is best performed while viewing a Time Domain trace. Then, either disable Transform, or separately view a frequency domain trace to see the trace with the gated effects removed.

NOTE

When a discontinuity in a test device reflects energy, that energy will not reach subsequent discontinuities. This can “MASK”, or hide, the true response which would have occurred if the previous discontinuity were not present. The Gating feature does NOT compensate for this.

How to make Time Domain Gating settings

- Press **Measure 4**.
- Then **Transform**.
- Then **Gating**.
- Then choose from:
 - **On** Gating is being performed.
 - **Off** Gating is NOT being performed.

Start, Stop, Center, and Span Gate Times

These settings specify the time in the trace to be gated (in or out). The gate times can be specified using either Start and Stop or Center and Span.

- Press **Gating Start Stop**.
- A settings table appears that allows you to navigate and select the following settings. These settings are made exactly like those made on the Transform Settings table. Learn how in **“Transform Settings Table” on page 6-4**.

Gating Type

This setting defines the type of filtering that will be performed for the gating function. The gate start and stop flags on the display point toward the part of the trace you want to keep.

Choose from the following:

- **Bandpass** KEEPS the responses within the Gating Start and Stop times.

- **Notch** REMOVES the responses within the Gating Start and Stop times.

Gating Shape

This setting defines the filter characteristics of the gate function. Choose from Minimum, Normal, Wide, Maximum.

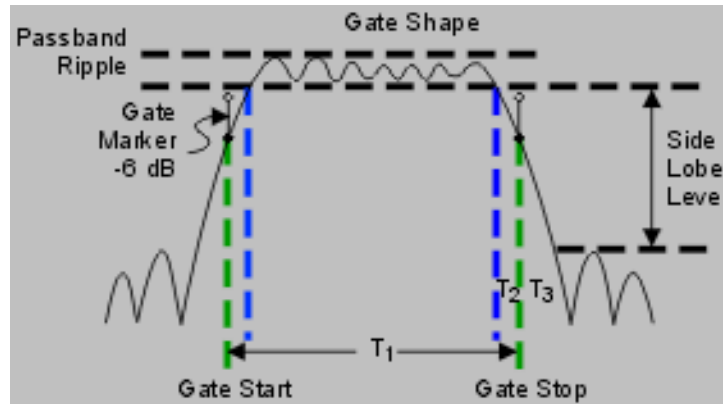

Time domain Gate Shape setting is shown in the graphic above.

Gate Shape	Passband Ripple	Sidelobe Levels	Cutoff Time	Minimum Gate Span
Minimum	±0.1 dB	-48 dB	1.4/Freq Span	2.8/Freq Span
Normal	±0.1 dB	-68 dB	2.8/Freq Span	5.6/Freq Span
Wide	±0.1 dB	-57 dB	4.4/Freq Span	8.8/Freq Span
Maximum	±0.01 dB	-70 dB	12.7/Freq Span	25.4/Freq Span

Cutoff time is the time between the stop time (-6 dB on the filter skirt) and the peak of the first sidelobe.

- T₁ is the gate span, which is equal to the stop time minus the start time.
- T₂ is the time between the edge of the passband and the 6 dB point, representing the cutoff rate of the filter.
- T₃ is the time between the 6 dB point and the edge of the gate stopband.

For all filter shapes T₂ is equal to T₃, and the filter is the same on both sides of the center time.

Minimum gate span is twice the cutoff time. Each gate shape has a minimum recommended gate span for proper operation. This is a consequence of the finite cutoff rate of the gate. If you specify a gate span that is smaller than the minimum span, the response will show the following effects:

- distorted gate shape that has no passband
- distorted shape
- incorrect indications of start and stop times
- may have increased sidelobe levels.

Time Domain – Option 010
Gating

7 Calibration for NA, CAT, and VVM Modes

Calibration removes the systematic errors that are associated with measurements in NA, CAT, and VVM Modes. Key presses are identical in all of these Modes.

In this Chapter

“Why and When to Calibrate” on page 7-2

“Definitions” on page 7-2

“Preset Calibration (also known as CalReady)” on page 7-3

“QuickCal” on page 7-3

“O, S, L Cal” on page 7-5

“Normalize” on page 7-6

“Compatible Mode Calibrations” on page 7-8

“Compatible 1-port and 2-port Calibrations” on page 7-8

“Save the Calibration” on page 7-9

“Verify a Calibration” on page 7-10

“Calibration Method Summary” on page 7-11

NOTE

ECal and Waveguide Calibrations are NOT supported on the N9912A.

See Also

Learn **How to Make 75 ohm Measurements** at the FieldFox Supplemental Online Help:

<http://na.support.keysight.com/fieldfox/help/SupHelp/FieldFox.htm>

Why and When to Calibrate

There are well-defined and understood systematic errors that are measured and calculated during the calibration process. These errors are caused by leakage signals inside the FieldFox, by the frequency response of the FieldFox receivers, and by reflections inside the FieldFox that interact with the DUT. After calibration, these errors are removed from subsequent measurements.

To maintain highest measurement accuracy, perform a new calibration when any of the following changes occur:

- When any of the following measurement settings change: Frequency Range, Power Level, and Resolution. Therefore, make these measurement settings before calibrating. Increased Averaging and higher Resolution cause slower sweeps and slower calibration times. Learn about Interpolation and Questionable Accuracy in [page 7-7](#).
- When the FieldFox temperature changes more than about 10°F (5°C). Learn more in [“How to monitor the internal FieldFox temperature:” on page 2-4](#).
- When the connection to the DUT changes, requiring a different jumper cable or adapter.

Definitions

DUT (Device Under Test) The cable, antenna, transmission line, or anything else that is connected to the FieldFox that is to be measured.

Calibration Standards - OPEN, SHORT, LOAD, and THRU

- **OPEN, SHORT, and LOAD** are calibration standards. These are precision components that are used during calibration and to terminate a DUT during some measurements. When an RF signal ‘hits’ these components, the signals are reflected in a predictable manner.
 - SHORT and OPEN standards both cause 100% of an RF signal to be reflected. The difference between these two standards is what happens to the phase of the reflected signal, which is beyond the scope of this discussion. Although an OPEN standard is a precision component, simply leaving **nothing** connected at the end of a cable can be a reasonable substitute for an OPEN.
 - A LOAD standard absorbs almost ALL of the incident signal and very little signal is reflected back to the source.

Calibration Reference Plane is the point at which cal standards are connected during a calibration. This can be either the FieldFox RF OUT connector, or at the end of a jumper cable or adapter.

Preset Calibration (also known as CalReady)

NOTE

CalReady (Preset calibration) only applies to S11 and Return Loss measurements. CalReady does not apply to S21 or Insertion Loss measurements. Also, you can interpolate the S11 calibration, but you cannot interpolate the S21 calibration or S21 normalization.

Every FieldFox is factory calibrated at the RF Out connector over the entire frequency range of the FieldFox using a number of data points that allows reasonable interpolation over the FieldFox frequency range.

This CalReady condition allows you to start using your FieldFox immediately if you are measuring a device that is directly connected to the RF Out test port. CalReady applies to the entire frequency range of the FieldFox. It can be used to check the integrity of the jumper cable.

Cal ON is shown on the screen when powered ON or Preset.

When measuring a DUT using a jumper cable or adapter - NOT a direct connection to the RF Out connector - then a QuickCal or O,S,L Cal is recommended.

Learn how to see when your factory CalReady calibration was performed in [“System Information” on page 22](#).

QuickCal

QuickCal is ideal for a quick and simple calibration of the measurement when using a jumper cable or adapter to connect the DUT to the FieldFox test ports. QuickCal corrects for phase shift, time delay, and loss of adapters or jumper cables.

QuickCal does not require a specific Cal Kit and is a very simple calibration. If the highest accuracy is required, a mechanical calibration with a high quality calibration kit is recommended.

If the DUT has 3.5 mm-female or SMA-female connectors, QuickCal is NOT recommended.

How to perform a QuickCal

Press **Esc** at any time during the QuickCal to stop the calibration.

- In CAT, NA, or VVM Mode, press **Cal 5**.
- Then (if necessary) press **Cal Type** to see **QuickCal**.
- Press **Start Cal**.

No Connection

- Disconnect the DUT from the FieldFox.

Calibration for NA, CAT, and VVM Modes Why and When to Calibrate

- If a jumper cable or adapter is required to connect the DUT to the FieldFox, connect those components to the FieldFox RF Out connector NOW. The effects of those components will be measured and removed during the calibration, and only the effects of the DUT will be displayed in the measurement results. These should be high-quality components!
- Do NOT connect anything at the cal reference plane where the DUT connects.
- Then Press **QuickCal**.



Optionally Connect Load(s)

- Connect a Load standard at the point where the DUT will be connected and press **Measure** under the following conditions:
 - When a jumper cable has too much loss. If a 'Cal Failed' error appears and you skipped the Load measurement, then perform the Cal again but include measuring the Load.
 - When your DUT has high return loss such as the reject band of a filter. Then measuring the load improves accuracy. Even with the optional Load, phase accuracy begins to degrade when the return loss is greater than about 20dB.

- Press **Skip Step** in all other cases and when making DTF measurements. Measuring a load would do little to improve accuracy.

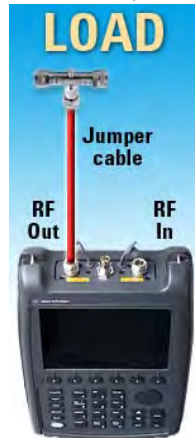

- Press **Finish**.
- **CAL ON Q** is shown on the screen for all displayed measurements that are corrected with QuickCal.

Using QuickCal with a Long Jumper Cable

QuickCal requires a sufficient frequency span to adequately characterize the jumper cable (the cable between the instrument port and the DUT). If a 'Cal Failed' error appears and you connected the optional Load standard, then increase the frequency span of the measurement until the error no longer appears. After the calibration, you can then decrease the frequency span as needed and rely on interpolation. Learn more about Interpolation in **“Interpolation” on page 7-7**.

QuickCal is also limited in how much jumper cable loss it can tolerate. If QuickCal without the Load is failing, then measure the Load during the QuickCal to see if that resolves the issue.

O, S, L Cal

An OPEN, SHORT, LOAD Cal is performed using discrete standards from a Cal Kit. Several Cal Kit definitions are built into the FieldFox firmware.

NOTE

Visit www.keysight.com/find/fieldfoxsupport to see a complete list of supported Cal Kits. Also at this website, download Data-Link software that allows you to edit Cal Kit definitions or add a new Cal Kit.

O, S, L Cal are extremely accurate when performed using the correct Cal Kits with standards that are clean and in good repair, and when using correct connection procedures.

CAL ON U is shown on the screen when an O,S,L Cal is correcting the measurement.

How to perform a O, S, L Cal

Before performing an O,S,L Cal, set the Measurement type, Frequency Range, Power Level, and Resolution of the measurement. The calibration will remain highly accurate until these settings change, or the physical connection to the FieldFox changes.

- Disconnect the DUT from the FieldFox.
- If a jumper cable or adapter is required to connect the DUT to the FieldFox, then connect **those** components to the FieldFox Out connectors NOW. The effects of those components will be measured and removed during the calibration, and only the effects of the DUT will be displayed in the measurement results. **These should be high-quality components!**
- In CAT or NA Mode, press **Cal 5**.
- Then (if necessary) press **Cal Type** to choose **O.S.L**.
- Then using the **▲▼** arrows or the rotary knob, select the connector type and gender of your DUT port to be measured and press **Enter**. This will determine the type and gender of Cal Kit to use. For example, if a Type-N Male connector is used on the DUT port to be measured, then the Type-N Male standards (OPEN, SHORT, AND LOAD) will ALL be connected in place of the DUT during the calibration.
- If there is more than one Cal Kit for the selected connector type, press **Cal Kit** and select the correct Cal Kit to use.

NOTE

Calibration kit definitions are unique to each connector type and connector sex. They must be correctly applied to obtain the most accurate calibration.

-
- Then press **Start Cal**.
 - Press **Open**, **Short**, and **Load** in any order.
 - Connect the corresponding standard at the point where the DUT will be connected, then press **Measure**.
 - Measure each of the three standards. Standards can be measured again at any time if you feel a standard was not connected securely.
 - Press **Finish** to complete the O,S,L calibration.

Normalize

Normalize is used to calibrate a 2-port Insertion Loss measurement (CAT Mode) and a S21 Transmission measurement (NA Mode). One of these measurements must be selected before performing a Normalize Cal.

NOTE

A Normalization Cal is REQUIRED to make **accurate** 2-port Transmission or Insertion Loss measurements.

How to perform a Normalization

- Press **Cal 5**.
- **Cal Type [Normalize]** should appear.
- Connect a short, high-quality, phase stable cable between the FieldFox RF OUT and RF IN connectors.

NOTE

All subsequent insertion loss measurements are made relative to the insertion loss of this cable. For example, if you use a Normalization cable with 1 dB of loss, then after pressing **Normalize**, the display will show 0 dB of loss with this cable in place. Therefore, for highest accuracy, when measuring the DUT also attach the cable that was used in the normalization cal.

-
- Press **Start CAL** then **Thru** then **Measure**.
 - Press **Finish**.
 - Connect the DUT between the RF OUT and RF IN connectors.

NOTE

A Normalization cal will NOT be interpolated if the Resolution or Frequency range changes.

CAL ON U is shown on the screen when a Normalization Cal is correcting the measurement.

Interpolation

Highest measurement accuracy is achieved when the frequency range or resolution settings remain the same during the measurement as when the FieldFox was calibrated. If these settings change after performing a calibration, the FieldFox will interpolate the calibration so that VERY accurate measurements continue to be made.

Interpolated Calibrations are only slightly less accurate than a calibration performed at the measurement settings.

For example, if frequency settings change after a Preset Calibration is performed, the Preset Calibration is only slightly less accurate.

Learn more about the relative accuracy of FieldFox calibrations in below.

When a calibration that you performed is being interpolated, an asterisk is added to the screen annotation as follow: Cal ON*.

For highest accuracy: a new cal should be performed when the temperature changes more than about 10F (5C), or when the connection to the DUT requires a different jumper cable or adapters.

How to turn Error Correction OFF

"Error Correction" is applying the results of a calibration to a measurement. Error Correction is automatically turned ON after a calibration. You could turn Error Correction OFF in order to see the effects of a calibration on the measurement.

- Press **Cal 5** then Error Correction ON OFF.
- Then **Exit** or **Esc**.
- **Cal OFF** is shown on the screen when Correction is OFF.
- **Cal OFF*** is shown on the screen when switching from a 1-port measurement to a 2-port measurement or vice-versa. Calibration for the current measurement has NOT been performed.

Cal ON ? – Questionable Accuracy

If a change made by the user to the output power setting, or a change made automatically by the FieldFox firmware makes accurate calibration interpolation questionable, a question mark is added to the screen annotation for all calibration states (Ex: **CAL ON ?**). The resulting measurement accuracy depends on how much the setting has changed. For optimum accuracy, recalibrate using the new settings.

Compatible Mode Calibrations

Because CAT, NA, and VVM modes are very similar, a 1-port or 2-port calibration that is performed in one mode is automatically applied in the other modes. This occurs ONLY when modes have the same frequency data points, have the same Power Level, and have the same IF BW. CAT Mode IF BW is 30 kHz and is NOT selectable.

Compatible 1-port and 2-port Calibrations

Typically, a 1-port calibration and a 2-port normalization can NOT be maintained at the same time. The most recently performed calibration will usually overwrite the other.

- In CAT mode, the 1-port measurement is Return Loss or DTF, and the 2-port measurement is Insertion Loss.
- In NA mode, the 1-port measurement is S11, and the 2-port measurement is S21.

However, a 1-port calibration CAN coexist with a 2-port normalization ONLY when BOTH of the following conditions occur:

1. A 1-port Cal already exists, then a Normalization Cal is performed. They can NOT be performed in the reverse order.

Calibration for NA, CAT, and VVM Modes Why and When to Calibrate

2. The Frequency Range, Resolution, Power (Hi/Low), and IF BW (in NA Mode) settings of the two calibrations are identical.

When both conditions occur, you can switch between the 1-port and the 2-port measurements, and both will remain fully calibrated.

In a DTF measurement, the frequency range over which the calibration is made can be viewed using the calculated Start and Stop Frequency on the Settings page. Learn how to see this in [“Calculated DTF values” on page 4-26](#).

Save the Calibration

After performing any type of calibration, you can save the FieldFox settings along with the calibration into a STATE (*.sta) file. These settings and calibration can then be recalled as necessary. To learn how, see [“Saving and Recalling Files” on page 17-2](#).

Verifying Calibration and Jumper Cable Integrity

After calibrating, it is important to verify that the calibration is good. When using a jumper cable, also verify that the cable is of high quality.

Verify a Calibration

- Connect a LOAD standard at the calibration reference plane (where calibration standards were connected). This may be at the end of the jumper cable or at FieldFox RF OUT connector.
- In CAT Mode, select a **Return Loss**.
- In NA Mode, select **S11** with Log Mag format.
- Observe the trace on the FieldFox screen:
 - Lower than 40 dB indicates a GOOD calibration.
 - Higher than 30 dB indicates that you should recalibrate.

Verifying Phase Accuracy

- Connect a LOAD standard at the calibration reference plane (where calibration standards were connected).
- In NA Mode, select a S11 Reflection with Polar or Smith Chart format.
- Because all LOAD standards have delay, you should see a small amount of phase rotation as a function of frequency.
- In general, the measurement result should agree with the characteristics of the calibration standard.

Test the Jumper Cable

With the LOAD standard still connected, move the jumper cable while observing the trace.

- If the measurement trace is relatively stable, the jumper cable is of good quality.
- If you observe significant movement in the peaks of the measurement trace when moving the cable (>5 dB), the jumper cable may need to be replaced.

Calibration Method Summary

- **O,S,L** is ALWAYS the most accurate Cal method. The quality of a O,S,L is completely dependent on the quality of the OPEN, SHORT, LOAD standards. Use the correct high quality standards to ensure the most accurate calibration.
- **QuickCal** is ideal for DTF measurements. QuickCal should be performed when good accuracy is required and when using a jumper cable or adapter.
 - QuickCal is NOT recommended when the DUT has 3.5 mm-female or SMA-female connectors.
 - Even with the optional Load, phase accuracy begins to degrade when the return loss is greater than about 20dB.
- **Present Cal** is ONLY useful for DUT connections made at the RF Out port and most accurate at room temperature.
- **For highest accuracy**, a new QuickCal or O,S,L Cal should be performed:
 - When the temperature changes more than about 10°F (5°C)
 - When the connection to the DUT requires a different jumper cable or adapters.

Calibration for NA, CAT, and VVM Modes
Calibration Method Summary

8 SA (Spectrum Analyzer) Mode

SA Mode measures signals at the RF IN port. The RF OUT connector is NOT used.

General purpose Spectrum Analyzer measurements are available with Option 230 or 231. SA measurements require NO calibration.

For a comprehensive SA Mode tutorial, see Spectrum Analysis Basics (App Note 150) at <http://literature.cdn.keysight.com/litweb/pdf/5952-0292.pdf>

Figure 8-1 SA Display with Markers

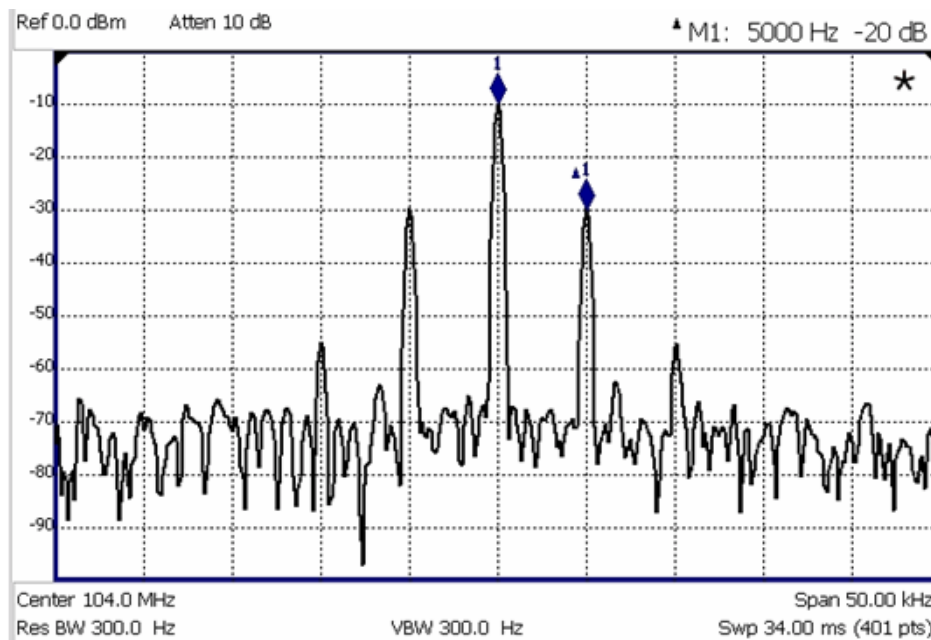

The graphic above shows an SA display with markers.
Carrier with 5 kHz frequency modulation and deviation of 1 kHz.

In this Chapter

“Frequency Range” on page 8-4

“Radio Standard” on page 8-6

“Channel Selection” on page 8-7

“Scale and Units” on page 8-8

[“External Gain” on page 8-10](#)

[“Attenuation Control” on page 8-10](#)

[“Preamplifier Control \(Opt 235\)” on page 8-11](#)

[“Check for Compressed Measurements” on page 8-11](#)

[“Field Strength Measurements” on page 8-12](#)

[“Tune & Listen \(AM/FM\)” on page 8-16](#)

[“Independent Source” on page 8-18](#)

[“Resolution Bandwidth \(Res BW\)” on page 8-20](#)

[“Video Bandwidth \(Video BW\)” on page 8-21](#)

[“Sweep Type” on page 8-21](#)

[“Sweep Acquisition” on page 8-22](#)

[“Very Long Sweep Times” on page 8-23](#)

[“Zero Span Measurements” on page 8-23](#)

[“Triggering” on page 8-25](#)

[“Single / Continuous / Restart” on page 8-27](#)

[“Points” on page 8-27](#)

[“Trace Display States” on page 8-28](#)

[“Average Type” on page 8-29](#)

[“Average Count” on page 8-29](#)

[“Detection Method” on page 8-30](#)

[“Display Line” on page 8-31](#)

[“Noise Marker” on page 8-32](#)

[“Band/Interval Power Marker” on page 8-33](#)

[“Frequency Counter at Marker” on page 8-34](#)

[“Audio Beep at Marker Power” on page 8-35](#)

[“Channel Measurements” on page 8-37](#)

See Also

Interference Analyzer (Opt 236):

[“Spectrogram Display” on page 9-2](#)

[“Waterfall Display” on page 9-5](#)

[“How to Record a Session” on page 9-9](#)

Optional Settings:

[“All about Markers” on page 16-2](#)

[“All about Limit Lines” on page 16-14](#)

[“Saving and Recalling Files” on page 17-2](#)

SA Mode Settings

Select SA Mode before making any setting in this chapter.

Because there is no calibration, these settings can be made in any order.

How to select SA Mode

- Press **Mode**
- Then **SA**.

Frequency Range

The X-axis frequency range determines the frequencies that are measured for each sweep. The default Start frequency is 0 Hz. However, the Start frequency can be set as low as -100 MHz. The internal LO of the FieldFox can be seen at 0 Hz, which will mask signals that may be present.

NOTE

Although the start frequency can be set as low as -100 MHz, amplitude accuracy is specified above 2 MHz. Below 2 MHz, frequency accuracy is maintained, but amplitude accuracy is degraded.

The frequency range of the measurement can be changed using the following methods:

- Set Center and Span frequencies.
- Set Start and Stop frequencies.
- Toggle between Zero and Last selected span.
- Set Full Span of the FieldFox .
- Using Channel selection. Learn how in [“Channel Selection” on page 8-7](#).
- Using Marker -> Center (frequency). Learn how in [“How to use Marker Functions” on page 16-12](#).

How to set Frequency Range

- Press **Freq/Dist**.
- Then choose from the following:
 - **Center** and **Freq Span** frequencies. This is the most common method of entering frequency range. Enter the frequency of interest. The Center frequency is at the exact center of the X-axis. The Frequency Span places half of the frequency range on either side of center. When the Center and Frequency Span values are entered, then the X-axis annotation on the screen shows the Center and Span frequencies.

- **Start** and **Stop** frequencies. Start is the beginning of the X-axis and Stop is the end of the X-axis. When the Start and Stop frequencies are entered, then the X-axis annotation on the screen shows the Start and Stop frequencies.
- Follow each of these by entering a value using the numeric keypad, the **▲▼** arrows, or the rotary knob.
- When using the **▲▼** arrows, press **Enter**. The increment setting of the arrows is based on the current span. This can be changed in SA Mode. See **How to change frequency step size** below.
- After using the keypad, select a multiplier key. Learn more in **“Multiplier Abbreviations” on page 2-14**.

Two more ways to change the frequency range

- Press **Freq/Dist**
- Then choose from the following:
 - **Zero/Last Span** Each key press toggles the frequency span between 0 Hz and the last specified frequency span. Learn more about Zero Span in **“Zero Span Measurements” on page 8-23**.
 - **More**
 - Then **Full Span** Selects the entire frequency span of the FieldFox. The Center frequency is set automatically.

How to change frequency step size

When using the **▲▼** arrows to change any of the frequency settings, the size of the frequency step can be changed.

- Press **Freq/Dist**
- Then **More**
- Then **CF Step Auto Man**
 - **Auto** Each press of the **▲▼** arrows increments or decrements the value by 1/10th (one division) of the current frequency span. **Note:** To change this setting from **Manual** to **Auto**, press **CF Step** twice.
 - **Manual** Type a step size value using the numeric keypad, then select a multiplier key. Learn more in **“Multiplier Abbreviations” on page 2-14**.

Radio Standard

A Radio Standard is a collection of settings that are applied to the FieldFox for specific RF protocols. When a Radio Standard is applied, the FieldFox frequency and channel settings change to that of the standard.

By default, the FieldFox locates the center frequency of the standard in the middle of the screen and sets the frequency span to cover all of the Uplink and Downlink frequencies. The selected Radio Standard name appears in the center of the screen below the X-axis.

After a Radio Standard has been selected, the frequency range can be changed by selecting channel numbers rather than frequency. Learn how in [page 8-4](#).

When a Channel Measurement is selected such as ACPR, other relevant settings will be changed such as Integration BW. Learn more about [“Radio Standards and Channel Measurements” on page 8-37](#).

How to select a Radio Standard

- Press **Measure 1** OR **Freq/Dist** then **More**.
- Then **Radio Standard**.
- Then select a standard using the **▲▼** arrows or rotary knob and press **Enter**.

Custom Radio Standards

Beginning with Rev A.05.50, your own custom Radio Standards can be imported into the FieldFox. Custom standards are created in *.csv (spreadsheet) format.

A template and instructions for creating your custom Radio Standard is at: <http://na.support.keysight.com/fieldfox/help/SupHelp/Reference/CustomRadioStandard.htm>

Once imported, the *.csv file is stored in the FieldFox \User Data\ folder. The custom Radio Standards are read and presented at the top of the list of internal Radio Standards.

How to Import and Delete a Custom Radio Standard

First, press **Save/Recall** and select the **Device** from which the Radio Standard will be read. Most likely this will be **USB** or **SD Card**.

- Press **Measure 1** OR **Freq/Dist** then **More**.
- Then **Radio Standard**.
- Then **Import Radio Standards**.

- Then select the *.csv file using the **▲▼** arrows or rotary knob and press **Enter**.
- Custom Radio Standards can be removed from the FieldFox by selecting **Measure 1** then **Radio Standard** then **Delete Radio Standard**.
- Then select the *.csv file to delete using the **▲▼** arrows or rotary knob and press **Enter**.

NOTE

To overwrite a custom standard that is already uploaded to the FieldFox, you must first delete the *.csv file from the FieldFox, then re-upload the file that contains the standard. A predefined internal standard (such as GSM 450) can NOT be deleted from the FieldFox.

Channel Selection

After a Radio Standard has been selected, the frequency range can be changed by selecting channel numbers rather than frequency. Once enabled, the channel number is appended to the X-axis frequency range.

How to Enable Channel selection

- Press **Freq/Dist**.
- Then **More**.
- Then **Unit Freq Chan**.

How to change the Channel Number of the Measurement

With Unit = **Chan** the FieldFox will NOT allow you to specify channels outside of the selected Radio Standard.

- Press **Freq/Dist**.
- Then choose from the following:
 - **Center Channel** Places the center frequency of the specified channel in the middle of the X-axis.
 - **Start Channel** Places the lowest frequency of the specified channel at the beginning of the X-axis.
 - **Stop Channel** Places the highest frequency of the specified channel at the end of the X-axis.
 - **Freq Span** Changes the span of frequencies while the center frequency remains unchanged.
 - Follow each of the above settings by entering a value using the numeric keypad or the rotary knob.

SA (Spectrum Analyzer) Mode SA Mode Settings

- Use the  arrows to increment the channel number by an amount specified by the Channel Step value (see below).
- Then press **Enter**.

Select either Uplink or Downlink Frequencies

Press **Chan Direction** to toggle between **Uplink** and **Downlink**. If either of these selections is not available, then the selected Radio Standard does not contain those frequencies.

Channel number X-axis annotation

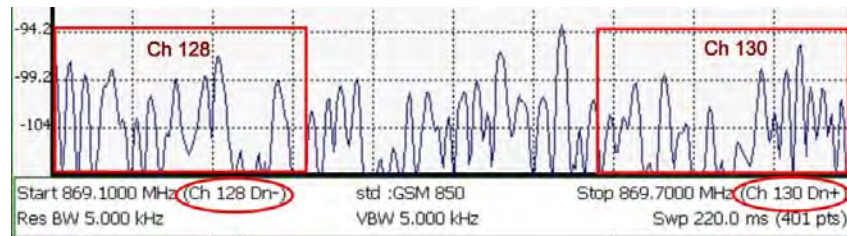

- **Dn** indicates **Downlink** frequencies.
- **Up** (not shown) indicates **Uplink** frequencies.
- **(-)** indicates that the lowest frequency in the channel (128) is at the left edge of the screen.
- **(+)** indicates that the highest frequency in the channel (130) is at the right edge of the screen.
- When Center Channel or Freq Span is specified, the X-axis shows the Center Freq (Channel) and Frequency Span.
- When Start or Stop Channel is specified, the X-axis shows the Start Freq (Channel) and Stop Freq (Channel).

Change Channel Step Size (Optional)

This setting allows you to use the  arrows to increment the channel number by the specified value.

- Press **Channel Step**.
- Enter a step value using the numeric keypad, the  arrows, or the rotary knob. Then press **Enter**.

Scale and Units

Adjust the Y-axis scale to see the relevant portions of the data trace.

The Y-axis is divided into 10 graticules. A Reference Level is shown on the screen as a solid horizontal bar that can be placed at any graticule.

When RF Attenuation set to **Auto**, the RF Attenuation is coupled to Reference Level.

How to set Scale

Press **Scale / Amptd**. Then choose from the following:

- **Scale Type [current setting]**
 - **Log** Logarithmic scale (default setting). The Y-axis reference line represents the specified absolute Reference Level in the current Unit selection. Y-axis graticules show dB below or above the reference line.
 - **Lin** Linear scale. The Y-axis reference line represents the specified absolute Reference Level in the current Unit selection. Y-axis graticules show percent of Reference Level (%) below or above the reference line.

Manually set Scale, Reference Level, and Reference Position.

- **Scale** Manually adjust the scale per division to view specific areas of the current trace. Enter a value using the numeric keypad, the **▲▼** arrows, or the rotary knob. Then press **Enter**.
- **Ref Level** Manually set the value of the reference line. Enter a negative value by pressing **Run/Hold (+/-)** either before or after typing a value. This can also change the RF Attenuation setting. See **“Attenuation Control” on page 8-10**.
- **Ref Position** Manually set the position of the reference line. Values must be between 0 (TOP line) and 10 (BOTTOM line). Default position is zero (top).
- Press **More**, then **Autoscale** Automatically adjusts the Y-axis to comfortably fit the Min and Max amplitude of the trace on the screen.

How to Set Y-axis Units

The Unit setting appears for the reference line, marker readouts, and trigger level. All Unit choices are available in both Log and Linear Scale Types.

The UNIT setting survives Mode Preset, but NOT Preset.

- Press **Scale / Amptd**, then **More**, then **Unit**.
- Then choose from the following:
 - **dBm** (default setting), **dBmV** (dB milli Volts), **dBuV** (dB microVolts), **W** (watts), **V** (volts), **A** (amps), **dBmA** (dB milliAmps), **dBuA** (dB microAmps).

Antenna correction units are available ONLY by loading or editing an Antenna file that contains the desired units setting. Learn more in **“Using the Antenna/Cable Editor” on page 8-13**.

External Gain

When using an external amplifier or attenuator, the SA mode trace amplitude values can be offset to compensate for the effect of the external device. This effectively moves the reference plane of the SA measurement port out to just beyond the external device. For example, when using an external preamp with gain of +10 dB, enter this value for External Gain, and the data trace across the displayed frequency span will be adjusted down by 10 dB.

When RF Atten is set to Auto, you may see a change in the RF Attenuation value. This is an attempt to measure the signal at top of screen (the Reference Level) without overloading the SA first mixer.

How to Set External Gain

- Press **Scale/Amptd**.
- Then **More**.
- Then **External Gain**.
- Enter a value using the numeric keypad, the **▲▼** arrows, or the rotary knob (positive for gain; negative for loss). Values less than 5 dB must be typed using the numeric keypad. Then press **Enter**.

ExtGain xx dB is shown at the top of the screen.

Attenuation Control

Both the RF Attenuation and Pre Amp functions control the power level into the SA.

When too much power is present at the RF Input port, **ADC Over Range** appears on the FieldFox screen. This does not necessarily mean that damage has occurred, but that the measurement is probably compressed.

When high power levels are present at the RF Input port, internal attenuation can be switched in to keep the FieldFox receiver from compressing. At extremely high power levels, use external attenuation to protect the internal circuitry from being damaged.

WARNING

The FieldFox can be damaged with too much power.

RF Damage Level: +27 dBm

DC Damage Level: ±50 VDC

The displayed power level is automatically adjusted for RF Attenuation. As the attenuation value changes, the displayed power level should NOT change.

How to set Attenuation

The default Attenuation setting is 10 dB. This value can be changed from 0 to 31 dB in 1 dB steps.

- Press **Scale/Amptd**.
- Then **RF Atten Auto Man**.
- **Auto** RF Attenuation is set by adjusting the Reference Level. As the Reference Level is lowered, for example from –10 dBm to –30 dBm, the FieldFox assumes that you are looking at low-level signals. The RF Attenuation value is automatically lowered in 5 dB steps to allow low-level signals to be viewed. The RF Attenuation value is never automatically lowered below 5 dB.
- **Man** RF Attenuation is set manually. Enter a value between 0 to 30 dB in 5 dB steps using the numeric keypad, the **▲▼** arrows, or the rotary knob. Then press **Enter**.

#Atten xx dB is shown at the top of the screen. (#) means manual setting.

Preamplifier Control (Opt 235)

When **very low-level** signals are analyzed, an internal preamplifier can be used to boost the signal level by approximately 22 dB. The gain of the preamp is NOT adjustable. The displayed signal level is automatically adjusted for the increase in system gain.

How to control the Preamp

By default, the preamp is OFF.

- Press **Scale/Amptd**.
- Then **Preamp ON OFF**. The underlined setting is the current setting. When ON, **PA** is shown to the left of the graticules on the display.

Check for Compressed Measurements

Compression occurs when too much power into an amplifier causes it to no longer amplify in a linear manner. When too much power goes into the FieldFox RF Input connector, the amplifiers in the SA receiver compress and signal power will not be displayed accurately. This can occur even if **ADC Over Range** is not displayed because devices other than the ADC, such as the mixer, might be compressed. Increase the RF Attenuation value to prevent the SA receiver from being compressed.

How to Check for a Compressed Measurement

- Using a marker at the signal peak, make note of the signal power level.
- Increase the RF Attenuation level by 5 dB.
 - If the signal level does NOT change, then NO compression exists. This indicates that the signal is in the linear region of the FieldFox receiver.

- If the signal level DOES increase, then the receiver was compressed. Set the RF Attenuation value at the setting when further increases no longer result in an increase in the displayed power level.

Field Strength Measurements

To measure the strength of any signal transmitted through the air, an antenna must be connected to the FieldFox. The Field Strength feature allows you to enter the frequency response of the receiving antenna (the Antenna Factor) and associated cabling, and then have amplitude corrections automatically compensate the displayed trace for that response.

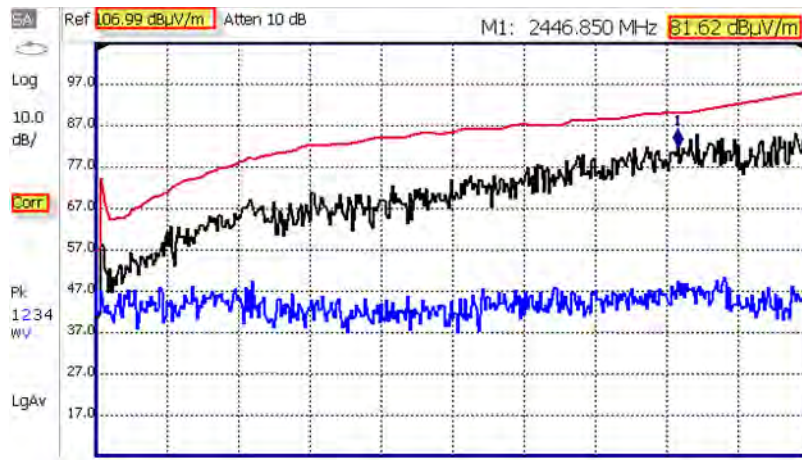

Field Strength Measurements

Trace 1 - Corrected trace with antenna factor. (Antenna = ON, Apply Corr = ON)

Trace 2 - Uncorrected trace (Apply Corr = OFF).

Red Trace - Current correction factor. See below.

- Learn **“How to Set Y-axis Units”** on page 8-9.
- Use a Band Power marker to measure total power over a range of frequencies. Learn how in **“Band/Interval Power Marker”** on page 8-33

How to select and edit corrections for Field Strength measurements

The Antenna and Cable correction data survives a Mode Preset and Preset.

All Correction ON/OFF states survive a Mode Preset, but NOT a Preset.

- Press **Scale/Amptd**.
- Then **More**.
- Then **Corrections**.
- Then choose from the following:
 - **Apply Corrections ON OFF** Turn ON and OFF correction for all settings.

- **SrcSide Antenna Off / On** Edit/Recall an Antenna file to be used to transmit.
- **RcvrSide Antenna Off / On** Edit/Recall an Antenna file to be used to receive.
- **SrcSide Cable Off / On** Edit/Recall a Cable file to be used on the Source side.
- **RcvrSide Cable Off / On** Edit/Recall a Cable file to be used on the Receiver side.
- **View Corrections ON OFF** Turn ON and OFF Pink Trace - Antenna/Cable corrections. This is a composite of all cable/antenna corrections that are currently applied. Available as a useful visual aid, the zero “dB” level (no net correction) is mapped to appear at the -50 dBm on-screen level.

The following menu appears when any of the above Antenna or Cable softkeys are pressed:

- **Antenna/Cable ON OFF** Turn correction ON or OFF for this Antenna/Cable.
- **Edit Antenna/Cable** Edit an Antenna/Cable Correction table. See Using the Antenna/Cable Editor (below) for more information.
- **New** Create a new Antenna/Cable. See Using the Antenna/Cable Editor (below) for more information.
- **Save Antenna/Cable** Save the modified Antenna/Cable to a file on the specified Storage Device.
- **Recall Antenna/Cable** Read an existing Antenna/Cable file from the specified Storage Device.
- **Storage Device** Choose from: Internal, USB, SD. Learn more about these selections in **“Set File Type and Select Device” on page 17-5.**

When finished, press **Back** to return to the previous menu.

Using the Antenna/Cable Editor

The Antenna Editor and the Cable Editor menus are very similar. Both tables include header information, and a Frequency/Value table.

NOTE

The FieldFox limits Antenna and Cable correction to a maximum of 10001 values.

Figure 8-2

FieldFox Antenna Editor

Setting	Value
Description	Correction Fa
Freq Interpolation	ILIN
Antenna Unit	dB μ V/m
Frequency	Antenna Factor
26.00000000 MHz	20.000 dB
30.00000000 MHz	17.500 dB

How to use the Antenna/Cable Editor

- Press **New** then **Yes** to clear all data from the existing Antenna or Cable table and reset header information to default settings.
- Then **Edit Antenna** or **Edit Cable** to open the Antenna / Cable Editor.
- Then use the **▲▼** arrows to select a field.
 - To edit header information, press **Edit** then modify the selected field using the FieldFox labeler.
 - **Description**: Enter a description for the antenna or cable correction table. This is NOT the filename used to save the file.
 - **Antenna Unit (Rcvr-side Antennas only)**: Units in which the measurement will be displayed. Select **NONE** (default setting) to select from standard SA Units on the Scale menu. Learn how in **“Scale and Units” on page 8-8**.
 - Choose from: **dB μ V/m** - (dB micro Volts per meter), **dB μ A/m** - (dB micro Amps per meter), **dBG** (gauss), **dBpT** (tesla).
 - **Freq Interpolation**: Set to LINear and can NOT be edited.
 - To edit Frequency/Value pairs, enter numbers using the numeric keypad, and a frequency suffix when necessary.
 - For both **Cable and Antenna correction**, Positive numbers indicate loss (we need ADD something positive to compensate for it), and Negative is indicative of some existing gain.

- **Antenna Factor** describes the dB value needed to accurately display a far-field signal in terms that are in the units listed below. When the antenna has low gain, or low efficiency, the dB value to be added is larger.
- When one Freq/Value pair is entered, that correction value is applied to the entire displayed frequency span.
- When two or more Freq/Value pairs are entered, the data points between the lowest and highest frequencies are corrected. Linear interpolation is applied between frequencies when necessary.
- Optionally choose from the following:
 - **Previous / Next Page** Quickly scrolls through pages of Freq/Value data.
 - **Add Row** Add a blank Freq/Value pair to the table,
 - **Delete/Clear** then:
 - **Delete Row** Remove the selected Freq/Value pair from the table.
 - **Clear All** then **Yes** Remove all Freq/Value pairs from the table and resets header information to default settings.

When the table edits are complete

- Press **Done** to close the Antenna/Cable Editor.
- Press **Save Antenna** or **Save Cable** to save your changes to the specified Storage Device. Enter a filename using the FieldFox labeler (learn more in **“How to use the FieldFox labeler” on page 17-3**). Learn more about Antenna and Cable files below.
- **Antenna/Cable ON OFF** Turn correction ON or OFF for this Antenna/Cable.

About Antenna and Cable files

- Cable files are saved and recalled from the **Cables** folder.
- Antenna files are saved and recalled from the **Antenna** folder.
- If the folder does not already exist on a USB or SD card, it is created automatically before storing the file.
- All SA mode Antenna and Cable files are saved and recalled as *.csv files, which allows them to also be read by spreadsheet programs.
- The FieldFox can also read *.ANT (Antenna) files that were created from older Keysight Spectrum Analyzers.
- Data Link does NOT support the SA Mode cable or antenna (*.csv or *.ANT) files. Learn more about Data Link software at:
www.keysight.com/find/fieldfoxsupport

How to create a Cable file from an S21 (NA mode) measurement

1. Measure the S21 of a cable.
2. Use Manage Folders to change the active folder to CABLES. Learn how in **“Manage Folders” on page 17-8.**
3. While in NA mode, save the measurement as a *.csv file. Learn how in **“How to Save a File” on page 17-2.**
4. In SA mode, select Corrections, then recall the *.csv file for correction.

Tune & Listen (AM/FM)

The Tune & Listen feature can be used to identify an interfering AM or FM signal.

The demodulated AM or FM signal can be heard through the internal speaker or through headphones using the 3.5 mm jack located on the FieldFox side panel.

The Tune & Listen tuner is separate from the SA display. This allows you to listen to one frequency while displaying a different range of frequencies. The Tune & Listen measurement alternates between normal SA sweeps for the display and performing audio demodulation at the Tune Frequency. See the Listen Time setting for more information.

Figure 8-3 Tune & Listen ON

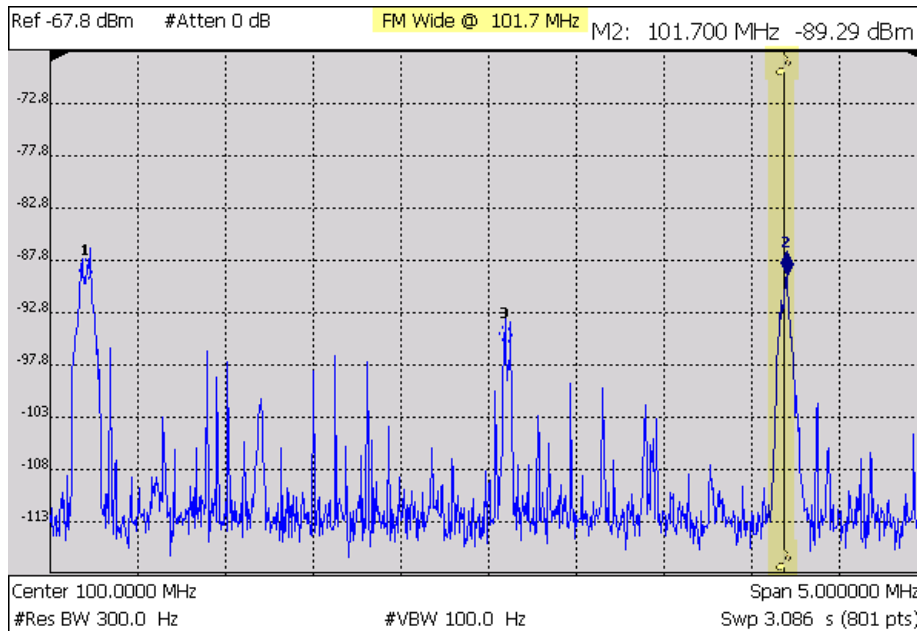

In the graphic above, Tune & Listen ON with Tune Frequency is indicated by a vertical bar (highlighted).

How to select Tune & Listen

- Press **Measure 1**.
- Then **Tune & Listen**.
- Then choose a demodulation type. Select a setting based on the type of interfering signal you suspect is being broadcast.
 - **None** Turns Tune & Listen OFF
 - **AM** Amplitude Modulation
 - **FM Narrow** Frequency Modulation; Narrow bandwidth. Choose when interfering transmission consist of voice or data.
 - **FM Wide** Frequency Modulation; Wide bandwidth. Choose for high quality music transmissions of FM broadcast radio.

Tune Frequency

The Tune & Listen tuner is separate from the SA display. This allows you to listen to one frequency while displaying a different range of frequencies.

Set the Tune Frequency using one of three methods:

1. Selecting Preset, Mode Preset, or Meas Preset sets Tune Frequency to 3.0 GHz.
2. Specify Tune Frequency:
 - Press **Meas Setup 4**.
 - Then **Tune Freq**.
 - Enter a value using the numeric keypad, **▲▼** arrows, or the rotary knob. Then select a multiplier key. Learn about multiplier abbreviations [“Multiplier Abbreviations” on page 2-14](#).
3. Using Mkr->Tune Freq:
 - Create a normal marker at the frequency of interest. Learn how in [“How to create Markers” on page 16-2](#).
 - Press **Mkr->/Tools**
 - Then **Mkr->TuneFreq** to change the Tune Frequency to that of the marker.

NOTE

To improve sound quality, try increasing power by reducing the Attenuation setting and, if available, turn ON the Preamplifier. Learn how in [“Attenuation Control” on page 8-10](#)

Listen Time

While Tune & Listen is actively demodulating a signal, the SA does not sweep and update the display. Listen Time sets the amount of time that the FieldFox demodulates, then stops to perform a single sweep and update the display, then again demodulates.

To select Listen Time:

- Press **Meas Setup 4**.
- Then **Listen Time**.
- Enter a value using the numeric keypad, **▲▼** arrows, or the rotary knob. Then select a multiplier key. Learn more in [“Multiplier Abbreviations” on page 2-14](#).

Volume Control

To increase or decrease the Volume of the demodulated signal:

- Press **Meas Setup 4**.
- Then **Volume**.
- Enter a value in percent between 0 and 100 (loudest) using the numeric keypad, **▲▼** arrows, or the rotary knob.
- Volume can also be changed and easily muted from the **System** menu. Learn more in [“How to set FieldFox Volume Control” on page 5](#).

Demod ON and OFF

To quickly stop the audio demodulation and perform only the normal SA sweeps, select the following:

- Press **Meas Setup 4**.
- Then **Demod ON OFF**.

Independent Source

NOTE

For best results, when using the independent source feature, the battery saver features should be turned off. Refer to "Setting the Battery Saver to OFF" on [page 8-20](#) and to [“Preferences” on page 18-7](#).

A tracking generator, a popular option with Spectrum Analyzers, is a source which always tracks the SA receiver.

Like a traditional tracking generator, the Independent Source feature can set the internal FieldFox source to track the SA receiver frequency range. It can also set the internal source to a CW frequency that is independent of the SA frequency.

Independent Source can be enabled ONLY when the FieldFox is in SA mode.

- To view the internal source, you must connect a cable or device between the RF Output connector and the RF Input connector.

NOTE

The FieldFox output power is approximate and NOT flat across the frequency range.

How to make Independent Source Settings

- Press **Measure 1**.
- Then **Source**.
- **Source Enable ON OFF**
 - **ON** Turns ON the internal source.
 - **OFF** Turns OFF the internal source.
- **Source Mode** Choose from the following:
 - **Tracking** The internal source sweeps simultaneously (tracks) with the SA receiver over the displayed frequency range, emulating NA mode measurements. **Src** is annotated on the screen.
 - **CW** The source is set to a CW frequency independent from the SA setting. **Srcw** is annotated on the screen.
 - **Coupled CW** The source is set to a CW frequency, but that frequency “tracks” the SA receiver Center Frequency setting. Therefore, the signal always appears at center of the display. **Srcp** is annotated on the screen.
- **Normalize ON OFF** With Source Enable ON and Source Mode = Tracking, Normalize ON stores the current measurement trace into Trace 4 in View state as a reference trace. All subsequent trace measurements subtract out this Trace 4 reference trace, and therefore become relative to it. This causes measurements to appear near the ZERO absolute level on the y-axis (0 dBm if UNIT is set to dBm). **SrcN** is annotated on the screen. Normalize is automatically turned OFF when the frequency range or Resolution is changed. Learn more about Trace Display States in [“Trace Display States” on page 8-28](#).
- **Source Power** Sets the source attenuation from 0 to 31 dB in 1 dB steps. This effectively sets the source output power. While changing the source attenuation, the approximate Nominal Output power is annotated to the right of the active entry setting.

- **Source CW Freq** Sets the CW frequency that is used when Source Mode is set to CW.

NOTE

By default, the source output will turn off momentarily at the end of each SA sweep. To cause the source to stay ON at the end of each sweep, turn battery saver OFF. (Learn more in [“Battery Saver” on page 18-10.](#))

Setting Battery Saver to OFF

- Press **System 7**.
- Then **Preferences**.
- Then **Battery Saver OFF**.

Resolution Bandwidth (Res BW)

In SA Mode, the Res BW provides the ability to resolve, or see closely spaced signals. The narrower (lower) the Res BW, the better the spectrum analyzer can resolve signals. In addition, as the Res BW is narrowed, less noise is measured by the spectrum analyzer ADC and the noise floor on the display lowers as a result. This allows low level signals to be seen and measured. However, as the Res BW is narrowed, the sweep speed becomes slower. See [“Very Long Sweep Times” on page 8-23.](#)

How to set Res BW

- Press **BW 2**.
- Then **Res BW Auto | Man**.
- Then choose from the following:
 - **Auto** Res BW is coupled to the frequency span. As the frequency span is narrowed, the Res BW is also narrowed providing increased ability to resolve signals.
To change this setting from **Man** to **Auto**, press **Res BW** twice.
 - **Man** Enter a Res BW value using the numeric keypad, the **▲|▼** arrows, or the rotary knob. Then press a multiplier if necessary or press **Enter**.

The current Res BW setting is shown at the bottom of the screen.

#Res BW x.xx XHz (#) means manual setting.

This setting could impact the accuracy of the measurement. See [Appendix B: “Specifications/Data Sheet”](#).

NOTE

The Res BW setting also affects the Sweep Type setting. Learn how in [“Sweep Type” on page 8-21.](#)

Video Bandwidth (Video BW)

Video BW is a smoothing operation that is performed after measurement data is acquired. The trace data is effectively smoothed so that the average power level of the displayed noise is the same, but the peaks and valleys of adjacent data points are smoothed together. More smoothing occurs as the Video BW is set lower. However, as the Video BW is narrowed, the sweep speed becomes slower.

How to set VBW

- Press **BW 2**.
- Then **Video BW Auto Man**.
- Then choose from the following:
 - **Auto** Couples Video BW to the ResBW in a 1-to-1 ratio.
 - **Man** Enter a Video BW value using the numeric keypad, the **▲▼** arrows, or the rotary knob. Then press a multiplier if necessary or press **Enter**.

NOTE

To change this setting from **Man** to **Auto**, press **Video BW** twice.

The current Video BW setting is shown at the bottom of the screen.

VBW x.xx XHz (#) means manual setting.

When the Res BW/Video BW ratio exceeds 10,000, a **Meas UNCAL** warning may appear to indicate that the Video BW filter has reached the maximum capacity for averaging.

In Zero Span, the maximum Res BW/Video BW ratio is 100.

Sweep Type

In SA mode, the FieldFox uses two sweep types to process inputs signals. The sweep type that is currently being used (**FFT** or **Step**) is displayed in the lower-left corner of the FieldFox screen.

For a more comprehensive tutorial, see Spectrum Analysis Basics (App Note 150) at <http://literature.cdn.keysight.com/litweb/pdf/5952-0292.pdf>

How to set Sweep Type

- Press **BW 2**.
- Then **Advanced**.
- Then **Sweep Type Auto FFT Step**.

- Then choose from the following:
 - **Auto** The FieldFox selects the most efficient sweep type based on the Res BW. When Res BW is set to 200 kHz and below, FFT sweep type is selected. Above 200 kHz, Step sweep type is being performed.
 - **FFT** The FieldFox uses FFT sweep type regardless of the Res BW.
 - **Step** The FieldFox uses Step sweep type regardless of the Res BW. This is useful for capturing impulsive noise that may be generated from nearby electrical equipment.

Sweep Acquisition

When set to Auto, Sweep Acquisition is set to the minimum value required with the current settings in order to achieve amplitude accuracy when measuring CW signals yielding the fastest sweep update rate.

However, you can adjust this setting in order to increase the probability of intercepting and viewing pulsed RF signals.

For example, with **SwpAcquisition set to Auto** a pulsed GSM signal is NOT visible on the FieldFox screen, as shown in a blue trace in the following image.

While watching the trace, increase the SwpAcquisition value until the pulse spectrum rises out of the noise and reaches its maximum level. Increasing the SwpAcquisition value beyond this point only slows the update rate (increases the actual Sweep time readout) but does not improve measurement quality.

Figure 8-4 GSM Signal in Framed Data Format

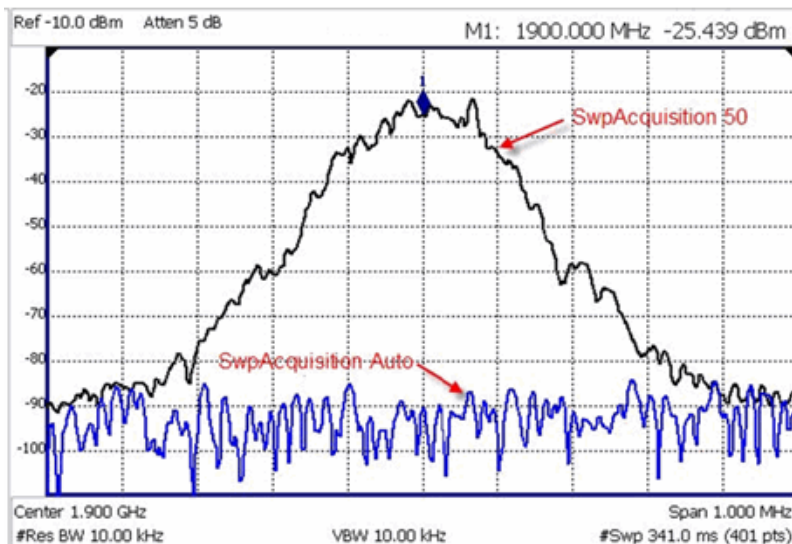

In the graphic above, a GSM signal in a framed data format; timeslot zero ON; all others OFF;

PRF = 218Hz, Duty Cycle = 12.5%. The pulsed signal becomes visible on every sweep update with SwpAcquisition = 50.

How to set Sweep Acquisition Parameter

- Press **Sweep 3**.
- Then **SwpAcquisition Auto Man**.
- Then choose from the following:
 - **Auto** Sweep is set to the fastest sweep possible with the current settings.
 - **Man** Enter a relative acquisition value between 1 and 5000, where:
 - 1 = Fastest sweep possible
 - 5,000 = Slowest sweep possible
 - # is shown in front of the actual sweep time to indicate a manual setting.

Some Detector and Video Bandwidth settings will raise the Auto Sweep Acquisition value greater than 1. In these cases, manually setting Sweep Acquisition lower than the Auto value may have NO effect.

NOTE

Measurement speed specifications do NOT apply in Temperature Control Mode. Learn more in [“Temperature Control Mode” on page 2-5](#).

Learn more about SA mode SwpAcquisition time in the Supplemental Online Help: <http://na.support.keysight.com/fieldfox/help/SupHelp/FieldFox.htm>

Very Long Sweep Times

Two primary settings are responsible for the sweep time: Res BW and SwAcquisition.

- When the sweep time exceeds 1200 seconds (20 minutes), an informational message: **Alert: Very long sweep in progress...** is annotated on the screen for the duration of the sweep.
- When the sweep time exceeds 4000 seconds (about 1 hour), **Meas UNCAL** is annotated on the screen. Accuracy cannot be guaranteed.

Zero Span Measurements

When setting the frequency span to Zero, there is NO spectrum of frequencies to display, so the X-axis units becomes Time. The SA becomes like a tunable oscilloscope, with the center frequency being the frequency of interest. This capability is useful for analyzing modulation characteristics, such as pulsed measurements.

Figure 8-5 GSM Signal, Framed Data Format

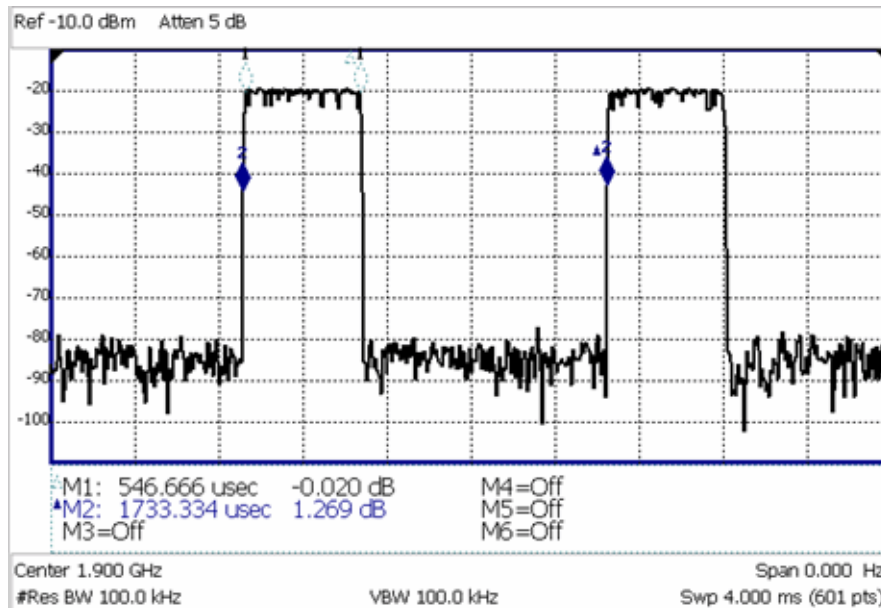

The graphic above shows a GSM signal, framed data format, with timeslot 0 and 3 “on”. Sweep Time is set to approximately the frame interval. Press Single several times until the waveform section of interest is viewable and stable. Then markers can be used to measure the timeslot width and interval as shown.

How to set Zero Span

- Set **Center** to the frequency of interest
 - then set **Span** to 0 Hz.
 - or select **Zero/Last Span**. Each key press toggles the frequency span between 0 Hz and the last specified frequency span.

How to change Sweep Time in Zero Span

- Press **Sweep 3**.
- Then **SweepTime**.
- Enter a value using the numeric keypad.
- Then select a multiplier key. Learn more in **“Multiplier Abbreviations” on page 2-14**.

When the sweep time is longer than can be acquired with the current available memory, **Meas UNCAL** is displayed on the screen. Learn more on **page 8-23**. Four times the amount of memory is available with the FieldFox A.04.00 release, allowing longer sweep times in Zero Span.

Triggering

External and Video triggering allows you to start a FieldFox sweep which is initiated by an external event such as a signal burst.

External and Video triggering can be used in either Zero Span (time domain) or frequency span measurements. However, Video triggering in frequency domain sweeps is limited to cases where Res BW is less than or equal to 200 kHz.

NOTE

The following Trigger Settings are available ONLY when performing an FFT sweep or when in Zero Span. Learn more about FFT on [page 8-21](#). Learn more about Zero Span on [page 8-23](#).

Trigger Type

- Press **Sweep 3**.
- Then **Trigger Settings**.
- Then **Trig Type**.
- Then choose from the following:
 - **Free Run** Triggering is provided by the FieldFox internal circuitry. A new sweep begins when the previous sweep ends.
 - **External** A sweep is triggered on an external TTL signal at the Ref In/Trig In connector on the FieldFox top panel. Choose to trigger on the rising slope at about 1.7 V or on the falling slope at about 1.0 V using the Trigger Slope setting (below).
 - **Video** A sweep is triggered on a signal at the RF IN connector when the amplitude of the incoming signal exceeds the settable Trigger Level. In frequency domain sweeps, Res BW must be set to 200 kHz or less. This setting is called Video trigger because the signal that initiates the trigger appears on the display.

Trigger Slope

Trigger Slope determines which edge of an External, Video, or RF Burst trigger signal initiates a sweep.

- Press **Sweep 3**.
- Then **Trigger Settings**.
- Then **Trig Slope**.
- Then choose from the following:
 - **Pos** Sweep is triggered by the rising (positive) edge of signal.
 - **Neg** Sweep is triggered by the falling (negative) edge of signal.

Trigger Delay

After a valid External or Video trigger signal is received, the sweep begins after the specified Trigger Delay time. Only positive values are allowed.

To see the rising edge of a repetitive signal which is triggered on that edge, use trigger delay to clearly view the subsequent signal one period later.

- Press **Sweep 3**.
- Then **Trigger Settings**.
- Then **Trig Delay**.
- Enter a value using the numeric keypad, the **▲▼** arrows, or the rotary knob.
- Then select a multiplier key or press **Enter**. Learn more in **“Multiplier Abbreviations” on page 2-14**.

Trigger Level

Used with Video triggering, an incoming signal with this amplitude or higher (for positive slope) will initiate a sweep. The Units depend on the Scale Type setting: (Log or Linear). Learn more in **“Scale and Units” on page 8-8**.

The Video Trigger Level is a time domain (Zero Span) signal level comparison. Therefore, the sweep will trigger close to the displayed level in Zero Span measurements. In frequency span measurements, processing can cause broadband signal energy to display at lower power levels than the originating time domain signal. Therefore, you may need to set the trigger level higher than the displayed level.

- Press **Sweep 3**.
- Then **Trigger Settings**.
- Then **Trig Level**.
- Enter a value using the numeric keypad, the **▲▼** arrows, or the rotary knob.
- Then select a multiplier key or press **Enter**. Learn more in **“Multiplier Abbreviations” on page 2-14**.

Auto Trigger Time

If an External or Video trigger signal is not received before the specified Auto Trig Time, a sweep will occur automatically.

Enter 0 to set Auto Trigger OFF. When Auto Trigger is OFF, the FieldFox does NOT sweep unless a valid External or Video trigger signal is received.

- Press **Sweep 3**.
- Then **Trigger Settings**.

- Then **Auto Trigger [current setting]**.
- Enter an Auto Trig Time using the numeric keypad.
- Then select a multiplier key. See **“Multiplier Abbreviations” on page 2-14.**

Single / Continuous / Restart

NOTE

The following behavior is unique to SA Mode.

This setting determines whether the FieldFox measures continuously or only once each time the **Single** or **Run / Hold +/-** button is pressed. Use **Hold / Single** or to conserve battery power or to allow you to save or analyze a specific trace.

How to set Single or Continuous

- Press **Sweep 3**.
- Then choose one of the following:
 - **Continuous**
 - **ON** Causes the SA to make continuous sweeps. This is the typical setting for making measurements. Each **Run / Hold +/-** press causes the SA to toggle between continuous sweep and Hold.
 - **OFF** Causes the SA to Hold. Each **Run / Hold +/-** or **Single** press causes the SA to make ONE sweep, then Hold. The Hold annotation changes to an arrow --> while the sweep occurs.
 - **Single** Automatically sets Continuous OFF and causes the SA to make ONE sweep, then Hold.
 - **Restart** Resets the Average counter on 1. When in Hold, causes the SA to make ONE sweep, then Hold. The Average counter has is used with MaxHold and MinHold Trace States. Learn more in **“Average Count” on page 8-29.**

Points

Points is the number of measured frequencies the X-axis. The higher number of data points, the better the ability to resolve closely spaced signals and the slower the sweep speed.

How to set number of points

- Press **Sweep 3**.
- Then **Points [current setting]**.

- Then choose from: **101 | 201 | 401 | 601 | 801 | 1001**.

Trace Display States

In SA Mode you can display up to four of the following types of trace states. All SA settings are applied to all displayed traces.

A color-coded legend for displayed traces is visible in the left pane of the SA mode screen:

W = Clear/Write; **M** = MaxHold; **m** = MinHold; **A** = Average; **V** = View

How to display the Trace States

- Press **Trace 6**.
- Then **Trace 1,2,3,4** repeatedly to select a trace number to display or change its state. Traces are displayed in the following colors:
 - Trace 1 – **Yellow** Trace 2 – **Blue**
 - Trace 3 – **Orange** Trace 4 – **Green**
- Then **State [current setting]**
- Then choose from the following Trace States:
 - **Clr /Wr** (Clear/Write) Displays the actual measured data for each sweep.
 - **MaxHold** Displays the maximum response of the input signal at each data point over multiple sweeps. See also Average Count in **“Average Count” on page 8-29**.
 - **MinHold** Displays the minimum response of the input signal at each data point over multiple sweeps. See also Average Count in **“Average Count” on page 8-29**.
 - **Average** Each data point is averaged over multiple sweeps as set by the Average Count setting. Learn more in **“Average Count” on page 8-29**.
 - **View** Displays and then holds the last complete measurement trace on the screen. This is similar to storing a trace in memory.
 - **Blank** Displays no trace.
- Press **Default All** to return all traces to their default settings: Trace 1 (Clear/Write); all other traces (Blank).

NOTE

Trace 4 data WILL be overwritten by the FieldFox when using the Independent Source Normalize feature (**“Independent Source” on page 8-18**) or using Field Strength antenna or cable corrections (**“Field Strength Measurements” on page 8-12**).

Average Type

In SA Mode, there are four different processes in which Averaging is performed:

- Average Traces – Learn more in **“Averaging” on page 8-37**.
- Detection Method Averaging – Learn more in **“Detection Method” on page 8-30**.
- Noise Marker Averaging – Learn more in **“Noise Marker” on page 8-32**.
- Video BW filtering (for non-Zero Span measurements) – Learn more in **“Video Bandwidth (Video BW)” on page 8-21**.

There are two types of mathematical averaging that can be performed. Select ONE of these types and it is used for all of the above averaging processes.

How to set Average Type

- Press **Meas Setup 4** then **Average Type [current setting]**.
- Then choose from the following:
 - **Auto** – The FieldFox chooses the most appropriate type of averaging for the current settings. When Detection Method is set to Average, a Noise Marker is present, or a Channel measurement is active, then Power Average is ALWAYS selected. Otherwise, Log Average is selected.
 - **Log** Averaging – Best for displaying Trace Averaging. LgAv is shown on the left side of the FieldFox screen when selected.
 - **Power** (Linear) Averaging – Best for measuring true power levels. Used in Detection Average and Noise Marker Average. Mathematically, trace noise is 2.5 dB higher than when using Log Average. PAvG is shown on the left side of the FieldFox screen when selected.

Average Count

The Average Count setting is used mainly with the Average Trace State described above. In this Trace State, the Average Count setting determines the number of sweeps to average. The higher the average count, the greater the amount of noise reduction.

When Trace (display) State is set to **Average**, **MaxHold**, or **MinHold**, the average counter is shown in the left edge of the screen below the Average Type.

For all three of these Trace States, when **Sweep 3 Continuous** is set to OFF, press **Restart** to reset the sweep count to 1, perform <n> sweeps, then return to **Hold**.

How to set Average Count

- Press **Meas Setup 4**.
- Then **Average Count**.
- Enter a value from 1 to 10,000 using the numeric keypad, the **▲▼** arrows, or the rotary knob.
- Press **Enter**.

Detection Method

In SA Mode, the X-axis is comprised of data points, also known as “buckets”. The number of data points is specified using the Points setting. Learn more in [“Points” on page 8-27](#).

Regardless of how many data points are across the X-axis, each data point must represent what has occurred over some frequency range and time interval.

From the frequency span of the measurement, the span of each data point is calculated as $(\text{frequency span} / (\text{data points} - 1))$. The detection method allows you to choose how the measurements in each bucket are displayed.

Figure 8-6 Detection using One Bucket

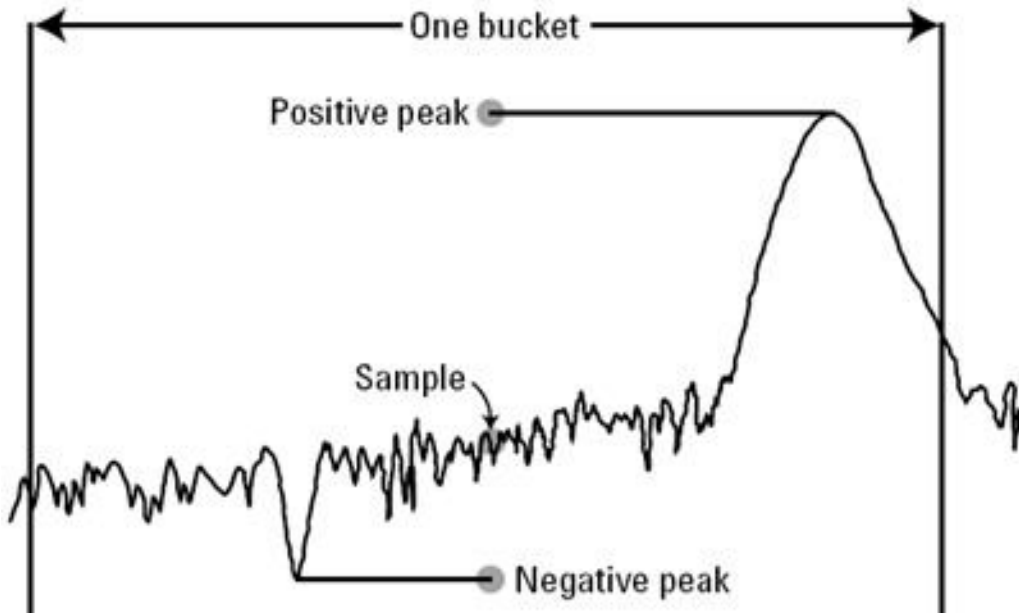

In the graphic above there is one bucket showing Positive peak, Sample, and Negative peak Detection methods.

How to set Detection Method

The current Detection method is labeled on the left edge of the screen. When a method is selected manually, a # precedes the label. For example: **# Nrm** means that **Normal** was selected from the softkeys.

- Press **Trace 6**.
- Then **Detector**.
- Then choose from the following:
 - **Auto** Displays the most appropriate Detection method based on other settings. [**# is NOT shown**]
 - **Normal** [**Nrm**] Provides a better visual display of random noise than **Positive peak** and avoids the missed-signal problem of the **Sample** Mode. Should the signal both rise and fall within the bucket interval, then the algorithm classifies the signal as noise. An odd-numbered data point displays the maximum value encountered during its bucket. An even-numbered data point displays the minimum value encountered during its bucket. If the signal is NOT classified as noise (does NOT rise and fall) then Normal is equivalent to Positive Peak.
 - **Positive Peak** [**PK**] Displays the maximum value of all the measurements in each bucket. This setting ensures that no signal is missed. However, it is not a good representation of the random noise in each bucket.
 - **Negative Peak** [**NPk**] Displays the minimum value of all the measurements in each bucket.
 - **Sample** [**Smp**] Displays the center measurement of all the measurements in each bucket. This setting gives a good representation of the random noise in each bucket. However, it does not ensure that all signals are represented.
 - **Average** [**#RMS**] Displays the Root Mean Squared (RMS) average power of all the measurements in each bucket. This is the preferred method when making power measurements.

Display Line

A display line is a simple, horizontal line that can be placed at any amplitude level on the SA screen. Use a display line as mental guide for visual feedback. A display line is similar to a Limit Line, except that no PASS/FAIL testing occurs. A display line is easier to create than a Limit Line. Learn more in **“All about Limit Lines” on page 16-14.**

Figure 8-7 Display Line with Annotations

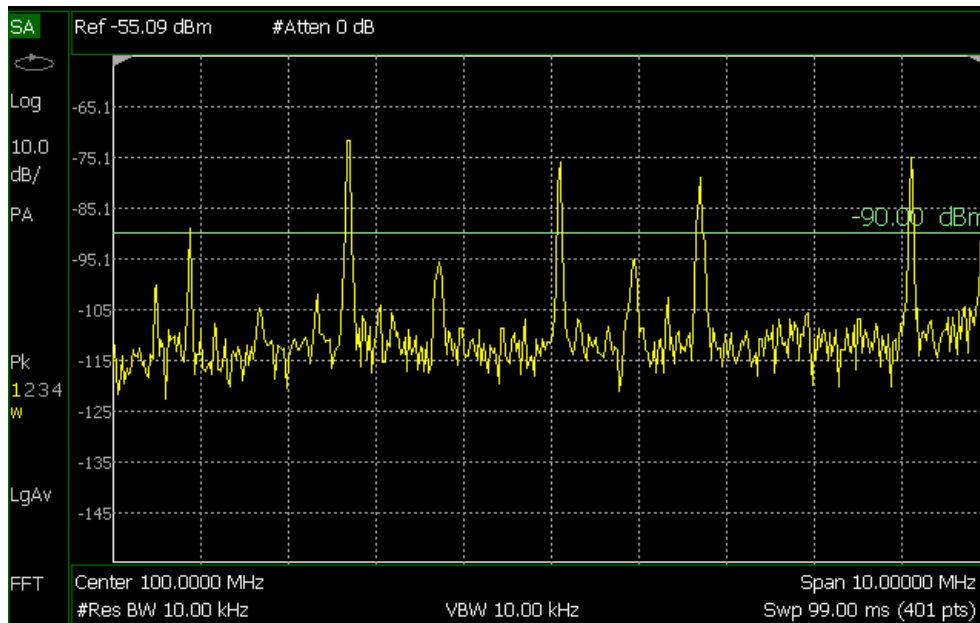

How to create and move a Display Line

- Press **Limit 8**.
- Then **Display Line OFF ON**.
- Then enter a Y-axis value using the **▲▼** arrows or the rotary knob, then press **Enter**. Or enter a value using the numeric keypad and press a suffix key or press **Enter**.

Noise Marker

For comparison purposes, electronic noise measurements are often displayed as though the measurement was made in a 1 Hz Res BW. However, making an actual measurement at a 1 Hz Res BW is extremely slow.

A Noise Marker, unique to SA Mode, mathematically calculates the noise measurement as though it were made using a 1 Hz bandwidth.

Several data points (or ‘buckets’) are averaged together to calculate the Noise Marker readout. To accurately measure noise, the Noise Marker should NOT be placed on, or too close to, a signal. The distance from a signal depends on several factors. To know if an accurate reading is being made, move the Noise Marker until consistent measurements are displayed in adjacent data points.

In addition, when a Noise Marker is displayed, the Detection method is automatically switched to Average and **PAvg** is shown on the FieldFox screen. This occurs only when Detector is set to Auto. Learn more in **“Detection Method” on page 8-30**.

With a Noise Marker present, the Res BW can be changed and the displayed noise floor will also change, but the Noise Marker readout will remain about the same.

Noise Markers can be used like regular markers. A Noise Marker is distinguished from a regular marker by **(1Hz)** after the marker readout value. Learn more about regular markers in [“How to create Markers” on page 16-2](#).

How to measure Noise with a marker

- Press **Marker** to create or select a Normal or Delta marker to use to measure Noise.
- Then **More**.
- Then **Marker Function**.
- Then **Noise ON OFF**.

Band/Interval Power Marker

A Band/Interval Power marker, unique to SA Mode, accumulates the power that is measured over several adjacent data points (or ‘buckets’). The range of buckets being measured is displayed with vertical posts around the marker. This Band Span value is selectable.

This feature is very similar to a channel power measurement ([“Channel Power \(CHP\)” on page 8-38](#)).

When the frequency span is set to Zero span, the marker is referred to as an Interval Band Marker because it averages power over a specific time interval. In this case the range is specified as the Interval Span. Learn more about Zero span measurements in [“Zero Span Measurements” on page 8-23](#).

If the Detection method and Averaging type are set to Auto when you enable a Band/Interval Power marker, the Detection method will change to Average (RMS) and Averaging type will change to Power average. Other Detection methods or Averaging type settings will usually cause measurement inaccuracy. Learn more about Detection method in [“Detection Method” on page 8-30](#), and Averaging Type in [“Average Type” on page 8-29](#).

Summary:

- In Zero span, an Interval Power Marker yields the average power over the specified time interval.
- In non-Zero span, a Band Power Marker yields the total power over the specified frequency range.

How to measure Band/Interval Power with a marker

- Press **Marker** to create or select a Normal or Delta marker to use to measure Band/Interval Power.
- Then press **More**.

SA (Spectrum Analyzer) Mode
SA Mode Settings

- Then **Marker Function**.
- Then **Band/Int Power**.
- Then **Band (or Interval) Span**.
- Then choose from the following:
 - **Auto** Measures power over 5% of the displayed span, or ½ graticules. The Band Span is automatically updated to remain at 5% when you change the frequency span.
 - **Man** Enter a frequency or time value using the **▲▼** arrows or the rotary knob, then press **Enter**. Or enter a value using the numeric keypad and select a frequency or time suffix. The Band Span remains at the frequency or time value that you set as the span changes.

Frequency Counter at Marker

Available in SA Mode ONLY. Use any existing marker to make highly-accurate frequency counter readings. For highest accuracy, lock the FieldFox to a stable external frequency reference. Learn how in [“Frequency Reference Source” on page 15](#).

When Frequency Counter is ON, the FieldFox uses background sweeps to zoom on the signal, measure the signal peak with 1 Hz resolution, and display the frequency of the signal peak in the marker annotation area. The marker does not move to the signal peak.

When Freq Counter is ON, measurement sweeps are considerably slower.

How to use Frequency Counter

- Press **Marker**.
- Press Normal, Delta, or Peak, or select an existing marker to use as a frequency counter.
- Locate the marker somewhere on a CW signal. It does NOT have to be on the peak.
- Then **More**.
- Then **Freq Count ON**.
- With Freq Count ON, you can scroll through the existing markers that are located on a discrete CW signal, and read the frequency of the signal peak. However, each frequency count update requires another sweep. If the FieldFox is in HOLD, press **Single** to update the frequency count results.

Audio Beep at Marker Power

When enabled, the Audio Beep feature emits a repetitive beep sound which varies in tone pitch and repetition rate to indicate the relative power level of the active marker. The highest tone pitch and fastest beep rate occurs when the marker Y-axis position is at the top of the display. Conversely, the lowest pitch and repetition rate occurs at the bottom of the display. Therefore, it is important to scale the signals that you intend to measure between the top and bottom of the screen. Learn more about Scale in [“Scale and Units” on page 8-8](#).

Audio Beep can be used with any marker type or function, including Band/Interval Power. Learn more in [“Audio Beep at Marker Power” on page 8-35](#).

How to use Audio Beep

- Press **Marker**.
- Optionally, press **Marker 1 2 3 4 5 6** to select an existing marker to use with Audio Beep. A marker will be created if one does not already exist.
- Then **More**.
- Then **Marker Function**.
- Then **Audio Beep ON OFF**.

Audio Beep does NOT beep when the FieldFox is in Hold mode.

While Audio Beep is ON, press **Marker 1 2 3 4 5 6** to toggle Audio Beep through the existing markers.

To set FieldFox speaker volume control, press **System**, then **Volume**. Learn more in [“Volume Control” on page 4](#).

Meas UNCAL Error

Meas UNCAL appears in the lower-left corner of the screen when the FieldFox can NOT display accurate measurement results with the current settings. Usually, the part of the trace that is inaccurate is shown at –200 dB.

The following situation can produce **Meas UNCAL**:

- In Zerospan, when Sweep Time is set too high for the current Res BW. Lower the Res BW or the Sweep Time setting.
- When the ResBW/VBW ratio exceeds 10,000, causing the VBW filter to reach the maximum capacity for averaging.

Old Data Indicator (*)

In SA mode, when the current trace does not exactly match the annotation that is on the screen, an asterisk is displayed in the upper-right corner of the screen graticule area. This would occur, for example, when the Res BW setting is

SA (Spectrum Analyzer) Mode
SA Mode Settings

changed while in sweep Hold mode. The annotation is changed immediately, but the trace is not updated until the next sweep occurs. Therefore, the current data trace does not match the screen annotation. See the asterisk in **Figure 8-1 on page 8-1**.

Channel Measurements

The following Channel Measurements are offered in SA Mode:

“Channel Power (CHP)” on page 8-38

“Occupied Bandwidth” on page 8-40

“Adjacent Channel Power Ratio (ACPR)” on page 8-42

Radio Standards and Channel Measurements

To tune the frequency range of any of the Channel Measurements using channels instead of frequency, first select a Radio Standard, then select Units = CHAN. Learn how to select a Radio Standard and channels in “How to select a Radio Standard” on page 8-6.

When you first select a Radio Standard, then select a Channel Measurement:

- With Units = FREQ selected, the center frequency and span will ALWAYS change to the full frequency range of that standard (Uplink and Downlink) to allow for a quick scan of energy. The X-axis annotation indicates the frequency range.
- With Units = CHAN selected, the FieldFox chooses either the uplink or downlink band, and displays that range of frequencies. You can then tune within that Standard using Start CHAN, Stop CHAN, or Center CHAN. The X-axis annotation indicates the frequency range.

When you **first select a Channel Measurement**, then select a **Radio Standard**, the BW, Offset, RRC, Integration BW, and Span settings are changed to those of the standard. In addition, Res BW can also change when set to ‘Auto(couple)’. However, center frequency is NOT changed unless you first select Units = CHAN.

Measurement Preset

Measurement Preset allows you to easily reset any of the channel measurements to its default settings. The Center Frequency, Preamp ON|OFF, RF Attenuation, Markers, Limits, and Radio Standard settings are NOT reset.

How to select Measurement Preset:

- Press **Preset** then **Meas Preset**.

Averaging

By default in ALL Channel measurements, averaging is enabled and set to display the average of the last 15 measurements. When enabled, this average setting is automatically making the following ‘averaging’ settings in order to provide the most accurate power measurements:

- Averaging Type is set to Power.

SA (Spectrum Analyzer) Mode Channel Measurements

- Trace State is set to Average.
- Detector is set to Average.
- Count is set to 15.

Any of these settings can be changed manually during a Channel measurement. Learn more about these settings starting in **“Average Type” on page 8-29.**

To change Averaging:

- Press **Meas Setup 4**.
- Then **Average Enable ON OFF** OFF effectively sets the Average Count to 1.
- Then **Average Count**.
- Enter a value between 1 and 10,000 using the numeric keypad,  arrows, or the rotary knob.
- Press **Enter**.

Traces

Only one measurement trace can be displayed in Channel Measurements.

Channel Power (CHP)

Channel Power measures total power over the specified Integration BW. The Integration Bandwidth (IBW) can be adjusted to measure the power over multiple channels.

Figure 8-8 Channel Power Measurement

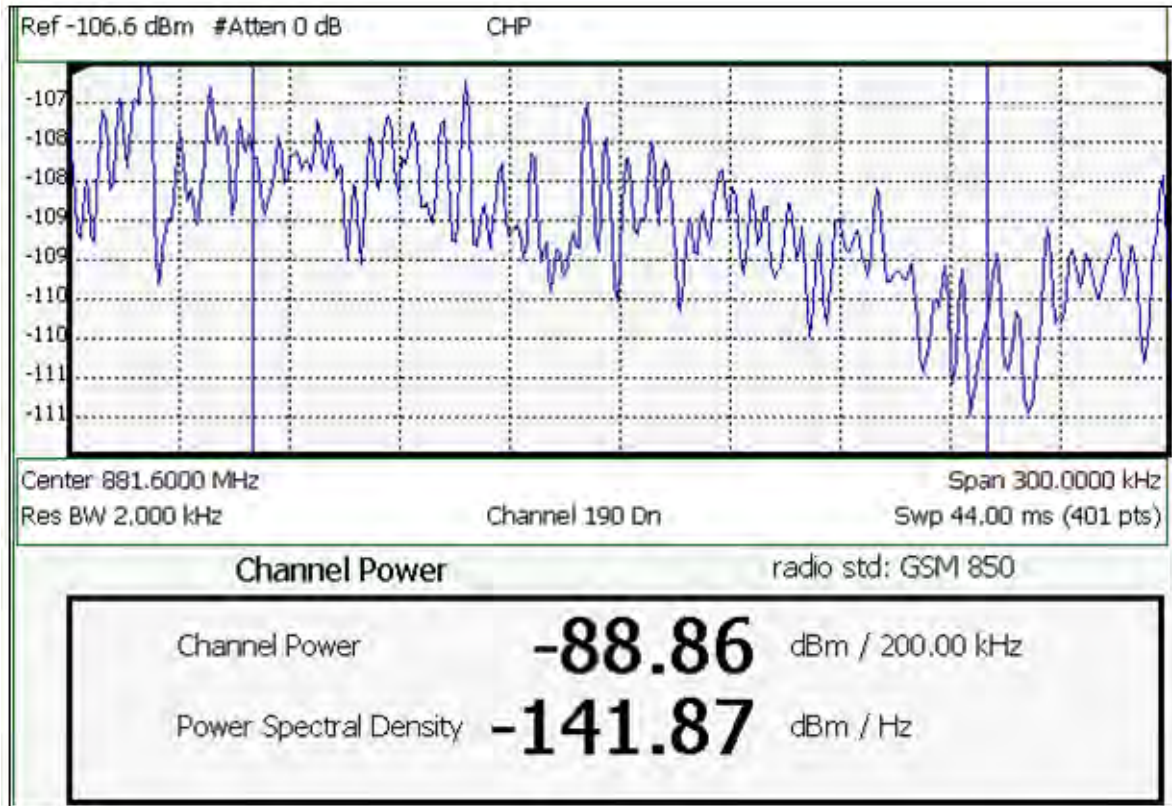

The following two Channel Power levels are displayed:

- **Channel Power** - measures total power over the specified Integrated BW.
- **Power Spectral Density** – same measured power, but mathematically normalized to a 1 Hz bandwidth using the same algorithm as Noise Marker. Learn more about the **“Noise Marker”** on page 8-32.

How to select Channel Power

- Press **Measure 1**.
- Then **Channel Measurements**.
- Then **Channel Power**.

When Channel Power is selected, the following settings are maintained from a previous measurement: Center Frequency, Preamp ON|OFF, and RF Attenuation.

Integration Bandwidth

When Channel Power is selected, vertical posts appear on the display to mark the current Integration Bandwidth setting. The displayed Channel Power and Power Spectral Density values are measured and calculated over the specified Integration Bandwidth.

By default, the displayed frequency span is automatically coupled to the Integration Bandwidth. As you change the Integration Bandwidth, the frequency span is adjusted so that the vertical posts appear to NOT move. However, when you manually change the frequency span, the Integration Bandwidth is no longer coupled to the frequency span.

When a Radio Standard is selected, the appropriate Integration Bandwidth is set automatically. Learn more about **“Radio Standard”** on page 8-6.

To change Integration Bandwidth:

- Press **Meas Setup 4**.
- Then **Integration BW**.
- Enter a value between 100 Hz and 3 GHz using the numeric keypad, **▲▼** arrows, or the rotary knob.
- Press **Enter**.

Other Channel Power Settings

All relevant FieldFox settings are made automatically to ensure the highest accuracy, such as ResBW, VideoBW, and sweep (SwpAcquisition) speed. These, and all other SA Mode settings, can be changed manually in a Channel Power measurement.

- Learn about **“Measurement Preset”** on page 8-37.
- Learn about **“Averaging”** on page 8-37.
- Learn about **“RRC Weighting”** on page 8-46.

Occupied Bandwidth

Occupied Bandwidth measures the power of the displayed frequency span and displays vertical posts at the frequencies between which the specified percentage of the power is contained. The frequency span between the two vertical posts is the Occupied Bandwidth. The Occupied Power, the power that is contained between the two posts, is also displayed in dBm.

Figure 8-9 Occupied Bandwidth Measurement

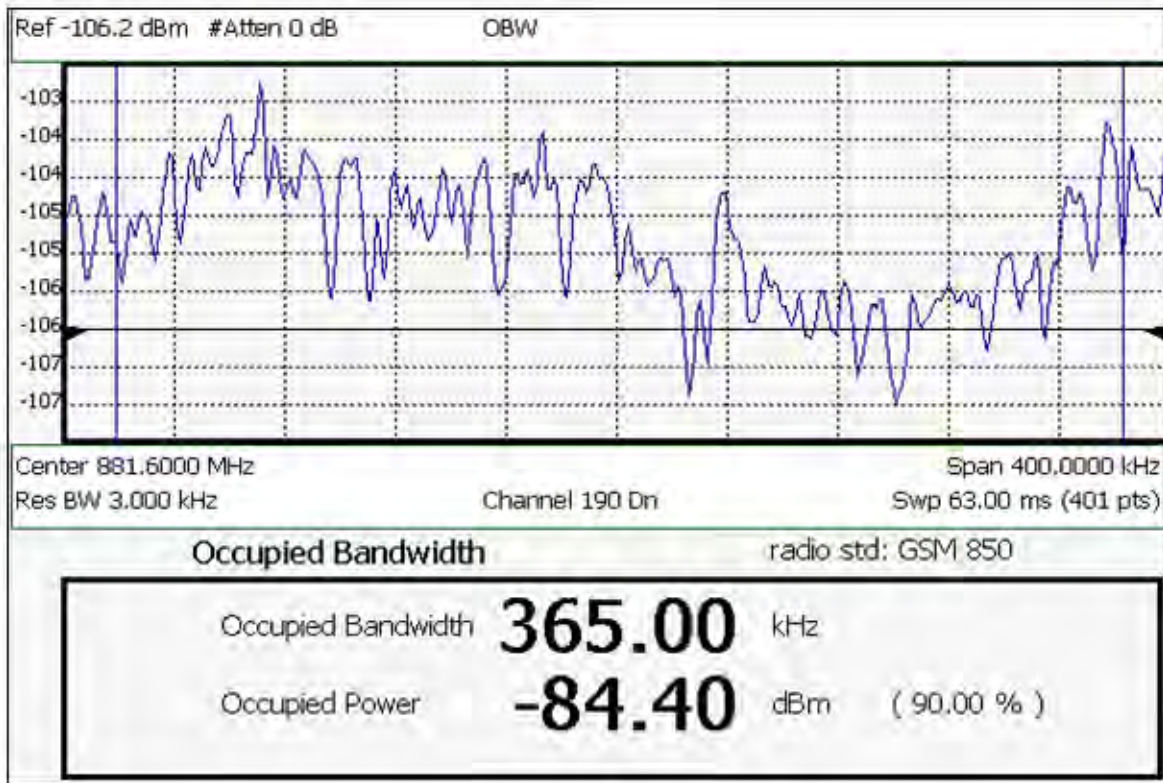

The graphic above shows an OBW measurement; Chan 190 Downlink; GSM850 Radio Standard

How to Select Occupied Bandwidth

- Press **Measure 1**.
- Then **Channel Measurements**.
- Then **Occupied BW**.

When Occupied Bandwidth is selected, the following settings are maintained from a previous measurement: Center Frequency, Preamp ON|OFF, and RF Attenuation.

Frequency Span

Occupied BW is calculated from power that is measured over the entire displayed Frequency Span. The frequency span can be entered using arbitrary frequencies or by using a Radio Standard in conjunction with channel numbers. Learn how to select a Radio Standard and channels in [page 8-6](#) and [page 8-7](#).

To change Frequency Span:

- Press **Freq/Dist**.

SA (Spectrum Analyzer) Mode Channel Measurements

- Then **Freq Span**.
- Enter a value using the numeric keypad, **▲▼** arrows, or the rotary knob.
- Press **Enter**.

Power Percent

This setting specifies the percentage of total measured power to display between the vertical posts. The measurement defaults to 99% of the occupied bandwidth power. The remaining power (1% of default setting) is evenly distributed;.5% of the power on the outside of each side of the vertical posts.

To change Power Percent:

- Press **Meas Setup 4**.
- Then **Power Percent**.
- Enter a value between 10 and 99.99 using the numeric keypad, **▲▼** arrows, or the rotary knob.
- Press **Enter**.

Other Occupied Bandwidth Settings

All relevant FieldFox settings are made automatically to ensure the highest accuracy, such as ResBW, VideoBW, and sweep (SwpAcquisition) speed. These, and all other SA Mode settings, can be changed manually in a Occupied Bandwidth measurement.

- Learn about **“Measurement Preset” on page 8-37**.
- Learn about **“Averaging” on page 8-37**.

Adjacent Channel Power Ratio (ACPR)

ACPR measures the power of a carrier channel and the power in its adjacent (offset) channels. The measurement results can help you determine whether the carrier power is set correctly and whether the transmitter filter is working properly.

You can measure the channel power in one, two, or three adjacent (offset) channels on the low frequency and high frequency side of the carrier channel.

Limits can be used to quickly see if too much power is measured in the adjacent channels.

Figure 8-10 GSM 850-Ch 251-Up with one Offset

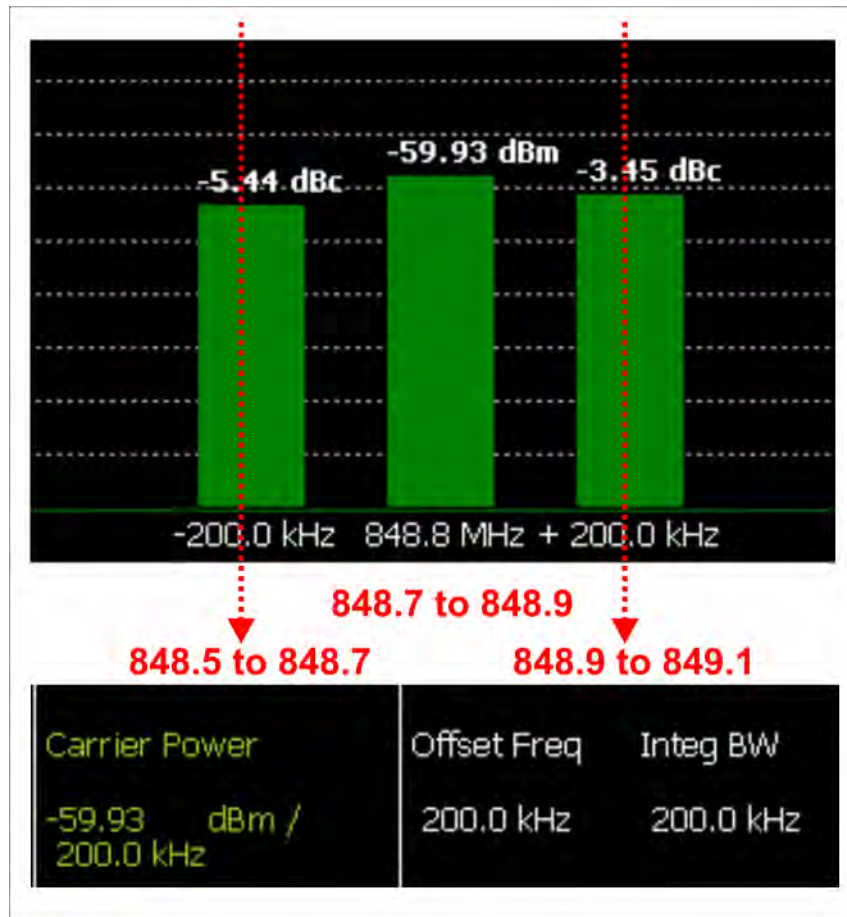

In the graphic above, red frequencies (MHz) are added to illustrate offset and integ BW.

Data in the ACPR graphical chart is always presented in dBm for the carrier, and dBc (dB below the carrier) for the offsets. This can NOT be changed. Use the **Meas Type** setting (next page) to change how the data is presented in the table below the graph.

How to select ACPR

- Press **Measure 1**.
- Then **Channel Measurements**.
- Then **Adjacent Channel Power**.

When ACPR is selected, the following settings are maintained from a previous measurement: Center Frequency, Preamplifier ON|OFF, and RF Attenuation.

Frequency Range/Channel

When a Radio Standard is selected, the appropriate center frequency or channel and span is set automatically. The frequency or channel number can then be changed from the **Freq/Dist** menu. Learn how to select a Radio Standard and channels on [page 8-6](#) and [page 8-7](#).

The frequency range of an ACPR measurement can also be entered using arbitrary frequencies.

When a Radio Standard is NOT selected, the center frequency of a previous measurement is maintained when ACPR is selected.

Integration Bandwidth

The Integration Bandwidth of the carrier and offsets is the frequency span over which power is measured.

To change Integration Bandwidth:

- Press **Meas Setup 4**.
- Then **Integrating BW**.
- Enter a value between 100 Hz and 100 MHz using the numeric keypad, **▲▼** arrows, or the rotary knob.
- Press **Enter**.

How to define adjacent (Offset) channels

An offset represents a difference in center frequencies of the carrier channel and its adjacent channel to be measured. The frequency range for each offset is specified with an Offset Freq and Integ BW. Each offset that is created has a Lower (carrier MINUS Offset Freq) and Upper (carrier PLUS Offset Freq) set of frequencies.

- Press **Meas Setup 4**.
- Then **Offsets**.
- Press **Offset 1 2 3** to select an offset.
- Then **Offset State** to set that offset ON or OFF.
- Select **Offset Freq** This is the difference between the **carrier center frequency** and the **center frequency of the offset channel**. Then enter a value using the numeric keypad.
- Select **Offset Integ BW** This is the frequency range over which power is measured in that offset; half of the range below and half above the Offset Freq.

How to set limits for adjacent channels

You can set a unique threshold power for each of the offsets that will cause a FAIL indication (RED bar). This occurs when the calculated **dBc** power (on top of the offset bar) is ABOVE the specified level.

To set limits, with an ACPR measurement on the screen:

- Press **Limit 8**.
- Then **Set Limits (1,2, or 3)**.
- Then choose from the following:
 - **LowerOffset** Sets a limit for the lower-frequency offset.
 - **Upper Offset** Sets a limit for the higher-frequency offset.
- Then enter a value using the numeric keypad, **▲▼** arrows, or the rotary knob.
- Then **Limit Test ON OFF**.

Measurement Type

This setting determines how the measured carrier and offset power levels in the **table** are presented. (Data in the graphical chart is always presented in dBm for the carrier and dBc for the offsets.)

To select Meas Type:

- Press **Meas Setup 4**.
- Then **More**.
- Then **Meas Type**.
- Then choose from the following:
 - **Total Pwr Ref** – Integrated carrier power is represented in dBm, and relative powers between offsets and carrier are represented as dBc (dB below the carrier).
 - **PSD Ref (Power Spectral Density)** – Integrated carrier power is normalized to a 1 Hz density as dBm/Hz using a similar algorithm as Noise Marker. Learn more about the **“Noise Marker” on page 8-32**.

For both Meas Types, choose the reference for the offset data.

- **Auto** – dB or dBc value is computed by subtracting the measured carrier power from the measured offset power.
- **Man** – dB or dBc value is computed by subtracting the entered RefValue from the measured offset power.
 - Press **Ref Value**.

–Then enter a value to be used to reference the data using the numeric keypad,  arrows, or the rotary knob.

Other ACPR Settings

All relevant FieldFox settings are made automatically to ensure the highest accuracy, such as ResBW, VideoBW, and sweep (SwpAcquisition) speed. These, and all other SA Mode settings, can be changed manually in a ACPR measurement.

- Learn about **“Measurement Preset”** on page 8-37.
- Learn about **“Averaging”** on page 8-37.

RRC Weighting

RRC, or Root-Raised-Cosign weighting, is offered with Channel Power and ACPR measurements.

When RRC Weighting is applied to transmitted and received power, the edges of the channel are ‘smoothed’ to help prevent interference. To accurately measure a channel that has RRC weighting, set the same value of RRC weighting as that used in the transmitter and receiver.

Figure 8-11 Channel power measurement with .22 RRC applied

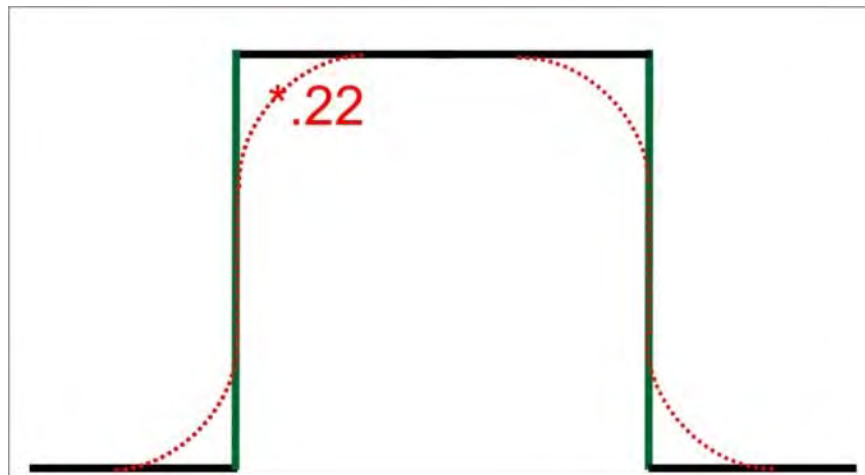

RRC Weighting is set and enabled automatically when included in a selected radio standard.

To set and enable RRC Weighting:

- Press **Meas Setup 4**.
- Then **RRC Weighting ON OFF**.
- Then **More**.
- Then **RRC Alpha [current setting]**.

SA (Spectrum Analyzer) Mode
Channel Measurements

- Enter a value between 0 (no smoothing) and 1 (most smoothing) using the numeric keypad,  arrows, or the rotary knob. A standard level of filtering is 22.
- Press **Enter**.

SA (Spectrum Analyzer) Mode
Channel Measurements

9 Interference Analyzer (SA Mode) – Option 236

Option 236 provides Spectrogram display, Waterfall display, and Record/Playback.

In this Chapter

[“Spectrogram Display” on page 9-2](#)

[“Common Settings for Waterfall and Spectrogram” on page 9-3](#)

[“Waterfall Display” on page 9-5](#)

[“About Sessions” on page 9-7](#)

[“About State and User Tags” on page 9-9](#)

[“How to Record a Session” on page 9-9](#)

[“How to Playback a Session” on page 9-10](#)

[“Recording Configuration” on page 9-11](#)

[“Playback Configuration” on page 9-14](#)

[“Manage Sessions” on page 9-14](#)

[“Record Playback Example” on page 9-15](#)

Spectrogram and Waterfall Displays

Spectrogram and Waterfall displays provide a visual history of the measured spectrum. Each display type can be used to locate intermittent signals or to view signal levels and frequencies over time.

Spectrogram is a single horizontal line of color-coded power while Waterfall uses a 3-D color-coded display. The functional difference between these two displays is that Spectrogram provides less trace detail than Waterfall display. However, it also allows more traces to be viewed.

These two displays can NOT be used with Channel Measurements.

NOTE

Although this document refers to past traces as ‘records’ these traces are not saved in Spectrogram and Waterfall displays. They are only drawn on the FieldFox screen. See [“How to Record a Session” on page 9-9](#) to learn how to save traces.

Spectrogram Display

Spectrogram draws the most recent trace record at the bottom of the stack of previously-drawn trace records. Drawing the live trace on the display is optional.

Figure 9-1

Spectrogram display- Overlay view- with time markers 23 seconds apart.

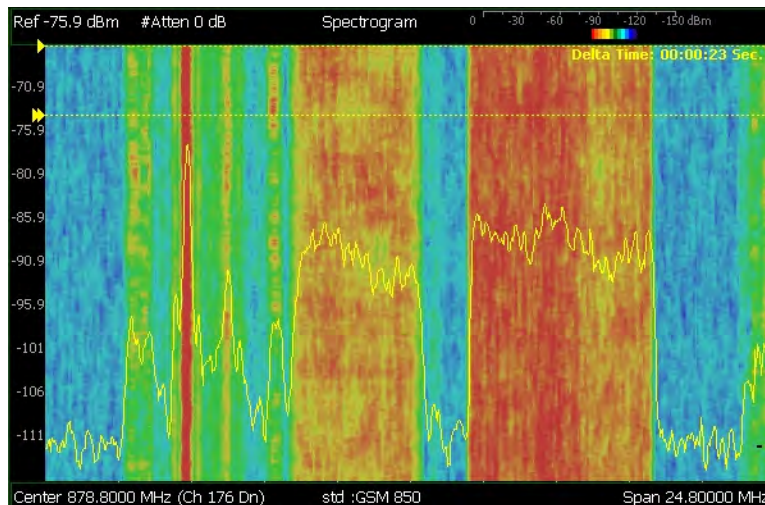

The following settings all contribute to the sweep time of an individual trace, and therefore, the total elapsed time that can appear on the screen in Spectrogram display:

- Frequency Range. Learn more in [“Frequency Range” on page 8-4](#).
- Resolution BW and Video BW. Learn more in [“Resolution Bandwidth \(Res BW\)” on page 8-20](#) and [“Video Bandwidth \(Video BW\)” on page 8-21](#).

- Sweep Time (Acquisition). Learn more in [“Sweep Acquisition” on page 8-22.](#)
- Resolution (Number of Points). Learn more in [“Points” on page 8-27.](#)

How to select Spectrogram

- Press **Meas 1**.
- Then **Interference Analysis**.
- Then **Spectrogram**.

How to modify the Spectrogram

You can change how the spectrogram is displayed relative to the data trace. This setting affects the total number of trace records that can be displayed.

- Press **Meas Setup 4**.
- Then **Spectrogram Settings**.
- Then **Spectrogram View**.
- Then choose from the following:
 - **Overlay** Displays the data trace over the spectrogram with NO graticules. Total trace records: 340.
 - **Full Screen** Displays the spectrogram with NO data trace. Total trace records: 340.
 - **Top** Displays the data trace above the spectrogram. Total trace records: 130.
 - **Bottom** Displays the data trace below the spectrogram. Total trace records: 130.

How to Restart the Spectrogram

Press **Sweep 3** then **Restart**.

Averaging

Averaging can be enabled on the underlying measurement. Press Meas 4 then Average Type. Learn more in [“Average Type” on page 8-29.](#)

Common Settings for Waterfall and Spectrogram

Set Red and Blue Limits

The colors displayed on the Waterfall and Spectrogram represent the various measured power levels:



- Red = Highest power levels

- Blue = Lowest power levels

NOTE

The full Red-to-Blue color spectrum is visible only with Indoor display colors. Learn more in “Display Colors” on page 5.

Adjust the Red and Blue limits to the power levels that you expect to measure. The Blue limit must always be less than the Red limit.

- Press **Meas Setup 4**.
- Then **Spectrogram Settings** or **Waterfall Settings**.
- Then choose from the following:
 - **Red Limit** Using the  arrows, rotary knob, or keypad, select the HIGHEST power level that you expect to measure. This power level, and those measured higher than this level, appear Red.
 - **Blue Limit** Using the  arrows, rotary knob, or keypad, select the LOWEST power levels that you expect to measure. This power level, and those measured lower than this level, appear Blue.





Time Markers

Use Time Markers to determine the elapsed time between any two displayed records.

NOTE

Spectrogram displays the most recent record at the top of the screen. Waterfall displays the most recent record at the bottom.

To create Time Markers:

- Press **Meas Setup 4**.
- Then **Time Markers**.
- Then **Time**.
- Then enter a value from 0 (the most recent sweep record) to the maximum value, using the numeric keypad,  arrows, or the rotary knob. A  indicates the Time Marker.
- Then **Delta**.
- Then enter a value from 0 (the most recent sweep record) to the maximum value, using the numeric keypad,  arrows, or the rotary knob. A  indicates the Delta Marker.
- At the current sweep speed, the difference in time between these two markers appears at the upper-right corner of the view as **Delta Time: hh:mm:ss Sec**.

- An invalid (very large number) appears when a trace record is not available at one or both of these markers.

How to Restart the Spectrogram/Waterfall

Press **Sweep 3** then **Restart**.

Averaging

Averaging can be enabled on the underlying measurement. Press **Trace 6** then **State [Average]**. Learn more in “Average Type” on page 8-29.

Measurement Preset

Measurement Preset resets ONLY the Spectrogram and Waterfall display settings. It does not reset the measurement settings.

- Press **Preset**.
- Then **Meas Prese**.

Waterfall Display

The live trace is always drawn on a Waterfall display. Older trace records scroll up from the displayed trace and eventually off the screen. Because of this, locate the live trace on the bottom of the screen using the scale and reference settings. Learn how in “Scale and Units” on page 8-8.

NOTE

Although this document refers to past traces as ‘records’ these traces are not saved. They are only drawn on the FieldFox screen.

Figure 9-2

Waterfall display- moderate angle- with time markers 1 minute apart.

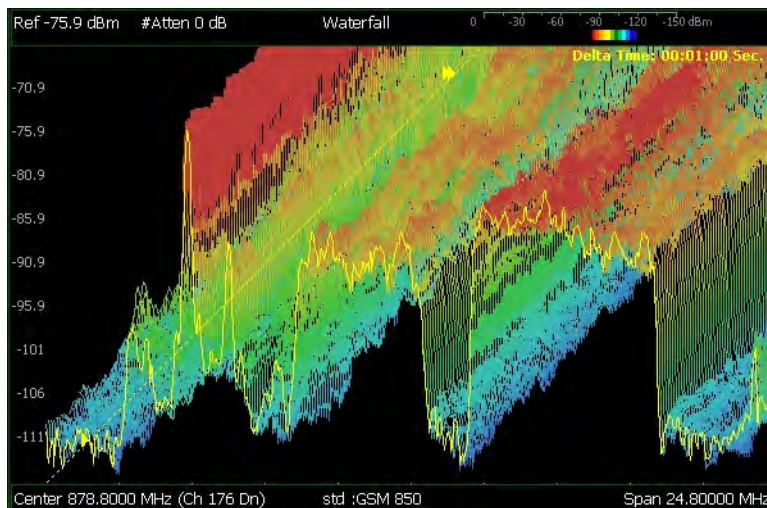

The following settings all contribute to the sweep time of an individual trace, and therefore, the total elapsed time that can appear on the screen in Waterfall display:

- Frequency Range. Learn more in [“Frequency Range” on page 8-4](#).
- Resolution BW and Video BW. Learn more in [“Resolution Bandwidth \(Res BW\)” on page 8-20](#) and [“Video Bandwidth \(Video BW\)” on page 8-21](#).
- Sweep Time (Acquisition). Learn more in [“Sweep Acquisition” on page 8-22](#)
- Resolution (Number of Points). Learn more in [“Points” on page 8-27](#).

Waterfall Angle

This setting allows you to show more or less detail. More detail provides fewer (time) records.

- Press **Meas Setup 4**.
- Then **Spectrogram Settings**.
- Then **Waterfall Angle**.
- Then choose from the following:
 - **Moderate** Compromise between detail and number of records.
 - **Steep** Least detail with highest number of records.
 - **Gradual** Most detail with lowest number of records.
 - **Wide Angle** Moderate angle with increased space between records.

Learn how to [“Set Red and Blue Limits” on page 9-3](#).

Record/Playback

Record Playback allows you to record SA trace sweeps and play them back at a later time. Use this feature to monitor spectrum activity over a period of time.

You can record traces continuously, record a specified number of traces (segments), or record when triggered by a specified power level.

Traces can be recorded from, or played back into, any measurement type (such as Channel Power or Occupied BW) or any display type (such as Spectrogram and Waterfall).

When GPS is enabled, the current location and elevation are saved and played back with traces.

Recordings can be saved to the FieldFox Internal memory, an SD Card, or a USB flash drive.

About Sessions

A Recording Session is a collection of recorded traces and the instrument states that generated them.

Before recording can occur, a new session must be initiated or an existing session must be opened. Sessions can later be opened for playing or continued recording. Only one session can be open at a time.

You close the session when finished recording or playing. A session is also closed when the FieldFox is Preset (or Mode Preset), an Instrument State is recalled, or when Mode is changed from SA.

Each session is saved as a folder containing a set of files on the specified storage device.

How long can a recording session last?

There are many variables that determine the possible length of a recording session. But one key variable is the amount of available memory.

When a session is opened or a new session is initiated, an estimate is made of the maximum number of traces that can be saved based on the available disk space and the current number of data points (resolution). Recording will stop when that number is reached. This estimate always keeps 4 MB of available disk space on the specified storage device. You can decrease the number of traces to further limit recording. The resolution setting can NOT be changed after a session is opened.

To maximize the amount of space that is available, save recorded traces to a USB Flash drive or SD card. Learn how in **“Manage Sessions” on page 9-14.**

You can determine the length of time over which recording can occur by setting the Record Interval (the time between recorded traces) and other settings. Learn more in **“Recording Configuration” on page 9-11.**

To view and edit the maximum number of records

Just after opening or initiating a session...

- Press **Session Data**.
- Then **TraceRecordLimit <n>** (n = Max number of traces that can be recorded).
- **Clear All Records** Empties that session of recorded traces. Learn more in **“Manage Sessions” on page 9-14**.

FieldFox Setting Changes during Record and Playback

During Recording

When any of the following State settings are changed during recording, the State counter is incremented (**“About State and User Tags” on page 9-9**) and the settings are saved to the Session file along with the first trace to be recorded with the new setting. During playback, the trace and display annotation will reflect the change on the screen.

State settings: Frequency Range, Resolution BW, Video BW, Zero Span Sweep Time, Sweep Acquisition, Preamp On/Off, Attenuation, Detector, Average Type, Trigger Settings, Independent Source.

Other display settings, such as Scale and Reference Level, can also be changed during recording but are not saved with the session file. Think of these as settings that help YOU see the recording and playback activity. They do NOT change the data that is recorded.

During Playback

The State setting changes listed above are NOT allowed during playback.

However, all other display settings can be changed during playback to help you analyze the recorded data.

The recordings can be played into different measurements such as Channel Power or Occupied BW. When the recorded data is not compatible with the measurement type, a **MEAS UNCAL** message will appear on the screen.

The data can also be played back in Spectrogram and Waterfall displays.

Record/Playback Exceptions

- Markers can be activated and moved to help analyze recorded data. However, marker position control is only available when playback is Paused.
- Field Strength Corrections is saved with the session file and it is also allowed during playback. Learn about **“Field Strength Measurements” on page 8-12**.
- Frequency Counter at Marker is NOT allowed during Recording or Playback. Learn about this feature in **“Frequency Counter at Marker” on page 8-34**.

About State and User Tags

When any of the State settings (listed above) are changed during a recording, a 'state tag' is inserted at the first trace number to be recorded with the new setting.

In addition, you can insert a 'User Tag' at any time during a recording session to indicate an external event, such as when an antenna is moved. During playback, you can move quickly to any of these tags, or scroll through these tags.

A symbol is used on the screen annotation to distinguish a User Tag from a State Tag when scrolling through tags during playback.

Screen Annotation

During a record or playback session, the following is displayed in the top-left area of the screen:

– **AutoSession02: 92/95 (state 4/5)_***
Sep.22.2009 09:15:15 AM

where:

- **AutoSession** is an auto-generated name for sessions. **02** is the auto-generated number, incremented with each new session. The name can be changed using Manage Sessions. Learn more in [“Manage Sessions” on page 9-14](#).
- **92/95** is the current and total trace number: currently trace is 92 of 95 total traces.
- **state 4/5** is the current and total state tag or user tag number: 4 of 5 total tags.
- ***** (Asterisk) indicates that a state has changed. **#** (Pound) indicates that a User Tag has been inserted.
- **Sep.22..** is the date and time of recording.

When GPS is enabled, the current location and elevation are annotated at the bottom of the playback display. Learn more in [“GPS” on page 12](#).

NOTE

If Recording or Playback is not occurring when you think it should, check the following:

- Is the sweep in **HOLD**? (upper-left annotation)
- Is Recording or Playback **Paused**? (mid-left annotation)
- Is the Record or Playback **Interval** set too long? (Configuration settings.)

How to Record a Session

- Press **Trace 6**.

- Then **Record Playback Setup**.
- Optionally set resolution (points). Learn how in **“Points” on page 8-27**. This can NOT be changed after a session is opened.
- Then either:
 - **New Session** OR
 - **Recall Session** then **Open** and select a session.
- Then **Recorder Player**.
- Then **Record**.

REC is displayed in the left of screen graticules.

During recording, choose from the following:

- **Pause Resume** Temporarily halts recording until pressed again. The incoming trace continues to sweep. Press again to continue recording.
- **Stop** Immediately stops recording. Then choose from the following:
 - Press **Play** to start replaying the recording from the beginning.
 - Press **Record** to continue recording.
- **User Tag** Press to insert a User Tag at the current recorded trace. This allows you to quickly move to this location during playback. Learn more in **“About State and User Tags” on page 9-9**.

How to Playback a Session

- Press **Trace 6**.
- If the session is already open, skip the following step. Otherwise:
- Then **Record Playback Setup**.
 - Press **Recall Session** Then select a session to playback and press **Open**.
- Then **Recorder Player**.
- Then **Play**.

PLAY is displayed in the left of screen graticules during playback. When the end of the recording is reached, playback begins again at trace 1 and continues to loop indefinitely.

During playback, choose from the following:

- **Pause Resume** Temporarily halts playback. Then choose from the following:
 - **Pause Resume** Press to continue playing.

- **Playback State/Tag** Allows you to continue playback from a state tag, or scroll through the state tags. Enter a value between 1 and the total number of state tags using the numeric keypad, **▲▼** arrows, or the rotary knob. Learn more in **“About State and User Tags” on page 9-9**.
- **Playback Trace** Activated automatically when Paused. Allows you to continue playback from a specific trace, or scroll through traces manually. Enter a value between 1 and the total number of traces using the numeric keypad, **▲▼** arrows, or the rotary knob.
- **Stop** Immediately stops playback. Then choose from the following:
 - **Play** Start playback from trace 1.
 - **Record** Resume recording from the last recorded trace.
 - **Record Playback Setup** Return to the setup menu to change Configuration settings or Close the session.

Recording Configuration

To change Recording Configuration settings:

- Press **Trace 6**.
- Then **Record Playback**.
- Then **Record Playback Setup**.
- Then **New Session** or **Recall** an existing session.
- Then **Recording Configuration**.

Then choose from the following:

- **Record Time** Sets the amount of time to record traces. Default is MAX, which is to record indefinitely. Enter a value between 1s and 1 Ms (million) seconds using the numeric keypad, **▲▼** arrows, or the rotary knob. When set, a timer appears during recording in the lower-left corner which counts DOWN from the specified time.
- **Record Source** Sets where, in the FieldFox data flow, data is recorded. Learn more in **“Record Source” on page 9-13**. Choose from the following:
 - **RawMeas** Records raw measurement data.
 - **Trace 1,2,3,4** Records data from the corresponding trace in its current state.

- **Record Interval** Sets the amount of time to wait between individual trace recordings. Default is MIN, which is to wait 0 seconds (record traces as fast as possible). Enter a value in seconds between 0 (no delay) and 10,000 seconds – about 3 hrs) using the numeric keypad, **▲▼** arrows, or the rotary knob.
- **Segment Count** Sets the number of traces to record, after which the recording will automatically pause. Press Pause/Resume or Record to capture another N traces, or Stop to end recording. Default is OFF, which is NO limit to the number of traces to be recorded.

When set, a counter appears in the lower-left corner which counts UP to the specified number of recordings.

- **FreqMaskTrigger OFF ON** Sets the power level which will trigger a recording. Set these power levels (mask) exactly as you would set Limit Lines. (See **“All about Limit Lines” on page 16-14.**) With **Record ON**, when any data point measurement is higher than an upper limit, or lower than a lower limit, recording begins. See Frequency Mask Trigger Configuration in the following section to learn how to configure the mask.

Typically you would use FreqMaskTrigger with Segment Count, but it can also be used with Record Time and Record Interval.

When used with **Segment Count**:

- When a mask limit is exceeded, subsequent traces are recorded until the specified segment count is reached. Once segment count is reached, exceeding another mask limit will again cause traces to be recorded until the segment count is reached, and so forth.
- To record only those traces that exceed the limit, set Segment Count to 1
- To record ALL traces after a limit is exceeded, set Segment Count OFF.

When used with **Record Time**, the timer counts down even when traces are not being recorded (limits are not being exceeded). Recording starts when a limit is exceeded and stops when the timer reaches 0.

When used with **Record Interval**, a trace is recorded when a limit is exceeded, then no recordings during the specified ‘wait’ interval, then the next trace is recorded, followed by another time delay, and so forth. This pattern repeats indefinitely if Segment Count is OFF, or (if ON) until Segment Count is reached.

Frequency Mask Trigger Configuration

Create or recall a Frequency Mask to be used with the FreqMaskTrigger feature.

NOTE

The Mask file is saved to, and recalled from, the Save /Recall Storage Device location – NOT from the Record Playback Storage Device location. These are two different settings. Learn how to set the Save /Recall Storage Device in **“Set File Type and Select Device” on page 17-5.**

A mask that is in use during a recording is NOT saved with the recording and does NOT automatically appear during playback. Like Limits Lines, it is saved and recalled with a state file.

Although they are created in the same manner, Limit Line files and FreqMask files can NOT be used interchangeably.

- Press **Trace 6**.
- Then **Record Playback**.
- Then **New Session** or **Recall** an existing session. The current mask appears as soon as a session is opened.
- Then **FreqMaskTrigger Configuration**.
- Then choose from the following
 - **Edit Mask** Create or modify the current mask. Learn how to edit the Mask / Limit Line table in **“All about Limit Lines” on page 16-14**.
 - **Save Mask** Saves the current mask to a file.
 - **Recall Mask** Loads a mask file.

Record Source

The simplest way to use Record Playback is to record RawMeas data, which can then be played back into all of the current Trace States.

However, for more complicated processing, refer to the following diagram. This illustrates where in the FieldFox data flow data is recorded and played back.

NOTE

For this discussion, it is important to understand Trace States. Learn more in **“Trace Display States” on page 8-28**.

Figure 9-3 FieldFox Data Flow and Record Playback Data Points

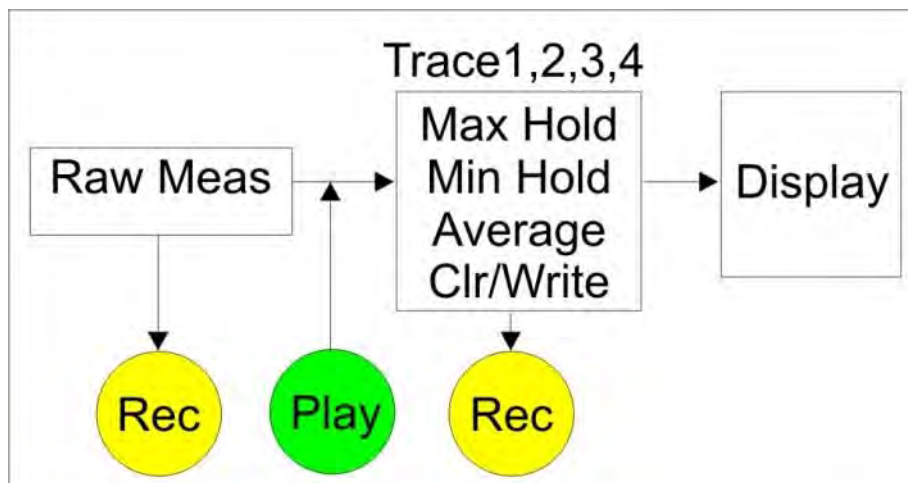

- Data can be recorded at the **Raw Meas** block where data is acquired after ResBW, VideoBW, and Detector processing, but before any trace state processing.
- Data can be recorded from Traces 1,2,3, or 4 which includes the trace state (Max Hold, Min Hold, and so forth).
- Recording from a Clear/Write trace yields exactly the same data as recording from the Raw Meas block.
- Data is ALWAYS played back at the same location in the data flow: just after the Raw Meas block, through all currently active Traces, and onto the display.
- See an **example** using Record Playback with Max Hold traces in **“Record Playback Example” on page 9-15.**

Playback Configuration

By default, trace sweeps are played back as fast as the trace can be drawn on the screen. The following setting allows you to slow playback. In addition, you can manually scroll through individual traces using Playback Trace, or scroll through State and User Tags using Playback State/Tag. Learn more in **“How to Playback a Session” on page 9-10.**

To slow playback of a session:

- Record a new session or Open an existing session.
- Press **Playback Configuration** and choose one of the following:
 - **Playback Interval**
 - Enter a value in seconds between 0 (no delay) and 100 using the numeric keypad, **▲▼** arrows, or the rotary knob. After using the keypad, select a multiplier key. Learn more in **“Multiplier Abbreviations” on page 2-14.**
 - Press Enter.

Manage Sessions

- Press **Trace 6**.
- Then **Record Playback Setup**.

The following selections are available ONLY when a session is NOT open.

- Then **Storage Device** to select the media which stores the sessions to be managed. This is a different setting from the Save/Recall Storage Device setting.
- Then choose from the following:
 - **Internal** FieldFox memory (default).

- **SD Card** An external SD Card (must be inserted).
- **USB** An external USB flash drive (must be inserted).
- Then **Manage Sessions**.
- Then choose from the following:
 - **Name** Using the FieldFox labeler, change the name of the session. AutoSession (n) is the default name where (n) is the next-available number. Learn more in **“Set File Type and Select Device” on page 17-5**.
 - **Sort** Arrange the listing of sessions **by Name**, **by Date**, or **by Size**.
 - **Delete** After a confirmation prompt, removes the contents of the selected session from the list.
 - **Copy** Copies the selected session to a different storage device, or the same storage device with ‘Copy_’ appended to the beginning of the name so that duplication is prevented.
 - **Copy All** Copies ALL of the listed sessions to a different storage device, or the same storage device with ‘Copy_’ appended to the beginning of the names so that duplication is prevented.

Record Playback Example

The following “Interval Recording” example shows how you can record spectral activity over a longer period of time with less trace storage.

- Press **Trace 6** then, with **Trace** = 1, press **State** then **Max Hold**
- Then **Record Playback Setup**.
- Then **New Session**.
- Then **Recording Configuration**.
- Then **Record Source** to Trace.
- Then **Record Interval** to 10 **s** (seconds).
- Then **Back**.
- Then **Recorder Player**.
- Then **Record** At the end of each 10 second record interval, the Max Hold trace is recorded and the Max Hold processing is reset for the next 10 second record interval.
- Then **Stop** to end the recording.

This session can be played back into any Trace State. For example:

Play the Max Hold recording into a **Clear/Write trace** to see the data exactly as it was recorded.

- Press **Trace 6** then with **Trace** = 1 and press **State** then **Clr/Wr**.

Interference Analyzer (SA Mode) – Option 236
Spectrogram and Waterfall Displays

- Then **Record Playback**.
- Then **Play**.

Play the Max Hold recording into a Max Hold trace to show the accumulation of “Max Hold” activity over the entire recording.

- Press **Trace 6** then with **Trace** = 1 and press **State** then **Max Hold**.
- Then **Record Player**.
- Then **Play**.

10 Channel Power Meter Mode - Option 311

Channel Power Meter (also known as CPM or Built-in Power Meter) uses the RF IN connector to make quick and simple power measurements over a selectable frequency span. A power sensor is NOT required.

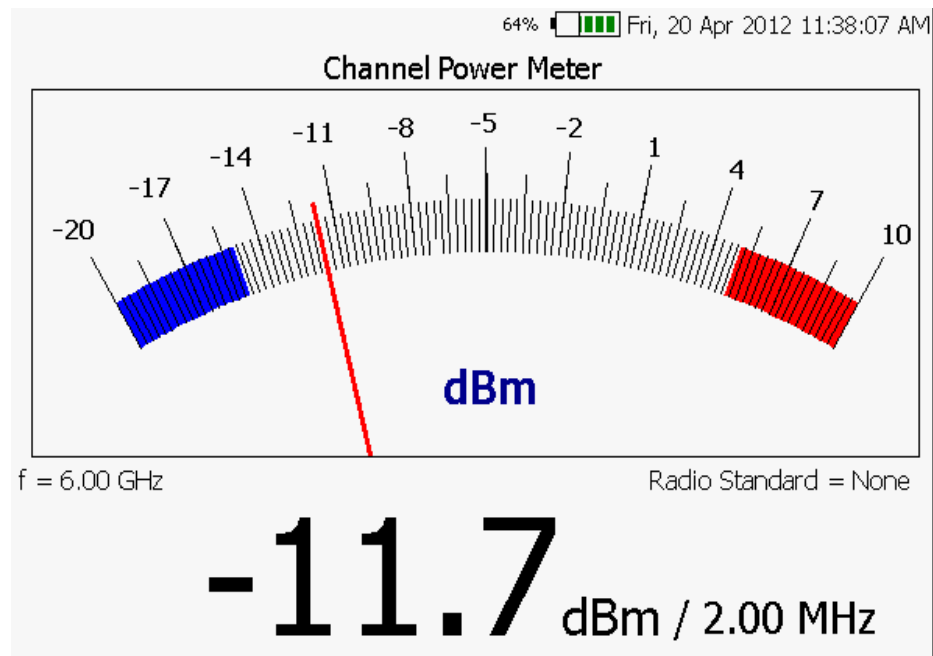

In this Chapter

["How to select Reflection Mode" on page 10-3](#)

["Frequency/Span/Step" on page 10-3](#)

["Radio Standard" on page 10-4](#)

["Attenuation" on page 10-4](#)

The following CPM settings are identical to the standard Power Meter settings. Learn more about these settings:

[“Scale” on page 11-5](#)

[“Relative and Offset Power Measurements” on page 11-6](#)

[“Display Units” on page 11-6](#)

[“Averaging” on page 11-7](#)

[“Single or Continuous Measure” on page 11-7](#)

[“Limits” on page 11-8](#)

CPM Settings

Connect the power to be measured to the RF IN port on the FieldFox top panel. Select CPM Mode before making any setting in this section.

How to select Reflection Mode

- Press **Mode**.
- Then **CPM**.

CAUTION

Please observe the RF IN port damage level.

+27 dbm (320 mW) average

+33 dBm peak (2 W) < 10 μ s

+50 V

Frequency/Span/Step

Valid CPM measurements can be made over the entire frequency range of the FieldFox. Although it is possible to enter a center frequency below the FieldFox minimum frequency, the LO feed-thru of the internal SA hardware will invalidate these Built-in Power Meter measurements.

The measurement span (also known as Channel Width and Integration BW) is the frequency range, half above and half below the center frequency, over which power is detected and displayed. The maximum measurement span is 100 MHz.

A Radio Standard can also be used to set the center frequency and span. Learn more about **“Radio Standard” on page 8-6**.

How to enter center frequency, step size, and span

The default frequency is 50 MHz.

- Press **Freq/Dist** or **Meas Setup 4**.
- Then **Frequency**.
- Then **Center**.
- Then type a value using the numeric keypad. Then press a multiplier key. Learn about **“Multiplier Abbreviations” on page 2-14**. The current frequency (f) is shown on the FieldFox screen.
- Optionally, use the **▲▼** arrows to quickly change Center frequency. The size of the frequency step can also be changed. Press **CF Step** then type a step size value using the numeric keypad, then select a multiplier key. Optionally press.

- Optionally press **Span(Ch Wid)**. Type a value using the numeric keypad. Then press a multiplier key. The default span is 2 MHz. The maximum measurement span is 100 MHz. The current span setting is shown as the dividend in the digital display. For example: -10 dBm / 1.00 MHz.

Radio Standard

A Radio Standard can be used to integrate power within specific radio channels. When a Radio Standard is selected, the Span setting is automatically coupled to the defined Channel Width for that standard. (Width is the same for all channels within a standard.) Also, Unit is set to Chan and CF is set to the nearest specific Channel defined in the standard.

Learn all about Radio Standards, including Importing and Deleting Custom Radio Standards, beginning on [page 8-6](#).

How to Select a Radio Standard

- Press **Measure 1** or **Freq/Dist**.
- Then **Radio Standard**.
- Then select a standard using the arrows **▲▼** or rotary knob and press **Enter**.

Attenuation

The Attenuation setting controls the power level into the FieldFox.

To compare CPM measurements to SA Channel Power measurements, use the same attenuation settings. Built-in Power Meter Mode defaults to 30 dB attenuation, while SA mode defaults to 10 dB attenuation. In CPM Mode, the attenuation setting is NOT annotated on the screen.

How to set Attenuation

- Press **Scale/Amptd**.
- Then **More**.
- Then **Internal Atten**.
- Then choose from either **30dB** or **10dB**.

NOTE

The following CPM settings are identical to the standard Power Meter settings. To learn about these settings, please refer to the following pages:

[“Scale” on page 11-5](#)

[“Relative and Offset Power Measurements” on page 11-6](#)

Channel Power Meter Mode - Option 311
CPM Settings

“Display Units” on page 11-6

“Averaging” on page 11-7

“Single or Continuous Measure” on page 11-7

“Limits” on page 11-8

Channel Power Meter Mode - Option 311
CPM Settings

11 Power Meter Mode (Option 302)

Power Meter measurements are made with Keysight USB power sensors. Power readings are displayed on the FieldFox screen.

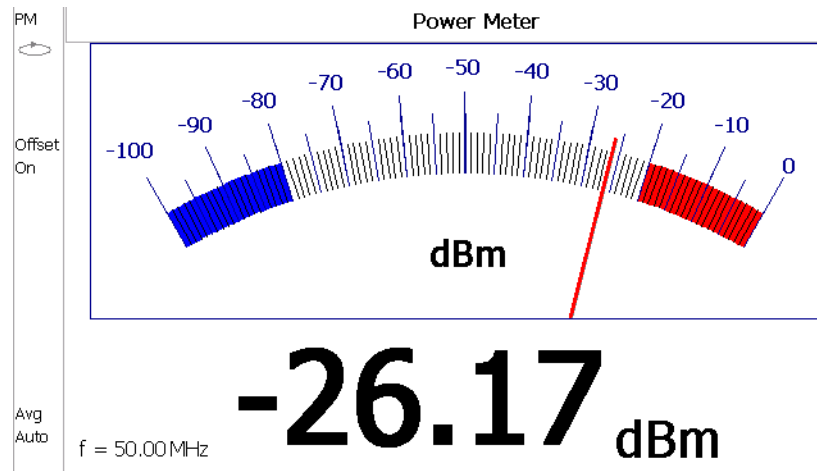

In this Chapter

- “Supported Power Sensors” on page 11-2
- “How to Connect the Power Sensor” on page 11-2
- “Average / Peak” on page 11-3
- “Zeroing” on page 11-3
- “Frequency” on page 11-4
- “Source Control” on page 11-4
- “Scale” on page 11-5
- “Relative and Offset Power Measurements” on page 11-6
- “Display Units” on page 11-6
- “Averaging” on page 11-7
- “Single or Continuous Measure” on page 11-7

[“Step Detection Mode” on page 11-8](#)

[“Limits” on page 11-8](#)

See Also

[“FOPS Settings” on page 12-5](#)

Supported Power Sensors

For a complete list of supported Keysight USB Power Sensors, please visit:
www.keysight.com/find/usbsensorsforfieldfox

NOTE

The FieldFox does NOT support the following Keysight USB Power Sensor features: External Triggering (Time Gated Burst Power Measurement), Power Sweep Operation, and Frequency Sweep Operation. External Zeroing is NOT allowed on the U2020 X-series Power Sensors.

CAUTION

Please refer to your USB Power Sensor User’s Guide and observe the damage levels of your device.

How to Connect the Power Sensor

Connect your Power Sensor to one of the FieldFox USB ports.

NOTE

Use an attenuator between the DUT and the power sensor when measuring power levels that are higher than +20 dBm. The attenuator value can be subtracted from the measurement using the Offset feature, discussed in [“Relative and Offset Power Measurements” on page 11-6](#).

A sequence of status lights are displayed on the base of the power sensor.

- **Green blinking** light indicates the power sensor is communicating or self-tests are being performed. Because the FieldFox is usually communicating with the power sensor when it is connected, this is the normal mode of operation.
- **Amber light** indicates Zeroing is being performed.
- **Red light** indicates an error has occurred with the power sensor. Refer to power sensor documentation.
- **No light** indicates the FieldFox is not communicating with the power sensor. This is the case when in Hold mode or when NOT in Power Meter Mode.

Power Meter Settings

Select Power Meter Mode before making any setting in this section.

How to select Power Meter Mode

- Press **Mode**.
- Then **Power Meter (USB Sensor)**.

Average / Peak

- Press **Measure 1**.
- Then choose from the following:
 - **Average** Measures and reports the average of the power measurements.
 - **Peak** Available ONLY on the U202x power sensors. Measures and reports peak power detected at sensor input.

Zeroing

The Keysight USB Power Sensors perform Internal Zeroing automatically. Because Keysight USB Power Sensors have an internal switch, Internal Zeroing does NOT require that the power source be turned OFF.

For highest measurement accuracy, when measuring power levels below -30 dBm, External Zeroing should be performed.

During External Zeroing, the power source MUST be turned OFF or the power sensor disconnected from the power source (device under test). Power is OFF when power sensor measurements are below -60 dBm. When power higher than this is detected at the sensor, a warning message is shown on the FieldFox and External Zeroing will not proceed.

NOTE

External Zeroing is NOT allowed on the U2020 X-series Power Sensors.

How to perform External Zeroing

- Press **Cal 5**.
- Then **External Zero**.

While either Internal or External Zeroing is being performed, “Zeroing...” is shown on the FieldFox screen. While this message is present, do NOT make any changes to the FieldFox.

In addition, once External Zeroing has started, the power source must be OFF for the entire time that the Zeroing message is present. Otherwise, the calibration will be compromised but NO warning is shown.

Frequency

A table of correction factors versus frequency is stored within Keysight Power Sensors. The frequency of the power to be measured is entered in the FieldFox so that the appropriate correction factor can be used.

The Source Control feature (see following section) will determine the frequency range of the power measurement.

How to enter Frequency of the Power Measurement

- Press **Freq/Dist** or **Meas Setup 4**.
- Then **Frequency**.
- Then type a value using the numeric keypad. The default frequency is 50 MHz.
- Then press a multiplier key. Learn about multiplier abbreviations in **“Multiplier Abbreviations” on page 2-14**.

The current frequency is shown on the FieldFox screen.

Source Control

This feature may require an option on some FieldFox models.

With the FieldFox internal source enabled, these settings allow you to make simple, absolute power measurements. The source and the power sensor can be physically separated by a long distance when using a long USB cable.

Set the internal source frequency by setting the frequency of the power measurement. Learn how in the previous section.

Power Meter measurements are limited by the combined frequency ranges of the internal source when enabled and the frequency range of the power sensor. For example, assume the frequency range of your sensor is 9 kHz to 18 GHz and the frequency range of the FieldFox is 2 MHz to 6 GHz.

- With the Source ON, measurements are limited to 2 MHz to 6 GHz.
- With the Source OFF, measurements are allowed from 9 kHz to 18 GHz.

How to Set Source Control and Power Level

- Press **Freq/Dist**.

- Then **Advanced**.

NOTE

When Option 208 (FOPS) is enabled, to access Source Control, press **Sweep 3**. Then **Power Setup**. Learn more about “Frequency Offset Using Power Sensor (FOPS) – Option 208” on page 12-1.

- Then **Source Enable**
 - **ON** Turn ON the internal source.
 - **OFF** Turn OFF the internal source.

Optionally set the power level.

- Press **Src Nom Power** (0.0 dBm default setting) Set output power to an arbitrary value at the displayed CW frequency.
- Then enter a value using the numeric keypad, the **▲▼** arrows, or the rotary knob.
- Press **Enter**.

Scale

The scale of the Power Meter display can be set manually or automatically. The major and minor ticks are set automatically and can NOT be changed. Although the scale settings are limited, you can view measurements beyond these settings by performing Autoscale.

How to Scale the Power Meter Display

Manually:

- Press **Scale / Amptd**.
- Then choose from the following:
 - **Scale Min** Sets the low power level of the power meter display. Type a number and select the units or press Enter. This value is limited to -100 dBm.
 - **Scale Max** Sets the high power level of the power meter display. Type a number and select the units or press Enter. This value is limited to 100 dBm.

Autoscale:

Using Autoscale, the current reading is used for the center of the scale, and Min and Max values are set accordingly.

- Press **Scale / Amptd**.
- Then **More**.
- Then **Autoscale**.

Relative and Offset Power Measurements

Power measurements can be made that are relative to another reading or that are offset by a fixed value.

- Use Relative to measure the difference between power levels.
- Use Offset to account for components or a long length of cable that is used before the power sensor. For example, if using a 10 dB attenuator to protect the FieldFox, enter an Offset Value of 10 to read the power as it would appear without attenuation. If using a 10 dB amplifier, enter an Offset Value of -10 to read the power as it would appear without amplification.

How to set Relative and Offset Power Measurements

- Press **Scale / Amptd**.
- Then choose from the following:
 - **Relative Off On** When switched to ON, the FieldFox measures and stores the current power level. Subsequent power measurements display a power level which is relative to the stored value. When relative is ON, the units change from dBm to dB or from Watts to %.
 - **Offset Off On** Toggles ON and OFF the displayed power level using the Offset value.
 - **Offset Val** Value by which the power meter display is offset. A positive value compensates for a component with loss. A negative value compensates for a component with gain. Offset values are limited to +/- 100 dB.

Display Units

Select whether to display power in dBm or Watts. When making relative power measurements, these change to dB and %.

How to set Power Meter display units

- Press **Meas Setup 4** or **Scale / Amptd**.
- Then **Unit**.
- Then choose from the following:
 - **dBm (dB)** Sets Power Meter display to dBm or dB.
 - **Watt (%)** Sets Power Meter display to Watts or %.

Resolution

Resolution sets the number of digits to display after the decimal point on the digital power meter display.

How to set Resolution

- Press **Scale / Amptd**.
- Then **More**.
- Then choose from 0, 1, 2, or 3.

Averaging

Averaging is used to improve measurement accuracy in low power or noisy power situations. Increased averaging improves measurement accuracy, but also reduces measurement speed.

How to set Power Meter Averaging

- Press **BW 2** or **Meas Setup 4**.
- Then choose from the following:
 - **Averaging Auto Man Off**.
 - **Auto** Allows the USB Power Sensor to use its Auto Averaging settings. See the USB Power Sensor documentation for details.
 - **Man** Manually enter an averaging count by setting **Num Averages**.
 - **OFF** Performs NO averaging.
 - **Num Averages** Sets the number of Power Meter readings to be averaged before a valid reading is displayed. When the number is changed, **Averaging** is automatically set to Man.

Single or Continuous Measure

This setting determines whether the FieldFox measures continuously or only once each time the **Single** button is pressed. Use **Single** to conserve battery power or to allow you to save or analyze a specific measurement.

This setting can be changed at any time without affecting calibration accuracy.

How to set Single or Continuous

- Press **Sweep 3**.
- Then choose one of the following:
 - **Single** Automatically sets Continuous OFF and causes FieldFox to make ONE measurement, then hold for the next **Single** key press. When a data trace is displayed, the entire trace is measured, then holds. The **Hold** annotation changes to an arrow --> while the measurement occurs.
 - **Continuous** Makes continuous measurements. This is the typical setting when battery power is not critical.

You can also use **Run / Hold +/-** to toggle between Single and Continuous.

Step Detection Mode

The FieldFox supports the Step Detection feature that is present in U2000 series power sensors. When enabled, this feature reduces settling time after a significant step in the measured power. For more information, please refer to the USB Power Meter documentation.

How to set Step Detection mode

- Press **Meas Setup 4**.
- Then **Step Detection OFF ON**.
- Then choose from the following:
 - **ON** Enables step detection (default setting)
 - **OFF** Disables step detection

Limits

In Power Meter Mode, Minimum and Maximum limits set a visible range of acceptable readings between these two values. Readings that are below the minimum or above the maximum are clearly visible on the power meter display.

How to set Limits

- Press **Limit 8**.
- Then choose from the following:
 - **Min Limit OFF ON** Toggles the display of the Minimum limit ON and OFF.
 - **Min Limit Value** Sets the Minimum limit power value. Power reading lower than this will exceed the limit.
 - **Max Limit OFF ON** Toggles the display of the Maximum limit ON and OFF.
 - **Max Limit Value** Sets the Maximum limit power value. Power reading higher than this will exceed the limit.

12 Frequency Offset Using Power Sensor (FOPS) – Option 208

FOPS is accessed through (and requires) Option 302 USB Power Meter Mode. With both options installed, you can send a signal with the FieldFox internal source at one frequency, and measure this signal with a Keysight U-Series USB Power Sensor at another frequency.

Figure 12-1 Display for FOPS

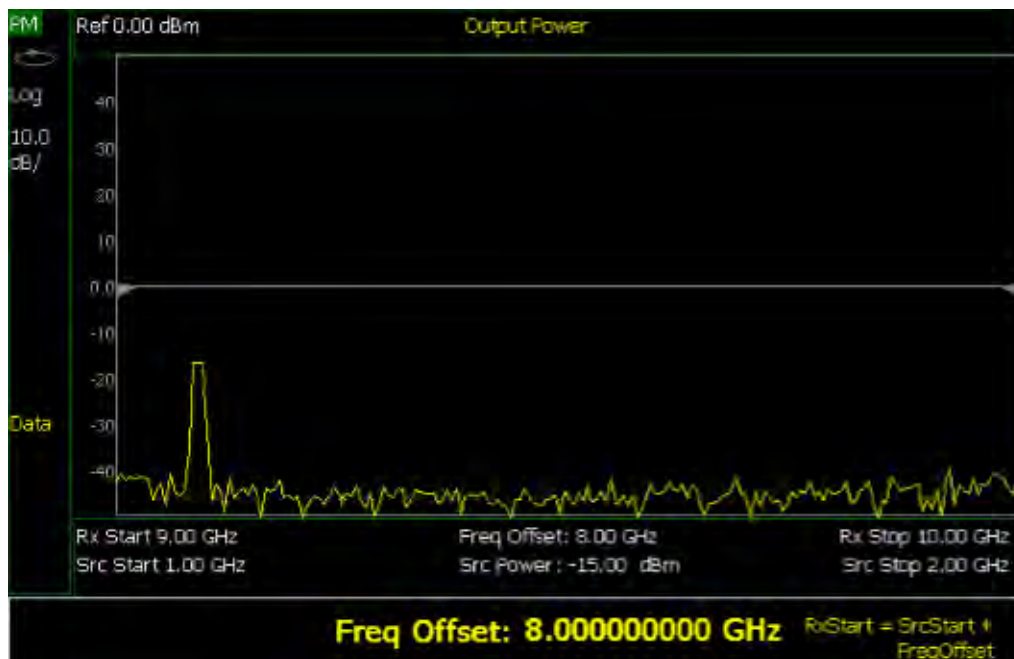

In this Chapter

- “Overview” on page 12-3
- “Measurement Selection” on page 12-5
- “Sweep Type and Frequency” on page 12-6
- “Power Sensor Settling” on page 12-8
- “Sweep Settings” on page 12-8

[“Amplitude Markers” on page 12-9](#)

[“Trace Math” on page 12-9](#)

See Also

[“All about Trace Math” on page 16-19](#)

Overview

This feature allows the FieldFox source frequency to be set independently from the power sensor (receiver) frequency. With frequency offset using power sensor (FOPS), the frequency of both the source and receiver are swept, and the two track each other. The offset frequency can be negative, zero, or positive.

FOPS can be used to characterize the scalar transmission response of devices such as mixers and converters. This frequency offset capability is necessary for conversion loss/gain measurements on frequency-translating devices since, by definition, the input and output frequencies of the DUT are different. The FieldFox source stimulates the DUT and the power sensor is used as the measurement receiver.

Since power sensors are inherently broadband devices (not frequency-selective), it is your responsibility to ensure that ONLY the signal of interest is present at the power sensor input and that all other signals are filtered appropriately.

For some DUTs, the output frequency may sweep in a reverse direction, as compared to the source frequency. The FieldFox analyzer includes an offset calculator that ensures a fast measurement setup.

The following shows a typical use case for FOPS:

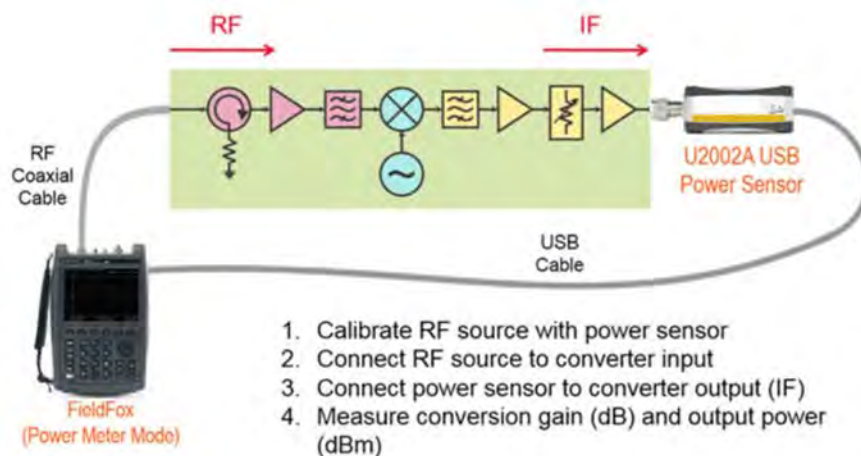

- The DUT is a frequency converter.
- The FieldFox source is tuned to the RF frequency.
- The USB power sensor, with an equally long USB/LAN cable, is connected to the IF Output. USB/LAN extenders are NOT provided with the FieldFox or Keysight USB power sensors.
- Conversion gain/loss is measured at power sensor.

NOTE

The dynamic range with FOPS may be significantly different when using various power sensors. In general, the lower frequency range sensors have better dynamic range.

FOPS Settings

The following settings are unique to FOPS. Standard USB Power Meter mode settings, which may be useful with FOPS, are documented in that chapter starting on [page 11-3](#).

Select Power Meter (USB Sensor) before making any setting in this section.

How to select Power Meter (USB Sensor)

- Press **Mode**.
- Then **Power Meter (USB Sensor)**.
- Then connect a USB Power Sensor to either FieldFox USB port.
- For a complete list of supported Keysight USB Power Sensors, please visit: www.keysight.com/find/usbsensorsforfieldfox

Measurement Selection

- Press **Measure 1**.
- Then choose from the following:
 - **Src Power Measure** Similar to a ‘normalization’ cal, this selection guides you through the following steps to make a measurement at the reference plane and then store the data trace into memory.
 - Connect the power sensor to the measurement reference plane. This is the location to where power measurements are to be referenced. For example, to measure only the conversion loss through a converter, attach the power sensor to the cable that connects to the converter input.
 - Press **Measure**. When finished, press **Src Data -> Mem** to store the measured data into FieldFox memory. Preset or Mode Preset will clear the stored memory.
 - Optionally choose from the following:
 - **Re-Measure** Make another measurement.
 - **Src Data** View only the re-measured data.
 - **Src Memory** View only the stored memory data.
 - **Src Data & Memory** View both the re-measured data and the stored memory data.
 - 4. Press **Done**.
 - **Src Power Memory** Not available until source data is stored into memory. Displays only the source power memory trace.

- **Gain** Not available until source data is stored into memory. Displays the Output power / Source power (memory trace).
- **Rx Power** Displays the raw received power at the USB power sensor.

Sweep Type and Frequency

Set the source and receiver frequencies for the FOPS measurements. The receiver is a Keysight U-Series Power Sensor. These are broadband measurement devices, which means that they measure power over a very wide frequency range. Tables of frequency and power correction factors are stored within the power sensors. The receiver (Rx) frequencies are used ONLY to apply the appropriate correction factors to the power levels measured with the power sensor.

NOTE

It is YOUR responsibility to ensure that ONLY the signal of interest is present at the power sensor. All other signals MUST be filtered appropriately.

How to set Sweep Type and Frequency

- Press **Freq/Dist**,
- Then **Frequency**.
- Then **Sweep Type**,
- Then choose from the following:
- **CW** Used to make standard (non-offset) power meter measurements at a single frequency. Learn more in **“Power Meter Settings” on page 11-3**.

NOTE

To make FOPS measurements at a single frequency, choose Swept, then enter a Src Center frequency, then Span = 0 Hz.

- **Swept** Used to make swept FOPS measurements.
 - Then enter source (Src) frequencies as either Center and Span or Start and Stop. Both methods set the FieldFox internal source sweep range out the Port 1 RF Output connector.
 - The frequency limits are determined by the limits of both the FieldFox and the power sensor.
 - The LOW frequency is limited by the higher of either the FieldFox or the power sensor minimum frequencies.
 - The HIGH frequency is limited by the lower of either the FieldFox or the power sensor maximum frequencies.
 - Then **More**.

- Then **Freq Display**. This determines how the receiver frequencies below the graticules are displayed. Choose from the following:
 - Start** Annotated as Start and Stop frequencies.
 - Center** Annotated as Center and Span frequencies.
- Then choose from the following two methods to determine the **offset frequency** (the frequency that the receiver is offset from the source). This is typically the frequency of the LO that is used with the frequency converter. The frequency offset may be positive, negative, or zero.
- Freq Offset** Enter an Offset frequency. The receiver frequencies are calculated.
- Offset Calculator** Enter the Receiver Start and Stop frequencies. Then press **Calculate Offset**.
- Press **Rx Sweep** to select the receiver sweep direction.
 - Fwd** Used for systems for which the output frequency is $\text{Offs} + \text{Src}$. The output frequency of the DUT and the receiver sweeps in the same direction as the source.
 - Rev** Used for systems for which the output frequency is $\text{Offs} - \text{Src}$. The output frequency of the DUT and the receiver sweeps in reverse direction as compared to the source.

Invalid Settings

Violations of the following conditions will return an error message:

- The frequency span for the source and receiver must be the same.
- Both the source and receiver frequencies must be positive.

FOPS Configuration Examples

Negative Offset, RxSwp = **Fwd** ($\text{Offs} + \text{Src}$)

Src = 2 GHz to 3 GHz

Offset = -1 GHz

Rx = 1 GHz to 2 GHz

Positive Offset, RxSwp = **Rev** ($\text{Offs} - \text{Src}$)

Src = 2 GHz to 3 GHz

Offset = 3.8 GHz

Rx = 1.800 GHz to 800 MHz

Positive Offset, RxSwp = **Fwd** ($\text{Offs} + \text{Src}$)

Src = 2 GHz to 3 GHz

Offset = 3.8 GHz

Rx = 5.8 GHz to 6.8 GHz

Power Sensor Settling

The following two settings work together to allow you to choose the right compromise between measurement speed and accuracy.

Each power sensor reading is considered “settled” when either:

- The difference between two consecutive readings are within the Tolerance value.
- **Or** the Max (number of) Readings has been made.

The readings that were taken are averaged together to become the displayed reading.

How to choose Power Sensor settling

- Press **BW 2**.
- Then **Tolerance**. Enter a value in dB between 0 and 10 using the numeric keypad, the **▲▼** arrows, or the rotary knob. Tolerance of 0 will never be achieved, so the Max Readings will always be made. Press **Enter**.
- Then **Max Readings**. Enter a value between 1 and 20 using the numeric keypad, the **▲▼** arrows, or the rotary knob. Press **Enter**.

Sweep Settings

These settings provide added control of the FOPS measurement.

How to make additional sweep settings

- Press **Sweep 3**.
- Then choose from the following:
 - **Power Setup**.
 - **Source Enable**
 - **ON** Turn ON the internal source (required for FOPS).
 - **OFF** Turn OFF the internal source.
 - **Src Nom Power** (-15 dBm default setting) Set output power to an arbitrary value at the source CW frequency. Then enter a value using the numeric keypad, the **▲▼** arrows, or the rotary knob. Press **Enter**

- **Num Points** or **Freq Step Size** Both settings control the number of power sensor measurements between the Start and Stop frequencies. Enter one setting and the other will be changed automatically. There must be at least two data points.
- **Dwell /Point** Specifies a settling time (in seconds) after the internal source steps to the next frequency and before the power sensor makes a measurement.

Amplitude Markers

Amplitude markers are horizontal dotted lines that you can move to any amplitude level on the screen. The two amplitude markers can be set independently or used as a pair of delta markers. Amplitude markers can be used as a visual comparison aid with the data trace.

How to make Amplitude Marker settings

- Press **Marker**.
- Then **More**.
- Then **Ampl Markers**.
- Then choose from the following:
 - **OFF** Amplitude markers are NOT displayed.
 - **ON** Amplitude markers ARE displayed at their previous positions.
- Then **Ampl Mkr 1 or 2**.
- Enter a value in dBm for the marker using the numeric keypad, the **▲▼** arrows, or the rotary knob.
- Press **Delta Ampl Mkr**.
- Then choose from the following:
 - **ON** AmplitudeMkr 2 value is relative to AmplitudeMkr 1. When AmplitudeMkr 1 is moved, AmplitudeMkr 2 also moves to maintain the AmplitudeMkr 2 value between them.
 - **OFF** The two amplitude markers move independent of one another.

Trace Math

Trace Math allows you to compare data traces and perform simple math. Learn how to use Trace Math in **“All about Trace Math” on page 16-19**. All Data and Memory features work as documented EXCEPT for the following:

NOTE

When Trace, then Data -> Mem is pressed, if a Src Power trace is active, then RxPower is actually stored into memory.

To Compare Src Power (Input) and Rx Power (Output):

1. Meas Rx Power
2. Store to memory

- 3. View Data & Memory**
- 4. Meas Src Power.**

13 Pulse Measurements Mode – Option 330

Pulsed power meter measurements, available with Option 330, are made with Keysight U2020 X-Series USB Peak Power Sensors. These sensors are capable of detecting, measuring, and storing data from a train of pulses at the RF input. This data is queried from the USB Power Sensor and displayed on the FieldFox screen. You can then analyze the data using several selectable settings.

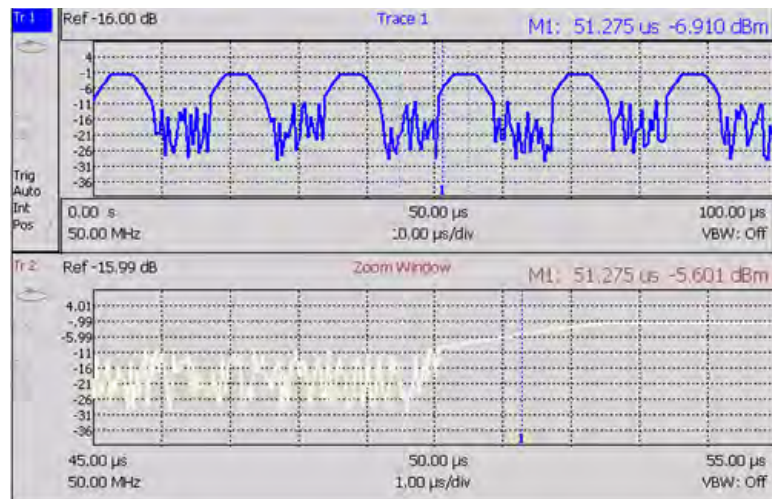

In this Chapter

- “Supported Power Sensors” on page 13-3
- “Measurement Selection” on page 13-4
- “Frequency / Time” on page 13-4
- “Zoom Window” on page 13-5
- “Scale” on page 13-6
- “Averaging” on page 13-6
- “Video Bandwidth” on page 13-7
- “Single or Continuous Measure” on page 13-7
- “Resolution” on page 13-8
- “Triggering” on page 13-8

“Marker Settings” on page 13-11

“Amplitude Markers” on page 13-11

“Pulse Top” on page 13-14

“Grid” on page 13-14

“Trace Memory” on page 13-14

NOTE

Many of the features included with the FieldFox Pulse Measurements Mode are discussed in detail in these two documents:

-
- Keysight U2020 X-Series USB Peak Power Sensors Programmer’s Guide.
<http://literature.cdn.keysight.com/litweb/pdf/U2021-90003.pdf>
 - “Best Practices For Making The Most Accurate Radar Pulse Measurements”
<http://literature.cdn.keysight.com/litweb/pdf/5991-0434EN.pdf>

Supported Power Sensors

Pulse measurements are made using any of the Keysight U2020 X-Series USB Peak Power Sensors.

Zeroing of the U2020 X-Series USB Peak Power Sensors is performed automatically at power up, every 5 seconds, and prior to measuring low level signals.

Switching between Pulse Measurement Mode and Power Meter Mode

NOT Supported - Using a single USB Peak Power Sensor and switching between Power Meter Mode and Pulse Measurement Mode. Both modes will attempt to program the sensor, which could cause one or both modes to hang, or at least report inaccurate data.

Supported - Using one U2000A Average Power Sensor connected to the top USB port for Power Meter Mode, and one Peak Power Sensor connected to the bottom USB port for Pulse Measurement Mode.

How to Connect the Power Sensor

Connect your Power Sensor to one of the FieldFox USB ports.

NOTE

Use an attenuator between the DUT and the power sensor when measuring power levels that are higher than +20 dBm. The attenuator value can be subtracted from the measurement using the Offset feature, discussed in [“Relative and Offset Power Measurements” on page 11-6](#).

A sequence of status lights are displayed on the base of the power sensor.

- **Green blinking** light indicates the power sensor is communicating or self-tests are being performed. Because the FieldFox is usually communicating with the power sensor when it is connected, this is the normal mode of operation.
- **Amber light** indicates Zeroing is being performed.
- **Red light** indicates an error has occurred with the power sensor. Refer to power sensor documentation.
- **No light** indicates the FieldFox is not communicating with the power sensor. This is the case when in Hold mode or when NOT in Pulsed Measurement Mode.

Pulse Measurement Settings

Select Pulse Measurement Mode before making any setting in this section.

How to select Pulse Measurement Mode

- Press **Mode**.
- Then **More** if your FieldFox contains more than five measurement modes.
- Then **Pulse Measurements**.

Measurement Selection

The pulse measurement results are presented as either a traditional power meter display or as a trace graph.

How to select the Measurement

- Press **Measure 1**.
- Then choose from the following:
 - **Average** Average power (Meter display)
 - **Peak** Peak power (Meter display)
 - **Pk to Avg** Displays the difference between the above two measurements (Meter display)
 - **Trace Graph** (default) The primary trace (**Tr 1**) plots pulse data in amplitude versus time. Optionally, you can enable a secondary ‘zoom’ trace. Learn how in [“Zoom Window” on page 13-5](#).
 - When a ‘Meter display’ measurement is selected, the following Pulse Measurement Mode settings are identical to the standard USB Power Meter Mode settings.
 - Learn how to set [“Scale” on page 13-6](#).
 - Learn how to set [“Relative and Offset Power Measurements” on page 11-6](#).
 - Learn how to set [“Display Units” on page 11-6](#).
 - Learn how to set [“Limits” on page 11-8](#).

Frequency / Time

How to set Frequency

- Press **Freq/Dist**.
- Then choose from the following:

- **Frequency** Sets the center frequency of the carrier on which pulse modulation resides. This is used to set amplitude correction of the USB Power Sensor.

How to set Time

Specify the time over which data will be acquired by the USB Power Sensor. When Trace Graph is selected, **Tr 1** is annotated with these values. Time can be specified using either of the following pairs of values:

- **Center 1** and **Time/div 1** Specify the center time and time per division.
- **Start Time** and **Time Length** Specify the start time and length of acquisition.
- A positive start time indicates a delay after the sensor detects a pulse signal.
- A negative start time displays data that is acquired BEFORE the sensor detects a pulse signal (or T-zero).
- Follow each by entering a value using the numeric keypad, the **▲▼** arrows, or the rotary knob.
- After using the keypad, select a multiplier key. Learn more in **“Multiplier Abbreviations” on page 2-14.**

Zoom Window

When Trace Graph is selected as the measurement, a secondary Zoom Trace can be used to view a zoomed portion of **Tr 1**. When Zoom Window is ON, blue vertical posts appear on **Tr 1** to indicate the current start, center, and stop times of the zoom window. The zoom window can be scaled using the standard Scale settings.

How to make Zoom Window settings

- Press **Measure**.
- Then **Zoom Window**.
- Then choose from the following:
 - **ON** Opens the zoom window on the bottom half of the FieldFox screen. The window includes the zoomed trace.
 - **OFF** Closes the zoom window.
- **Zoom Center** While monitoring the T within the blue vertical posts on **Tr 1**, enter a value for the center time using the numeric keypad, the **▲▼** arrows, or the rotary knob.

- **Zoom Time/div** While monitoring the blue vertical posts on the primary trace, enter a value for the zoom window span using the numeric keypad, the \uparrow/\downarrow arrows, or the rotary knob.
- **Trace 1** Press to select **Tr 1**. This can also be done by using the \uparrow/\downarrow arrows. Select a trace before making trace settings, such as Scale.
- **Zoom Trace** Press to select the zoom trace.

Scale

For Meter-style measurements, learn how to set Scale, Relative and Offset Power, display Units, and Resolution beginning in **“Scale” on page 11-5**.

How to set Scale for Trace Graph measurements

- Select a trace to scale using the \uparrow/\downarrow arrows.
- Press **Scale / Amptd**.
- Then choose from the following methods:
 - **Autoscale** Automatically adjusts the Y-axis to comfortably fit the Min and Max amplitude of the trace on the screen.
 - Set Scale, Reference Level, and Reference Position:
 - **Scale** Manually enter a **scale per division** to view specific areas of the trace.
 - **Ref Level** Manually set the value of the reference line. Enter a negative value by pressing **Run/Hold (+/-)** either before or after typing a value.
 - **Ref Pos** Manually set the position of the reference line. Values must be between 0 (TOP line) and 10 (BOTTOM line).
 - **Offset ON** Enable Offset. When only trace 1 is visible, **Offset ON** appears to the left of the trace.
 - **Offset Val** Enter a value by which all amplitude values will be offset. This can have the effect of virtually removing a component from the measurement path. A positive value compensates for a component with loss. A negative value compensates for a component with gain. Offset values are limited to +/- 100 dB.

Averaging

Averaging helps to reduce the effects of random noise on a measurement. The more measurements that are averaged, the greater the amount of noise reduction. Averaging is allowed for all pulse measurements.

Averaging is performed in the USB Power Sensor before the data is sent to the FieldFox.

Annotation in the left pane shows the state of the Average setting. When Manual is selected, the 'Num of Averages' setting is also shown.

How to set Averaging

- Press **BW 2**.
- Then **Averaging**.
- Then choose from the following:
 - **Auto** Averaging is set to a reasonable value by the USB Power Sensor.
 - **Man** Averaging is set to the value specified in the 'Num Averages' setting.
 - **Off** Averaging is OFF.
- **Num Averages** Select a value using the numeric keypad, then press **Enter**.

Video Bandwidth

The Video Bandwidth setting enables an FIR (finite impulse response) filter within the USB Power Sensor. The filter setting affects the appearance of the trace results.

Video Bandwidth is allowed for all pulse measurements.

How to set Video Bandwidth

- Press **BW 2**.
- Then **Video Bandwidth**.
- Then choose from the following:
 - **Off** Video Bandwidth is disabled.
 - **Low** Similar to a low pass filter, ripple in the pass band is minimized but allows higher side-lobes on the filter skirt.
 - **Medium** Smooth pass band with reasonable transition ripple.
 - **High** The pass band ripple is similar to the OFF setting, but the transition skirts are smoother.

Single or Continuous Measure

This setting determines whether the FieldFox continuously queries the USB Power Sensor for data, or only once each time the **Single** button is pressed. Use **Single** to conserve battery power or to allow you to save or analyze specific data.

How to set Single or Continuous

- Press **Sweep 3**.
- Then choose one of the following:
 - **Single** Automatically sets Continuous OFF and causes the FieldFox to query the USB Power Sensor ONCE, then hold for the next Single key press. Hold is annotated in the upper left corner of the display.
 - **Continuous** Queries the USB Power Sensor whenever a valid trigger signal is present. This is the typical setting when battery power is not critical.

You can also use **Run / Hold +/-** to toggle between Single and Continuous.

Resolution

Resolution is the number of individual acquisitions that occur in the USB Power Sensor. This data is read by the FieldFox and plotted across the X-axis to form a trace. More data points increases measurement resolution. However, more data points requires more time to acquire, query, and plot.

How to set Resolution

- Press **Sweep 3**.
- Then **Resolution**.
- Then choose from the following:
 - **Low** 240 data points.
 - **Medium** 1000 data points.
 - **High** Calculated value - approximately 8000 data points.

Triggering

For pulse measurements, a trigger signal refers to the event that causes the USB Peak Power Sensor to initiate measurement acquisition. It does NOT refer to triggering the FieldFox.

Trigger settings can be used with ALL pulse measurements unless stated otherwise.

A **Waiting for Trigger** message on the FieldFox screen is posted on behalf of the USB Power Sensor when it is waiting for a pulse signal at the RF Input (Internal) or a TTL signal at the USB Sensor External Trigger input.

How to make Trigger settings

- Press **Sweep 3**.
- Then **Trigger**.

- Then **Trig Type**.
- Then choose from the following:
 - **Freerun** The USB Power Sensor acquires data without waiting for a trigger. This mode is NOT supported for Trace Graph measurements.
 - **Internal** The USB Power Sensor acquires data when a valid pulse signal is detected at the RF input. The following Trigger settings determine the validity of the trigger signal.
 - **External** The USB Power Sensor acquires data when a valid TTL signal is detected at the USB Power Sensor external trigger input.

Trigger Edge

This setting determines which edge of a trigger signal initiates data acquisition.

- Press **Sweep 3**.
- Then **Trigger**.
- Then **Trigger Edge**.
- Then choose from the following:
 - **Pos** Acquisition is triggered by the rising (positive) edge of a valid signal.
 - **Neg** Acquisition is triggered by the falling (negative) edge of a valid signal.

Trigger Delay

After a valid trigger signal is received at the USB Power Sensor, data acquisition begins after the specified Trigger Delay time PLUS the specified Start time. See the Pulse Timing diagram in **“Trigger Settings Annotation” on page 13-10** for more information.

- Press **Sweep 3**.
- Then **Trigger**.
- Then **Trigger Delay**.
- Then enter a value using the numeric keypad, the **▲▼** arrows, or the rotary knob.

Auto Trigger

Used ONLY when Trigger Type = Internal, this setting determines whether the trigger level is set manually or is set to the default level in the USB Power Sensor firmware.

- Press **Sweep 3**.
- Then **Trigger**.

- Then **Auto Trigger**.
- Then choose from the following:
 - **ON** Trigger level is determined by the USB Power Sensor firmware.
 - **OFF** The trigger level is set manually using the Trigger Level setting.

Trigger Level

Used when Trigger Type = Internal AND Auto Trigger = OFF (Manual).

- Press **Sweep 3**.
- Then **Trigger**.
- Then **Trig Level**.
- Then set the trigger level using the numeric keypad, the **▲▼** arrows, or the rotary knob. A line appears on **Tr 1** at the current trigger level setting. Data acquisition occurs when the RF input signal crosses the line. This setting can be used with either Positive or Negative edge triggering.

Trigger Settings Annotation

Trigger settings are annotated on the FieldFox screen as highlighted in **red** in the following image:

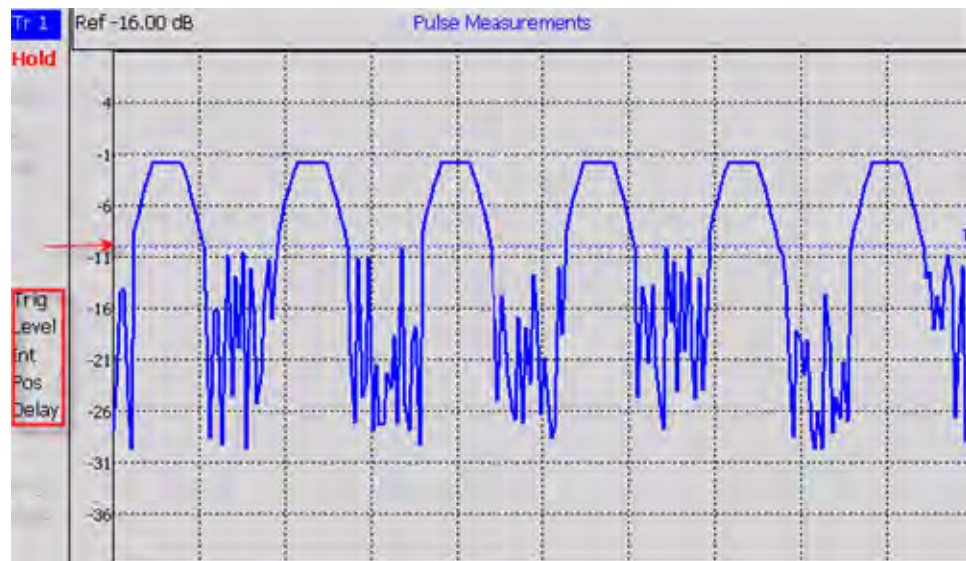

In the previous graphic, the settings are: Trig Level = -10 dBm, Trig Type (Int), Pos Slope (/), Delay

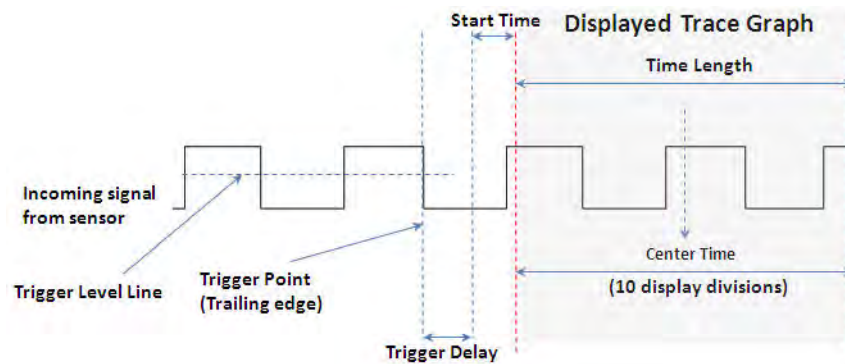

Marker Settings

Markers are not allowed with Meter-style measurements.

Markers are displayed on **Tr 1** and also on the zoom trace if the marker is within the zoom window time span.

Up to six standard markers can be used to provide readouts of the Y-axis amplitude at the current X-axis location.

The six standard markers can also be used as Delta Markers.

Learn more about standard markers in [“All about Markers” on page 16-2](#).

Amplitude Markers

Amplitude markers are horizontal dotted lines that you can move to any amplitude level on the screen. The two amplitude markers can be set independently or used as a pair of delta markers.

Amplitude markers can be used as a visual comparison aid with the pulse measurement traces.

How to make Amplitude Marker settings

- Press **Marker**.
- Then **More**.
- Then **Ampl Markers**.
- Then choose from the following:
 - **OFF** Amplitude markers are NOT displayed.
 - **ON** Amplitude markers ARE displayed at their previous positions.
- Then **Ampl Mkr 1 or 2**.
- Enter a value in dBm for the marker using the numeric keypad, the **▲▼** arrows, or the rotary knob.

- Press **Delta Ampl Mkr**.
- Then choose from the following:
 - **ON** AmplMkr 2 value is relative to AmplMkr 1. When AmplMkr 1 is moved, AmplMkr 2 also moves to maintain the AmplMkr 2 value between them.
 - **OFF** The two amplitude markers move independent of one another.

Marker Search

Use Marker Search to find and move markers to locations on the **Tr 1** trace.

How to Search with Markers

- Activate the marker to be used for the search
- Then press **Mrk ->/Tools**.
- Then **Marker Search**.
- Then **Zone Search**.
- Then choose from the following:
 - **ON** Available ONLY when the zoom window is enabled, the search is limited to the zone defined by the zoom window.
 - **OFF** The search is performed over the entire **Tr 1** trace.

Then choose from the following:

- **Target**, **Peak**, and **Minimum**. Learn more about these standard features beginning in **“Searching with Markers” on page 16-7**.
- **Rise Time** Select, then set a value in dB. Delta markers are created and placed at the Peak and at the specified value BEFORE the Peak.
- **Fall Time** Select, then set a value in dB. Delta markers are created and placed at the Peak and at the specified value AFTER the Peak.

NOTE

Rise and Fall time in Marker Search uses different criteria than in Auto Analysis and will therefore result in different reported values.

Auto Analysis

Auto Analysis reports the following TEN pulse measurements:



1 - Average Power	Average power level of all measured data points
2 - Peak Power	Highest reading of all measured data points
3 - Peak minus Average	Difference between the above two results
4 - Pulse Top	Power value based on the specified Pulse Top setting.
5 - Rise Time	The time it takes for a pulse to rise from 10% to 90% of its peak value.
6 - Fall Time	The time it takes for a pulse to fall from 90% to 10% of its peak value.
7 - Pulse Width	The time between the rising edge and falling edge of a pulse.
8 - Pulse Period	The time of complete pulse cycle.
9 - Duty Cycle	The ratio of the pulse width / pulse period.
10 - Pulse Rep Freq	The rate, in pulses / sec, at which pulses recur.

How to enable Auto Analysis

- Press **Mrk ->/Tools**.
- Then **Auto Analysis**.
- Then choose from the following:
 - **OFF** Analysis OFF
 - **ON** The Analysis values appear below trace 1.

Pulse Top

Pulse Top is NOT the same as the pulse Peak. Pulse Top is used to set and report the reference power level. You enter a value in percent, and the Pulse Top value is reported in the Auto Analysis table in dB down from 100% of the reference power level.

How to set Pulse Top

- Press **Mrk ->/Tools**.
- Then **Pulse Top**.
- Then enter a percent value between 0 and 100 using the numeric keypad, the **▲▼** arrows, or the rotary knob.
 - When set to 10%, 10 dB down from the 100% reference level is reported.
 - When set to 50%, 3 dB down from the 100% reference level is reported.
 - When set to 90%, 0.5 dB down from the 100% reference level is reported.

Grid

Enables and disables the display of a 10 x 10 grid on the FieldFox screen.

How to enable Grid display

- Press **Mrk ->/Tools**.
- Then **Grid**.
 - **OFF** Grid OFF.
 - **ON** A grid of X/Y lines appears on the screen.

Trace Memory

A memory trace is a pulse measurement **Tr 1** data trace (NOT the trace in the Zoom window) that has been stored in the FieldFox volatile memory. It then becomes static, meaning it is not updated with normal pulse measurements. It can be displayed on the screen by itself, or with a pulse trace for comparison purposes.

The **Tr 1** data trace is displayed in **yellow**.

The memory trace is displayed in **blue**.

How to display data and memory traces

- Press **Trace 6**.

Pulse Measurements Mode – Option 330
Pulse Measurement Settings

- Then **Trace Memory**.
- Then **Data->Mem** to store the current live trace into memory. A ‘beep’ sounds to confirm the data trace has been saved to memory. There is no display annotation that indicates that the memory trace has been stored.
 - Press **Data** to view only the data trace.
 - Press **Memory** to view only the memory trace.
 - Press **Data & Memory** to view both the live trace and the stored memory trace.

Pulse Measurements Mode – Option 330
Pulse Measurement Settings

14 VVM (Vector Voltmeter) Mode - Option 308

VVM Mode measures the electrical length of cables and other devices. The 1-Port Cable Trimming application displays the electrical length in both Magnitude and Phase. The 2-Port Transmission measurement displays Magnitude ONLY.

Figure 14-1 Display for the 1-Port Cable Trimming measurement

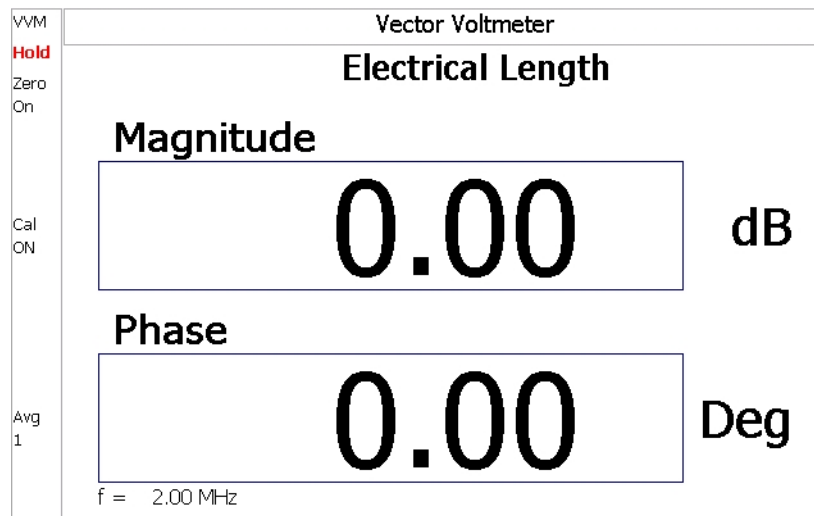

In this Chapter

- [“Overview” on page 14-3](#)
- [“VVM Mode Settings” on page 14-4](#)
- [“Measurement Selection” on page 14-4](#)
- [“Frequency Selection” on page 14-4](#)
- [“Display Resolution” on page 14-5](#)
- [“IF Bandwidth” on page 14-5](#)
- [“Output Power” on page 14-5](#)
- [“Averaging” on page 14-7](#)

“Single or Continuous Measure” on page 14-7

“Zeroing” on page 14-8

Procedures

“1-Port Cable Trimming Measurements ” on page 14-9

“2-Port Transmission Measurements” on page 14-11

Overview

In the FieldFox, both 1-port and 2-port measurement types use a different configuration setup from the HP/Keysight 8508A Vector Voltmeter.

Figure 14-2 Typical 8508A measurement configuration –as shown in the 8508A manual.

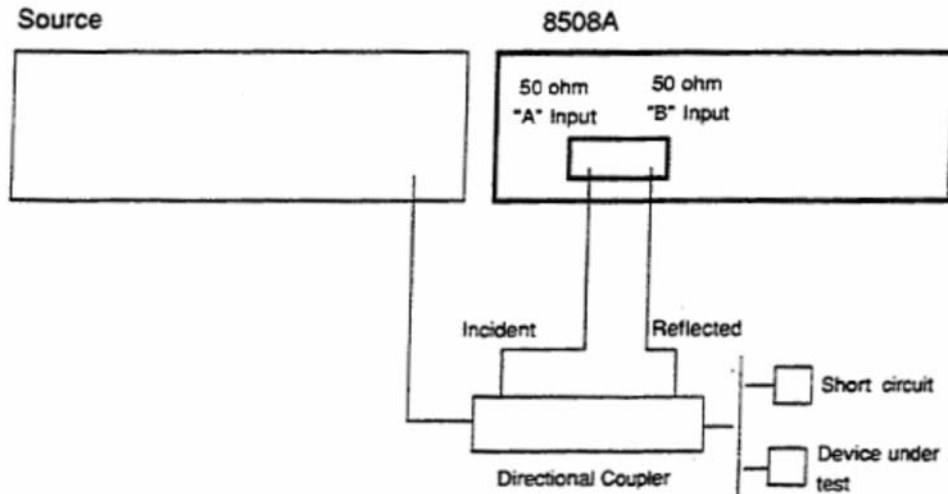

The above block diagram requires an external source and directional coupler to measure the electrical length of a DUT or cable to be trimmed. Separate paths are used to measure the Incident signal (A) and Reflected signal (B). To measure the ratio of the Reflected/Incident signals, you were required to select B/A for both the Magnitude and Phase display.

In the FieldFox, the source and directional coupler are inside the instrument. This allows you to connect the DUT to ONLY the FieldFox PORT 1, with NO external instruments, in order to make Cable Trimming measurements.

See the FieldFox block diagram and Cable Trimming procedures beginning in ["1-Port Cable Trimming Measurements"](#) on page 14-9.

VVM Mode Settings

Select VVM Mode before making any setting in this section.

How to select VVM Mode

- Press **Mode**.
- Then **VVM**.

Measurement Selection

How to select a VVM Measurement

- Press **Measure 1**.
- Then choose from the following:
 - **1-Port Cable Trimming** 1-port reflection measurement. Learn how to make this measurement in “**1-Port Cable Trimming Measurements**” on page 14-9.
 - **2-Port Transmission** 2-port transmission measurement. Learn how to make this measurement in “**2-Port Transmission Measurements**” on page 14-11.

Frequency Selection

VVM measurements are made at a single CW frequency.

How to set Frequency

NOTE

Frequency can be set to 1 Hz resolution.

-
- Press **Freq/Dist**.
 - Then **Frequency**.
 - Enter a value using the numeric keypad, the **▲▼** arrows, or the rotary knob.
 - After using the **▲▼** arrows or the rotary knob, press **Enter**. The increment setting of the arrows is based on the current span and can NOT be changed in VVM Mode.
 - After using the keypad, select a multiplier key. Learn about multiplier abbreviations in “**Multiplier Abbreviations**” on page 2-14.

Display Resolution

You can display either one digit or two digits after the decimal point for both magnitude and phase readings.

This setting survives a Preset and Mode Preset.

How to set Resolution

- Press **Scale/Amptd**.
- Then **Resolution**.
- Then choose:
 - **1** 0.0 (default)
 - **2** 0.00

IF Bandwidth

Reducing the IF receiver bandwidth reduces the effect of random noise on a measurement. However, narrower IF bandwidths cause longer measurement times.

For highest accuracy, Zero AFTER changing the IF Bandwidth. Learn about **“Zeroing” on page 14-8**.

How to set IF BW

- Press **BW 2**.
- Then **IF BW**.
- Then choose from the following:
 - **300 Hz | 1 kHz | 3 kHz | 10 kHz | 30 kHz**

Output Power

Set the power level out of the FieldFox to High, Low, or manually set power level to a value between High and Low.

Generally, the high power setting is used when measuring passive, high-loss devices to place the signal farther from the noise floor. However, for devices that are sensitive to high power levels such as amplifiers, use the Low power setting.

For best measurement accuracy, use the Manual power setting at -15 dBm. After calibration, the power level can be decreased for amplifiers, or increased for higher dynamic range.

CAUTION

Power Level settings in this mode will NOT change Power Level settings in other modes. To help prevent damage to your DUT, use caution when changing modes with your DUT connected to the FieldFox test ports.

How to set Output Power

- Press **Meas Setup 4**.
- Then **More**.
- Then **Output Power**.
 - **High** (Default setting) Sets output power to the maximum achievable power at all displayed frequency.
 - **Low** Sets output power to approximately -27 dBm.
 - **Man** Set output power to an arbitrary value.
- Then press **Nominal Power**.
- Then enter a value using the numeric keypad, the **▲▼** arrows, or the rotary knob.
- Press **Enter**.

NOTE

Nominal here means: a general, descriptive term or design parameter. It is not tested and not covered by the product warranty. The Nominal Output displayed on the bottom right side of the display indicates a range of low and high power values. Your actual measured output power could be a little lower or a little higher.

If you have the USB power sensor feature (Option 302) you can measure the actual output power for your measurement. Refer to “Supported Power Sensors” on page 13-3.

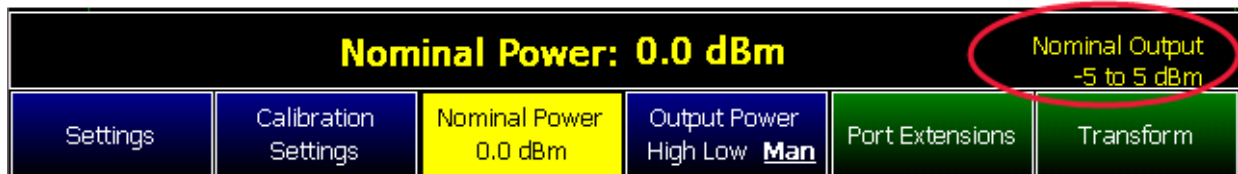

Averaging

Averaging helps to reduce the effects of random noise on a measurement. The FieldFox computes the displayed value over several consecutive readings. Average count determines the number of readings to average. The higher the average count, the greater the amount of noise reduction.

An average counter is shown in the left edge of the screen as **Avg N**. This shows the number of previous readings that have been averaged together. When the counter reaches the specified count, then a 'running average' of the last **N** readings is displayed.

Average count = 1 means there is NO averaging.

This setting can be changed at any time without affecting calibration accuracy.

How to set Averaging

- Press **Meas Setup 4**.
- Then **More**.
- Then **Average N** where **N** is the current count setting.
- Enter a value using the numeric keypad. Enter **1** for NO averaging.
- Press **Enter**.

While Averaging is in process, press **Meas Setup 4**, then **More**, then **Restart** To restart the averaging.

Single or Continuous Measure

This setting determines whether the FieldFox measures continuously or only once each time the **Single** button is pressed. Use **Single** to conserve battery power or to allow you to save or analyze a specific measurement.

This setting can be changed at any time without affecting calibration accuracy.

How to set Single or Continuous

- Press **Sweep 3**.
- Then choose one of the following:
 - **Single** Automatically sets Continuous OFF and causes the FieldFox to make ONE measurement, then hold for the next **Single** key press. When a data trace is displayed, the entire trace is measured, then holds. The **Hold** annotation changes to an arrow --> while the measurement occurs.
 - **Continuous** Makes continuous measurements. This is the typical setting when battery power is not critical.
- You can also use **Run / Hold +/-** to toggle between Single and Continuous.

VVM Calibration

In VVM Mode, calibration is performed in the same manner as in CAT and NA Modes. In summary, a Preset Cal is sufficient when the DUT is connected directly to the FieldFox RF Out test port. When using an adapter or jumper cable to connect the DUT, first perform a QuickCal + Load or OSL Cal before making measurements. Learn more about these FieldFox calibrations from [Chapter 7, “Calibration for NA, CAT, and VVM Modes”, on page 7-1.](#)

To make an accurate measurement, set **Zero OFF** before calibrating.

Zeroing

When performing a Cable Trimming operation, one cable is compared to another. After measuring the first, shorter cable, pressing Zero performs the same operation as Data->Memory, then Data/Mem, also known as Normalization. All subsequent electrical length measurements are relative to the stored measurement.

To make an accurate measurement, set **Zero ON** before calibrating. Zero after changing the IF Bandwidth.

How to select Zeroing

- Press **Meas Setup 4**.
- Then **Zero Ref**.
 - **Open** – select to display Phase = 0.0 Deg when zeroed.
 - **Short** - select to display Phase = 180.0 Deg when zeroed.
- Then **Zero ON**.
- Select **Zero OFF** to turn zeroing off.

1-Port Cable Trimming Measurements

A 1-Port Cable Trimming measurement is used in a cable fabrication procedure to validate proper electrical length.

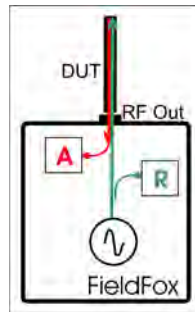

- The R receiver measures incident signal (green line) out of the source.
- The A receiver measures reflected signal (red line) from the end of the DUT (black line).
- In VVM mode, the display ALWAYS shows ratioed (A/R) measurements which is the electrical length of the DUT.

How to make a 1-Port Cable Trimming Measurement

1. Press **Mode** then **VVM** then **1-Port Cable Trimming**.
2. Press **Freq/Dist** then enter the frequency for the VVM measurement.
3. Press **Meas Setup 4** then **Zero OFF**.
4. If using an adapter or jumper cable to connect the cables to the FieldFox, press **Cal 5** then select **Calibration Type**, then either **QuickCal** (+ Load) or **OSL Cal**. Follow the FieldFox calibration prompts. Learn more about VVM calibration on [page 14-8](#).

Verification: Perform the following optional steps to ensure that the FieldFox is properly calibrated. Steps 1 through 9 need only be done once to determine the difference in phase between the Open and Short standard. Once that value is known, perform steps 10 through 14 to verify a calibration.

1. Press **Mode** then **NA**. Select **S11**.
2. Press **Freq/Dist** and enter start and stop frequencies that span about 40% of the VVM measurement frequency. For example, for a 1 GHz measurement, enter Start .8 GHz and Stop 1.2 GHz.
3. Perform a calibration using a cal kit (NOT Quick Cal).
4. Press **Meas 1** then **Format Phase**.
5. Connect the Short standard to the RF OUT calibration plane.8
6. Press **Trace 6** then **Math and Memory**. Then **Data-> Mem**.
7. Connect the Open standard to the RF OUT calibration plane.
8. Press **Data Math** then **Data/Mem**.

9. Press **Marker** then scroll the marker to the VVM frequency. The Y-axis value is the phase difference in degrees between the Open standard and the Short standard at that frequency. **Remember this value!**
10. Press **Mode** then **VVM**.
11. Connect the Short standard to the RF OUT calibration plane.
12. Press **Meas Setup 4** then press **Zero**.
13. Connect the Open standard to the RF OUT calibration plane.
14. Confirm that magnitude measurement is less than -0.1 dB and the phase is within 1 degrees of the value from step 9.

Perform Cable Trimming:

1. Attach the shortest cable to the FieldFox RF OUT connector. This cable is the reference cable. Leave the end of the reference cable open (unterminated).
2. Press **Meas Setup 4** then press **Zero**.
3. Remove the reference cable from the FieldFox RF OUT connector.
4. Connect an unterminated, longer cable to the FieldFox RF OUT connector.
5. Observe the displayed phase difference between the reference cable and the attached cable.
6. Carefully trim the cable until the phase shift reads zero. **The attached cable's electrical length is now matched to the reference cable.**
7. Repeat steps 4 through 6 for the remaining cables to be trimmed.

2-Port Transmission Measurements

A 2-Port Transmission measurement is used for measuring electrical length, insertion loss, gain, or isolation of a device. The FieldFox signal source is transmitted out the RF OUT connector, through the DUT, and into the RF IN connector. Both ends of the DUT must be connected to the FieldFox.

NOTE

Only Magnitude, NOT Phase, is displayed.

Figure 14-3

2-Port Transmission measurement of an amplifier

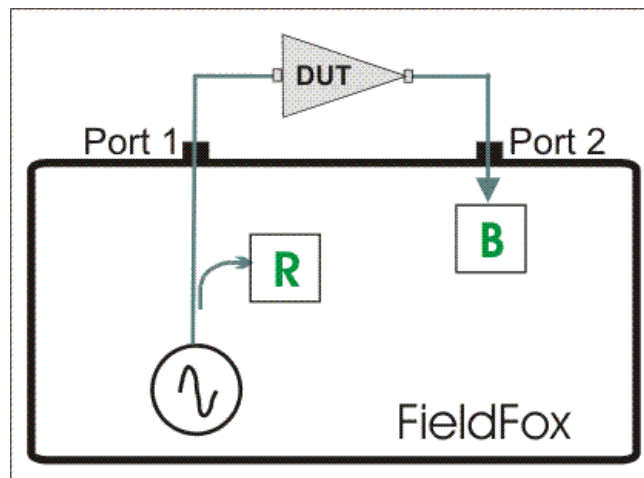

How to make a 2-Port Transmission Measurement

1. Press **Mode** then **VVM** then **2-Port Transmission**.
2. Press **Freq/Dist** and enter the measurement frequency.
3. Connect the RF Out and RF In test port cables to form a Thru connection. If an adapter is needed to make the connection, the measurement results will be in error by the amount of loss in that adapter
4. Press **Meas Setup 4** then **Zero**.
5. Connect the DUT as in the diagram above.
6. The displayed magnitude value is the gain of the amplifier. To measure isolation of the amplifier, reverse the connection to the amplifier (RF Out to the amplifier output).

VVM (Vector Voltmeter) Mode - Option 308
2-Port Transmission Measurements

15 Channel Scanner (SA Only and Option 312)

In this Chapter:

[“Using Channel Scanner” on page 15-1](#)

[“How to Set Up Channel Scanner” on page 15-2](#)

Using Channel Scanner

Channel Scanner enables you to do the following:

Measure and display channel power vs. frequency for up to 20 channels simultaneously.

Six Display Types:

- Bar graph vertical display orientation
- Bar graph horizontal display orientation
- Channel Power
- Strip Chart
- Strip Chart and Overlay
- Scan & Listen

Color Coded Display Types:

- Specify high and low power with color bars

Flexible Data Sorting:

- Sort results displayed by power or frequency, low to high, or high to low

Data Logging. Record GPS stamped data measurements

- Define measurement interval by time or distance
- Show results in spectrogram
- Replay files on Google Maps or Google Earth

Figure 15-1 Display Example: Measure 5 Channels Spaced 2 MHz Apart

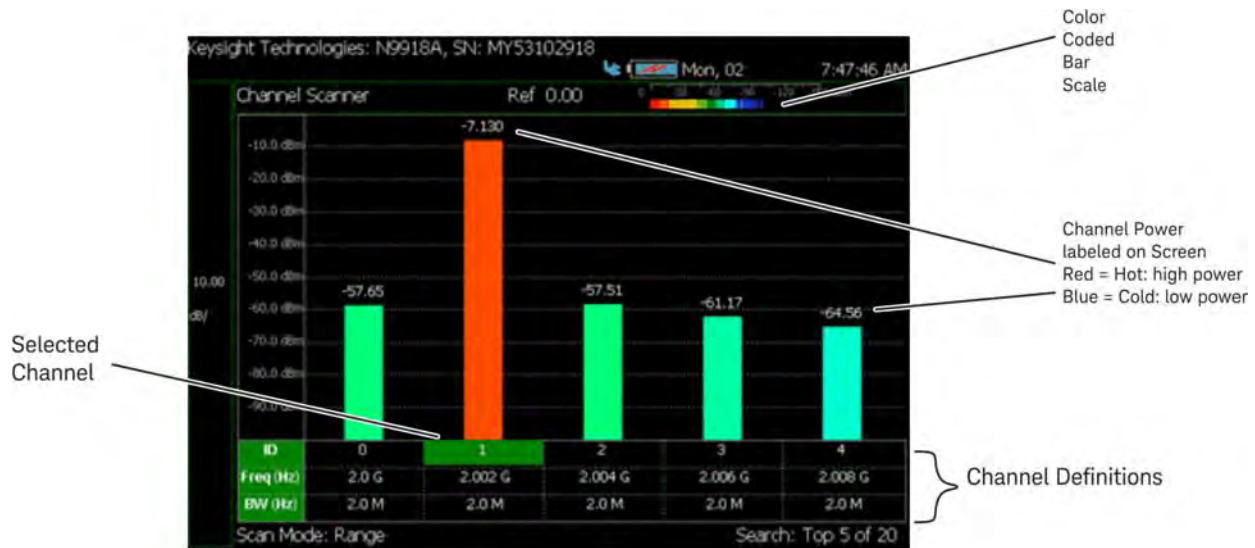

How to Set Up Channel Scanner

This section briefly reviews the steps in setting up a channel scan measurement. If you are not familiar with this process or would like more information, refer to [“How to Define a Channel and Use Channel Scanner”](#).

1. Define some channels (refer to [“How to Define a Channel and Use Channel Scanner”](#)).
 - a. Select a **Scan Mode**—choose:
 - **Range** Specify total channels, channel spacing or
 - **Custom List** Specify a list of channels from an editor
 - b. Then modify channels based on the selected scan mode
2. Select **Display Type**—choose:
 - **Bar ChartV** or
 - **Bar ChartH** or
 - **Channel Pow** or
 - **Strip Chart** or
 - **Chart Overlay** or
 - **Scan&Listen**
3. Modify scale and specify color bar coding—Modify the scale and assign colors to low and high power channels (bars):

Press **Scale/Amptd**

Then one of the following:

- **Red Limit** to set the power level and color scale for high power channels.
- **Blue Limit** to set the power level and color scale for low power channels.
- Others: **Scale**, **Ref Level**, **RF Atten**, etcetera as desired.

4. Press **Data Logging** and set the **Record Settings**.

- **Record** or
- **Play** or
- **View**
- To set the **Record Settings**—choose:
 - **Meas Interval**
 - **Interval Time**
 - **Time Interval**
 - **Distance Interval** and or
 - **Auto Save** (default is On)

5. Then **User Folder Def System**

- **Def** – Sets the default User Folder path:
 - List files (*.csv and *.kml) are save-recalled to:
"CurrentDevice\ChannelScanner\ChannelScanner\RecordPlayback\"
 - Record-Play files are save-recalled to:
"CurrentDevice\ChannelScanner\ChannelScanner\RecordPlayback\"

Or

- **System** – Sets the User Folder to the user defined system folder path/name:
 - List files are save to-from
"CurrentDevice\<UserSelectedFolder>\"
 - Record-Play files are save-recalled to:
"CurrentDevice\<UserSelectedFolder>\"

6. Then Save to *.KML or *.CSV file, **Save-Recall Rec-Playback**:

- Then **User Folder Def System**
 - **Def** – Sets the default User Folder path:

--List files (*.csv and *.kml) are save-recalled to:
"CurrentDevice\ChannelScanner\Channels
canner\RecordPlayback\"

--Record-Play files are save-recalled to:
"CurrentDevice\ChannelScanner\Channels
canner\RecordPlayback\"

Or

- **System** – Sets the User Folder to the user defined system folder path/name:

--List files are save to-from
"CurrentDevice\<UserSelectedFolder>\"

--Record-Play files are save-recalled to:
"CurrentDevice\<UserSelectedFolder>\"

Refer to **Chapter 17, "File Management."**

- Then **File Type**
 - KML (default) or
 - CSV
- Then **Save Log File.**

7. (Optional) Export KML file into 3rd party mapping software (i.e., Google or Google Earth)

How to Define a Channel and Use Channel Scanner

Channel definitions consist of the following:

- Each channel is defined by CF and Integration BW.
- Frequency span is set automatically to 1.5 x Integration BW
- Power is measured over the Integration BW

Using Channel Scanner, refer to:

- **"Step 1A: Scan Mode: Range Channel Defined"** on page 15-5 or
- **"Step 1B: Scan Mode: Custom List Channel Defined"** on page 15-6

Then:

- **"Step 2: Select Display Type"** on page 15-7
- **"Step 3. Modify Scale and the Display Color Bar Settings"** on page 15-11
- **"Step 4: Enable Data Logging and Record Results"** on page 15-12
- **"Save 5: Save the Log Results:"** on page 15-14

- “Step 6: Import and Play back KML Files into 3rd Party Software (Example: Google Earth with Animation Tool)” on page 15-14

Figure 15-2 Channel Definition

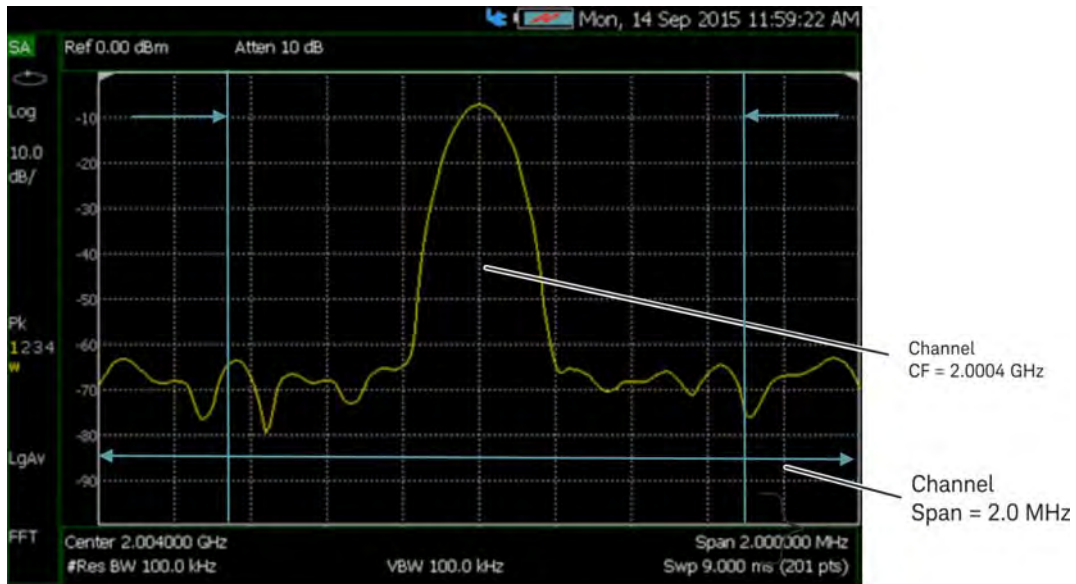

Step 1A: Scan Mode: Range Channel Defined

1. Define some channels: Press **Measure** > **Scan Mode** > **Range**
2. Press **Edit Range** and modify table items:
 - Total Channels
 - Search Count
 - Start Channel CF
 - CF Step Size

Figure 15-3 Range Table Settings

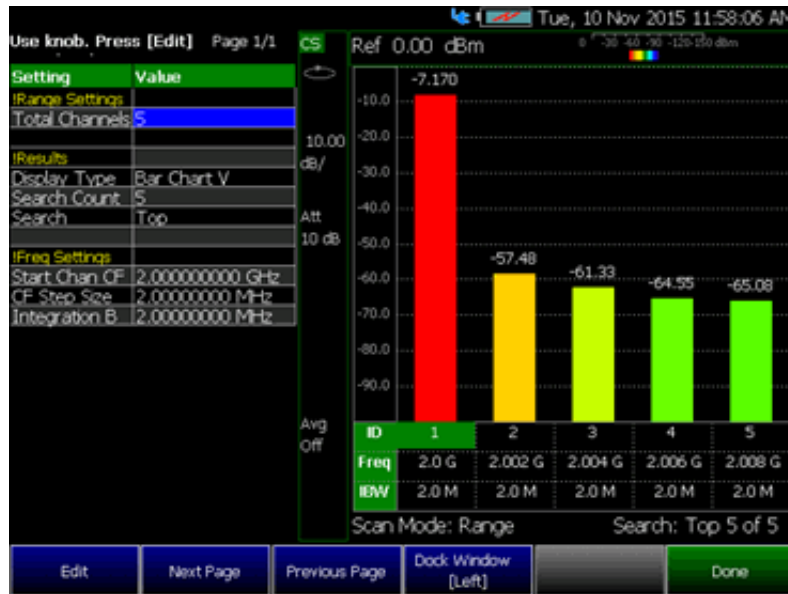

3. Press **Done**

Step 1B: Scan Mode: Custom List Channel Defined

1. Define some channels: Press **Measure** > **Scan Mode** > **Custom List**
2. Press **Edit Custom List** and modify table items:
 - Add table rows
 - Then for each row:
 - Edit Center Frequency (CF)
 - Edit Integration BW (IBW)

Figure 15-4 Custom List Table Settings

Use knob. Press [Edit] to make changes. Press [Done] to exit. Page 1/1

ID	CF	BW
Chan	Center	Integration BW
1	93.700000 MHz	100.000 kHz
1	100.100000 MHz	100.000 kHz
2	97.300000 MHz	100.000 kHz
3	99.700000 MHz	100.000 kHz
4	96.500000 MHz	100.000 kHz

Edit Next Page Previous Page Add Row Delete/Clear Done

3. Press **Done**
4. Press **Save Recall List** > **Save List** to save a custom list. See also “How to use the FieldFox labeler” on page 17-3.

NOTE

Press **Recall List** to bring back a previously stored custom list

Step 2: Select Display Type

Select one of the following display orientations:

- Select **Display Type**—choose:
 - **Bar ChartV** or
 - **Bar ChartH** or
 - **Channel Pow** or
 - **Strip Chart** or
 - **Chart Overlay** or
 - **Scan&Listen**

Figure 15-5 Bar Chart Vertical Display Type



Figure 15-6 Bar Chart Horizontal Display Type



Figure 15-7 Channel Power Display Type

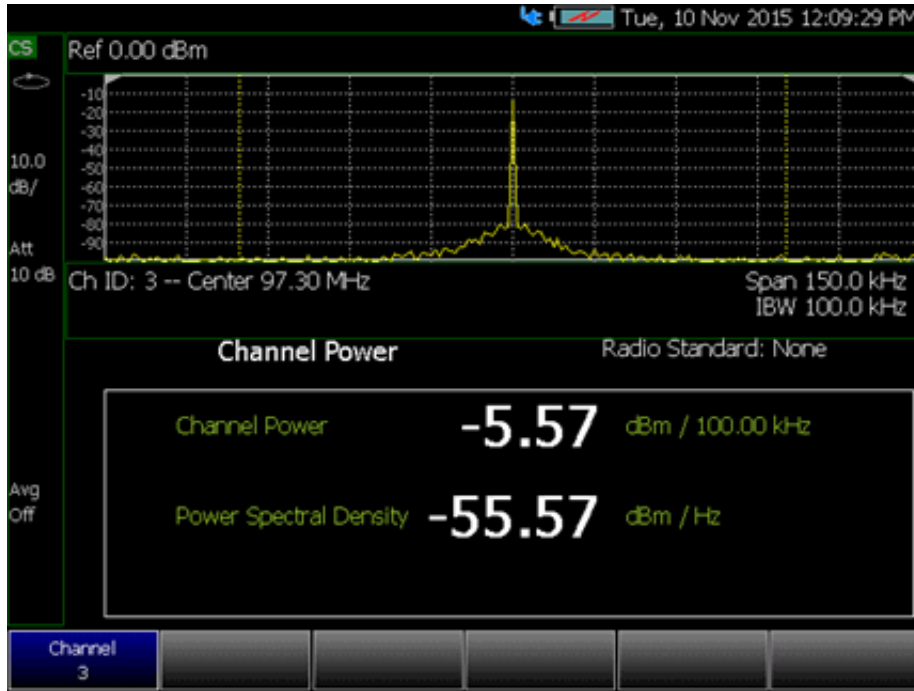

Figure 15-8 Strip Chart Display Type

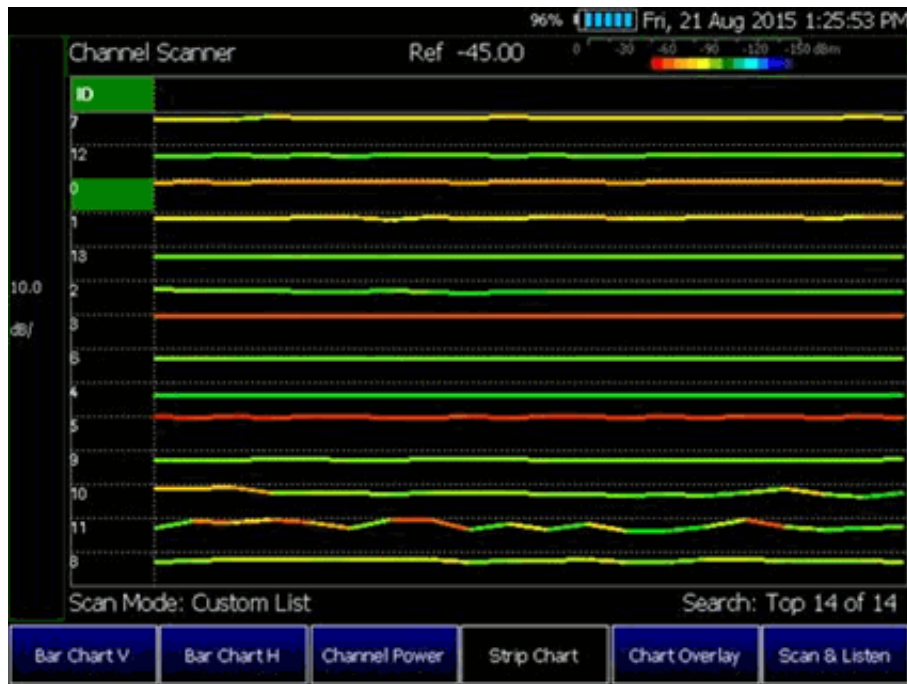
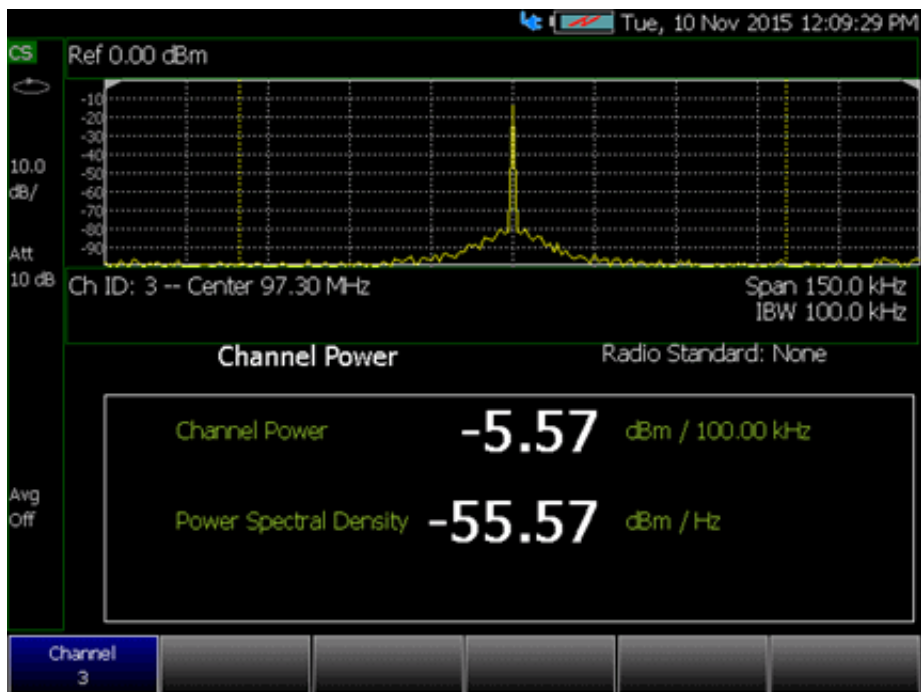

Figure 15-9 Strip Chart Overlay Display Type



Figure 15-10 Scan & Listen Display Type



Step 3. Modify Scale and the Display Color Bar Settings

To assign colors to low and high power values:

1. Press **Scale/Amptd** > **Red Limit** to set high power values and to set the color.
2. Press **Blue Limit** to set low power values and to set the color.
3. And, then press **System** > **Display** > **Display Colors**, to set Indoor, Outdoor, or other display colors. See also [Chapter 18, "System Settings."](#)

Figure 15-11 Outdoor Display Colors

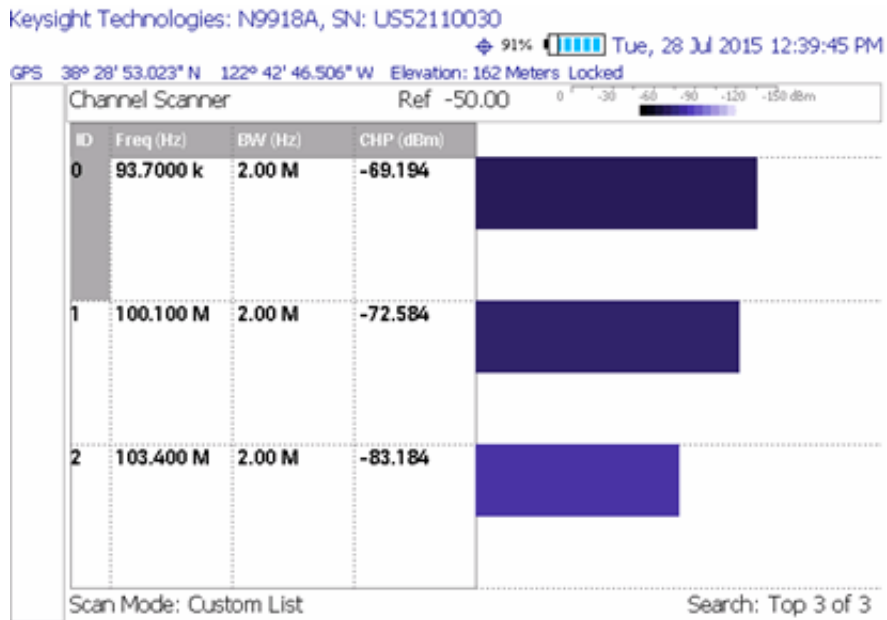
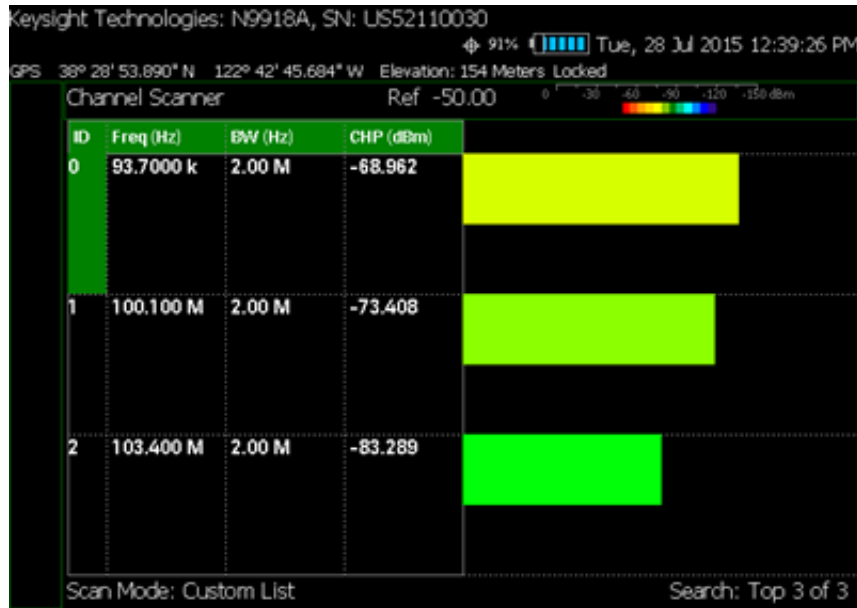

Figure 15-12 Indoor Display Colors



Step 4: Enable Data Logging and Record Results

Data logging records your data with a timestamp and GPS stamp (refer to [“GPS” on page 18-12](#)). GPS must be enabled for the log results to include a GPS stamp.

Features

- Log files contain measured channel results including timestamps and/or distance stamps.
 - Timestamps are included in log files with or without GPS.
 - GPS must be enabled for log results to include distance stamps.
- Data results can be logged
- Data results can be saved to a *.CSV or *.KML file. Refer to [“Save 5: Save the Log Results:” on page 15-14](#).
- User specifies how often results are stored.
 - Time: Store results every “n” seconds
 - Distance: Store results every “n” meters. GPS must be enabled to store results by distance.

Procedure

1. Press **Measure** > **Data Logging** > **Record Settings** > **Meas Interval ON** (default)
2. Press **Interval Type** > **Time** or **Distance** then:

- **Time Interval** 1 sec to 3,000 seconds or
 - **Distance Interval** from 1m to 10 km
 - When done, press **Back**
3. Press **Save Recall Rec-Playback** > **File Type** CSV or KLM
 4. To begin recording: Press **Record**
If Auto Save is On (default) Measurements are stored automatically accorded to the specified time or distance interval values. Refer to step 5.
 5. Optional: **Auto Save** ON (default)–When Auto Save is on, during recording, the FieldFox stores intermediate results in a temporary file. If the power fails during recording you can retrieve the results. Select **Recall Log File**. Select the temporary file name.
Press **Record Settings** > **Auto Save On Off**
 6. When done press **Stop** or **Esc**. The files save dialog is displayed. Edit the file name where the file results will be stored.
 7. Press **Done**
 8. Press **Back**

Playing a Recorded Log and Viewing the Spectrogram

To play the log results:

1. Press **Data Logging** > **Play**
2. Then choose:
 - Optional: Use the RPG (fine adjust) or the arrow keys (coarse adjust) to change the color bar.
 - **Position** to change the position along the time record's results. Recording must be Paused to use Position.
 - **Red Limit** to change the color bar.
 - **Blue Limit** to change the color bar.
3. Press **Stop** or **Esc** to exit the log recording.

To pause the log play:

1. Optional: Press **Pause Resume** to pause or resume the log recording.
2. Then choose:
 - Optional: Use the RPG (fine adjust) or the arrow keys (coarse adjust) to change the color bar.
 - **Position** to change the position along the time record's results.
 - **Red Limit** to change the color bar.

- **Blue Limit** to change the color bar.
3. Press **Stop** or **Esc** to stop the log recording.

To View the spectrogram of recorded results:

1. Press **View**
2. Then choose:
 - **Zoom** to zoom in on spectrogram time record results.
 - **Red Limit** to change the color bar.
 - **Blue Limit** to change the color bar.
3. Press **Exit** or **Esc** to exit view.

Save 5: Save the Log Results:

Two file types are supported for save or recall log results:

- KML file format
 - Files include bar color
 - Files stored in this format can be imported into 3rd party applications like Google Earth or Google Maps.
- CSV file format. Files stored into this format can be imported into spreadsheet applications.

1. Press **Save Recall Rec-Playback** > **File Type** CSV or KLM > **Back**

2. To begin recording: Press **Record**

Measurements are stored automatically according to the specified time or distance interval values.

3. When done press **Stop**. The files save dialog is displayed. Edit the file name where the file results will be stored.

4. Press **Done**

5. Optional: **Auto Save** ON (default)—When Auto Save is on, during recording, the FieldFox stores intermediate results in a temporary file. If the power fails during recording you can retrieve the results. Select **Recall Log File**. Select the temporary file name.

Press **Record Settings** > **Auto Save On Off**

Step 6: Import and Play back KML Files into 3rd Party Software (Example: Google Earth with Animation Tool)

Features

Use the Playback Slider to replay measurement results. See also Google Maps and or Google Earth's help.

Channel Scanner (SA Only and Option 312) How to Set Up Channel Scanner

- Open the FieldFox *.KML file in Google Earth. Time Slider appears in upper left of the map.
- Manual Mode – Move the time slider cursor to see color-coded icons pop-up according to the timestamp.
- Loop mode has a Fast-Slow Replay Option.
- Click on each color coded balloon to see the table of measurement results for that location.

Figure 15-13 Importing a KML File Into Google Earth

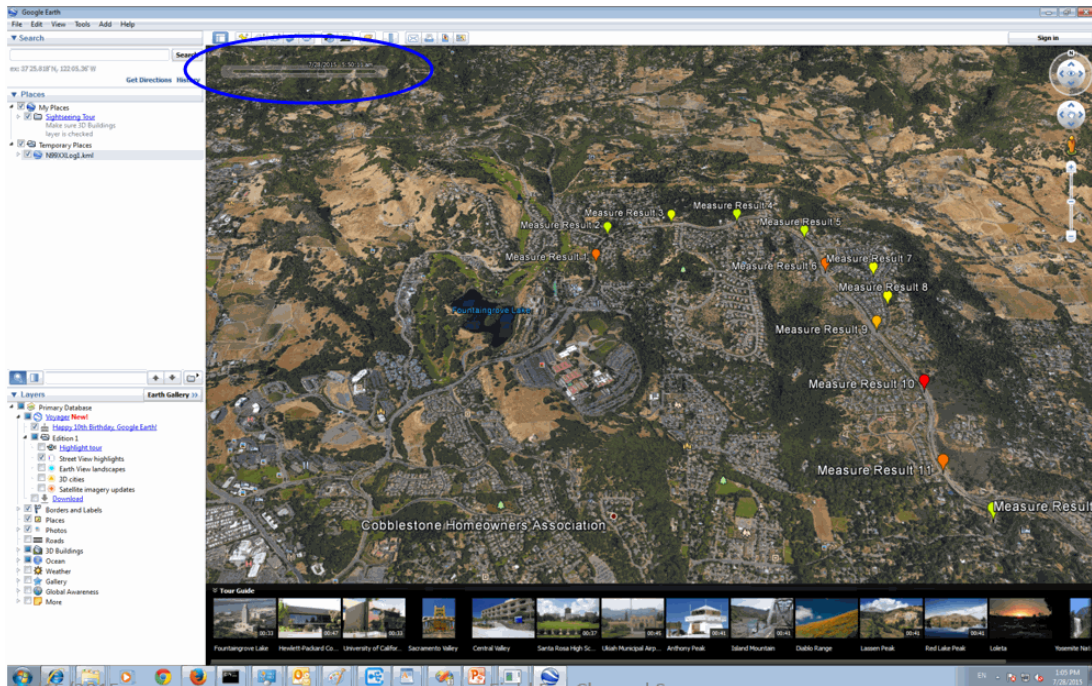

Channel Scanner (SA Only and Option 312)
How to Set Up Channel Scanner

16 Data Analysis Features

The following features can be used after a measurement to analyze the results.

In this Chapter

- “All about Markers” on page 16-2
- “About Delta Markers” on page 16-3
- “Marker Table” on page 16-4
- “Coupled Markers (NA Mode)” on page 16-5
- “Marker Colors” on page 16-6
- “Marker Trace (CAT and NA Modes)” on page 16-6
- “Marker Trace (SA Mode)” on page 16-6
- “Marker Format” on page 16-7
- “Searching with Markers” on page 16-7
- “What Is a ‘Peak’” on page 16-10
- “Marker Functions” on page 16-12
- “SA Marker Functions” on page 16-13
- “All about Limit Lines” on page 16-14
- “Relative Limit Lines” on page 16-15
- “Build From Trace” on page 16-16
- “Limit Options” on page 16-17
- “How to Save and Recall Limits” on page 16-17
- “All about Trace Math” on page 16-19
- “About Math Operations” on page 16-20

All about Markers

Markers move along the X-axis range of the measurement trace to provide a numerical readout of each measured data point. Markers also allow you to search for specific Y-axis values.

A trace can contain up to six markers.

The marker readout on the FieldFox screen displays X and Y-axis information for the current active marker ONLY.

A Marker Table can be displayed that allows you to simultaneously view X and Y-axis information for all markers.

Markers can be used in **CAT**, **NA**, **SA**, and **Pulse Measurements** Modes.

How to create Markers

- Press **Marker**.
- Then **Markers 1..6** to select a marker to activate.
- Then **Normal** to activate that marker. A marker is created on the trace in the middle of the X-axis. That marker is now **active**.
- Then move the marker using the rotary knob, the **▲▼** arrows, or by entering an X-axis position with the number keys.
- Then press **Enter**.

How to move a Marker after it is created

- Press **Marker**.
- Then **Markers 1..6** repeatedly until the marker of interest is selected. The OFF, Normal, or Delta softkey is black to indicate the current setting of each marker.
- Then move the marker as when it was first created.
- Markers can also be moved using one of the marker search functions. Learn more in **“Searching with Markers” on page 16-7**.

Figure 16-1 Marker 2 is Active, marker 1 is NOT active.

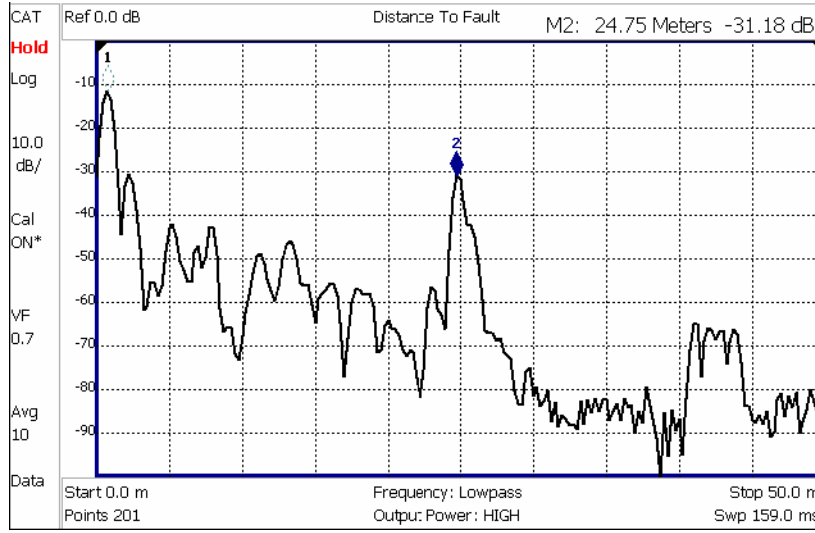

About Delta Markers

A Delta marker provides X-and Y-axis readout information that is **relative** to a 'reference' marker.

A Delta marker is created with a Δ (delta symbol) to distinguish it from the reference marker.

All six markers can be a Delta marker pair.

Peak search functions can be performed using delta markers.

Figure 16-2 A Delta marker and its associated reference marker.

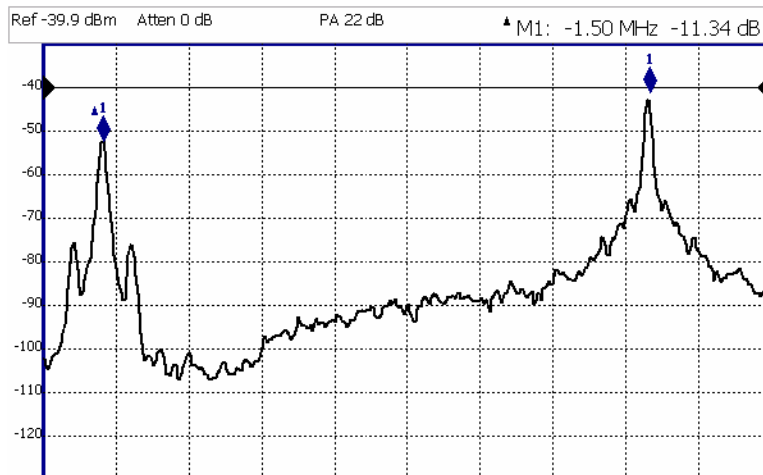

In the graphic above, the marker readout shows the difference between the two markers in frequency and amplitude.

How to Create a Delta Marker

- Create a **Normal** marker and move it to the reference position.
- Press **Delta**. The marker becomes the reference marker and fixed in its X-Axis position.
- Move the **Delta** marker using the numeric keypad, the **▲▼** arrows, or the rotary knob.
- Press **Enter** when finished.

How to move the Reference marker

- Press **Delta** to turn the Delta marker OFF.
- Move the marker to the new position.
- Then press **Delta** again, to turn the Delta marker back ON.

Fix the position of the Reference marker (SA Mode ONLY)

In SA mode, the reference marker can be fixed at the Y-axis position of the data trace when the marker was created, or it can 'float' with each sweep at the Y-axis position of the data trace. In CAT and NA mode, the reference marker always floats with the data trace. This setting applies to all SA markers.

- Create a Delta marker.
- From the **Mrk ->/Tools** menu, press **More**, then **Marker Properties**, then **Delta Ref Fixed**.
 - **OFF** – The reference marker floats at the data trace Y-axis position.
 - **ON** – The reference marker is fixed at the Y-axis position of the data trace when the marker was created (default SA mode).

Marker Table

The Marker Table can be displayed at the bottom of the FieldFox screen. It can display information for up to 6 markers in a full-width window, and up to 3 markers for a half-width window (NA mode). The marker table "squeezes" the graticule area when activated.

How to display the Marker table

- Press **Marker**.
- Then **Marker Table On Off**.

Coupled Markers (NA Mode)

Coupled Markers, available in NA mode only, allows you to simultaneously create and move markers that have the same number for all traces. For example, when marker 2 is created on a trace, a marker 2 is created for ALL traces. When any marker 2 is moved, they all move together to the same X-axis position.

- Coupled markers are allowed only in NA mode and are relevant only in multi-trace configurations.
- All markers are either coupled or uncoupled. There can NOT be one marker coupled and another uncoupled.
- Peak functions move the marker to the peak on the active trace, while all other markers move to the same X-axis position.

Figure 16-3 Coupled Markers move on ALL traces at the same time.



How to create Uncoupled Markers

NOTE

Markers are coupled by default.

To create markers that are NOT coupled (move independently on each trace):

- Press **Marker**.
- Then **More**.
- Then **Coupled Markers OFF**.

Marker Colors

As shown in the above image, in NA and CAT Modes, markers are the same color as the trace to which they are assigned. In SA Mode, the marker color is NOT the same as the trace.

Marker colors can NOT be changed.

Marker Trace (CAT and NA Modes)

The Marker Trace setting is used to move markers between the data trace and memory trace.

When Coupled Markers is ON, this setting applies to the active marker for ALL traces that are coupled. Otherwise, this setting applies to the active marker on only the active trace.

How to move a marker between traces

- With at least one marker present, press **Marker** then **More**.
- Then select the marker to move using **Marker 1,2,3,4,5,6**.
- Then toggle **Marker Trace Auto Data Mem**.
 - **Auto** - Marker resides on data trace when it is visible. Marker resides on memory trace when only IT is visible (Default setting).
 - **Data** - Marker resides on data trace, even when not visible.
 - **Mem** - Marker resides on memory trace, even when not visible.

Marker Trace (SA Mode)

Marker Trace determines the trace number on which a marker resides. A marker is created on, or can later be changed to, the trace number specified by the Marker Trace selection. When changed, a marker moves to the same X-axis location on the specified trace. Learn more about SA Traces in **“Trace Display States” on page 8-28**.

How to move a marker between traces

- With two or more traces present, press **Marker** and **Enter** to create a marker. The marker is created on the current Marker Trace selection (default setting is 1).
- Then **More**.
- Then select the marker to move using **Marker 1,2,3,4,5,6**.
- Then toggle **Marker Trace 1,2,3,4**.
 - The selected marker is moved to the specified trace.

- When a marker is moved to a 'blank' trace (not visible) the marker moves to the same X-axis position at either the Y-axis position of the last data, or to the ZERO position.

Marker Format

The Marker Format setting allows you to choose the format of the marker readout that appears in the upper-right corner of the screen and in the marker table. The marker format can be independent of the trace format, and can be set independently for each trace. All markers on a trace have the same marker format.

How to choose marker format

- Press **Marker**.
- Then **More**.
- Then **Marker Format**.
- Then choose from the following:

Selection	Example Y-axis value
Default Same as displayed format	
R + jX Complex impedance format (3rd number is distance for Time Domain)	22.8Ω -j61.4Ω 287.9fF
Z Magnitude Impedance Mag.	66.08Ω
Phase	73.8°
Real	0.2003
More	
Imaginary	-0.6727
Mag & Phase	0.705, -73.7°

There are more trace formats available than marker formats. To display marker readouts in more formats than are shown here, change the trace format, then select **Default**. Learn how to change format in **“Format” on page 5-7**.

Searching with Markers

Marker Searches are used to move markers to locations on the trace which exhibits the characteristics of the search criteria. Learn **“What Is a ‘Peak’” on page 16-10**.

How to Search with Markers

The following menu structure applies to NA Mode. Keystrokes will be slightly different for CAT, Pulse Measurements, and SA Modes.

- Activate the marker to be used for the search (NOT necessary with Bandwidth search.)
- Then press **Mrk ->/Tools**.
- Then **Marker Search**.
- Then choose one of the following:
 - **Tracking ON OFF** (NA Mode ONLY)
 - **ON** causes the active marker to search for the specified criteria with each new sweep. Search criteria can include: Target, Bandwidth, Peak, Min. The searches begin with the first sweep after Tracking is turned ON, based on the current search type. **Trk** appears next to the marker number.
 - **OFF** causes a new marker search only when the search feature is re-executed.
 - **Peak** Moves the active marker to the HIGHEST amplitude data point of the trace. Peak Excursion value is ignored. In SA Mode, the LO feed-through signal (0 Hz) is also ignored.
 - **Min** (Not available in DTF) Moves the active marker to the LOWEST amplitude data point of the trace.
 - **Target** (NA Mode and Pulse Measurements ONLY) Enter the Target value. The marker moves to the first occurrence of the Target value to the right of its current position. The FieldFox interpolates between measured data points to find the exact Target value to two decimal points. The interpolated X-axis value is displayed in the marker readout or marker table. Subsequent presses of the Target softkey cause the marker to move to the right to find the next occurrence of the Target value. When the marker reaches the end of the stimulus range, it “wraps around” and continues the search from the beginning of the stimulus range.
 - **Band width ON OFF** (NA Mode ONLY) Use to quickly toggle BW Markers ON and OFF. When OFF, the marker table appears showing the X and Y-axis positions of all enabled markers.
 - **Band width** (NA Mode ONLY) Specify the level in dB from the peak or valley where bandwidth is measured.
 - **Negative** numbers search for a **Peak** bandpass, such as a filter S21 response.

Either of the following TWO methods can be used to search for a **Valley** or Notch filter, such as the S11 response of a bandpass filter.

- **Negative** values search down from the TOP (MAX) of the response.
- **Positive** values search up from the BOTTOM (MIN) of the notch.
- If you first enter Negative, then Positive values, it may be necessary to press **Marker**, then **More**, then **Markers All Off**.

Figure 16-4 S21 of a filter with BW Markers and associated readout values. The search criteria is -3 dB.

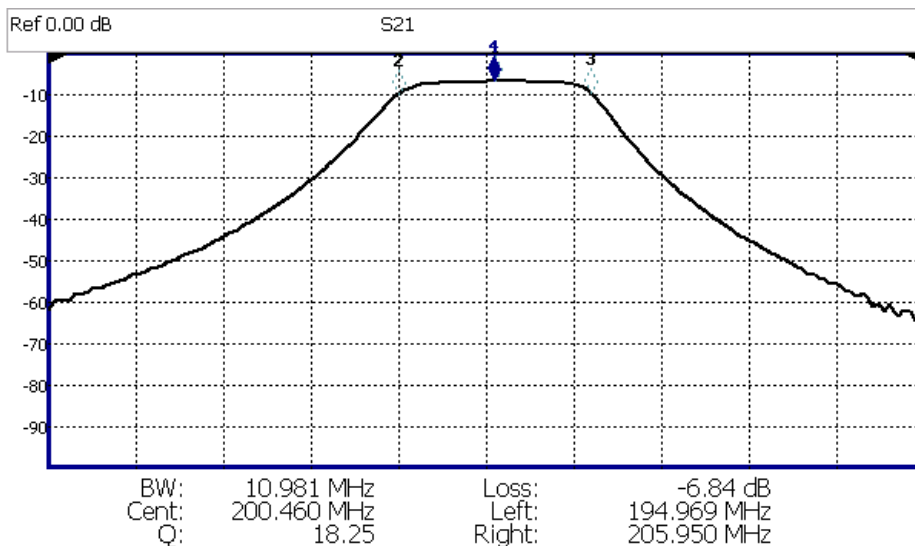
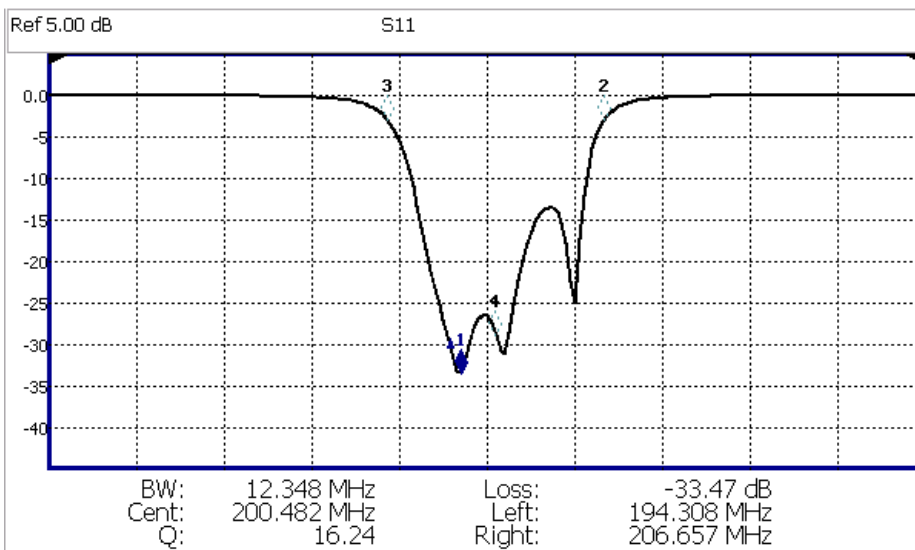

Figure 16-5 S11 of the same filter with same search criteria: -3 dB. The same values would result from a search criteria of approximately +30.4 dB.



After pressing **Enter**, four markers are automatically created to find the first negative or positive bandpass over the displayed frequency range.

Bandwidth Search can be used ONLY with Log Mag display format.

The following six values are displayed for Bandwidth Search:

- **BW**: Width of the filter. (marker 2 freq) **minus** (marker 3 freq).
- **Center**: Marker 4 frequency. Mathematical midpoint between marker 2 and marker 3.
- **Q**: Center Frequency / Bandwidth.
- **Loss**: Marker 1 amplitude.
- **Left**: Frequency of marker 2 or 3 (to left of marker 1).
- **Right**: Frequency of marker 2 or 3 (to right of marker 1).
- Press **Back** to return to the previous menu.

Press **Peak Search** then choose from the following:

- **Peak** Moves the active marker to the HIGHEST amplitude data point of the trace. Peak Excursion value is ignored. In SA Mode, the LO feed-through signal (0 Hz) is also ignored.
- **Next Peak** Moves the active marker to the next highest amplitude peak from where it currently resides.
- **Peak Left** Moves the active marker to the next data point to the left that meets the 'Peak' criteria. When no data points to the left meet the 'Peak' criteria, the marker does not move.
- **Peak Right** Moves the active marker to the next data point to the right that meets the 'Peak' criteria. When no data points to the right meet the 'Peak' criteria, the marker does not move.

The following applies to DTF Measurements ONLY:

- **More** then:
- **Track Peaks ON OFF** When Track Peaks is ON, markers will find the new peak with every sweep. While in this Mode, the markers can NOT be turned OFF or moved.
- **Find 3 Peaks** Three markers are created and find the highest peaks (faults) on the trace.

What Is a 'Peak'

You define what the FieldFox considers a "peak" by setting the Peak **Threshold** and Peak **Excursion**.

These two peak criteria settings are set individually for each trace and for each mode (CAT, SA, or NA).

These settings do NOT survive a FieldFox or Mode Preset.

NOTE

The Peak Threshold and Excursion settings are NOT available in DTF measurements. To make these settings, create a non-DTF CAT mode measurement, then change the measurement back to DTF.

How to set Peak Criteria

- Press **Mrk ->/Tools**.
- In **CAT and NA** modes:
 - Then **Peak Search**.
- In SA mode:
 - Then **More**.
 - Then **Mkr Properties**.
 - Then **Peak Criteria**.
- Then select the following:
 - **Peak Threshold** Minimum amplitude (dB). To be considered valid, the peak must be above the threshold level. The valley on either side can be below the threshold level. Default = -190 for CAT and NA Modes; -90 for SA Mode.

NOTE

CAT mode Loss measurements are displayed in positive values. In these cases, the Peak Threshold setting is inverted. For example, Peak Threshold = -20 will consider any peak that has less Loss than 20 dB to be valid.

- **Peak Excursion** The vertical distance (dB) between the peak and the valleys on both sides. To be considered a peak, data values must “fall off” from the peak on both sides by the excursion value. Default = 0.5 dB for CAT and NA Modes; 6 dB for SA Mode.

For example, the settings for the trace in the following image are:

- Threshold: -10 dB
- Excursion: 1 dB

- Scale = 1 dB / Division.

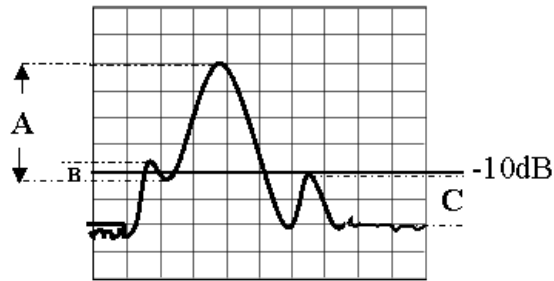

Peak A = **Valid Peak** (Above Threshold and Excursion Settings)

Peak B = **Invalid Peak** (Below 1 dB Excursion Setting)

Peak C = **Invalid Peak** (Below -10 dB Threshold Setting)

Marker Functions

Marker functions are used to change FieldFox frequency or distance settings to those of the active marker.

How to use Marker Functions

- Activate the marker to move.
- Then press **Mrk ->/Tools**.
- Then **Mkr ->**.

Then choose one of the following:

- **Mrk -> Center** (Not available in DTF or SA mode with zero span) The center frequency of the measurement becomes the value of the active marker. The frequency span is adjusted accordingly.
- **Mkr -> Delay** (NA mode ONLY.) The group delay value of the active marker becomes the electrical delay setting of the trace. Learn how to set group delay format in **“Format” on page 5-7**. Learn more about **“Electrical Delay” on page 5-10**.
- **Mkr->RefLev** (SA mode ONLY) The reference level becomes the magnitude of the active marker.
- **Mkr->TuneFreq** (SA mode with Tune & Listen ONLY) The Tune & Listen Frequency becomes the frequency of the active marker.

The following applies to DTF Measurements ONLY:

- **More** then:
- **Mkr=>Start Distance** The Start Distance of the measurement becomes the value of the active marker. Markers that would no longer appear on the screen are moved to the new Start Distance.

- **Mkr=>Stop Distance** The Stop Distance of the measurement becomes the value of the active marker. Markers that would no longer appear on the screen are moved to the new Stop Distance.

SA Marker Functions

The following Marker Functions are available in SA Mode ONLY:

- Noise Marker
- Band/Interval Power Marker
- Frequency Counter at Marker
- Audio Beep with Marker

Learn more about these marker functions starting in **“Noise Marker” on page 8-32.**

All about Limit Lines

Limit lines are visual representations, drawn on the FieldFox screen, of the specified limits for a measurement. With this capability, you can easily compare measured data versus specifications. Optionally, you can enable an audible beep and display **Pass or Fail** information for each measurement.

- You can have up to as many limit line segments as there are data points for each measurement trace allowing you to test all aspects of your measurements.
- Limit lines are available in CAT Mode, NA Mode, and SA Mode. Power Meter Mode uses different limit settings. Learn more in [“Limits” on page 11-8](#).
- Limit lines and limit testing are NOT allowed in NA Mode with **Smith Chart** or **Polar** display formats.
- A simple Display Line is also available in SA Mode ONLY. Learn more in [“Display Line” on page 8-31](#).
- Limit lines can be saved and recalled with an *.sta file. Learn more in [“Saving and Recalling Files” on page 17-2](#). They can also be saved and recalled independently from the Limit softkeys. Learn more in [“How to Save and Recall Limits” on page 16-17](#).

How to Create Fixed Limit Lines

There are two ways to build a Fixed limit line:

1. **Build (limits) From a Trace.** Learn how in [“Build From Trace” on page 16-16](#).
2. **Enter X/Y data points into the on-screen editor.** The limit line is formed as the FieldFox ‘connects the dots’ on the screen. To create frequency gaps that are NOT tested, use separate limit lines. The X-axis values for two lines can overlap.
 - Press **Limit 8**.
 - Then **Edit Limits**. A limit line table appears.
 - Use the Up / Down arrows and rotary knob to navigate the cursor to the following editable cells.
 - **Description** – Press **Edit**, then enter a description for the limit line using the FieldFox labeler. Learn how in [“How to use the FieldFox labeler” on page 17-3](#).
 - **Fixed/Relative** – Press **Edit** to toggle between the following:
 - **Fixed** – the limit line does not move. The X/Y coordinates are absolute locations on the screen.

- **Relative** - the limit line moves relative to the center frequency and reference level. **Note:** It is easiest to first create Fixed Limits, then change this setting to Relative. Learn more **“Relative Limit Lines” on page 16-15.**
- **Upper/Lower** - Press **Edit** to toggle between the following:
 - **Upper** - FAILS any measured data point **ABOVE** the line.
 - **Lower** - FAILS any measured data point **BELOW** the line.
- **Off/On** - Press **Edit** to toggle between the following:
 - **On** - Limit line is drawn on the screen and PASS/FAIL testing occurs.
 - **Off** - Limit line is NOT drawn on the screen and testing does NOT occur.
- **Frequency** - Enter a numeric X-axis value of the data point.
- **Amplitude** - Enter a numeric Y-axis value of the data point.
- Press **Add** then choose from the following:
 - **Add Point** - Adds a blank X/Y data point below the cursor.
 - **Add Limit** - Adds a default limit line below the current limit.
- Press **Clear** then choose from the following:
 - **Clear Point** - Removes the X/Y data point on which the cursor resides.
 - **Clear Limit** - Removes the limit Line on which the cursor resides.
 - **Clear All** - Removes ALL limit lines.
- Press **<Back** to return to the Limit menu.

Relative Limit Lines

Relative limit lines are X/Y coordinates that are referenced to the center frequency (X-axis) and Reference level (Y-axis).

Use relative limits to test devices or signals that are identical except for the center frequency or amplitude. With relative limit lines in place, you change the center frequency of the measurement and the limits look as though they are in the same location.

The same is true for Reference Level. When you expect to measure a different power level, instead of changing the Y-axis value of all of the fixed limits, simply change to relative limits. The limits will then remain a constant Y-axis distance from the Reference Level.

Each limit line can be changed at any time from Fixed to Relative, and Relative to Fixed.

How to Create a Relative Limit Line

The easiest way to create a Relative limit line is to create a Fixed Limit at a specific center frequency and reference level. Learn how **“Relative Limit Lines” on page 16-15**. Then change the limit line to Relative. The X/Y data points will be re-calculated relative to the center frequency and reference level.

Build From Trace

A limit line can be built from an existing trace. One X/Y point is made from each measured data point. Then, using an offset value, you can shift the limit line UP for upper limits or DOWN for lower limits.

Once limit lines have been built from the trace, changes that you make to the trace, such as frequency range, do NOT change the limits. However, the limit line properties can be edited just like standard limit lines.

Figure 16-6 A lower limit line (red) built from the trace (yellow) shifted down 5 dB.

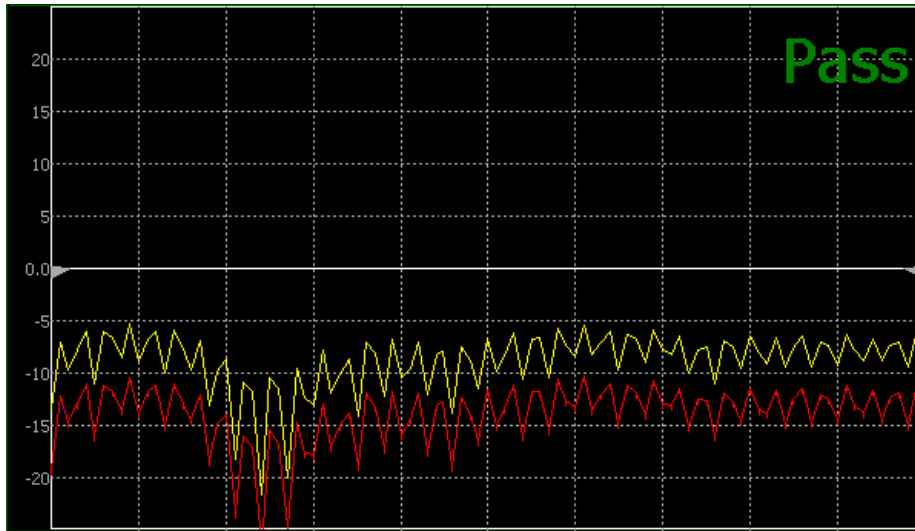

How to Build Limit Lines from a Trace

NOTE

Build from Trace is NOT allowed for traces with more than 1001 data points.

- Select the trace from which limits will be built.
- Press **Limit 8**.
- Then **Edit**.
- Then **Build From Trace**. A limit line table appears.
- Use the **▲▼** arrows to select ON.
- Use **Offset** to shift the limit line UP or DOWN. Learn how below.

Limit Options

How to set Limit Options

- Press **Exit** if the limit table is visible.
- Then **Options**.
- Then choose from the following:
 - **Beep**
 - **On Pass** Audible beep sounds when a sweep passes.
 - **On Fail** Audible beep sounds when a sweep fails.
 - **Off** No audible beep sounds.
 - **Warning On Off** Shows Pass or **Fail** indication on the display with each sweep. Data points that fail are highlighted.
 - **Limit Type** Then Fixed or Relative.
 - **Offset** Shifts the limit line up or down. Enter an offset value using the rotary knob, the **▲▼** arrows, or by entering a value with the number keys.
 - Enter a **positive** offset to shift the limit line UP, usually used with UPPER limits.
 - Enter a **negative** offset to shift the limit line DOWN, usually used with LOWER limits.
 - **Margin** Shifts the limit line up or down like an offset, but only virtually. The limit line does NOT appear to move. Enter a Margin value using the rotary knob, the **▲▼** arrows, or by entering a value with the number keys.
 - Enter a **positive** margin to virtually shift the limit line UP.
 - Enter a **negative** margin to virtually shift the limit line DOWN.

How to Save and Recall Limits

In addition to saving and recalling limits with an *.sta file, limit lines can also be saved and then recalled independent of the current mode or measurement. Use this feature to recall and apply existing limit lines to measurements with different settings or even a different frequency range.

Limit line files can be loaded into the FieldFox Data Link Software. Learn how in the help file that is included in the Data Link software.

- Press **Save/Recall** then **Device** to set the Device (Internal, SD card, or USB flash drive) to be used for the Save or Recall. Learn more in **“Set File Type and Select Device” on page 17-5**.

Data Analysis Features
All about Limit Lines

- Then press **Limit**.
- Then choose from the following:
 - **Save Limits** After limit lines have been defined, this saves the line definition to a file on the specified device.
 - **Recall Limits** Recalls a limit Line definition from the specified device.

All about Trace Math

Trace Math is available ONLY in **CAT** and NA Mode, but not in DTF measurements.

A trace is a series of measurement data points that are connected to form a line. This 'live' data trace is updated as data points are measured.

A memory trace is a live trace that has been stored in the FieldFox volatile memory. It then becomes static, meaning it is not updated with measurements. It can be displayed on the screen by itself, or with a data trace for comparison purposes.

- In NA mode, memory traces are the same color as data traces, but muted (duller).
- In CAT mode, the data trace is displayed in **yellow** and the memory trace is displayed in **blue**.

How to display data and memory traces

- Press **Trace 6**.
- Then **Data->Mem** to store the current live trace into memory. A 'beep' sounds to confirm the data trace has been saved to memory. There is no display annotation that indicates that the memory trace has been stored.
 - Press **Data** to view only the data trace.
 - Press **Memory** to view only the memory trace.
 - Press **Data & Memory** to view both the live trace and the stored memory trace.

How to perform Trace Math

Trace math is performed between a live trace and a memory trace. When one of the following math operations are selected, the yellow data trace displays the current measurement with the selected trace math applied. The math operation symbol indicated below in [brackets] is displayed on the lower left corner of the screen.

- Press **Trace 6**.
- If not already stored, press **Data->Mem** to store the current live trace into memory.
- Then **Data Math**.
- Then choose one of the following:
 - **Data + Mem** [D+M] Current measurement data is added to the data in memory.

- **Data – Mem** [D-M] Current measurement data is subtracted from the data in memory.
- **Data / Mem** [D/M] Current measurement data is divided by the data in memory.
- **Math Off** [Data] Displays trace data with NO math applied.

About Math Operations

Data / Memory and **Data - Memory** math operations are performed on complex linear data before it is formatted. Because data is often viewed in log format, it is not always clear which of the two math operations should be used. Remember: dividing linear data is the same as subtracting logarithmic data. The following illustrates, in general, when to use each operation.

Use **Data / Memory** for normalization purposes, such as when comparing traces “before” and “after” a change is made or when measuring trace noise. In the following table, the Data/Mem values intuitively show the differences between traces. It is not obvious what Data-Mem is displaying.

Values to compare	Data/Mem	Data-Mem
0.5 dB and 0.6 dB	0.1 dB	-39 dB
0.5 dB and 0.7 dB	0.2 dB	-33 dB

Use **Data - Memory** to show the relative differences between two signals. Use for comparison of very small signals, such as the S11 match of two connectors.

In the following table, Data/Mem shows both pairs of connectors to have the same 2 dB difference. However, the second pair of connectors have much better S11 performance (-50 and -52). The relative significance is shown in **Data-Mem**.

Values to compare	Data/Mem	Data-Mem for S-parameters with 20*log relationship	Data-Mem for absolute power levels with 10*log relationship
-10 dB and -12 dB	2 dB	-24 dB	-14dB
-50 dB and -52 dB	2 dB	-64 dB	-54dB

17 File Management

The FieldFox can save any of the following types of files:

- Current settings and calibration
- Trace data (*.csv, *.kml, and *.S1P)
- Picture of the FieldFox screen

In addition, files can be saved to the internal memory, a USB Flash drive, or a standardSD card.

In this Chapter

[“Save Files” on page 17-2](#)

[“Recall Files” on page 17-4](#)

[“Set File Type and Select Device” on page 17-5](#)

[“Manage Files” on page 17-7](#)

[“Manage Folders” on page 17-8](#)

[“Edit Keywords” on page 17-9](#)

[“Prefixes for Filenames” on page 17-10](#)

[“Printing” on page 17-11](#)

See Also:

[“Erase User Data” on page 18-23](#)

Saving and Recalling Files

NOTE

FieldFox State files are intended to be recalled on the same instrument model on which they were saved. Sometimes you may be able to recall them within model families. An error will result when trying to recall a state file that was saved on a different model family.

The FieldFox model families are:

- N991x (VNA/SA) model family
- N992x (VNA) model family
- N993x (SA) model family
- N995x (VNA/SA) model family
- N996x (SA) model family

Save Files

How to Save a File

- Press **Save/Recall 9**.
- Then **Save**.
- At the top of the current 'labeler' screen (see following image) check the **File Type** to save and **Device** (Internal, USB, Storage Card) to which the file is saved. Learn how to change these settings in **“Set File Type and Select Device” on page 17-5**.
- Then use the labeler to specify a filename.

CAUTION

If you are having difficulty saving to a USB flash drive, it may be a timing issue. The turn-around time for “file open, write data, file close” to a USB drive is much longer than to FieldFox’s internal memory. Alternative methods are:

1. Save your content to the FieldFox’s internal memory; and then move your files off to a USB flash drive using FTP SCPI programming. Refer to **Using FTP with FieldFox** and to the **FieldFox Programming Guide**.
 2. Save your data to the FieldFox’s internal memory, then move the data to a PC using a binary block transfer, and delete the data from the FieldFox’s internal memory. An example for transferring an image: http://na.support.keysight.com/fieldfox/help/Programming/webhelp/Examples/Transfer_Image_to_PC.htm. Please note that the receiving computer program needs to be able to handle the binary block transfer. See also **FieldFox Programming Guide**.
-

NOTE

Insert only ONE USB Flash Drive in the FieldFox when saving or copying files.

How to use the FieldFox labeler

The FieldFox labeler is used to edit or change the current filename. It is also used for many other labeling functions, such as creating a title, prefix, and keyword to display on the FieldFox screen. Learn [“Title” on page 18-6](#).

- Move the cursor (see section below, How to move the cursor), then press **Select** to add the cursor character to the end of the existing filename.
- **Back Space** to erase the last character(s) from the end of a filename.
- Press **Clear** to erase the current filename.
- The preselected keywords (File, Site, and so forth) can be selected just like a single character. These keywords can also be edited. Learn more in [“Edit Keywords” on page 17-9](#).

Figure 17-1 The FieldFox labeler

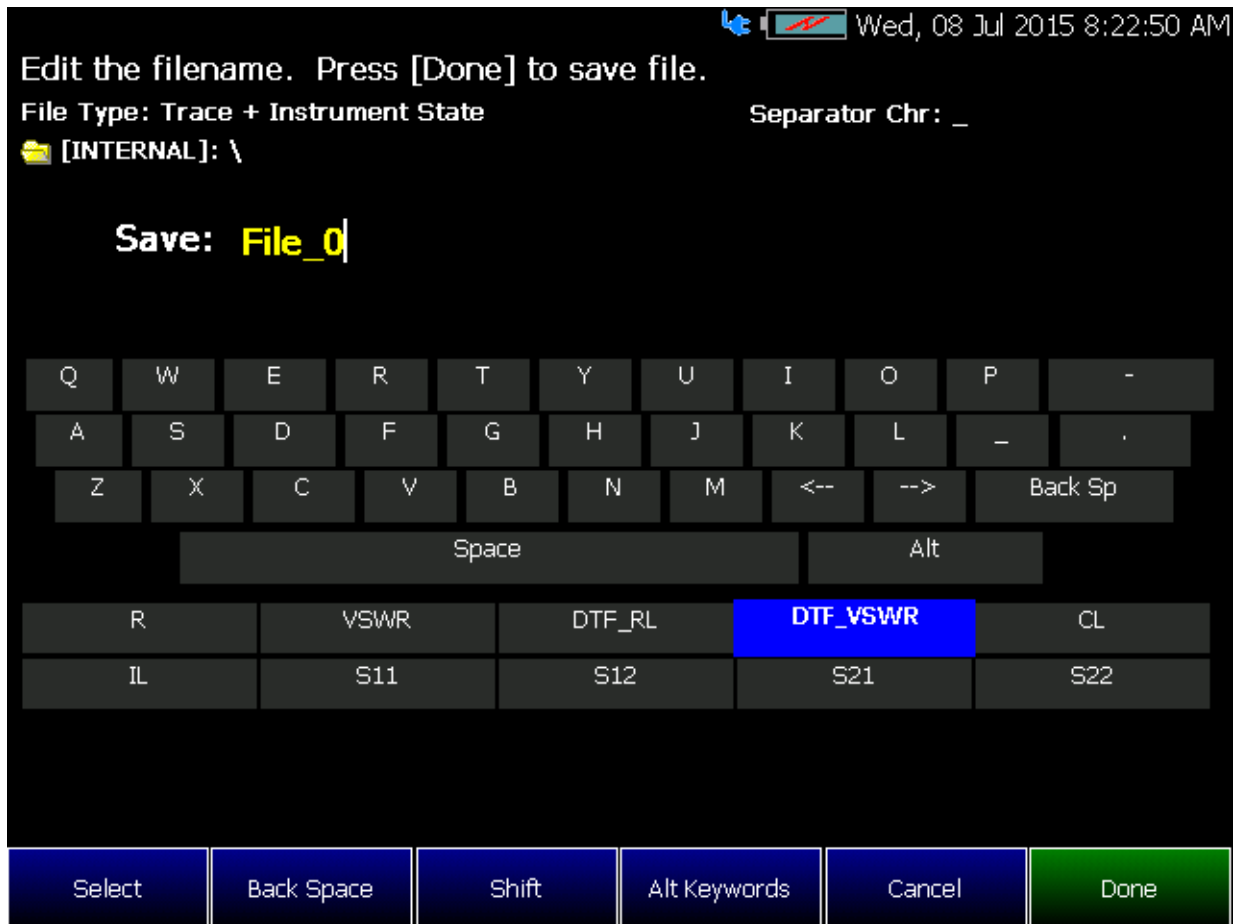

In the graphic above, the current filename is **File_0**. The cursor is on the custom **DTF_VSWR** keyword. The file will be saved to USB (flash drive). File Type is “Trace + State” (Instrument State).

How to move the cursor

- Use the rotary knob to move cursor on the same row. The cursor will change rows when it comes to a row end.
- Use the  arrows to move the cursor up and down the rows.

When the current filename is complete

- Press **Done** to save the file to the specified filename. If the filename already exists, a warning is displayed.
- Press **Cancel** to close the labeler without saving a file.
- If the filename already exists, you are prompted to choose from the following:
 - Press **Yes** to overwrite the existing file.
 - Press **Cancel** to return to edit the filename.

Recall Files

The FieldFox can recall **State** files, **Trace + State** files, and image files.

State Files

ALL FieldFox instrument settings for ALL Modes are saved and recalled in a *.sta file. If error correction is ON in CAT or NA Mode, then calibration data is also saved and recalled.

If error correction is OFF (CalRdy is active), calibration data is NOT saved in the *.sta file. When a Trace + State file is recalled on a FieldFox other than the one it was saved on, differences in the CalRdy calibration data may result in differences between the displayed traces.

Image Files

The FieldFox can open and display *.png, *.jpg, and *.jpeg images.

How to Recall a File

NOTE

Before recalling a file, first set File Type to State or Trace + State, and also Select Device from which the file will be recalled.

- Press **Save/Recall 9**.
- Then **Recall**.

- Navigate to the file to be recalled using the Up/Down arrow keys.
- Then **Recall File** or **Enter**.

Set File Type and Select Device

The following File TYPE and DEVICE settings are used to determine the type of file to save, and the location to be used for all file operations.

These two settings remain through an instrument preset, but are reset to the default values when the FieldFox power is shutdown.

Select Device (location of File Save/Recall)

- Press **Save/Recall 9**.
- Then **Select Device** to set the LOCATION where the file is to be saved. Choose from the following:
 - **Internal** Saves/Recalls/to/from the FieldFox internal memory. To specify a folder, first select Manage Folders (learn how in **“Manage Folders” on page 17-8**). The Data Link software will read data ONLY from the \UserData folder.
 - **SD Card** Saves/Recalls/Moves (Copies) files to/from the SD card (not included), inserted in the card slot. See **“Take the FieldFox Tour” on page 2-7**. Only the root folder is available.
 - **USB** Saves/Recalls files to or from a USB Flash drive (not included) that is inserted in one of the USB connectors. Only the root folder is available.

NOTE

Insert only ONE USB Flash Drive in the FieldFox when saving or copying files.

How to set File Type

State files are the only file type that can be recalled by the FieldFox.

- Press **Save/Recall 9**
- Then **File Type**. Choose one of the following:
 - **State** Saves ALL FieldFox instrument settings for ALL Modes to a *.sta file. If a calibration is ON in CAT or NA Mode, calibration data is also saved. This file can be opened ONLY by a FieldFox. State files can be saved between compatible FieldFox models. See note in **page 17-2**.
 - **Trace+State** Saves the current trace and instrument settings to a *.sta file. In SA Mode, all traces are saved. This file can be opened ONLY by a FieldFox. When recalled, the FieldFox sweep is set to Hold.

- **Picture (PNG)** Saves a 640 x 453 pixel image of the FieldFox screen to a *.png file. The picture does NOT include the softkeys.
- **Data (csv)** Saves trace data from the current Mode to a *.csv file. This format can be imported into spreadsheet software such as Microsoft Excel. Column A is always the frequency at which the data is measured.
 - In **SA Mode**, all visible data traces are saved. Each trace is saved to a separate column that is labeled with the Trace State.
 - In **CAT** and **NA** Modes, only the data trace is saved – not the memory trace.
 - In **Power Meter** and **VVM** Mode, NO data is saved.
- **Data (S1P) / (S2P)** Saves **CAT** and **NA** Mode trace data to an *.S1P or *.S2P file, depending on the active measurement. This file format is used by CAE programs such as Keysight's Microwave Design System (MDS) and Advanced Design System (ADS). It can also be imported into spreadsheet software such as Microsoft Excel.

About SNP Files

The SNP file includes header information, and the following data:

- Phase data is NOT available for port 2 (RF IN port).
- S1P - saves 1-port (receiver) data for the active data trace. *.s1p Files contain 1 stimulus value and 1 S-parameter (total of 3 scalar values) **Stim Real(Sxx) Imag(Sxx)**
- S2P (NA Mode ONLY) - saves data for two S-parameters (S11, S21) if they are both displayed. *.s2p Files contain 1 stimulus value and 4 S-parameters (total of 9 scalar values) **Stim Real(S11) Imag(S11) Real(S21) Imag(S21) Real(S12) Imag(S12) Real(S22) Imag(S22)**

Corrections

- When parameters are corrected, data is returned even when not displayed. Data is returned with the correction type that is applied for each S-parameter. The correction type for each S-parameter is annotated in the header.
- When parameters are NOT corrected or displayed:
 - With Smith chart and Polar formats, Real/Imag zero-filled data appears as (1.0, 0.0).
 - With all other formats, LogMag/Phase zero-filled data appears as (0.0, 0.0).

> Display formats

In CAT Mode, S1P files are always Magnitude (dB) / Phase (angle) format.

In NA Mode:

- Smith chart and Polar display formats are ALWAYS saved in Real/Imag data pairs.
- All other display formats are saved in LogMag/Phase (dbAngle).

> What Data Processing functions are included in saved SNP Data:

In NA Mode, the data processing functions (such as trace math) that are included in the SNP data depends on a Preference setting. Click **System**, then **Preferences**, then **Preferences**, then scroll to **NA, SNP File Save**, then select from the following:

- **Default** – SNP data does NOT include smoothing. SNP data saves are taken AFTER data processing (location 2) on the processing chain.
- **Advanced** – SNP data includes the following:
 - With Smith or Polar display format, SNP data saves are taken BEFORE most processing (location 1 on the data processing chain).
 - With any other display format, SNP data saves are taken just AFTER Formatting and Smoothing is applied (location 3 on the data processing chain). For each non-active trace, SNP trace data is reprocessed using the data processing chain of the active trace.

See the FieldFox data processing chain at the **Supplemental Online Help:** <http://na.support.keysight.com/fieldfox/help/SupHelp/FieldFox.htm> Learn more about System Preferences in “Preferences” on page 18-7.

Manage Files

Files that are stored in the FieldFox internal memory, standard SD card, and USB Flash drive, can be copied to another device or deleted.

How to Manage files

- Press **Save/Recall 9**.
- Then **Device** to select the location (Internal, USB, or standard SD Card) of the file to copy or delete.

NOTE

When selecting **Internal**, it may also be necessary to first select **Manage Folders** to specify an active folder which contains the files to copy or delete. Refer to “Manage Folders” on page 17-8.

- Then **More**.
- Then **Manage Files**.

- Then choose from the following:

NOTE

For **Copy File** and **Copy All Files**, files are always copied to a subdirectory titled Copy_<date.time stamp> of when the file was copied. For example, “Copy_June.27.2013-00.40.47”. A new subdirectory is created every time a file is copied. Files can NOT be copied to other folders. To get a file to a different folder, it must be saved to the specified folder.

- **Copy** Select a file or files to copy.
- Then select a device to copy the file to. Choose from **Internal**, **USB** (must be inserted), or **SD Card** (must be inserted).
- **Copy All File** All files that appear will be copied. Then select a device to copy the file to. Choose from Internal, USB (must be inserted), or SD Card (must be inserted).
- **Delete File** The selected file is deleted after a warning prompt is displayed.

NOTE

Insert only ONE USB Flash Drive in the FieldFox when saving or copying files.

Manage Folders

You can create new folders, delete old folders, and select the active folder to which files can be saved. The Parent folder [...] is listed when not in the root directory.

Press Save/Recall

- Press **Save/Recall 9**.
- Then **More**.
- Then **Manage Folders**.
- Then choose from the following:
 - **Change Folder** Changes the active folder to which files can be saved. The active device and current folder is displayed at the top of the screen, and below, a list of files in that folder. Use the **▲▼** arrows to highlight a folder within the current folder. Each time the **Change Folder** softkey is pressed, the highlighted folder becomes the active folder.
 - **Create Folder** A new folder is created in the current folder. Select a name for the new folder from one of the displayed keywords: You can change these keywords using the following **Edit Keywords** function. Refer to **“Edit Keywords” on page 17-9**.

- Press **Delete Folder**. The **selected** folder and its contents are deleted after a warning prompt is displayed. A “Parent” folder or system folder can NOT be deleted.
- Press **Exit** when finished.

Edit Keywords

The preselected keywords (FILE, SITE, and so forth) can be edited to meet your specific needs. Your keywords will remain in the FieldFox until you change them. Keywords are limited to 30 characters.

How to edit keywords

- Press **Save/Recall 9**.
- Then **More**.
- Then **Edit Keywords**.
- Then **Next Page** and **Previous Page** to view all keywords.
- Use the **▲▼** arrows to select a keyword to edit.
- When a keyword is selected, then press **Edit**.
- Then choose from the following:
 - Press **Select** to add the cursor character to the end of the selected keyword.
 - Press **Backspace** to erase the last character from the end of the selected keyword.
 - Press **Clear** to erase the selected keyword.

How to move the cursor:

- Use the rotary knob to move the cursor along the same row. The cursor will change rows when it comes to a row end.
- Use the **▲▼** arrows to move the cursor up and down between rows.

When the selected keyword is complete:

- Press **Done** to save all keywords and close the Edit Keywords labeler. These keywords will exist on the FieldFox until changed.
- Press **Cancel** to close the labeler without saving changes.

Prefixes for Filenames

A prefix is used as a default filename to which characters can be added. The prefix can be customized, and quickly enabled or disabled. When enabled, the current prefix is automatically entered as the start of a filename when performing a Save operation.

How to enable/disable the Prefix (persistent)

- Press **Save/Recall 9**.
- Then **More**.
- Then **Prefix ON OFF**. The current selection is underlined.

How to edit the current Prefix

- Press **Save/Recall 9**.
- Then **More**.
- Then **Prefix**.
- Then choose from the following:
 - **Select** to add the cursor character to the end of the Prefix.
 - **Back Space** to delete the last character(s) from the end of the prefix.
 - **Clear** to erase the Prefix.
 - The preselected keywords (File, Site, and so forth) can be selected just like a single character. These keywords can also be edited. See Edit Keywords.

How to move the cursor

- Use the rotary knob to move cursor on the same row.
- Use the **▲▼** arrows to move the cursor up and down the rows.

When the Prefix is complete

- Press **Done** to save the Prefix and close the labeler. This Prefix will exist on the FieldFox until it is changed.
- Press **Cancel** to close the labeler without saving changes.

Printing

The current screen or selected files can be printed using a PCL-compatible printer (like older HP Deskjet printer) connected to one of the FieldFox USB ports. Newer PCL3GUI photo and all-in-one printers are NOT supported.

Measurements can also be printed using the FieldFox Data Link software.

How to print the current screen or a saved file

To save ink, first select an outdoor (white background) display color. Learn how in **“Display Colors” on page 18-5**.

- Connect the printer to a FieldFox USB port. **The print softkey will appear ONLY when a compatible printer is connected.**
- Then press **Save/Recall 9**.
- Then **Print** and choose from the following:
 - **Printer & Page Setup** – Confirm that the printer is connected and configured properly. The Status line should read “Ready”.
 - Make other print settings as desired.
 - **Select Files for Printing** – Print up to 16 *.PNG images on one page that are stored on the Internal drive. Images can NOT be printed from the USB and SD card.
 - Edit the Quick Settings table to select up to FOUR Rows and FOUR Columns for up to 16 total images to be printed on a single page.
 - If necessary, edit the filenames to be printed.
 - Select **Done**. Then **Print Selected Files** to begin printing.
 - **Print Current Screen** – Immediately prints the FieldFox screen using the selected Printer and Page Setup settings.

File Management
Printing

18 System Settings

In this Chapter

- “Run/Hold” on page 18-2
- “Preset” on page 18-3
- “User Preset” on page 18-3
- “Volume Control” on page 18-4
- “Display Settings” on page 18-5
 - “Display Brightness” on page 18-5
 - “Display Colors” on page 18-5
 - “Trace Width” on page 18-6
 - “Title” on page 18-6
 - “Edit Keywords” on page 18-7
 - “Full Screen Mode” on page 18-7
- “Preferences” on page 18-7
 - “Quick Settings Table” on page 18-7
 - “Save and Reset Preferences” on page 18-8
 - “Language” on page 18-9
 - “Startup Mode” on page 18-9
 - “Battery Saver” on page 18-10
 - “File folders” on page 18-10
 - “Alpha Numeric Editing” on page 18-11
 - “File Saving Naming Options” on page 18-11
- “System Configuration” on page 18-11
 - “Options (Licensing)” on page 18-11
 - “GPS” on page 18-12
 - “Frequency Reference Source” on page 18-15

“Security Level” on page 18-16

“Date and Time, Format, and Time Zone Settings” on page 18-16

“LAN Settings” on page 18-18

“Power ON” on page 18-19

“FieldFox Package Installer (N9912A units with serial number prefixes ≥ 5607 Only)” on page 18-20

“Service Diagnostics” on page 18-22

“System Information” on page 18-22

“Event Log” on page 18-22

“Battery” on page 18-22

“Internal Temperatures” on page 18-23

“Erase User Data” on page 18-23

See Also:

“Install the Lithium-Ion Battery” on page 2-2



“FieldFox High Temperature Protection” on page 2-4

Run/Hold

The **Run/Hold** key determines whether the FieldFox sweeps continuously or does NOT sweep, but holds the display results of the last sweep that was performed.

Use **Hold** to conserve battery power or to allow you to save or analyze the results of a specific measurement sweep.

The current sweep mode is shown on the screen as:

-  Continuous
- **Hold**
-  is displayed while a single sweep occurs.

How to perform a single sweep while in Hold

- Press **Sweep 3**.
- Then choose one of the following:
 - **Single** Automatically sets Continuous OFF (Hold) and causes FieldFox to make ONE measurement sweep, then hold for the next Single key press.

- **SA Mode ONLY** – With **Continuous OFF** each successive **Run/Hold** press also causes a single sweep.
- **Continuous ON OFF** Makes continuous sweeps. This is the typical setting when battery power is not critical.

Preset

The Preset key restores the FieldFox measurement settings to a known condition. You can preset the entire instrument, or just the current Mode (CAT, SA, Power Meter, NA).

When Preset, the FieldFox CalReady calibration is recalled for use in CAT and NA Modes. Learn more in [“Preset Calibration \(also known as CalReady\)” on page 7-3](#).

The following settings always survive Preset and Mode Preset:

- External Reference state (see [“Frequency Reference Source” on page 18-15](#))
- SA Units (see [“Scale and Units” on page 8-8](#))
- SA Correction states (see [“Field Strength Measurements” on page 8-12](#))
- VVM Display Resolution (see [“Display Resolution” on page 14-5](#))
- Marker Peak Excursion and Threshold (see [“What Is a ‘Peak’” on page 16-10](#))
- Volume Control

How to Preset the FieldFox

- Press **Preset**.
- Then choose one of the following:
 - **Preset** Returns ALL Modes to the factory default settings.
 - **Mode Preset** Returns only the current Mode to the factory default settings. The current settings for all other Modes remain.

User Preset

User Preset allows you to store custom settings for each mode, then recall the settings when the Preset key is pressed. Your custom settings are saved to a standard State file (UserPreset.sta). However, unlike State files, calibration data is NOT saved. Learn more about State files in [“Set File Type and Select Device” on page 17-5](#).

How to set User Preset

- Make your custom settings for all modes.
- When finished, press **Preset**.
- Then **Save User Preset**, then select **Yes** to confirm.
- Then **User Preset ON**.

How to recall User Preset

- Press **Preset**.
- Then choose from the following:
 - **Preset (User)** The entire UserPreset.sta file is recalled. ALL modes assume the settings that were in place when the User Preset was saved. The active mode is the mode that was visible when the file was saved.
 - **Mode Preset (User)** The settings for only the current mode are recalled from UserPreset.sta.

NOTE

- Only the instrument settings are saved to UserPreset.sta. No trace data or calibration data is saved.
- User Preset ON / OFF is saved as a Preference setting. Like all preferences, this setting survives a FieldFox shut down and power ON. Therefore, when User Preset is ON during shut down, the FieldFox will load UserPreset.sta when it is powered ON.
- To return to Factory Preset, select **User Preset OFF**. The contents of UserPreset.sta remain stored on the FieldFox. When User Preset is OFF, you can also set the Startup Mode preference that determines which mode will be visible after powering ON. Learn more in **“Startup Mode” on page 18-9**.

Volume Control

System volume control is a FieldFox global setting which sets speaker volume for ALL success beeps, key press clicks, and individual features that use the FieldFox speaker, such as SA Mode Tune and Listen.

The volume control setting remains through a FieldFox Preset. To cause your volume control setting to remain through a FieldFox shut down, save the setting as a Preference. Learn how in **“Save and Reset Preferences” on page 18-8**.

How to set FieldFox Volume Control

- Press **System 7**.
- Then **Volume**.
- Then use the  arrows, the rotary knob, or numeric keypad to enter a value between 0 (lowest volume) and 100 (highest volume).
- Press **Volume** again and select Mute to quickly turn OFF the speaker volume.
- Press **Volume** again to set volume ON to the previous volume control.

Display Settings

You can adjust the FieldFox for optimum viewing in a wide range of lighting conditions.

Display settings remain through a FieldFox Preset. To cause the display brightness, color settings, and trace width to remain through a FieldFox shut down, save the display settings as Preferences. Learn how in [“Save and Reset Preferences” on page 18-8](#).

NOTE

Clean the transfective screen with gentle and minimal wiping using Isopropyl alcohol applied to a lint-free cloth.

Display Brightness

Change the brightness of the background.

How to set Display Brightness

- Press **System 7**.
- Then **Display**.
- Then **Brightness**.
- Use the  arrows, the rotary knob, or numeric keypad to enter a value between 0 and 100%.

Display Colors

Change Display Colors to alter the viewing scheme.

How to set Display Colors

- Press **System 7**.
- Then **Display**.

System Settings
Display Settings

- Then **Display Colors**.
- Then choose one of the following:

Indoor



Outdoor Dusk



Outdoor Clouds



Outdoor Sun



Night Vision



Trace Width

You can set width of all displayed traces on the FieldFox. This may allow better viewing or enhance the look of screen images. This setting can be saved with Preferences.

How to set Trace Width

- Press **System 7**.
- Then **Display**.
- Then **Display Colors**.
- Then **More**.
- Then **Trace Width**.
- Then choose one of the following:
 - **Normal** - Standard width.Wide
 - **Wide** - Enhanced width

Title

A custom title can be made to appear in the upper-left corner of the FieldFox screen. The title can contain up to approximately 65 alpha-numeric characters. To view the Title area, see the **“Screen Tour” on page 2-12**.

How to add or edit a Title

- Press **System 7**.
- Then **Display**.
- Then **Title**.
- Then enter or edit a title using the FieldFox labeler. This is the same labeler function that is used to name files. Learn [“How to use the FieldFox labeler” on page 17-3](#).
- Then **Title ON OFF** to make the title appear and disappear from the screen.

Edit Keywords

During a file save operation, keywords can be quickly appended to other text to create unique filenames. The Edit Keywords feature allows you to create custom keywords. Learn all about [“Edit Keywords” on page 17-9](#).

Full Screen Mode

Full Screen Mode maximizes the display of trace. The screen annotations and the soft keys are removed.

- Press **System 7**.
- Then **Full Screen**.

To **Exit** full screen Mode, press any key.

Preferences

FieldFox preferences are settings that survive a shut down. When your FieldFox is turned OFF, then back ON, these settings remain. All preference settings can be restored to their factory defaults. Learn how in [“Save and Reset Preferences” on page 18-8](#).



There are two ways to make FieldFox preference settings:

- From softkey selections throughout [the FieldFox menu structure](#). Do this to temporarily try a setting, then press **Save Current Preferences**. Learn how in the next section.
- From the Quick Settings table.

Quick Settings Table

All preferences can be set from the Quick Settings table. They are immediately saved as Preferences when **Done** is pressed.

How to view and change Preference Quick Settings

- Press **System 7**.
 - Then **Preferences**.
 - Then **Preferences**.
 - Press **Next Page** and **Previous Page** to view all settings.
 - To change a setting:
 - Use the  arrows to highlight a setting.
 - Then press **Edit**. The current setting changes to **yellow**.
 - Some settings require you to press a softkey to change the value. Otherwise, use the numeric keypad,  arrows, or rotary knob to change the value.
 - When finished changing a value, press **Done Edit**.
 - When finished changing ALL preferences, press **Done**. All changes are immediately saved as Preferences.
 - To exit the editing session without saving changes, press **Esc** at any time.
- Learn more about these preference settings:

Setting (Learn more...)

[“Language” on page 18-9](#)

[“Display Settings” on page 18-5](#)

[“Audio Beep at Marker Power” on page 8-35](#)

[“Date and Time, Format, and Time Zone Settings” on page 18-16](#)

[“GPS” on page 18-12](#)

[“Distance Units” on page 6-6](#)

[“Battery Saver” on page 18-10](#)

[“About SNP Files” on page 17-6](#)

Save and Reset Preferences

All preference settings can be made at one time from the Quick Settings table.

All settings that can be saved as preferences (except Battery Saver and Startup Mode) can also be made from individual softkey selections throughout the FieldFox menu structure. However, they remain through a FieldFox shut down ONLY when the current settings are saved as preferences.

The table above shows a list of all of these settings and where they are discussed in this User's Guide.

How to save current settings as Preferences

- Using softkeys, configure the settings as you would like them to remain.
- Press **System 7**.
- Then **Preferences**.
- Then **Save Current Settings** There is a beep when your settings have been saved.
- Press **Reset Preferences** to restore the factory default settings.

Language

Choose the language in which to display FieldFox softkeys and other messages.

How to select a Language

- Press **System 7**.
- Then **Preferences**.
- Then **Language**.
- Then choose from the following:
 - **English**
 - **Espanol - Spanish**
 - **Deutsch - German**
 - **Italiano - Italian**
 - **Francais - French**
 - **Russian**
 - **Japanese**
 - **Chinese**
 - **Turkish**

Startup Mode

The Startup Mode setting determines the mode that becomes active (visible) when User Preset is set to OFF (Factory Preset) and the FieldFox is powered ON. See **“User Preset” on page 18-3**.

How to setup Startup Mode

- Press **System 7**.
- Then **Preferences**.
- Then **Preferences**.
- Then scroll to **Global Settings > Startup Mode** and press **Edit**.
- Then repeatedly press the **Startup Mode** to scroll through the available choices.
 - **<Default>** is the factory default mode for your FieldFox model.
 - Built-in Power Meter Mode is NOT allowed as a Startup Mode.

Battery Saver

When the battery saver is OFF, the RF source power is left ON at the end of the sweep which consumes more battery power. This feature is used in CAT, NA, VVM modes.

How to set Battery Saver

- Press **System 7**.
- Then **Preferences**.
- Then **Battery Saver**.
 - **ON** – Default setting. To conserve battery power, the RF source power is turned OFF at the end of each CAT, NA, and VVM mode sweep. This behavior does not impact FieldFox measurements.
 - **OFF** – Source power is kept ON at all times, including during trigger Hold mode and between single sweep acquisitions. The RF source stays at the stop frequency until another sweep begins. This provides a constant, uninterrupted RF output from the RF OUT port. This behavior also provides the highest trace stability sweep-to-sweep which may only be evident while using either single sweep or Run/Hold. With Battery Saver OFF, the use of a full battery charge is reduced by approximately 45 minutes.

File folders

When enabled, FieldFox uses the last selected Device and Folder location as the default device location after instrument power cycle.

NOTE

Before setting the preferences for the File Folders, you must select the Device and Folder locations. Refer to **Chapter 17, “File Management”, on page 17-1**.

How to set File Folders

- Press **System 7**.
- Then **Preferences**.
- Then **Preferences**.
- Then scroll to User Folder Persist:
 - **User Folder Persist (On/Off)** – Defaults to the current Device and folder location at power up. Toggle User Folder Persist On/Off when a new Device location is selected location.
 - **User Folder** – displays the default folder location.
 - **User Device** – displays the default device location.

Alpha Numeric Editing

- **Keyboard Style** – Toggles through Qwerty/ABC style keyboards that the Labeler displays. Refer to [“How to use the FieldFox labeler” on page 17-3](#).

File Saving Naming Options

- **Prefix** – Displays the current choice for Prefix. Choices are User, Last File (default), or Off. Refer to Prefixes and Suffixes for Filenames in [“Prefixes for Filenames” on page 17-10](#).
- **Auto Append** – Displays the current choice for Auto Append to a filename (Suffix). Choices are Off (default), Number, Date. Refer to [“Prefixes for Filenames” on page 17-10](#).

System Configuration

Options (Licensing)

You can view and install options on your FieldFox. See all available options in [“Options and Features” on page 1-1](#).

How to view the Installed Options

- Press **System 7**.
- Then **System Configuration**.
- Then **Options (Licensing)**.
- Then **Show Options**.

The currently installed options are listed.

How to Install Options

A.lic file must already be on a USB Flash Drive. To learn how to obtain a.lic file, visit: <http://www.keysight.com/find/softwarelicense>

Insert the USB Flash Drive in the FieldFox.

- Press **System 7**.
- Then **System Configuration**.
- Then **Options**.
- Then **Install Options** The FieldFox reads, validates, then installs the options.
- Press and hold the power button to shut down, then restart the FieldFox.

How to Delete ALL Options

Deleting individual options is NOT supported.

- Press **System 7**.
- Then **System Configuration**.
- Then **Options**.
- Then **Advanced**.
- Then **Delete All Options**.

After a warning message, all options on the FieldFox are deleted.

NOTE

Delete All CFG Options is to be used by Service Personnel ONLY.

GPS

GPS (Global Positioning System) allows you to ‘stamp’ each data trace with your physical position in latitude/longitude/elevation format. This can be useful when making measurements on cell towers or other antennas at remote locations.

NOTE

This feature is usable ONLY with the GPS receiver that is shipped with Microsoft “Streets and Trips” and “AutoRoute” (versions 2010 and later). The GPS receiver is NOT available from Keysight. Only the GPS USB receiver is used with the FieldFox. Therefore, it is NOT necessary to purchase the very latest version of the map software.

- GPS can be used in all FieldFox modes.
- Your GPS setting can be saved with Preferences. Learn more on [page 18-7](#).

How to make GPS settings

- Press **System 7**.
- Then **System Configuration**.
- Then **GPS**.
- Then choose from the following:
 - **OFF** - Disable GPS (default setting).
 - **External** - Enable GPS using an external, customer-supplied, USB dongle device. When enabled, a check is made to detect a USB GPS device at the USB connectors. When a device is detected, a search is made for satellites overhead. The GPS works best when outdoors and in full of the open sky. when several satellites are found, the following screen appears and is updated frequently:

NOTE

As the bar graph count exceeds 9 bars, the “dB” text is dropped from the number displayed on the bar. Units for C/No are dBHz.

Figure 18-1

GPS Display

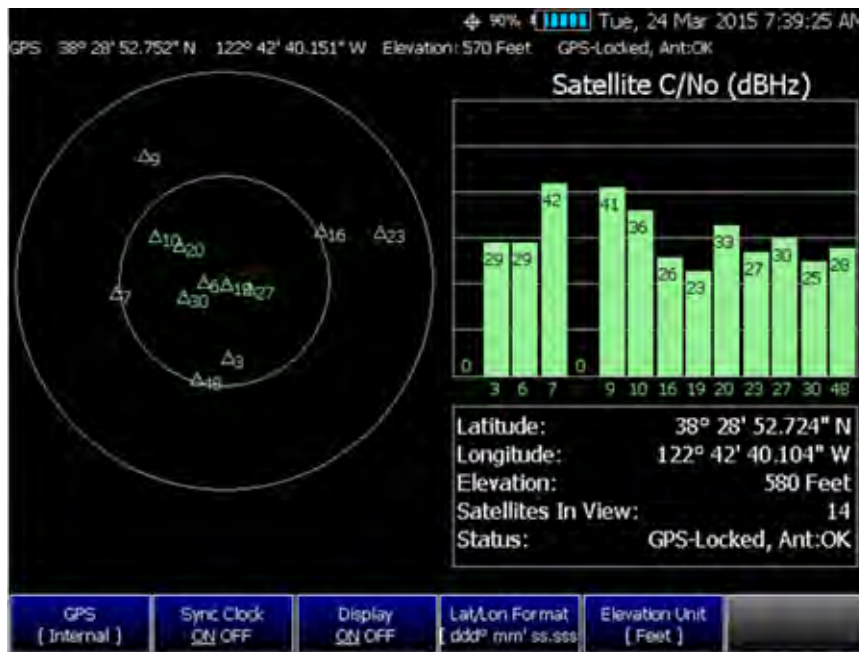

- The left portion of the screen displays satellites and the corresponding number on the adjacent Satellite Power chart.

- The right portion of the screen displays Satellite Power Carrier to Noise (C/No) dBHz values on the tops of the satellite power chart.

NOTE

The C/No values returned are not calibrated at the factory or warranted for accuracy. The numbers retrieved are passed unprocessed directly from the GPS receiver in use.

- **Sync CLock ON OFF** Enable and disable the synchronization of the FieldFox internal clock to the GPS UTC time standard.

NOTE

The GPS Sync setting has the same restrictions as the Date and Time setting. Time can be changed BACK no more than once a day and no more than 6 hours at a time. Learn more on [page 18-16](#).

- **ON** The FieldFox clock is synchronized and updated approximately every second to the time of the GPS clock. Learn how to set the local time zone on [page 18-16](#).
- **OFF** The FieldFox clock is NOT synched with GPS. When set to OFF after Sync was ON, the date and time does NOT revert back to the settings before the clock was synchronized.
- **Display ON OFF** Enable and disable the GPS display on the FieldFox main window.
- **Lat/Lon Format** Change the format of the GPS display on the FieldFox screen. Choose from:
 - **ddd°mm' ss.sss"** degrees, minutes, seconds (default setting)
 - **ddd°mm.mmmmm'** degrees, minutes, fractional minutes
 - **ddd.ddddddd°** decimal degrees
- **Elevation Unit** Choose from:
 - **m** (Meters)
 - **Feet**

GPS Status

With GPS enabled and a device detected, the following is displayed at the top of the FieldFox screen:

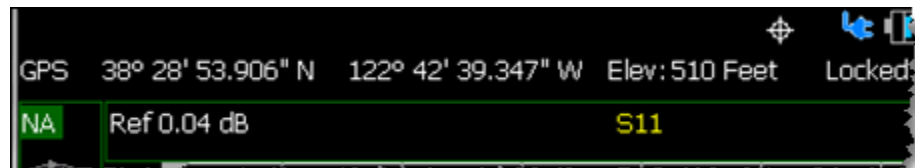

In the above image, the following icons show if the FieldFox is locked on satellites:

GPS ON and locked on satellites

GPS ON, but NOT locked on satellites

GPS ON, but no GPS receiver is present or detected

Saving Data with GPS Enabled

GPS position and clock data are included when data is saved with the following files types: *.csv, *.SnP, State, State+Trace data save.

A warning is shown if the GPS is ON but unlocked at time of save, or if the GPS feature is ON but no GPS is physically present at time of save.

The following is a sample S1P file with GPS information:

```
!GPS Latitude: 38 28.87717 N
!GPS Longitude: 122 42.66625 W
!GPS TimeStamp: 06/25/2010 16:24:48
!GPS Seconds Since Last Read: 2
```

Frequency Reference Source

The FieldFox can phase lock with an external 10 MHz reference signal. When a high-stability 10 MHz reference signal is available, this can improve the accuracy and stability of measurements in CAT, NA, and SA Modes.

The External Reference setting will survive a FieldFox or Mode Preset and is saved as part of the Instrument State.

How to set External Reference

Connect the 10 MHz External Reference to the EXT TRIG/EXT REF BNC connector on the FieldFox top panel. Learn about External Trigger Input in [“Triggering” on page 13-8](#).

- Press **System 7**.
- Then **System Configuration**.
- Then **Frequency Ref**.
- Then **Freq Ref Source Int Ext**.

NOTE

The FieldFox may take up to 10 seconds to lock to a valid External References source.

When switched to Ext, if the FieldFox does NOT find an appropriate **Ext** or **GPS** reference signal, then **Ext Ref UNLOCKED** is displayed in the lower-left corner of the graticule area. This can occur when any of the following conditions exist:

- NO external reference signal is present.
- A low or very high-level external reference signal is present. For best results, the signal should be between -5 dBm and +5 dBm.
- The external reference is off-frequency

Security Level

For security reasons, you can prevent frequency information from appearing on the FieldFox while in SA, NA, or CAT modes.

How to set Security Level

- Press **System 7**.
- Then **System Configuration**.
- Then **Security Level**.
- Then choose from the following:
 - **None** All frequency settings are visible.
 - **High** Frequency information is blanked from the following:
 - Display annotation
 - Softkeys
 - Marker display and marker table
 - Calibration properties
 - All settings tables
 - Limit line tables
 - All saved.png files
 - Any of the following will re-display frequency information:
 - Set to **None**, Preset, Mode Preset, or FieldFox restart.

Date and Time, Format, and Time Zone Settings

Set the local date and time, Date and Time format, and Time Zone that is shown on the FieldFox screen. The Date and Time is also used to identify files that are saved.

The Date and Time can also be set by synchronizing with GPS satellites. Learn more in **“GPS” on page 18-12**.

How to Update Date and Time using Internet

This method of setting the Date and Time does NOT have the security restrictions of the other methods (listed below).

This method will NOT set the correct Time Zone. You must do that using the manual method. See below.

- Press **System 7**.
- Then **System Configuration**.
- Then **More**.
- Then **Update Time using Internet**.
- Connect a LAN cable that is also connected to the Internet.
- Then press **Update Time using Internet**. When successful, a message is displayed indicating the amount of time correction that occurred.
- Optional: Set the following when a Proxy server is used to connect to the internet:
 - **Proxy Host** – Enter the name of the proxy host.
 - **Proxy Port** – Enter the port number of the proxy host.

How to MANUALLY set Date and Time, Format, and Time Zone

NOTE

Because of licensing security, the manual and GPS Sync methods to set Date and Time are restricted as follows:

Can be set backward no more than 5 hours at a time.

Can be set forward any amount of time.

Can be set backward or forward no more than once in a day. A new day begins at midnight.

The GPS Sync setting has the same restrictions.

There is no restriction for setting the Time Zone.

To change the Date and Time backward a significant amount, send an email to csg.servicedesk@keysight.com.

NOTE

BEFORE manually setting the Date and Time, be absolutely certain that the Time Zone setting is correct.

- Press **System 7**.
- Then **System Configuration**.
- Then **Date and Time**.
- Press the   arrows to highlight the row to be edited.

- Then press **Edit**.
- Use the **▲▼** arrows or rotary knob to select the field to be edited.
- Use the **▲▼** arrows or numeric keypad to edit that field.
- Press **Cancel** or **Done** when the edits are complete.
- Press **Done** to exit the Date and Time settings. The readout in the upper-right corner of the FieldFox screen will update accordingly.

LAN Settings

Configure the LAN settings to be used to communicate with the Data Link Software. Learn more about Data Link at:
www.keysight.com/find/fieldfoxsupport.

Use knob. Press [Edit] to make changes. Press [Done] to exit.	
Setting	Value
Current IP Address	192.168.1.102
Current Subnet Mask	255.255.255.0
Current Gateway	192.168.1.1
Hostname	A-N9912A-00000
Obtain IP Address using:	DHCP
Static IP Address	123.456.789.123.123
Static Subnet Mask	0.0.0.0
Static Gateway	0.0.0.0
Apply Settings at:	PowerUp

Table 18-1 LAN LEDs (N9912A units with serial number prefixes \geq 5607 Only)

LAN LEDs (N9912A units with serial number prefixes \geq 5607 Only)

When FieldFox is connected to the LAN, the flashing LAN LEDs have the following definitions:

Green: Flashing indicates packets are being transferred.

Yellow:

- Flash, pause = 10 Mbit link speed
- Flash, flash, pause = 100 Mbit link speed
- Flash, flash, flash, pause = 1 Gbit link speed

How to configure LAN settings

The first three 'Current...' settings can NOT be edited.

- Press **System 7**.
- Then **System Configuration**.

- Then **LAN**.
- Use the  arrows to select one of the following, then press **Edit**.
- **Hostname** Change the name that can be used to address the FieldFox if your server supports this feature. The default hostname is generated automatically.
- **Obtain IP** Choose from:
 - **DHCP** - IP Address is assigned dynamically. If your server supports this feature, the IP Address for the FieldFox is assigned each time it is started.
 - **Static** - Set the IP Address manually. The Address remains until you change it.
 - **Static IP Address** - Enter the IP Address – including periods - in the format nnn.nnn.nnn.nnn

NOTE

For all FieldFoxes with firmware \leq A.08.25 and \leq A.09.50 FW, when using Static IP addresses:

- Either a valid Static Gateway is required or 0.0.0.0.
 - Either a valid Static DNS is required or 0.0.0.0. (If entry is available.)
-
- **Static Subnet Mask** - Enter the Subnet Mask – including periods - in the format nnn.nnn.nnn.nnn
 - **Static Gateway** - Enter the Static Gateway – including periods - in the format nnn.nnn.nnn.nnn
 - **Static DNS** - Enter the Static DNS – including periods - in the format nnn.nnn.nnn.nnn
 - **Apply Settings** Choose from:
 - **Power Up** The above settings take effect when the FieldFox is started.
 - **Now** The above settings take effect immediately.

NOTE

To make the LAN settings persist after power up, toggle Apply Settings to Now then back to Power Up. You should see a message indicating that the LAN config file was saved.

- Press **Done Edit** when finished.

Power ON

When the FieldFox is without a power source, this setting allows the FieldFox to power ON as soon as a charged battery or the DC Adapter is inserted without pressing the power button.

How to set Power ON

- Press **System 7**.
- Then **System Configuration**.
- Then **Power ON**.
- Then choose from the following:
 - **Auto** The FieldFox will power ON when a charged battery or the DC Adapter is inserted.
 - **Manual** The FieldFox will power ON only when the power button is pressed.

FieldFox Package Installer (N9912A units with serial number prefixes \geq 5607 Only)

The FieldFox Package Installer enables you to download new versions of firmware from either a USB memory or SD Card. Additionally, the Utility softkey enables you to backup user files or restore user files.

How to run the Installer

NOTE

Before running the Installer to update your firmware, you might want to back up your user data. Refer to [“How to restore files” on page 18-21](#).

- Press **System 7**.
- Then **System Configuration**.
- Then **More**.
- Then **Firmware Update**.
- Then **Start Installer**.
- The Installer software opens after a couple of seconds.

NOTE

If no files are displayed, verify that a USB memory or SD Card is installed and press **Refresh List**.

- Then the  arrows or the knob to scroll to the firmware you want to install.
- Press **Start Install**.
- “Current Step Progress:” bar and a “Total Progress:” bar are displayed along with this message: “Copying package. Do not remove install media.”

- When the installation is completed, the FieldFox reboots.

How to backup files

This procedure backs up your user data to a USB or SD card. See also [“How to restore files” on page 18-21](#).

NOTE

If you backup multiple versions of the user files, the FieldFox appends a “_#” to each subsequently stored file. During restore, the file with the highest appended number is loaded into the FieldFox.

From the initial Installer menu:

- Press **Utility**
- Then **Backup Data**
- A message is displayed: “Choose backup file location.”
- Then choose either **SD Card** or **USB**
- A progress bar and a message is displayed: “Saving user data...”
- Press **Cancel** to exit without backing up your files and returning to the initial Installer menu.

How to restore files

This procedure restores user files from a USB or SD card. See also [“How to backup files” on page 18-21](#).

CAUTION

Restoring files overwrites the existing user data on the FieldFox.

NOTE

If you backup multiple versions of the user files, the FieldFox appends a “_#” to each subsequently stored file. During restore, the file with the highest appended number is loaded into the FieldFox

If you stored any user files to a USB or SD card, this procedure restores those files.

From the initial Installer menu:

- Press **Utility**
- Then **Cancel** to exit without restoring your files and returning to the initial Installer menu.

Or

Press **Restore Data**

- A message is displayed: “This option will COMPLETELY ERASE existing user data. ARE YOU SURE?”
 - Then **No** to return to the previous menu without restoring files.
 - Or
 - Press **Yes**
 - Then choose either **SD Card** or **USB**
- A progress bar and a message is displayed: “Restoring user data...”

Service Diagnostics

- The Service diagnostics menu is generally used to display service-related information. To access these menu items, press **System 7** then **Service Diagnostics**.

System Information

The System information table shows important information about your FieldFox. The following is the most useful information:

- **Model Number** – FieldFox model
- **Serial Number** – Identification number of your FieldFox
- **Firmware Release** – The currently installed version of software. Check to see if you have the latest firmware at:
www.keysight.com/find/fieldfoxsupport
- **Network Identity** – The network name and current IP address of your FieldFox.
- **Reflectometer Factory Cal** – The Factory (CalReady) Calibration shows the date and time that the factory cal was performed for each test port and the Thru connection. The format is P1 <date time>, P2 <date time>, P1-P2 <date time>. The factory calibration is updated when you send your FieldFox to Keysight for Instrument Calibration. Learn more in “**Instrument Calibration**” on page C-4.

Event Log

The Event Log shows the information that has appeared on the FieldFox screen. The most recent information is at the top of the table.

Press **Clear Events** to erase this information.

Battery

Learn more in [Chapter 20, “Working with the Lithium-Ion Battery”](#), on page 20-1.

Internal Temperatures

Learn about the importance of the internal FieldFox temperatures in **“FieldFox High Temperature Protection”** on page 2-4.

Erase User Data

All data that you have written to the FieldFox can be erased with the press of a button. You would do this if your FieldFox is located in a secure environment and must be routinely erased of sensitive data.

All data is deleted from the FieldFox internal “UserData” partition. This includes all State files and Trace + State files (*.sta), all Data files (*.csv, *.snp), all Picture files (*.png), all Cal Kit files, and all Cable files.

External media that is inserted (mini-SD card or USB flash drive) is NOT erased.

The “Lost Clusters” folder and files are NOT erased because they are part of the file system housekeeping.

How to Erase User Data

- Press **System 7**.
- Then **Service Diagnostics**.
- Then **Advanced**.
- Then **Erase User Data**.
- Then **Confirm Erase**.
- Then the following occurs:
 - All data files and folders are deleted from the “UserData” partition.
 - A large file of 0s is written to all of the free blocks on the partition.
 - The large file is deleted. All blocks released by deleting this file are now available for use.
 - The FieldFox is rebooted, which manages the newly-freed data and re-writes the factory cal kits and cable files.

NOTE

Rebooting is not required on the N9912A units with serial number prefixes ≥ 5607 models.

System Settings
Service Diagnostics

19 Using the Mini-USB Port to send SCPI Commands and Queries (N9912A units with serial number prefixes ≥ 5607 Only)

In this Chapter

[“Mini-USB Connection to PC with IO Libraries” on page 1](#)

Mini-USB Connection to PC with IO Libraries

The FieldFox comes with a mini-USB port that can be used to connect to your PC's standard USB 2.0 port. Using Keysight IO Libraries, Connection Expert and connecting via a VISA connection, you can send SCPI commands via the **Keysight Interactive IO** window to the FieldFox. Refer to your IO Libraries online help for the details on connecting to your instrument. Refer to keysight.com to download the IO Libraries.

NOTE

The FieldFox may be communicated with via the VISA libraries. This makes it available to VEE, LabView, and other software tools that can communicate with VISA instruments.

You can connect to USB ports that are not type 2.0 USB. But, the mini-USB port is optimized for a type 2.0 USB ports.

Overview of mini-USB to PC setup for sending SCPI commands and queries:

- Connect a mini-USB (FieldFox device-side) to standard USB (host-PC)
- **On the FieldFox:** Power on the instrument.
- Click **System 7** > **System Diagnostics** > **System Information** and find the FieldFox serial number.
- **On your PC:** Open the **Keysight IO Libraries** software, **Connection Expert** and connect to the FieldFox using the VISA connection. Refer to the Keysight Connection Expert Help.
- In the **Keysight Interactive IO** window: Type in your SCPIs on the Command line and click **Send Command**, **Read Response**, or **Send & Read**. Refer to the Keysight Connection Expert Help and [Figure 19-1 on page 2](#).

Using the Mini-USB Port to send SCPI Commands and Queries (N9912A units with serial number prefixes ≥ 5607 Only)
Mini-USB Connection to PC with IO Libraries

Figure 19-1 Keysight Interactive IO Window

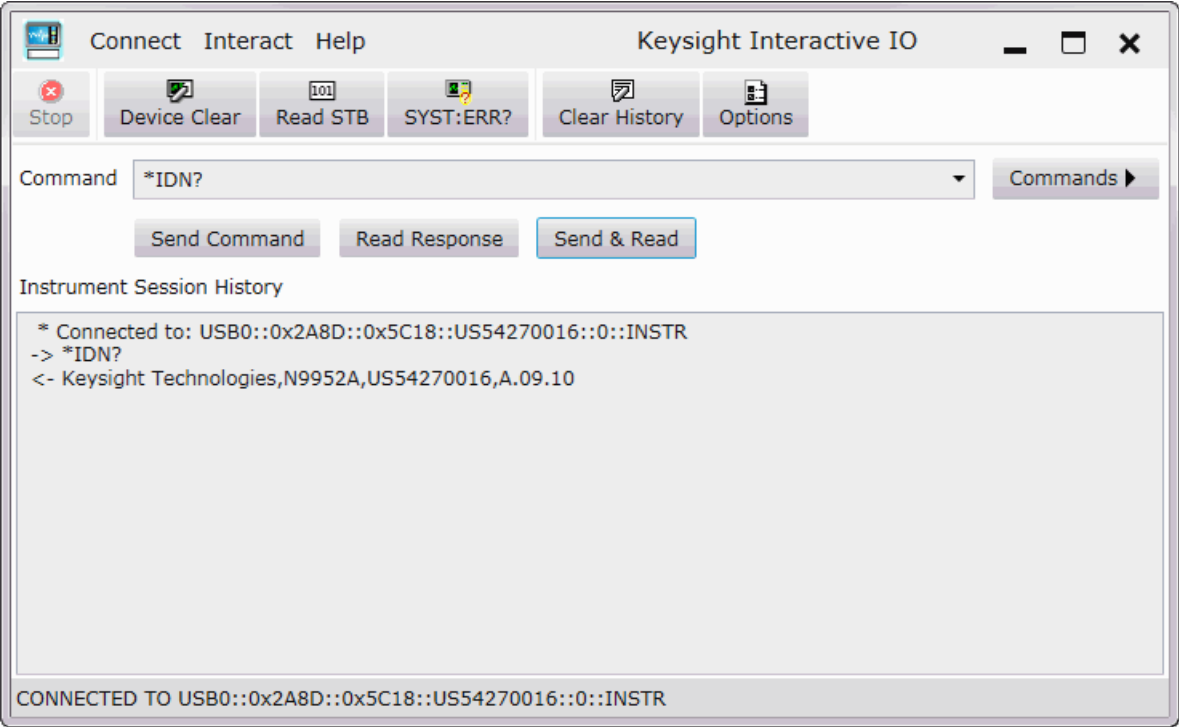

20 Working with the Lithium-Ion Battery

In this Chapter

“Viewing the Battery Charge Status” on page 20-1

“Charging the Battery” on page 20-3

“Reconditioning Battery” on page 20-6

“Battery Care” on page 20-6

“Maximizing Battery Life” on page 20-6

“Lithium-Ion Battery Disposal” on page 20-7

See Also:

“Install the Lithium-Ion Battery” on page 2-2

“To conserve battery power:” on page 2-3

“For the Battery” on page 21-6

Viewing the Battery Charge Status

You can view the battery charge status in the following ways:

- Icons in the upper right of the front panel screen.
- Battery screen - select **System** then **Service Diagnostics** then **Battery**.
- Built-in battery gauge. Learn more in the following section.

Table 20-1

Front Panel Icons



Icon	Status
	Connected to external power through the AC/DC adapter. Battery installed and charging. The amount of charge is indicated by the number of bars shown.

Table 20-1

Front Panel Icons

Icon	Status
	Battery not charging with 84% battery life remaining.
	Battery fully charged. A fully charged battery MAY NOT read 100%.

Service Diagnostics—Battery Screen

The Battery screen displays the following information. To access the screen, select **System** then **Service Diagnostics** then **Battery**.

Additional battery information is available using SCPI commands.

1. **Status** – Fully charged, No battery, Charging, Empty, or Discharging.
2. **External DC Supply** – True or False indicates if an external DC supply is connected.
3. **Battery Present** – True or False indicates if a battery is installed.

NOTE

Items 4 through 8 are read directly from the battery. The information is based on the battery's internal sensors and memory.

1. **Voltage** – measured by the battery's sensor.
2. **Current** – amount of current being consumed when operating from internal battery. If battery is charging, indicates amount of charging current.
3. **Battery Temperature** – internal temperature of the battery as measured by a sensor embedded in the battery.
4. **Present Run Time to Empty** – minutes of power remaining based on amount of current being used now.
5. **Charge Cycles** – number of charge cycles the battery has experienced. Charge cycle defined as $\geq 80\%$ change in relative state of charge.

Built-In Battery Gauge

Each lithium ion battery has an LED gauge that displays its charge status. The gauge is active unless the battery is in shut down mode.

To view the LED gauge, open the FieldFox battery compartment door, remove the battery, then press the button on the battery.

The battery in your FieldFox will have either 4 or 5 LED segments.

5-segment Gauge	Charge Remaining	4-segment Gauge	Charge Remaining
5 segments	≥80%	4 segments	≥75%
4 segments	60% to 79%	3 segments	50%, to 74%
3 segments	40% to 59%	2 segments	25% to 49%
2 segments	20% to 39%	1 segment	< 25%
1 segment	< 20%		

Charging the Battery

When you receive your FieldFox, the lithium-ion battery is partially charged to approximately 30% to 40% to preserve battery life. Allow four hours to fully charge the battery internally, or three hours by using the external battery charger (N9910X-872). A fully charged battery will power your FieldFox for about four hours. It is NOT necessary for you to do any type of battery preconditioning before use.

The FieldFox circuitry ALWAYS prevents the battery from discharging to a level that is damaging. However, if the battery is completely discharged, the FieldFox may not turn ON. If this occurs, the battery can still be charged either internally or externally.

Because a lithium-ion battery has no memory effect, you can charge a battery at any time regardless of the current charge status. However, this could impair the accuracy of its internal charge-remaining indicator. When the Max Error is 10% or greater, the battery should be reconditioned. Learn more on [page 20-6](#).

Internal Charging with the AC/DC Adapter

NOTE

Read the safety information in [“For the AC/DC Adapter” on page 21-4](#).

Internal charging time for a fully depleted battery is approximately 4 hours with the FieldFox either ON or OFF.

Figure 20-1 AC/DC Adapter



To charge a battery inside the FieldFox, insert the AC/DC adapter plug into the Power connector on the FieldFox side panel, then plug the adapter into an AC outlet.

- FieldFox ON: Charging is indicated by a battery icon in the upper right of the front panel screen.
- FieldFox OFF: Charging is indicated by the FieldFox power LED glowing amber, with its intensity increasing from dim to bright every few seconds. This pattern repeats until the LED turns off when charging is done. Learn more on **“Front Panel” on page 2-7**.

Using the External Battery Charger (N9910X-872)

NOTE

Read the safety information in **“For the External Battery Charger (N9910X-872)”** on page 21-6.

Figure 20-2 External Battery Charger (N9910X-872)



The external battery charger (N9910X-872), lets you charge a fully depleted battery in approximately three hours. It is a two bay, level-3 stand-alone battery charger that is compliant with the standard Smart Battery System. The two bays are charged sequentially on a first-come, first-served basis, though a discharge can be performed in the left bay while the right bay is charging. It uses an external universal switching.

External Battery Charger LED	Charging Status
Green	Fully charged
Green flashing	Fast charging
Yellow flashing	Reconditioning – the accuracy of the battery’s internal LED charge gauge is being renewed. See “Reconditioning Battery” on page 20-6.
Yellow/green	Battery is reconditioned
Red flashing	Error
Yellow	Standby

For more information, refer to the Instruction Manual included with the external battery charger.

Reconditioning Battery

Reconditioning a battery can be performed ONLY with the External Battery Charger (N9910X-872).

1. Insert a battery into the left bay of the external charger.
2. Press the button labeled Push to Recalibrate Left Battery Bay
3. The charger will charge the battery fully, discharge it completely, then recharge it fully again. The entire process can take up to 12 hours.
4. Install the battery into the FieldFox.
5. On the System, Battery screen, verify that the battery is fully charged.

Battery Care

Visually inspect the battery periodically for signs of degradation, such as swelling, cracking of the battery shell, or leakage of fluid. If degradation occurs, replace the battery and dispose of it properly. Refer to **“Lithium-Ion Battery Disposal” on page 20-7**. Operation with a degraded battery could result in damage to the FieldFox. Learn more, see **“For the Battery” on page 21-6**.

Maximizing Battery Life

- If AC power is not continuously available (Ex: in a field environment), use the battery and recharge it when it holds a 20% to 50% charge, as shown on the screen's battery charge icon. At this charge level, 2 or 3 segments show on the battery gauge.
- If the FieldFox is not going to be used for more than a week, remove the battery. Best practice is to store the battery with a charge of about 50%. At this charge level, 3 segments show on the battery gauge. Batteries that remain idle eventually lose their ability to hold a charge.
- Allow a battery to warm to room temperature before charging it. Temperature shock can damage the battery chemistry and in some cases cause a short circuit.
- Store batteries in a cool, dry location, away from metal objects and corrosive gases.
Storage temperature limits (20% to 50% relative charge is recommended):
 - Transportation: -20°C to 50°C
 - Within 1 month: -20°C to 45°C
 - Within 6 months: -20°C to 40°C
 - Within 1 year: -20°C to 35°C

- Battery charging limits:
Charge temperature: 0°C to 45°C (<10°C slows charge on some batteries)
Discharge temperature: –10°C to 60°C
- Operate the FieldFox on battery power between the ambient temperatures of –10 and +50°C (–14 to +122°F). Using the battery at lower or higher temperatures can damage it and reduce operating life. Cold temperatures affect battery chemistry, reducing charge capacity, especially below 0°C (32°F).

Lithium-Ion Battery Disposal

When you notice a large decrease in charge capacity after proper recharging, it's probably time to replace the battery.

Lithium-Ion batteries need to be disposed of properly. Contact your local waste management facility for information regarding environmentally sound collection, recycling, and disposal of the batteries. Regulations vary for different countries. Dispose of the battery in accordance with local regulations.

Keysight Technologies, through Rechargeable Battery Recycling Corporation (RBRC), offers free and convenient battery recycling options in the U.S. and Canada. Contact RBRC at 877-2-RECYCLE (877.273.2925) or online at: <http://www.call2recycle.org/> for the nearest recycling location.

Working with the Lithium-Ion Battery
Lithium-Ion Battery Disposal

21 Safety Considerations

Keysight has designed and tested the FieldFox in accordance with IEC Publication 61010-1 Safety Requirements for Electrical Equipment for Measurement, Control and Laboratory Use, and the FieldFox is supplied in a safe condition. The FieldFox is also designed for use in Installation Category II and pollution Degree 2 per IEC 61010-1. Read the following safety notices carefully before you start to use this FieldFox to ensure safe operation and to maintain the product in a safe condition.

For the FieldFox

WARNING

No operator serviceable parts inside except for the lithium-ion battery. Refer servicing to qualified personnel. To prevent electrical shock do not remove covers.

WARNING

If this product is not used as specified, the protection provided by the equipment could be impaired. This product must be used in a normal condition (in which all means for protection are intact) when attached to the AC-DC adapter.

WARNING

The unit may be used only in the operating conditions and positions specified by the manufacturer.

WARNING

Do not install substitute parts or perform any unauthorized modification to the product. Return the product to Keysight Technologies or a designated repair center for service to ensure that safety features are maintained.

WARNING

Applicable local or national safety regulations and rules for the prevention of accidents must be observed in all work performed.

WARNING

Ensure that the connections with information technology equipment comply with IEC950 / EN60950.

WARNING

Observe all ratings and markings of the instrument before connecting the instrument.

Maximum Input Voltages and Power:

RF Output Connector: 50V DC, +23 dBm RF

Ext Trig/Ref Connector: 5.5 V DC

RF Input: ± 50 VDC, +27 dBm RF

DC Input: 19VDC, 4ADC

WARNING

When performing a measurement, ensure that the right safety and performance ratings of the instrument and accessories are used.

Do not expose the circuit or operate the instrument without its cover or while power is being supplied.

Do not operate the instrument in any environment at risk of explosion.

CAUTION

The power cord and connectors shall be compatible with the connector used in the premise electrical system. Failure to ensure adequate earth grounding by not using the correct components may cause product damage and serious injury.

CAUTION

The measuring terminals on this instrument are designed to be used with external signals described in Measurement Category I, but NOT with external signals described in Categories.

For the AC/DC Adapter

WARNING

The AC/DC adapter is a Safety Class 1 Product (provided with a protective earthing ground incorporated in the power cord). The mains plug shall only be inserted in a socket outlet provided with a protective earth contact. Any interruption of the protective conductor inside or outside of the product is likely to make the product dangerous. Intentional interruption is prohibited.

WARNING

Use only the designated AC/DC adapter supplied with the instrument.

WARNING

Use only the designated power cord supplied with the AC/DC adapter.

WARNING

No operator serviceable parts inside this product. Do not perform any unauthorized modification to the product. Return the product to Keysight Technologies or a designated repair center for service to ensure that safety features are maintained.

WARNING

Operated at an ambient temperature: 0 to 40°C; full power rating; derate linearly to 50 W at 50°C.

Maximum output rating: +15V/4.0 A.

Input rating: AC 100–250 V, 50/60Hz

WARNING

Main Plug: Use a 3-pin main plug that complies with IEC 60884–1, Plugs and Socket–Outlets for Household and Similar Purposes – Parts 1: General Requirements and country specific safety authority requirements, such as UL, SA, BSI, VDE, CCC, SA, NZ, and PSE.

WARNING

Appliance Connector: Use an appliance connector certified to IEC 60320–1/EN 60320–1 requirements

WARNING

To prevent electrical shock, disconnect the AC to DC adapter from the mains before cleaning. Use a dry cloth or one slightly dampened with water to clean the external case parts. Do not attempt to clean internally.

WARNING

When the FieldFox is connected to the AC/DC adapter, position the adapter so the power cord is readily accessible. The power cord is the disconnecting device. It removes main power to the AC/DC adapter. The FieldFox front panel switch is only for the DC power within the instrument, and not for the AC/DC adapter. Alternately, an AC switch or circuit breaker (which is readily identifiable and is easily reached by the operator) may be installed and used as a disconnecting device to remove mains power from the AC/DC adapter.

WARNING

To avoid overheating, always disconnect the FieldFox from the AC/DC adapter before storing the FieldFox in the backpack.

If you prefer to leave the FieldFox connected to the AC/DC adapter while inside the backpack, you can disconnect the AC/DC adapter from its AC power source to prevent overheating.

CAUTION

The AC/DC adapter has an auto-ranging line voltage input – be sure the supply voltage is within the specified range.

CAUTION

The AC/DC adapter is for indoor use only.

CAUTION

Never use a modified or damaged charger. Use the original AC-DC adapter ONLY.

CAUTION

The AC/DC adapter is designed for use in Installation Category II and Pollution Degree 2 per IEC 61010-1.

For the External Battery Charger (N9910X-872)

CAUTION

If charging batteries externally, use the optional external charger available from Keysight, or another SMBus charger of level II or higher.

Never use a non-SMBus charger because the battery issues commands over the SMBus to the charger to control the charge rate and voltage.

Never use a modified or damaged charger.

External AC/DC power supply, U.S. FCC compliance

Meets the required verification equipment authorization rules.

This device complies with part 15 of the FCC Rules. Operation is subject to the following two conditions: (1) This device may not cause harmful interference, and (2) this device must accept any interference received, including interference that may cause undesired operation.

For the Battery

Lithium battery packs may get hot, explode, or ignite and cause serious injury if exposed to abuse conditions. Be sure to follow these safety warnings:

WARNING

Lithium-ion batteries:

- Must not be exposed to high temperatures (>70°C) or fire.
 - Must be kept away from children.
 - Must not be short circuited.
 - Must be replaced only with Keysight qualified Li-ion batteries.
 - If replaced or charged improperly, there is a danger of explosion.
-

WARNING

Do not connect the positive terminal and negative terminal of the battery to each other with any metal object (such as wire).

WARNING

Do not carry or store the battery with necklaces, hairpins, or other metal objects.

WARNING

Do not pierce the battery with nails, strike the battery with a hammer, step on the battery, or otherwise subject it to strong impacts or shocks.

WARNING

Do not solder directly onto the battery.

WARNING

Do not expose the battery to water or salt water, or allow the battery to get wet.

WARNING

Do not disassemble or modify the battery. The battery contains safety and protection devices, which if damaged, may cause the battery to generate heat, explode, or ignite.

WARNING

Do not place the battery in direct sunlight, or use or store the battery inside cars in hot weather. Doing so may cause the battery to generate heat, explode, or ignite. Using the battery in this manner may also result in a loss of performance and a shortened life expectancy.

WARNING

There is a danger of explosion if the battery is incorrectly replaced. Replace only with the same or equivalent type of battery recommended. Discard used batteries according to manufacturer's instructions.

WARNING

If you are charging the batteries internally, even while the FieldFox is powered off, the FieldFox may become warm. Allow for proper ventilation.

WARNING

Do not discharge the battery using any device except the FieldFox or the external battery charger (N9910X-872). When the battery is used in a device other than those specified, it may damage the battery or reduce its life expectancy. If the device causes an abnormal current to flow, it may cause the battery to become hot, explode, or ignite and cause serious injury.

WARNING

For a Korean battery safety consideration translation, refer to [Appendix D: "Korean Battery Safety Translation."](#)

Battery Protective Functions

The following protective functions are designed into the lithium-ion rechargeable battery system used in FieldFox.

The protective functions can be divided between two categories: active and passive. Active protection refers to the type of protection that depends on at least two or more protection devices working together to enable the protection. Passive protection refers to the type of protection that is always enabled independent of any other protection device.

Active Protection

Primary Overcharge Voltage: This prevents the battery from being charged if the voltage across any cell exceeds approximately 4.35 V per cell. Once the overcharge protection is tripped, the voltage across each cell must drop below approximately 4.15 V to reset the protection and permit charging.

Secondary Overcharge Voltage: This is a one-time, permanent protection that is triggered when the voltage across any cell exceeds approximately 4.45 V. Once this protection is tripped, the battery can no longer be used and must be replaced.

Overdischarge Voltage: This prevents the battery from discharging if the voltage across any cell drops below approximately 2.6 V. Once the overdischarge voltage protection is tripped, the voltage across each cell must be charged to approximately 3 V to reset the protection and permit discharging.

Primary Overcharge Current: This prevents the battery from being charged if the average charging current reaches or exceeds 3.5A for a time period of 120 seconds or more.

Secondary Overcharge Current: This prevents the battery from being charged if the charging current reaches or exceeds 4A+/-20% for a time period of 20 milliseconds or more.

Primary Overdischarge Current: This prevents the battery from being discharged if the average current out of the battery reaches or exceeds 5A for a time period of 120 seconds or more. This protection can be reset by removing the load.

Secondary Overdischarge Current: This prevents the battery from being discharged if the current out of the battery reaches or exceeds 6A for a time period of 20 milliseconds or more. This protection can be reset by removing the load.

Short Circuit Protection: This prevents the battery from being charged or discharged and protects against damage or lost data if the current in or out of the battery reaches or exceeds 12.5A for a time period of 183 microseconds or more. This protection can be reset by removing the load.

Overtemperature Charging: The system microcontroller prevents the battery from being charged if the cell temperature exceeds 46C. Once the overtemperature charging protection is tripped, the cell temperature has to drop to or below 45C to reset the protection and permit charging.

Overtemperature Discharging: The system microcontroller prevents the battery from being discharged if the cell temperature exceeds 65C. Once the overtemperature discharging protection is tripped, the battery is automatically shut off which results in turning off the instrument as well.

Passive Protection

Reverse Charging: A reverse protection diode prevents against damage or lost data due to a reverse charge polarity applied to the battery terminals.

Primary Overtemperature: A PTC (positive temperature coefficient) polyfuse in series between the Li-ion cells and the charging and discharging transistors will open up and limit current flow to the battery terminals as a function of very high temperatures. This protection is resettable once the overstress condition is removed.

The maximum operating temperature of this fuse is 85C.

Secondary Overtemperature: A second PTC polyfuse built into each Li-ion cell will open up and limit current flow as a function of very high temperatures.

Tertiary Overtemperature: A current interrupt device (CID) within each Li-ion cell will permanently open up when the temperature reaches 95C. As each cell fuse is permanently interrupted, overall battery performance will become severely degraded, up to and including disabling the battery.

Overcurrent Fuse: This is a one-time blow fuse with a rated current of 12A.

Batteries: Safe Handling and Disposal

To learn how to safely handle and dispose of the FieldFox battery, refer to the Material Safety Data Sheet for the manufacturer of the battery at:

<http://na.support.keysight.com/fieldfox/help/SupHelp/Reference/MSDS.htm>

Environmental Requirements

Refer to the FieldFox Specifications in “[Specifications/Data Sheet](#)” on [page B-3](#).

Electrical Requirements

The FieldFox allows you to use either the lithium-ion battery or the AC/DC adapter - both are included.

Electrostatic Discharge (ESD) Precautions

The FieldFox was constructed in an ESD protected environment. This is because most of the semiconductor devices used in this instrument are susceptible to damage by static discharge.

Safety Considerations
Electrostatic Discharge (ESD) Precautions

Static charges are generated in numerous ways, such as simple contact, separation of materials, and normal motions of persons working with the FieldFox. To prevent instrument damage, practice industry accepted techniques for handling static sensitive devices when using the FieldFox.

Very often, coaxial cables and antennas also build up a static charge, which, if allowed to discharge by connecting to the FieldFox, may damage the instrument input circuitry. To avoid such damage, it is recommended to dissipate any static charges by temporarily attaching a short to the cable or antenna prior to attaching to the instrument.

FieldFox Markings



The CSA mark is a registered trademark of CSA International.



The RCM Mark is a registered trademark of the Australian Communications and Media Authority.



This symbol combines the following three markings:

CE indicates product compliance with all relevant European legal Directives (if accompanied by a year, it signifies when the design was proven).

ICES indicates product compliance with the Canadian Interference-Causing Equipment Standard (ICES-001).

ISM indicates this is an Industrial Scientific and Medical Group 1 Class B product (CISPR 11, Clause 4)



The Standby symbol is used to mark a position of the instrument power line switch.



This symbol indicates separate collection for electrical and electronic equipment, mandated under EU law as of August 13, 2005. All electric and electronic equipment are required to be separated from normal waste for disposal (Reference WEEE Directive, 2002/96/EC).



Indicates the time period which no hazardous or toxic substance elements are expected to leak or deteriorate during normal use. Forty years is the expected useful life of the product.

This symbol indicates the Environmental Protection Use Period (EPUP) for the product's toxic substances and for the China RoHS requirements.



CAUTION, risk of danger, refer to safety information in manual.



Dispose of properly



Hot surface - connectors get hot during extended operation, so care must be taken when making connections and disconnections.

Battery Markings



The CE mark shows that the product complies with all relevant European legal Directives (if accompanied by a year, it signifies when the design was proven).



The battery parts can be recycled. Consult local or country regulations.



Dispose of properly. Do not throw batteries away—collect as small chemical waste.



Recycle the old battery properly. Consult local or country regulations related to disposal.



Keep battery away from excessive heat. Do not dispose of by burning.



UL recognized in Canada and the United States.

Packaging Markings



This symbol on all primary and secondary packaging indicates compliance to China standard GB 18455-2001.

AC/DC Adapter Markings



The UL Marks are registered certification marks of Underwriters Laboratories Inc. (UL). It means that UL has tested and evaluated representative samples of that product and determined that it meets UL's safety requirements. When accompanied by a 'C' and 'US', it indicates compliance to both Canadian and US requirements.



NOM Mark (Normality of Mexico) indicates that the product was tested by an accredited laboratory in Mexico and meets Mexico's safety requirements.



Japan's safety and EMC compliance mark.



China's safety and EMC compliance mark.



Taiwan's safety and EMC compliance mark.



Singapore's safety mark.



Korea's safety and EMC mark.



GOST, Russia's safety and EMC mark.

Safety Considerations
Certification and Compliance Statements



AC (Alternating Current).



Direct current (DC) equipment



CAUTION, risk of danger, refer to safety information in manual.



DC connector polarity



Dispose of properly

Certification and Compliance Statements

Certification

Keysight Technologies, Inc. certifies that this product met its published specifications at the time of shipment from the factory. Keysight Technologies, Inc. further certifies that its calibration measurements are traceable to the United States National Institute of Standards and Technology, to the extent allowed by the Institute's calibration facility, and to the calibration facilities of other International Standards Organization members.

Manufacturer's Declaration

This product has been designed and tested in accordance with accepted industry standards, and has been supplied in a safe condition. The documentation contains information and warnings that must be followed by the user to ensure safe operation and to maintain the product in a safe condition.

Declaration of Conformity

Should the Declaration of Conformity be required, visit:

<http://www.keysight.com/go/conformity>.

For more information, see **"Where to Find the Latest Information"**.

EMC

Complies with the essential requirements of the European EMC Directive as well as current editions of the following standards (dates and editions are cited in the Declaration of Conformity):

- IEC/EN 61326-1
- CISPR Pub 11 Group 1, class A
- AS/NZS CISPR 11
- ICES/NMB-001

This ISM device complies with the Canadian ICES-001.
Cet appareil ISM est conforme a la norme NMB-001 du Canada.

Safety

Complies with the European Low Voltage Directive

- IEC/EN 61010-1
- Canada: CSA C22.2 No. 61010-1
- U.S.A.: UL std no. 61010-1

South Korean Class A EMC Declaration

This equipment is Class A suitable for professional use and is for use in electromagnetic environments outside of the home.

A급 기기
(업무용 방송통신기자재)
이 기기는 업무용(A급) 전자파적합기기로서 판매자 또는 사용자는 이 점을 주의하시기 바라며, 가정외의 지역에서 사용하는 것을 목적으로 합니다.

Acoustic Statement (European Machinery Directive)

Acoustic Noise Emission

LpA <70 dB

Operator position

Normal operation position per ISO 7779

Safety Considerations
Certification and Compliance Statements

A: Connector Care Review

Proper connector care and connection techniques are critical for accurate and repeatable measurements. The following table contains for tips on connector care.

Prior to making connections to your analyzer, carefully review the information about inspecting, cleaning, and gauging connectors. For course numbers about additional connector care instruction, contact Keysight Technologies.

Handling and Storage	
Do	Do Not
<ul style="list-style-type: none"> – Keep connections clean – Extend sleeve or connector nut – Use plastic end-caps during storage 	<ul style="list-style-type: none"> – Touch mating-plane surfaces – Set connectors contact-end down – Store connectors or adapters loose
Visual Inspection	
Do	Do Not
<ul style="list-style-type: none"> – Inspect all connectors carefully – Look for metal particles, scratches, and dents 	<ul style="list-style-type: none"> – Use a damaged connector—ever
Connector Cleaning	
Do	Do Not
<ul style="list-style-type: none"> – Try compressed air first – use isopropyl alcohol^a – Clean connector threads 	<ul style="list-style-type: none"> – Use any abrasives – Get liquid into plastic support beads
Gaging Connectors	
Do	Do Not
<ul style="list-style-type: none"> – Clean and zero the gage before use – Use the correct gage type – Use correct end of calibration block – Gage all connectors before first use 	<ul style="list-style-type: none"> – Use an out-of-specification connector
Making Connectors	
Do	Do Not
<ul style="list-style-type: none"> – Align connectors carefully – Make preliminary connection contact lightly – Turn only the connector nut – Use a torque wrench for final connection 	<ul style="list-style-type: none"> – Apply bending force to connection – Over Tighten preliminary connection – Twist or screw any connection – tighten past torque wrench "break" point
<p>a. Cleaning connectors with alcohol shall only be done with the DC power cord removed, in a well-ventilated area, and with the power to the FieldFox turned OFF. Allow all residual alcohol moisture to evaporate, and the fumes to dissipate prior to energizing the instrument.</p>	

B: Specifications/Data Sheet

To ensure the highest accuracy and consistency, the FieldFox Specifications are now stored ONLY at:

<http://literature.cdn.keysight.com/litweb/pdf/N9912-90006.pdf>

C: Instrument Calibration

Over time, the active components in the FieldFox age and the performance may degrade or drift. To ensure that the FieldFox is performing to the published specifications, you should have an instrument calibration performed periodically.

How Often Should Calibrate My Instrument?

You determine the calibration period which best meets your requirements. However, a 12 month calibration cycle is appropriate for most users.

There are two things to consider: performance drift and connector wear.

The instrument specifications are set to consider the performance drift that may occur over a 12 month period. Therefore, getting the instrument calibrated at 12 month intervals ensures that the analyzer maintains performance within the operating specifications. If you need the analyzer to maintain more consistent operation, you may want to have the instrument calibrated more often.

Connector wear is a bigger factor and depends on the number of connections that are made. The test ports become noticeably worn after 500 to 700 connections. This could represent about 12 months with average use. With more frequent connections, the calibration cycle should be sooner. You can extend the time between calibrations and thereby save money by using connector savers and by performing proper Connector Care. Learn more in [Appendix A: "Connector Care Review,"](#).

How do I Get an Instrument Calibration?

To get your Keysight instrument calibrated, send it to one of the Keysight Technologies service centers. Please visit this website to learn how:

www.keysight.com/find/calibration.

What Are My Choices of Instrument Calibration?

The following types of instrument calibration are available from Keysight Technologies service center:

Keysight Calibration	Includes the test data from the calibration and the certificate of calibration, stating the instrument has been calibrated and is operating within the published specifications.
ANSI Z540 Calibration	Includes the test data from the calibration and the certificate of calibration, stating the instrument has been calibrated using a process in compliance with ANSI Z540.1 and is operating within the published specifications.
ISO 17025 Calibration	Includes the test data from the calibration and the certificate of calibration, stating the instrument has been calibrated using a process in compliance with ISO 17025 and is operating within the published specifications. Chapter 3, “CAT (Cable and Antenna Test) Mode.”

D: Korean Battery Safety Translation

외장 배터리에 대한 안전 사항

배터리 관리:

부풀어오름 (스웰링), 배터리 셀의 균열, 유체의 누수와 같은 상태 악화의 증상이 나타나는지, 주기적으로 배터리를 검사하십시오. 상태가 악화될 경우, 배터리를 교체하고 올바르게 배터리를 처분하십시오. 20-7 페이지의 “리튬 이온 배터리 폐기처분법”을 참조하십시오. 상태가 나쁜 배터리를 사용하여 구동할 경우 FieldFox에 악영향을 끼칠 수 있습니다. 더 알아보려면 21-6 페이지의 “배터리 관련”을 참조하십시오.

리튬 이온 배터리 폐기처분법:

적절한 재충전을 거쳤음에도 충전 용량이 대폭 감소한 경우, 배터리를 교체하는 것이 권장됩니다. 리튬 이온 배터리는 적절한 방법으로 폐기되어야 합니다. 배터리의 환경 친화적 수거, 재활용, 폐기 처분에 관련된 내용에 대해 알아보려면 지역 폐기물 관리 시설에 문의하십시오. 국가별로 적용되는 규제가 다를 수 있습니다. 거주지 규정에 따라 배터리를 처분하십시오. Keysight Technologies에서는 미합중국과 캐나다 지역에서 Rechargeable Battery Recycling Corporation (RBRC)를 경유하여 무료로 편리한 배터리 재활용 옵션을 제공하고 있습니다. 근처 재활용 시설의 위치를 알아보려면 877-2-RECYCLE (877.273.2925)로 전화하시거나 인터넷을 통해 <http://www.call2recycle.org/> RBRC에 문의하십시오.

배터리 관련:

리튬 배터리 팩은 잘못된 환경에 노출될 경우 발열이 발생하거나, 폭발하거나, 발화하여 심각한 상해를 발생시킬 수 있습니다. 다음 안전 경고를 주의깊게 따라 주십시오.

경고:

리튬 이온 배터리:

- 고온 (>70°C) 또는 화재에 노출되어서는 안 됩니다.
- 어린이들이 취급하지 않도록 해 주십시오.
- 합선되지 않도록 해 주십시오.
- Keysight에서 검증한 리튬 이온 배터리로만 교환되어야 합니다.
- 부적절하게 교환하거나 충전된 경우, 폭발의 위험이 있습니다.

- | 배터리의 음극과 양극을 금속제 물질(전선 등)으로 서로 연결하지 마십시오.
- | 배터리를 목걸이, 머리핀 또는 다른 금속제 물질과 같이 보관하거나 운반하지 마십시오.
- | 배터리에 직접적으로 납땜하지 마십시오.
- | 배터리를 물이나 소금물에 노출하거나, 배터리가 습기에 노출되게 하지 마십시오.
- | 배터리를 분해하거나 개조하지 마십시오. 배터리에는 안전 보호 장치가 장착되어 있으며, 이것이 손상될 경우 배터리 발열, 폭발, 발화의 원인이 됩니다.
- | 배터리를 직사광선에 노출하거나, 더운 날씨에 배터리를 차 내부에 보관하지 마십시오. 배터리가 발열, 폭발, 또는 발화할 수 있습니다. 이러한 방식으로 배터리를 사용하면 또한 성능의 감소와 생명 주기의 단축이 발생할 수 있습니다.
- | 배터리가 올바르게 교체된 경우, 폭발의 위험이 있습니다.
- | 동일하거나 일치하는 종류의 배터리로만 교체할 것을 권장합니다.
- | 배터리를 폐기할 때에는 제조사의 지시에 따르십시오. 내부에서 배터리를 충전할 경우 FieldFox의 전원이 꺼져 있는 상태라 할지라도 FieldFox에서 발열이 발생할 수 있습니다.
- | 적절한 환기는 허용됩니다.
- | 이 배터리를 FieldFox 또는 외장 배터리 충전기(N9910X-872) 이외의 장비를 사용하여 방전하지 마십시오.
- | 배터리가 기술되어 있지 않은 장비에 사용될 경우, 배터리가 손상되거나 수명이 단축될 가능성이 있습니다. 해당 장비가 전류를 비정상적으로 흘려보낼 경우, 배터리에 발열이 발생하거나, 폭발하거나, 발화하여 심각한 부상을 입힐 수 있습니다.

배터리: 안전한 사용 및 처리

FieldFox 배터리를 안전하게 사용하고 처리하는 방법에 대해 알아보려면, 제조사에서 제공하는 배터리의 물질안전보건자료(MSDS)를 참조하십시오:

<http://na.support.keysight.com/fieldfox/help/Reference/MSDS.htm>

E: Keysight Software End-User Licensing Agreement
(EULA)

KEYSIGHT SOFTWARE END-USER LICENSE AGREEMENT

ATTENTION: THIS SOFTWARE IS SUBJECT TO THE END-USER LICENSE AGREEMENT (“EULA”) SET FORTH BELOW. TO INSTALL OR USE THE SOFTWARE, YOU MUST FIRST AGREE TO THE EULA BELOW. IF THE EULA IS PRESENTED TO YOU ELECTRONICALLY AND IF YOU HAVE READ, UNDERSTAND AND AGREE TO BE BOUND BY THE TERMS OF THE EULA, CLICK “AGREE”. IF THE EULA IS PRESENTED TO YOU IN A HARD COPY FORMAT, BY POWERING ON AND USING THE INSTRUMENT OR MACHINE, YOU AGREE THAT YOU HAVE READ, UNDERSTAND AND AGREE TO BE BOUND BY THE TERMS OF THE EULA.

1. **Translations.** Translations of this EULA are found at: www.keysight.com/find/sweula.

2. **Software.** “Software” means a single copy of one or more computer programs, whether stand-alone or bundled with other products, and related documentation, including any online or electronic documentation, data and license files.

3. **License Grant.** Keysight Technologies, Inc. (“Keysight”) grants you a limited, non-exclusive license to use, in accordance with one of the license types listed below, the Software, for the Term (as defined below), subject to the terms and conditions herein:

3.1 **Node Locked (“fixed”) license.** If you have obtained a Node Locked license, you may install one copy of the Software on one instrument or machine and use the Software only on that instrument or machine for your internal business use.

3.2 **Transportable license.** If you have obtained a Transportable license, you may use one copy of the Software on any single instrument or machine at one time for your internal business use. You may move such Software to a different instrument or machine for your internal business use provided only one copy is in use at any one time.

3.3 **Floating (“concurrent use”) license.** If you have obtained a Floating license, you may install one or more copies of the Software on any instrument or machine within your internal computer network for your internal business use provided the total number of users who are accessing and/or using any of the Software at the same time does not exceed the maximum number of licensed users.

You may find the type of license you obtained, the Term of your license, and the licensed number of users (if applicable) in documentation associated with the Software. “Term” means either a set amount of time (an expiring license) or a Perpetual license. “Perpetual” means the lifetime of the instrument or machine. In the absence of documentation specifying the applicable license, you have a fixed license with a Perpetual Term.

4. **License Restrictions.**

4.1 **No Copies.** You may not make copies or adaptations of the Software except for backup and archival purposes or when copying or adaptation is an essential step in the licensed use of the Software including correction of errors. You must reproduce all copyright and other legal notices in the original Software on all permitted copies or adaptations. You may not copy the Software onto any public or distributed network.

4.2 **No Reverse Engineering.** You may not decompile, reverse engineer, disassemble, attempt to derive the source code of, decrypt, modify, or create derivative works of the Software (except to the extent any foregoing restriction is prohibited by applicable mandatory law or by licensing terms governing the use of open source components that may be included with the Software).

4.3 **No Circumvention.** The Software may include technological measures, whether in the Software or in bundled hardware or both, that are designed to prevent or detect unlicensed use of the Software. Circumvention of these technological measures is prohibited, except as expressly permitted by applicable law. Any attempt to circumvent technological measures may render the Software or certain features unusable or unstable, and may prevent you from updating or upgrading the Software.

4.4 **Limited Use.** Notwithstanding anything to the contrary herein, you may not use Software to make or distribute your own or a third party’s application, a principal purpose of which, as reasonably determined by Keysight, is to perform the same or similar functions as the Software or which replaces any component of the Software.

5. **Third Party Software.**

5.1 **General.** The Software may contain third party software subject to third party notices and/or additional terms and conditions. Such required third party software notices and/or additional terms and conditions can be found in the documentation associated with the Software. You have all rights necessary to use the Software as permitted in Sections 3 and 4. To the extent your use exceeds the grants and restrictions in Sections 3 and 4, third party license terms take precedence and will apply.

5.2 **Separation of Components.** Except as required by included open source software licenses, the Software is licensed as a single product and its component parts may not be separated for any other use except to the extent expressly otherwise licensed.

5.3 **Additional Terms for Microsoft Windows Embedded Software.** Microsoft Windows for Embedded Systems may be included with the instrument or machine. If so, your grant under this license prohibits accessing or using any Desktop Functions other than through, in support of and operating as part of the software and/or functions that provide the primary functionality of the instrument or machine.

“Desktop Functions” means consumer or business tasks or processes, including word processing, spreadsheets, database, scheduling and personal finance.

6. **Upgrades.** This EULA does not entitle you to receive upgrades, updates or technical support. Upgrades, updates and technical support services may be purchased separately. The terms of this EULA govern any software updates or upgrades provided by Keysight unless replaced and/or supplement Software is accompanied by a separate license agreement in which case the terms of that license agreement will govern. Any comments, suggestions, improvements or other communications from you to Keysight regarding the Software (“Feedback”) may be used by Keysight without compensation or attribution.

7. **Ownership.** The Software and all copies thereof are licensed and not sold to you. The Software and all copies thereof are owned and copyrighted by Keysight or its third party suppliers and protected by copyright laws and other intellectual property laws and treaties. Keysight and its third party suppliers retain all right, title and interest in the Software. Keysight and its third party suppliers may protect their respective rights in the Software in the event of any violation of this EULA.

8. **High Risk Activities.** The Software is not specifically written, designed, manufactured or intended for use in the planning, construction, maintenance or direct operation of a nuclear facility, nor for use in on line control or fail safe operation of aircraft navigation, control or communication systems, weapon systems or direct life support systems.

This information is subject to change without notice. © Keysight Technologies, 2013 – 2015 Published in USA, February 1, 2017 www.keysight.com

Keysight Software End-User Licensing Agreement (EULA)

5991-3402 (supersedes 5991-3402-14Dec2015)

9. Transfer. You may not sell or otherwise transfer the Software except as expressly specified below. Licensed users are Licensee's employees, authorized agents, representatives, and subcontractors acting on behalf of Licensee for Licensee's internal business use. You may not rent, lease, lend, allow for commercial time sharing, or otherwise permit access to the Software to any unlicensed third party or entity. You may not transfer the license granted to you here unless you obtain Keysight's prior written authorization, deliver all copies of the Software to the transferee along with this EULA, and pay any applicable fees. For all transfers, the transferee must accept this EULA as a condition to any transfer and your license to use the Software will terminate upon transfer. Entitlement to receive technical support services for the Software may be transferred provided that you obtain Keysight's prior written consent and pay any applicable fees. This section regarding transfer applies only to the extent permissible under applicable mandatory laws.

10. Term and Termination. This EULA shall continue for the Term unless terminated by Keysight as provided herein. Keysight may terminate this license upon notice for breach of this EULA. Upon expiration or termination, you must immediately destroy all copies of the Software.

11. Export Requirements. If you export, re-export or import Software, technology or technical data licensed hereunder, you assume responsibility for complying with applicable laws and regulations and for obtaining required export and import authorizations. Keysight may terminate this license immediately if you are in violation of any applicable laws or regulations.

12. Audit and Security Mechanisms. You agree that Keysight may restrict the number of copies you are using by security servers, security keys/modules, a hardware lock device, license administration software, a license authorization key to control access to the Software or other security mechanism and you consent to such use. You may not take any steps to avoid or defeat the purpose of any such measures. Use of the Software without the lock device or authorization key provided by Keysight is prohibited. Keysight may take all legal steps to eliminate unlicensed use and piracy of their Software. In this context, the Software may include a security mechanism to detect installation or use of unlicensed copies of the Software, and collect and transmit data about suspected unlicensed copies. Data collected does not include any customer data created with the Software. By using the Software, you consent to such detection and collection of data, as well as its transmission and use if suspected unlicensed copies are detected. Upon reasonable notice and reasonable suspicion of unlicensed use, Keysight may conduct during normal business hours (with the auditor's costs being at Keysight's expense) an audit of your compliance with this EULA. If an audit reveals underpayments then you will pay to Keysight such underpayments. If underpayments discovered exceed five (5) percent of the contract price, you will reimburse Keysight for the auditor costs.

13. U.S. Government Rights. The Software is "commercial computer software," as defined by Federal Acquisition Regulation ("FAR") 2.101. Pursuant to FAR 12.212 and 27.405-3 and Department of Defense FAR Supplement ("DFARS") 227.7202, the U.S. government acquires commercial computer software under the same terms by which the software is customarily provided to the public. Accordingly, Keysight provides the Software to U.S. government customers under its standard commercial license, which is embodied in this EULA. The license set forth in this EULA represents the exclusive authority by which the U.S. government may use, modify, distribute, or disclose the Software. This EULA and the license set forth herein, does not require or permit, among other things, that Keysight: (1) Furnish technical information related to commercial computer software or commercial computer software documentation that is not customarily provided to the public; or (2) Relinquish to, or otherwise provide, the government rights in excess of these rights customarily provided to the public to use, modify, reproduce, release, perform, display, or disclose commercial computer software or commercial computer software documentation. If you are a U.S. government customer, you acknowledge that you have reviewed the Software and the terms of this EULA and agree that the license provided for herein is consistent with Federal law and otherwise satisfies the U.S. government needs. In addition, if you are a U.S. government customer you agree that this EULA reflects the entirety of the terms of Keysight's customary commercial license applicable to U.S. government customers. No additional government requirements beyond those set forth in this EULA shall apply, except to the extent that those terms, rights, or licenses are explicitly required from all providers of commercial computer software pursuant to the FAR and the DFARS and are set forth specifically in writing elsewhere in this EULA. Keysight shall be under no obligation to update, revise or otherwise modify the Software.

14. WARRANTY. TO THE EXTENT ALLOWED BY APPLICABLE MANDATORY LAW, AND EXCEPT TO THE EXTENT KEYSIGHT HAS PROVIDED A SPECIFIC WRITTEN WARRANTY APPLICABLE TO THIS SOFTWARE, THIS SOFTWARE IS PROVIDED TO YOU "AS IS" WITHOUT WARRANTIES OR CONDITIONS OF ANY KIND, WHETHER ORAL OR WRITTEN, EXPRESS OR IMPLIED. KEYSIGHT, ON BEHALF OF ITSELF ITS SUBSIDIARIES, AFFILIATES AND SUPPLIERS SPECIFICALLY DISCLAIMS ANY IMPLIED WARRANTIES OR CONDITIONS OF MERCHANTABILITY, SATISFACTORY QUALITY, NON-INFRINGEMENT AND FITNESS FOR A PARTICULAR PURPOSE. SHOULD THE SOFTWARE PROVE DEFECTIVE, YOU ASSUME THE ENTIRE RISK AND COST RESULTING FROM OR RELATING TO THE DEFECT. SOME JURISDICTIONS DO NOT ALLOW EXCLUSIONS OF IMPLIED WARRANTIES OR CONDITIONS, SO THE ABOVE EXCLUSION MAY NOT APPLY TO YOU. YOU MAY HAVE OTHER RIGHTS THAT VARY ACCORDING TO APPLICABLE MANDATORY LAW.

15. LIMITATION OF LIABILITY. TO THE EXTENT ALLOWED BY APPLICABLE MANDATORY LAW, IN NO EVENT WILL KEYSIGHT OR ITS SUBSIDIARIES, AFFILIATES OR SUPPLIERS BE LIABLE FOR ANY SPECIAL, INCIDENTAL, CONSEQUENTIAL OR OTHER DAMAGES (INCLUDING DOWNTIME COSTS, LOSS OF DATA, RESTORATION COSTS OR LOST PROFITS) REGARDLESS OF WHETHER SUCH CLAIMS ARE BASED ON CONTRACT, TORT, WARRANTY OR ANY OTHER LEGAL THEORY, EVEN IF ADVISED OF THE POSSIBILITY OF SUCH DAMAGES. YOUR USE OF THE SOFTWARE IS ENTIRELY AT YOUR OWN RISK. NOTWITHSTANDING THE FOREGOING, IN THE EVENT THE SOFTWARE IS PROVIDED TO YOU AT NO CHARGE, KEYSIGHT OR ITS SUBSIDIARIES, AFFILIATES OR SUPPLIERS SHALL HAVE NO LIABILITY FOR DIRECT DAMAGES. SOME JURISDICTIONS DO NOT ALLOW THE EXCLUSION OR LIMITATION OF LIABILITY FOR DAMAGES, SO THE ABOVE LIMITATION MAY NOT APPLY TO YOU.

16. Applicable Law. Disputes arising in connection with this EULA will be governed by the laws of the United States and of the State of California, without regard to choice of law provisions. The United Nations Convention for Contracts for the International Sale of Goods will not apply to this EULA.

17. Unenforceability. To the extent that any provision of this EULA is determined to be illegal or unenforceable, the remainder of this EULA will remain in full force and effect.

18. Entire Agreement. Certain program, data and license files in the Software may be subject to supplemental license terms found in the documentation associated with the Software or directly in the files to which the supplemental terms apply. This EULA constitutes the entire

Keysight Software End-User Licensing Agreement (EULA)

agreements between the parties, whether oral or written, except if you have a separate written, valid agreement that is executed by both parties and the terms of such agreement conflict with the terms contained herein, in which case the terms of such agreement apply. This EULA may not be changed except by an amendment signed by an authorized representative of each party.

This information is subject to change without notice. © Keysight Technologies, 2013 – 2015 Published in USA, February 1, 2017 www.keysight.com
5991-3402 (supersedes 5991-3402-14Dec2015)

This information is subject to change without notice. © Keysight Technologies, 2013 – 2015 Published in USA, February 1, 2017 www.keysight.com

Index

Symbols

, 21-13

Numerics

- 1-port cable loss measurements
 - CAT mode, 3-12
- 1-port cable loss, CAT mode, 3-13
- 1-Port Cable Trimming VVM Measurements, 14-9
- 1-Port Cable Trimming, VVM measurements, 14-1
- 2-port insertion loss measurements, 14-9
 - CAT mode, 3-14
- 2-port insertion loss measurements, CAT mode, 3-14
- 2-port transmission measurements
 - VVM mode, 14-11
- 2-port transmission measurements, VVM mode, 14-11

A

- AC/DC adapter, 21-1
 - , 21-13
 - power requirements, 2-1
 - using, 20-3
- accessories, 1-3
- Adjacent Channel Power (ACPR), 8-42
- Alias Faults, 4-26
- all about markers, 16-2
- AM FM Tune & Listen, 8-16
- Antenna Corrections, 8-12, 8-13
- appendix B, A-1, B-3
- attenuation, 8-10
- Audio Beep, 8-35
- Average Type, 8-29
- Averaging

- VVM, 14-7
- averaging, 3-6, 5-11
 - VVM, 14-7
- avoid overpowering, 2-5

B

- Band Power Marker SA mode, 8-33, 16-13
- bandpass mode, 4-20
- battery
 - care, 20-6
 - charge status, viewing, 20-1
 - charge status, viewing, 18-2, 20-1
 - charging, 2-3
 - external, 20-5
 - internal, 20-3
 - disposal, 20-7
 - gauge, 20-2
 - icons, 20-1
 - installing, 2-2
 - LED, 20-5
 - markings, 21-12
 - maximizing life, 20-6
 - protective functions, 21-7
 - safe handling, 21-9
 - saver, 18-10
 - service diagnostics, 20-2
 - viewing charge status, 2-2

- Big Marker IStates, 5-17, 5-18
- big marker states, 5-17, 5-18
- bridge cancellation measurements, VVM mode, 14-11
- brightness display, 18-5

C

- Cable (Correction) Specifications
 - DTF, 4-22
- cable and antenna test See CAT

- cable loss measurements, 3-12, 3-13
- cable specifications, DTF, 4-23
- Cal On ?, 7-6, 7-8
- Calculated DTF values, 4-26
- calibration
 - Cal On ?, 7-6, 7-8
 - CAT and NA modes, 7-1
 - verifying integrity, 7-10
- CalReady, 7-3
 - properties, 7-8
- CalReady Properties, 7-8
- care of the battery, 20-6
- CAT mode
 - 1-port cable loss measurements, 3-12
 - 2-port insertion loss measurements, 3-14
 - calibration, 7-1
 - DTF settings, 4-19, 5-3, 6-3
 - return loss measurements, 3-12
 - settings, 3-3, 10-2, 10-3
- CAT mode measurements, 10-1
- certification statements, 21-14
- Channel Power (CHP), 8-38
- channel scanner, option 312, 15-1
- Channel Selection, 8-7
- charge status, viewing, 18-2, 20-1
- charging the battery
 - externally, 20-5
 - internally, 20-3
- cleaning the screen, 2-9
- colors, display, 18-5
- compliance statements, 21-14
- compressed measurement, 8-11
- Compressed SA Measurements, 8-11
- connector care review, A-1
- considerations, safety, 21-1
- control, temperature, 2-5

- Coupled Frequency, 3-11, 4-21, 7-8
- Coupled Markers, 16-5
- CPM, 10-1
- cursor moving, 17-9
- cursor, moving, 17-4, 17-9, 17-10
- D
- data analysis features, 16-1, 17-1
- data indicator (*), old, 8-35
- data indicator, old (*), 8-35
- Date and Time Setting, 18-16
- declaration of conformity, 21-14
- delta marker, 16-3, 16-4
- delta markers, 16-3
- Detection Method, 8-30
- detection method, 8-30
- display
 - brightness, 18-5
 - colors, 18-5
 - front panel, 2-12
 - preferences, 18-9
 - settings, 18-5
- display "live" and memory traces, 13-14
- Display Resolution
 - VVM, 14-5
- disposal of battery, 20-7
- dissipate static charge, 2-6
- DTF
 - measurements, 4-17, 4-18
 - settings, 4-19, 5-3, 6-3
 - start and stop distance, 4-18
- DTF Measurement, 4-19
- DTF settings, 4-19
- DTF Start and Stop
 - Distance, 4-20
- Dynamic Range, 5-20
- dynamic range, 5-20
- E
- Edit a Cable File, 4-23
 - DTF, 4-23
- edit keywords, 17-9
- edit, enable and disable the current prefix, 17-10
- edit, enable and disable the current suffix, 17-10
- Electrical Delay, 5-10
- Erase User Data, 18-23
- error
 - meas UNCAL, 8-21, 8-35
 - red flashing LED, external battery charger, 20-5
 - red red flashing LED, external battery charger, 20-5
 - systematic, 7-2
- ESD, 21-9
- Event Log, 18-22
- external frequency reference, 18-15
- External Gain, 8-10
- External triggering, 8-25
- external triggering, 8-25
- external zeroing, 11-3
- F
- features, overview, 1-1
- Field Strength
 - Measurements, 8-12
- File Management, 17-1
- file management, 17-1
- files
 - managing, 17-7
 - prefixes, 17-10
 - suffixes, 17-10
- FM Tune & Listen, 8-16
- folders, 17-8
- Format
 - NA Mode, 5-7
- format, NA mode, 5-7
- FreqMaskTrigger, 9-12
- frequency
 - external reference, 18-15
 - mode, DTF, 4-20
 - range, NA mode, 5-8
 - range, setting, 3-5
 - range, step size, 8-5
 - step size, 8-5
- Frequency Counter at SA
 - Marker, 8-34, 16-13
- Frequency Offset Using Power
 - Sensor, 12-1
- Frequency Range
 - NA Mode, 5-8
- front panel, 2-7
- Full Screen Mode, 18-7
- G
- Gating, 6-10
- gating, 6-10
- gauge, battery, 20-2
- getting started information, 2-1
- GPS, 18-12
- group delay, 5-7, 5-8
- H
- high-temperature protection, 2-4
- hold, 18-2
- how to change
 - frequency step size, 8-4, 8-5
 - units to feet, 4-25
- check for a compressed measurement, 8-11
- control the preamp, 8-11
- create
 - delta marker, 16-4
 - markers, 16-2
- edit keywords, 17-9
- edit, enable and disable the current prefix, 17-10
- enter
 - numeric values, 2-14
- make
 - 1-port cable loss measurement, 3-12, 3-13
 - 2-port insertion loss measurement, 3-14
 - DTF measurements, 4-18
- manage files, 17-7
- measure return loss, 3-12
- monitor the internal FieldFox temperature, 2-4
- move
 - cursor, 17-4, 17-10
 - reference marker, 16-4
- name files, 17-3
- perform
 - normalization, 7-7
 - O, S, L cal, 7-5

- O,S, L cal, 7-5
 - single sweep while in Hold, 18-2
 - preset, 18-3
 - recall an *.sta file, 17-4
 - save
 - display settings as preferences, 18-9
 - file, 17-2
 - select
 - CAT mode, 3-3, 10-3
 - CAT mode measurements, 3-3, 10-3
 - NA formats, 5-7
 - SA mode, 8-4
 - set
 - attenuation, 8-10
 - bandpass mode ON, 4-21
 - frequency range, 3-5, 8-4
 - output power, 3-9, 3-10, 5-14, 14-6
 - power meter display units, 11-6
 - res BW, 8-20
 - resolution, 3-8, 5-13
 - scale, 3-5
 - sweep time, 3-8, 3-9
 - sweep type, 3-7, 5-13
 - trace averaging, 3-6, 3-7
 - video BW, 8-21
 - use
 - external reference, 18-15
 - view and change Quick Settings, 5-6
 - view and change quick settings, 5-5
- I
- icons, battery, 20-1
 - IF Bandwidth
 - NA Mode, 5-12
 - VVM, 14-5
 - IF bandwidth
 - NA Mode, 5-12
 - indicator (*), old data, 8-35
 - initial use, preparing for, 2-1
 - input voltages and power, maximum, 2-5
 - insertion loss measurements, 3-14
 - installing battery, 2-2
 - Interference Analyzer, 9-1
 - interference rejection, 3-10
 - Interpolation, 7-7
 - Interval Power Marker, 8-33
- K
- keywords, 17-9
- L
- LAN Settings, 18-18
 - language, settings, 18-9
 - latest information, where to find, 1-4
- LED
- battery, 20-5
 - on/off settings, 2-4
- Licensing, 18-11
- Limit Lines, 16-14
- Limit lines, 16-14
- saving and recalling, 16-17
- lithium-ion battery, installing, 2-2
- M
- Magnitude Offset, 5-9
 - magnitude offset, 5-9
 - Manage Files, 17-7
 - Manage Folders, 17-8
 - managing files, 17-7
 - folders, 17-8
 - manuals, 1-4
 - marker table, 16-4
 - Markers
 - Coupled, 16-5
 - markers, 16-2
 - Coupled (NA Mode), 16-5
 - creating, 16-2
 - delta, 16-3
 - moving, 16-2
 - search function, 16-6, 16-7
 - table, 16-4
 - trace, 16-6
 - trace (CAT & NA Mode), 16-6
 - trace (SA Mode), 16-6
- markings
- battery, 21-12
 - FieldFox, 21-11
 - packaging, 21-13
- math
- operations, 16-20
- maximizing battery life, 20-6
- maximum input voltage and power, 2-5
- maximum input voltages and power, 2-5
- Meas UNCAL error, 8-35
- meas UNCAL error, 8-21
- measurement selection, NA Mode, 5-1
- measurements
- 1-port cable loss measurements, CAT mode, 3-12
 - 1-port cable loss, CAT mode, 3-12
 - 2-port insertion loss, CAT mode, 3-14
 - bridge cancellation, VVM mode, 14-11
 - compressed, 8-11
 - return loss, 3-12
 - selection, 3-3, 10-3
 - selection, reflection, 10-3
- mini-USB port, sending SCPI commands, 19-1
- mode
- NA, 5-1
 - SA, 8-1, 8-4, 9-1, 10-1, 11-1, 12-1
 - temperature control, 2-5
 - VVM, 14-1
- move
- cursor, 17-4, 17-9, 17-10
 - reference marker, 16-4
- moving the cursor, 17-4, 17-9, 17-10
- multiplier abbreviations, 2-14
- multipliers, 2-14
- Multi-Trace Configurations, 5-4
- multi-trace configurations, 5-4

N

NA Factory Cal, 18-22
 NA mode
 calibration, 7-1
 settings, 5-3, 5-5
 name files, 17-3
 network analyzer, 5-1
 normalization, 7-7
 numeric values, 2-14
 numeric values, entering, 2-14

O

O, S, L cal. 7-5
 O, S, L calibration, 7-5
 Occupied Bandwidth, 8-40
 old data indicator (*), 8-35
 Opt 010, 6-1
 option
 010, 6-1
 option 312, channel
 scanner, 15-1
 options
 installing, 18-11
 Output Power
 NA Mode, 5-14, 14-5
 output power, 3-9, 3-10, 5-14,
 14-6
 overpowering, avoid, 2-5
 overview, 1-1

P

packaging markings, 21-13
 panel, front, 2-7
 panel, right side, 2-10
 panel, top, 2-10
 Parameter Conversion, 5-3
 peak
 criteria, 16-10, 16-11
 excursion, 16-11
 threshold, 16-11
 perform
 single sweep while in
 Hold, 18-2
 Phase Offset, 5-10
 Playback Configuration, 9-10,
 9-14
 Points SA mode, 8-27
 points, SA mode, 8-27
 Port Extensions, 5-16

power requirements, 2-1
 power requirements for the
 AC/DC adapter, 2-1
 power sensor input, 2-5, 2-11
 Power Spectral Density, 8-39
 power, maximum, 2-5
 Preferences, 18-7
 preferences, 18-7
 prefixes for file names, 17-10
 preparing for initial use, 2-1
 preset, 18-3
 preset settings, 18-3
 Printing, 17-11
 printing, 17-11
 protection, high
 temperature, 2-4
 protective functions of the
 battery, 20-2
 Pulse Measurements, 13-1

Q

Quick Settings, 5-6
 quick settings, 3-4
 QuickCal, 7-3

R

Radio Standard, 8-6
 recall an *.sta file, 17-4
 recalling files, 17-4
 Record Source, 9-13
 Record/Playback, 9-7
 Recording Configuration, 9-11
 reference marker, 16-4, 16-12
 reference, external
 frequency, 18-15
 Reflection Mode, 10-1
 resolution, 2-12, 3-8
 NA Mode, 5-13
 Resolution Band width SA
 mode, 8-20
 resolution band width, SA
 mode, 8-20
 Resolution, NA mode, 5-13
 Restart, 8-27
 restart, 8-27
 return loss measurements, CAT
 mode, 3-12
 review connector care, 2-15
 reviewconnector care, A-1
 RRC Weighting, 8-46

S

S11 measurements, NA
 mode, 5-3
 SA mode
 settings, 8-4, 9-2
 units, 8-8
 SA Mode Units, 8-8
 Safety Considerations, 21-1
 save
 display setting as
 preferences, 18-8
 file, 17-2
 save and recalling files, 17-2
 Save Preferences, 18-8, 18-9
 Scale Settings
 NA Mode, 5-8
 scale settings, NA mode, 5-8
 scale, setting, 3-5
 screen cleaning, 2-9
 screen front panel, 2-12
 Security Level, 18-16
 select
 language, 18-9
 sending SCPI commands,
 mini-USB port, 19-1
 service diagnostics, 18-22
 Sessions, 9-7
 set
 display colors, 18-5
 display units, 11-6
 output power, 14-5
 settings
 CAT mode, 3-3, 10-2, 10-3
 DTF, 4-19, 5-3, 6-3
 DTF mode, 4-19
 language, 18-9
 preset, 18-3
 SA mode, 8-4, 9-2
 VVM mode, 14-4
 smoothing, 3-7
 Source Control with USB
 Power Meter, 11-4
 S-parameters, 5-3
 Spectrogram Display, 9-2
 spectrogram display, 9-2
 spectrum analyzer mode, 8-1,
 9-1, 10-1, 11-1, 12-1
 stand-by mode, 2-3
 Startup Mode, 18-9
 static charge, dissipate, 2-6
 Step Detection Mode, 11-8

- suffixes for file names, 17-10
 - sweep
 - acquisition parameter, 8-21, 8-23
 - time, 3-9
 - time, NA mode, 5-14
 - type, 3-7, 5-13
 - type, SA mode, 8-21
 - Sweep Acquisition, 8-22
 - sweep acquisition, 8-22
 - Sweep Time
 - NA Mode, 5-14
 - Sweep Type
 - SA Mode, 8-21
 - system configuration
 - settings, 18-11
 - System Impedance (Z0), 5-15
 - System Settings, 18-1
 - systematic, 7-2
- T**
- temperature control mode, 2-5
 - Time Domain, 6-1
 - Time Zone, 18-16
 - title, editing, 17-3, 18-6, 18-7
 - top panel, 2-10
 - trace averaging, setting, 3-7
 - Trace Display States, 8-28
 - Trace Math, 12-9, 16-19
 - Trace Width, 18-6, 18-8
 - Tracking Generator, 8-18
 - Transform, 6-1
 - transform, 6-4
 - Transform Window, 6-6
 - transform window, 6-6
 - Triggering - SA Mode, 8-25
 - triggering - SA mode, 8-25
 - Tune & Listen (AM/FM), 8-16
- U**
- units, DTF, changing, 4-25
 - USB keyboard, 1-4, 10-4
 - use
 - external reference, 18-15
 - User Preset, 18-3
 - User Tags, 9-9
- V**
- values
 - multipliers, 2-14
 - numeric, 2-14
 - values, multipliers, 2-14
 - VBW, 8-21
 - vector voltmeter, 14-1
 - vector voltmeterSeeVVM, 14-1
 - Velocity Factor, 4-22, 5-17
 - verifying integrity of
 - calibration, 7-10
 - jumper cables, 7-10
 - verifying integrity of calibration
 - & jumper cables, 7-10
 - video band width, 8-21
 - Video Band width SA
 - mode, 8-21
 - Video triggering, 8-25
 - video triggering, 8-25
 - viewing
 - charge status, battery, 18-2, 20-1
 - installed options, 18-9, 18-11
 - Volume Control, 18-4
 - volume control, 18-4
 - VVM Calibration, 14-8
 - VVM mode, 14-1
 - bridge cancellation
 - measurements, 14-11
 - settings, 14-4
 - VVM mode, settings, 14-4
- W**
- Waterfall Display, 9-2, 9-5
 - where to find the latest
 - information, 1-4
 - Window Settings
 - DTF, 4-25
 - window settings, DTF, 4-25
- Z**
- zero span, 8-23, 8-24
 - Zeroing VVM mode, 14-8
 - zeroing, external, 11-3
 - zeroing, VVM mode, 14-8



This information is subject to change without notice.

© Keysight Technologies 2015-2021

Edition 2, May 2021



N9912-90001

www.keysight.com