

Leader ZEN



Version3.2

LV5600	Waveform Monitor
LV5300A	Waveform Monitor
LV5350	Waveform Monitor
LV7600	Rasterizer
LV7300	Rasterizer

Leader



LV5600

MULTI WAVEFORM MONITOR

LV7600

RASTERIZER



General

The LV5600/LV7600 is a 'True-Hybrid' waveform monitor and rasterizer compatible with 4K/HD/SD-SDI signals and UHDTV/HD/SD IP signals. The LV5600 is a waveform monitor with a 7-inch touch screen display in a compact 3 RU enclosure with built-in AC power supply. The LV7600 is a rasterizer with the same function as the LV5600 in a 1RU full rack enclosure. Selection of necessary input signals and functions from various options easily allows customization to the specification that fits your purpose.

Features

Supports widest range of input signals

The LV5600/LV7600 can monitor SDI signals up to 12G-SDI as well as IP (video over IP). Audio support can include SDI embedded Audio, Audio multiplexed to IP, external input AES/EBU, and analog Audio. In addition, the LV5600 or LV7600 can be configured to simultaneously monitor SDI and IP feeds – 'True Hybrid' monitoring for complex networks.

10G IP/25G IP input format

The LV5600/LV7600 also monitor SMPTE 2022-6 and SMPTE 2110 IP signals up to 2K/4K. Up to 4 IP flows can be joined by one 10 Gigabit or 25 Gigabit SFP, (in this context ST 2110-20, -30-, -40 is one flow). Up to 1 IP 4K flow can be joined via one 25 Gigabit SFP.

Unmatched ease of use

The front panel offers familiar, dedicated buttons and knobs for simple operation and training. Additionally, the units can be controlled via a USB mouse. The LV5600 adopts a 7-inch full HD panel with a touchscreen, and the LV7600 can be operated and set intuitively by touch operation by connecting an external touch-enabled LCD monitor with a USB cable.

* While most external touch-capable LCD monitors are compatible, not all vendors' products can be guaranteed.

Comprehensive SDI format compatibility

The LV5600/LV7600 support SD- SDI, HD- SDI, 3G- SDI, 6G-SDI, 12G- SDI single link, 3G- SDI dual link and quad link, HD- SDI quad link and a wide range of video formats.

SDI and IP analysis

For engineering and troubleshooting needs, the LV5600 and LV7600 offer monitoring of SDI transmission errors, external synchronization phase difference, lip sync, SDI signal frequency deviation, and ancillary data analysis, of growing importance in 4K video systems. For IP, transmission errors such as packet loss and Quality of Service (QoS) monitoring including packet jitter and timing allow for comprehensive network performance characterization.

Video analysis

The LV5600 and LV7600 provide a full set of video displays including waveform, vector, 5 BAR gamut, and CIE chromaticity diagram. In addition to the various displays, quality of experience (QoE) monitoring such as freeze, black, gamut, help ensure all potential issues with content are easily diagnosed.

xy chromaticity coordinate display

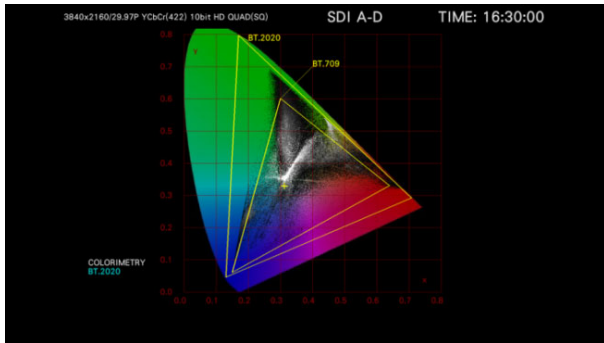

Audio analysis

Embedded SDI audio, discreet audio inputs, and IP audio flows can all be displayed and monitored using level meters, Lissajous display, mute, clip error detection, and loudness calculations. Audio format is compatible with L-PCM. Also, Dolby E, Dolby Digital, Dolby Digital Plus decode and display is available.

* Dolby and Dolby Digital, Dolby Digital Plus, Dolby E are registered trademarks of Dolby.

Eye pattern display

From SD-SDI to 12G-SDI, Full physical layer measurement of the SDI signal including eye pattern display and jitter allows for detailed engineering evaluations of SDI signal paths.

Eye pattern display

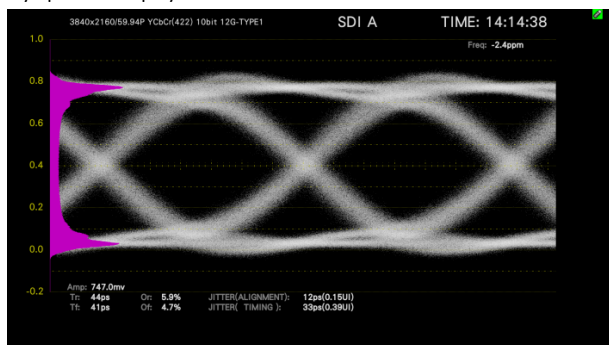

Subtitles and closed caption decode

CEA-608, CEA-708 closed captioning, Teletext, Japanese subtitles, and OP47 subtitle embedded in the SDI signal can be displayed in the video.

100% Free-form customizable layout

Users can size and position all video displays, waveforms, vectorscopes, gamut views, audio tools, etc. as desired to optimize the screen for any specific workflow or user.

SDI signal generation

A built-in generator provides SDI test signals, useful for device or network troubleshooting. The generator supports HD-SDI through 12G-SDI with HD multi format color bar and patterns, multiple overlays of moving boxes and embedded audio, flat field at any level, and a 4K multi format color bar.

External monitor output

The screen can be output to an external SDI monitor or HDMI monitor with full HD resolution.

* It does not guarantee operation with all HDMI monitors.

Capture data for analysis

Capture the display screen as still image data or use the frame capture function to capture up to 16 frames of data.

Time code display

The time code may be superimposed on SDI or IP video signals. The time code can also be used as the timestamp of the event log.

External remote terminal

The presets can be recalled by remote terminals, and users can switch input signals, tally displays or output alarms.

Ethernet connectivity

The LV5600 and LV7600 support remote operation by TELNET, file transfer by FTP, remote operation by SNMP and alarm notification, remote operation and monitoring from a web-browser via HTTP.

HDR capable

HDR signal level monitoring and luminance management accounting for OOTF is straightforward. The waveform display in HDR scale is added to the IRE scale. Furthermore, in the CINEZONE™ display, the luminance distribution of HDR and SDR in the picture can be easily confirmed, with SDR content appearing in monochrome gray scale while HDR is colored according to the brightness.

Focus assist

We developed a new focus detection algorithm based on proprietary nonlinear super-resolution technology; accordingly, focus is determined with high sensitivity and repeatability even with difficult, low-contrast images.

Tally display

Serial communication allows display of camera ID, iris and tally.

Lip sync

This function measures the time difference between the SDI video signal and embedded audio signal or between the SDI video signal and AES/EBU digital audio signal and shows measurements as a value and on a graph.

Audio bars display

This function displays the embedded audio level on a bar graph, and is included without the audio option enhanced displays.

External synchronization signal input with waveform display

This function allows you to graphically check the phase difference and synchronization state of SDI and IP video signals based on the external reference signal (black burst, tri-level sync). This function also allows you to display the waveform of the external reference signal input, which is useful for quickly discovering problems caused by an external reference signal.

Black burst display

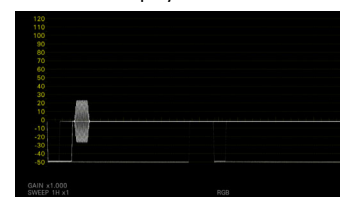

Tri-level sync display

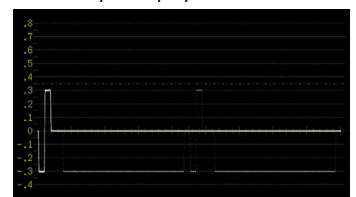

■ List of hardware options

Model Name	Type Number		Function
	LV5600	LV7600	
SDI INPUT	LV5600-SER01		SD, HD, 3G SDI input *1
SDI INPUT/EYE	LV5600-SER02A		SD, HD, 3G SDI input and eye pattern display *1
DIGI/ANA AUDIO	LV5600-SER03	LV7600-SER03	Digital/analog Audio input/output and display
DOLBY	LV5600-SER04	LV7600-SER04	Dolby Digital, Dolby E decode function *2,3
10G IP INPUT	LV5600-SER05	LV7600-SER05	10G IP input *1
25G IP INPUT	LV5600-SER06	LV7600-SER06	25G IP input *1,*4

- *1 The LV5600 requires the LV5600-SER01, LV5600-SER02A, LV5600-SER05, or LV5600-SER06 to be installed.
The LV7600 requires the LV5600-SER01, LV5600-SER02A, LV7600-SER05, or LV7600-SER06 to be installed.
The LV5600-SER01 and LV5600-SER02A cannot be installed in the instrument at the same time.
The LV5600-SER05 and LV5600-SER06 cannot be installed in the instrument at the same time.
The LV7600-SER05 and LV7600-SER06 cannot be installed in the instrument at the same time.
- *2 You need the LV5600-SER03 to install the LV5600-SER04 in the LV5600.
You need the LV7600-SER03 to install the LV7600-SER04 in the LV7600.
- *3 Decodes up to 7.1 channels
- *4 For 4K, only a single stream is supported. You also need the SER28.

■ List of Software options

Model Name	Type Number		Function
	LV5600	LV7600	
HDR	LV5600-SER23	LV7600-SER23	HDR measurement function
TSG	LV5600-SER24	LV7600-SER24	SDI signal generation function *1
FOCUS ASSIST	LV5600-SER25	LV7600-SER25	Focus assist display Function
LAYOUT	LV5600-SER26	LV7600-SER26	Customized layout, display assignment function
TALLY	LV5600-SER27	LV7600-SER27	ID/iris/tally display function
4K	LV5600-SER28	LV7600-SER28	4K video signal correspondence function *2
12G-SDI	LV5600-SER29	LV7600-SER29	6G/12G-SDI compatible *2
VIDEO NOISE METER	LV5600-SER30	LV7600-SER30	Video noise measurement function
COLORIMETRY ZONE	LV5600-SER31	LV7600-SER31	Colors outside the color gamut display function
25G IP TSG	LV5600-SER32	LV7600-SER32	25G IP signal generation function *3
EXTENDED VEC	LV5600-SER40	LV7600-SER40	Extended vector display function

- *1 You need the LV5600-SER28 to output 4K patterns (other than 12G and 6G) on the LV5600-SER24.
You need the LV7600-SER28 to output 4K patterns (other than 12G and 6G) on the LV7600-SER24.
- *2 You need the LV5600-SER28 to install the LV5600-SER29 in the LV5600.
You need the LV7600-SER28 to install the LV7600-SER29 in the LV7600.
- *3 You need the LV5600-SER06 to install the LV5600-SER32 in the LV5600.
You need the LV7600-SER06 to install the LV7600-SER32 in the LV7600.

■ Related accessories

Product Name	Model	Related products		Remarks
		LV5600	LV7600	
RACK-MOUNT ADAPTER	LR2561	○	—	LR2561 is a rack mount adapter that allows two LV5600s to be mounted side by side or an LV5600 and LV5350 or LV5300A to be mounted side by side in an EIA 19-inch rack. *
BLANK PANEL	LC2566	○	—	The LC2566 is a blank panel for the LR2561 rack mount adapter.
SFP+ MULTI-MODE	LC2148	SER05/06	SER05/06	10GE, 850nm, 10GBASE-SR/SW
SFP+ SINGLE-MODE	LC2145	SER05/06	SER05/06	10GE, 1310nm, 10GBASE-LR/LW
SFP28 MULTI-MODE	LC2151	SER06	SER06	25GE, 850nm, 25GBASE-SR/SW
SFP28 SINGLE-MODE	LC2147	SER06	SER06	25GE, 1310nm, 25GBASE-LR/LW
REMOTE CONTROLLER	LV7290	○	○	One remote controller can be connected up to 8 units of waveform monitor or rasterizer via Ethernet. .

- * Please be advised that the LV5350 and LV5300A can only be installed on the right side of the LR2561.

LV5600-SER01 SDI Input

LV5600-SER02A SDI Input with eye pattern

LV5600-SER01 option accepts a wide range of SDI signals.
(LV5600, LV7600 both can accept this option)

Video analysis

With SER01 or SER02A, the LV5600 and LV7600 provide a full set of video displays including waveform, vector, 5 BAR gamut, CINELITE™ II, and CIE chromaticity diagram. In addition to the various displays, quality of experience (QoE) monitoring such as freeze, black, gamut, help ensure all potential issues with content are easily diagnosed.

Audio support

Embedded SDI audio can be displayed on meters for basic level and presence monitoring.

Approved standard SMPTE ST 299, SMPTE ST 272
48 kHz/24 bit/L-PCM

Synchronization All are synchronized with the video clock.
All input SDI signals are synchronized.

*Lissajous, surround, loudness and status can be displayed by adding LV5600-SER03/LV7600-SER03

SDI data analysis

The status display summarizes CRC and embedded audio errors in the SDI signal. An event log, data dump, and phase difference measurements can be used to troubleshoot.

SDI status display

STATUS		SDI A		TIME: 10:33:22	
Signal	Format	Freq.	Cable	Embedded Audio	
A CH	DETECT	1920x1080/59.941 HD		-0.0ppm	1,2,3,4,5,6,7,8,9,10,11,12,13,14,15,16

ERROR		A CH		ANC		A CH	
SDI	0	CRC	0	Check Sum	0		0
TRS Position	0	Parity	0				0
TRS Code	0						
Illegal Code	0						
Line Number	0						

Embedded Audio		A CH		Video Quality		A CH	
BCH	0	Freeze	0				0
Parity	0	Black	0				0
DBN	0	Gamut	0				0
Intact	0	One Gamut	0				0
Audio Sample	0	Level Y	0				0
		Level C	0				0

SinceReset 00:00:36

Screen capture

SER01/02 include a screen capture function to capture the display screen as still image data as well as a frame capture function to capture 16 frames of data. The screen capture can be saved in BMP format to allow for simplified sharing of problem signals.

Frame capture

The frame capture can be triggered manually, or on a predetermined error condition. Free Windows™ software allows for detailed search and data export.

*Only one frame is captured when an error occurs.

Time code display

Embedded time code data can be verified and displayed. The time code can also be used as the timestamp of the event log.

SDI inputs and outputs

Four (4) BNC SDI inputs
Four (4) BNC SDI outputs

Re-clocking: The input SDI signal is re-clocked to the outputs, respectively.

*Output terminal 1 can switch the signal of the input terminal and can re-clock output.

*LV5600-SER24 and LV7600-SER24 are required for signal generation function.

Closed caption display

Embedded CEA-608, CEA-708 closed captioning, Teletext, OP47 subtitle can be decoded and displayed.

Superimpose Display

Displays English closed captions, European closed captions, and Japanese closed captions over the picture

English Closed Caption

Compliant Standards (Mapping Standards)

EIA-708	SMPTE ST 334
EIA/CEA-608-B (EIA-708-B)	SMPTE ST 334
EIA/CEA-608-B (EIA/CEA-608-B)	SMPTE ST 334
VBI (EIA/CEA-608-B Line21)	CIA/EIA-608-B

Supported Video Formats

SD, HD, 3G-A, 3G-B-DL,
HD(DL) (close caption decoding only for link A),
3G(DL)-4K (close caption decoding only for link 1),
HD(QL) (close caption decoding only for link 1),
3G(QL) (close caption decoding only for link 1),
6G (close caption decoding only for sub 1),
12G (close caption decoding only for sub 1)

European Closed Caption

Compliant Standards

Teletext

VBI (ITU-R BT.653-3 System B) (SD only) / OP47

Simple Japanese Closed Caption Display

Displays a simple Japanese closed caption on the picture display. (Select HD, SD, analog, or portable closed caption to display. Select language 1 or 2.)

Compliant Standard ARIB STD-B37 short form data

Supported Video Formats

SD, HD, 3G-A,
HD(DL) (close caption decoding only for link A),
3G(DL)-4K (close caption decoding only for link 1),
HD(QL) (close caption decoding only for link 1),
3G(QL) (close caption decoding only for link 1),
12G (close caption decoding only for sub 1)

Display

Display position control is supported only for HD and SD closed captions.

Characters

Only Kanji, roman numerals, katakana, hiragana, additional characters (ARIB STD-B24), additional kanji (ARIB STD-B24), and 1-byte DRCS are displayed.

Character Sizes

Supports only standard, medium, small, and specified size Codes

Logging

Logged Events

Clear screen command, text closed caption display event, time code, TV commercial material check result

Data Format Text

*1 You need the LV5600-SER28, LV7600-SER28 to 3G (DL)-4K.

*2 You need the LV5600-SER28 and SER29, LV7600-SER28 and SER29 to 6G/12G.

Closed caption display

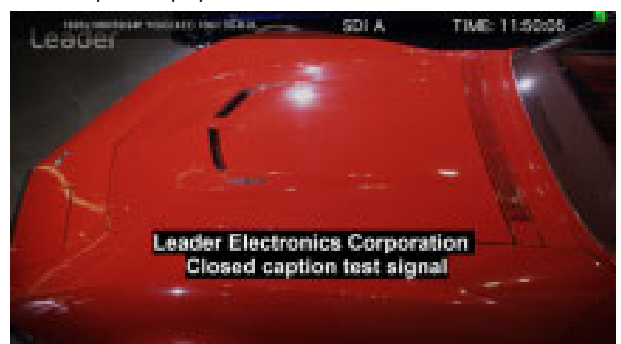

CIE chart display

This is a chromaticity display of ITU-R BT. 601, ITU-R BT. 709, ITU-R BT. 2020 colorimetry. The display mode supports CIE 1931 (xy display) and CIE 1976 (u'v' display). Since the CIE chart can display two color gamuts, the tool can be used to suppress the color gamut of BT.709 using the equipment compatible with BT.2020, and to confirm the content that exceeds the color gamut of BT.709. In color display, the chromaticity point is displayed using the color (on the picture) in the video signal. The chromaticity point can be measured at the point with the cursor.

xy chromaticity coordinate display

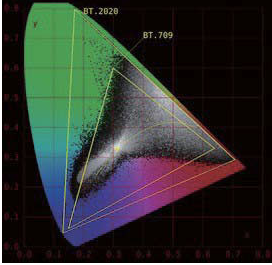

u'v' chromaticity coordinate display

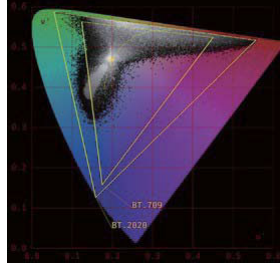

xy coordinate color indication

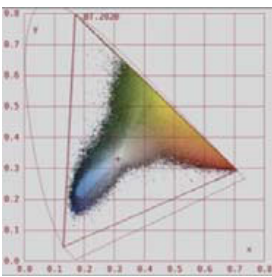

A light blue trace is a measurement function cursor

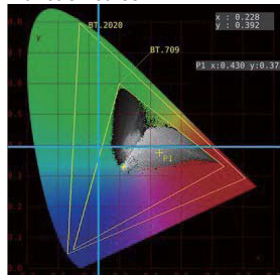

BT.709 compatible vectorscope scale

UHDTV (ARIB STD-B66) and HLG color bars (ARIB STD-B67) contain BT.2020 and BT.709 colors. This allows quick verification of the vector coordinates of a BT.709 color bar, useful for BT.2020 and BT.709 video content production.

BT.709 color bar vector display

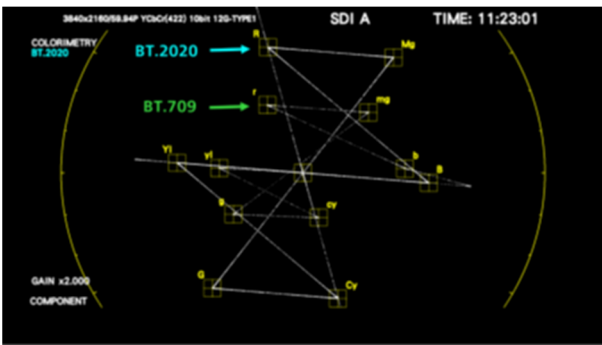

SCTE-104 compatible for ANC data analysis function

You can display the status of the packet you are currently receiving in blue and record it in the event log, or record the SPLICE request data. In addition, up to three SCTE-104 detection packets can be superimposed in the picture display.

SCTE-104 packet display (text display)



Picture Screen SCTE-104 detection display



SR Live Metadata display

Displays the packet of "SR Live Metadata" used by Sony Products & Software Inc.

SR Live Metadata display

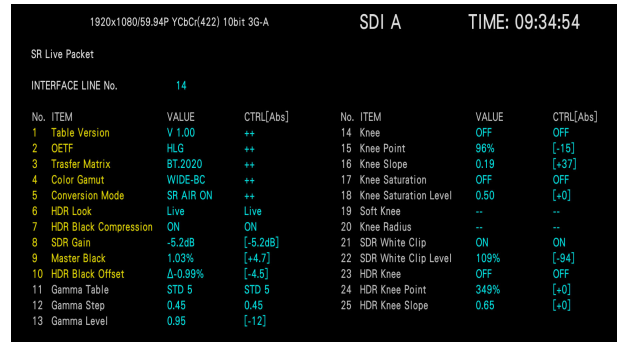

Eye pattern display (LV5600-SER02A)

This function displays SDI signal eye pattern waveforms and jitter waveforms, and parameter measurements. Only SDI input 1 supports the eye pattern display. A histogram view is also available. This function allows the eye pattern obtained with a 100kHz or higher filter (alignment jitter) and the eye pattern obtained with a 10Hz or higher filter (timing jitter) to be displayed together.

SDI input terminal Display SDI INPUT 1
Displays the waveform of the SDI input signal before it is equalized.

Screen
1-screen display The eye pattern for the selected filter is displayed on one screen.
2-screen display The eye pattern for the timing filter and eye pattern for the selected filter are displayed on two screens.

Waveform display color Selectable from seven colors.
Scale display color Selectable from seven colors.
Method ETS
Amplitude accuracy 800mV±5% (to 800mV input)

Time-axis display 2UI, 4UI, 16UI
Time-axis accuracy ±3%
Jitter filter 10Hz,100Hz,1kHz,100kHz,TIMING,ALIGNMENT
Cursor measurement Amplitude measurement/time measurement
Automatically measured item

Histogram view Amplitude, rising edge, falling edge, timing jitter, and jitter overshoot
Displays the frequency distribution of the eye pattern waveform amplitude.

Concurrent display

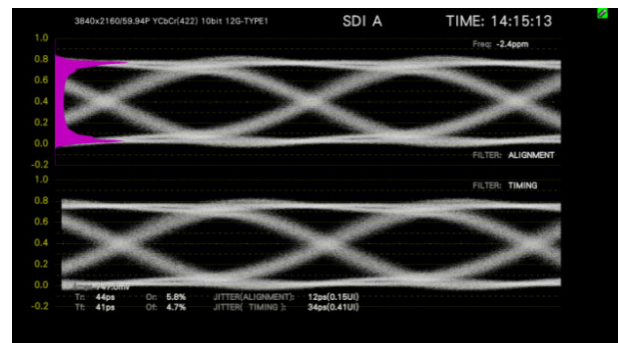

LV5600-SER03 / LV7600-SER03

Digital and analog audio I/O and displays (16 ch)

Audio analysis

Lissajous display, surround display, mute, clip error detection, loudness measurement, etc. are added with this option. Numerous analysis displays are available, and simultaneous display of 16 channels from one SDI signal or 4 channels from 4 SDI signals is possible.

Embedded Audio

Approved standard SMPTE ST 299, SMPTE ST 272
48 kHz/24 bit/L-PCM
Synchronization All are synchronized with the video clock.
All input SDI signals are synchronized.

External input audio

Approved standard AES-3id
Synchronization All external audio inputs are synchronized with each other.

Digital audio input/output Terminal

Input/output terminal DIN 1.0/2.3 connector
Number of Input/output terminals
Group A 4 terminals 8ch
Group B 4 terminals 8ch
Switching I/O: Switching by each group (4 terminals 8 ch)

Analog audio I/O terminal

I/O terminal D-sub 37-pin (female)
I/O signal format Balanced DC coupling
I/O channel 8ch

Level meter

Display channels 8ch/16ch
Display dynamic range
SDI embedded audio -60dBFS/-90dBFS/Reference level ± 3 dB
External digital audio -60dBFS/-90dBFS/Reference level ± 3 dB
External analog audio -60dBFS/Reference level ± 3 dB, Scaling with the scale reference level 4dBu converted to -20dBFS
Level accuracy ± 0.3 dB
(-50 to 0dBFS, 1kHz, signal source impedance 40 Ω or less)
Frequency characteristics
30Hz to 20kHz ± 0.4 dB (4dBu, 1kHz reference, TRUE PEAK response)
20Hz to 20kHz +0.4dB, -0.6dB (4dBu, 1kHz reference, TRUE PEAK response)
Meter response model TRUE PEAK/PPM type I/PPM type II/VU
Peak hold time 0.0 to 5.0 sec (0.5-sec steps)/HOLD
Level setting -40.0 to 0.0dBFS (reference level, warning level, over level)

Lissajous display

Display channels 2ch x 1/2ch x 4/2ch x 8
Display method X-Y/MATRIX
Correlator Indicates a value between -1 and 1 for the correlation between two channels.

Channel assignments

SINGLE LISSAJOU L/R
MULTI LISSAJOU L1/R1 to L4/R4 to L8/R8

Lissajous and bar graph audio display

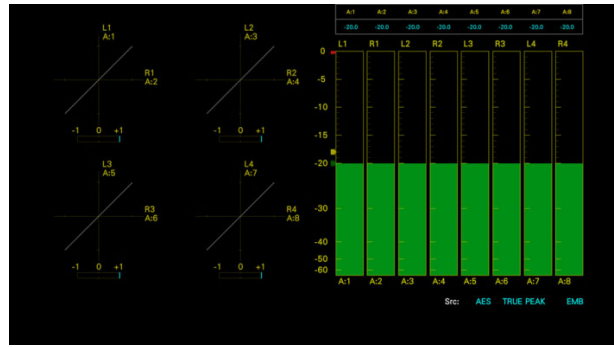

Surround display

Function Graphically displays the sound field.
Surround system 5.1ch
Channel assignments L/R/C/LFE/Ls/Rs/Lt/Rt

Status display

Level value Indicates the audio level as a (dBFS) value
Error detection Counts the number of errors that occurred on each channel.
Level over Counts the number of times the input signal level exceeds the specified value.
Detection setting -40.0 to 0.0dBFS
Clip Counts the number of times a maximum value signal exceeding the specified number of samples is input successively.
Detection setting 1 to 100samples
Mute Counts the number of times a mute signal exceeding the specified duration of time is input successively.
Detection setting 1 to 5000ms
Parity error Counts the number of times the parity bit of an input signal differs from the re-calculated parity value.
Validity error Counts the number of times that the validity bit of an input signal is 1.
CRC error Counts the number of times the CRC value of the channel status bit differs from the re-calculated CRC value.
Code violation Counts the number of times the bi-phase modulation of an input signal is abnormal.

Loudness display

Function Chart display, value display, log, level meter display, and peak value display
Approved standard ITU-R BS.1770, ARIB TR-B32, EBU R128, ATSC A/85
No. of measurable channels Two audio channels can be measured simultaneously.
Modes (main) Mono/Stereo/5.1/Proper channel
Modes (sub) Off/Mono/Stereo
Channel assignment Any eight channels can be assigned.
LFE gain x0 to x10
Measurement trigger Manual (panel)/Remote/Time code/Mute
Measurement mode BS1770/ARIB/EBU/ATSC/CUSTOM



Lip sync measurement

Function	Measures the time difference between the SDI signal and digital audio signal and shows measurements as a value and on a simple graph.
Reference signal	Supports Leader lip sync signal.
Luminous level setting value	25 to 100%
Audio signal level setting value	-30 to 0dBFS
Supported audio signal	Embedded audio signal, Digital audio signal
Measurement range (bar display)	±50ms/±100ms/±500ms/±1.0s/±2.5s
Measurement range (value display)	±3999ms
Measurement resolution	1ms

* TSG patterns other than ours can be supported by configuring video signal settings and audio signal settings.

Lip sync display

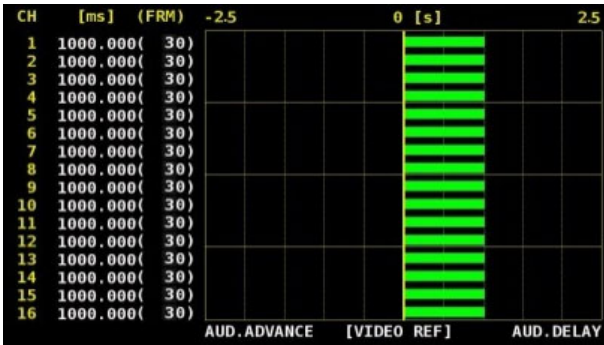

LV5600-SER04 / LV7600-SER04

Dolby decoding

Decode and analysis of Dolby E, Dolby Digital, Dolby Digital Plus. LV5600-SER 04 and LV7600-SER 04 must be added to LV5600-SER 03 and LV7600-SER 03.

LV5600-SER05 / LV7600-SER05

IP Input (SMPTE ST 2022-6 , SMPTE 2110-20)

LV5600-SER06 / LV7600-SER06

25G-IP supported

Adds support for SMPTE ST 2022-6 (uncompressed) and SMPTE 2110-20/-30*/-40* (uncompressed) & SMPTE ST 2022-7 video over IP formats. NMOS(IS-04/-05) compatible.

Enhanced transmission quality (QoS) monitoring features are available for detecting packet loss, checksum errors, discontinuous packets, and other transmission errors as well as packet jitter and other parameters useful to troubleshoot live audio and video IP flows.

Input video format

IP standard	SMPTE ST 2022- 6 & 7, SMPTE ST 2110- 20
Supported format	3840x2160 (60,59.94,50P) *1 1920x1080 (60,59.94,50I/P) , 1280x720 (60,59.94,50P)

Input audio format

Approved standard	SMPTE ST 2022- 6, SMPTE ST 2110- 30, SMPTE ST 2110-31
-------------------	--

Sampling frequency 48kHz

Quantization accuracy 24bit

Supported formats L-PCM

Clock generation: Generated from video clock synchronization.

Synchronization Relationship

Audio is synchronized to the video signal
All video and audio streams must be synchronized during Simul Display.

Up to 16 channels of IP audio are displayed.

* L-PCM requires optional LV5600-SER 03 and LV7600-SER 03.

Input terminal(SER05)

Input terminal	SFP +
Number of terminals	2
Approved standard	10GBASE-SR/10G BASE-LR
Fiber Types	Multi-mode, single-mode

Input terminal(SER06)

Input terminal	QSFP+/QSFP28
Number of terminals	2 *2
Approved standard	10GBASE-SR/10GBASE-LR *3 25GBASE-SR/25GBASE-LR *3
Fiber Types	Multi-mode, single-mode

*1 Only LV5600-SER06/LV7600-SER06

*2 An adapter included with the SER06 is used when installing the SFP+ or SFP28.

*3 The standard must be the same for each of the two I/O connectors.

Ancillary data

Approved standard	SMPTE ST 2110-40
-------------------	------------------

Video analysis

Perform all the video checks offered for a conventional SDI Waveform monitor: waveform, vector, 5 BAR gamut, CINELITE II, and CIE chromaticity diagram. In addition to the various displays, quality of experience (QoE) monitoring such as freeze, black, gamut, help ensure all potential issues with content are easily diagnosed.

Audio analysis

Audio IP signals can be displayed on a level meter.

Add the LV5600-SER03/LV7600-SER03 to enable Lissajous, surround, and status displays.

Transmission quality

This function enhances the monitoring capability for errors related to the transmission quality (QoS) specific to the implementation of IP, such as packet loss, checksum error, and packet discontinuity.

Time code display

Display of time code information in the IP stream.

The time code can also be used as the timestamp of the event log.

Remote control

You can change the stream or format to observe through registration/control on NMOS from the Ethernet terminal (RJ45).

Approved standard: NMOS (IS-04/05)

IP Analysis

•IP status display

Displays Ethernet (IP 1/2) traffic and each stream. It is possible to switch between port 1 and port 2 and display them at the same time.

IP stream list: Displays streams included in IP input signals.

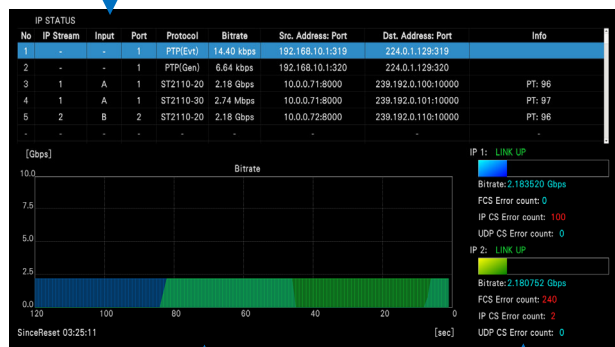

Graph display that allows traffic to be checked by time

Bit rate measurement value
FCS: Frame checksum
IP CS: IP checksum
UDP CS: UDP checksum

• IP packet jitter

The packet arrival time interval is graphed for ease of monitoring. You can also display the maximum, minimum, average value of packet arrival time intervals per second, and display maximum and minimum values in measurement.

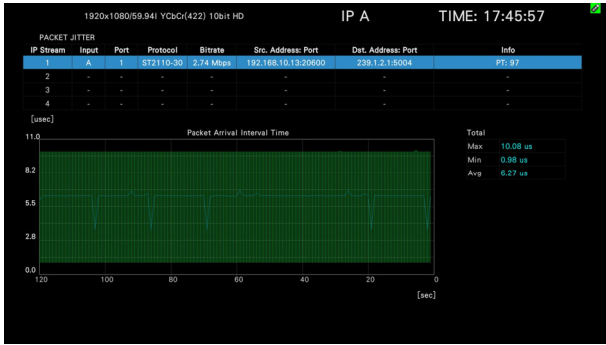

• Path Delay

The path delay screen shows the measurement of the packet arrival time difference between IP signal ports.

Path delay display

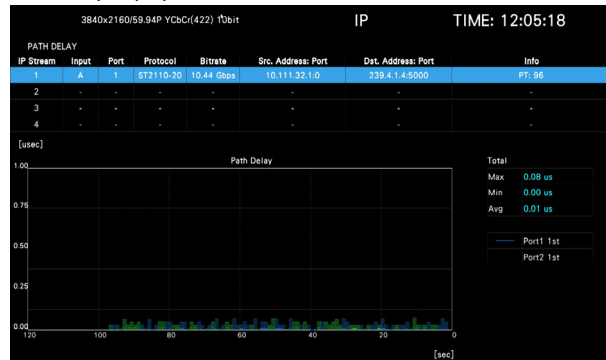

Display maximum as a graph

Display maximum, minimum, and average packet arrival intervals

• PTP status

Display PTP synchronization status, time information, offset graph of time difference and time difference graph.

PTP status display

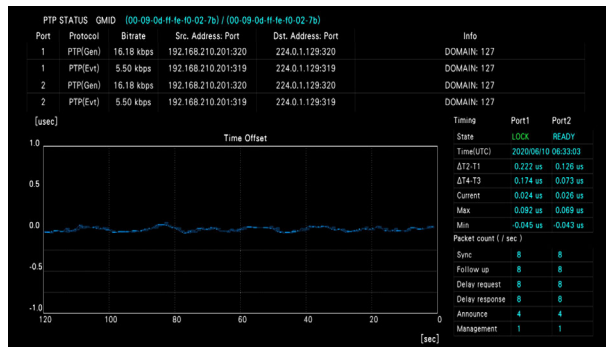

• PTP-RTP Timing Comparison display

Displays the phase difference comparing the time stamps of PTP and ST2110-20.

Used to confirm if the video/audio and ANC signals are in sync with PTP by comparing between the PTP time information and time stamp.

PTP-RTP timing comparison display

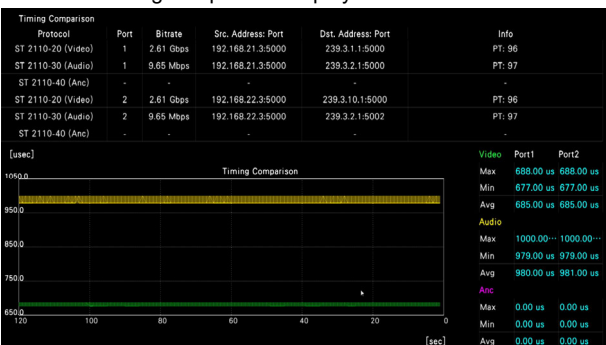

SFP module status

Return the vendor code, type, and other information of the installed SFP module.

Stream info

Displays information about the MAC/IP/UDP/RTP/PAYLOAD header packets in the stream.

• IP Event Log

The errors that you have selected to detect are displayed in chronological order.

Displayable errors

FCS error / IP checksum error / UDP checksum error / Packet loss for streams 1-4/ Marker bit errors for streams 1-4 / Unlock PTP

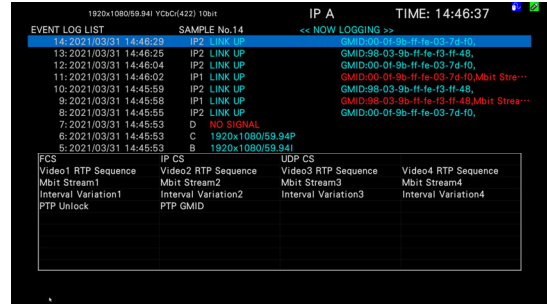

• Buffer measurement (SER06)

Displays the measured value of CMAX / VRX when the transmission type of SMPTE ST2110-21 is Narrow. CMAX represents the full value of the packet being sent, and VRX represents the value of the virtual receive buffer.

CMAX: Displays the maximum buffer value from the sender to the receiver



VRX: Displays the maximum buffer value required by the receiver



• Analysis of NMOS

The NMOS SDP Viewer function allows you to analyze NMOS. LV5600 / LV7600 displays NMOS requests for each receiver.

NMOS CONNECTION LIST (IS-05) display

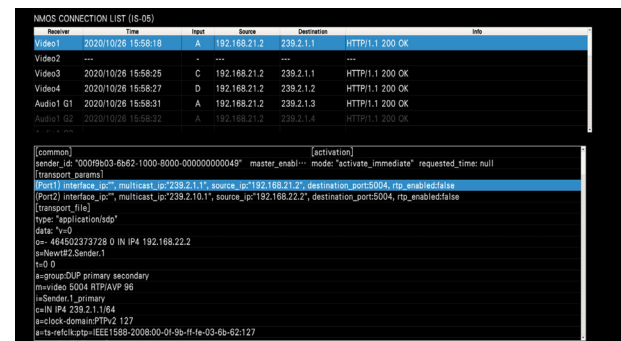

NMOS REGISTRATION LIST (IS-04) display.
 Displays the host that is presenting the Registry (RDS) service that LV5600 / LV7600 recognize.



-IP/SDI simultaneous display

Up to 4 different signals can be displayed at the same time, whether IP or SDI.

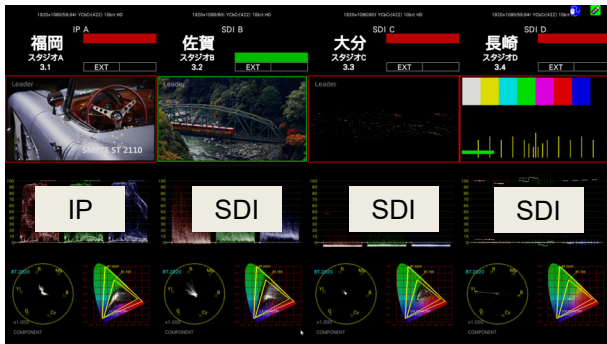

LV5600-SER23 / LV7600-SER23

HDR measurement

In addition to HLG and PQ per ITU-R BT.2100, this option also supports level monitoring of S-log3 HDR signals. Level management can be made using the assumed luminance (cd/m²) in a display considering OOTF. The video waveform includes the HDR scale added to the IRE scale. In the CINEZONE™ display, the luminance distribution of the HDR area can be easily confirmed with the SDR area shown in monochrome, and the HDR content with a color according to the brightness.

Approved standard

ITU-R BT.2100 (HLG; Hybrid Log Gamma, PQ Curve), S-Log3, C-Log, Log-C

Supported formats

All formats except SD-SDI.

HDR Scale

By associating waveform and histogram with the HDR scale, management of the video with brightness is simplified.

HDR zone display

The luminance distribution of the HDR area can be easily confirmed by coloring the SDR area with monochrome, and the HDR with a color according to brightness.

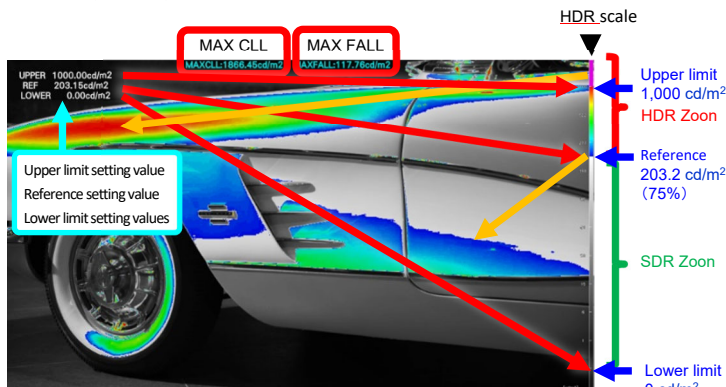

The SDR part is monochrome, the HDR region is colored according to luminance. Above the upper limit value is colored with magenta. The upper limit value, the reference value, the lower limit value can be varied.

HDR waveform display

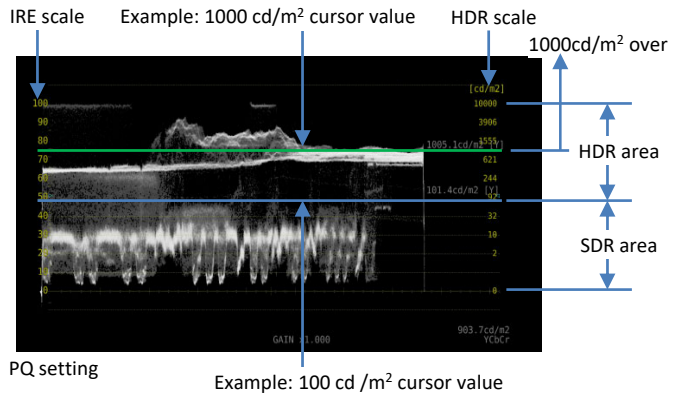

HDR point measurement

The crosshair cursor can be freely moved. Up to 3 points can be measured simultaneously.



PQ setting

P1(S: 884, L: 261) 3243.6cd/m2

HLG setting SYSTEM GAMMA OFF

P1(S: 884, L: 261) 623.9%

HLG setting System Gamma On

P1(S: 884, L: 261) 456.1cd/m2

S-Log3 setting System Gamma Off

P1(S: 884, L: 261) 809.1%

LV5600-SER24 / LV7600-SER24

SDI signal generation

The optional generator provides SDI test signals, useful for device or network troubleshooting. The generator supports HD-SDI through 12G-SDI with HD multi format color bar and patterns, multiple overlays of moving boxes and embedded audio, flat field at any level, and a 4K multi format color bar.

With the 4K pattern of 3G-SDI quad link, the phase of each link can be shifted to confirm the recovery margin of the receiving device.

* When outputting 3G (DL) -4K signal and 3G (QL) -4K signal, LV5600-SER 28 is required for LV5600 and LV7600-SER 28 is required for LV7600.

* When outputting the 12 G-4 K signal, LV5600 - LV5600 - SER28 and LV5600-SER 29, LV7600 requires LV7600-SER 28 and LV7600-SER 29.

Output pattern

100% color bar, 75% color bar, HD multifformat color bar *1, 4K multifformat color bar *1, color raster, gamma, cross hatch, 10 step, limit lamp, check field, lip sync pattern(SER03), HDR color bar (SER23) *1

Scroll *2 ON/OFF
 Direction 8directions (up and down, left and right, and combinations thereof)

Speed range and unit 4 to 124 dots per frame (field), 4 dot unit.

Moving Box *2 ON/OFF
 Color WHITE, YELLOW, CYAN, GREEN, MAGENTA, RED, BLUE, BLACK
 Speed 1 to 3

Frequency Phase Adjustment *2*3

- Quad link Vary the phases of SDI OUTPUT 2 to 4 independently relative to SDI OUTPUT 1
- Dual link Vary the phase of SDI OUTPUT 2 relative to SDI OUTPUT 1 and the phase of SDI OUTPUT 4 relative to SDI OUTPUT 3
- Adjustment Range ± 0.5 lines (in unit of video clocks)
 $\pm 1/2$ frames (in unit of lines)

Embedded Audio

- Number of Embedded Channels 16channels max. *4
- Embedding On/Off On/off at the audio group level
- Audio Level -20dBFS, -18dBFS, 0dBFS, mute
- Audio Frequency 1kHz
- CRC Error Addition An incorrect CRC is inserted into the Y component of the first line.

- *1 It cannot be set in horizontal 4096 and 2048 pixel format.
- *2 Either scrolling, moving box, or frequency phase adjustment can be turned on.
- *3 The output phase may be off by ± 2 clock from the specified value as a result of switching the format or turning on and off the power.
- *4 For horizontal 4096/2048 pixel format at frame rates 60, 59.94, 30, 29.97 Hz, only 8 channels are embedded.

LV5600-SER25 / LV7600-SER25

Focus assist

This option adds a new, proprietary focus detection algorithm based on nonlinear super-resolution technology to aid in scene focus conditions. Focus is determined with high sensitivity and repeatability even with difficult, low-contrast images. In addition, sensitivity can be selected from 5 levels according to the video scene.

Focus assist display



After focus adjustment
(The green part is the focus adjustment point)

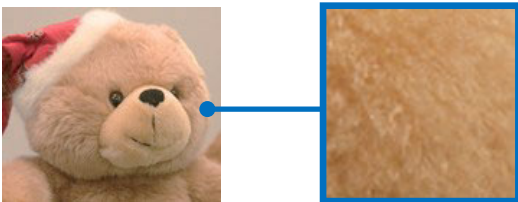

Enlarged view (After focus adjustment)

LV5600-SER26 / LV7600-SER26

Customized layout

Customized display layout

Users can size and position all video displays, waveforms, vectorscopes, gamut views, audio tools, etc. as desired to optimize the screen for any specific workflow or user. Multiple input signals for up to 4 inputs can be displayed simultaneously, or one input signal can be displayed on multiple screens.

Customized layout setting screen

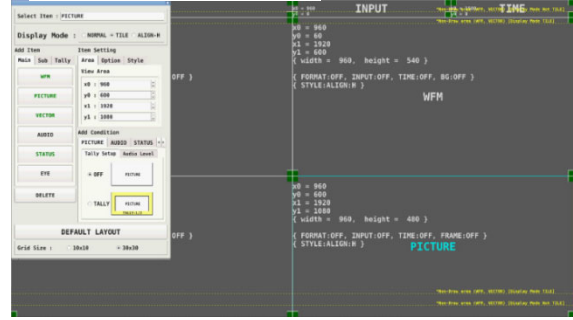

Layout Set measurement screen

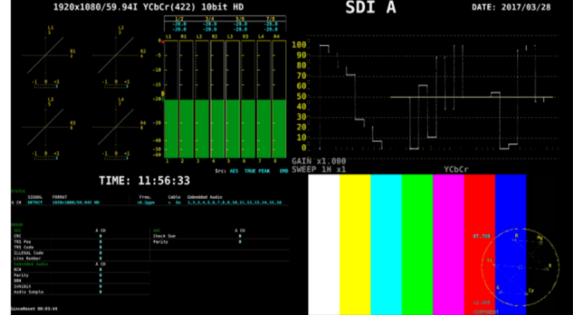

Display assignment

SDI input signals from the four rear inputs can be assigned to A to D display channels. By allocating one SDI input signal to multiple display channels, it is possible to monitor video signals in multiple display formats. For example, SDI input 1 can be rendered as composite video on display channel A and as a component video waveform on display channel B.

*It is not possible to monitor errors in the background of input channels not assigned to display channels.

Display assignment display image

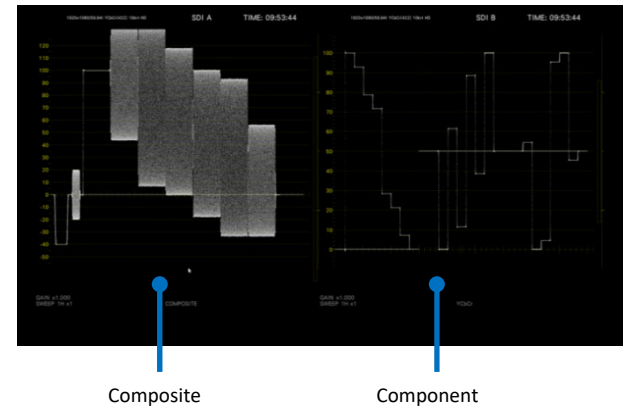

LV5600-SER27 / LV7600-SER27

ID / Iris / Tally display

Display camera ID, and tally information received via Serial RS-422/485 ports. Remote connectivity is also supported.

ID/iris/tally display

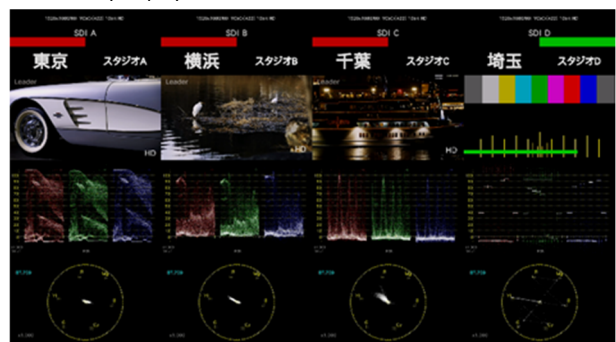

LV5600-SER28 / LV7600-SER28

4K/UHDTV video

Adds 4K/UHDTV video formats via 3G-SDI dual link and quad link, HD-SDI quad link.

LV5600-SER29 / LV7600-SER29

12G/6G-SDI

Adds support for 12G/6G-SDI single link. In 4K/UHDTV video formats, switching of up to 4 displays possible with a 12G/6G-SDI single link input, and switching of up to 2 displays can be done with a 3G-SDI dual link.

* Requires optional mounting of LV5600-SER28 and LV7600-SER28.

LV5600-SER30 / LV7600-SER30

Video noise meter

This meter measures the video noise included in the luminance signal or RGB signal in the input SDI signal.

Supports 4K/UHDTV/12G/6G/3G/HD/SD cameras to allow for the broadest range of compatible cameras.

Video noise meter

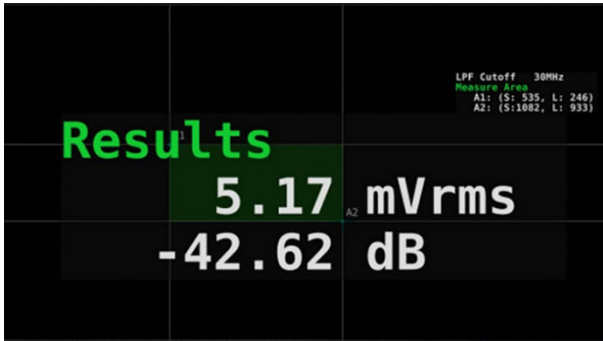

LV5600-SER31 / LV7600-SER31

Colorimetry zone display

This feature simplifies the task of identifying the reproduction errors which can occur when transmitting video content produced in BT.709, DCI-P3 or BT.2020 wide color gamut or when converting content from BT.2020 to narrow color gamut.

Color Gamut Selection Selects the color gamut inside the colorimetry zone display

ITU-R BT.709 / DCI

Mesh Pattern Size × 1, × 2, × 4, × 6, × 8

Display Selection Color, monochrome

Log

Records as the event log when a color outside the ITU-R BT.709 or DCI color gamut exists inside the ITU-R BT.2020 color gamut.

Colorimetry zone display

Colorimetry zone OFF

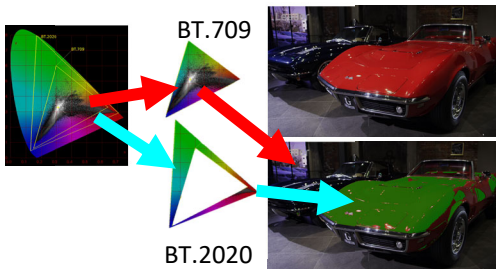

Colorimetry zone ON

Areas of the picture outside of BT.709 or DCI-P3 will be coloured in the picture.

LV5600-SER32 / LV7600-SER32

UHDTV/HD-IP pattern generator

This is an IP pattern generator option that outputs color bars and lip sync patterns and supports jitter addition to color bars, in order to evaluate IP networks. The supported output format is SMPTE 2110.

* The LV5600-SER06 or LV7600-SER06 must be implemented.

Supported IP standards

Supported IP formats

SMPTE ST 2022-6

SMPTE ST 2110-20/30/40

Synchronization method

PTP (SMPTE ST 2059)

IP based video format

SMPTE ST 2022-6 (only uncompressed format supported)

Color system	Image	Frame (field) frequency/scanning
Quantization accuracy		
YCbCr 4:2:2	1280x720	60/59.94/50 /P
10bit	1920x1080	60/59.94/50 /I
		60/59.94/50 /P

ST2110-20 (only uncompressed format supported)

Color system	Image	Frame (field) frequency/scanning
Quantization accuracy		
YCbCr 4:2:2	1280x720	60/59.94/50 /P
10bit	1920x1080	60/59.94/50 /I
	3840x2160 *	60/59.94/50 /P

* For 4K, only a single stream is supported. You also need the SER28.

Output pattern 100% color bar, 75% color bar, multiformat color bar, lip sync pattern

Audio signal Outputs 1kHz audio signals that conform to the SMPTE ST 2022-6, SMPTE ST 2110-20, SMPTE ST 2110-30 standard.

Supported protocols

- IPv4 (Internet Protocol version 4)
- IGMPv2/v3 (Internet Group Management Protocol)
- NMOS (IS-04/05)*

* For NMOS control, use the RJ45 Ethernet input on the LV5600/LV7600.

IP I/O terminals

I/O terminals QSFP+/QSFP28

Supported SFP SFP+, SFP28 *1

Number of terminals 2 *2

Approved standard 10GBASE-SR/10GBASE-LR

25GBASE-SR/25GBASE-LR

Fiber type Multi mode/Single mode

*1 The adapter included with the SER06 is used when installing the SFP+ or SFP28.

*2 The same standard must be used in each of the two I/O connectors.

IP Packet Emulation

Adds jitter and checksum error to the SMPTE ST 2110-20 test signal.

Error FCS ERROR/IP CS/UDP CS

Jitter *1*2*3*4 1packet/10packet/20packet/30packet/

40packet/50packet/60packet/70packet/

80packet/90packet/100packet

* Error and jitter are added on the output from port 1.

*1 In outputting 4K signal, you can set up to 20 packets.

*2 The packet jitter depends on the output signal format.

*3 The packet jitter may be off by ±10%.

*4 The RTP time stamp causes twice delay of the packet transmission interval.

LV5600-SER40 / LV7600-SER40

Extended vector display function

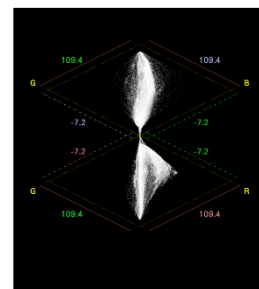

RGB VECTOR

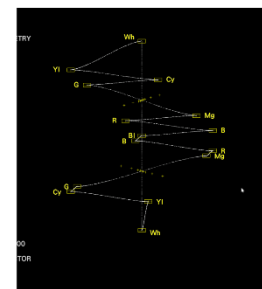

YCbCr VECTOR

SDI Video Formats and Standards (SER01/SER02A)

SD video signal formats and standards

Color System	Quantization	Image	Field Frequency /Scanning	Supported Standard
YCbCr 4:2:2	10bit	720 × 487	59.94 /I	SMPTE ST 259
		720 × 576	50 /I	

HD video signal formats and standards

Color System	Quantization	Image	Frame (Field) Frequency /Scanning	Supported Standard
YCbCr 4:2:2	10bit	1280 × 720	60/59.94/50/ 30/29.97/25/24/23.98 /P	SMPTE ST 292-1 SMPTE ST 296
			60/59.94/50 /I	SMPTE ST 274
		1920 × 1080	30/29.97/25/24/23.98 /P	SMPTE ST 292-1
			30/29.97/25/24/23.98 /PsF	SMPTE ST 292-1

3G-A video signal formats and standards

Color System	Quantization	Image	Frame (Field) Frequency /Scanning	Supported Standard			
YCbCr 4:2:2	10bit	1920 × 1080	60/59.94/50 /P	SMPTE ST 274 SMPTE ST 425-1			
			48/47.95 /P	-			
		2048 × 1080	60/59.94/50/48/47.95 /P	SMPTE ST 425-1 SMPTE ST 2048-2			
			60/59.94/50 /I	SMPTE ST 274			
	12bit	1920 × 1080	30/29.97/25/24/23.98 /P	SMPTE ST 425-1			
			30/29.97/25/24/23.98 /PsF	SMPTE ST 425-1			
		2048 × 1080	30/29.97/25/24/23.98 /P	SMPTE ST 425-1			
			30/29.97/25/24/23.98 /PsF	SMPTE ST 2048-2			
YCbCr 4:4:4	10bit	1280 × 720	60/59.94/50/ 30/29.97/25/24/23.98 /P	SMPTE ST 296 SMPTE ST 425-1			
			60/59.94/50 /I	SMPTE ST 274			
			1920 × 1080	30/29.97/25/24/23.98 /P	SMPTE ST 425-1		
				30/29.97/25/24/23.98 /PsF	SMPTE ST 425-1		
		2048 × 1080	30/29.97/25/24/23.98 /P	SMPTE ST 425-1			
			30/29.97/25/24/23.98 /PsF	SMPTE ST 2048-2			
			12bit	1920 × 1080	60/59.94/50 /I	SMPTE ST 274	
					30/29.97/25/24/23.98 /P	SMPTE ST 425-1	
	30/29.97/25/24/23.98 /P	SMPTE ST 425-1					
	30/29.97/25/24/23.98 /PsF	SMPTE ST 425-1					
	2048 × 1080	30/29.97/25/24/23.98 /P		SMPTE ST 425-1			
		30/29.97/25/24/23.98 /PsF		SMPTE ST 2048-2			
		RGB 4:4:4		10bit	1280 × 720	60/59.94/50/ 30/29.97/25/24/23.98 /P	SMPTE ST 296 SMPTE ST 425-1
						60/59.94/50 /I	SMPTE ST 274
	1920 × 1080		30/29.97/25/24/23.98 /P		SMPTE ST 425-1		
			30/29.97/25/24/23.98 /PsF		SMPTE ST 425-1		
2048 × 1080	30/29.97/25/24/23.98 /P		SMPTE ST 425-1				
	30/29.97/25/24/23.98 /PsF		SMPTE ST 2048-2				
	12bit		1920 × 1080	60/59.94/50 /I	SMPTE ST 274		
				30/29.97/25/24/23.98 /P	SMPTE ST 425-1		
2048 × 1080		30/29.97/25/24/23.98 /P	SMPTE ST 425-1				
		30/29.97/25/24/23.98 /PsF	SMPTE ST 2048-2				
XYZ 4:4:4	12bit	2048 × 1080	30/25/24 /P	SMPTE ST 425-1			
			30/25/24 /PsF	SMPTE ST 428			

3G-B-DL, HD(DL) Video Signal Formats and Standards

Color System	Quantization	Image	Frame (Field) Frequency /Scanning	Supported Standard		
YCbCr 4:2:2	10bit	1920 × 1080	60/59.94/50 /P	SMPTE ST 274 SMPTE ST 372 SMPTE ST 425-1		
			48/47.95 /P	-		
		2048 × 1080	60/59.94/50/48/47.95 /P	SMPTE ST 372 SMPTE ST 425-1 SMPTE ST 2048-2		
			60/59.94/50 /I	SMPTE ST 274		
	12bit	1920 × 1080	30/29.97/25/24/23.98 /P	SMPTE ST 372		
			30/29.97/25/24/23.98 /PsF	SMPTE ST 425-1		
		2048 × 1080	30/29.97/25/24/23.98 /P	SMPTE ST 372 SMPTE ST 425-1		
			30/29.97/25/24/23.98 /PsF	SMPTE ST 2048-2		
YCbCr 4:4:4	10bit	1920 × 1080	60/59.94/50 /I	SMPTE ST 274		
			30/29.97/25/24/23.98 /P	SMPTE ST 372		
			2048 × 1080	30/29.97/25/24/23.98 /PsF	SMPTE ST 425-1	
				30/29.97/25/24/23.98 /PsF	SMPTE ST 425-1	
		12bit	1920 × 1080	60/59.94/50 /I	SMPTE ST 274	
				30/29.97/25/24/23.98 /P	SMPTE ST 372	
				2048 × 1080	30/29.97/25/24/23.98 /PsF	SMPTE ST 425-1
					30/29.97/25/24/23.98 /PsF	SMPTE ST 2048-2
	RGB 4:4:4		10bit	1920 × 1080	60/59.94/50 /I	SMPTE ST 274
					30/29.97/25/24/23.98 /P	SMPTE ST 372
				2048 × 1080	30/29.97/25/24/23.98 /PsF	SMPTE ST 425-1
					30/29.97/25/24/23.98 /PsF	SMPTE ST 2048-2
		12bit	1920 × 1080	60/59.94/50 /I	SMPTE ST 274	
				30/29.97/25/24/23.98 /P	SMPTE ST 372	
			2048 × 1080	30/29.97/25/24/23.98 /PsF	SMPTE ST 425-1	
				30/29.97/25/24/23.98 /PsF	SMPTE ST 2048-2	
XYZ 4:4:4	12bit	2048 × 1080	30/25/24 /P	SMPTE ST 372 SMPTE ST 425-1		
			30/25/24 /PsF	SMPTE ST 428		

* The phase difference between links of HD(DL) is automatically corrected and displayed to 100 clocks (about 1.34 μs).

3G-B-DS video signal formats and standards

Color System	Quantization	Image	Frame (Field) Frequency /Scanning	Supported Standard
YCbCr 4:2:2	10bit	1920 × 1080	60/59.94/50 /I	SMPTE ST 274
			30/29.97/25/24/23.98 /P	SMPTE ST 425-1
		1280 × 720	60/59.94/50/ 30/29.97/25/24/23.98 /P	SMPTE ST 296 SMPTE ST 425-1

3G(DL)-2K Video Signal Formats and Standards

Color System	Quantization	Image	Frame (Field) Frequency / Scanning	Supported Standard
Y _C B _C R 4:2:2	12bit	1920 × 1080	60/59.94/50 /P	SMPTE ST 274 SMPTE ST 425-3
			48/47.95 /P	-
		2048 × 1080	60/59.94/50/48/47.95 /P	SMPTE ST 2048-2 SMPTE ST 425-3
Y _C B _C R 4:4:4	10bit	1920 × 1080	60/59.94/50 /P	SMPTE ST 274 SMPTE ST 425-3
		2048 × 1080	60/59.94/50/48/47.95 /P	SMPTE ST 2048-2 SMPTE ST 425-3
	12bit	1920 × 1080	60/59.94/50 /P	SMPTE ST 274 SMPTE ST 425-3
		2048 × 1080	60/59.94/50/48/47.95 /P	SMPTE ST 2048-2 SMPTE ST 425-3
RGB 4:4:4	10bit	1920 × 1080	60/59.94/50 /P	SMPTE ST 274 SMPTE ST 425-3
		2048 × 1080	60/59.94/50/48/47.95 /P	SMPTE ST 2048-2 SMPTE ST 425-3
	12bit	1920 × 1080	60/59.94/50 /P	SMPTE ST 274 SMPTE ST 425-3
		2048 × 1080	60/59.94/50/48/47.95 /P	SMPTE ST 2048-2 SMPTE ST 425-3

* When these signals are displayed, phase differences of up to 100 clocks (approx. 0.67 μs) between links are automatically corrected.

* 3G-A and 3G-B-DL links are supported.

3G(DL)-4K Video Signal Formats and Standards

Square

Color System	Quantization	Image	Frame Frequency / Scanning	Supported Standard
Y _C B _C R 4:2:2	10bit	3840 × 2160	30/29.97/25/24/23.98 /P	SMPTE ST 425-3 SMPTE ST 2036-1
			30/29.97/25/24/23.98 /PsF	-
		4096 × 2160	30/29.97/25/24/23.98 /P	SMPTE ST 425-3 SMPTE ST 2048-1
			30/29.97/25/24/23.98 /PsF	-

2 sample interleave

Color System	Quantization	Image	Frame Frequency / Scanning	Supported Standard
Y _C B _C R 4:2:2	10bit	3840 × 2160	30/29.97/25/24/23.98 /P	SMPTE ST 425-3 SMPTE ST 2036-1
		4096 × 2160	30/29.97/25/24/23.98 /P	SMPTE ST 425-3 SMPTE ST 2048-1

* You also need the SER28.

* When these signals are displayed, phase differences of up to 100 clocks (approx. 0.67 μs) between links are automatically corrected.

* 3G-B-DS links are supported.

HD(QL) video signal formats and standards (square)

Color System	Quantization	Image	Frame Frequency / Scanning	Supported Standard
Y _C B _C R 4:2:2	10bit	3840 × 2160	30/29.97/25/24/23.98 /P	-
			30/29.97/25/24/23.98 /PsF	-
		4096 × 2160	30/29.97/25/24/23.98 /P	-
			30/29.97/25/24/23.98 /PsF	-

* You also need the SER28.

* When these signals are displayed, phase differences of up to 100 clocks (approx. 0.67 μs) between links are automatically corrected.

3G(QL) video signal formats and standards

Square

Color System	Quantization	Image	Frame Frequency / Scanning	Supported Standard
Y _C B _C R 4:2:2	10bit	3840 × 2160	60/59.94/50 /P	SMPTE ST 425-5 SMPTE ST 2036-1
			48/47.95 /P	-
	12bit	3840 × 2160	60/59.94/50/48/47.95 /P	SMPTE ST 425-5 SMPTE ST 2048-1
			30/29.97/25/24/23.98 /P	SMPTE ST 425-5 SMPTE ST 2036-1
Y _C B _C R 4:4:4	10bit	3840 × 2160	30/29.97/25/24/23.98 /P	SMPTE ST 425-5 SMPTE ST 2036-1
			30/29.97/25/24/23.98 /PsF	-
	12bit	3840 × 2160	30/29.97/25/24/23.98 /P	SMPTE ST 425-5 SMPTE ST 2036-1
			30/29.97/25/24/23.98 /PsF	-
RGB 4:4:4	10bit	3840 × 2160	30/29.97/25/24/23.98 /P	SMPTE ST 425-5 SMPTE ST 2036-1
			30/29.97/25/24/23.98 /PsF	-
	12bit	3840 × 2160	30/29.97/25/24/23.98 /P	SMPTE ST 425-5 SMPTE ST 2036-1
			30/29.97/25/24/23.98 /PsF	-
XYZ 4:4:4	10bit	3840 × 2160	30/29.97/25/24/23.98 /P	SMPTE ST 425-5 SMPTE ST 2036-1
			30/29.97/25/24/23.98 /PsF	-
	12bit	4096 × 2160	30/29.97/25/24/23.98 /P	SMPTE ST 425-5 SMPTE ST 2048-1
			30/29.97/25/24/23.98 /PsF	-
12bit	4096 × 2160	30/25/24 /P	SMPTE ST 425-5 SMPTE ST 428	
		30/25/24 /PsF	-	

2 sample interleave

Color System	Quantization	Image	Frame Frequency / Scanning	Supported Standard
Y _C B _C R 4:2:2	10bit	3840 × 2160	60/59.94/50 /P	SMPTE ST 425-5 SMPTE ST 2036-1
			48/47.95 /P	-
	12bit	3840 × 2160	60/59.94/50/48/47.95 /P	SMPTE ST 425-5 SMPTE ST 2048-1
			30/29.97/25/24/23.98 /P	SMPTE ST 425-5 SMPTE ST 2036-1
Y _C B _C R 4:4:4	10bit	3840 × 2160	30/29.97/25/24/23.98 /P	SMPTE ST 425-5 SMPTE ST 2036-1
			30/29.97/25/24/23.98 /PsF	-
	12bit	3840 × 2160	30/29.97/25/24/23.98 /P	SMPTE ST 425-5 SMPTE ST 2036-1
			30/29.97/25/24/23.98 /PsF	-
RGB 4:4:4	10bit	3840 × 2160	30/29.97/25/24/23.98 /P	SMPTE ST 425-5 SMPTE ST 2036-1
			30/29.97/25/24/23.98 /PsF	-
	12bit	3840 × 2160	30/29.97/25/24/23.98 /P	SMPTE ST 425-5 SMPTE ST 2036-1
			30/29.97/25/24/23.98 /PsF	-
12bit	4096 × 2160	30/25/24 /P	SMPTE ST 425-5 SMPTE ST 428	
		30/25/24 /PsF	-	

* You also need the SER28.

* When these signals are displayed, phase differences of up to 100 clocks (approx. 0.67 μs) between links are automatically corrected.

* 3G-A and 3G-B-DL links are supported.

6G video signal formats and standards (2 sample interleave)

Color System	Quantization	Image	Frame Frequency / Scanning	Supported Standard
YCbCr 4:2:2	10bit	3840 × 2160	30/29.97/25/24/23.98 /P	SMPTE ST 2036-1 SMPTE ST 2081-10
		4096 × 2160	30/29.97/25/24/23.98 /P	SMPTE ST 2048-1 SMPTE ST 2081-10

* You also need the SER28 and SER29.

12G video signal format and standard (2 sample interleave)

Color System	Quantization	Image	Frame Frequency / Scanning	Supported Standard
YCbCr 4:2:2	10bit	3840 × 2160	60/59.94/50 /P	SMPTE ST 2036-1 SMPTE ST 2082-10
			48/47.95/P	-
	12bit	4096 × 2160	60/59.94/50/48/47.95 /P	SMPTE ST 2036-1 SMPTE ST 2082-10
			3840 × 2160	30/29.97/25/24/23.98 /P
YCbCr 4:4:4	10bit	3840 × 2160	30/29.97/25/24/23.98 /P	SMPTE ST 2036-1 SMPTE ST 2082-10
			4096 × 2160	30/29.97/25/24/23.98 /P
	12bit	3840 × 2160	30/29.97/25/24/23.98 /P	SMPTE ST 2036-1 SMPTE ST 2082-10
			4096 × 2160	30/29.97/25/24/23.98 /P
RGB 4:4:4	10bit	3840 × 2160	30/29.97/25/24/23.98 /P	SMPTE ST 2036-1 SMPTE ST 2082-10
			4096 × 2160	30/29.97/25/24/23.98 /P
	12bit	3840 × 2160	30/29.97/25/24/23.98 /P	SMPTE ST 2036-1 SMPTE ST 2082-10
			4096 × 2160	30/29.97/25/24/23.98 /P

* You also need the SER28 and SER29.

IP Video Formats and Standards (SER05/SER06)

Supported IP Formats

SER05 SMPTE ST 2022-6, SMPTE ST 2110-20/30/31/40
SER06 SMPTE ST 2022-6, SMPTE ST 2110-20/30/31/40

Redundant System Compliant Standard

SMPTE ST 2022-7

Synchronization Mode

PTP (SMPTE ST 2059-1/2) *1

Supported Protocol

SER05 IPv4 (Internet Protocol version 4)
IGMPv2/v3 (Internet Group Management Protocol)
NMOS (IS-04 v1.2/IS-05 v1.0) *2
SER06 IPv4 (Internet Protocol version 4)
IGMPv2/v3 (Internet Group Management Protocol)
NMOS (IS-04 v1.2/IS-05 v1.0) *2

10G IP input signal formats (SER05, SER06)

Link	Compression	Color System	Quantization	Image	Frame Frequency / Scanning
HD	Uncompressed	YCbCr 4:2:2	10bit	1920x1080	60/59.94/50 /I
				1280x720 (*2)	60/59.94/50 /P
3G-A	Uncompressed	YCbCr 4:2:2	10bit	1920x1080	60/59.94/50 /P

25G IP input signal formats (SMPTE ST 2022-6) (SER06)

Link	Compression	Color System	Quantization	Image	Frame Frequency / Scanning
HD	Uncompressed	YCbCr 4:2:2	10bit	1920x1080	60/59.94/50 /I
				1280x720	60/59.94/50 /P
3G-A	Uncompressed	YCbCr 4:2:2	10bit	1920x1080	60/59.94/50 /P

25G IP input signal formats (SMPTE ST 2110-20) (SER06)

Link	Compression	Color System	Quantization	Image	Frame Frequency / Scanning
HD	Uncompressed	YCbCr 4:2:2	10bit	1920x1080	60/59.94/50 /I
				1280x720	60/59.94/50 /P
3G-A	Uncompressed	YCbCr 4:2:2	10bit	1920x1080	60/59.94/50 /P
4K (*4)	Uncompressed	YCbCr 4:2:2	10bit	3840x2160	60/59.94/50 /P

*1 Only SMPTE ST 2022 is supported.

*2 For NMOS control, the instrument's Ethernet port is used.

*3 SER28 must be installed to input 4K signals.

TSG Video Formats and Standards (SER24)

HD video signal formats and standards

Color System	Quantization	Image	Frame (Field) Frequency/Scanning	Supported Standard
YCbCr 4:2:2	10bit	1280x720	60/59.94/50 /P	SMPTE ST 292-1
			30/29.97/25/24/23.98 /P	SMPTE ST 296
		1920 × 1080	60/59.94/50 /I	SMPTE ST 274
			30/29.97/25/24/23.98 /P	SMPTE ST 292-1
		30/29.97/25/24/23.98 /PsF		

3G-A, 3G-B-DL video signal formats and standards

Color System	Quantization	Image	Frame (Field) Frequency/Scanning	Supported Standard
YCbCr 4:2:2	10bit	1920x1080	60/59.94/50/48/47.95 /P	SMPTE ST 274 SMPTE ST 425-1
			48/47.95 /P	-
YCbCr 4:4:4	10bit	1920x1080	60/59.94/50/48/47.95 /P	SMPTE ST 425-1 SMPTE ST 2048-2
			60/59.94/50 /I	SMPTE ST 274 SMPTE ST 425-1
RGB 4:4:4	10bit	1920x1080	30/29.97/25/24/23.98 /P	SMPTE ST 274 SMPTE ST 425-1
			30/29.97/25/24/23.98 /PsF	SMPTE ST 425-1 SMPTE ST 2048-2
		2048x1080	30/29.97/25/24/23.98 /P	SMPTE ST 274 SMPTE ST 425-1
			30/29.97/25/24/23.98 /PsF	SMPTE ST 425-1 SMPTE ST 2048-2

3G (DL)-4K video signal formats and standards

Square

Color System	Quantization	Image	Frame Frequency / Scanning	Supported Standard
YCbCr 4:2:2	10bit	3840x2160	30/29.97/25/24/23.98 /P	SMPTE ST 425-3 SMPTE ST 2036-1
			30/29.97/25/24/23.98 /PsF	-
		4096x2160	30/29.97/25/24/23.98 /P	SMPTE ST 425-3 SMPTE ST 2048-1
			30/29.97/25/24/23.98 /PsF	-

2-sample interleave

Color System	Quantization	Image	Frame Frequency / Scanning	Supported Standard
YCbCr 4:2:2	10bit	3840x2160	30/29.97/25/24/23.98 /P	SMPTE ST 425-3 SMPTE ST 2036-1
			30/29.97/25/24/23.98 /P	SMPTE ST 425-3 SMPTE ST 2048-1

* You also need the SER28

3G (QL) video signal formats and standards (square)

Color System	Quantization	Image	Frame Frequency / Scanning	Supported Standard
YCbCr 4:2:2	10bit	3840x2160	60/59.94/50 /P	SMPTE ST 425-5 SMPTE ST 2036-1
			48/47.95 /P	-
YCbCr 4:4:4	10bit	4096x2160	60/59.94/50/48/47.95 /P	SMPTE ST 425-5 SMPTE ST 2048-1
			30/29.97/25/24/23.98 /P	SMPTE ST 425-5 SMPTE ST 2036-1
RGB 4:4:4	10bit	3840x2160	30/29.97/25/24/23.98 /P	SMPTE ST 425-5 SMPTE ST 2036-1
			30/29.97/25/24/23.98 /PsF	-
		4096x2160	30/29.97/25/24/23.98 /P	SMPTE ST 425-5 SMPTE ST 2048-1
			30/29.97/25/24/23.98 /PsF	-

* SER28 is required separately.

* 3G-A, 3G-B-DL are supported.

3G (QL) video signal formats and standards (2-sample interleave)

Color System	Quantization	Image	Frame (Field) Frequency /Scanning	Supported Standard
Y _C B _C R 4:2:2	10bit	3840×2160	60/59.94/50 /P	SMPTE ST 425-5 SMPTE ST 2036-1
		4096×2160	60/59.94/50/48/47.95 /P	-
Y _C B _C R 4:4:4	10bit	3840×2160	30/29.97/25/24/23.98 /P	SMPTE ST 425-5 SMPTE ST 2036-1
		4096×2160	30/29.97/25/24/23.98 /P	SMPTE ST 425-5 SMPTE ST 2048-1
RGB 4:4:4	10bit	3840×2160	30/29.97/25/24/23.98 /P	SMPTE ST 425-5 SMPTE ST 2036-1
		4096×2160	30/29.97/25/24/23.98 /P	SMPTE ST 425-5 SMPTE ST 2048-1

* SER28 is required separately.
* 3G-A, 3G-B-DL are supported.

6G video signal formats and standards (2-sample interleave)

Color System	Quantization	Image	Frame (Field) Frequency /Scanning	Supported Standard
Y _C B _C R 4:2:2	10bit	3840×2160	30/29.97/25/24/23.98 /P	SMPTE ST 2036-1 SMPTE ST 2081-10
			30/29.97/25/24/23.98 /P	SMPTE ST 2048-1 SMPTE ST 2081-10

* SER28 and SER29 are required separately.

12G video signal formats and standards (2-sample interleave)

Color System	Quantization	Image	Frame (Field) Frequency /Scanning	Supported Standard
Y _C B _C R 4:2:2	10bit	3840×2160	60/59.94/50 /P	SMPTE ST 2036-1 SMPTE ST 2082-10
		4096×2160	60/59.94/50/48/47.95 /P	-
Y _C B _C R 4:4:4	10bit	3840×2160	30/29.97/25/24/23.98 /P	SMPTE ST 2048-1 SMPTE ST 2082-10
		4096×2160	30/29.97/25/24/23.98 /P	SMPTE ST 2036-1 SMPTE ST 2082-10
RGB 4:4:4	10bit	3840×2160	30/29.97/25/24/23.98 /P	SMPTE ST 2048-1 SMPTE ST 2082-10
		4096×2160	30/29.97/25/24/23.98 /P	SMPTE ST 2036-1 SMPTE ST 2082-10

* Type 1 of 12G-SDI is supported.
* SER28 and SER29 are required separately.

IP TSG option (SER32) IP video signal output formats and standards

SMPTE ST 2022-6

Color System	Quantization	Image	Frame (Field) Frequency /Scanning	Supported Standard
Y _C B _C R 4:2:2	10bit	1280x720	60/59.94/50 /P	SMPTE ST 2022-6
		1920x1080	60/59.94/50 /I	
		1920x1080	60/59.94/50 /P	

SMPTE ST 2110-20/30/40

Color System	Quantization	Image	Frame (Field) Frequency /Scanning	Supported Standard
Y _C B _C R 4:2:2	10bit	1280x720	60/59.94/50 /P	SMPTE ST 2110-20
		1920x1080	60/59.94/50 /I	
			60/59.94/50 /P	
		3840x2160	60/59.94/50 /P *1	

* Requires SER06.
*1 For 4K, only a single stream is supported. Requires SER28.

External synchronize input terminal

Input terminal BNC terminal
 Number of input terminals 1 line 2 terminals
 Input impedance 15 kΩ Passive loop through
 Input return loss 30 dB or more (50 kHz to 30 MHz, 75 Ω termination)
 Maximum input voltage ± 5 V (DC + peak AC)
 Input signal Tri-level sync or NTSC/PAL black burst signal
 (NTSC 10 field IDs are supported.)
 Function Video signal waveform display and phase difference display based on the phase of an external sync signal.
 Waveform display of external sync signal.

Headphone output terminal

Output terminal LV5600
 3.5 mm Mini jack 1 terminal (stereo)
 LV7600
 standard jack 1 terminal (stereo)
 Output signal On the screen of the displayed audio signal, arbitrary 2 ch (Downmixed Lt, Rt is also acceptable)

Monitor output terminal

SDI output terminal
 Function Output screen for SDI monitor
 Output terminal BNC terminal
 Number of output terminals 1
 Output signal Output liquid crystal display screen is output with HD, 3G-A, 3G-B-DL.
 1920 × 1080 60,59.94,50 I/P, YCBCR 4:2:2 (10bit)

TMDS output terminal

Function The displayed screen is output for HDMI monitor.
 Output terminal HDMI terminal
 Number of output terminals 1
 Signal format Single Link T.M.D.S
 DDC function Not supported
 HOT PLUG detection function Not supported
 Output signal Output liquid crystal display screen is output.
 1920x1080 60 P, 59.94 P, 50 P

Control terminal

USB terminal
 Terminal shape Standard A
 Number of terminals 2
 Standard USB 2.0
 Compatible device USB memory, USB mouse, touch panel type monitor

For Ethernet terminal control

Approved standard IEEE802.3
 Supported protocols TELNET, FTP, SNMP, HTTP, SNT
 Input/output terminals RJ-45
 Function Remote operation with an external PC or remote controller,
 File transfer, get status information
 Types 10Base-T, 100Base-TX, 1000Base-T

Remote terminal

Terminal shape D Sub 15 pins (female)
 Number of terminals 1
 Control signal LV- TTL level (LOW active)
 Function Preset recall, input signal switching, alarm output, tally
 Alarm output When a format alarm, various errors, fan abnormality, or internal temperature occurs

RS-422/485 terminal (LV5600-SER27/ LV7600-SER27)

Function Reception of tally, camera ID, camera iris signal
 Terminal shape RJ-45
 Number of terminals 2

Display (LV5600)

Liquid crystal display 7 type TFT color liquid crystal
 Resolution 1920x1080
 Refresh rate 60 Hz, 59.94 Hz, 50 Hz
 (Free run or frequency synchronization to external synchronization signal)
 Touch panel Electrostatic capacity type touch panel

General specifications

Environmental conditions	
Operating temperature	0 to 40 °C
Operating humidity range	85% RH or less (no condensation)
Optimal Temperature	10 to 30 °C
Operating Environment	Indoors
Elevation	up to 2,000 m
Overvoltage category	II
Pollution degree	2
Power Requirements	
Voltage	AC 90 to 250 V
Frequency	50/60 Hz
Power consumption	160 W max.

Dimensions(excluding protrusions)

LV5600	215 (W)x132 (H)x298 (D) mm
LV7600	426 (W)x44 (H)x300 (D) mm

Weight(including options, excluding accessories)

LV5600	4.6 kg max.
LV7600	4.2 kg max.

Accessories

LV5600、LV7600	Power cord	x1
	Cover inlet stopper	x1
	D sub 15 pin connector	x1
	D sub 15 pin connector cover	x1
	Manual (CR-ROM)	x1
LV5600-SER03/LV7600-SER03	D sub 37 pin connector	x1
	D sub 37 pin connector cover	x1
LV5600-SER06/LV7600-SER06	IP 1/2 / SFP conversion adapte	x2

Related accessories

LR2561 RACKMOUNT ADAPTER

LR2561 is a rack mount adapter that allows two LV5600s to be mounted side by side or an LV5600 and LV5350 or LV5300A to be mounted side by side in an EIA 19-inch rack. Please be advised that the LV5350 and LV5300A can only be installed on the right side of the LR2561. If you install only one LV5600, LV5350 or LV5300A in the LR2561, you can also install an LC2566 blank panel (sold separately). LR2561 supports both short bar and long Bar rack installations using the included bars.



LC2566 BLANK PANEL

The LC2566 is a blank panel for the LR2561 rack mount adapter. Use it when installing a single LV5600 waveform monitor in the LR2561.



SFP + Transceiver

LC2148 (SFP+ MULTI-MODE)
 Transmission Distance : 300m
 Wave length : 850nm
 Supported standards : 10GBASE-SR/SW
 Connector : LC
 Supported options : LV5600-SER05, LV5600-SER06,
 LV7600-SER05, LV7600-SER06



LC2145 (SFP+ SINGLE-MODE)

Transmission Distance : Max 10,000m
 Wave length : 1310nm
 Supported standards : 10GBASE-LR/LW
 Connector : LC
 Supported options : LV5600-SER05, LV5600-SER06,
 LV7600-SER05, LV7600-SER06



LC2151 (SFP28 MULTI-MODE)

Transmission Distance : Max 70m
 Wave length : 850nm
 Supported standards : 25GBASE-LR/LW
 Connector : LC
 Supported options : LV5600-SER06, LV7600-SER06



LC2147 (SFP28 SINGLE-MODE)

Transmission Distance : Max 10,000m
 Wave length : 1310nm
 Supported standards : 25GBASE-LR/LW
 Connector : LC
 Supported options : LV5600-SER06, LV7600-SER06



LV7290 Remote Controller

The LV7290 remote controller connects to the Ethernet port on the rear panel of the LV5600/LV7600 and can be used to remotely control the LV5600/LV7600. A single unit can connect and control up to eight LV5600/LV7600s.

Dimensions and weight: 482 (W) X 44 (H) X 110 (D) mm
 (excluding protrusions), 1.2 kg



LV5600

With LV5600-SER05

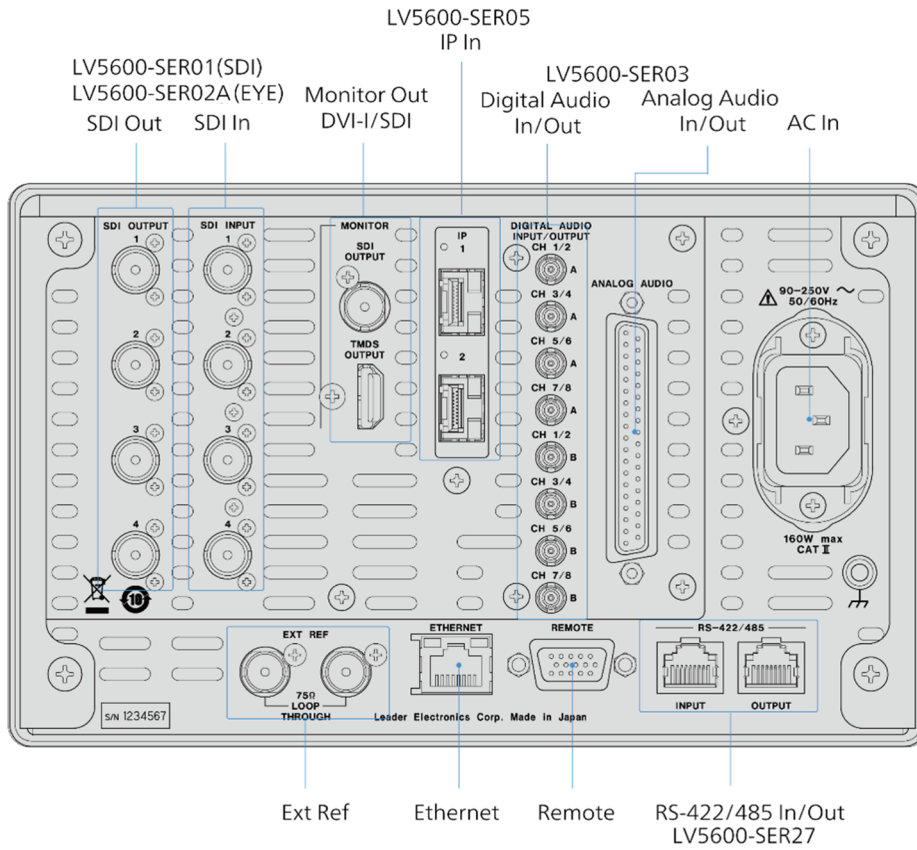

With LV5600-SER06

LV5600-SER06 25G IP In
LV5600-SER32 25G IP TSG out

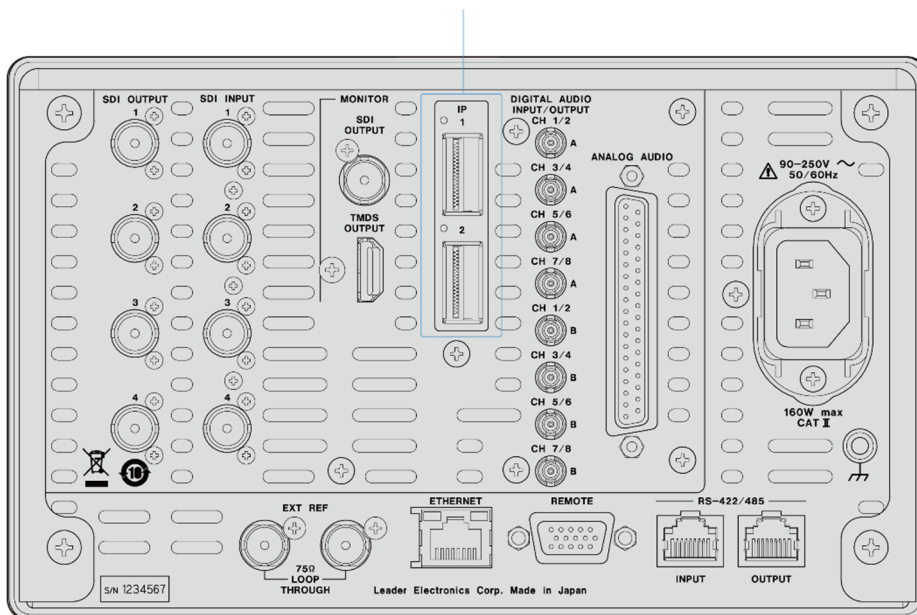

LV7600

With LV7600-SER05

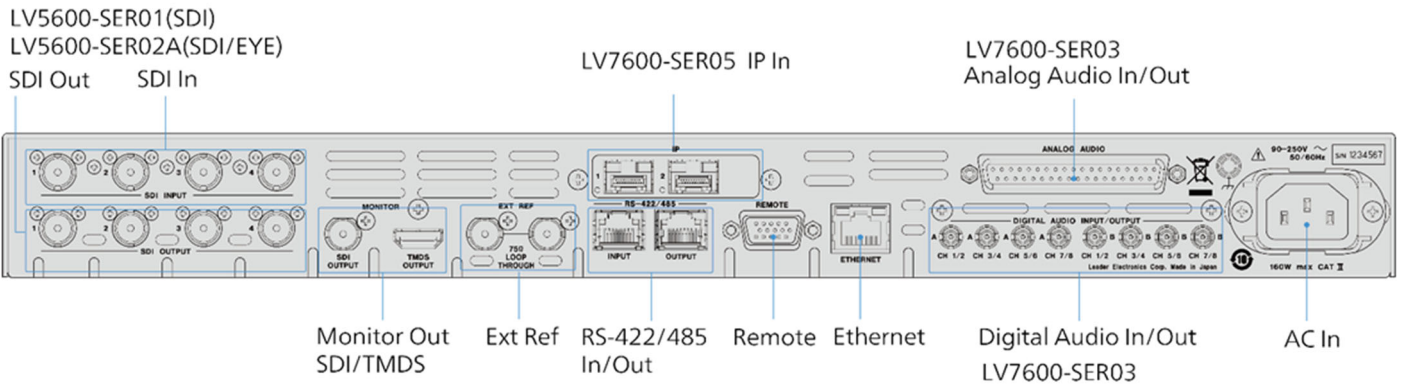

With LV7600-SER06

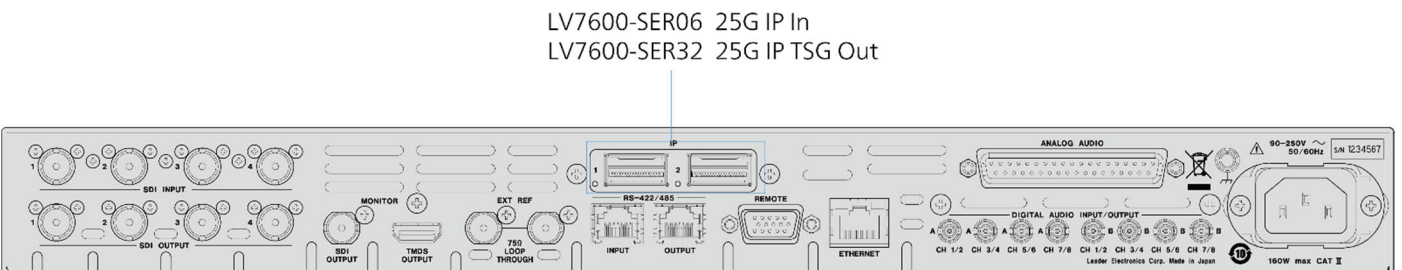

LV5600

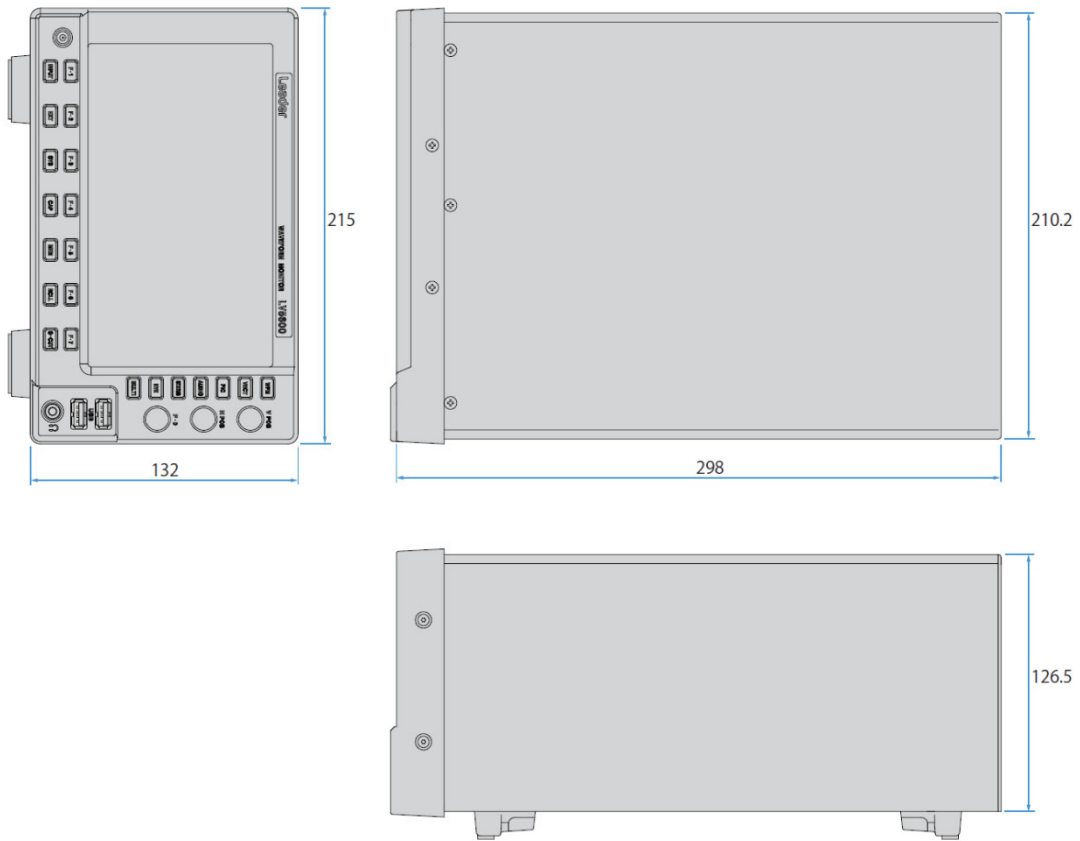

LV7600

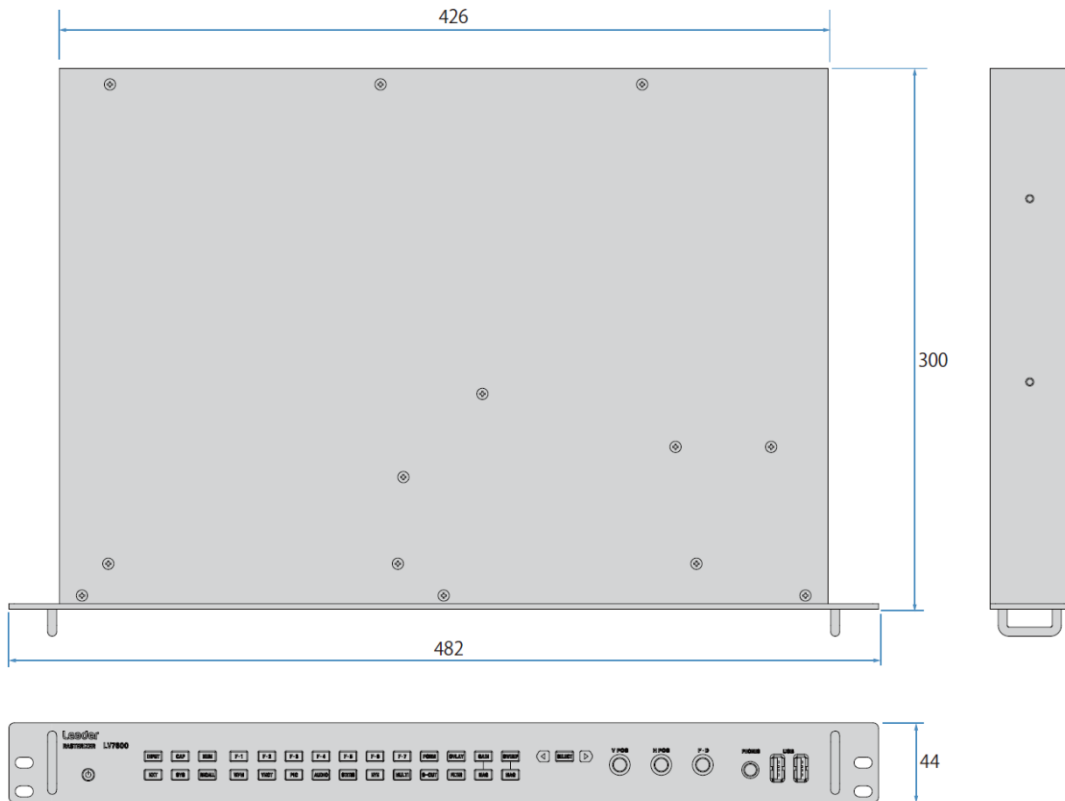

Leader

LV5300A MULTI WAVEFORM MONITOR



LV5350 MULTI WAVEFORM MONITOR



LV7300 RASTERIZER



General

The LV5300A/LV5350/LV7300 are a space-saving, compact waveform monitor and rasterizer family designed for 4K/UHDTV/HD/SD-SDI video signals. The LV5300A/LV5350 are a waveform monitor with a 7-inch touch screen display in a compact, short-depth 3 RU enclosure optionally operated with battery power supply. The LV7300 is a 1RU half rack sized rasterizer. It is compact but supports eye pattern measurement up to 12G-SDI.

Features

Supports wide range of SDI Video

These monitors and rasterizers support SDI signals from SD formats up to 12G-SDI. Detailed embedded audio analysis is also available.

Unmatched ease of use

The front panel offers familiar, dedicated buttons and knobs for simple operation and training. Additionally, the units can be controlled via a USB mouse. The LV5300A/LV5350 uses a 7-inch full HD panel with a touchscreen, and the LV7300 can be operated and set intuitively by touch operation by connecting an external touch-enabled LCD monitor with a USB cable.

* While most external touch-capable LCD monitors are compatible, not all vendors' products can be guaranteed.

SDI input format

SD-SDI, HD-SDI, 3G-SDI, 6G-SDI, 12G-SDI Single Link is supported.

SDI and IP analysis

For engineering and troubleshooting needs, the LV5300A/LV5350 and LV7300 offer monitoring of SDI transmission errors, external synchronization phase difference, lip sync, SDI signal frequency deviation, and ancillary data analysis.

Video analysis

The LV5300A/LV5350 and LV7300 provide a full set of video displays including waveform, vector, 5 BAR gamut, and CIE chromaticity diagram. In addition to the various displays, quality of experience (QoE) monitoring such as freeze, black, gamut help ensure all potential issues with content are easily diagnosed.

xy chromaticity coordinate display

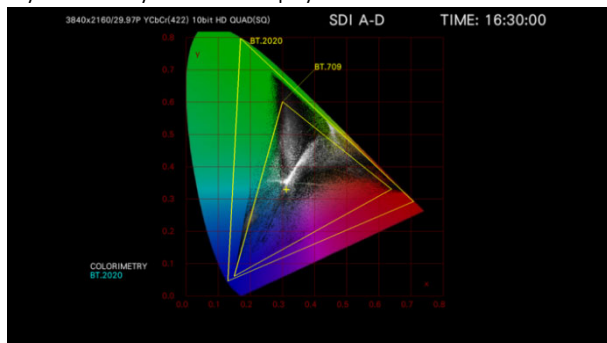

Audio analysis

Embedded SDI audio can be displayed and monitored using level meters, Lissajous display, mute, and clip error detection. Audio format is compatible with L-PCM.

Eye pattern display

From SD-SDI to 12G-SDI Full physical layer measurement of the SDI signal including eye pattern display and jitter allows for detailed engineering evaluations of SDI signal paths.

Eye pattern

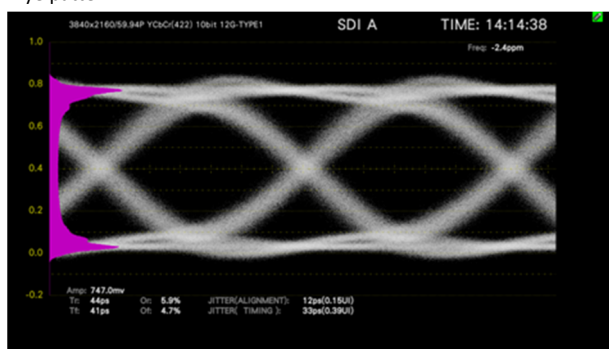

Subtitles and closed caption decode

CEA-608, CEA-708 closed captioning, Teletext, Japanese subtitles, and OP47 subtitle embedded in the SDI signal can be verified and displayed in the video.

External synchronization signal input

The phase difference and synchronization status of each SDI video signal is shown graphically based on the external synchronization signal (black burst, tri-level sync).

Fully customizable layout

Various items such as waveforms, vector displays, audio bars, gamut views, and pictures of input signals can be laid out in any position with your preferred size.

SDI signal generation

A built-in generator provides SDI test signals, useful for device or network troubleshooting. The generator supports HD-SDI through 12G-SDI with HD multi format color bar and patterns, multiple overlays of moving boxes and embedded audio, flat field at any level, and a 4K multi format color bar.

*For 4K/UHDTV format only 12G-SDI is possible.

External monitor output

The screen can be output to an external SDI monitor or HDMI monitor with full HD resolution.

*Does not guarantee the operation with all HDMI monitors.

*The LV5300A / LV5350 do not support external monitor output.

Capture data for analysis

Capture the display screen as still image data or use the frame capture function to capture up to 16 frames of data.

Time code display

The time code may be superimposed on SDI video signals. The time code can also be used as the timestamp of the event log.

External remote terminal

The presets can be recalled by remote terminals, and users can switch input signals, tally displays or output alarms.

Ethernet connectivity

The LV5600 and LV7600 support remote operation by TELNET, file transfer by FTP, remote operation by SNMP and alarm notification, remote operation and monitoring from a web-browser via HTTP.

HDR capable

HDR signal level monitoring and luminance management accounting for OOTF is straightforward. The waveform display in HDR scale is added to the IRE scale. Furthermore, in the CINEZONE™ display, the luminance distribution of HDR and SDR in the picture can be easily confirmed, with SDR content appearing in monochrome gray scale while HDR is colored according to the brightness.

HDR zone display

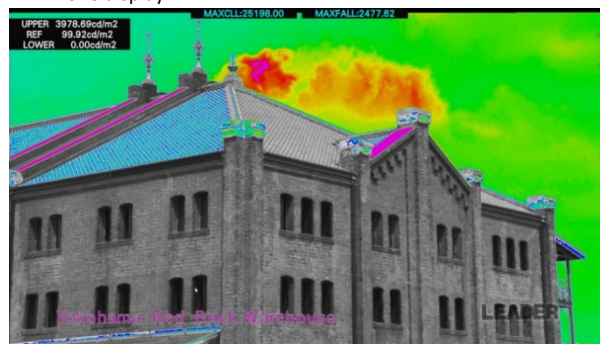

Focus assist

We developed a new focus detection algorithm based on proprietary nonlinear super-resolution technology. Focus is determined with high sensitivity and repeatability even under difficult, low-contrast images.

Tally display

Serial communication allows display of camera ID, iris and tally. Fast switching of tally display by remote terminal is also possible.

■ List of hardware options

Model Name	Type Number			Description
	LV5300A	LV5350	LV7300	
SDI INPUT	—	LV5350 standard	LV7300-SER01	SD,HD,3G SDI input *
SDI INPUT/EYE	LV5300A standard	—	LV7300-SER02	SD,HD,3G SDI input and eye pattern display *
BATTERY ADAPTER V MOUNT	LV5300-SER11	LV5350-SER11	—	Battery adapter: V-Mount
BATTERY ADAPTER QR GOLD	LV5300-SER12	LV5350-SER12	—	Battery adapter: QR-Gold

* For LV7300, either LV7300-SER01 and LV7300-SER02 are selected, but one of them is necessary.

■ List of Software options

Model Name	Type Number			Description
	LV5300A	LV5350	LV7300	
AUDIO	LV5300-SER20	LV5350-SER20	LV7300-SER20	Embedded audio analysis
CLOSED CAPTION	LV5300-SER21	LV5350-SER21	LV7300-SER21	Japanese subtitles, EIA-608,708/TELETEXT
CIE	LV5300-SER22	LV5350-SER22	LV7300-SER22	CIE display
HDR	LV5300-SER23	LV5350-SER23	LV7300-SER23	HDR analysis
TSG	LV5300-SER24	LV5350-SER24	LV7300-SER24	SDI signal generation
FOCUS ASSIST	LV5300-SER25	LV5350-SER25	LV7300-SER25	Focus assist
LAYOUT	LV5300-SER26	LV5350-SER26	LV7300-SER26	Customized layout function / Display assignment function
TALLY	LV5300-SER27	LV5350-SER27	LV7300-SER27	Tally displays
4K	LV5300-SER28	LV5350-SER28	LV7300-SER28	4K 6G/12G SDI format support
EXTENDED VEC	LV5300-SER40	LV5350-SER40	LV7300-SER40	Extended vector display function

■ Related accessories

Product Name	Model	Related products			Remarks
		LV5300A	LV5350	LV7300	
RACK-MOUNT ADAPTER	LR2530	○	○		Dual rack mount adapter for the LV5300/LV5350. Two LV5300A / LV5350 can be mounted in an EIA 19-inch rack. (Two options of LV5300A + LV5350 need separately option compatibility.)
BLANK PANEL	LC2535	○	○		Blank panel for the LR2530
RACK-MOUNT ADAPTER	LR2561	○	○		LR2561 is a rack mount adapter that allows two LV5600s to be mounted side by side or an LV5600 and LV5350 or LV5300A to be mounted side by side in an EIA 19-inch rack.*
BLANK PANEL	LC2566	○	○		Blank panel for the LR2561
RACK-MOUNT ADAPTER	LR2731			○	Single rack mount adapter to install in a 19-inch EIA standard rack. One side is a blank panel.
RACK-MOUNT ADAPTER	LR2732			○	Dual rack mount adapter to install in a 19-inch EIA standard rack. It allows two sets of LV7300 to be installed side by side.
AC ADAPTER	GST90A12	○	○	Includ	AC adapter for LV5300A/LV5350/LV7300 (Included as a standard accessory for the LV7300)
REMOTE CONTROLLER	LV7290	○	○	○	One remote controller can be connected up to 8 units of waveform monitor or rasterizer via Ethernet. .

* Please be advised that the LV5350 and LV5300A can only be installed on the right side of the LR2561.

LV5350 standard / LV7300-SER01 SDI Input

LV5300A standard / LV7300-SER02 SDI input with eye pattern

Both the LV5350 and LV5300A monitor SDI signals. The LV5300A can also display EYE pattern.

The LV7300 can be configured with or without an EYE pattern display.

Video analysis

The LV5300A / 5350 / 7300 provide a full set of video displays including waveform, vector, 5 BAR gamut, CINELITE™ II, and CIE chromaticity diagram. In addition to the various displays, quality of experience (QoE) monitoring such as freeze, black, gamut, help ensure all potential issues with content are easily diagnosed.

Audio support

Embedded SDI audio can be displayed on meters for basic level and presence monitoring.

Approved standard	SMPTE ST 299, SMPTE ST 272 48 kHz/24 bit/L-PCM
Synchronization	All are synchronized with the video clock. All input SDI signals are synchronized.
Display channels	8ch
Display dynamic range	SDI embedded audio
Level accuracy	-60dBFS/-90dBFS/Reference level ±3dB ±0.3dB (-50 to 0dBFS, 1kHz, signal source impedance 40Ω or less)
Frequency characteristics	30Hz to 20kHz ±0.4dB (4dBu, 1kHz reference, TRUE PEAK response) 20Hz to 20kHz +0.4dB, -0.6dB (4dBu, 1kHz reference, TRUE PEAK response)
Meter response model	TRUE PEAK/PPM type I/PPM type II/VU
Peak hold time	0.0 to 5.0 sec (0.5-sec steps)/HOLD
Level setting	-40.0 to 0.0dBFS (reference level, warning over level)

Lissajous, surround and status can be displayed by adding LV5300-SER20/LV5350-SER20/LV7300-SER20

SDI data analysis

The status display summarizes CRC and embedded audio errors in the SDI signal. An event log, data dump, and phase difference measurements can be used to troubleshoot.

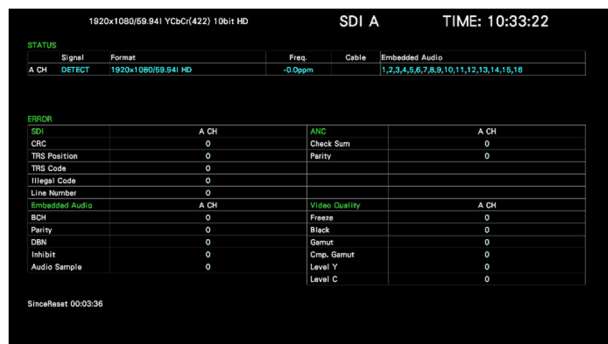

Screen capture function

A screen capture function to capture the display screen as still image data and a frame capture function to capture 16 frames of data are available. The captured data can be saved in BMP format in comparison with the input signal, as well as the display on the monitor, and allowing confirmation with an external PC.

Time code display

Embedded time code data can be verified and displayed. The time code can also be used as the timestamp of the event log.

SDI Inputs and outputs

Two (2) SDI inputs BNC connector

Two (2) SDI outputs BNC connector

Output re-clock signal

The SDI signals of the input terminals relock output to the output terminals, respectively.

Select re-clock signal

The signals of the input terminals can be switched/relock output.

BT.709 compatible vectorscope scale

UHDTV (ARIB STD-B66) and HLG color bars (ARIB STD-B67) contain BT.2020 and BT.709 colors. This allows quick verification of the vector coordinates of a BT.709 color bar, useful for BT.2020 and BT.709 video content production.

BT.709 color bar vector display

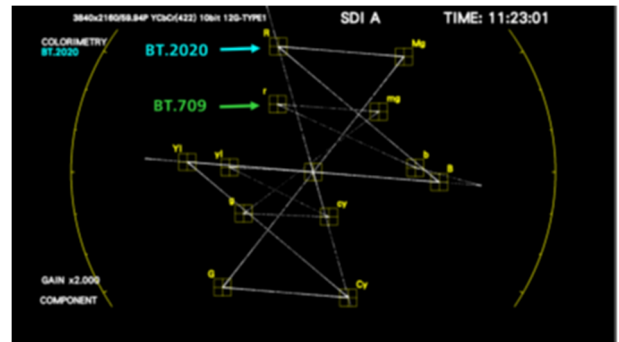

SCTE-104 compatible for ANC data analysis function

In Japan, ARIB-STD B39 (NET-Q) is used for starting and replacing commercials while in other countries SCTE-104 is commonly used.

Recently, SCTE104 has been used in operation systems in Japan too.

We support SCTE-104 for efficient operation worldwide.

SCTE-104 packet display (text display)

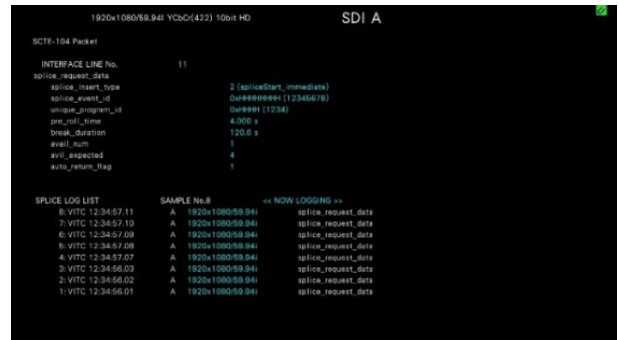

SCTE-104 detection display (Picture Screen)



SR Live Metadata display

The ZEN series waveform monitors and rasterizers LV5600/LV7600/LV5350/LV5300A/LV7300 decode and display the “SR Live Metadata” packet used by Sony Imaging Products & Solutions Inc(“Sony”).

SR Live Metadata display

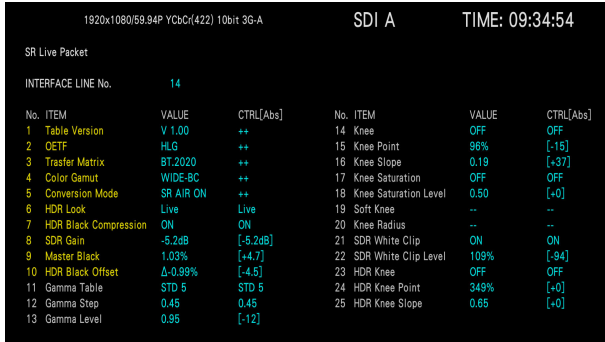

Eye pattern display (LV5300A standard/ LV7300-SER02)

Displays SDI signal eye pattern waveforms and jitter waveforms, and parameter measurements. Only SDI input 1 supports the eye pattern display. A histogram view is also available.

An eye pattern obtained with a 100kHz or higher filter (alignment jitter) and the eye pattern obtained with a 10Hz or higher filter (timing jitter) can be displayed together.

SDI input terminal Display	SDI INPUT 1
Displays the waveform of the SDI input signal before it is equalized.	
Screen	
1-screen display	The eye pattern for the selected filter is displayed on one screen.
2-screen display	The eye pattern for the timing filter and eye pattern for the selected filter are displayed on two screens.
Waveform display color	Selectable from seven colors.
Scale display color	Selectable from seven colors.
Method	ETS
Amplitude accuracy	800mV±5% (to 800mV input)
Time-axis display	2UI, 4UI, 16UI
Time-axis accuracy	±3%
Jitter filter	10Hz, 100Hz, 1kHz, 100kHz, TIMING, ALIGNMENT
Cursor measurement	Amplitude measurement/time measurement
Automatically measured items	Amplitude, rising edge, falling edge, timing jitter, and jitter overshoot
Histogram view	Displays the frequency distribution of the eye pattern waveform amplitude.

Concurrent display

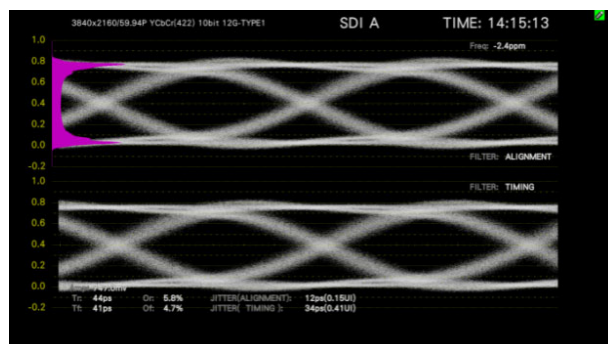

*Upper: 100kHz or higher filter, Lower: 10Hz or higher filter, Magenta: Histogram

LV5300-SER11 / LV5350-SER11

Battery adapter: V-Mount

V mount adapter for battery compatible with IDX battery.

LV5300-SER12 / LV5350-SER12

Battery adapter: QR-Gold

QR Golden Mount Adapter for Battery Compatible with Anton Bauer Battery.

LV5300-SER11 V Mount



LV5300-SER12 Antonbauer



LV5300-SER20 / LV5350-SER20 / LV7300-SER20

Embedded audio analysis

Lissajous display, surround display, mute, clip error detection, etc. are added with this option. Numerous analysis displays are available, and simultaneously display of 8 channels from one SDI signal and 4 channels from 2 SDI signals is possible. Embedded audio playback system complies with SMPTE ST 299, 272.

Audio display

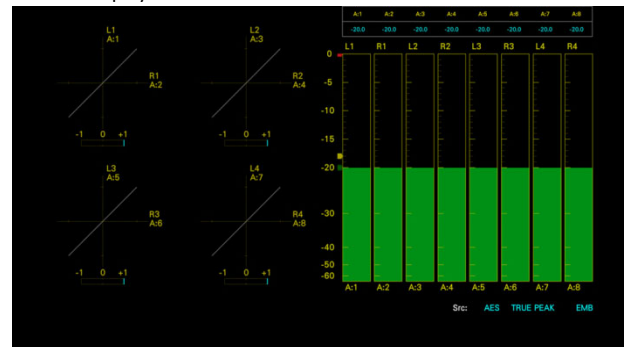

Embedded Audio

Approved standard SMPTE ST 299, SMPTE ST 272
48 kHz/24 bit/L-PCM

Synchronization condition: All are synchronized with the video clock. All input SDI signals are synchronized.

Lissajous display

Display channels 2ch x 1/2ch x 4
Display method X-Y/MATRIX
Correlator Indicates a value between -1 and 1 for the correlation between two channels.

Channel assignments

SINGLE LISSAJOU L/R
MULTI LISSAJOU L1/R1 to L4/R4

Surround display

Function Graphically displays the sound field.
Surround system 5.1ch
Channel assignments L/R/C/LFE/Ls/Rs/Lt/Rt

Status display

Level value	Indicates the audio level as a (dBFS) value
Error detection	Counts the number of errors that occurred on each channel.
Level over	Counts the number of times the input signal level exceeds the specified value.
Detection setting	-40.0 to 0.0dBFS
Clip	Counts the number of times a maximum value signal exceeding the specified number of samples is input successively.
Detection setting	1 to 100 samples
Mute	Counts the number of times a mute signal exceeding the specified duration of time is input successively.
Detection setting	1 to 5000ms
Parity error	Counts the number of times the parity bit of an input signal differs from the re-calculated parity value.
Validity error	Counts the number of times that the validity bit of an input signal is 1.
CRC error	Counts the number of times the CRC value of the channel status bit differs from the re-calculated CRC value.
Code violation	Counts the number of times the bi-phase modulation of an input signal is abnormal.

Lip sync measurement

Function	Measures the time difference between the SDI signal and digital audio signal and shows measurements as a value and on a graph.
Reference signal	Leader lip sync function.
Luminous level setting value	25 to 100%
Audio signal level setting value	-30 to 0dBFS
Supported audio signal	Embedded audio signal
Measurement range (bar display)	$\pm 50\text{ms}$ / $\pm 100\text{ms}$ / $\pm 500\text{ms}$ / $\pm 1.0\text{s}$ / $\pm 2.5\text{s}$
Measurement range (value display)	$\pm 3999\text{ms}$
Measurement resolution	1ms

* TSG patterns other than ours can be supported by configuring video signal settings and audio signal settings.

Lip sync display

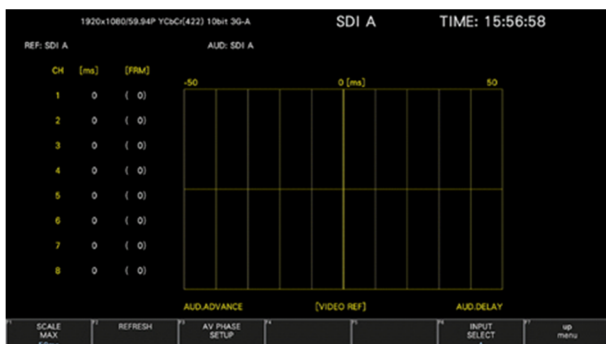

LV5300-SER21 / LV5350-SER21 / LV7300-SER21

Closed captioning

Closed captioning

CEA-608, CEA-708 closed caption, teletext, OP47 subtitle embedded in an SDI signal can be decoded and displayed.

Superimpose Display

Displays English closed captions, European closed captions, and Japanese closed captions over the picture

English Closed Caption

Compliant Standards (Mapping Standards)

EIA-708	SMPTE ST 334
EIA/CEA-608-B (EIA-708-B)	SMPTE ST 334
EIA/CEA-608-B (EIA/CEA-608-B)	SMPTE ST 334
VBI (EIA/CEA-608-B Line21)	CIA/EIA-608-B

Supported Video Formats

SD, HD, 3G-A, 3G-B-DL,
3G(DL)-4K (close caption decoding only for link 1),
6G (close caption decoding only for sub 1),
12G (close caption decoding only for sub 1)

European Closed Caption

Compliant Standards

Teletext	VBI (ITU-R BT. 653-3 System B) (SD only), OP47
----------	---

Closed caption display



Simple Japanese Closed Caption Display

Displays a simple Japanese closed caption on the picture display. (Select HD, SD, analog, or portable closed caption to display. Select language 1 or 2.)

Compliant Standard ARIB STD-B37 short form data

Supported Video Formats

SD, HD, 3G-A,
3G(DL)-4K(close caption decoding only for link 1) *,
12G (close caption decoding only for sub 1) *

Display

Display position control is supported only for HD and SD closed captions.

Characters

Only Kanji, roman numerals, katakana, hiragana, additional characters (ARIB STD-B24), additional kanji (ARIB STD-B24), and 1-byte DRCS are displayed.

Character Sizes

Supports only standard, medium, small, and specified size Codes

Logging

Logged Events Clear screen command, text closed caption display event, time code, TV commercial material check result

Data Format Text

* Requires SER28.

LV5300-SER22 / LV5350-SER22 / LV7300-SER22

CIE chart display function

A chromaticity display of ITU-R BT. 601, ITU-R BT. 709, ITU-R BT. 2020 colorimetry. The display mode supports CIE 1931 (xy display) and CIE 1976 (u'v' display). Since the CIE chart can display two color gamuts, the tool can be used to suppress the color gamut of BT.709 using the equipment compatible with BT.2020, and to confirm the content that exceeds the color gamut of BT.709. In color display, the chromaticity point is displayed using the color (on the picture) in the video signal. The chromaticity can be measured at any pixel with the cursor.

xy chromaticity coordinate display

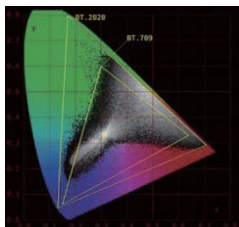

u'v' chromaticity coordinate display

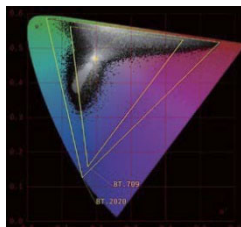

xy coordinate color indication

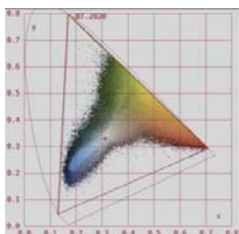

A light blue is a measurement function cursor

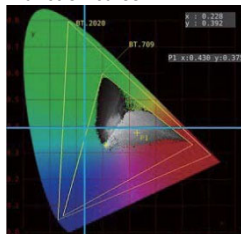

LV5300-SER23 / LV5350-SER23 / LV7300-SER23

HDR analysis

In addition to HLG and PQ per ITU-R BT.2100, this option also supports level monitoring of S-log3 HDR signals. Level management can be made using the assumed luminance (cd/m²) in a display considering OOTF. The video waveform includes the HDR scale added to the IRE scale. In the CINEZONE™ display, the luminance distribution of the HDR area can be easily confirmed with the SDR area shown in monochrome, and the HDR content with a color according to the brightness.

Approved standard

ITU-R BT. 2100 (HLG, PQ), S-Log 3, C-Log, Log-C

Supported format

All formats except SD-SDI.

HDR Scale

By associating waveform and histogram with the HDR scale, management of the video with brightness is simplified.

HDR zone display

The luminance distribution of the HDR area can be easily confirmed by coloring the SDR area with monochrome and the HDR with a color according to the brightness.

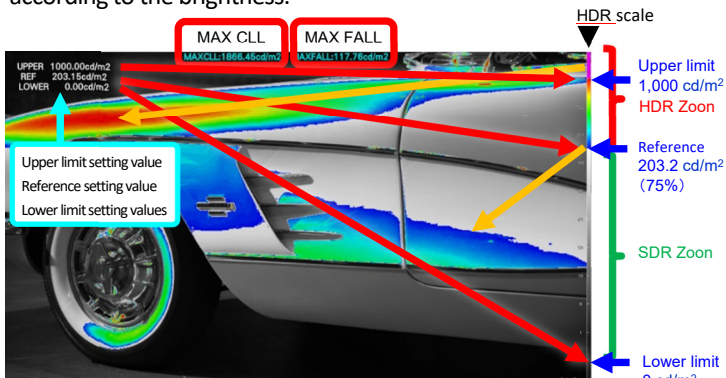

The SDR part is monochrome, the HDR region is colored according to luminance. Above the upper limit value is colored with magenta. The upper limit value, the reference value, the lower limit value can be varied.

HDR waveform display

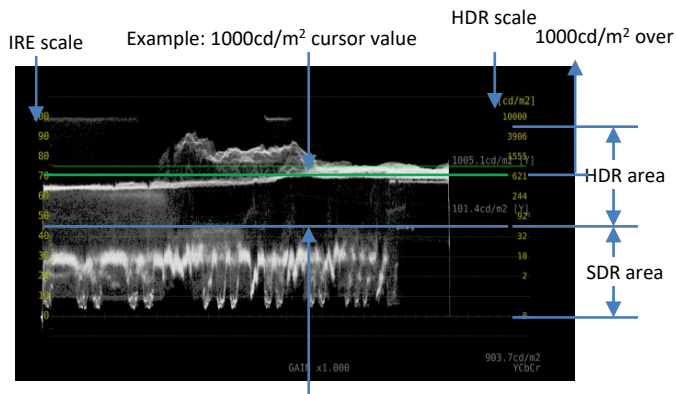

PQ setting

Example: 100cd/m² cursor value

HDR point measurement

The crosshair cursor can be freely moved, with up to 3 points measured simultaneously.



PQ setting

P1(S: 884,L: 261)3243.6cd/m2

HLG setting SYSTEM GAMMA OFF

P1(S: 884,L: 261) 623.9%

HLG setting System Gamma On

P1(S: 884,L: 261) 456.1cd/m2

S-Log3 setting System Gamma Off

P1(S: 884,L: 261) 809.1%

LV5300-SER24 / LV5350-SER24 / LV7300-SER24

SDI signal generation

The optional generator provides SDI test signals, useful for device or network troubleshooting. The generator supports HD-SDI through 12G-SDI with HD multi format color bar and patterns, multiple overlays of moving boxes and embedded audio, flat field at any level, and a 4K multi format color bar.

* The SDI signal generation function of 12G-SDI requires LV5300-SER28/LV5350-SER28 /LV7300-SER28options.

* The LV5300A/LV5350/LV7300 are output from the SDI output terminal 2 according to the output setting.

Output pattern

100% color bar, 75% color bar, HD multifformat color bar *1, 4K multifformat color bar *1, color raster, gamma, cross hatch, 10 step, limit lamp, check field, lip sync pattern(SER20), HDR color bar (SER23) *1

Scrolling *2

Direction

ON/OFF

8 directions (up and down, left and right, and combinations thereof)

Speed range and unit

4 to 124 dots per frame (field), 4 dot units.

Moving Box *2

Color

ON/OFF

WHITE, YELLOW, CYAN, GREEN, MAGENTA, RED, BLUE, BLACK

Speed

1 to 3

Embedded audio

- Number of Embedded Channels 16channels max. *3
- Embedding On/Off On/off at the audio group level
- Audio Level -20d BFS, -18 dBFS, 0 dBFS, mute
- Audio Frequency 1kHz
- CRC Error Addition An incorrect CRC is inserted into the Y component of the first line.

*1 It cannot be set in horizontal 1280, 4096, and 2048 pixel format.
 *2 Either scrolling, or moving box can be selected.
 *3 For 4096 × 2160 6G and 2048 × 1080 3G-B-DL, only 8 channels are embedded.

Customized layout setting screen

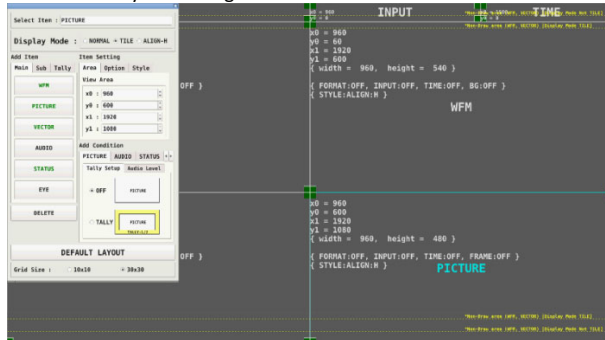

LV5300-SER25 / LV5350-SER25 / LV7300-SER25

Focus assist

This option adds a new, proprietary focus detection algorithm based on nonlinear super-resolution technology to aid in scene focus conditions. Focus is determined with high sensitivity and repeatability even with difficult, low-contrast images. In addition, sensitivity can be selected from 5 levels according to the video scene.

Focus assist display



After focus adjustment
 (The green part is the focus adjustment point)

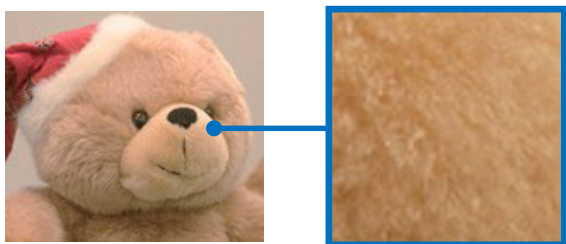

Enlarged view (After focus adjustment)

Layout Set measurement screen

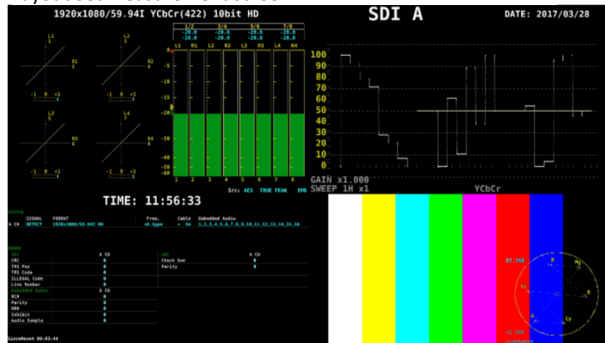

LV5300-SER27 / LV5350-SER27 / LV7300-SER27

Tally display

Fast switching of tally display by remote terminal is possible. For the camera ID, a fixed name can be assigned to each channel in the setting of this unit.

Tally display

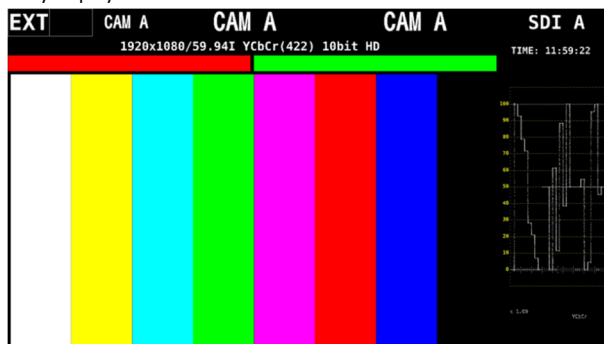

LV5300-SER28 / LV5350-SER28 / LV7300-SER28

4K/UHDTV video

Adds support for 4K/UHDTV signals via 12G/6G- SDI single link.
 *12G/6G-SDI signal is input terminal 1 only.

LV5300-SER40 / LV5350-SER40 / LV7300-SER40

Extended vector display function

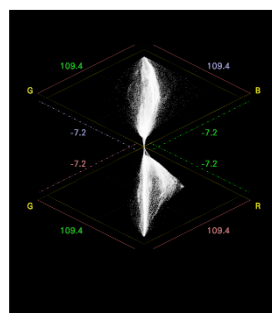

RGB VECTOR

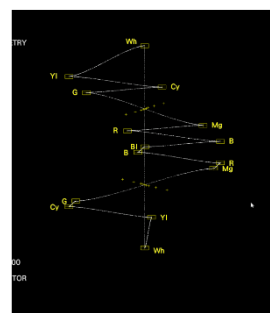

YCbCr VECTOR

LV5300-SER26 / LV5350-SER26 / LV7300-SER26

Customized layout

Users can size and position all video displays, waveforms, vectorscopes, gamut views, audio tools, etc as desired to optimize the screen for any specific workflow or user. Two input signals can be displayed simultaneously, or one input signal can be displayed on multiple screens.

Specifications

SDI video signal formats and standard

SD video signal format and standard

Color System	Quantization	Image	Field Frequency /Scanning	Supported Standard
YCbCr 4:2:2	10bit	720 × 487	59.94 /I	SMPTE ST 259
		720 × 576	50 /I	

HD video signal format and standard

Color System	Quantization	Image	Frame (Field) Frequency /Scanning	Supported Standard
YCbCr 4:2:2	10bit	1280 × 720	60/59.94/50/30/29.97/25/24/23.98 /P	SMPTE ST 292-1 SMPTE ST 296
			60/59.94/50 /I	SMPTE ST 274
			30/29.97/25/24/23.98 /P	SMPTE ST 292-1
		1920 × 1080	60/59.94/50 /I	SMPTE ST 274
			30/29.97/25/24/23.98 /P	SMPTE ST 292-1
			30/29.97/25/24/23.98 /PsF	SMPTE ST 292-1

3G-A video signal format and standard

Color System	Quantization	Image	Frame (Field) Frequency /Scanning	Supported Standard
YCbCr 4:2:2	10bit	1920 × 1080	60/59.94/50 /P	SMPTE ST 274 SMPTE ST 425-1
			48/47.95 /P	-
		2048 × 1080	60/59.94/50/48/47.95 /P	SMPTE ST 425-1 SMPTE ST 2048-2
	12bit	1920 × 1080	60/59.94/50 /I	SMPTE ST 274 SMPTE ST 425-1
			30/29.97/25/24/23.98 /P	SMPTE ST 425-1
		2048 × 1080	30/29.97/25/24/23.98 /P 30/29.97/25/24/23.98 /PsF	SMPTE ST 425-1 SMPTE ST 2048-2
YCbCr 4:4:4	10bit	1280 × 720	60/59.94/50/30/29.97/25/24/23.98 /P	SMPTE ST 296 SMPTE ST 425-1
			60/59.94/50 /I	SMPTE ST 274
			30/29.97/25/24/23.98 /P	SMPTE ST 425-1
		1920 × 1080	30/29.97/25/24/23.98 /PsF	SMPTE ST 425-1
			30/29.97/25/24/23.98 /P	SMPTE ST 2048-2
			30/29.97/25/24/23.98 /PsF	SMPTE ST 2048-2
	12bit	1920 × 1080	60/59.94/50 /I	SMPTE ST 274 SMPTE ST 425-1
			30/29.97/25/24/23.98 /P	SMPTE ST 274 SMPTE ST 425-1
			30/29.97/25/24/23.98 /PsF	SMPTE ST 425-1 SMPTE ST 2048-2
		2048 × 1080	60/59.94/50 /I	SMPTE ST 274 SMPTE ST 425-1
			30/29.97/25/24/23.98 /P	SMPTE ST 425-1 SMPTE ST 2048-2
			30/29.97/25/24/23.98 /PsF	SMPTE ST 425-1 SMPTE ST 2048-2
RGB 4:4:4	10bit	1280 × 720	60/59.94/50/30/29.97/25/24/23.98 /P	SMPTE ST 296 SMPTE ST 425-1
			60/59.94/50 /I	SMPTE ST 274
			30/29.97/25/24/23.98 /PsF	SMPTE ST 425-1
		1920 × 1080	30/29.97/25/24/23.98 /P	SMPTE ST 425-1
			30/29.97/25/24/23.98 /PsF	SMPTE ST 2048-2
			30/29.97/25/24/23.98 /PsF	SMPTE ST 2048-2
	12bit	1920 × 1080	60/59.94/50 /I	SMPTE ST 274 SMPTE ST 425-1
			30/29.97/25/24/23.98 /P	SMPTE ST 274 SMPTE ST 425-1
			30/29.97/25/24/23.98 /PsF	SMPTE ST 425-1 SMPTE ST 2048-2
		2048 × 1080	60/59.94/50 /I	SMPTE ST 274 SMPTE ST 425-1
			30/29.97/25/24/23.98 /P	SMPTE ST 425-1 SMPTE ST 2048-2
			30/29.97/25/24/23.98 /PsF	SMPTE ST 425-1 SMPTE ST 2048-2
XYZ 4:4:4	12bit	2048 × 1080	30/25/24 /P	SMPTE ST 425-1
			30/25/24 /PsF	SMPTE ST 428

3G-B-DL video signal formats and standard

Color System	Quantization	Image	Frame (Field) Frequency /Scanning	Supported Standard
YCbCr 4:2:2	10bit	1920 × 1080	60/59.94/50 /P	SMPTE ST 274 SMPTE ST 372 SMPTE ST 425-1
			48/47.95 /P	-
		2048 × 1080	60/59.94/50/48/47.95 /P	SMPTE ST 372 SMPTE ST 425-1 SMPTE ST 2048-2
	12bit	1920 × 1080	60/59.94/50 /I	SMPTE ST 274 SMPTE ST 372
			30/29.97/25/24/23.98 /P	SMPTE ST 372 SMPTE ST 425-1
		2048 × 1080	30/29.97/25/24/23.98 /P 30/29.97/25/24/23.98 /PsF	SMPTE ST 372 SMPTE ST 425-1 SMPTE ST 2048-2
YCbCr 4:4:4	10bit	1920 × 1080	60/59.94/50 /I	SMPTE ST 274
			30/29.97/25/24/23.98 /P	SMPTE ST 372
			30/29.97/25/24/23.98 /PsF	SMPTE ST 425-1
		2048 × 1080	30/29.97/25/24/23.98 /P	SMPTE ST 372 SMPTE ST 425-1
			30/29.97/25/24/23.98 /PsF	SMPTE ST 2048-2
			30/29.97/25/24/23.98 /PsF	SMPTE ST 2048-2
	12bit	1920 × 1080	60/59.94/50 /I	SMPTE ST 274
			30/29.97/25/24/23.98 /P	SMPTE ST 372
			30/29.97/25/24/23.98 /PsF	SMPTE ST 425-1
		2048 × 1080	60/59.94/50 /I	SMPTE ST 274
			30/29.97/25/24/23.98 /P	SMPTE ST 372
			30/29.97/25/24/23.98 /PsF	SMPTE ST 425-1

RGB 4:4:4	10bit	1920 × 1080	60/59.94/50 /I	SMPTE ST 274
			30/29.97/25/24/23.98 /P	SMPTE ST 372
		30/29.97/25/24/23.98 /PsF	SMPTE ST 425-1	
	2048 × 1080	30/29.97/25/24/23.98 /P	SMPTE ST 372 SMPTE ST 425-1	
		30/29.97/25/24/23.98 /PsF	SMPTE ST 2048-2	
		30/29.97/25/24/23.98 /PsF	SMPTE ST 2048-2	
XYZ 4:4:4	12bit	1920 × 1080	60/59.94/50 /I	SMPTE ST 274
			30/29.97/25/24/23.98 /P	SMPTE ST 372
		30/29.97/25/24/23.98 /PsF	SMPTE ST 425-1	
	2048 × 1080	30/29.97/25/24/23.98 /P	SMPTE ST 372 SMPTE ST 425-1	
		30/29.97/25/24/23.98 /PsF	SMPTE ST 2048-2	
		30/29.97/25/24/23.98 /PsF	SMPTE ST 2048-2	

3G(DL)-4K Video Signal Formats and Standards

Square

Color System	Quantization	Image	Frame (Field) Frequency /Scanning	Supported Standard
YCbCr 4:2:2	10bit	3840 × 2160	30/29.97/25/24/23.98 /P	SMPTE ST 425-3 SMPTE ST 2036-1
			30/29.97/25/24/23.98 /PsF	-
		4096 × 2160	30/29.97/25/24/23.98 /P	SMPTE ST 425-3 SMPTE ST 2048-1
			30/29.97/25/24/23.98 /PsF	-

2 sample interleave

Color System	Quantization	Image	Frame (Field) Frequency /Scanning	Supported Standard
YCbCr 4:2:2	10bit	3840 × 2160	30/29.97/25/24/23.98 /P	SMPTE ST 425-3 SMPTE ST 2036-1
			30/29.97/25/24/23.98 /PsF	-
		4096 × 2160	30/29.97/25/24/23.98 /P	SMPTE ST 425-3 SMPTE ST 2048-1
			30/29.97/25/24/23.98 /PsF	-

* You also need the SER28.

* When these signals are displayed, phase differences of up to 100 clocks (approx. 0.67μs) between links are automatically corrected.

* 3G-B-DS links are supported.

6G video signal formats and standards (2 sample interleave)

Color System	Quantization	Image	Frame Frequency /Scanning	Supported Standard
YCbCr 4:2:2	10bit	3840 × 2160	30/29.97/25/24/23.98 /P	SMPTE ST 2036-1 SMPTE ST 2081-10
		4096 × 2160	30/29.97/25/24/23.98 /P	SMPTE ST 2036-1 SMPTE ST 2082-10

* Type 1 of 12G-SDI is supported.

12G video signal formats and standards (2 sample interleave)

Color System	Quantization	Image	Frame Frequency /Scanning	Supported Standard
YCbCr 4:2:2	10bit	3840 × 2160	60/59.94/50 /P	SMPTE ST 2036-1 SMPTE ST 2082-10
			48/47.95/P	-
		4096 × 2160	60/59.94/50/48/47.95 /P	SMPTE ST 2036-1 SMPTE ST 2082-10
	12bit	3840 × 2160	30/29.97/25/24/23.98 /P	SMPTE ST 2036-1 SMPTE ST 2082-10
			4096 × 2160	30/29.97/25/24/23.98 /P
		4096 × 2160	30/29.97/25/24/23.98 /P	SMPTE ST 2036-1 SMPTE ST 2082-10
YCbCr 4:4:4	10bit	3840 × 2160	30/29.97/25/24/23.98 /P	SMPTE ST 2036-1 SMPTE ST 2082-10
			4096 × 2160	30/29.97/25/24/23.98 /P
		12bit	3840 × 2160	30/29.97/25/24/23.98 /P
	4096 × 2160			30/29.97/25/24/23.98 /P
	4096 × 2160		30/29.97/25/24/23.98 /P	SMPTE ST 2036-1 SMPTE ST 2082-10
	RGB 4:4:4	10bit	3840 × 2160	30/29.97/25/24/23.98 /P
4096 × 2160				30/29.97/25/24/23.98 /P
12bit			3840 × 2160	30/29.97/25/24/23.98 /P
		4096 × 2160		30/29.97/25/24/23.98 /P
		4096 × 2160	30/29.97/25/24/23.98 /P	SMPTE ST 2036-1 SMPTE ST 2082-10

* Type 1 of 12G-SDI is supported.

TSG (SER24) SDI video signal formats and standard

HD video signal formats and standards

Color System	Quantization	Image	Frame (Field) Frequency /Scanning	Supported Standard
YCbCr 4:2:2	10bit	1280x720	60/59.94/50 /P	SMPTE ST 292-1
			30/29.97/25/24/23.98 /P	SMPTE ST 296
		1920x1080	60/59.94/50 /I	SMPTE ST 274
			30/29.97/25/24/23.98 /P	SMPTE ST 292-1
		30/29.97/25/24/23.98 /PsF		

3G-A, 3G-B-DL video signal formats and standards

Color System	Quantization	Image	Frame (Field) Frequency /Scanning	Supported Standard
YCbCr 4:2:2	10bit	1920x1080	60/59.94/50/48/47.95 /P	SMPTE ST 274
			48/47.95 /P	SMPTE ST 425-1
		2048x1080	60/59.94/50/48/47.95 /P	SMPTE ST 425-1
				SMPTE ST 2048-2
YCbCr 4:4:4	10bit	1920x1080	60/59.94/50 /I	SMPTE ST 274
			30/29.97/25/24/23.98 /P	SMPTE ST 425-1
		2048x1080	30/29.97/25/24/23.98 /PsF	SMPTE ST 425-1
			30/29.97/25/24/23.98 /P	SMPTE ST 2048-2
RGB 4:4:4	10bit	1920x1080	60/59.94/50 /I	SMPTE ST 274
			30/29.97/25/24/23.98 /P	SMPTE ST 425-1
		2048x1080	30/29.97/25/24/23.98 /PsF	SMPTE ST 425-1
			30/29.97/25/24/23.98 /P	SMPTE ST 2048-2

6G video signal formats and standards(2-sample interleave)

Color System	Quantization	Image	Frame (Field) Frequency /Scanning	Supported Standard
YCbCr 4:2:2	10bit	3840x2160	30/29.97/25/24/23.98 /P	SMPTE ST 2036-1
		4096x2160	30/29.97/25/24/23.98 /P	SMPTE ST 2081-10
				SMPTE ST 2048-1
				SMPTE ST 2081-10

* You also need the SER28.

12G video signal formats and standards (2-sample interleave)

Color System	Quantization	Image	Frame (Field) Frequency /Scanning	Supported Standard
YCbCr 4:2:2	10bit	3840x2160	60/59.94/50 /P	SMPTE ST 2036-1
			48/47.95 /P	SMPTE ST 2082-10
		4096x2160	60/59.94/50/48/47.95 /P	SMPTE ST 2048-1
				SMPTE ST 2082-10
YCbCr 4:4:4	10bit	3840x2160	30/29.97/25/24/23.98 /P	SMPTE ST 2036-1
				SMPTE ST 2082-10
		4096x2160	30/29.97/25/24/23.98 /P	SMPTE ST 2048-1
				SMPTE ST 2082-10
RGB 4:4:4	10bit	3840x2160	30/29.97/25/24/23.98 /P	SMPTE ST 2036-1
				SMPTE ST 2082-10
		4096x2160	30/29.97/25/24/23.98 /P	SMPTE ST 2048-1
				SMPTE ST 2082-10

* You also need the SER28.

External synchronize input terminal

Input terminal	BNC terminal
Number of input terminals	1 line 2 terminals
Input impedance	15 kΩ Passive loop through
Input return loss	30 dB or more (50 kHz to 30 MHz, 75 Ω termination)
Maximum input voltage	± 5 V (DC + peak AC)
Input signal	Ternary synchronization signal or NTSC/PAL black burst signal
	10 Field ID correspondence
Function	SDI reference signal input for video signal waveform display and phase difference display

Headphone output terminal

Output terminal	
LV5300A/LV5350	3.5 mm Mini jack 1 terminal (stereo)
LV7300	Standard jack 1 terminal (stereo)
Output signal	On the screen of the displayed audio signal, arbitrary 2ch (Downmixed Lt, Rt is also acceptable)

Monitor output terminal

SDI output terminal	
Function	Output screen for SDI monitor
Output terminal	BNC terminal
Number of output terminals	1
Output signal	Output liquid crystal display screen is output with HD, 3G-A, 3G-B-DL. 1920 × 1080 60,59.94,50 I/P, YCbCr 4:2:2(10bit)

* LV7300 outputs SDI monitor output terminal, LV5300A, LV5350 switch output of SDI output 2 terminal

TMDS output terminal (LV7300)

Function	The displayed screen is output for HDMI monitor.
Output terminal	HDMI terminal
Number of output terminals	1
Signal format	Single Link T.M.D.S
DDC function	Not supported
HOT PLUG detection function	Not supported
Output signal	Output liquid crystal display screen is output. 1920x1080 60 P, 59.94 P, 50 P

Control terminal

USB terminal

Terminal shape	Standard A
Number of terminals	2
Standard	USB 2.0
Compatible device	USB memory, USB mouse, touch panel type monitor

For Ethernet terminal control

Approved standard	IEEE802.3
Supported protocols	TELNET, FTP, SNMP, HTTP, SNTP
Input/output terminals	RJ-45

Function	Remote operation with an external PC or remote controller, File transfer, get status information
----------	--

Types 10Base-T, 100Base-TX, 1000Base-T

Remote terminal

Terminal shape	D Sub 15 pins (female)
Number of terminals	1
Control signal	LV- TTL level (LOW active)
Function	Preset recall, input signal switching, alarm output, tally
Alarm output	When a format alarm, various errors, fan abnormality, or internal temperature occurs

Display (LV5300A / LV5350)

Liquid crystal display	7 type TFT color liquid crystal
Resolution	1920x1080
Refresh rate	60 Hz, 59.94 Hz, 50 Hz (Free run or frequency synchronization to external synchronization signal)
Touch panel	Electrostatic capacity type touch panel

General specifications

Environmental conditions

Operating temperature range	0 to 40 °C
Operating humidity range	85% RH or less (no condensation)
Optimal Temperature	10 to 30 °C
Operating Environment	Indoors
Elevation	up to 2,000 m
Overvoltage category	I
Pollution degree	2

Power supply

Voltage	DC 10 to 18 V
Power consumption (DC Power supply)	
LV5300A	80W max.
LV5350	60W max.
LV7300	80W max.

Dimensions(excluding protrusions)

LV5300A	215 (W)x132 (H)x132(D) mm
LV5350	215 (W)x132 (H)x85(D) mm
LV7300	213 (W)x44 (H)x300 (D) mm
Weight(excluding accessories and battery option)	
LV5300A	2.95 kg max.
LV5350	2.5 kg max.
LV7300	2.25 kg max.

Accessories

AC adapter(LV7300 only)	x1
D sub 15 pin connector	x1
D sub 15 pin connector cover	x1
Manual (CR-ROM)	x1

LR2530 RACKMOUNT ADAPTER

The LR2530 is a dual rack mount adapter used to install LV5300A/LV5350 waveform monitors in a 19-inch EIA standard rack. It allows two sets of LV5300A/LV5350 to be installed side by side. (Two options of LV5300A + LV5350 need separately option compatibility.)
Compatible models: LV5300A / LV5350



LC2535 BLANK PANEL

The LC2535 is a blank panel for the LR2530 rack mount adapter. Use it when installing a single LV5350 waveform monitor in the LR2530.



LR2731 RACKMOUNT ADAPTER

The LR2731 is a rack mount adapter used to install a LV7300 rasterizer in a 19-inch EIA standard rack. Because one side is a blank panel, use it to install a single LV7300.

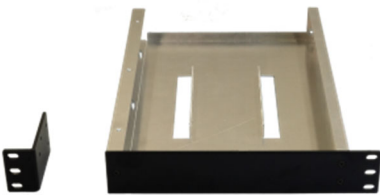

LR2732 RACKMOUNT ADAPTER

The LR2732 is a dual rack mount adapter used to install LV7300 rasterizers in a 19-inch EIA standard rack. It allows two sets of LV7300 to be installed side by side.



GST90A12 AC Adapter

An AC adapter exclusive to Leader products. An AC cord is included.
* An AC adapter is attached to the LV7300.



LV7290 Remote Controller

The LV7290 remote controller connects to the Ethernet port on the rear panel of the LV5300A/LV5350/LV7300 and can be used to remotely control the LV5300A/LV5350/LV7300. A single unit can connect and control up to eight LV5300A/LV5350/LV7300s.

Dimensions and weight: 482 (W) X 44 (H) X 110 (D) mm (excluding protrusions), 1.2 kg



LV7290

LV5300A

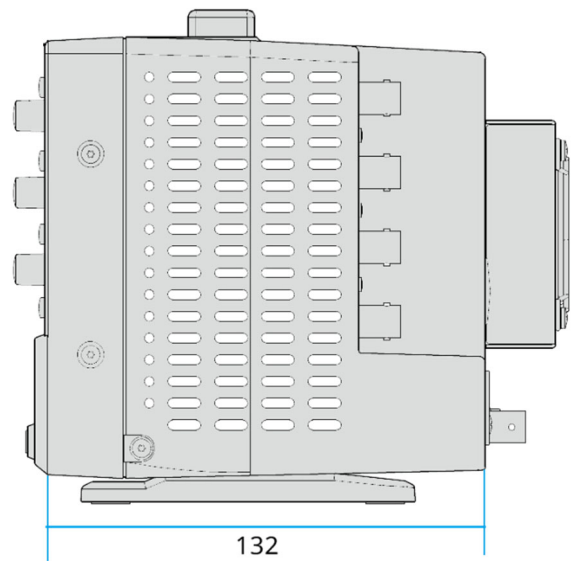
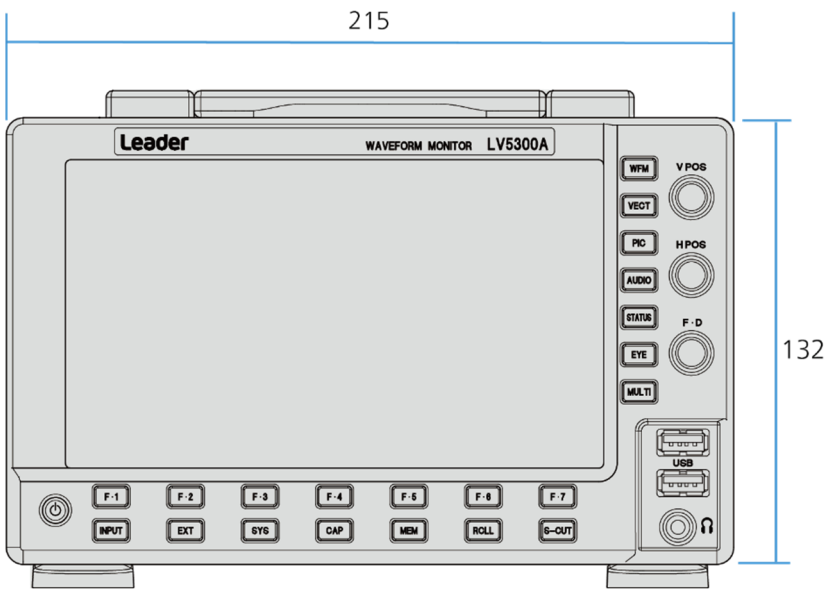
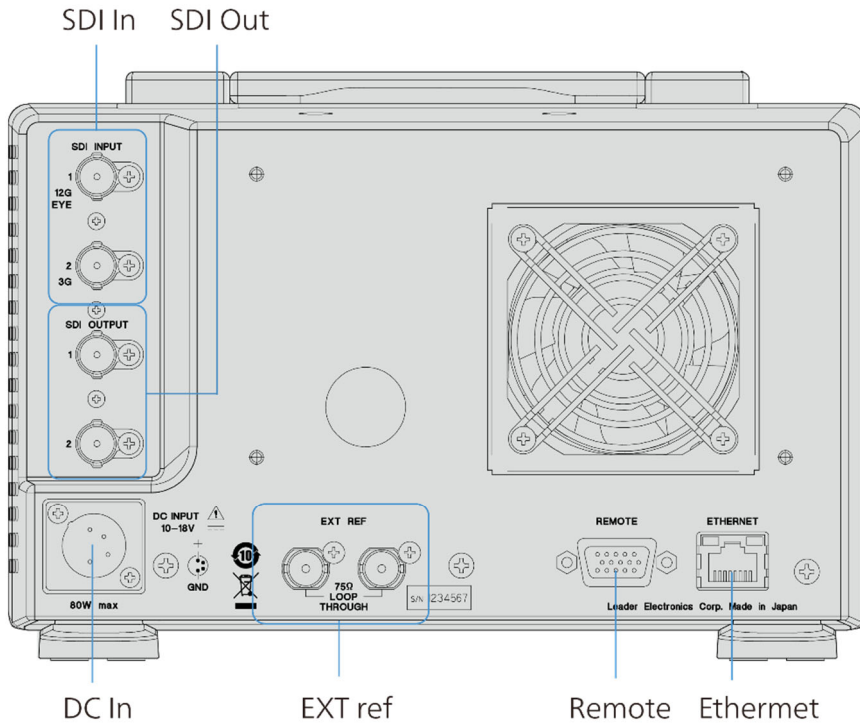

LV5350

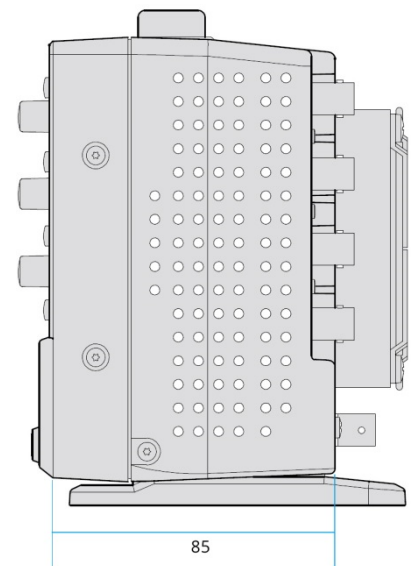
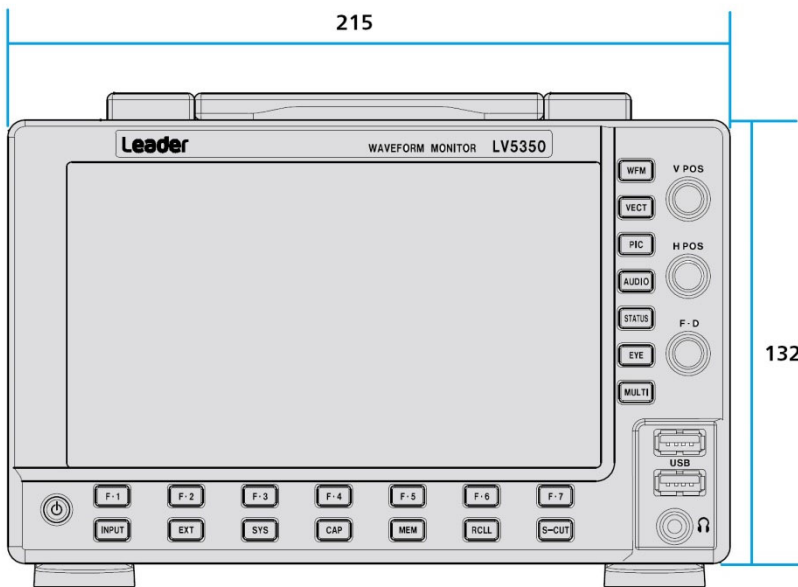
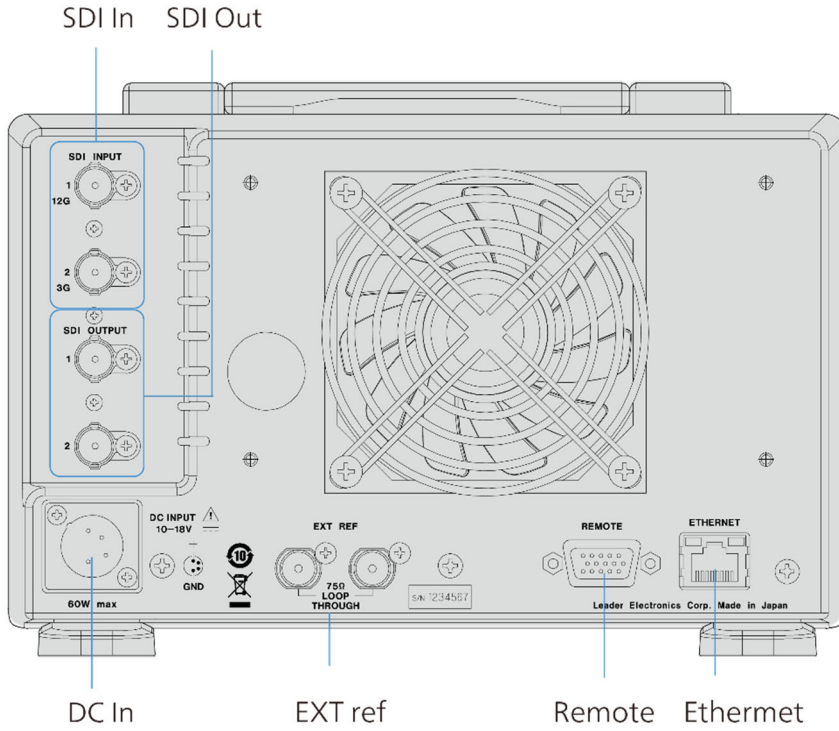

LV7300

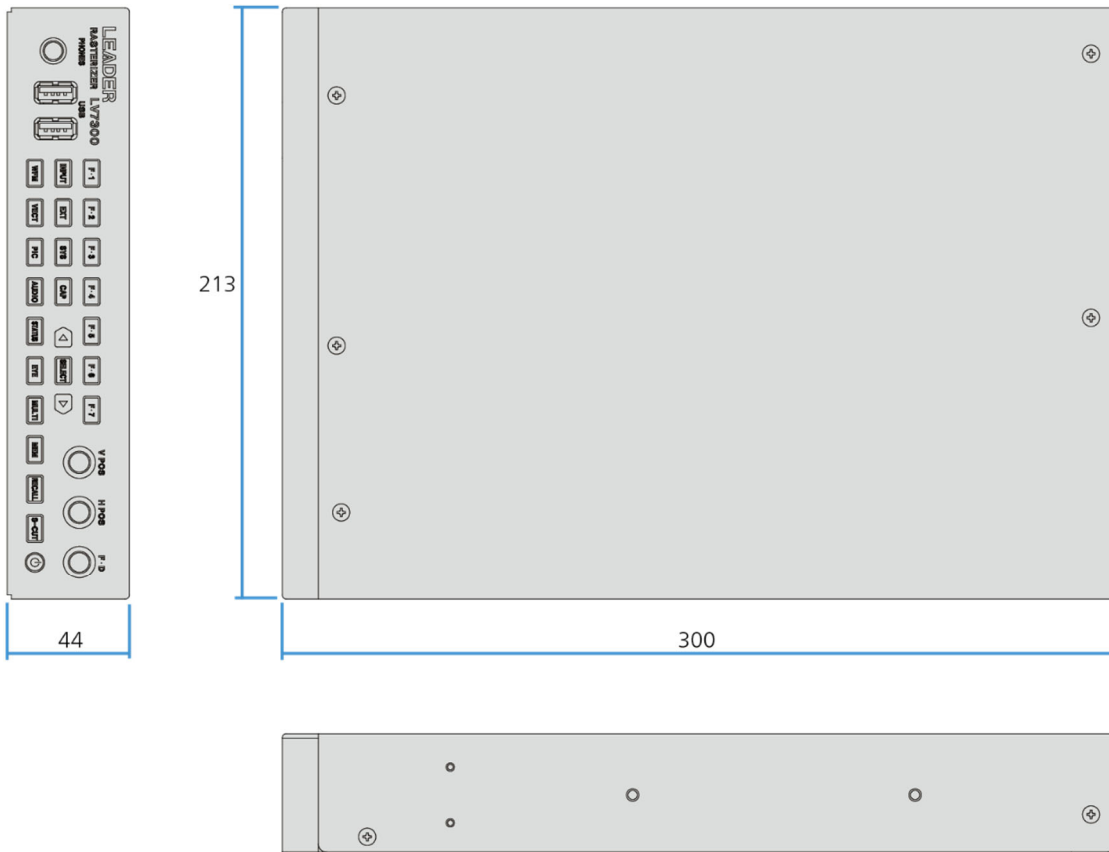
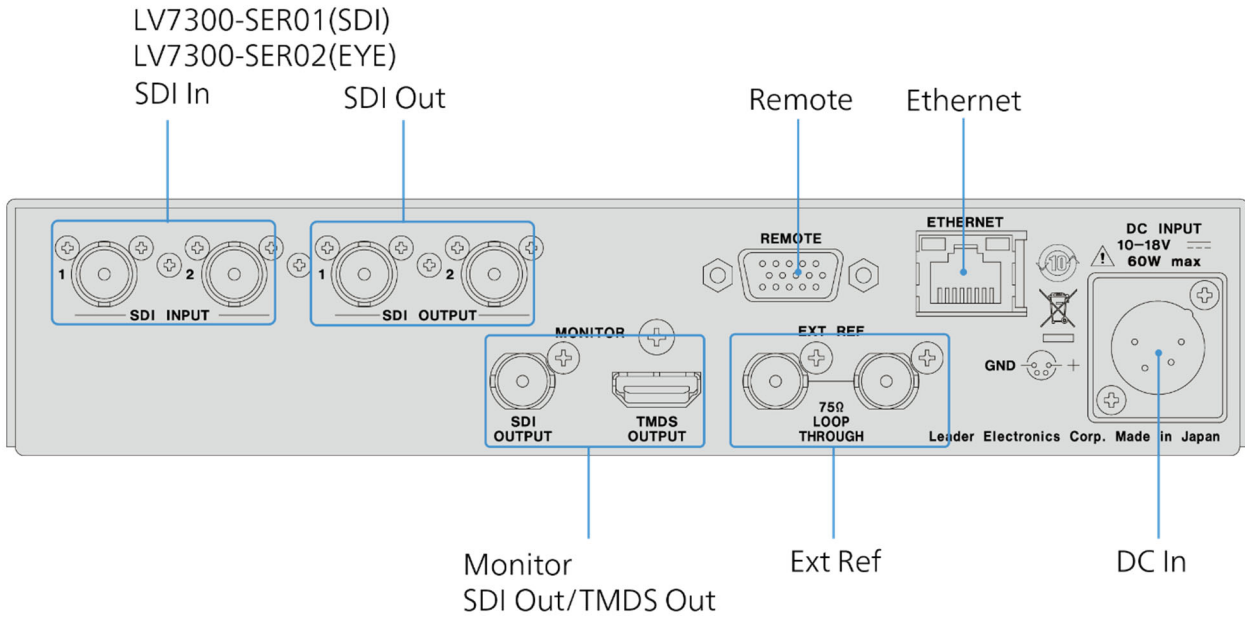

www.leader.co.jp/en

Leader Electronics Corporation

2-6-33 Tsunashima-higashi, Kohoku-ku, Yokohama 223-8505 Japan

Tel: +81-45-541-2123 Email: sales@leader.co.jp

- **Leader Instruments Corporation**
- **Latin America Branches**
- **Leader Europe limited (UK)**
- **Leader Korea Co., Ltd.**
- **JiaLong Leader (Beijing) Trading Co., Ltd.**
- **Shanghai Branch**
- **Leader Singapore Branch**
- **Taiwan Representative Office**

Specified product specifications are subject to change without notice. Dec , 2021