

Getting Down
to Earth

Megger[®]

**A practical
guide to
earth resistance
testing**

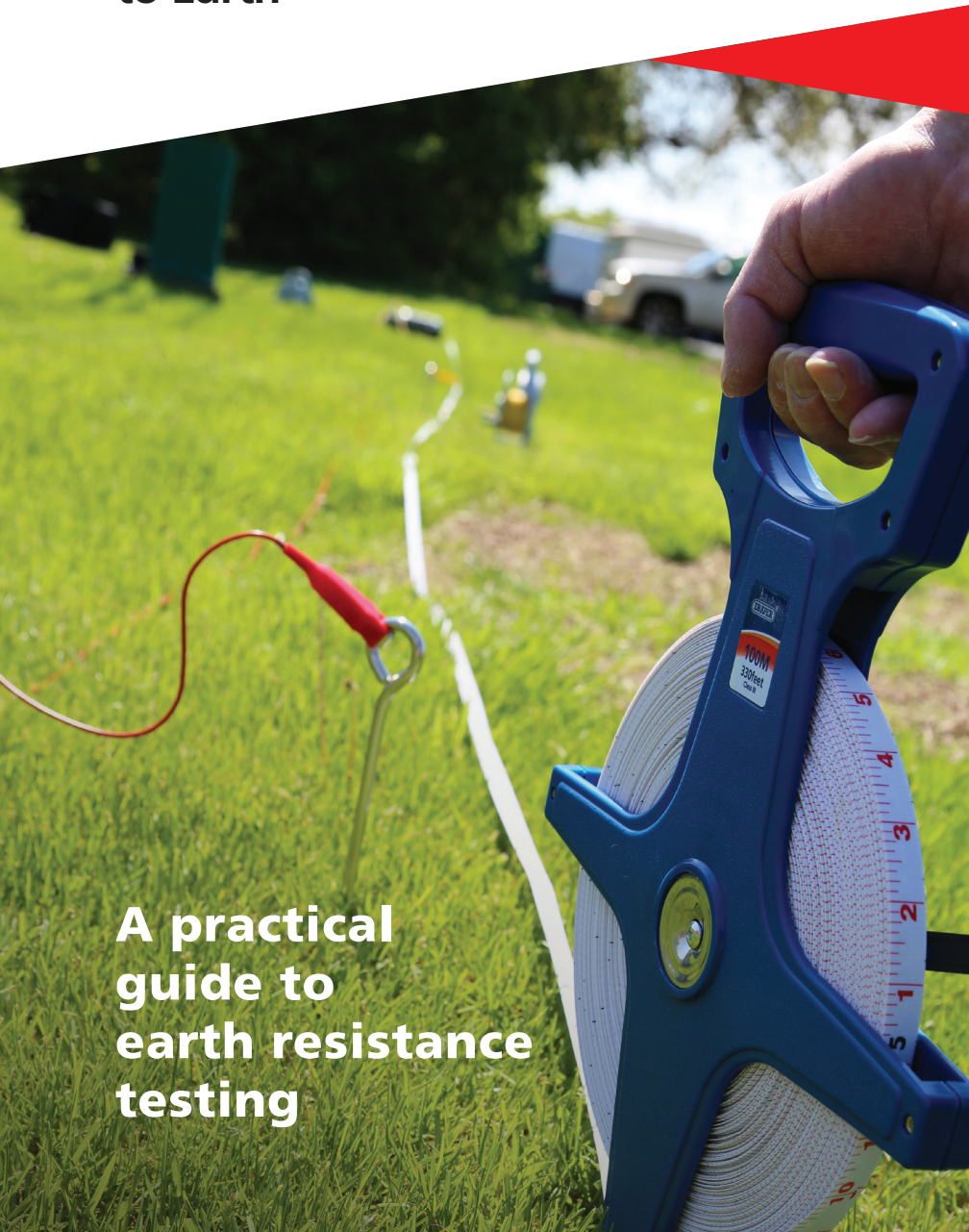

Getting Down to Earth

Introduction

Nothing is quite so common or abundantly available throughout the world as the earth's soil. While you likely think of soil as something to be tilled for planting or to be excavated for a building foundation, it also has an electrical property—conductivity (or low resistance)—that is put to practical use every day in industrial plants and utilities.

Broadly speaking, “earth resistance” is the resistance of soil to the passage of electric current. In reality, the earth is a relatively poor conductor of electricity compared to normal conductors like copper wire. However, if the area of a path for current is large enough, resistance can be quite low and the earth can be a good conductor. It is the earth's abundance and availability that make it an indispensable component of a properly functioning electrical system.

Earth resistance is measured in two ways for two important fields of use:

1. Determining effectiveness of “ground” grids and connections that are used with electrical systems to protect personnel and equipment.
2. Prospecting for good (low resistance) “ground” locations, or obtaining measured resistance values that can give specific information about what lies some distance below the earth's surface (such as depth to bed rock).

It is not the intent of this manual to go too deeply into the theory and mathematics of the subject. If you're interested in learning more, there is a list of Additional Resources—found at the back of this booklet—which cover these in extensive detail. Rather, “Getting Down to Earth” is written in a simple and easy-to-understand format for all industry users.

Testing covered in this manual can be carried out on large, complex earth systems, including communications earth systems and other difficult test environments. Testing is carried out in accordance with BS 7430 (Earthing), BS-EN-62305 (Lightning Protection) and IEEE Standard 81.

From years of experience—supplying instruments for the tests involved—Megger can provide advice to help you perform specific tests. Upon request, we would also be happy to have a representative call you to discuss your specific application question(s).

Getting Down to Earth

TABLE OF CONTENTS

Introduction.....	1
Safety	5
SECTION I	
Earth Resistivity	6
How Earth Resistivity is Measured.....	6
Practical Example of Test Method.....	8
Type of Soil Affects Resistivity.....	9
Resistivity Decreases with Moisture and Dissolved Salts.....	10
Effect of Temperature on Earth Resistivity.....	12
Seasonal Variations in Earth Resistivity.....	12
Determining a Good Electrode Location	14
SECTION II	
Measuring Earth Resistance for Electrical Grounding Systems	16
Factors That Can Change Your Minimum Earth Resistance.....	17
Some Basic Definitions.....	17
Factors Influencing Requirements for a Good Grounding System.....	19
National Electrical Code Maximum Values.....	21
Nature of an Earth Electrode.....	21
Principles Involved in Earth Resistance Testing	23
Basic Test Methods for Earth Resistance.....	26
Effects of Different Reference Probe Locations	30
Bonding and Continuity.....	35
Test Leads.....	36
Lazy Spikes.....	37
Supplementary Tests	38
How to Improve Earth Resistance	39
Additional Test Methods:	
Clamp-On Method	44
Advantages of Stakeless Testing.....	47
Limitations of Stakeless Testing	48
Cell Tower Ground Testing.....	49
Attached Rod Technique (ART).....	50

Getting Down to Earth

Star Delta Method.....	54
Determining Touch and Step Potential	57
SECTION III	
Accurately Measuring Earth Resistance for Large Ground Systems.....	59
Testing Challenges in Large Ground Systems.....	59
Addressing the Testing Challenges in Large Ground Systems.....	60
Measurement of the Resistance of Large Earth-Electrode Systems:	
Intersecting Curves Method	62
Test at a Large Substation	63
General Comments.....	64
Slope Method.....	66
Four Potential Method	69
APPENDIX I	
Nomograph Guide to Getting Acceptable Earth Resistance	72
APPENDIX II	
Ground Testing Methods Chart.....	74
GROUND TESTERS AVAILABLE FROM MEGGER	76
GROUND TESTING ACCESSORIES AVAILABLE FROM MEGGER.....	78
REFERENCES.....	79
ADDITIONAL RESOURCES	80



Getting Down to Earth

Safety

There is an inherent safety problem in earth resistance testing that requires care and planning by the user of the test set.

The possibility exists that a fault in the power system will cause a high current to flow into the ground system while the test is in progress. This may cause unexpected high voltages to appear at the current and voltage probes and also at the terminals of the test set.

This risk must be evaluated by the person responsible for the tests, taking into account the fault current available and expected step-and-touch potentials. IEEE Standard 80 entitled "IEEE Guide for Safety in AC Substation Grounding" fully covers this subject. (Other standards may prevail elsewhere in the world.)

We recommend that the operator wear rubber protective gloves (ANSI/ASTM D120 or equal) while handling connections and use a rubber safety mat (ANSI/ASTM D178 or equal) while operating the test set.

Getting Down to Earth

SECTION I Earth Resistivity

The term “earth resistivity” expressed in ohm-centimeters (abbreviated ohm-cm) is one basic variable affecting resistance to earth of an electrode system. Fortunately, the actual value of earth resistivity does not need to be measured in order to check the electrode earth resistance. Let’s first consider other fields where the value of resistivity is measured, as well as some of the factors affecting it that are of interest in earth testing.

Earth resistivity measurements can be used conveniently for geophysical prospecting — to locate ore bodies, clays, and water-bearing gravel beneath the earth’s surface. The measurement can also be used to determine depth to bed rock and thickness of glacial drift.

Measurements of earth resistivity are also useful for finding the best location and depth for low resistance electrodes, as well. Such studies are made, for example, when a new electrical unit is being constructed, such as: a generating station, substation, transmission tower, or telephone central office.

Finally, earth resistivity may be used to indicate the degree of corrosion to be expected in underground pipelines for water, oil, gas, gasoline, etc. In general, spots where the resistivity values are low tend to increase corrosion. This same kind of information is a good guide for installing cathodic protection.

How Earth Resistivity is Measured

To measure earth resistivity, a four-terminal instrument is used, along with four small-sized electrodes - driven down to the same depth and equal distances apart in a straight line (Fig. 1). Four separate lead wires connect the electrodes to the four terminals on the instrument, as shown. Hence, the name of this test: the four-terminal method.

Getting Down to Earth

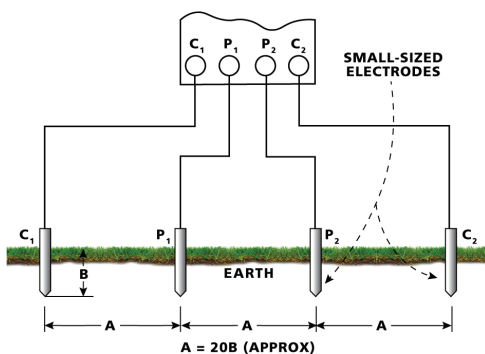

Fig. 1: Four-terminal method of measuring earth resistivity

Dr. Frank Wenner of the U.S. Bureau of Standards (now NIST) developed the theory behind this test in 1915 [1]. He showed that, if the electrode depth (B) is kept small compared to the distance between the electrodes (A)¹, the following formula applies:

$$\rho = 2\pi AR$$

where ρ is the average soil resistivity to depth A in ohm-cm, π is the constant 3.1416, A is the distance between the electrodes in cm, and R is the Megger earth tester reading in ohms.

In other words, if the distance A between the electrodes is 4 ft, you obtain the average earth resistivity to a depth of 4 ft as follows:

1. Convert the 4 ft to centimeters to obtain A in the formula:

$$4 \times 12 \times 2.54 \text{ cm} = 122 \text{ cm}$$

2. Multiply $2\pi A$ to obtain a constant for a given test setup:

$$2 \times 3.14 \times 122 = 766$$

Now, for example, if your instrument reading is 60 Ω , the earth resistivity would be 60 x 766, or 45,960 ohm-cm.

There are other methods for measuring soil resistivity such as the Schlumberger method. However, the Wenner method is the most popular in the electric power industry.

¹B = 1/20A is generally recommended

Getting Down to Earth

Practical Example of Test Method

A petroleum company had a 10-in. pipeline 6300 ft long running through rugged terrain [2]. After a corrosion leak, they wanted to check out earth resistivity along the line. Low-resistance spots would most likely require attention. They used a Megger earth tester to make a survey along the line.

First, the average depth of the pipeline was found from a profile map. It was 4 ft, so four electrodes were tied together 4 ft apart with strong cotton cord. They decided to check soil resistivity every 20 ft along the line. Fig. 2 shows a portion of the results; pit depth corrosion and Megger earth tester readings are plotted for points along the pipeline. Note that for low resistance readings, more corrosion was found.

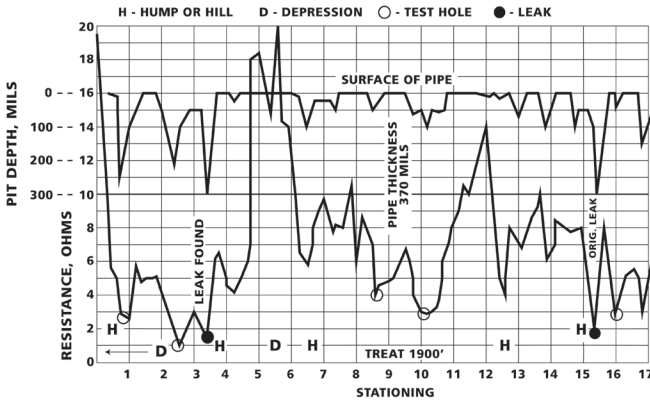

Fig. 2: Earth resistivity survey of pipeline shows where corrosion is most likely to occur [2].

Getting Down to Earth

Type of Soil Affects Resistivity

Whether a soil is largely clay or very sandy, for example, can change the earth resistivity a great deal. It isn't always easy to define exactly what's in a given soil; "clay" can cover a wide variety of soils. Therefore, we cannot say that any given soil has a resistivity of so many ohm-cm. Tables I and II are taken from two different reference books and show the wide range in values. Note also the spread of values for the same general types of soil. See Fig. 3 also.

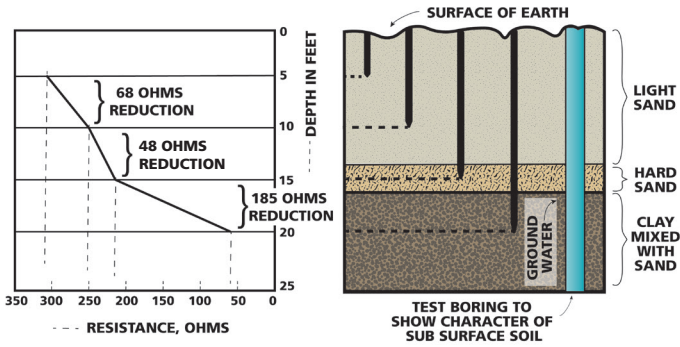

Fig. 3: Deeper earth electrodes lower the resistance. These graphs show the relation between character of soil and resistance of driven electrode at increased depths.

Table I: Resistivities of Different Soils²

Soil	Resistivity (Ohm-cm)		
	Avg	Min	Max
Fills: ashes, cinders, brine wastes	2,370	590	7,000
Clay: shale, gumbo, loam	4,060	340	16,300
Same: varying proportions of sand/gravel	15,800	1,020	135,000
Gravel, sand, stones with little clay/loam	94,000	59,000	458,000

² US Bureau of Standards Report 108

Getting Down to Earth

Resistivity Decreases with Moisture and Dissolved Salts

In soil, conduction of current is largely electrolytic. Therefore, the amount of moisture and salt content of soil radically affects its resistivity. The amount of water in the soil varies, of course, with the weather, time of year, nature of sub-soil, and depth of the permanent water table. Table IV shows typical effects of water in soil; note that when dry, the two types of soil are good insulators (resistivities greater than 1000×10^6 ohm-cm). With a moisture content of 15 percent, however, note the dramatic decrease in resistivity (by a factor of 100,000). Actually, pure water has an infinitely high resistivity. Naturally occurring salts in the earth, dissolved in water, lower the resistivity. Only a small amount of salt³ can reduce earth resistivity quite a bit. (See Table IV.) As noted in Section I, this effect can be useful to provide a good low-resistance electrode, in place of an expensive, elaborate electrode system.

Table II: Resistivities of Different Soils⁴

Soil	Resistivity Ohm-cm (Range)
Surface soils, loam, etc.	100 - 5,000
Clay	200 - 10,000
Sand and gravel	5,000 - 100,000
Surface limestone	10,000 - 1,000,000
Shales	500 - 10,000
Sandstone	2,000 - 200,000
Granites, basalts, etc.	100,000
Decomposed gneisses	5,000 - 50,000
Slates, etc.	1,000 - 10,000

³ By "salt" we don't mean the kind used to season food (sodium chloride), though this kind can occur in soil. Other kinds include copper sulphate, sodium carbonate, and others (see "Treatment of Soil," Section II, page 40).

⁴ Evershed & Vignoles Bulletin 245

Getting Down to Earth

Table III: Effect of Moisture Content on Earth Resistivity⁵

Moisture Content, Percent by Weight	Resistivity (Ohm-cm)	
	Top Soil	Sandy Loam
0.0	1,000 x 10 ⁶	1,000 x 10 ⁶
2.5	250,000	150,000
5.0	165,000	43,000
10.0	53,000	22,000
15.0	21,000	13,000
20.0	12,000	10,000
30.0	10,000	8,000

Table IV: Effects of Salt Content on Earth Resistivity⁶

Added Salt Percent by Weight of Moisture	Resistivity (Ohm-cm)
0.0	10,700
0.1	1,800
1.0	460
5.0	190
10.0	130
20.0	100

⁵ From "An Investigation of Earthing Resistance" by P.J. Higgs, I.E.E. Journal, vol. 68, p. 736, February 1930

⁶ For sandy loam; moisture content, 15% by weight; temperature 63° F (17° C)

Getting Down to Earth

Effect of Temperature on Earth Resistivity

Not much information has been collected on the effects of temperature. Two facts lead to the logical conclusion that an increase in temperature will decrease resistivity: (1) water present in soil mostly determines the resistivity, and (2) an increase in temperature markedly decreases the resistivity of water. The results shown in Table V confirm this. Note that when water in the soil freezes, the resistivity jumps appreciably; ice has a high resistivity. The resistivity continues to increase as temperatures go below freezing.

Table V: Effect of Temperature on Earth Resistivity⁷

Temperature		Resistivity (Ohm-cm)
C	F	
20	68	7,200
10	50	9,900
0	32 (water)	13,800
0	32 (ice)	30,000
-5	23	79,000
-15	14	330,000

Seasonal Variations in Earth Resistivity

We have seen the effects of temperature, moisture, and salt content upon earth resistivity. It makes sense, therefore, that the resistivity of soil will vary considerably at different times of year. This is particularly true in locations where there are more extremes of temperature, rainfall, dry spells, and other seasonal variations.

From the preceding discussion, you can see that earth resistivity is a very variable quantity. If you want to know what the value is at a given location, at a given time of year, the only safe way is to measure it. When you use this value for survey work, the change in the value, caused by changes in the nature of the sub-soil, is the important thing; from the variations in resistivity you can obtain useful survey results.

⁷ For sandy loam, 15.2% moisture

Getting Down to Earth

As will be covered in Section II, the other main reason for measuring earth resistivity is to design earth-electrode systems for electrical power systems, lightning arresters, and so on. The measured resistivity values are used in standard engineering formulas that calculate factors like number and depth of rods necessary to achieve a required ground resistance, thus reducing the amount of trial and error in the installation of an effective ground. Earth resistance varies directly with earth resistivity and it is helpful to know what factors affect resistivity.

The curves of Fig. 4 illustrate several worthwhile points. They show the expected change in earth resistance (due to resistivity changes) over a 1-1/2 year period; they also show that the deeper electrode gives a more stable and lower value. We conclude that the moisture content and temperature of the soil become more stable at greater distances below the earth's surface. Therefore, the earth electrode should reach a deep enough level to provide:

- Permanent moisture content (relatively speaking).
- Constant temperature (below frost line; again, relatively speaking).

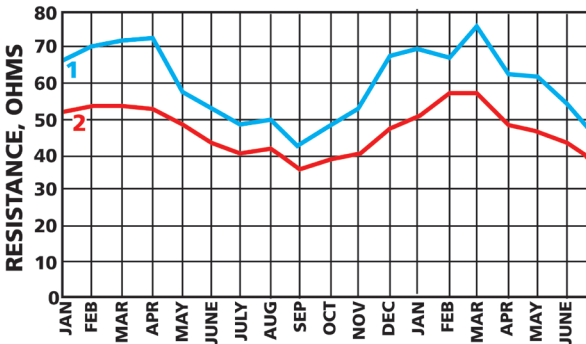

Fig. 4: Seasonal variation of earth resistance with an electrode of 3/4" pipe in stony clay soil. Depth of electrode in earth is 3 ft for Curve 1 and 10 ft for Curve 2 [3].

Getting Down to Earth

Determining a Good Electrode Location

A good, low-resistance earth electrode depends upon a low-resistivity soil in a spot where you can drive in your electrodes. There are two approaches to picking your location:

1. Drive rods in various locations to such depths as may be required and test their resistances while they are being driven.
2. Measure the earth resistivity **before** driving ground rods. Then calculate the number and length of rods required.

To get a low-resistance electrode in an unfavorable location, lay out straight lines 10 ft apart, covering the area. Drive four stakes 10 ft apart, but not more than 6 in. deep, along a line a-b-d-c, as shown in Fig. 5. Measure the resistance R between stakes b and c, using the method described for earth resistivity. Then, shift the stakes along the line in question to points b-c-d-e, c-d-e-f, etc. (see Fig. 5) and test until the entire line has been covered. Next, move to the next line and repeat

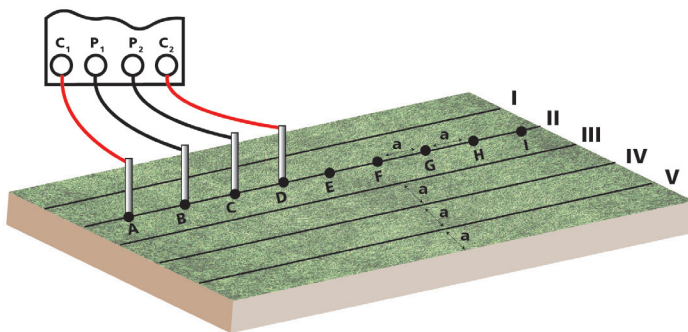

Fig. 5: Method of prospecting for best earth electrode location to a depth a . Location giving lowest reading on the Megger ground tester is the most desirable.

Getting Down to Earth

the process until the whole chosen area has been covered. The location giving the lowest value for R has the lowest specific resistance for the soil to the chosen depth of 10 ft. The spot is likely to give you the best earth electrode.

If you want results affected by the average earth resistivity to a depth of 20 ft, repeat the survey on lines 20 ft apart and with stakes spaced 20 ft apart. Such surveys do not require much time and can pay off in ensuring a good grounding system.

Alternate Method: Another way is to drive rods or pipes in various locations to such depths as may prove practicable, testing their resistance while they are being driven. In this manner, you can usually tell at once when moisture or other good conducting earth is reached. However, the work involved is apt to be much more than with the first method.

Getting Down to Earth

SECTION II Measuring Earth Resistance for Electrical Grounding Systems

The simplest and somewhat misleading idea of a good ground for an electrical system is a section of iron pipe driven into the earth with a wire conductor connected from the pipe to the electrical circuit (Fig. 6). This may, or may not, be a suitable low resistance path for electric current to protect personnel and equipment.

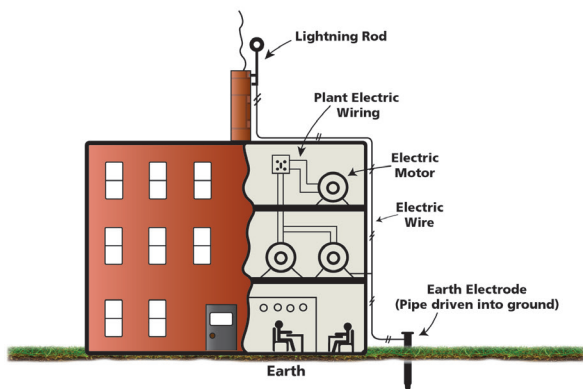

Fig. 6: A simplified grounding system in an industrial plant

A practical earth electrode that provides a low ground resistance is not always easy to obtain. But from experience gained by others you can learn how to set up a reliable system and how to check the resistance value with reasonable accuracy. As you will see, earth resistivity (refer to Section I) has an important bearing on electrode resistance, as does the depth, size and shape of the electrode.

The principles and methods of earth resistance testing covered in this section apply to lightning arrester installations as well as to other systems that require low resistance ground connections. Such tests are made in power-generating stations, electrical-distribution systems, industrial plants, and telecommunication systems.

Factors That Can Change Your Minimum Earth Resistance

We will discuss later what value of earth resistance is considered low enough. You'll see that there is no general rule usable for all cases. First, however, consider three factors that can change the earth electrode requirements from year to year:

- A plant or other electrical facility can expand in size. Also, new plants continue to be built larger and larger. Such changes create different needs in the earth electrode. What was formerly a suitably low earth resistance can become an obsolete "standard."
- As facilities add more modern sensitive computer-controlled equipment, the problem of electrical noise is magnified. Noise that would not affect cruder, older equipment can cause daily problems with new equipment.
- As more nonmetallic pipes and conduits are installed underground, such installations become less and less dependable as effective, low-resistance ground connections.
- In many locations, the water table is gradually falling. In a year or so, earth electrode systems that formerly were effective may end up in dry earth of high resistance.

These factors emphasize the importance of a continuous, periodic program of earth-resistance testing. It is not enough to check the earth resistance only at the time of installation.

Some Basic Definitions

First, let's define our terms. As early as 1918, the terms *ground*, *permanent ground*, and *ground connections* were defined to mean "electrical connections intentionally made between electrical bodies (or conducting bodies in close proximity to electrical circuits) and metallic bodies in the earth — such as rods, water pipes, plates, or driven pipes [4]."

The metallic body in the earth is often referred to as an electrode

Getting Down to Earth

even though it may be a water-pipe system, buried strips or plates, or wires. Such combinations of metallic bodies are called a grid. The earth resistance we're concerned with is the resistance to current from the electrode into the surrounding earth.

To appreciate why earth resistance must be low, you need only use Ohm's Law: $E = R \times I$ where E is volts; R , the resistance in ohms; and I , the current in amperes. Assume that you have a 4000-V supply (2300 V to ground) with a resistance of 13Ω (see Fig. 7). Now, assume that an exposed wire in this system touches a motor frame that is connected to a grounding system which has a 10-ohm resistance to earth.

By Ohm's Law, there will be a current of 100 A^8 through the fault (from the motor frame to the earth). If you happen to touch the motor frame and are grounded solidly to earth, (by standing in a puddle) you could be subjected to 1000 V ($10 \Omega \times 100 \text{ A}$).

As you'll note from point 2 in the following, this may be more than enough to kill you instantly. If, however, the earth resistance is less than 1Ω , the shock you'd get would be under 100 V (1×100) and you'd probably live to correct the fault.

Equipment can also be damaged similarly by overvoltages caused by high-resistance ground systems.

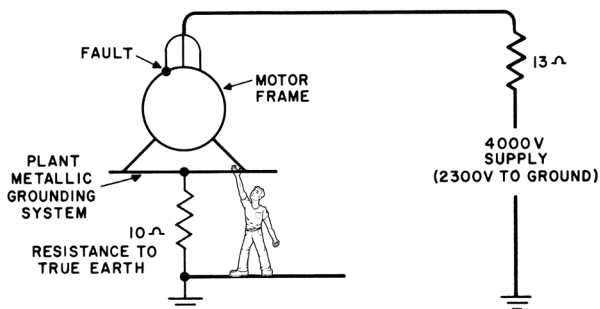

Fig. 7: Example of an electrical circuit with too high an earth resistance

⁸ $I = E/R = 2,300 / (10 + 13) = 100$ amperes

Factors Influencing Requirements for a Good Grounding System

In an industrial plant or other facility that requires a grounding system, one or more of the following must be carefully considered (see Fig. 8):

1. *Limiting to definite values the voltage to earth of the entire electrical system.* Use of a suitable grounding system can do this by maintaining some point in the circuit at earth potential. Such a grounding system provides these advantages:
 - Limits voltage to which the system-to-ground insulation is subjected, thereby more definitely fixing the insulation rating.
 - Limits the system-to-ground or system-to-frame voltage to values safe for personnel.
 - Provides a relatively stable system with a minimum of transient overvoltages.
 - Permits any system fault to ground to be quickly isolated.
2. *Proper grounding of metallic enclosures and support structures that are part of the electrical system and may be contacted by personnel.*

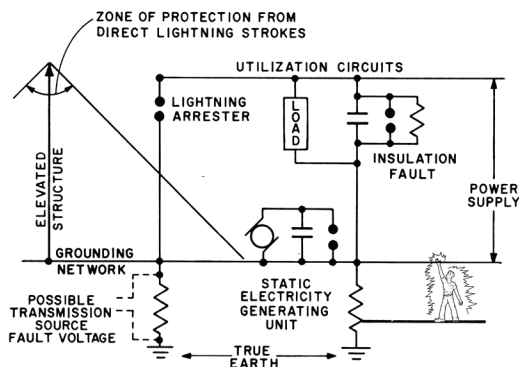

Fig. 8: Typical conditions to be considered in a plant ground system

Getting Down to Earth

Also to be included are portable electrically operated devices. Consider that only a small amount of electric current — as little as 0.1 A for one second — can be fatal! An even smaller amount can cause you to lose muscular control. These low currents can occur in your body at voltages as low as 100 V, if your skin is moist.

3. *Protection against static electricity from friction.* Along with this are the attendant hazards of shock, fire and explosion. Moving objects that may be inherent insulators - such as paper, textiles, conveyor belts or power belts and rubberized fabrics - can develop surprisingly high charges unless properly grounded.
4. *Protection against direct lightning strokes.* Elevated structures, such as stacks, the building proper, and water tanks may require lightning rods connected into the grounding system.
5. *Protection against induced lightning voltages.* This is particularly a factor if aerial power distribution and communications circuits are involved. Lightning arresters may be required in strategic locations throughout the plant.
6. *Providing good grounds for electric process control and communication circuits.* With the increased use of industrial control instruments, computers, and communications equipment, accessibility of low-resistance ground connections in many plant locations — in office and production areas — must be considered.

National Electrical Code Maximum Values

The National Electrical Code, Section 250-56 states that a single electrode with a resistance to ground greater than 25Ω shall be augmented by one additional electrode. (Other standards may prevail elsewhere in the world.)

We recommend that single-electrode grounds be tested when installed and periodically afterward.

Resistance to earth can vary with changes in climate and temperature. Such changes can be considerable. An earth electrode that was good (low-resistance) when installed may not stay that way; to be sure, you must check it periodically.

We cannot tell you what your maximum earth resistance should be. For specific systems in definite locations, specifications are often set. Some call for 5Ω maximum; others accept no more than 3Ω . In certain cases, resistances as low as a small fraction of an ohm are required.

Nature of an Earth Electrode

Resistance to current through an earth electrode actually has three components (Fig. 9):

1. Resistance of the electrode itself and connections to it.
2. Contact resistance between the electrode and the soil adjacent to it.
3. Resistance of the surrounding earth.

Electrode Resistance: Rods, pipes, masses of metal, structures, and other devices are commonly used for earth connections. These are usually of sufficient size or cross-section that their resistance is a negligible part of the total resistance.

Getting Down to Earth

Electrode-Earth Contact Resistance: This is much less than you might think. If the electrode is free from paint or grease, and the earth is packed firmly, contact resistance is negligible. Rust on an iron electrode has little or no effect; the iron oxide is readily soaked with water and has less resistance than most soils. But if an iron pipe has rusted through, the part below the break is not effective as a part of the earth electrode.

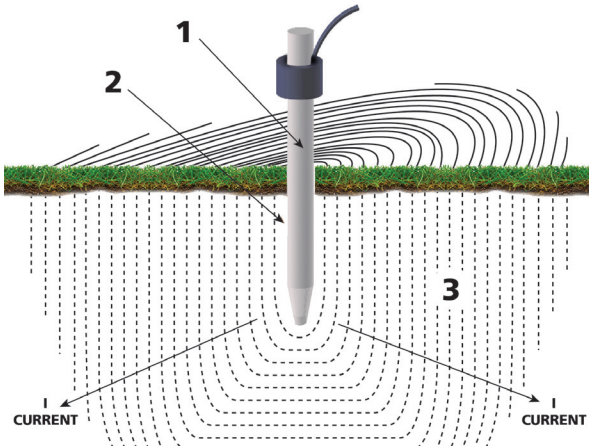

Fig. 9: Components of earth resistances in an earth electrode

Resistance of Surrounding Earth: An electrode driven into earth of uniform resistivity radiates current in all directions. Think of the electrode as being surrounded by shells of earth, all of equal thickness (see Fig. 9).

The earth shell nearest the electrode naturally has the smallest surface area and so offers the greatest resistance. The next earth shell is somewhat larger in area and offers less resistance. Finally, a distance from the electrode will be reached where inclusion of additional earth shells does not add significantly to the resistance of the earth surrounding the electrode. It is this critical volume of soil that determines the effectiveness of the ground electrode and which therefore must be effectively

Getting Down to Earth

measured in order to make this determination. Ground testing is distinct when compared to more familiar forms of electrical measurement, in that it is a volumetric measurement and cannot be treated as a “point” property.

Generally, the resistance of the surrounding earth will be the largest of the three components making up the resistance of a ground connection. The several factors that can affect this value are discussed in Section II on Earth Resistivity. From Section II, you’ll see that earth resistivity depends on the soil material, the moisture content, and the temperature. It is far from a constant, predictable value ranging generally from 500 to 50,000 ohm-cm⁹.

Principles Involved in Earth Resistance Testing

The resistance to earth of any system of electrodes theoretically can be calculated from formulas based upon the general resistance formula:

$$R = \rho \frac{L}{A}$$

where ρ is the resistivity of the earth in ohm-cm, L is the length of the conducting path, and A is the cross-sectional area of the path. Prof. H. B. Dwight of Massachusetts Institute of Technology developed rather complex formulas for the calculation of the resistance to earth for any distance from various systems of electrodes [4]. All such formulas can be simplified a little by basing them on the assumption that the earth’s resistivity is uniform throughout the entire soil volume under consideration.

Because the formulas are complicated, and earth resistivity is neither uniform or constant, a simple and direct method of measuring earth resistance is needed. This is where we come in with our Megger Ground Resistance Tester, a self-contained portable instrument that is reliable and easy to use. With it, you can check the resistance of your earth electrode while it is being installed; and, by periodic tests, observe any changes with time.

⁹ An ohm-centimeter (abbreviated ohm-cm) is defined as the resistance of a cube of material (in this case, earth) with the cube sides being measured in centimeters.

Getting Down to Earth

To understand the principle of earth testing, consider the schematic diagram in Fig. 10a. Bear in mind our previous observation with reference to the earth shell diagram in Fig. 9: with increased distance from an electrode, the earth shells are of greater surface area and therefore of lower resistance. Now, assume that you have three rods driven into the earth some distance apart and a voltage applied, as shown in Fig. 10a. The current between rods 1 and 2 is measured by an ammeter; the potential difference (voltage) between rods 1 and 3 is measured by a voltmeter.

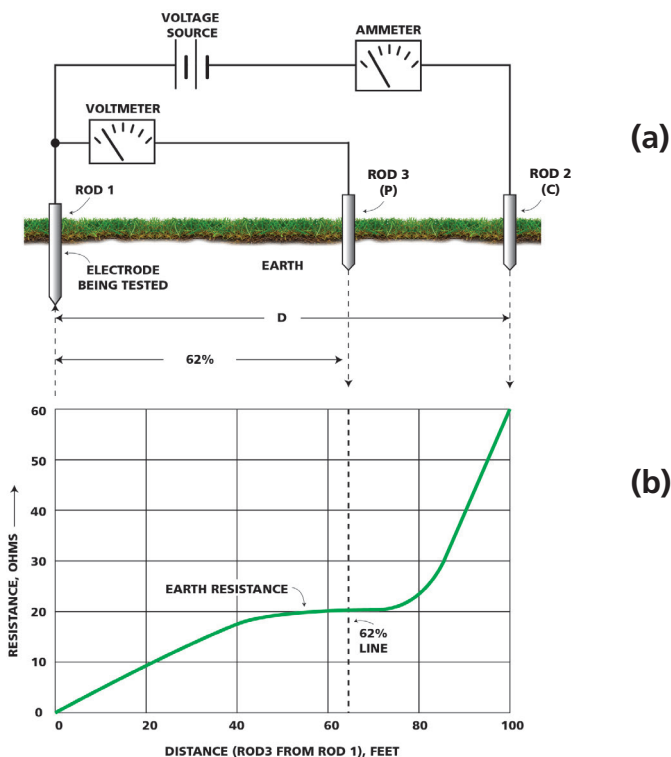

Fig. 10: Principle of an earth resistance test

Getting Down to Earth

If rod 3 is located at various points between rods 1 and 2, preferably in a straight line¹⁰, you can get a series of voltage readings. By Ohm's Law ($R = E/I$) you can determine the earth resistance at any point measured. For example, if the measured voltage E between rods 1 and 3 is 30 V and the measured current I is 2 A, the resistance of the earth R at that point would be 15 Ω .

The series of resistance values can be plotted against distance to obtain a curve (Fig. 10b). Note that as rod 3 is moved away from rod 1, the resistance values increase, but the amount of increase gets less and less until a point is reached *where the rate of increase becomes so small that I can almost be considered constant* (20 Ω in Fig. 10b). The earth shells between the two rods (1 and 3) have so great a surface area that they add little to the total resistance. Beyond this point, as rod 3 approaches the earth shells of rod 2, resistance gradually picks up. Near rod 2, the values rise sharply.

Now, let's say that rod 1 is our earth electrode under test. From a typical earth-resistance curve, such as Fig. 10b, what is the resistance to earth of this rod? We call rod 2 *current-reference probe C* and rod 3, *potential-reference probe P* (simply for convenience in identification). *The correct resistance is usually obtained if P (rod 3) is placed at a distance from the center of the earth electrode (rod 1) about 62 percent of the distance between the earth electrode and C (rod 2).*

For example, in Fig. 10b, the distance D from the earth electrode to C is 100 ft. Taking 62 percent of this distance, we get 62 ft. From Fig. 10b, the resistance for this distance is 20 Ω . This is the measured resistance of the earth electrode.

This rule works well for simple electrodes, such as a driven rod. It also works for a small group of rods. But you must know the true electrical center of the electrode system fairly accurately. Also, accuracy of readings is better if the earth resistivity between the three electrodes is reasonably

¹⁰ Actually, current can exist in other paths between the two fixed electrodes, so that rod 3 could be (and might have to be) located at other than along a straight line.

Getting Down to Earth

constant. Finally, C should be far enough away from the earth electrode system so that the 62 percent distance is out of the “sphere of influence” of the earth electrode. (See discussion with reference to Figs. 14 and 15). For the test, the electrode should be isolated from the electrical system that it is protecting; otherwise, the whole system is tested which (depending on local practices) may include the pole ground, system neutral, and transformer ground. This obscures the specific effect of the local ground.

Basically, you now have the principle of earth resistance testing. The rest is refinement -- in test methods, use of electrodes or electrode systems, and information about earth resistivity, as covered in later portions of this manual.

Basic Test Methods for Earth Resistance

The earth tester generates an a.c. signal which is fed into the system under test. The instrument then checks the status of the circuits for good connection and noise. If either of these variables is out of specification then the operator is informed. Having checked that the conditions for test are met, the instrument automatically steps through its measurement ranges to find the optimum signal to apply. Measuring the current flowing and the voltage generated the instrument calculates and displays the system resistance in the range of 0.001 to 20,000 ohms, depending on the model chosen.

There are three basic test methods as noted below. The first two are shown schematically in Figs. 11 and 12.

1. Fall-of-potential method, or three-terminal test.
2. Dead Earth method (two-point test).
3. Clamp-on test method (see Appendix II, page 48).

In addition, Megger has developed a version of Fall-of-Potential testing where the operator does not have to disconnect the ground rod under

Getting Down to Earth

test from the electrical system. The ART (Attached Rod Technique) Method will be covered later in this section, on page 48.

Fall-of-Potential Method: This three-terminal test is the method described previously with reference to Fig. 10. With a four-terminal tester, P_1 and C_1 terminals on the instrument are jumpered and connected to the earth electrode under test. With a three-terminal instrument, connect X to the earth electrode.

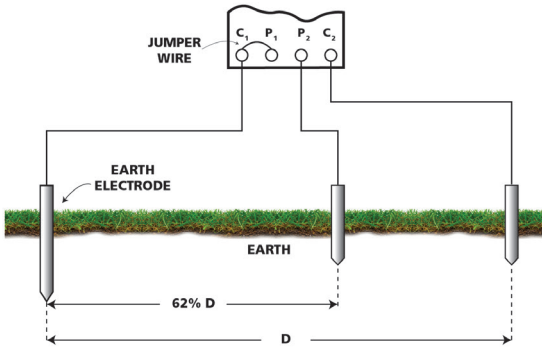

Fig. 11: Fall-of-potential or three-terminal earth resistance test

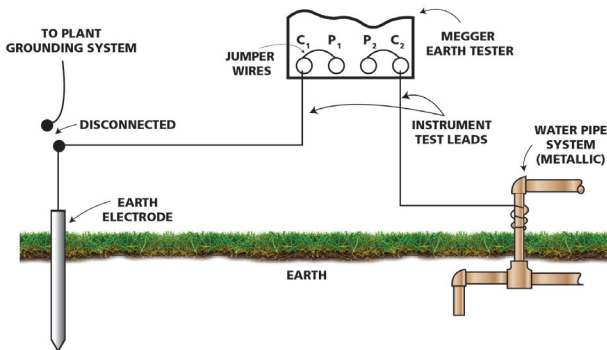

Fig. 12: Dead earth method or two-point earth resistance test

Getting Down to Earth

Although four terminals are necessary for resistivity measurements, the use of either three or four terminals is largely optional for testing the resistance of an installed electrode. The use of three terminals is more convenient because it requires one lead to be connected. The trade-off is that the resistance of this common lead is included in the measurement. Normally, this effect can be minimized by keeping the lead short, to accommodate simple test requirements. The small additional resistance thus introduced is negligible. When performing more complex tests or meeting stringent requirements, however, it may be better to use all four terminals by a lead from the P_1 terminal to the test electrode (connecting it inside the lead from C_1). This is a true four-wire test configuration which eliminates all lead resistance from the measurement.

The added accuracy may prove significant when meeting very low resistance specifications or using test methods that necessitate an extra digit of measurement in order to meet the mathematical requirements. The decision is optional, based on the operator's testing goals and the method used. The driven reference rod C should be placed as far from the earth electrode as practical; this distance may be limited by the length of extension wire available, or the geography of the surroundings (see Fig. 11). Leads should be separated and "snaked," not run close and parallel to each other, to eliminate mutual inductance.

Potential-reference rod P is then driven in at a number of points roughly on a straight line between the earth



Typical use of a Megger digital ground resistance tester - the DET4TC - to perform fall-of-potential testing.

Getting Down to Earth

electrode and C. Resistance readings are logged for each of the points. A curve of resistance vs. distance, like Fig. 10b, is then drawn. Correct earth resistance is read from the curve for the distance that is about 62 percent of the total distance from the earth electrode to C. In other words, if the total distance is D , the 62 percent distance is $0.62D$; for example, if D is 120 ft, the distance value for earth resistance is 0.62×120 or 74 ft.

There are three basic types of Fall-of-Potential test methods and a number of related test methods that will be described in the appendices. The types of Fall-of-Potential are:

- Full Fall-of-Potential — a number of tests are made at different spaces of P and the resistance curve is plotted.
- Simplified Fall-of-Potential — three measurements are made at defined distances of P and mathematical calculations are used to determine the resistance (to be described in more detail later).
- 61.8% Rule — a single measurement is made with P at a distance 61.8% (62%) of the distance between the electrode under test and C .

The related test methods tend to be more complex and sophisticated requiring many measurements and/or a great deal of math. These methods have been developed to help overcome the problems faced when testing large ground systems or when there is limited space. A list of these methods follows:

- Intersecting curves method (Section III, page 62)
- Slope method (Section III, page 66)
- Four-potential method (Section III, page 69)
- Star delta method (Section II, page 54)

Dead Earth Method: When using a four-terminal instrument, P_1 and C_1 terminals connect to the earth electrode under test; P_2 and C_2 terminals connect to an all-metallic water-pipe system. With a three-terminal instrument, connect X to the earth electrode, P and C to the pipe system (Fig. 12). If the water system is extensive (covering a large area), its resistance should only be a fraction of an ohm. You can then take the

Getting Down to Earth

instrument reading as being the resistance of the electrode under test.

The dead earth method is the simplest way to make an earth resistance test. With this method, resistance of two electrodes in series is measured — the driven rod and the water system. But there are three important limitations:

1. The water-pipe system must be extensive enough to have a negligible resistance.
2. The water-pipe system must be metallic throughout, without any insulating couplings or flanges.
3. The earth electrode under test must be far enough away from the water-pipe system to be outside its sphere of influence.

In some locations, your earth electrode may be so close to the water-pipe system that you cannot separate the two by the required distance for measurement by the two-terminal method. Under these circumstances, if conditions 1 and 2 above are met, you can connect to the water-pipe system and obtain a suitable earth electrode. As a precaution against any possible future changes in the resistance of the water-pipe system, however, you should also install an earth electrode.

Due to the many uncertainties associated with this method of testing, it should be considered using as a “last resort.”

Effects of Different Reference Probe Locations

Now, you may ask: if the right location for probe P is always 62 percent of the distance between the earth electrode and C, why bother with all the tests at other locations for P? Why not just drive P in at the 62 percent distance and assume that the measured resistance is the correct earth resistance? The following should help answer these questions.

Minimum Distance for C: Consider Fig. 13 which shows earth shells around the earth electrode and reference probe C. In Fig. 13a, C is so close to the earth electrode that the earth shells seriously overlap. Then you don't get the leveling off of measured resistance as P is moved away from the earth electrode; the shells of C add to the shells of the earth

Getting Down to Earth

electrode so the resistance keeps increasing.

In Fig. 13b, C is placed farther away. Then the measured resistance levels off enough and at the 62 percent distance it is very close to the actual earth resistance. The reason for having C farther away is to get assurance that the 62 percent value is “in line” with other values on the curve. The value could only be wrong (assuming there are no measuring mistakes) if the soil conditions at the 62 percent point vary from conditions at other points, causing changes in earth resistivity. Graded soil around construction sites or buried objects such as pipes can cause such localized deviations. Therefore, you want to get some degree of flatness or leveling off of your curve to make such a variation easily noticeable. At the same time, remember that the resistance will rise again in the electrical field of

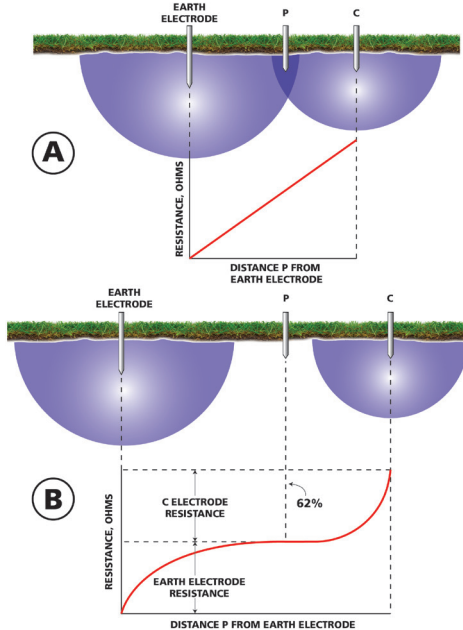

Fig. 13: Effect of C location on the earth resistance curve

Getting Down to Earth

the current probe, so measurements in this area are to be avoided.

As a practical example of this effect, consider the case illustrated in Fig. 14. This shows two earth resistance curves for two locations of C. Curve A was obtained when C was 100 ft from the earth electrode; Curve B when C was 700 ft away. Curve A shows that C was too close to the earth electrode; Curve B shows the desired tendency toward leveling out of the measured resistance. The 62 percent distance gives resistance values nearly the same in this case since the earth resistivity is fairly uniform.

Simplified Fall-of-Potential Test: The preferred test method is to always gather sufficient data to plot the actual curve of resistance vs. distance. In the event that this is impossible, a simplified test might be used with a compromise on accuracy. This procedure is similar to that outlined under Fall-of-Potential Method as described in IEEE Standard No. 81 (see references), but you start with P midway between the earth electrode and C.

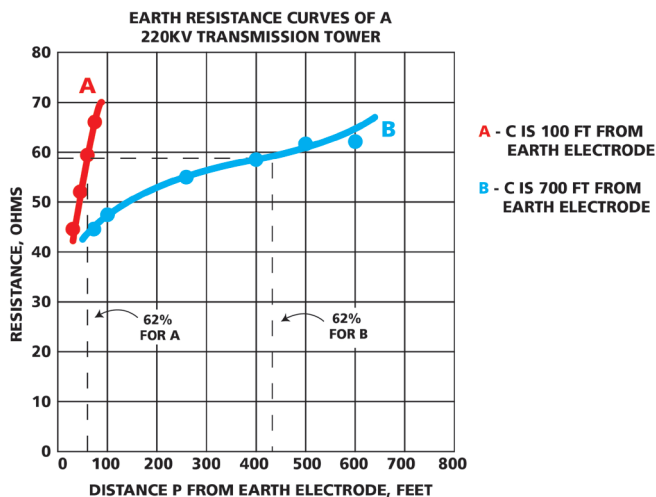

Fig. 14: Example of how C location affects the earth resistance curve

Getting Down to Earth

This reading with P at 50 percent of the distance from the earth electrode to C is noted as R_1 . Reference probe P is then moved to a location 40 percent of the distance to C. The reading at this point is noted as R_2 . A third reading, R_3 , is made with P at a 60 percent distance. The average of R_1 , R_2 and R_3 is calculated as R_A . You determine the maximum deviation from the average by finding the greatest difference between individual readings and the average. If 1.2 times this percentage is less than your desired test accuracy, R_A can be used as the test result. As an example of this technique, use the data from curve B in Fig. 14 as follows:

$$R_1 = 58 \Omega \quad R_2 = 55 \Omega \quad R_3 = 59 \Omega$$

$$R_A = \frac{55 + 58 + 59}{3} = 57.3 \Omega$$

$$\frac{R_A - R_2}{R_A} = \frac{57.3 - 55}{57.3} = 4.0\%$$

$$4.0\% \times 1.2 = 4.8\%$$

If your desired accuracy was 5 percent, 57 Ω (R_A) could be used as the result. If the result is not within the required accuracy, probe C has to be placed farther away and the tests repeated. This method can give sufficient accuracy but will always give values on the low side. (See discussion following with reference to Table II.)

Some Rules of Thumb on Spacing P and C: For testing a single earth electrode, C can usually be placed 50 ft from the electrode under test, with P placed about 31 ft away. With a small grid of two earth electrodes, C can usually be placed about 100 to 125 ft from the electrode under test; P correspondingly can be placed about 62 to 78 ft away. If the earth electrode system is large, consisting of several rods or plates in parallel, for example, the distance for C must be increased to possibly 200 ft, and for P to some 125 ft. You'll need even greater distance for complex electrode systems that consist of a large number of rods or plates and other metallic structures, all bonded together. For an earth electrode system covering a large area, refer to page 66 for additional techniques.

Getting Down to Earth

Table VI is a useful guide to reference probe location. You find the “Maximum Dimension” figure by taking the diagonal distance across your electrode system area. For example, if the area measures 100 by 100 ft, the diagonal equals about 140 ft. From the table, you run down the first column to 140 and read across. P should be 365 ft from the electrode and C should be 590 ft.

Table VI: Guide to approximate location of reference probes^{11,12}

Max Dimension, Ft.	Distance to P, Ft.	Distance to C, Ft.
2	40	70
4	60	100
6	80	125
8	90	140
10	100	160
12	105	170
14	120	190
16	125	200
18	130	210
20	140	220
40	200	320
60	240	390
80	280	450
100	310	500
120	340	550
140	365	590
160	400	640
180	420	680
200	440	710

¹¹Based upon data from “Earth Resistances,” G.F. Tagg, George Newnes Limited, London (1964).

¹²For example, the diagonal across an area surrounded by an earthed fence.

Bonding and Continuity

Sometimes overlooked in ground testing and maintenance is the measurement of bonding and continuity. While attention typically focuses on the grounding electrode ("ground rod", connection to earth), the National Electric Code® (NEC®) requires that there be a continuous low-impedance path from equipment to soil. The requirement is completed by bonding conductors that run from dead frame of grounded equipment to the grounding electrode or system, often by way of the jumpered ground bus. In order for the grounding electrode to function effectively, something must bring the fault currents to it, and that is the job of the bonding conductors.

One method for completing a conductor bonding check is by using a ground tester for this vital function. To do so, it is reduced to a two terminal configuration and the same leads used to test the electrode at great distances can easily be used across opposite ends of a grounding conductor as, for instance, from a motor head to the ground bus. In old testers, the terminals will have to be shunted together by shorting bars or such handy means as paper clips. The leads are then run from the two current terminals to opposite ends of the conductor under test. When the measurement is taken, the leads are then looped and measured separately, with this value subtracted from the initial measurement as a tare. Modern testers have a selector position for two-pole testing, so there is no longer a need to install jumpers in the terminals. The lead resistance must still be subtracted as a tare.

Continuity checks, as defined by IEC standards, are done at low voltage and current, from a few mA up to a fairly robust test at 200 mA, with accuracy down to 10 mA. They reveal wiring problems, such as poor or missed connections, construction and installation damage to circuits, and miswiring at junction boxes. For a more sensitive test of welds and similar bonding that may be subjected to thermal, electrical, physical and other stresses, a Low Resistance Ohmmeter that tests with something approximating operating current and measures to micro-ohms is necessary. Low Resistance Ohmmeters employ a 4-terminal measurement configuration that automatically subtracts the lead resistances. Effective testing of bonds is normally completed with a Low Resistance Ohmmeter.

Getting Down to Earth

One final test instrument that can be handy in maintenance testing is a loop tester. This combines some of the advantages of continuity and low resistance testing. Rather than stringing long leads, subtracting a tare, or de-energizing the facility, a loop tester plugs into a socket or is connected by short leads from hot to neutral or to ground. The circuit is energized and the loop tester takes only two half cycles, not enough to trip protective devices, to measure the entire loop resistance. This would include the grounding conductor, the grounding electrode, and the earth in parallel to the grounded utility neutral back to the transformer servicing the site, and then returning through the hot. If a suspiciously high reading is obtained, then the individual elements of the path must be inspected separately. If no high readings are obtained, the loop tester facilitates rapid testing and acceptance of the site.

Test Leads

Instruction manuals frequently recommend “snaking” leads and other advice for preventing interference during a ground test. Leads run rigidly parallel and close together can develop a crosstalk, or induced noise, that influences the reading. Snaking leads or keeping them spread well apart is recommended.

Running test leads parallel to overhead power lines is to be studiously avoided. Not only can these lines interfere; they can completely defeat a ground test by making the display so unstable as to be unreadable. But the natural tendency during a ground test is to be looking down, at the test instrument and layout. What’s overhead is easily overlooked. But be sure to cross power lines at right angles to defeat this interference.

While aerial interference is pronounced, there may also be subterranean interference. This tends to be less severe and less obvious. A lot of currents travel through the soil seeking the transformer from which they were generated. With older test instruments, the operator may have had little recourse beyond averaging the pointer swings. Modern testers, however, inject a test signal of a distinct square wave frequency that is recognized amongst the noise. Additional functions enhance the effectiveness, including frequency adjust (manual or automatic), signal-to-noise ratio enhancement,

and filtering.

Where long lead distances are involved, such as the testing of large grids, spooled leads may be involved. Indeed, in particularly challenging environments, like deserts, test leads can be stretched for miles! Not surprisingly, spooling leads can introduce inaccuracies from capacitance and inductance. Worse, this uncertainty can make the measurement less than the true value, so that the operator comes away with a false sense of having “met spec”. The degree of inaccuracy can be assessed by measuring with a known resistor in a 2-point configuration with leads fully extended and then with leads rolled up. This will show the influence of spooled long test leads on the tester. Only the highest quality testers can continue to provide accurate readings even with a mile of spooled test leads. Bottom line is, for absolutely certain measurements, unspool and snake the leads.

Lazy Spikes

The latest designs of digital earth testers can operate with very high temporary spike resistances and still give reliable and accurate results. Because the current and voltage are measured separately, it enables electrode measurements to be carried out with test spike resistances up to 400 k Ω .

The advantage of these instruments tolerating such high spike resistance is generally that tests can be performed quickly on a green field site because electrodes do not have to be inserted too far into the ground. However, in urban situations, tests can be carried out using street furniture such as sign posts, metal fences and bollards. Where this is not possible, results have been obtained by laying the temporary electrodes on a wet patch of concrete. Coiled metal chains or metallized ground mats, with water poured over them, make an even better electrode because they conform more intimately to the earth’s surface than does a rigid spike. This technique has led to measured values of “spike” of less than 10 k Ω , well inside the maximum value that will cause an error to the reading.

With modern instruments, any problem with the temporary spikes will be indicated on the display to show that a reading may not be valid. A more

Getting Down to Earth

suitable position for the spike may have to be used such as along the gap between paving stones, a crack in concrete, or in a nearby puddle. As long as warning indicators do not appear, sufficient contact has been made and a reliable test may be performed.

Supplementary Tests

There are related tests which can be performed to supplement the information gained from the ground test and to augment the protection provided by the ground electrode. One of these is a continuity test to assure that it is complete and adequate throughout the grounding conductors and down to the point of contact with the electrode. Either a three-terminal or four-terminal tester can be used in a two-terminal configuration by shunting together the appropriate pairs. The two leads can thus be connected across a bond, weld, joint, or length of conductor, and the resistance measured. An earth tester, however, provides only a convenient backup check, not a fully rigorous continuity test. The reason for this is that, for safety's sake, the test current is limited to values below a level harmful to the human body. A fully rigorous proof of a bond, however, must stress the connection at current levels capable of revealing corrosion, cracks, loose connections, and the like. For this reason, a dedicated low resistance ohmmeter capable of 10 A or more of test current is preferred.

To protect personnel about to perform a ground test, as well as to identify the presence of electrical problems in the system, the ground electrode can first be checked for the presence of fault current. It is not uncommon, in an unbalanced or faulted electrical system, for the electrode to be carrying a fault current, more or less constantly, to ground. This may be only a few milliamps or several amps, and occurring undetected. A sufficiently sensitive clamp-on milliammeter can reveal the problem, and protect the testing crew from possible shock, in just a few seconds.

The total impedance of the system can be measured at once by using a loop tester. This instrument simulates a fault between a phase conductor and ground, and thereby measures the total impedance of the entire ground loop, including conductors and the earth return path back to the transformer and its winding. If any of these elements have too high a resistance, protective devices may be inhibited from operating properly,

Getting Down to Earth

even though the ground electrode itself is maintained at a sufficiently low resistance.

How to Improve Earth Resistance

When you find that your earth electrode resistance is not low enough, there are several ways you can improve it:

- Lengthen the earth electrode in the earth.
- Use multiple rods.
- Treat the soil.

Effect of Rod Size: As you might suspect, driving a longer rod deeper into the earth materially decreases its resistance. In general, doubling the rod length reduces resistance by about 40 percent. The curve of Fig. 15 shows this effect. For example, note that a rod driven 2 ft down has a resistance of 88 Ω ; the same rod driven 4 ft down has a resistance of about 50 Ω . Using the 40 percent reduction rule, $88 \times 0.4 = 35$ Ω reduction. By this calculation, a 4-ft deep rod would have a resistance of $88 - 35$ or 53 Ω — comparing closely with the curve values.

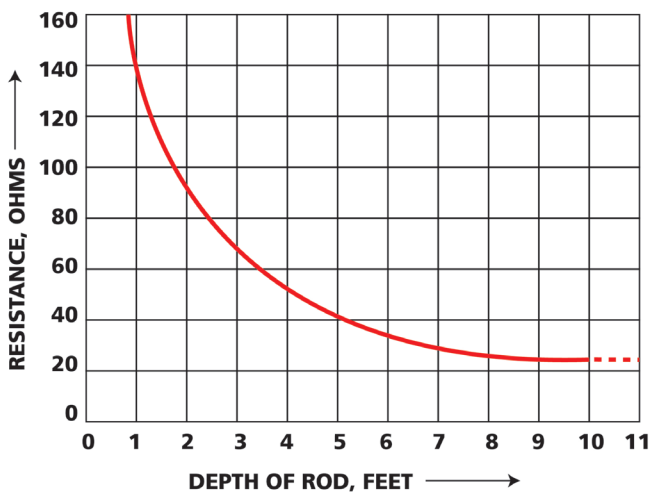

Fig. 15: Earth resistance decreases with depth of electrode in earth [5]

Getting Down to Earth

You might also think that increasing the electrode diameter would lower the resistance. It does, but only a little. For the same depth, doubling the rod's diameter reduces the resistance only about 10 percent. Fig. 16 shows this relationship. For example, a 10-ft deep rod, 5/8 in. in diameter, has a resistance of 6.33 Ω ; increasing its diameter to 1-1/4 in. lowers the resistance to 5.6 Ω . For this reason, you normally only consider increasing the rod diameter if you have to drive it into hard terrain.

Use of Multiple Rods: Two well-spaced rods driven into the earth provide parallel paths. They are, in effect, two resistances in parallel. The rule for two resistances in parallel does not apply exactly; that is, the resultant resistance is not one-half the individual rod resistances (assuming they are of the same size and depth). Actually, the reduction for two equal resistance rods is about 40 percent. If three rods are used, the reduction is 60 percent; if four, 66 percent (see Fig. 17).

When you use multiple rods, they must be spaced apart further than the length of their immersion. There are theoretical reasons for this, but you need only refer to curves such as Fig. 18. For example, if you have two rods in parallel and 10-ft spacing, resistance is lowered about 40 percent. If the spacing is increased to 20 percent, reduction is about 50 percent.

Treatment of the Soil: Chemical treatment of soil is a good way to improve earth electrode resistance when you cannot drive deeper ground rods because of hard underlying rock, for example. It is beyond the scope of this manual to recommend the best treatment chemicals for all situations. You have to consider the possible corrosive effect on the electrode as well as EPA and local environmental regulations. Magnesium sulfate, copper sulfate, and ordinary rock salt are suitable noncorrosive materials. Magnesium sulfate is the least corrosive, but rock salt is cheaper and does the job if applied in a trench dug around the electrode (see Fig. 19). It should be noted that soluble sulphates attack concrete, and should be kept away from building foundations. Another popular approach is to backfill around the electrode with a specialized conductive concrete. A number of these products, like bentonite, are available on the market.

Getting Down to Earth

Chemical treatment is not a permanent way to improve your earth electrode resistance. The chemicals are gradually washed away by rainfall and natural drainage through the soil. Depending upon the porosity of the soil and the amount of rainfall, the period for replacement varies. It may be several years before another treatment is required.

Chemical treatment also has the advantage of reducing the seasonal variation on resistance that results from periodical wetting and drying out of the soil. (See curves of Fig. 20.) However, you should only consider this method when deep or multiple electrodes are not practical.

See Appendix I which describes the use of a nomograph relating length of rod, diameter of rod, and earth resistivity to earth resistance.

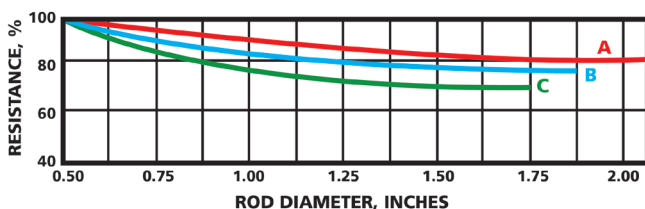

Fig. 16: Diameter of a rod has little effect on its earth resistance

Curve A, from Ref. 19

Curve B, average of Underwriters Laboratories tests at Chicago

Curve C, average of Underwriters Laboratories tests at Pittsburgh

Getting Down to Earth

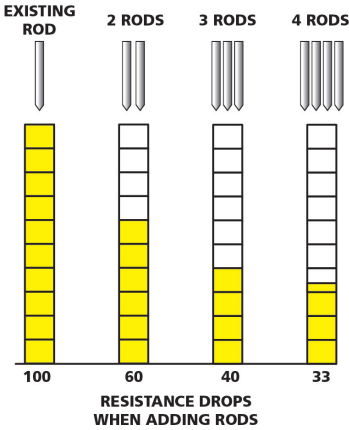

Fig. 17: Average results obtained from multiple-rod earth electrodes¹³

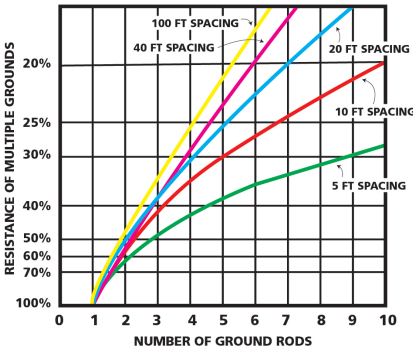

Fig. 18: Comparative resistance of multiple-rod earth electrodes. Single rod equals 100%¹⁴

^{13,14} Obtained from "Practical Grounding Principles and Practices for Securing Safe Dependable Grounds," Publication of Copperweld Steel Co., Glassport, Pa.

Getting Down to Earth

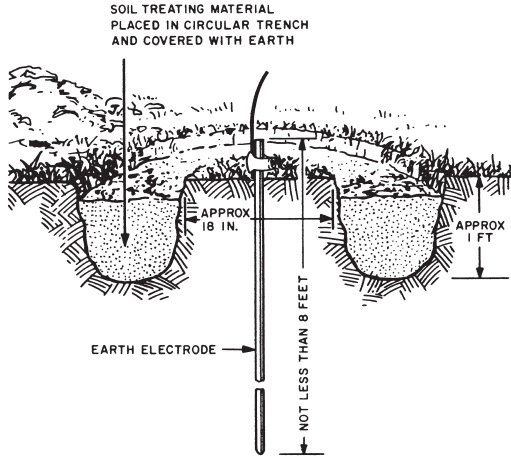

Fig. 19: Trench method of soil treatment¹⁵

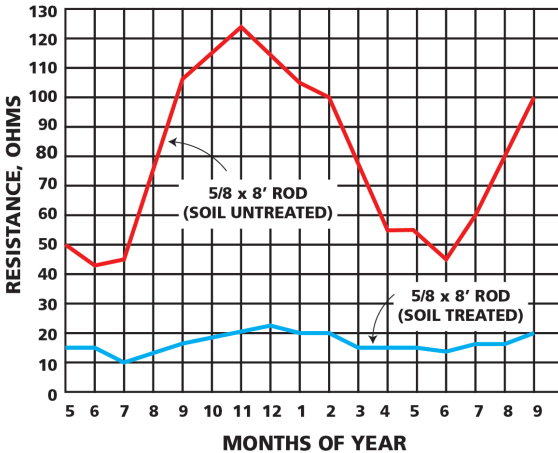

Fig. 20: Chemical treatment of soil lessens seasonal variation of electrodes' earth resistance¹⁶

^{15,16} Obtained from "Practical Grounding Principles and Practices for Securing Safe Dependable Grounds," Publication of Copperweld Steel Co., Glassport, Pa.

Getting Down to Earth

Additional Test Methods: Clamp-On Method

Fall-of-potential testing, and its modifications, conforms to IEEE 81. It is extremely reliable, highly accurate and can be used to test any size ground system. Additionally, the operator has complete control of the test set-up and can check or proof his/her results by testing at different probe spacing.

Unfortunately, the Fall of Potential method also comes with several drawbacks:

- It is extremely time consuming and labor intensive.
- Individual ground electrodes must be disconnected from the system to be measured.
- There are situations where disconnection is not possible.

The clamp-on ground tester performs a 'stakeless' test which is a ground resistance test performed without disconnecting the ground. Based on Ohm's Law ($R=V/I$), the stakeless test induces a known voltage in a loop circuit that includes ground, measures resultant current flow and calculates the loop resistance of the circuit. Four pole earth testers also perform a stakeless test; however they use two clamps, a voltage clamp (V clamp) and a current clamp (I clamp), and keep the clamps separate to prevent interaction between the two.

The operator must be certain that earth is included in the return loop and be aware that the tester measures the complete resistance of the path (loop resistance). All elements of the loop are measured in series. The method

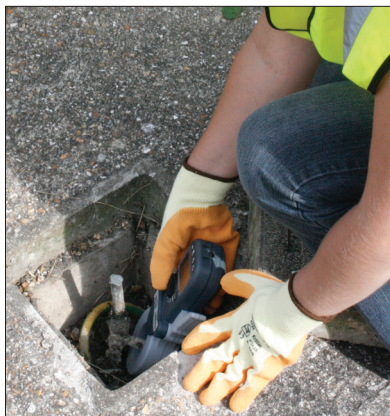

The Megger DET14C shown measuring a ground spike in a typical ground well.

Getting Down to Earth

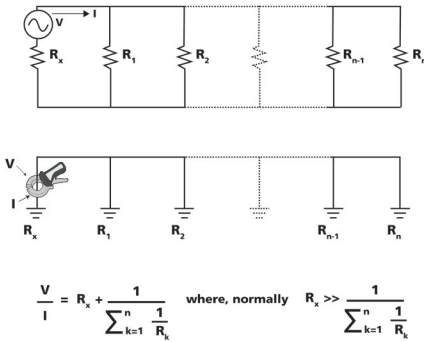

Fig 21: Basic clamp-on ground testing methodology

benefits from low return path resistance, i.e. where the ground resistance is large compared to the effective return loop resistance.

Figure 21 shows the basic methodology of the stakeless test. The tester is clamped over R_X , the ground being measured. All test current travels through the ground being measured (R_X) and divides between the remaining parallel resistances (R_1 to R_n). In a multiple ground system, the circuit can be considered a loop consisting of the individual ground electrode, a return path via all other electrodes and the mass of earth. The single electrode will have a higher resistance than the remainder of grounds connected in parallel.

Figure 22 shows a practical example of where the clamp-on method is highly effective because of the low return path loop resistance. The application is an interconnected parallel ground, like a lighting string. Importantly, ground forms part of the loop. The resistance-to-ground measure at R_G is:

$$R_{\text{loop}} = V_{\text{loop}}/I_{\text{loop}} = R_G + (1/(1/R_1 + 1/R_2 + 1/R_3 + 1/R_4 + 1/R_5))$$

For six similar electrodes with a resistance of 10Ω , the loop resistance measured when testing each electrode would be:

$$R_{\text{loop}} = 10 \Omega + 2 \Omega = 12 \Omega$$

Getting Down to Earth

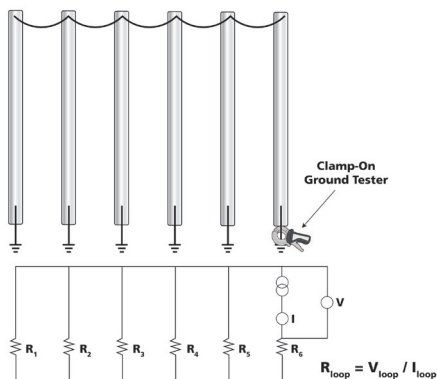

Fig 22: Pole ground application

For sixty similar electrodes with a resistance of $10\ \Omega$, the loop resistance measured when testing each electrode would be:

$$R_{loop} = 10\ \Omega + 0.17\ \Omega = 10.17\ \Omega$$

If one of six electrodes has a resistance of $100\ \Omega$, and the rest have a resistance of $10\ \Omega$, the loop resistance measured when testing the high resistance electrode would be:

$$R_{loop} = 100\ \Omega + 2\ \Omega = 102\ \Omega$$

The loop resistance measured when testing each of the five other electrodes would be:

$$R_{loop} = 10\ \Omega + 2.4\ \Omega = 12.4\ \Omega$$

The more parallel returns the lower the return loop resistance and therefore the closer the result to a fall-of-potential test. A high resistance ground among many low resistance returns will show up as a high resistance.

It is important for the operator to understand the limitations of the

stakeless test method so that he/she does not misuse the instrument and get erroneous or misleading readings. A clamp-on tester is an important tool in the bag of a test technician and trending results will add value over time with regard to early warning of degrading ground resistance.

Advantages of Stakeless Testing

The primary advantage of the clamp-on method is that it is quick and easy, as no probes have to be driven and the ground rod does not have to be disconnected from the system. One time saving example is when measuring a large industrial estate for lightning protection grounding, doing a fall-of-potential test on hundreds of ground points would take several days. The same testing performed using a clamp-on tester would take several hours. There are also examples like substation or cell-tower grounding where disconnection is not possible and the stakeless test is all that can be done. The clamp-on tester can be used to measure any loop resistance and application, such as a ground plate on a structure with multiple lightning conductors connected to it, as long as the user bears in mind the fact that it measures total loop resistance.

Many clamp-on testers include a current clamp measurement aimed at testing current flowing in a ground loop, ranging from less than 1 mA to 35 A ac. A current measurement is a useful safety check and will identify grounds that should not be disconnected because they can cause a spark. A current measurement should be performed if 50 Hz or 60 Hz (or any other power frequency) is thought to be interfering with clamp-on ground resistance reading.

Clamp-on testers operate at higher frequencies (typically between 1.5 kHz and 3.5 kHz) than 2-, 3-, and 4-pole testers (48Hz to 128 Hz) to reduce core size which improves access to ground tapes and cables and reduces tester weight. The downside is that this approach is less representative of a fault at power frequency than the traditional ground testing but the higher frequencies do reject inductive reactance which is advantageous for transmission tower grounds, lighting and similar sites.

Getting Down to Earth

Limitations of Stakeless Testing

The clamp-on tester is only effective in situations with multiple grounds in parallel. It cannot be used on isolated grounds, as there is no return path. In addition, it cannot be used if there is an alternate lower resistance loop not including ground. Fall-of-potential testing is advised for installation checks or commissioning new sites. General ground testing rules apply, e.g. if another part of the ground system is in the “sphere of influence” of the electrode under test, the result will be lower than the true resistance of the electrode.

A low return path is required for readings that approximate a fall-of-potential test result on a particular ground connection. A high resistance return path will yield high readings. The point of clamping the tester must be on the correct part of the loop for the electrode under test, as a wrong connection may give a faulty reading. The operator must have a thorough understanding of the grounding system to know exactly what is being measured.

The method is susceptible to noise from nearby electrical apparatus and older instruments are less effective for very low resistance grounds.

A final disadvantage of the clamp-on ground tester is that there is no built-in proof for the method without disconnection and performing a fall-of-potential test. As noted previously, a clamp-on ground tester should not be the only ground test instrument used. It is, however, an important part of the ground testing tool kit, along with a fall-of-potential tester. The clamp-on tester can be used to identify problems quickly. A fall-of-potential tester can then be used to confirm those problem results. This approach, together with trending results, allows the operator to be more productive and improves the early detection of potential faults.

While the IEEE Standard does not “recommend” clamp-on technology, it does describe it and the limitations of acceptable use: “There are several major advantages to the clamp-on method but also many disadvantages. It is important for the operator to understand the limitations of the test method so that the operator does not misuse the instrument and get erroneous or misleading readings.”¹⁷

¹⁷ Obtained from IEEE Standard 81-2012

Cell Tower Ground Testing

Communication towers present a problem where clamp-on testers perform well if used correctly, but measure 'dead shorts' if not. The problem is that the tower is live and provision of services prohibits removal of power. In America, utilities typically provide a low impedance utility earth connected to ground via an earth-ground link at the distribution panel. The stakeless method relies on having a low resistance return path in the loop, so this is an ideal point for clamp-on testers to measure ground resistance. Because the utility earth is very low, the loop resistance measured at the distribution panel ground by the clamp-on tester will be very close to the resistance a fall-of-potential measurement would yield. Note here that a fall-of-potential test would have to take into account the size of the total site ground system and ensure that long enough leads are available to correctly measure the ground resistance outside the sphere of influence of the ground system.

Figure 23 is an application where the clamp-on method is often misused at communication towers. This example will help show why knowledge of the system is critical to making the correct test. The illustration shows the problems with trying to use a clamp-on ground tester on a cellular tower. Cellular towers are grounded at the base, with each guy wire grounded and all of them connected together in a ground ring. If the operator clamps around the head of one of the guy wire grounds, the test current will simply complete the circuit in the ground ring and not through the soil. Note that the test current circulates through the conductor that connects the individual elements (ground rods) that comprise the ring. As such, the clamp-on ground tester will not be measuring the quality of the ground system. The reading will actually be a reading of the resistance of the "loop."

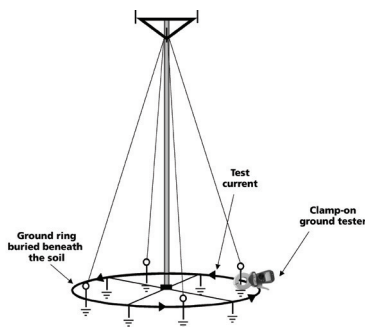

Fig 23: Cellular tower — example of a misused application

Getting Down to Earth

Additional Test Methods: Attached Rod Technique (ART)

Fall-of-potential testing is extremely reliable, highly accurate, conforms to IEEE 81 and gives the operator complete control over the set-up. Unfortunately, it is exceedingly time consuming and labor intensive, and requires that the individual ground electrodes be disconnected from the system.

As described in Appendix II, the clamp-on testing is quick and easy, but has many limitations. It requires a good return path, is susceptible to noise, has reduced accuracies and cannot be used on isolated grounds. It is not applicable for installation checks or commissioning new sites and has no built in proof.

The Attached Rod Technique (ART) method of testing provides some of the advantages of clamp-on testing (not having to disconnect the ground electrode) while remaining true to the theory and methodology of fall-of-potential testing. To understand the method, it is necessary to understand the theory and math behind it. In theory, a fall-of-potential measurement could be made without disconnecting the ground electrode if additional measurements were made with an earth leakage clamp meter (milliamp meter). Figures 24 and 25 show the three measurements that would be made.

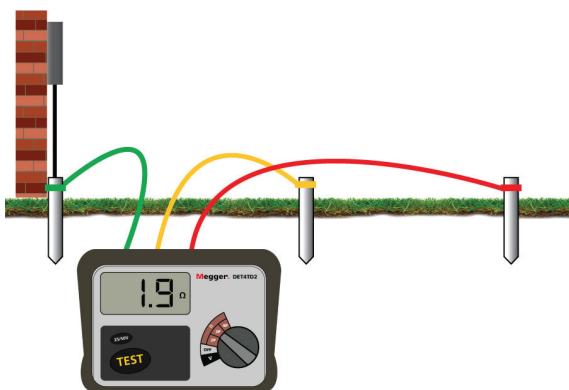

Fig 24: Ground resistance measurement

Getting Down to Earth

The first step is to measure the resistance (R_T) of the entire system using a typical fall-of-potential configuration. In this example, the reading for R_T is 1.9Ω .

Step two involves measuring the total current (I_T) being injected into the system from C1. For this example, I_T is 9.00 mA . The next step is to measure the amount of current (I_U) flowing to the service. In this case, I_U is 5.00 mA . With these measurements, the voltage drop from the selected volume of soil to the point of the P2 can be determined as follows:

$$V = I_T \times R_T$$

$$V = 0.009 \text{ A} \times 1.9 \Omega$$

$$V = 0.017 \text{ V}$$

The current through the ground electrode (I_G) can also be determined.

$$I_G = I_T - I_U$$

$$I_G = 9.00 \text{ mA} - 5.00 \text{ mA}$$

$$I_G = 4.00 \text{ mA}$$

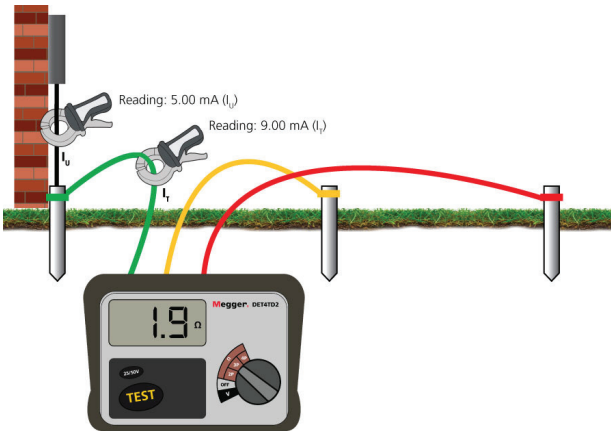

Fig 25: Leakage current measurements

Getting Down to Earth

Using the voltage drop and the current through the ground electrode, the resistance of the ground electrode (R_G) can be determined.

$$R_G = V \div I_G$$

$$R_G = 0.017 \text{ V} \div 0.004 \text{ A}$$

$$R_G = 4.25 \Omega$$

As noted, this is a theoretical approach that requires perfect conditions. Any additional current flowing from the service through the ground electrode would reduce the accuracy of the measurement. The earth leakage clamp meter would have to filter out all but the current generated by the instrument through C1 to ensure accuracy. Additionally, this approach requires that a number of mathematical calculations be made.

The Attached Rod Technique is based on the theory outlined above. Figure 26 shows an ART test being made.

Ground testers that are designed to make ART measurements include a

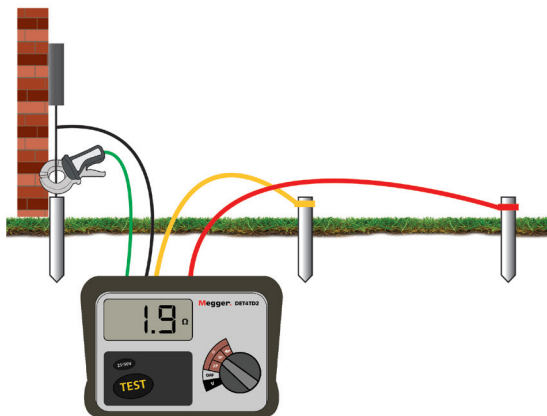

Fig 26: Attached Rod Technique (ART) measurement

Getting Down to Earth

special built-in current clamp that is placed between the C1 connection and the earth. This type of instrument includes noise protection and digitally filters out all currents other than that generated by the instrument. The instrument's microprocessor automatically performs all the calculations necessary to generate a resistance measurement for the ground electrode.

The test is a fall-of-potential test, meaning that all the "rules" still apply. Ideally, the operator would take ten measurements and plot the results to determine true resistance. Proper probe spacing remains critical, and fall-of-potential procedure and methodology must be followed. As with a traditional fall-of-potential test, the results can be proofed by increasing the probe spacings.

The advantage of the ART method over traditional fall-of-potential testing is that the ground electrode under test does not have to be disconnected from the system.



Using **ART** method with Megger DET2/3 Series to test commercial earth (ground) without disconnecting the system

Getting Down to Earth

Additional Test Methods: Star Delta Method¹⁸

If the current probe is so close that it is *within* the field of the test ground, the mathematical proofs for the Slope Method and Intersecting Curves will prove unintelligible and indicate to the operator that a better test position must be found. If this condition prevails, and room is so limited that an acceptable spacing cannot be derived, it may be necessary to resort to the Star-Delta Method. Named for the configuration of the test probes and lines of measurement (a graphic of it resembles the familiar symbols for “delta” and “star” windings), this method saves space by employing a tight configuration of three probes *around* the test ground (Figure 27).

In Figure 27, the ground electrode being tested is identified as “E.” Three

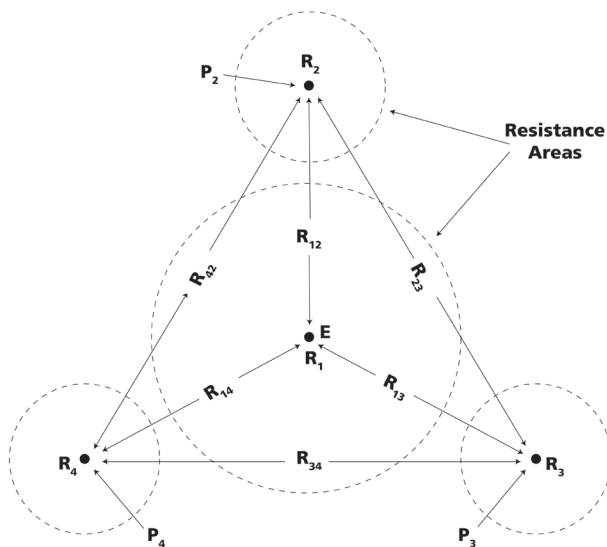

Fig 27: Star-Delta test configuration

¹⁸ Developed by W. Hymers and published in “Electrical Review”, January 1975

Getting Down to Earth

current probes (P_2 , P_3 and P_4) are placed equidistant from "E" with a 120° angle between them. Separation of potential and current circuits is abandoned, and a series of two-point measurements (see Figure 28) made between all pairs of probes, and probes to the ground under test.

In isolation, the ground under test "E" has a resistance R_1 , and probes P_2 , P_3 and P_4 have resistances R_2 , R_3 and R_4 respectively. In relation to each other, the resistance between them is the sum of their individual resistances (like two resistances in series). For example, if the resistances of "E" and P_2 were measured on a two-point system, their total resistance would be $R_1 + R_2$. Therefore, when considered as a whole, the Star-Delta resistance pattern is shown by the arrows between "E" and the probes on Figure 28. The tests result in six measurements (R_{12} , R_{13} , R_{14} , R_{23} , R_{34} and R_{42}) that are then put through a mathematical "crunch" of four series equations to calculate the resistance of the test ground.

Provided that the distances between "E" and the current probes are

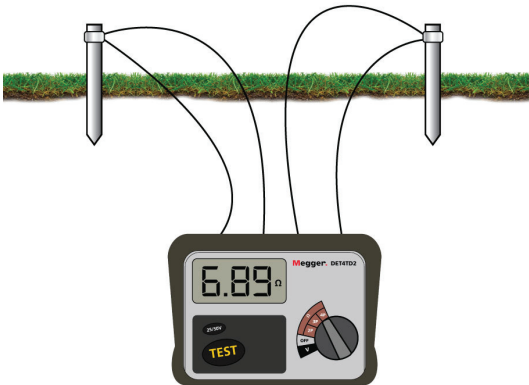

Fig 28: Making a two-point measurement

Getting Down to Earth

adequate (so the resistance areas do not overlap), the individual resistance of "E" can be determined as follows:

$$1] R_1 = 1/3 [(R_{12} + R_{13} + R_{14}) - (R_{23} + R_{34} + R_{42})/2]$$

$$2] R_1 = 1/2 (R_{12} + R_{13} - R_{23})$$

$$3] R_1 = 1/2 (R_{12} + R_{14} - R_{42})$$

$$4] R_1 = 1/2 (R_{13} + R_{14} - R_{34})$$

If the result from equation 1 matches substantially that from the other three equations, then satisfactory conditions have existed for the measurement. However, if one of the probes has been situated so that its resistance area has overlapped that of "E" or another of the probes, an obviously false reading (perhaps even a negative value of resistance) will be obtained. A false reading warns the operator to redo the test.

Performing calculations to obtain the values of R2, R3 and R4 would show which probe was at fault. The equations for R2, R3 and R4 follow:

$$R_2 = 1/2 (R_{12} + R_{23} - R_{13})$$

$$R_2 = 1/2 (R_{12} + R_{42} - R_{14})$$

$$R_2 = 1/2 (R_{23} + R_{42} - R_{34})$$

$$R_3 = 1/2 (R_{13} + R_{23} - R_{12})$$

$$R_3 = 1/2 (R_{13} + R_{34} - R_{14})$$

$$R_3 = 1/2 (R_{23} + R_{34} - R_{42})$$

$$R_4 = 1/2 (R_{14} + R_{42} - R_{12})$$

$$R_4 = 1/2 (R_{14} + R_{34} - R_{13})$$

$$R_4 = 1/2 (R_{42} + R_{34} - R_{23})$$

Determining Touch and Step Potential

Touch potential is the term given to the potential difference a person might experience across their body if they were, for example, standing on the ground outside the earthed perimeter fence of a substation and touching the fence at the time a fault to earth occurred.

To determine this value, an earth tester may first be used to find the earth resistance. It is connected as shown in Fig. 30.

Terminal "C1" of the earth tester is connected to the grounding system of the substation (e.g. at "E") and terminal "C2" is connected to a current spike "C" (set up for testing purposes some distance away). Terminal "P1" is connected to the structure being tested (e.g. the perimeter fence which the person might touch) and terminal "P2" is connected to a potential spike "P" which is inserted into the ground about 3 ft away from the perimeter fence adjacent to the point of test on the fence (i.e. where the person might stand).

The earth tester is operated in the normal way and a resistance measurement made. This is the effective resistance between the point of test on the fence and the potential spike as seen by the test current. The maximum value of the current that would flow in the earth when a fault occurred at the substation must be known. The maximum fault current has to be calculated from parameters associated with the substation ratings involved; it is not necessarily straight forward.

The effective maximum touch potential can be calculated within a reasonable margin of accuracy (about 20 percent, depending how true the earth resistance measurement is), by multiplying the fault current by the earth resistance.

Step potential is obtained in a similar way. This is the potential difference

Getting Down to Earth

a person would experience between their feet if they walked over the ground in which a fault current existed.

Terminals “C1” and “C2” on the earth tester are connected as described for determining touch potential. Terminals “P1” and “P2” are connected to two potential spikes set up for test purposes. The spikes are hammered into the ground at positions “A” and “B” as shown in Fig. 29, about 3 ft apart (i.e., the approximate length of an average person’s step). (Note: “A” is nearest to “E” and is connected to terminal “P1.”)

The earth tester is operated in the normal way and a resistance measurement is made. This is the effective resistance between “A” and “B” as seen by the test current. Again, the maximum value of the current that would flow in the earth under fault conditions at the substation must be known.

The effective step potential can be calculated by multiplying the fault current by the earth resistance, again within a reasonable accuracy.

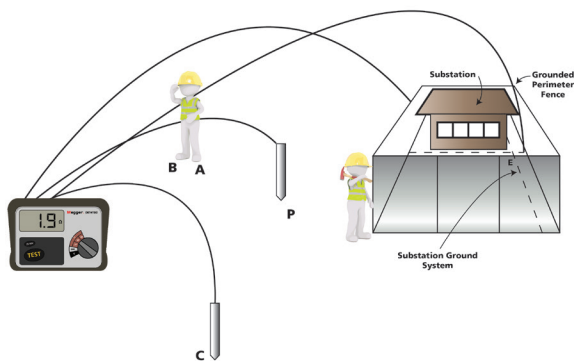

Fig. 29: Method of use for determining touch and step potential

SECTION III

Accurately Measuring Earth Resistance for Large Ground Systems

Large ground systems, such as those found in substations and power stations, are an important part of the protection of the electricity supply network. They ensure that fault current will enable protective devices to operate correctly. A substation must have a low ground resistance to reduce excessive voltages developing during a fault which could endanger safety of nearby people or damage equipment.

When installing a ground system the resistivity of the surrounding soil should be measured. Inaccurate resistivity tests can lead to unnecessary costs in the design of the system.

After installation it is vital to check that the electrical grounding system meets the design criteria and should be measured periodically to ensure corrosion or changes in the soil's resistivity do not have an adverse effect. Ground networks may not appear faulty until a fault occurs and a dangerous situation arises.

To obtain a sufficiently low value of ground resistance, ground systems may consist of an earth mat covering a large area or many interconnected rods. Suitable test techniques must be used for large systems to ensure that valid readings are obtained. This is unlike a small single ground rod (for example, a lightning protection system or residential ground) which can be simple to test.

Testing Challenges in Large Ground Systems

Securing valid measurements when testing large ground systems requires that proper techniques and instrumentation be used. The nature of substation and power station grounding systems and related conditions make testing far more complex than on a simple ground rod. Following are the three key challenges in testing substation ground systems:

1. The physically large area of a substation/power station ground system results in a large "resistance area" and, consequently, long distances to the test probes. Ideally, the current test probe should be placed 10

Getting Down to Earth

times the maximum distance on the ground system (e.g, 3000 ft for a 300 ft² ground grid) to find the “flat” portion of the characteristic resistance curve.

2. The large “resistance area” typically gives ground resistance values of less than 0.5 Ω ; test instrument resolution is critical if small variances in readings are to be observed. If the test instrument does not have suitable resolution, instrument errors can overwhelm the results.
3. Large electrical networks contain noise consisting of the frequency of the power utility and its harmonics, plus high frequency noise from switching, etc., and induced signals from other sources. The ground tester must retrieve and analyze a small test signal in a much larger test environment. Most ground testers only inject a single frequency (usually 128 Hz) which is adequate in most situations because it avoids harmonics of standard line frequencies. Unfortunately, it is often not adequate in substations, and this type of interference can cause significant measurement errors.

Addressing the Testing Challenges in Large Ground Systems

In the ideal world, testing a large ground system would be conducted in complete accordance with the Fall-of Potential Method. Unfortunately, the large “resistance areas” found in large ground systems may make it unfeasible or even impossible to carry out this test. As noted above, setting the current test probe 10 times the maximum distance of the ground system can require leads to be many thousands of feet. In these situations, the Slope Method can be used effectively because it does not require the user to find the “flat” portion of the curve or to know the electrical center as a point from which to measure. Readings are taken at 20 percent, 40 percent and 60 percent of the current probe distance and fit into a mathematical model of the resistance characteristic.

The other challenges faced in testing large ground systems relate to the capabilities of the test instrument. Improved technology has made it possible for instruments to be designed that address problems created by the characteristics and conditions found in and around large ground systems.

For the Slope Method to provide meaningful results, accurate measurement of the variations at different points is critical. Since large ground systems typically have resistance values of less than 0.5Ω , the differences can be quite small. An instrument with $1 \text{ m}\Omega$ measurement resolution can indicate the small differences between low readings.

Noise is a major problem in testing large ground systems, and must be addressed to ensure accurate results. To be effective, the test instrument must be designed to overcome the effects of significant noise in the test environment. Among the technical capabilities that can help offset the noise problem are:

- A variable test frequency (rather than a single, fixed test frequency) which can help remove any stray noise that could affect the reading.
- A high peak-to-peak interference suppression level.
- A sophisticated filter system to reject more noise.
- Various current settings to improve the signal-to-noise ratio when necessary.

Getting Down to Earth

Measurement of the Resistance of Large Earth-Electrode Systems: Intersecting Curves Method¹⁹

The difficulties of measuring the resistance of large electrode systems involve the use of very long leads to connect the potential and current probes. An alternative method, in which such long leads are not necessary, has been devised. The basic principle is to obtain earth-resistance curves for several current-electrode spacings and, by assuming a number of successive positions for the electrical center of the system, to produce intersection curves which will give the earth resistance and the position of the electrical center.

Some rather difficult problems are encountered when the resistance of an earth-electrode system, consisting of a number of rods, tapes, etc., all connected in parallel and spread over a large area, is to be measured. The usual method of measurement that worked very well has one disadvantage; namely, that it is generally necessary to place the auxiliary current probe at a considerable distance from the earth-electrode system. In some cases, this distance can be as much as 3000 ft, and this is not always convenient or possible.

A method which does not require such long lengths of cable would obviously be better. Therefore, the following is suggested.

Suppose that all measurements are made from an arbitrary starting point O, the distance C to the current probe and the variable distance P to the potential probe being measured from this point. Then a curve such as abc (Fig. 30), giving the measured resistance against the value of P, can be obtained. Now suppose the electrical center of the earth-electrode system is actually at D, distance X from O. Then the true distance from the center to the current probe is C + X, and the true resistance is obtained when the potential probe is at a distance 0.618 (C + X) from D. This means that the value of P, measured from O, is 0.618 (C + X) - X. If X is now given a number of values, the corresponding values of P can be calculated and the resistance read off the curve. These resistances can be plotted against

¹⁹ "Measurement of the Resistance of An Earth-Electrode System Covering a Large Area." Dr. G. Tagg; IEE Proceedings, Vol. 116, Mar. 1969.

the values of X in another curve. When this process is repeated for a different value of C , and another curve of resistance against X obtained, the two curves should cross at the required resistance. The process can be repeated for a third value of C as a check. These curves are called intersection curves. It has been assumed that D , O and C are in the same straight line.

Test at a Large Substation

Tests were made at a station covering an area approximately 300 ft x 250 ft. The earthing system consists of a number of earth plates and rods joined together by copper cables. The testing line was run out from a point on the face approximately halfway along one side and the current electrode was placed at distances of 400, 600, 800, and 1000 ft from the starting point. The resulting earth-resistance curves are given in Fig. 31. The intersection curves are plotted and the final value of resistance is found in Fig. 32. It is reasonable to expect that this value is correct to within a few percent.

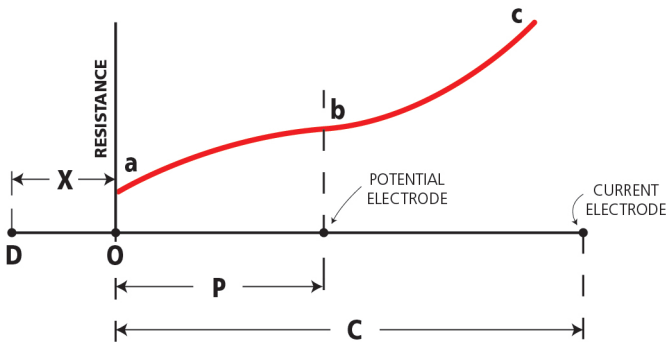

Fig. 30: Earth resistance curve applicable to systems of a large area

Getting Down to Earth

General Comments

It is the purpose of this method to reduce that distance to the current probe, and this appears to have been achieved, but there are some additional points to be noted. From the work which has been done on the method, there are certain limits to the distance to the current probe. To comply, if the earthing system is in the form of a square, the minimum distance to the current probe should not be less than the side of the square. On the other hand, the maximum distance should not be too great. If it is, the resulting curve is very flat, and the intersection point becomes rather indefinite. Again, for a square system, this maximum distance should not exceed twice the side of the square. For other shapes of earth-electrode systems, it is necessary to judge suitable minimum and maximum values for the distance to the current probe.



Using a Megger DET4 series to test building earth (ground)

Getting Down to Earth

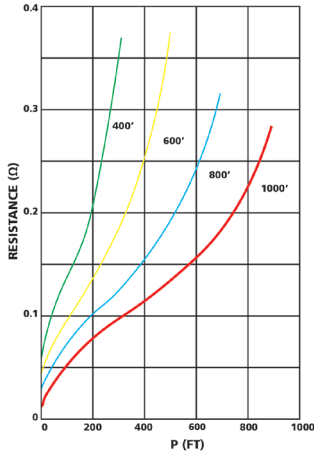

Fig. 31: Earth resistance curves for a substation

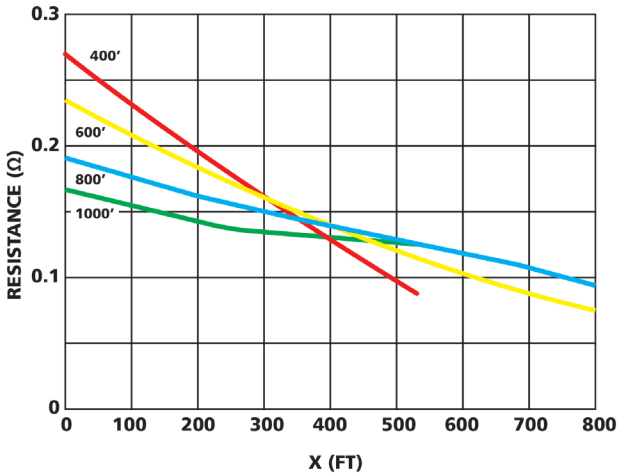

Fig. 32: Intersection curves for Fig. 31. The center of the triangle formed by the intersection gives the earth resistance 0.146Ω.

Getting Down to Earth

Measurement of The Resistance of Large Earth Electrode Systems: Slope Method²⁰

It has been shown that the true earth resistance of an electrode system is obtained when the temporary potential P is positioned at a distance from the electrical center of the system equal to 61.8 percent of the distance from the electrical center to the temporary current probe. This principle is used in the technique called "Intersecting Curves" explained in Appendix II. It becomes apparent that the method is complex in nature and requires some "trial and error" calculations.

A further technique was evolved and is described here. It is easier to use and has been shown to give satisfactory results, both in theoretical and practical cases, and when the soil is nonhomogenous. It is called the Slope Method.

To apply this technique, perform the following step procedure.

1. Choose a convenient rod E to which the Earth Tester can be connected. E is one of many paralleled rods forming the complex earth system.
2. Insert the current probe at a distance (D_C) from E (distance D_C is normally 2 to 3 times the maximum dimension of the system).
3. Insert potential probes at distances equal to 20% of D_C , 40% of D_C and 60% D_C . See examples in step 4.
4. Measure the earth resistance using each potential probe in turn. Let these resistance values be R_1 , R_2 and R_3 respectively.

Examples: $R_1 = 0.2 \times D_C$ $R_2 = 0.4 \times D_C$ $R_3 = 0.6 \times D_C$

5. Calculate the value of
$$\mu = \frac{R_3 - R_2}{R_2 - R_1}$$

The resultant is called μ and represents the change of slope of the

²⁰ "Measurement of the Resistance of Large Earth-Electrode Systems by the Slope Method." Dr. G. Tagg; IEE Proceedings, Vol. 117, Nov. 1970.

Getting Down to Earth

resistance/distance curve.

6. Refer to Table VII to find the corresponding value of D_P/D_C for μ .
7. Since D_C (distance to the current probe) is already known, calculate a new D_P (distance of the potential probe) as follows then insert the potential probe at this new distance from E.

$$D_P = D_P/D_C \times D_C$$

Now measure the earth resistance by placing the potential probe at this new distance D_P . This measurement is known as the “true” resistance.

8. Repeat the whole process for a larger value of D_C . If the “true” resistance decreases appreciably as D_C is increased, it is necessary to increase the distance of D_C still further. After making a number of tests and plotting the “true” resistance, the curve will begin to show less of a decrease and will indicate more stable readings. It is at this point the resistance of the grounding system is noted.

NOTE: As with other earth testing techniques, some experimentation may be necessary to ascertain if the practical result is as accurate as the theory appears to indicate.

The Slope Method has been designed to eliminate the need for impractically long leads by the ability to interpolate the correct distance along the combined resistance curve, i.e. the curve of the current probe’s resistance superimposed upon that of the tested grid, without sufficient spacing to produce the characteristic “flat portion” between.

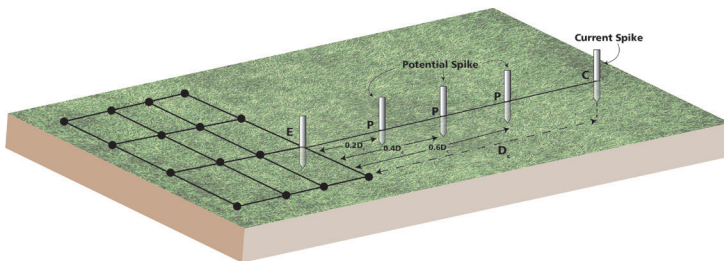

Fig. 33: Potential probe locations for using the slope method

Getting Down to Earth

One particular observation on the Slope Method is that if the calculation of μ is greater than that given in the table, the distance C must be increased.

Secondly, before the measured values for R_1 , R_2 and R_3 can be accepted with a degree of confidence, it is recommended that a curve be plotted which will identify any localized effects and eliminate uncharacteristic readings from the calculations. Thirdly, it is also suggested that the test be repeated in different directions and with different spacings. The various results should exhibit a reasonable degree of agreement.

Table VII: Values of D_p/D_c for Various Values of μ

μ	D_p/D_c	μ	D_p/D_c	μ	D_p/D_c
0.40	0.643	0.80	0.580	1.20	0.494
0.41	0.642	0.81	0.579	1.21	0.491
0.42	0.640	0.82	0.577	1.22	0.488
0.43	0.639	0.83	0.575	1.23	0.486
0.44	0.637	0.84	0.573	1.24	0.483
0.45	0.636	0.85	0.571	1.25	0.480
0.46	0.635	0.86	0.569	1.26	0.477
0.47	0.633	0.87	0.567	1.27	0.474
0.48	0.632	0.88	0.566	1.28	0.471
0.49	0.630	0.89	0.564	1.29	0.468
0.50	0.629	0.90	0.562	1.30	0.465
0.51	0.627	0.91	0.560	1.31	0.462
0.52	0.626	0.92	0.558	1.32	0.458
0.53	0.624	0.93	0.556	1.33	0.455
0.54	0.623	0.94	0.554	1.34	0.452
0.55	0.621	0.95	0.552	1.35	0.448
0.56	0.620	0.96	0.550	1.36	0.445
0.57	0.618	0.97	0.548	1.37	0.441
0.58	0.617	0.98	0.546	1.38	0.438
0.59	0.615	0.99	0.544	1.39	0.434
0.60	0.614	1.00	0.542	1.40	0.431
0.61	0.612	1.01	0.539	1.41	0.427
0.62	0.610	1.02	0.537	1.42	0.423
0.63	0.609	1.03	0.535	1.43	0.418
0.64	0.607	1.04	0.533	1.44	0.414
0.65	0.606	1.05	0.531	1.45	0.410
0.66	0.604	1.06	0.528	1.46	0.406
0.67	0.602	1.07	0.526	1.47	0.401
0.68	0.601	1.08	0.524	1.48	0.397
0.69	0.599	1.09	0.522	1.49	0.393
0.70	0.597	1.10	0.519	1.50	0.389
0.71	0.596	1.11	0.517	1.51	0.384
0.72	0.594	1.12	0.514	1.52	0.379
0.73	0.592	1.13	0.512	1.53	0.374
0.74	0.591	1.14	0.509	1.54	0.369
0.75	0.589	1.15	0.507	1.55	0.364
0.76	0.587	1.16	0.504	1.56	0.358
0.77	0.585	1.17	0.502	1.57	0.352
0.78	0.584	1.18	0.499	1.58	0.347
0.79	0.582	1.19	0.497	1.59	0.341

Four Potential Method

The Four Potential Method is another method based on fall-of-potential that allows the user to overcome the problems posed by complex grounding systems where the electrical center of the ground system is difficult to locate. This method was first introduced by Dr. G.F. Tagg in a 1964 IEE paper [6]. For the purpose of this booklet, we will cover the test method and the formulae by which the resistance of the ground system can be determined. The theory behind the method will not be covered, although it links the resistance values obtained by measurements at six different positions for the potential probe in four formulae with the true resistance (R_{∞}), which would occur with an infinite distance to the current probe.

The test probes are set out as shown in Figure 34, with measurement made from the edge of the electrical system. The current probe is set a suitable distance away from the edge of the ground system. The potential probe is then placed at distances equal to 20%, 40%, 50%, 60%, 70% and 80% of the distance to the current probe and a test is made at each location. The resistance values obtained (R_1 , R_2 , R_3 , R_4 , R_5 , and R_6) are then entered into four formulae.

The formulae used follow:

$$1] (R_{\infty}) = -0.1187R_1 - 0.4667R_2 + 1.9816R_4 - 0.3961R_6$$

$$2] (R_{\infty}) = -2.6108R_2 + 4.0508R_3 - 0.1626R_4 - 0.2774R_6$$

$$3] (R_{\infty}) = -1.8871R_2 + 1.1148R_3 + 3.6837R_4 - 1.9114R_5$$

$$4] (R_{\infty}) = -6.5225R_3 + 13.6816 R_4 - 6.8803R_5 + 0.7210R_6$$

The four results for R_{∞} should substantially agree, and an average of the

Getting Down to Earth

results can be calculated. However, because of the assumptions made in the theory of this method, it is possible that the result from equation (1) will be less accurate than the others. If the result from (1) is in variance from the other results, it can be ignored and the average calculated from the other three results.

One major drawback to this method is that it requires a large distance for d_c . This distance can range up to 2,000 feet or more for ground systems covering a large area or of very low resistance.

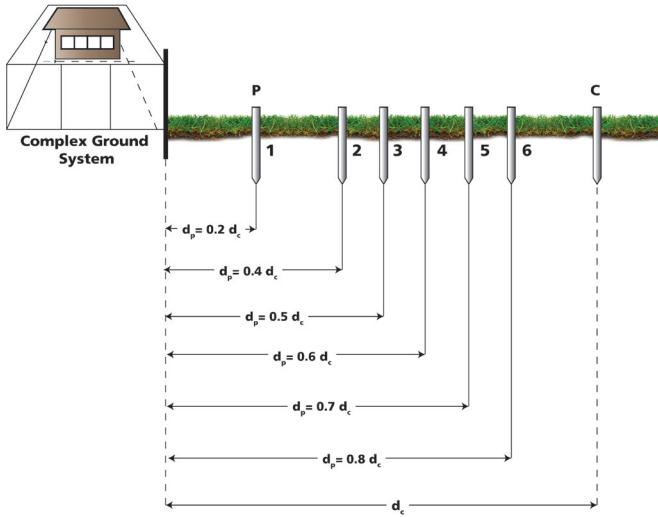

Fig 34: Four potential method test configuration

Getting Down to Earth

Getting Down to Earth

APPENDIX I

Nomograph Guide to Getting Acceptable Earth Resistance²¹

Dr. L.E. Whitehead of the DuPage Laboratories developed a nomograph (Fig. 35) which can be a helpful guide in meeting the established standard for a minimum earth resistance. If you have a given earth-electrode system and find that your Megger instrument reading is too high, the graph can be used to show what you must do to lower the value. Note that it covers three variable conditions that affect earth resistance of the electrode: earth resistivity, length of rod, and diameter of rod.

To illustrate use of the nomograph, let's take an example. Assume you have a 5/8-in. rod driven 10 ft into the soil. Your Megger instrument indicates an earth resistance of 6.6 Ω . But let's say your specification for this resistance is "no more than 4 Ω ." To get this, you can change one or more of the three variables -- the simplest and most effective being depth of the driven rod. To find the required depth to give you a 4 Ω earth resistance, proceed as follows: With a ruler, draw a line from the 10-ft point in the L line to the 5/8-in. point in the d line; this gives a reference point where the line crosses the q line. Connect this reference point with 6.6 Ω -the measured resistance on the R line, as shown in Fig. 35; read the value of earth resistivity when this line crosses the ρ line. The value is 2000 ohm-cm.

To determine the required rod depth for a 4 Ω earth resistance, draw a line from this point on the R line through the 2000 point on the ρ line until you cross the q line. The dashed line on Fig. 35 shows this step. Now, assuming you keep rod diameter unchanged, connect the 5/8 point on d line through your new reference point on q and extend the line to L. This gives you the required rod depth for the 4 Ω resistance value. Finally, take a new instrument reading to check the value, because earth resistivity may not be constant (as the nomograph assumes).

²¹"Nomograph Determines Ground-Rod Resistance," L.E. Whitehead, Electric Light & Power, December 1962.

Getting Down to Earth

Another way to reduce the earth resistance would be to lower the earth resistivity. Note in Fig. 35 that if you draw a line from a reference point 1 (leaving rod depth and diameter unchanged), you would need to reduce earth resistivity to about 1000 ohm-cm to give the required 4- Ω earth resistance. You could do this by chemical treatment, as described earlier, but normally the deeper rod is the easier way.

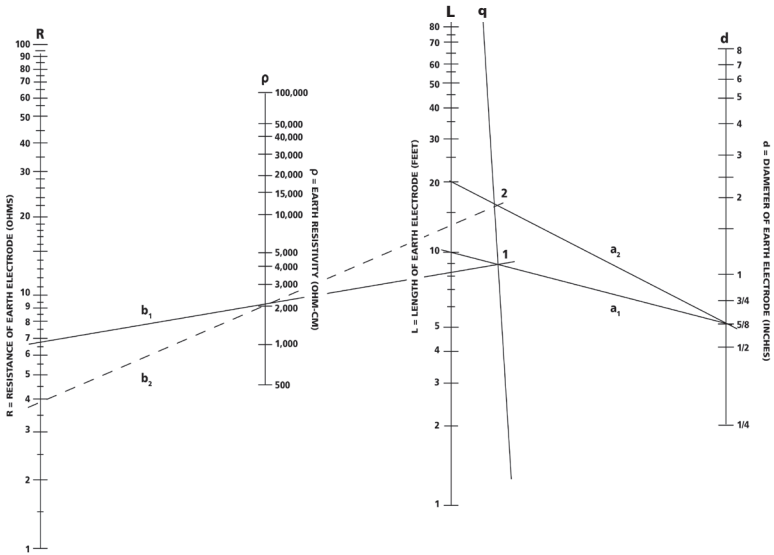

Fig. 35: Nomograph relating the basic factors affecting earth resistance.

Getting Down to Earth

APPENDIX II Ground Testing Methods Chart

*Method	Best Applications
1. Fall of Potential	Small electrode systems (1 or 2 rods/plates); complex systems if full resistance curve is plotted
2. Simplified Fall of Potential	Small and medium electrode systems
3. 61.8% Rule	Small and medium electrode systems
4. Slope	Large ground systems like substations
5. Intersecting Curves	Large ground systems like substations
6. Dead Earth (Two Point)	Not recommended
7. Star Delta	Ground systems located in congested urban areas and/or rocky terrain where probe positioning is difficult
8. Four Potential	Medium to large ground systems
9. Clamp-On	Simple ground system with existing return path through multiple grounds

**The Attached Rod Technique (ART) is based on Fall of Potential*

Getting Down to Earth

Advantages	Limitations
Extremely reliable; conforms to IEEE 81; operator has complete control of test set-up	Requires long distances (and long test leads) to the test probes on medium and large systems; time consuming and labor intensive
Easier to carry out than full Fall of Potential; much faster	Ineffective if the electrical center is unknown; less accurate than full Fall of Potential as less measurements are being made
Simplest to carry out; minimal calculation; fewest number of test probe moves	Assumes perfect conditions; ineffective if electrical center is unknown; soil must be homogeneous; less accurate
Knowledge of electrical center not necessary; long distances to test probes not necessary	Susceptible to non-homogeneous soil; less accurate; requires math
Knowledge of electrical center not necessary; long distances to test probes not necessary	Numerous calculations and drawing of curves
Quick and simple to perform	Problems of possible resistance overlap; non-metallic (high resistance) return
Long distances for test probe positioning not necessary	Resistance areas should not overlap; a number of calculations required
Knowledge of electrical center not necessary	Long distances to test probes is still required; a number of calculations required
Quick, easy; includes bonding and overall connection resistance	Effective only in situations with multiple grounds in parallel; susceptible to noise; limited basis in standards; no built-in proof

Getting Down to Earth

GROUND TESTERS AVAILABLE FROM MEGGER®

DET2/3

The DET2/3 is a robust and compact advanced earth/ground test instrument designed to measure earth electrode resistance and soil resistivity. The DET2/3 is a tester for use on large or more complex earth/ground systems, which include power stations, substations, railways, communication systems and difficult test environments.



With its powerful processor controlled system it provides a flexible and 'user-friendly' approach to earth tests by the provision of excellent error detection capabilities and full test information shown on a large color display. The DET2/3 can also provide a live trace of its measurements onscreen, which graphically shows the amount of changes and/or noise from the system under test - a powerful diagnostic tool for anyone doing earth/ground testing.

DET14C and DET24C

The DET14C and DET24C are advanced clamp-on ground resistance testers that set new standards pertaining to access, performance, features, simplicity of operation and safety. Designed with flat core ends, they prevent dirt build-up, ensuring measurement integrity and improved reliability over products with interlocking teeth. Other enhancements include safety to CATIV 600V, a built-in filter function for electrically noisy environments, time and date stamped stored test results and ultra long battery life. On the DET24C, stored test results can be transferred to PC via Bluetooth



Getting Down to Earth

DET3TD and DET3TC

The DET3TD and DET3TC are three-terminal digital models designed to measure ground resistance from 0.01Ω to 2000Ω and earth voltages up to 100 V . The units are supplied complete with a carrying case, test leads and probes.

The DET3TC includes Attached Rod Technique (ART) capability. This added function allows the testing of on-site grounds separately without having to remove the utility connection. With the optional ICLAMP, it will measure ground current from 0.5 mA to 19.9 A and leakage current down to 0.5 mA .



DET4T2 Series

The DET4T2 Series are four-terminal digital instruments and includes **four models** with different kit variants for each. The **DET4TD2 and DET4TR2** are designed to measure ground resistance from 0.01Ω to $20 \text{ k}\Omega$ and earth voltages up to 100 V . The **DET4TC2 and DET4TCR2** can measure ground resistance from 0.01Ω to $200 \text{ k}\Omega$, a key capability for soil resistivity testing. The DET4TC2 and DET4TCR2 also include a current measuring function for ART capability.

The DET4TD2 and DET4TC2 are powered by eight AA batteries while the DET4TR2 and DET4TCR2 are powered from rechargeable AA cells.



The units are supplied complete with a rugged carrying case, test leads, stakes and calibration certificate.

Getting Down to Earth

GROUND TESTING ACCESSORIES AVAILABLE FROM MEGGER®

ETK (Earth Test Kit)

The Megger Earth Test Kits (ETK models) are designed to be as practical as possible. Housed in a carrying bag, the kits are stored neatly, well protected and easy to transport. In use, the test leads are fitted and retained on reels with smooth action. Simply run out the test lead from the instrument to the test point, clip the end directly into the spike and run a test. When the test is complete, unclip the test leads and wind them in. The kits come in different combinations to meet different needs and constraints. They are supplied with a tape measure to ensure accurate placement of test spikes. The reels can be daisy chained together to provide longer lengths in manageable sections.

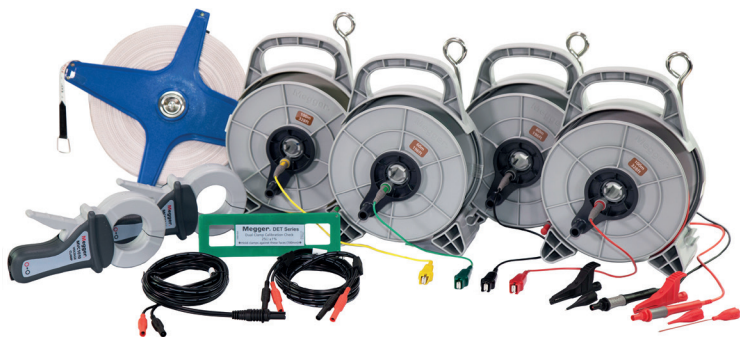

References

- [1] "A Method of Measuring Earth Resistivity," F. Wenner, Report No. 258, Bulletin of Bureau of Standards, Vol. 12, No. 3, Oct. 11, 1915.
- [2] "An Experience With the Megger," W.H. Simpson, Oil and Gas Journal.
- [3] "Grounding Electric Circuits Effectively," J.R. Eaton, General Electric Review, June, July, August 1941.
- [4] "Calculation of Resistance to Ground," H.B. Dwight, AIEE (IEEE) Transactions, Vol. 55, 1936.
- [5] "Ground Connections for Electrical Systems," O.S. Peters, U.S. National Bureau of Standards, Technological Paper 108, June 20, 1918 (224 pages - now out of print).
- [6] Paper 4619S from the proceedings of the IEE volume III No. 12 December 1964 by Dr. G.F. Tagg

Getting Down to Earth

Additional Resources

1. "Earth Conduction Effects in Transmission System," E.D. Sunde, D. Van Nostrand Co.
2. "Principles and Practices in Grounding," Pub. No. D9, Edison Electric Institute.
3. "Guide for Safety in AC Substation Grounding," AIEE (IEEE) No. 80.
4. "Recommended Guide for Measuring Ground Resistance and Potential Gradients in the Earth." AIEE (IEEE) No. 81.
5. "Master Test Code for Resistance Measurement, AIEE (IEEE) No. 550.
6. "Some of the Fundamental Aspects of Ground Resistance Measurement, E.B. Curdts, AIEE (IEEE) Paper No. 58-106, Transactions, Vol. 77, 1958.
7. "Equipment Grounding," Industrial Power System Data Book, General Electric Co.
8. "Lightning Arrester Grounds," H.M. Towne, General Electric Review, Parts I, II, III, Vol. 35, pp. 173, 215, 280, March, April, May 1932.
9. "Grounding Principles and Practices-Fundamental Considerations on Ground Currents," R. Rudenberg AIEE (IEEE), Elect. Eng., January 1946, Also AIEE (IEEE) Publication S2.
10. "Grounding Principles and Practices - Establishing Grounds," C.H. Jensen, AIEE (IEEE), Elect. Eng., February 1945, also AIEE (IEEE) Publications S2.
11. "Deep Driven Grounds," C.H. Jensen, EEI, T&D Committee, May 1951.
12. "Grounding Principles and Practices - Static Electricity in Industry," Beach, AIEE (IEEE) Publication S2.
13. "Corrosion of Buried Metals and Cathodic Protection," M.C. Miller, Petroleum Engineer, March, April, May, June 1944.

Getting Down to Earth



Megger
2621 Van Buren Ave
Norristown, PA 19403

us.megger.com

GDTE2020

The word 'Megger' is a registered trademark.

Copyright © 2018

Megger [®]