

SDS6000A Series Digital Oscilloscope

Service Manual

EN01A



Contents

1	IMPORTANT SAFETY INFORMATION	3
1.1	GENERAL SAFETY SUMMARY	3
1.2	SAFETY TERMS AND SYMBOLS	5
1.3	WORKING ENVIRONMENT	6
1.4	COOLING REQUIREMENTS	7
1.5	POWER AND GROUNDING REQUIREMENTS	8
1.6	CLEANING	9
1.7	ABNORMAL CONDITIONS	9
1.8	SAFETY COMPLIANCE	9
2	FIRST STEPS	11
2.1	DELIVERY CHECKLIST	11
2.2	QUALITY ASSURANCE	11
2.3	MAINTENANCE AGREEMENT	11
3	DOCUMENT CONVENTIONS	12
4	PREPARE INFORMATION	13
4.1	FUNCTIONAL CHECK	13
4.1.1	<i>Power-on Inspection</i>	13
4.1.2	<i>Probe Compensation</i>	15
4.1.3	<i>Auto Setup</i>	16
4.1.4	<i>Self-Calibration</i>	16
4.2	INTERFACE TEST	17
4.2.1	<i>USB Host Test</i>	17
4.2.2	<i>USB Device Test</i>	18
4.2.3	<i>LAN Port Test</i>	19
4.2.4	<i>Pass/Fail out Test</i>	21
5	PERFORMANCE TEST	24
5.1	TO VERIFY DC GAIN ACCURACY	26
5.2	TO VERIFY OFFSET ACCURACY	31
5.3	TO VERIFY DC MEASUREMENT ACCURACY	34
5.4	TO VERIFY BANDWIDTH	35
5.5	TO VERIFY TIME BASE ACCURACY	37
5.6	TO VERIFY TRIGGER LEVEL	38
5.7	TO VERIFY EXT TRIGGER LEVEL	39
5.8	TO VERIFY TRIGGER SENSITIVITY	40
5.9	TO VERIFY CHANNEL SKEW	42

5.10	To VERIFY INPUT IMPEDANCE	43
6	DISASSEMBLY PROCEDURES	45
6.1	SAFETY CONSIDERATION AND CAUTIONS	45
6.2	TOOLS LISTS.....	45
6.3	DISASSEMBLY PROCEDURES	46
6.3.1	<i>To Remove the Handle and Foot</i>	<i>46</i>
6.3.2	<i>To Remove the Rear Cover.....</i>	<i>47</i>
6.3.3	<i>To Remove the Rear Metal Cover.....</i>	<i>48</i>
6.3.4	<i>To Remove the Back-Chassis Module</i>	<i>49</i>
6.3.5	<i>To Remove the Power Supply Module and Fan.....</i>	<i>50</i>
6.3.6	<i>To Remove Front Panel</i>	<i>51</i>
6.3.7	<i>To Remove the Probe Interface Board and the Mainboard</i>	<i>52</i>
6.3.8	<i>To Remove the Rubber Keypad and Keyboard.....</i>	<i>53</i>
7	SOLVING GENERAL PROBLEMS	54
8	TROUBLESHOOTING.....	57
8.1	SAFETY CONSIDERATION AND CAUTIONS	57
8.2	REQUIRED EQUIPMENT	58
8.3	TROUBLESHOOTING FLOWCHART	58
8.4	TO CHECK THE POWER SUPPLY MODULE	59
8.5	TO CHECK THE ACQUISITION BOARD	60
8.5.1	<i>Acquisition Board Drawing</i>	<i>60</i>
8.5.2	<i>Check the board-level power supplies.....</i>	<i>61</i>
8.5.3	<i>Check the clock.....</i>	<i>63</i>
8.6	TO CHECK THE LCD.....	65
8.6.1	<i>To Check the LCD Power Supply.....</i>	<i>65</i>
8.6.2	<i>To Check the LCD Signal.....</i>	<i>65</i>

1 Important Safety Information

This manual contains information and warnings that must be followed by the user for safe operation and to keep the product in a safe condition.

1.1 General Safety Summary

Carefully read the following safety precautions to avoid personal injury and prevent damage to the instrument and any products connected to it. To avoid potential hazards, please use the instrument as specified.

To Avoid Fire or Personal Injury.

Use Proper Power Line.

Only use a local/state-approved power cord for connecting the instrument to mains power sources.

Ground the Instrument.

The instrument grounds through the protective terra conductor of the power line. To avoid electric shock, the ground conductor must be connected to the earth. Make sure the instrument is grounded correctly before connecting its input or output terminals.

Connect the Signal Wire Correctly.

The potential of the signal wire is equal to the earth, so do not connect the signal wire to a high voltage. Do not touch the exposed contacts or components.

Look over All Terminals' Ratings.

To avoid fire or electric shock, please look over all ratings and signed instructions of the instrument. Before connecting the instrument, please read the manual carefully to gain more information about the ratings.

Equipment Maintenance and Service.

When the equipment fails, please do not dismantle the machine for maintenance. The equipment contains capacitors, power supply, transformers, and other energy storage devices, which may cause high voltage damage. The internal devices of the equipment are sensitive to static electricity, and direct contact is easy to cause irreparable damage to the equipment. It is necessary to return to the

factory or the company's designated maintenance organization for maintenance. Be sure to pull out the power supply when repairing the equipment. Live line operation is strictly prohibited. The equipment can only be powered on when the maintenance is completed and the maintenance is confirmed to be successful.

Identification of Normal State of Equipment.

After the equipment is started, there will be no alarm information and error information at the interface under normal conditions. The curve of the interface will scan from left to right freely. If there is a button in the scanning process or there is an alarm or error prompt, the device may be in an abnormal state. You need to view the specific prompt information. You can try to restart the setting. If the fault information is still in place, do not use it for testing. Contact the manufacturer or the maintenance department designated by the manufacturer to carry out maintenance to avoid the wrong test data caused by the use of the fault or endanger the personal safety.

Not Operate with Suspected Failures.

If you suspect that there is damage to the instrument, please let qualified service personnel check it.

Avoid Circuit or Wire Exposed Components Exposed.

Do not touch exposed contacts or components when the power is on.

Do not operate in wet/damp conditions.

Do not operate in an explosive atmosphere.

Keep the surface of the instrument clean and dry.

Only probe assemblies that meet the requirement of UL61010-031 and CAN/CSA-C22.2 No.61010-031 shall be used.

Only a lithium battery with the same specifications as the original battery should be used to replace the battery on board.







Not to use the equipment for measurements on mains circuits, not to use the equipment for measurements on voltage exceed the voltage range describe in the manual. The maximum additional transient voltage cannot exceed 1300 V.

The responsible body or operator should refer to the instruction manual to preserve the protection afforded by the equipment. If the equipment is used in a manner not specified by the manufacturer, the protection provided by the equipment may be impaired.

Any parts of the device and its accessories are not allowed to be changed or replaced, other than authorized by the manufacturer or agent.

1.2 Safety Terms and Symbols

When the following symbols or terms appear on the front or rear panel of the instrument or in this manual, they indicate special care in terms of safety.

	<p>This symbol is used where caution is required. Refer to the accompanying information or documents to protect against personal injury or damage to the instrument.</p>
	<p>This symbol warns of a potential risk of shock hazard.</p>
	<p>This symbol is used to denote the measurement ground connection.</p>
	<p>This symbol is used to denote a safety ground connection.</p>
	<p>This symbol shows that the switch is an On/Standby switch. When it is pressed, the oscilloscope's state switches between Operation and Standby. This switch does not disconnect the device's power supply. To completely power off the oscilloscope, the power cord must be unplugged from the AC socket after the oscilloscope is in the standby state.</p>
	<p>This symbol is used to represent alternating current, or " AC ".</p>
<p>CAUTION</p>	<p>The " CAUTION " symbol indicates a potential hazard. It calls attention to a procedure, practice, or condition which may be dangerous if not followed. Do not proceed until its conditions are fully understood and met.</p>
<p>WARNING</p>	<p>The " WARNING " symbol indicates a potential hazard. It calls attention to a procedure, practice, or condition which, if not followed, could cause bodily injury or death. If a WARNING is indicated, do not proceed until the safety conditions are fully understood and met.</p>

1.3 Working Environment

The design of the instrument has been verified to conform to the EN 61010-1 safety standard per the following limits:

Environment

The instrument is used indoors and should be operated in a clean and dry environment with an ambient temperature range.

Note: Direct sunlight, electric heaters, and other heat sources should be considered when evaluating the ambient temperature.

	Warning: Do not operate the instrument in explosive, dusty, or humid environments.
---	---

Ambient Temperature

Operating: 0 °C to +50 °C

Non-operating: -30 °C to +70 °C

Note: Direct sunlight, radiators, and other heat sources should be taken into account when assessing the ambient temperature.

Humidity

Operating: 5% ~ 90% RH, 30 °C, derate to 50 % RH at 40 °C

Non-operating: 5% ~ 95% RH

Altitude

Operating: ≤ 3,048 m, 25 °C

Non-operating: ≤ 12,191 m

Installation (overvoltage) Category

This product is powered by mains conforming to installation (overvoltage) Category II.

Note:

Installation (overvoltage) category I refers to situations where equipment measurement terminals are connected to the source circuit. In these terminals, precautions are done to limit the transient voltage to a correspondingly low level.

Installation (overvoltage) category II refers to the local power distribution level which applies to equipment connected to the AC line (AC power).

Degree of Pollution

The oscilloscopes may be operated in environments of Pollution Degree II.

Note: Degree of Pollution II refers to a working environment that is dry and non-conductive pollution occurs. Occasional temporary conductivity caused by condensation is expected.

IP Rating

IP 20 (as defined in IEC 60529).

1.4 Cooling Requirements

This instrument relies on forced air cooling with internal fans and ventilation openings. Care must be taken to avoid restricting the airflow around the apertures (fan holes) at each side of the oscilloscope. To ensure adequate ventilation it is required to leave a 15 cm (6 inches) minimum gap around the sides of the instrument.

	<p>CAUTION: Do not block the ventilation holes located on both sides of the oscilloscope.</p>
---	--

	<p>CAUTION: Do not allow any foreign matter to enter the oscilloscope through the ventilation holes, etc.</p>
---	--

1.5 Power and Grounding Requirements

The instrument operates with a single-phase, 100 to 240 Vrms (+/-10%) AC power at 50/60 Hz (+/-5%), or single-phase 100 to 120 Vrms (+/-10%) AC power at 400 Hz (+/-5%).

No manual voltage selection is required because the instrument automatically adapts to line voltage.

Depending on the type and number of options and accessories (probes, PC port plug-in, etc .), the instrument can consume up to 193 W of power.

Note: The instrument automatically adapts to the AC line input within the following ranges:

Voltage Range:	90 - 264 Vrms	90 - 132 Vrms
Frequency Range:	47 - 63 Hz	380 - 420 Hz

The instrument includes a grounded cord set containing a molded three-terminal polarized plug and a standard IEC 320 (Type C13) connector for making line voltage and safety ground connection. The AC inlet ground terminal is connected directly to the frame of the instrument. For adequate protection against electrical shock hazards, the power cord plug must be inserted into a mating AC outlet containing a safety ground contact. Use only the power cord specified for this instrument and certified for the country of use.

	<p>Warning: Electrical Shock Hazard!</p> <p>Any interruption of the protective conductor inside or outside of the oscilloscope, or disconnection of the safety ground terminal creates a hazardous situation.</p> <p>Intentional interruption is prohibited.</p>
---	---

The position of the oscilloscope should allow easy access to the socket. To make the oscilloscope completely power off, unplug the instrument power cord from the AC socket.

The power cord should be unplugged from the AC outlet if the oscilloscope is not to be used for an extended period.

	<p>CAUTION: The outer shells of the front panel terminals (CH1, CH2, CH3, CH4, EXT) are connected to the instrument's chassis and therefore to the safety ground.</p>
---	--

1.6 Cleaning

Clean only the exterior of the instrument, using a damp, soft cloth. Do not use chemicals or abrasive elements. Under no circumstances allow moisture to penetrate the instrument. To avoid electrical shock, unplug the power cord from the AC outlet before cleaning.

	<p>Warning: Electrical Shock Hazard!</p> <p>No operator serviceable parts inside. Do not remove covers.</p> <p>Refer servicing to qualified personnel</p>
---	--

1.7 Abnormal Conditions

Do not operate the oscilloscope if there is any visible sign of damage or has been subjected to severe transport stresses.

If you suspect the oscilloscope's protection has been impaired, disconnect the power cord and secure the instrument against any unintended operation.

Proper use of the instrument depends upon careful reading of all instructions and labels.

	<p>Warning: Any use of the oscilloscope in a manner not specified by the manufacturer may impair the instrument's safety protection. This instrument should not be directly connected to human subjects or used for patient monitoring.</p>
---	--

1.8 Safety Compliance

This section lists the safety standards with which the product complies.

U.S. nationally recognized testing laboratory listing

- UL 61010-1:2012/R: 2018-11. Safety Requirements for Electrical Equipment for Measurement, Control, and Laboratory Use – Part 1: General Requirements.
- UL 61010-2-030:2018. Safety Requirements for Electrical Equipment for Measurement, Control, and Laboratory Use – Part2-030: Particular requirements for testing and measuring circuits.

Canadian certification

- CAN / CSA-C22.2 No. 61010-1:2012 / A1:2018-11. Safety Requirements for Electrical Equipment for Measurement, Control, and Laboratory Use – Part 1: General Requirements.
- CAN / CSA-C22.2 No. 61010-2-030:2018. Safety Requirements for Electrical Equipment for Measurement, Control, and Laboratory Use – Part 2-030: Particular requirements for testing and measuring circuits.

2 First Steps

2.1 Delivery Checklist

First, verify that all items listed on the packing list have been delivered. If you note any omissions or damage, please contact your nearest **SIGLENT** customer service center or distributor as soon as possible. If you fail to contact us immediately in case of omission or damage, we will not be responsible for replacement.

2.2 Quality Assurance

The oscilloscope has a 3-year warranty (1-year warranty for probes and accessories) from the date of shipment, during normal use and operation. **SIGLENT** can repair or replace any product that is returned to the authorized service center during the warranty period. We must first examine the product to make sure that the defect is caused by the process or material, not by abuse, negligence, accident, abnormal conditions, or operation.

SIGLENT shall not be responsible for any defect, damage, or failure caused by any of the following:

- a) Attempted repairs or installations by personnel other than **SIGLENT**.
- b) Connection to incompatible devices / incorrect connection.
- c) For any damage or malfunction caused by the use of non-**SIGLENT** supplies. Furthermore, **SIGLENT** shall not be obligated to service a product that has been modified. Spare, replacement parts, and repairs have a 90-day warranty.

The oscilloscope's firmware has been thoroughly tested and is presumed to be functional. Nevertheless, it is supplied without warranty of any kind covering detailed performance. Products not made by **SIGLENT** are covered solely by the warranty of the original equipment manufacturer.

2.3 Maintenance Agreement

We provide various services based on maintenance agreements. We offer extended warranties as well as installation, training, enhancement and on-site maintenance, and other services through specialized supplementary support agreements. For details, please consult your local **SIGLENT** customer service center or distributor.

3 Document Conventions

For convenience, text surrounded by a box border is used to represent the button of the front panel. For example, Print represents the "Print" button on the front panel.

Text with shading is used to represent the touchable or clickable menu / button / region on the touch screen. For example, Display represents the " Display " menu on the screen:

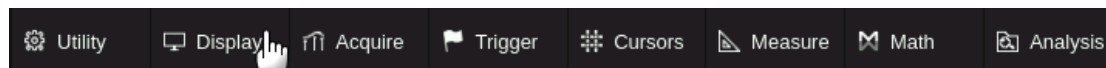

For the operations that contain multiple steps, the description is in the form of " Step 1 > Step 2 >...". As an example, follow each step in the sequence to enter the upgrade interface:

Utility > Maintenance > Upgrade

Press the Utility button on the front panel as step 1, click the Maintenance option on the screen as step 2, and click the Update option on the screen as step 3 to enter the upgrade interface.

4 Prepare Information

Before initiating performance verification or any adjustments, it is recommended the user follow these procedures. The following topics are discussed in this chapter.

- How to perform functional checks
- How to operate standard interface tests
- How to use the self-calibration routine
- How to recall factory default settings

For more detailed information about oscilloscope operation, please refer to the User Manual.

4.1 Functional Check

The functional check details four types of checks used to determine if the oscilloscope is operating properly.

4.1.1 Power-on Inspection

The standard power supply for the instrument is 100~240 V, 50/60 Hz, or 100~120 V, 400 Hz. Please use the power cord provided with the instrument to connect it to AC power.



Figure 1 Connect the power cord



CAUTION: To avoid electric shock, make sure that the instrument is correctly grounded to the earth before connecting AC power.

Press the Power button located at the lower-left corner of the front panel to start the oscilloscope. After the boot-up the oscilloscope will begin to perform its power-on tests automatically, after which the **Default** button can be pressed to recall the factory default settings.

4.1.2 Probe Compensation

When a passive probe is used for the first time, you should compensate it to match the input channel of the oscilloscope. Non-compensated or poorly compensated probes may increase measurement inaccuracy or error. The probe compensation procedures are as follows:

1. Connect the coaxial cable interface (BNC connector) of the passive probe to any channel of the oscilloscope.
2. Connect the probe to the “ Compensation Signal Output Terminal ” (Cal) on the front of the oscilloscope. Connect the ground alligator clip of the probe to the “ Ground Terminal ” under the compensation signal output terminal.



3. Press the Auto Setup button.
4. Check the waveform displayed and compare it with the following.

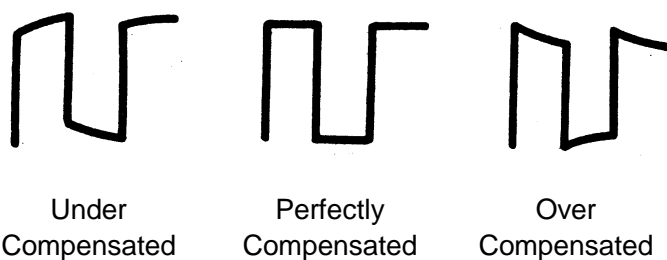

5. Use a non-metallic driver to adjust the low-frequency compensation adjustment hole on the probe until the waveform displayed is as the “ Perfectly compensated ” in the figure above.

It's not necessary to compensate an active probe.

4.1.3 Auto Setup

Press the **Auto Setup** button to enable the waveform auto setting function. The oscilloscope will automatically adjust the horizontal time base, vertical scale, and trigger mode according to the input signal to obtain an optimum waveform display.

- Auto Setup will not work on all signal types, especially time-varying bursts or slow signals (< 20 Hz). If Auto Setup cannot achieve desired settings, you can manually adjust the vertical, horizontal, and trigger systems.
- Select the channel with the lowest frequency when several channels are connected to signals.

4.1.4 Self-Calibration

The self-calibration program can quickly calibrate the oscilloscope to reach the best working state and the most precise measurement. It is recommended to perform a self-calibration if the change of ambient temperature is more than 5 °C. Make sure the oscilloscope has been warmed up or operated for more than 30 minutes before the self-calibration.

Please perform the self-calibration as follows:

1. Disconnect everything from all inputs.
2. Operate **Utility** > **Maintenance** > **Self Calibration** , and the following dialog will appear. Select **Continue** to start the self-calibration program.

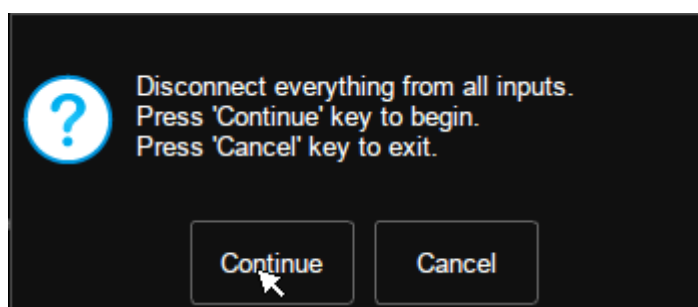

Figure 2 Calibration Interface

The oscilloscope will not respond to any operations until the self-calibration is finished. After the self-calibration is completed, touch the screen or press any button to exit.

4.2 Interface Test

The SDS6000A series oscilloscope is designed with four standard interfaces: USB Host, USB Device, LAN, and Pass/Fail. Connecting to other instruments via these interfaces enables the oscilloscope to achieve additional capabilities. To ensure the oscilloscope is operating properly, it is recommended that the user first test the interfaces.

4.2.1 USB Host Test

To test whether the USB Host interface is operating correctly.

Tools:

A U-disk (FAT32 format recommended)

Steps:

1. Insert a U-disk (flash drive) into the USB Host interface on the front panel of the oscilloscope.
2. A message prompt “ USB flash drive detected .” appears on the screen, and an icon will be shown in the lower right corner of the screen which confirms the U-disk has been successfully recognized.

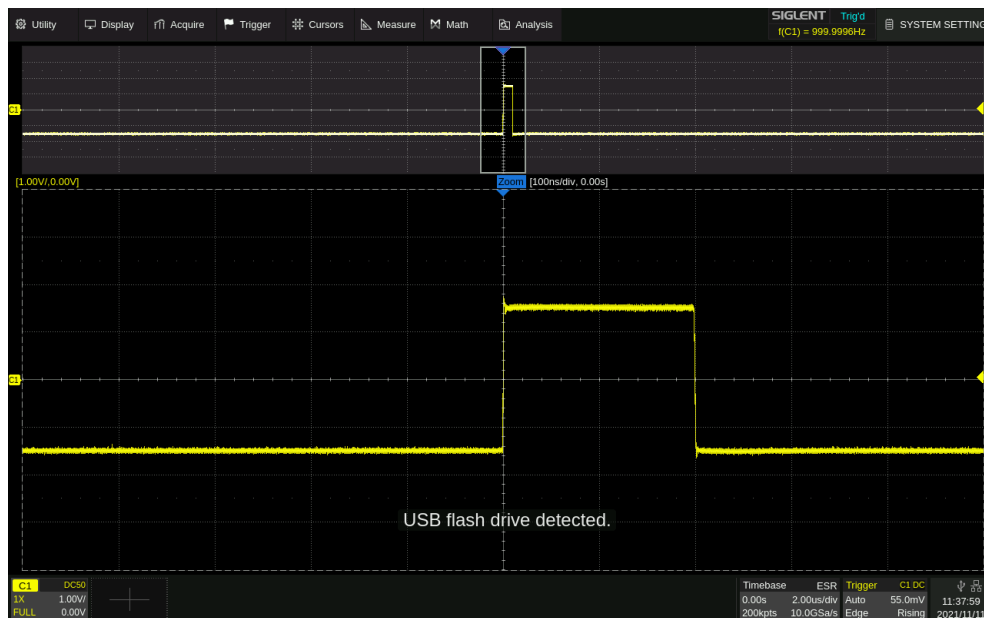

Figure 3 USB drive detected

4.2.2 USB Device Test

To test if the USB Device interface is operating correctly.

Tools:

- A computer with a USB interface
- A standard USB cable (Type AB)
- National Instruments NI-Max software

Steps:

1. Set up National Instruments Measurement and Automation Explorer (NI-Max) software on a computer and install the driver step by step following the instructions.
2. Connect the oscilloscope to the computer using a USB cable.
3. Run NI-MAX software. Click “ Device and Interface ” at the upper left corner of the NI software interface and immediately the “ USBTMC ” device symbol is displayed.

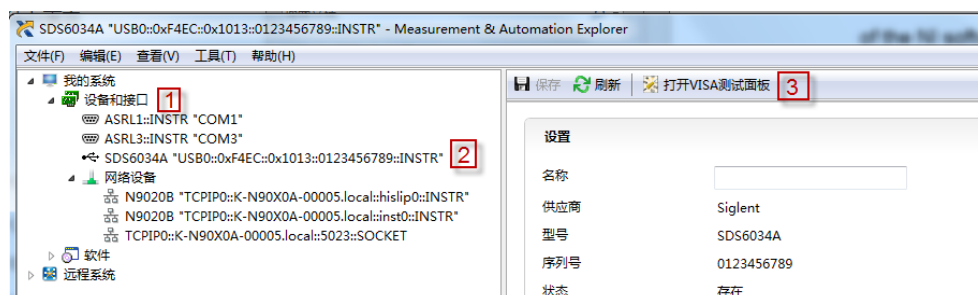

4. Click “ Open VISA Test Panel ” option button, and then the following Interface will appear. Next, click the “ Input/Output ” option button and click the “ Query ” option button to view the Read operation information.

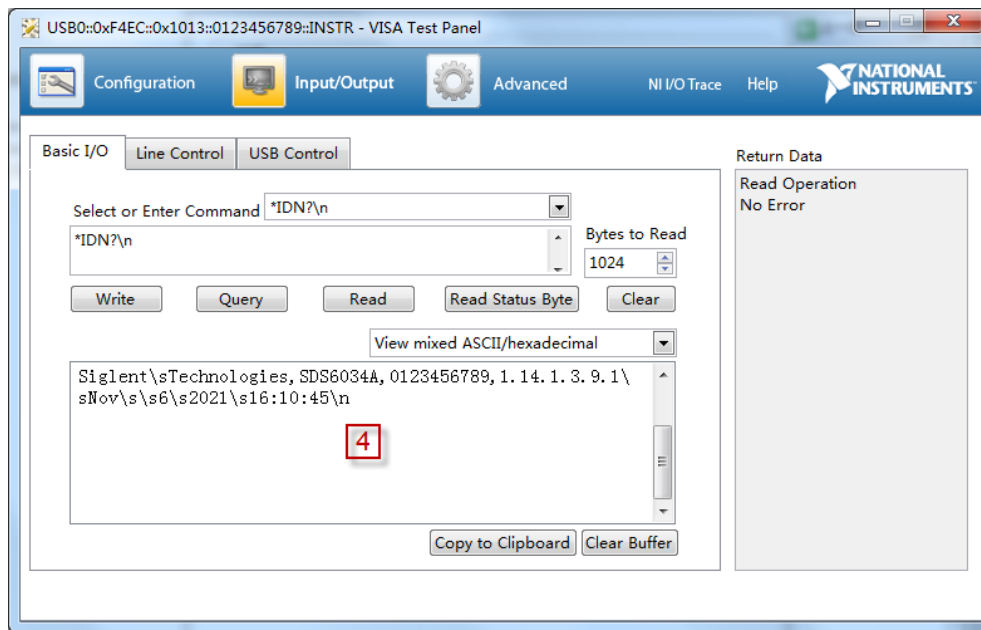

4.2.3 LAN Port Test

Use to test if the LAN interface operates correctly when connected with NI Visa software.

Tools:

- A computer with a LAN interface
- A standard LAN cable
- National Instruments NI-MAX software

Steps:

1. Set up the National Instruments Measurement and Automaton Explorer (NI-MAX) software on a computer and install the driver using the following instructions.
2. Perform **Utility** > **I/O** > **LAN Config** to open the LAN Config dialog box. And input usable IP Address and Subnet Mask.

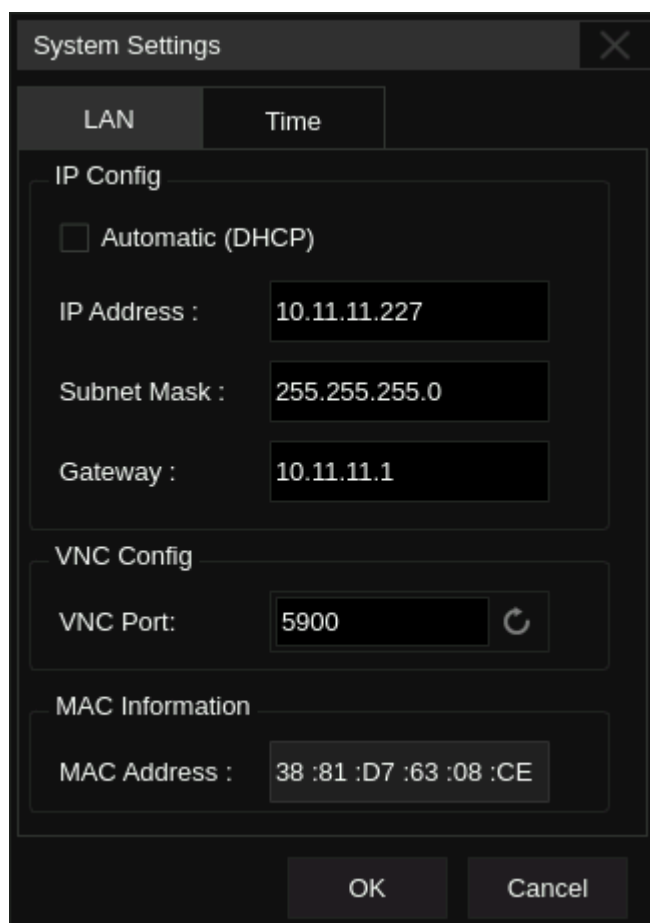
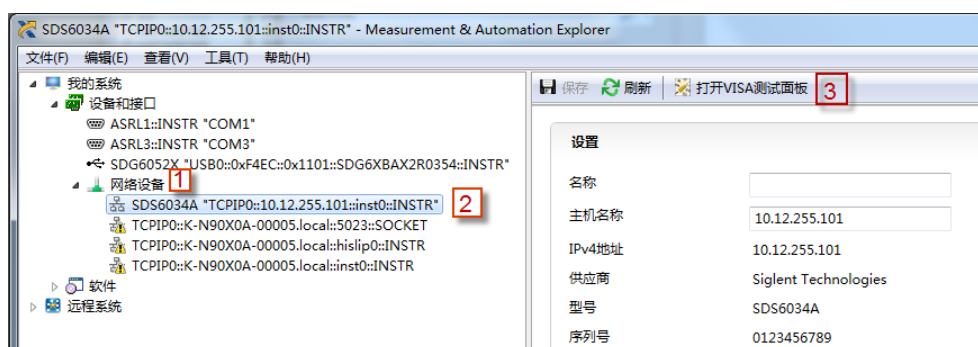
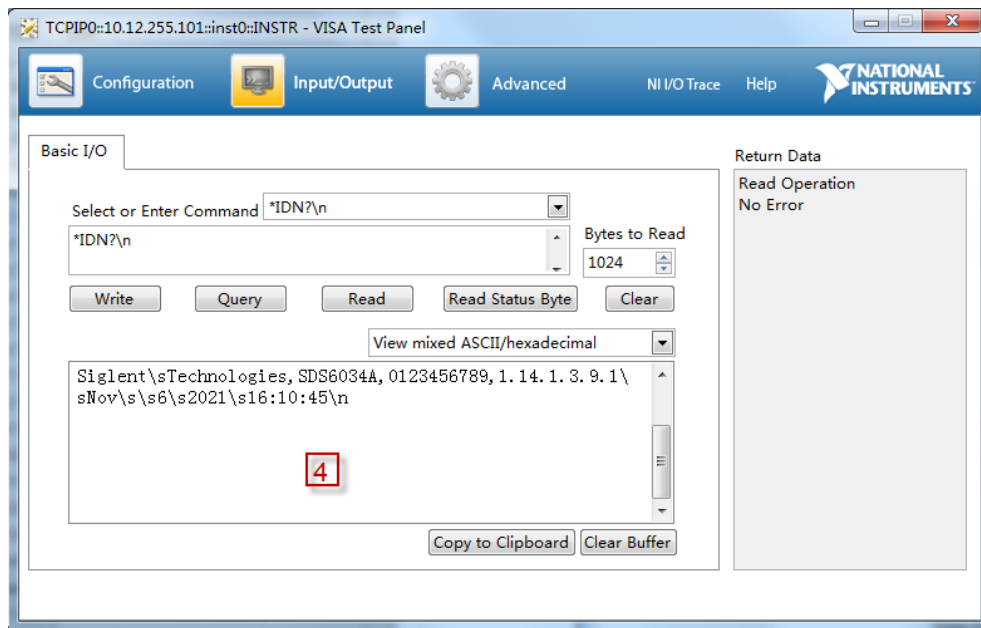

Figure 4 IP Setting interface

3. Connect the oscilloscope to the computer using a LAN cable via the LAN interface ports.
4. Run NI-MAX software. Click “ Device and Interface ” at the upper left corner of the NI software interface and select the “ LAN ” device symbol.



5. Click “ Open VISA Test Panel ” option button, which then displays the following interface (below). Then click the “ Input/Output ” option button and click the “ Query ” option button. The “ Read ” operation information will be displayed.



4.2.4 Pass/Fail out Test

To test the Mask Test function and signal output by viewing on another oscilloscope.

Tools:

- A second oscilloscope
- Two BNC cables

Steps:

1. Turn on the SDS6000A oscilloscope.
2. Enable Channel 1.
3. Perform **Analysis** > **Mask Test** to open the Mask Test dialog box, and touch **Mask Setup** > **Create Mask** to set the mask. Set the items as below:

Table 1 Mask Test Settings

Parameter	Setting
Enable to Test	On
Source	CH1
Type	All in
Display Info	On
Mask Setting	
Mask X	0.32
Mask Y	0.32

Note: Press **Create Mask** to complete Mask setting, after mask x setting and mask y setting.

After selecting the corresponding items as shown in the table above, the screen will appear as in Figure 5:

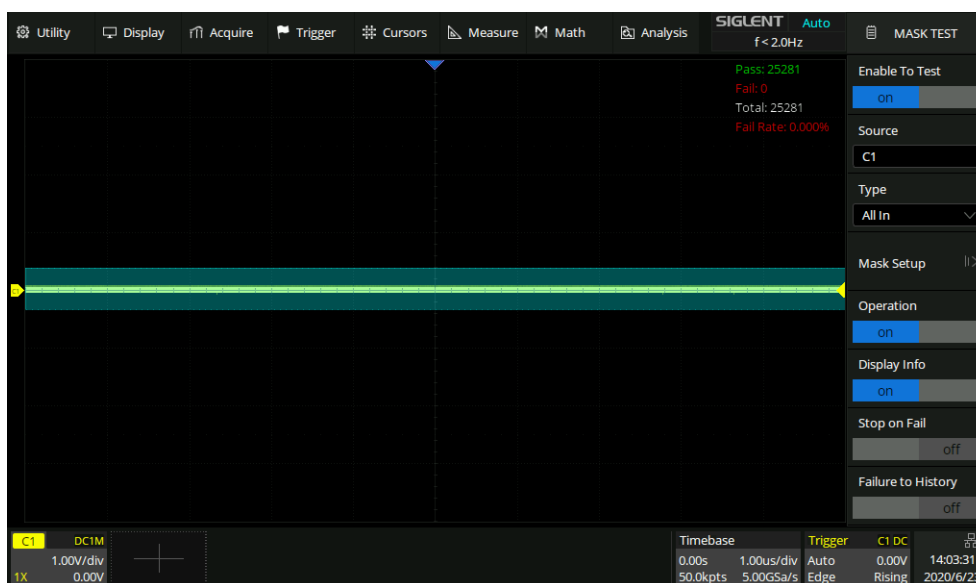

Figure 5 Mask Test Interface

All data points of the waveform must be inside the mask to pass the test. Even a single point outside the mask will cause a failure.

1. Connect the Pass/Fail output signal (on the rear panel) to the input terminal of another oscilloscope.

2. Move the waveform on the screen up, down, or sideways so that any portion of it falls outside of the Pass / Fail mask. If the interface is operating normally then a pulse will appear on the second oscilloscope. Adjust the second oscilloscope's time base and voltage scale as needed. If there is no viewable pulse on the second oscilloscope then there may be a problem with this function.

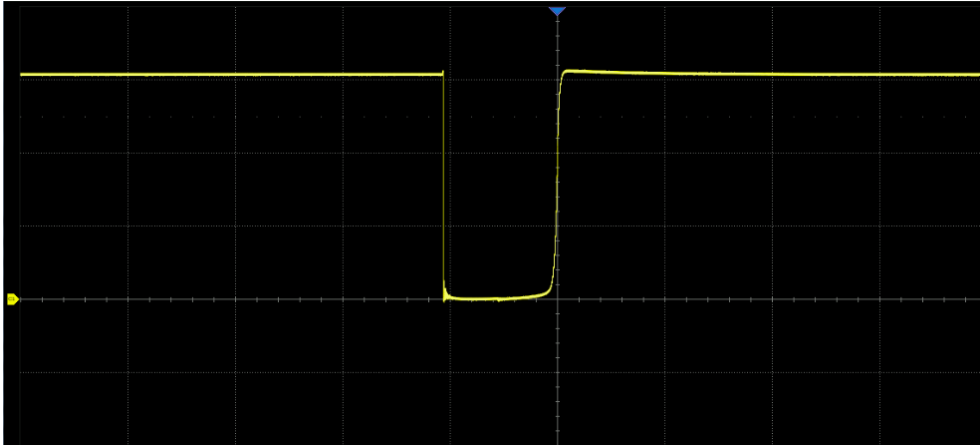

Figure 6 Pulse Waveform

5 Performance Test

This chapter explains testing the oscilloscope to verify performance specifications. For accurate test results, please let the test instruments and the oscilloscope warm-up for at least 30 minutes before testing.

Below is the required equipment for the test:

Table 2 Required test equipment

Equipment	Description	Qty	Test item
Fluke 9500B	3.2 GHz High-Performance Oscilloscope Calibrator	1	DCG accuracy \ Offset accuracy \ DC measurement accuracy \ Timebase accuracy \ Trigger level \
Fluke 9530	Active Head	≥ 2	Trigger sensitivity \ BW \ BWL \ Channel skew \ Input impedance\...

The figures below show the test setups:

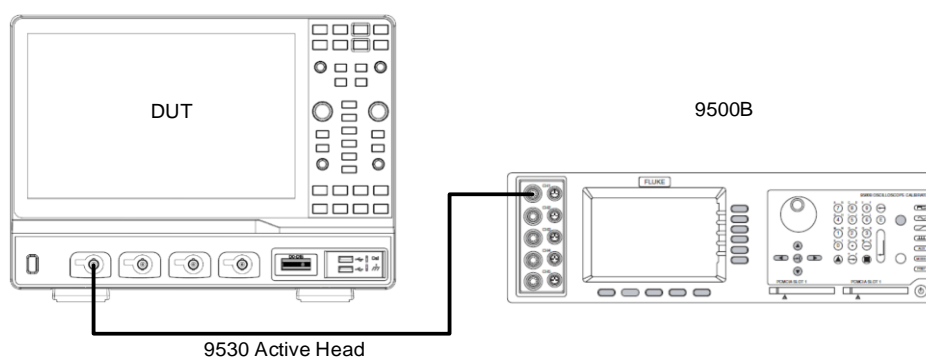

Figure 7 Test setup for DCG / Offset / Timebase...

Note: The 9530 active head in Figure 7 is connected to any channel of the 9500B, and its BNC connector is connected to the specified channel of the oscilloscope according to the test.

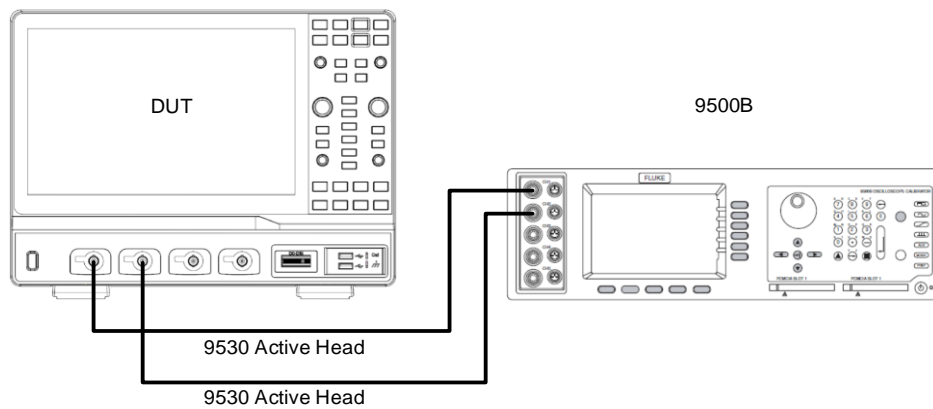

Figure 8 Test setup for Channel skew

Note: The 9530 active heads in Figure 8 are connected to any two channels of the 9500B, and their BNC connectors are connected to specified channels of the oscilloscope according to the test.

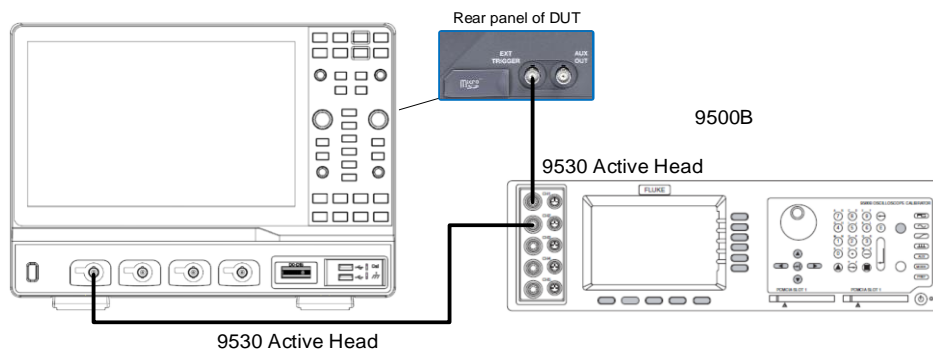

Figure 9 Test setup for Ext trigger level

Note: The 9530 active heads in Figure 9 are connected to any two channels of the 9500B. The BNC connector of one active head is connected to CH1 of the oscilloscope, and the one of another active head is connected to the external trigger of the oscilloscope.

Verify Test Results

To verify whether or not a test passes (i.e. whether the readings are within the appropriate limits), it is necessary to record the readings in the Performance Test located in the Test Record.

Self-Calibration

The Self Calibration procedure is described in the section **Self-Calibration**. If the environmental temperature changes by more than 5 °C, the Self Calibration operation must be performed to achieve the specified performance.

5.1 To Verify DC Gain Accuracy

To calculate the DC gain error of a vertical scale, at least nine input and reading values are required to generate a two-dimensional array.

Use the least square method below to fit the DC Gain error:

$$\text{Gain error} = \text{LINEST}(V_{\text{error}1}:V_{\text{error}9}, V_{\text{setting}1}:V_{\text{setting}9})$$

Where:

- “LINEST” is a function in Microsoft EXCEL® that uses the “least squares” method to calculate a line that best fits your dataset. It creates a two-dimensional array by using the least square method and then returns an array describing the line. The first value of the returned array represents the slope of the fitting line.
- “ V_{setting} ” represents the DC voltage output of the 9500B.
- “ V_{measure} ” represents the measurement value on the oscilloscope.
- “ V_{error} ” represents the difference between the voltage setting and the measurement value.

Table 3 Instance of Gain Error Calculation

	$V_{\text{setting}}(\text{mV})$	$V_{\text{measure}}(\text{mV})$	$V_{\text{error}}(\text{mV})$	Gain error
Point 1	-3	-3.08	-0.08	0.36%
Point 2	-2.25	-2.34	-0.09	
Point 3	-1.5	-1.59	-0.09	
Point 4	-0.9	-0.97	-0.07	
Point 5	0	-0.00	0	
Point 6	0.89	0.821	-0.069	
Point 7	1.5	1.43	-0.07	
Point 8	2.25	2.186	-0.064	
Point 9	3	2.93	-0.07	

Steps:

1. Set the 9500B output to On.
2. Connect a selected channel of the oscilloscope to the 9500B with an active head as shown in Figure 7.

3. Set the timebase of the oscilloscope to 5 ms/div, the “ Max Mem Depth ” in the menu of **Acquire** to 250k, and the impedance of the selected channel to 1 MΩ.
4. Set the vertical scale of the selected channel to 10 V/div, the position to 0 V. Select the **Measure** menu of the oscilloscope to display the “ Mean ” measurement of the selected channel.
5. Set DC voltage output level of the 9500B according to Table 4, and record the “ Mean ” value of the channel as V_{mean} .
6. Calculate V_{error} ($V_{\text{error}} = V_{\text{mean}} - V_{\text{setting}}$), and set the next output level as step 5.
7. Calculate gain error with these 9 data points: $V_{\text{setting}1} \sim V_{\text{setting}9}$, $V_{\text{error}1} \sim V_{\text{error}9}$ by using the ‘ LINEST ’ function. Check if the slope falls within the range shown in Table 4.
8. Set the next vertical scale of the selected channel to the other settings in Table 4, and repeat step 4 to step 7.
9. After measuring all vertical scales of the selected channel in turn, turn the 9500B output to Off.
10. Connect another channel of the oscilloscope to the 9500B with the active head. Check the other channels in the same way as step 4 to step 9.
11. Set the impedance of the selected channel to 50Ω and repeat step 4 to step 10 to measure all channels of the oscilloscope in turn according to Table 4 which the vertical scale less than or equal to 1 V/div.

Table 4 DC Gain Accuracy Setting

Vertical Scale	Applicable Impedance	DC voltage output levels	DC Gain Error Limit
10 V/div	1MΩ	-37.5 V, -28.125 V, -18.75 V, -9.375 V, 0 V, 9.375 V, 18.75 V, 28.125 V, 37.5 V	± 1.5%
6 V/div	1MΩ	-22.5 V, -16.875 V, -11.25 V, -5.625 V, 0 V, 5.625 V, 11.25 V, 16.875 V, 22.5 V	± 1.5%
4.5 V/div	1MΩ	-16.875 V, -12.65625 V, -8.4375 V, -4.21875 V, 0 V, 4.21875 V, 8.4375 V, 12.65625 V, 16.875 V	± 1.5%
3 V/div	1MΩ	-11.25 V, -8.4375 V, -5.625 V, -2.8125 V, 0 V, 2.8125 V, 5.625 V, 8.4375 V, 11.25 V	± 1.5%
2.1 V/div	1MΩ	-7.875 V, -5.90625 V, -3.9375 V, -1.96875 V, 0 V, 1.96875 V, 3.9375 V, 5.90625 V, 7.875 V	± 1.5%
1.9 V/div	1MΩ	-7.125 V, -5.34375 V, -3.5625 V, -1.78125 V, 0 V, 1.78125 V, 3.5625 V, 5.34375 V, 7.125 V	± 1.5%
1.2 V/div	1MΩ	-4.5 V, -3.375 V, -2.25 V, -1.125 V, 0 V, 1.125 V, 2.25 V, 3.375 V, 4.5 V	± 1.5%

Vertical Scale	Applicable Impedance	DC voltage output levels	DC Gain Error Limit
1.05 V/div	1MΩ	-3.9375 V, -2.953125 V, -1.96875 V, -0.984375 V, 0 V, 0.984375 V, 1.96875 V, 2.953125 V, 3.9375 V	± 1.5%
1 V/div	1MΩ 50Ω	-3.75 V, -2.8125 V, -1.875 V, -0.9375 V, 0 V, 0.9375 V, 1.875 V, 2.8125 V, 3.75 V	± 1.5%
600 mV/div	1MΩ, 50Ω	-2.25 V, -1.6875 V, -1.125 V, -0.5625 V, 0 V, 0.5625 V, 1.125 V, 1.6875 V, 2.25 V	± 1.5%
450 mV/div	1MΩ, 50Ω	-1.6875 V, -1.265625 V, -0.84375 V, -0.421875 V, 0 V, 0.421875 V, 0.84375 V, 1.265625 V, 1.6875 V	± 1.5%
300 mV/div	1MΩ, 50Ω	-1125mV, -843.75 mV, -562.5 mV, -281.25 mV, 0 mV, 281.25 mV, 562.5 mV, 843.75 mV, 1125 mV	± 1.5%
210 mV/div	1MΩ, 50Ω	-787.5 mV, -590.625 mV, -393.75 mV, -196.875 mV, 0 mV, 196.875 mV, 393.75 mV, 590.625 mV, 787.5 mV	± 1.5%
190 mV/div	1MΩ, 50Ω	-712.5 mV, -534.375 mV, -356.25 mV, -178.125 mV, 0 mV, 178.125 mV, 356.25 mV, 534.375 mV, 712.5 mV	± 1.5%
120 mV/div	1MΩ, 50Ω	-450 mV, -337.5 mV, -225 mV, -112.5 mV, 0 mV, 112.5 mV, 225 mV, 337.5 mV, 450 mV	± 1.5%
105 mV/div	1MΩ, 50Ω	-393.75 mV, -295.3125 mV, -196.875 mV, -98.4375 mV, 0 mV, 98.4375 mV, 196.875 mV, 295.3125 mV, 393.75 mV	± 1.5%
100 mV/div	1MΩ, 50Ω	-375 mV, -281.25 mV, -187.5 mV, -93.75 mV, 0 mV, 93.75 mV, 187.5 mV, 281.25 mV, 375 mV	± 1.5%
60 mV/div	1MΩ, 50Ω	-225 mV, -168.75 mV, -112.5 mV, -56.25 mV, 0 mV, 56.25 mV, 112.5 mV, 168.75 mV, 225 mV	± 1.5%
45 mV/div	1MΩ 50Ω	-168.75 mV, -126.5625 mV, -84.375 mV, 42.1875 mV, 0 mV, 42.1875 mV, 84.375 mV, 126.5625 mV, 168.75 mV	± 1.5%
30 mV/div	1MΩ, 50Ω	-112.5 mV, -84.375 mV, -56.25 mV, -28.125 mV, 0 mV, 28.125 mV, 56.25 mV, 84.375 mV, 112.5 mV	± 1.5%
21 mV/div	1MΩ, 50Ω	-78.75 mV, -59.0625 mV, -39.375 mV, -19.6875 mV, 0 mV, 19.6875 mV, 39.375 mV, 59.0625 mV, 78.75 mV	± 1.5%

Vertical Scale	Applicable Impedance	DC voltage output levels	DC Gain Error Limit
19 mV/div	1MΩ, 50Ω	71.25 mV, 53.4375 mV, 35.625 mV, 17.8125 mV, 0 mV, 17.8125 mV, 35.625 mV, 53.4375 mV, 71.25 mV	± 1.5%
12 mV/div	1MΩ, 50Ω	-45 mV, -33.75 mV, 22.5 mV, -11.25 mV, 0 mV, 11.25 mV, 22.5 mV, 33.75 mV, 45 mV	± 1.5%
10.5 mV/div	1MΩ, 50Ω	-39.375 mV, -29.53125 mV, -19.6875 mV, -9.84375 mV, 0 mV, 9.84375 mV, 19.6875 mV, 29.53125 mV, 39.375 mV	± 1.5%
9.5 mV/div	1MΩ, 50Ω	-35.625 mV, -26.71875 mV, -17.8125 mV, -8.90625 mV, 0 mV, 8.90625 mV, 17.8125 mV, 26.71875 mV, 35.625 mV	± 1.5%
7.5 mV/div	1MΩ, 50Ω	-28.125 mV, -21.09375 mV, -14.0625 mV, -7.03125 mV, 0 mV, 7.03125 mV, 14.0625 mV, 21.09375 mV, 28.125 mV	± 1.5%
6 mV/div	1MΩ, 50Ω	-22.5 mV, -16.875 mV, -11.25 mV, -5.625 mV, 0 mV, 5.625 mV, 11.25 mV, 16.875 mV, 22.5 mV	± 1.5%
5.5 mV/div	1MΩ, 50Ω	-20.625 mV, -15.46875 mV, -10.3125 mV, -5.15625 mV, 0 mV, 5.15625 mV, 10.3125 mV, 15.46875 mV, 20.625 mV	± 1.5%
4.5 mV/div	1MΩ, 50Ω	-13.5 mV, -10.125 mV, -6.75 mV, -3.375 mV, 0 mV, 3.375 mV, 6.75 mV, 10.125 mV, 13.5 mV	± 1.5%
2.5 mV/div	1MΩ, 50Ω	-7.5 mV, -5.625 mV, -3.75 mV, -1.875 mV, 0 mV, 1.875 mV, 3.75 mV, 5.625 mV, 7.5 mV	± 1.5%
1.3 mV/div	1MΩ, 50Ω	-3.9 mV, -2.925 mV, -1.95 mV, -0.975 mV, 0 mV, 0.975 mV, 1.95 mV, 2.925 mV, 3.9 mV	± 1.5%
1 mV/div	1MΩ, 50Ω	-3 mV, -2.25 mV, -1.5 mV, -0.888 mV, 0 mV, 0.888 mV, 1.5 mV, 2.25 mV, 3 mV	± 1.5%

“ V_{setting} ” in Table 4 is calculated in the following ways:

When the vertical scale is 1 mV/div, V_{setting} is calculated to follow [-3, -2.25, -1.5, -0.888, 0, 0.888, 1.5, 2.25, 3] * 1 mV.

When the vertical scale is within 1 mV to 5 mV, V_{setting} is calculated to follow

$[-3, -2.25, -1.5, -0.75, 0, 0.75, 1.5, 2.25, 3] * \text{vertical scale}$.

When the vertical scale is more than 5 mV, V_{setting} is calculated to follow $[-3.75, -2.8125, -1.875, -0.9375, 0, 0.9375, 1.875, 2.8125, 3.75] * \text{vertical scale}$.

An Instance of V_{setting} Calculation of 10 V/div:

$V_{\text{setting 1}} = -3.75 * 10$	-37.5 V	$V_{\text{setting 2}} = -2.8125 * 10$	-28.125 V
$V_{\text{setting 3}} = -1.875 * 10$	-18.75 V	$V_{\text{setting 4}} = -0.9375 * 10$	-9.375 V
$V_{\text{setting 5}} = 0 * 10$	0	$V_{\text{setting 6}} = 0.9375 * 10$	9.375 V
$V_{\text{setting 7}} = 1.875 * 10$	18.75 V	$V_{\text{setting 8}} = 2.8125 * 10$	28.125 V
$V_{\text{setting 9}} = 3.75 * 10$	37.5 V		

5.2 To Verify Offset Accuracy

Two components must be verified for offset accuracy. The first part is the offset gain error relative to the setting of an offset value (Gain component). The second part is the error only relative to the setting of the vertical scale (Full-scale component).

Table 5 Components of Offset Accuracy

	Gain Component	Full-scale Component
Offset accuracy	1%*offset	0.5%*full-scale + 0.02%*max offset +1 mV

Note: Refer to datasheet for the max offset spec at every vertical scale.

Take the setting below as an example:

The offset is 0 V, and the vertical scale is 100 mV/div.

Use the method below to calculate the offset accuracy:

$$\text{Offset accuracy} = 1\% \cdot 0 \text{ V} + 0.5\% \cdot 100\text{mV} \cdot 8 + 0.02\% \cdot 16\text{V} + 1 \text{ mV} = 8.2 \text{ mV}$$

To calculate the offset gain error of a vertical scale (i.e. Gain component), at least five input and reading values are required to generate a two-dimensional array.

Use the least square method below to fit the Offset Gain error:

$$\text{Offset Gain error} = \text{LINEST}(\text{Offset}_{\text{error}1}:\text{Offset}_{\text{error}5}, \text{Offset}_{\text{setting}1}:\text{Offset}_{\text{setting}5})$$

Where:

- “LINEST” is a function in Microsoft EXCEL© that uses the “least squares” method to calculate a line that best fits your dataset. It creates a two-dimensional array by using the least square method and then returns an array describing the line. The first value of the returned array represents the slope of the fitting line.
- “ V_{setting} ” represents DC voltage output of the 9500B.
- “ $\text{Offset}_{\text{setting}}$ ” represents the offset value setting on the oscilloscope.
- “ V_{mean} ” represents the measurement value on the oscilloscope.
- “ $\text{Offset}_{\text{error}}$ ” represents the difference between V_{mean} and V_{setting} .

Table 6 Instance of Offset Gain Error Calculation

	V_{setting} (V)	$\text{Offset}_{\text{setting}}$ (V)	V_{mean} (V)	$\text{Offset}_{\text{error}}$ (V)	Offset Gain Error
Point 1	10	-10	10.1	0.1	-1%
Point 2	5	-5	5.05	0.05	
Point 3	0	0	0	0	
Point 4	-5	5	-5.05	-0.05	
Point 5	-10	10	-10.1	-0.1	

Steps:

1. Set the 9500B output to On.
2. Connect a selected channel of the oscilloscope to the 9500B with an active head as shown in Figure 7.
3. Set the timebase of the oscilloscope to 5 ms/div, the “ Max Mem Depth ” in the menu of **Acquire** to 250k, and the impedance of the selected channel to 1 MΩ.
4. Set the vertical scale of the channel to 10 V/div. Select the **Measure** menu of the oscilloscope to display the “ Mean ” measurement of the selected channel.
5. According to Table 7, set offset of the channel to $\text{Offset}_{\text{setting}}$, and set the 9500B output level to $V_{\text{setting}} = -\text{Offset}_{\text{setting}}$, then record the “ Mean ” value of the oscilloscope as V_{mean} .
6. Calculate $\text{Offset}_{\text{error}}$ ($\text{Offset}_{\text{error}} = V_{\text{mean}} - V_{\text{setting}}$), and set the next $\text{Offset}_{\text{setting}}$ as step 5.
7. Calculate offset slope with these 5 data points: $V_{\text{setting}1} \sim V_{\text{setting}5}$, $\text{Offset}_{\text{error}1} \sim \text{Offset}_{\text{error}5}$ by using the ‘ LINEST ’ function. Check if the slope falls within the range of slope error shown in Table 7 .
8. Set offset of the channel to 0 V, and turn the 9500B output to Off, then record the “ Mean ” value of the oscilloscope as V_{zero} . Check if the V_{zero} falls within the range of Full-Scale Component. Turn the 9500B output to On for the next measurement.
9. Set the vertical scale of the channel to the other settings in Table 7, and repeat step 5 to step 7.
10. Turn the 9500B output to Off.
11. Connect another channel of the oscilloscope to the 9500B with the active head. Check the other channels in the same way as step 4 to step 10.

Table 7 Offset Accuracy

Vertical Scale	Offset _{setting}	Gain Component Error Limit	Full-scale Component Error Limit
10 V/div	-222.4 V, 111.2 V, 0 V, 111.2 V, 222.4 V	± 0.5%	± 0.481
2 V/div	-222.4 V, 111.2 V, 0 V, 111.2 V, 222.4 V	± 0.5%	± 0.161
1.02 V/div	-222.4 V, 111.2 V, 0 V, 111.2 V, 222.4 V	± 0.5%	± 0.1218
200 mV/div	-80 V, -40 V, 0 V, 40 V, 80 V	± 0.5%	± 0.025
102 mV/div	-80 V, -40 V, 0 V, 40 V, 80 V	± 0.5%	± 0.02108
100 mV/div	-16 V, -8 V, 0 V, 8 V, 16 V	± 0.5%	± 0.0082
50 mV/div	-16 V, -8 V, 0 V, 8 V, 16 V	± 0.5%	± 0.0062
20 mV/div	-8 V, -4 V, 0 V, 4 V, 8 V	± 0.5%	± 0.0034
10 mV/div	-4 V, -2 V, 0 V, 2 V, 4 V	± 0.5%	± 0.0022
5 mV/div	-1.6 V, -0.8 V, 0 V, 0.8 V, 1.6 V	± 0.5%	± 0.00152
2 mV/div	-1.6 V, -0.8 V, 0 V, 0.8 V, 1.6 V	± 0.5%	± 0.0014

5.3 To Verify DC Measurement Accuracy

Some products do not list the DC measurement accuracy in the datasheet, but it can be calculated by combining the DC gain Accuracy and Offset Accuracy. Verifying this specification is not necessary if the DC gain accuracy and Offset accuracy had been verified.

Table 8 DC Measurement Accuracy

DC Measurement Accuracy	$\pm(\text{DC gain accuracy} \times V_{\text{setting}} + \text{Offset}_{\text{setting}} + \text{Offset accuracy})$
-------------------------	--

Use the method below to calculate the High/Low limiting for the DC measurement results:

$$\text{Upper limit} = V_{\text{setting}} + (\text{DC gain accuracy} \times |V_{\text{setting}} + \text{Offset}_{\text{setting}}| + \text{Offset accuracy})$$

$$\text{Lower limit} = V_{\text{setting}} - (\text{DC gain accuracy} \times |V_{\text{setting}} + \text{Offset}_{\text{setting}}| + \text{Offset accuracy})$$

Where:

- “ V_{setting} ” represents DC voltage output by the 9500B.
- “ $\text{Offset}_{\text{setting}}$ ” represents the offset value setting on an oscilloscope.

Table 9 Instance of DC Measurement Limiting Calculation

1V/div	V _{setting} (V)	Offset _{setting} (V)	V _{mean} (V)	Lower limit (V)	Upper limit (V)
Setting 1	3	0		2.898	3.102
Setting 2	-3	0		-3.102	-2.898

$$\text{Upper limit} = 3V + (|3V + 0| \times 1.5\% + 0V \times 1.5\% + 1V/\text{div} \times 8\text{div} \times 0.5\% + 80V \times 0.02\% + 1\text{mV}) = 3.102 \text{ V}$$

$$\text{Lower limit} = 3V - (|3V + 0| \times 1.5\% + 0V \times 1.5\% + 1V/\text{div} \times 8\text{div} \times 0.5\% + 80V \times 0.02\% + 1\text{mV}) = 2.898 \text{ V}$$

The instance above give the DC measurement limiting with two different input and offset settings. Here the limiting calculation with no Zero offset is not listed, because the calculation process is complicated. It is not recommended to verify the device with no zero offset setting (offset $\neq 0$).

Steps:

The equipment and device configuration sequence is the same as the Offset Accuracy verification setting.

5.4 To Verify Bandwidth

This test checks the bandwidth of all the analog channels. In the test, the impedance of 9500B should be set to be the same as analog channels.

Table 10 Vertical Scales should be verified

Impedance	Vertical Scale
50Ω	6.8 mV/div, 11.2 mV/div, 16.6 mV/div, 23 mV/div, 32 mV/div, 48mV/div, 88mV/div, 100mV/div, 112mV/div, 166mV/div, 230mV/div, 300mV/div, 480mV/div, 890mV/div,1V/div

Steps:

1. Connect the selected channel of the oscilloscope to the 9500B via the active head, as shown in Figure 7.
2. Set the vertical scale of the selected channel to 6.8 mV/div, impedance to 50 Ω, “ Max Mem Depth ” to 250k.
3. Press the button on the front panel of the oscilloscope to display “ Stdev ” measurement of the selected channel.
4. Set the 9500B: impedance to 50 Ω, amplitude to 40.8 mV, waveform to sine.
5. Set frequency of the 9500B to the frequency in Table 11

Table 11 Frequency points in the test

Model	Impedance	Frequency Point (Hz)
SDS6204A	50 Ω	0.05M,21M,51M, 101M, 151M, 201M, 251M, 301M, 351M, 401M, 451M,501M, 551M, 601M, 651M, 701M, 751M, 801M, 851M, 901M, 951M, 1001M, 1051M, 1101M, 1151M, 1201M, 1251M, 1301M, 1351M, 1401M, 1451M, 1501M, 1551M, 1601M, 1651M, 1701M, 1751M, 1801M, 1851M, 1901 M, 1951M,2001M, 2021M, 2111M, 2211M, 2311M, 2411M, 2511M, 2611M, 2711M, 2811M, 2911M, 3011M
SDS6104A	50 Ω	0.05M,21M,51M, 101M, 151M, 201M, 251M, 301M, 351M, 401M, 451M,501M, 551M, 601M, 651M, 701M, 751M, 801M, 851M, 901M, 951M, 1001M, 1051M, 1101M, 1151M, 1201M, 1251M, 1301M, 1351M, 1401M, 1451M, 1501M, 1551M, 1601M, 1651M, 1701M, 1751M, 1801M, 1851M, 1901 M, 1951M,2001M
SDS6054A	50 Ω	0.05M,21M,51M, 76M, 101M, 126M, 151M, 176M, 201M, 226M, 251M, 276M, 301M, 351M, 401M, 451M,501M, 551M, 601M, 651M, 701M, 751M, 801M

6. It is recommended to adjust the timebase to 2 us/div at the first frequency point, and adjust the timebase to 200 ns/div at the remaining frequency points to display a complete non-aliased waveform.
7. Record the “ Stdev ” measurement of the waveform as V_{stdev} and the first frequency point as reference value as V_{ref} .
8. Set the vertical scale of the oscilloscope channel under test to the next setting according to Table 10, and repeat step 3 to step 7. The amplitude of the 9500B output is always 6*vertical scale.
9. Check the other channels in the same way as step 1 to step 8.
10. Disconnect the test connection.

After the test, calculate the dB value (regarding the amplitude at 50 kHz as 0 dB) at every frequency point. Check if the value is in the limited range in Table 12 Use the formula below to calculate the dB value:

$$\text{dB value} = 20 * \log_{10} \frac{V_{stdev}}{V_{ref}}$$

Table 12 Limited Range

Model	Impedance	Frequency Point (Hz)	Range
SDS6204A	50 Ω	≤ 201M	(-0.5, 0.5) dB
		≤ 668M	(-0.8, 0.8) dB
		≤ 1001M	(-1.2, 1.0) dB
		≤ 2001M	(-3.0, 1.0) dB
		≤ 2111M	(-5.5, 3.0) dB
		≤ 3200M	(-44, 3.0) dB
SDS6104A	50 Ω	≤ 101M	(-0.5, 0.5) dB
		≤ 334M	(-1.0, 1.0) dB
		≤ 568M	(-2.5, 1.0) dB
		≤ 1001M	(-3.0, 3.0) dB
		≤ 2001M	(-65, 3.0) dB
SDS6054A	50 Ω	≤ 51M	(-0.5, 0.5) dB
		≤ 168M	(-0.8, 0.8) dB
		≤ 334M	(-1.2, 1.0) dB
		≤ 501M	(-3.0, -1.0) dB
		≤ 801M	(-65, -2.0) dB

5.5 To Verify Time Base Accuracy

This test verifies the time base accuracy of the oscilloscope.

Time Base Accuracy: |Frequency Error| < 20 Hz

Note: 20 Hz is the initial accuracy limit of measuring the 10 MHz input. If the oscilloscope has been used for a long time (e.g. ≥ 1 year), the error caused by aging should be added to this limit. Refer to the datasheet for the aging spec.

Steps:

1. Connect the selected channel of the oscilloscope to the 9500B, as shown in Figure 7.
2. Set the oscilloscope vertical scale to 100 mV/div.
3. Set the timebase of the oscilloscope to 5 us/div.
4. Set the Memory Depth to 250 kpts.
5. Set waveform of the 9500B to sine, amplitude to 600 mV, and frequency to 10 MHz.
6. Check if the trigger (hardware-measured) frequency which is on the top right of the screen is in the range of 9.999980 MHz to 10.00002 MHz.



Figure 10

7. Disconnect the test connection.

5.6 To Verify Trigger Level

This test checks the trigger level accuracy of the analog channels. In this test, the impedance of both the 9500B and the oscilloscope should be set to 50 Ω .

Trigger Level Accuracy: |Error| \leq 20 mV

Steps:

1. Connect the selected channel of the oscilloscope to the 9500B as shown in Figure 7.
2. Set the impedance of the 9500B to 50 Ω , frequency to 2 kHz, amplitude to 800 mV, and waveform to sine.
3. Set the timebase of the oscilloscope to 50 us/div.
4. Set the impedance of the selected channel, vertical scale to 100 mV/div, trigger source to the selected channel, trigger slope to positive, and coupling mode to DC.
5. Set the trigger level to 300 mV.
6. Selected the **Measure** menu of the oscilloscope to display “Level@x” measurement.
7. Record the value of “Level@x”, calculate the level error (error = 300 mV - Level@x).
8. Check if the trigger level error is in the limited range above.
9. Set the trigger level to 0 mV and -300 mV, repeat step 6 to step 8 in turn.
10. Set trigger slope to negative, repeat steps step 5 to step 9.
11. Disconnect the test connection.
12. Check the other analog channels in the same way as steps 1 to 11.

5.7 To Verify Ext Trigger Level

This test checks the trigger level accuracy of the external trigger channel. In this test, the impedance of both the 9500B and the oscilloscope should be set to 1 MΩ.

Table 13 EXT Trigger Level Error Limit

Trigger Channel	Vertical Scale	Trigger Level Error Limited Range
EXT	150 mV	Abs (Error) < 45 mV
EXT/5	435 mV	Abs (Error) < 103.5 mV

Steps:

1. Connect channel 1 and the external trigger channel of the oscilloscope to the 9500B with two active heads, as shown in Figure 9.
2. Set the oscilloscope timebase to 500 us/div.
3. Set channel 1 of the oscilloscope to 150 mV/div, set the impedance of channel 1 and external trigger to 1 MΩ, trigger source to EXT, trigger slope to positive, and coupling mode to DC.
4. Set the impedance of the 9500B to 1 MΩ, frequency to 1 kHz, amplitude to 8*vertical scale, and waveform to sine.
5. Set the trigger level to 450 mV.
6. Set the **Measure** menu of the oscilloscope to display “ Level@x ” measurement.
7. Record the value of “ Level@x ”, calculate the level error (error = 300 mV - Level@x).
8. Check if the trigger level error is in the limited range above.
9. Set the trigger level to 0 mV and -450 mV, and repeat step 5 to step 8 in turn.
10. Set trigger slope to negative, repeat step 5 to step 9.
11. Set the oscilloscope vertical scale to 345 mV/div, trigger source to EXT/5, trigger slope to positive, and coupling mode to DC.
12. Set the impedance of the 9500B to 1 MΩ, frequency to 1 kHz, amplitude to 8* vertical scale, and waveform to sine.
13. Set the trigger level to 1035 mV.
14. Record the value of Level@x, calculate the level error (error = 1035 mV - Level@x).
15. Check if the trigger level is in the limited range in Table 13.
16. Set the trigger level to 0mV and -1035 mV, and repeat step 13 to step 15 in turn.
17. Set trigger slope to negative, and repeat step 13 to step 16.
18. Disconnect the test connection.

5.8 To Verify Trigger Sensitivity

This test checks trigger sensitivity at the frequency of 10 MHz and also at the bandwidth frequency. In the test, the impedance of 9500B should be set to 50 Ω .

Table 14 Trigger sensitivity data

Vertical Scale	Frequency	Frequency measured
100 mV/div	10 MHz	≥ 9.9 MHz
100 mV/div	Bandwidth frequency	$\geq 99\% * \text{Bandwidth frequency}$

Steps:

1. Connect the selected channel of the oscilloscope to the 9500B, as shown in Figure 7.
2. Set the selected channel vertical scale of the oscilloscope to 100 mV/div, timebase to 50 ns/div, and coupling mode to AC, and impedance to 50 Ω .
3. Set the impedance of the 9500B to 50 Ω , frequency to 10 MHz, waveform to sine, and output to 50 mV which is measured by the oscilloscope.
4. Set trigger slope of the oscilloscope to Positive.
5. Press the Trigger Level knob to set the level to the center of the waveform.
6. Adjust the trigger level within the waveform range and observe the (hardware-measured) frequency which is on the top right of the screen (as shown in Figure 10), and check if a level can be found to satisfy the frequency measured in Table 14.
7. Set the oscilloscope trigger slope to Negative, repeat steps 5 to 6.
8. Set frequency of the 9500B to the bandwidth frequency of the oscilloscope, and adjust the output whose " amplitude " measured by the oscilloscope to 50 mV. Set the timebase of the oscilloscope to 2 ns/div, and then repeat steps 4 to 7.
9. Check the other channels in the same way as steps 1 to 8.
10. Disconnect the test connection.

The steps above are for testing the trigger sensitivity of the analog channels. The following steps are used to test the external trigger sensitivity.

Steps:

1. Connect the external trigger channel of the oscilloscope to the 9500B, as shown in Figure 7.

2. Set the impedance of the 9500B to 50 Ω , amplitude to 200 mV, frequency to 10 MHz, and waveform to sine.
3. Set the trigger source of the oscilloscope to EXT, trigger slope to Positive, and impedance of the external trigger channel to 50 Ω .
4. Press the Trigger Level knob to set the level to the center of the waveform.
5. Adjust the trigger level within the range of [-100 mV, 100 mV], observe the (hardware-measured) frequency which is on the top right of the screen (as shown in Figure 10), and check if a level can be found to satisfy the frequency measured in Table 14.
6. Set trigger slope to Negative, repeat steps 4 to 5.
7. Set frequency of the 9500B to the 300 MHz (bandwidth frequency of the external trigger) and amplitude to 300 mV. Repeat steps 3 to 6. In step 5, change the trigger level range to [-150 mV, 150 mV].
8. Set frequency of the 9500B to 10 MHz, amplitude to 1 V.
9. Set the trigger source of the oscilloscope to EXT/5, trigger slope to Positive.
10. Press the Trigger Level knob to set the level to the center of the waveform.
11. Adjust the trigger level within the range of [-500 mV, 500 mV], observe the (hardware-measured) frequency which is on the top right of the screen (as shown in Figure 10), and check if a level can be found to satisfy the frequency measured in Table 14.
12. Set the trigger slope to Negative, repeat steps 10 to 11.
13. Set the frequency of the 9500B to 300 MHz (bandwidth frequency of the external trigger), amplitude to 1.5 V. Repeat steps 9 to 12. In step 11, change the trigger level range to [-750 mV, 750 mV].
14. Disconnect the test connection.

5.9 To Verify Channel Skew

This test checks the skew between two analog channels. In this test, the impedance of both the 9500B and the oscilloscope should be set to 50 Ω .

Channel Skew Limit: $|T@L| \leq 100$ ps

Steps:

1. Connect two selected channels of the oscilloscope to the 9500B shown as in Figure 8.
2. Press the ' Aux ' key at the right of the ' OSCILLOSCOPE CALIBRATOR ' panel of the 9500B and select the Skew function.
3. Set the impedance of the 9500B to 50 Ω , frequency to 1 kHz, and amplitude to 0.6 V.
4. Set vertical scale of the selected channels to 100 mV/div, impedance to 50 Ω .
5. Set the oscilloscope timebase to 2 ns/div, trigger source is the selected channel.
6. Press the Measure button on the front panel of the oscilloscope to display the " Skew " measurement between two selected channels.
7. Check if the result is in the limited range above.
8. Disconnect the test connection.
9. Check other channels in the same way as steps 1 to 8.

5.10 To Verify Input Impedance

This test checks the input impedance of all analog channels and the Ext trigger channel with different coupling modes and vertical scales (100 mV/div, 200 mV/div, and 2 V/div).

Table 15 Input Impedance data

Channel	Coupling and impedance type	Impedance Range		Capacitance Range
CH	AC / 1 M Ω	0.1 V/div	1176000~1224000 Ω	17 ~ 23 pF
		0.2 V/div, 2 V/div	980000~1020000 Ω	
	DC / 1 M Ω	980000~1020000 Ω		
	DC(AC) / 50 Ω	49~51 Ω		
Ext	1 M Ω	980000~1020000 Ω		
	50 Ω	49~51 Ω		

Steps:

1. Connect the selected channel of the oscilloscope to the 9500B, as shown in Figure 7.
2. Set the vertical scale of the selected channel to 100 mV/div, impedance to 1 M Ω , and coupling mode to AC.
3. Press the ' Aux ' key at the right of the ' OSCILLOSCOPE CALIBRATOR ' panel of the 9500B and select the Load Resistance Measurement Function. Record the reading displays on the screen of the 9500B.
4. Set coupling mode of the channel to DC. Record the reading displays on the screen of the 9500B.
5. Check if the impedance is within the specified range in Table 15.
6. Test at 2 V/div and 200 mV/div, using the same procedure as steps 2 to 5.
7. Check the other analog channels in the same way as steps 1 to 6.
8. Press the ' Aux ' key at the right of the ' OSCILLOSCOPE CALIBRATOR ' panel of the 9500B and select the Capacitance Measurement Function. Record the reading of the 9500B.
9. Set the vertical scale of the selected channel to 100 mV/div, impedance to 1 M Ω , and coupling mode to AC.
10. Check if the capacitance is within the specified range in Table 15.
11. Test at 2 V/div and 200 mV/div, using the same procedure as steps 9 to 10.
12. Check the other analog channels in the same way as steps 8 to 11.
13. Disconnect the test connection

When checking the EXT trigger channel, it is the same as checking analog channels. Record the reading displays on the screen of the 9500B, and check to verify it is within the specified range in Table 15.

6 Disassembly Procedures

This chapter describes how to remove major parts from the SDS6000A series oscilloscope.

6.1 Safety Consideration and Cautions

Only qualified personnel should perform the disassembly procedures. Disconnect the power before you begin to remove or replace the parts. Otherwise, potential personal injuries or damages to the components may occur.

WARNING



HAZARDOUS VOLTAGES

Maintenance is performed with the power supply on and without protective covers. Only qualified personnel with proper tools and protection should perform maintenance. Perform maintenance with the power cord disconnected whenever possible.

WARNING



AVOID ELECTRICAL SHOCK

Hazardous voltages exist on the power supply and LCD modules. To avoid electrical shock, disconnect the power cord and wait at least three minutes for the capacitors to discharge before you begin disassembly.

CAUTION



ESD CAUTION

Electrostatic discharge (ESD) sensitive devices inside. Electronic components may be damaged without detection. Proper ESD precautions should be taken to avoid performance degeneration or loss of functionality. At a minimum, place the oscilloscope on a properly grounded ESD mat and wear a properly grounded ESD strap.

CAUTION



REMOVE POWER TO AVOID DAMAGE

Remove power before you start to disassemble or replace parts. **DO NOT** disassemble or replace parts with the power on. Damage to the components may occur.

6.2 Tools Lists

Use these tools to remove or replace the modules in the oscilloscope:

- Multifunction screwdriver
- Antistatic gloves
- Custom screw hexagonal nut tool or long nose pliers

6.3 Disassembly Procedures

This section describes how to remove the modules in the oscilloscope in detail. To install the removed parts or replace a new part, follow the instructions in reverse order.

6.3.1 To Remove the Handle and Foot

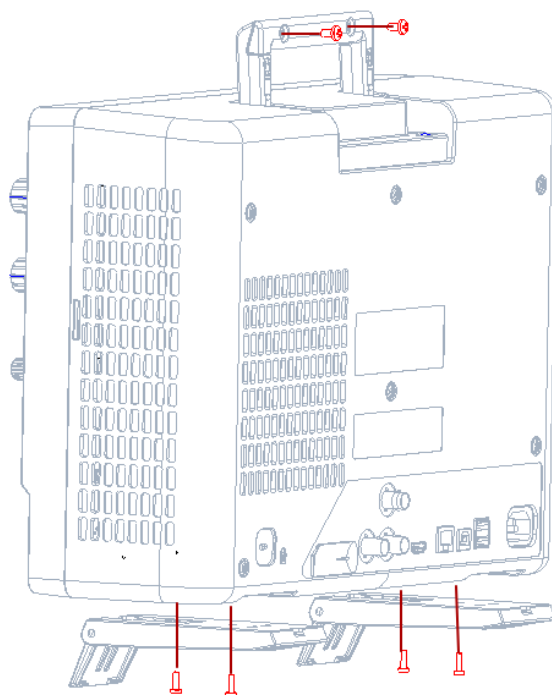

Figure 11 To remove the handle and foot

Steps:

1. Lift the handle and remove the two PM4*8 screws on the rear cover of the handle. Then push the two parts of the handle in opposite directions to remove the handle.
2. Remove the four PM3*8 screws from the bottom of each foot, then remove the two feet.

6.3.2 To Remove the Rear Cover

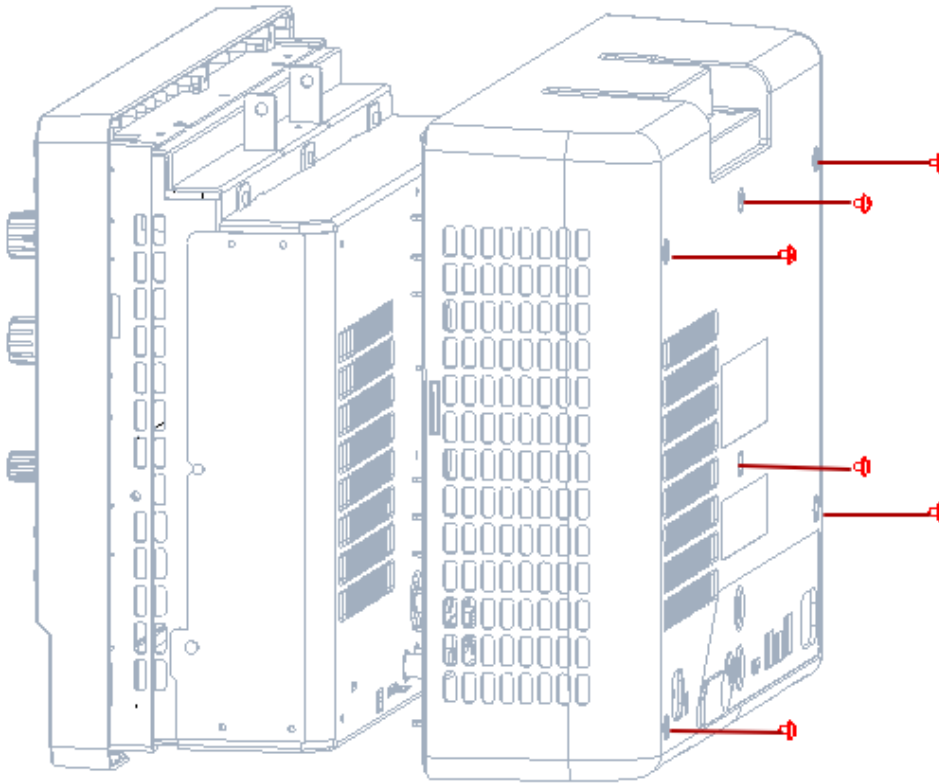

Figure 12 To remove the rear cover

Steps:

1. Remove the six screws (PWM3*6) on the rear cover.
2. Lift the rear cover up and off carefully.

6.3.3 To Remove the Rear Metal Cover

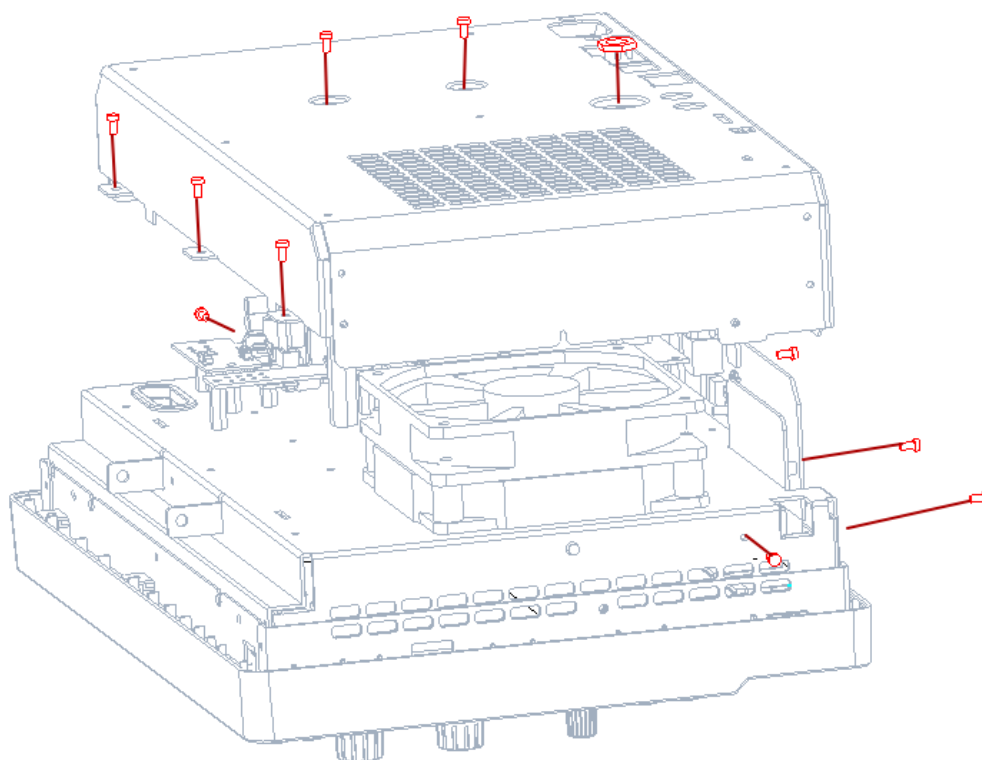

Figure 13 To remove the rear metal cover

Steps:

1. Remove the BNC nut on the rear metal cover.
2. Remove the ten screws (eight PM3*6 screws and two PWM screws) from the outside of the rear metal cover.
3. Remove the rear metal cover.

6.3.4 To Remove the Back-Chassis Module

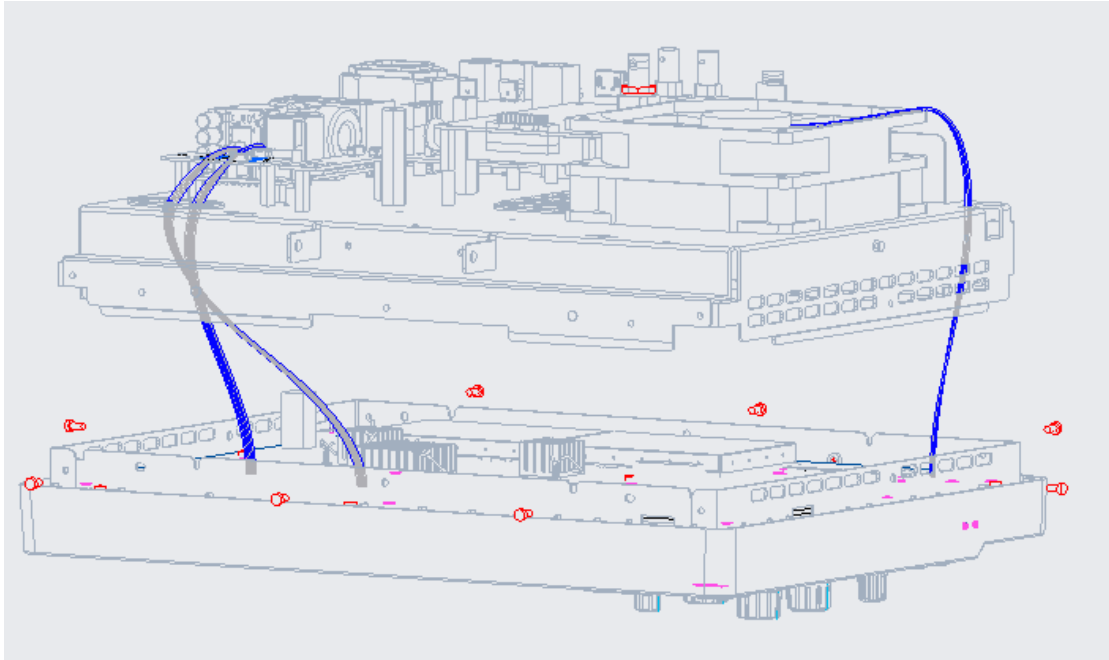

Figure 14 To remove the back panel chassis module.

Steps:

1. Remove the eight PM3*6 screws outside the back panel chassis.
2. Lift the back panel chassis module slowly and unplug the connecting cables from the mainboard.
3. Lift the back-chassis module away.

6.3.5 To Remove the Power Supply Module and Fan

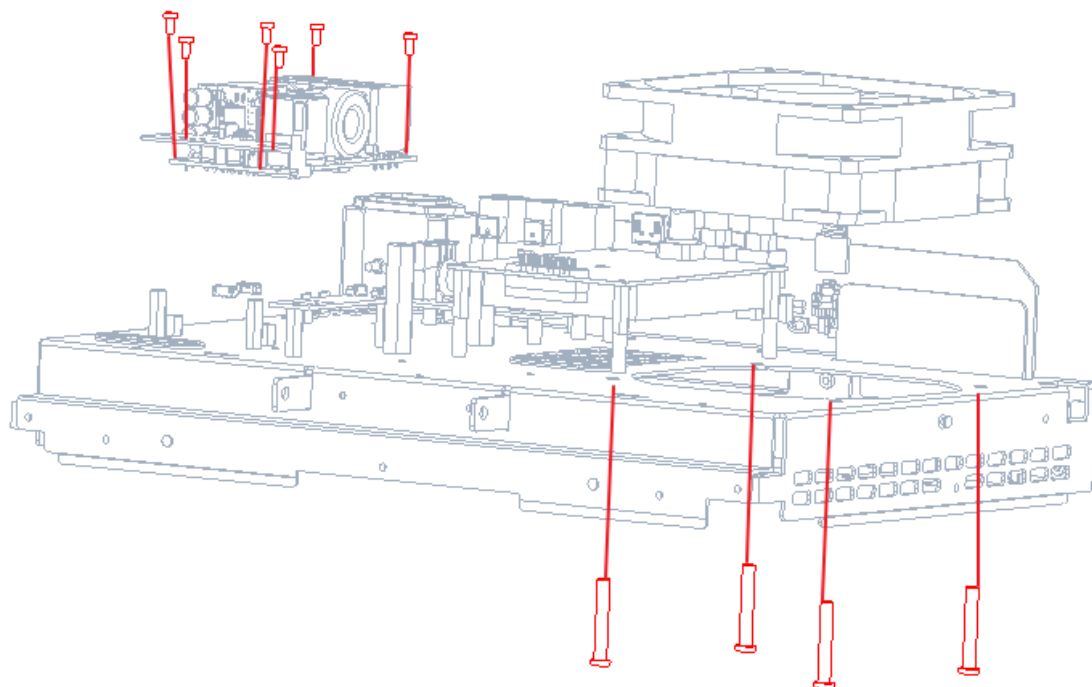

Figure 15 To remove the power supply module and fan.

Steps:

1. Remove the six PM3*6 screws on the power supply and remove the power supply.
2. Remove the four PB5*30 screws bottom of the fan and remove the fan.

6.3.6 To Remove Front Panel

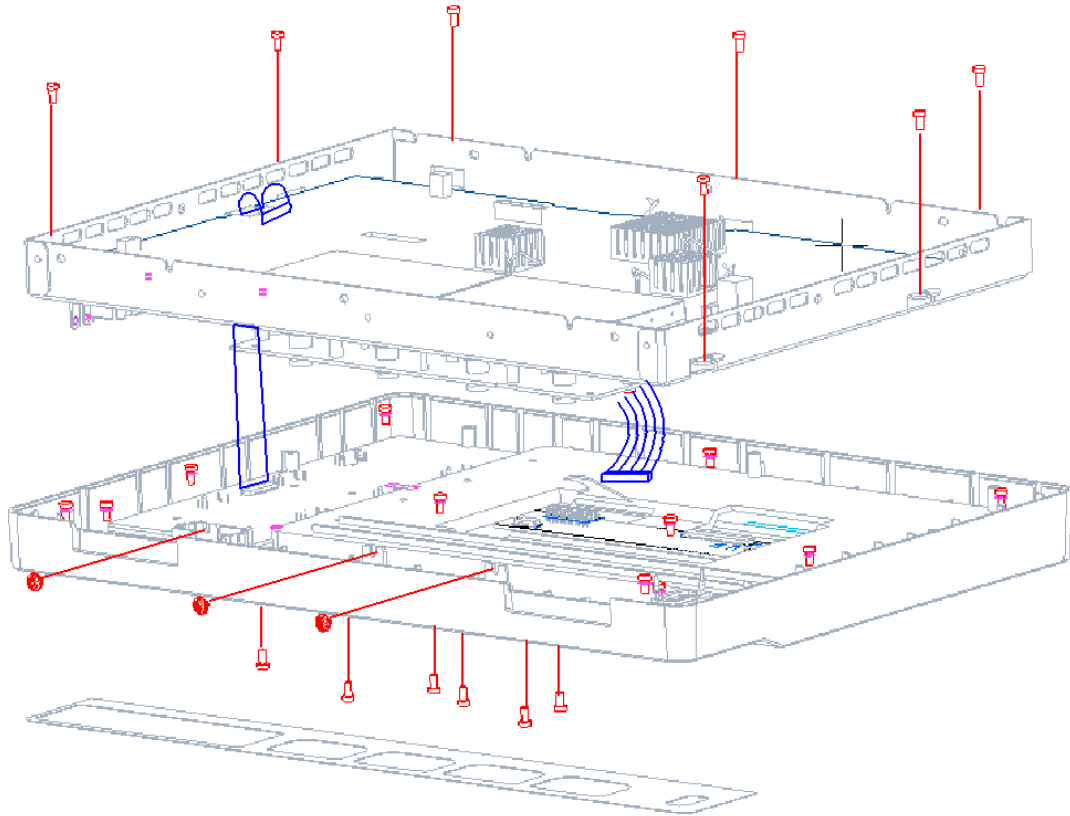
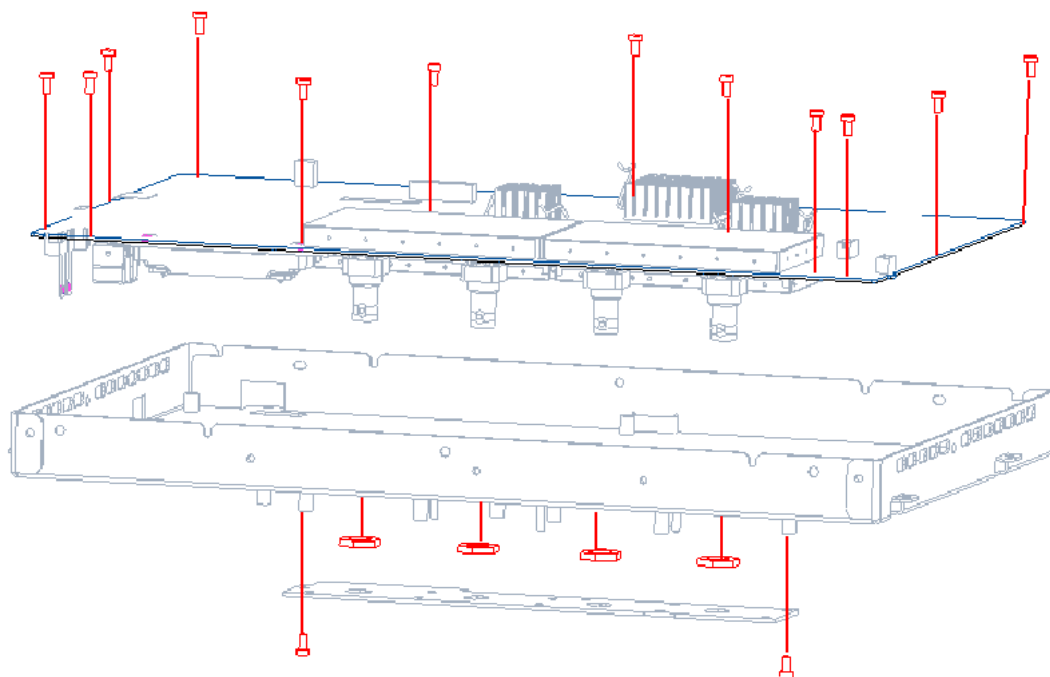

Figure 16 To remove the mainboard and front panel

Steps:

1. Remove the channel overlay sticker from the front panel and remove the six PM3*6 screws.
2. Unplug the side connecting cable from the front panel.
3. Remove the ten screws (seven PC3*6 and three PWM3*4.5) around the front chassis module.
4. Lift the front chassis module slowly and unplug the middle connecting cable from the front panel.
5. Remove the front panel.

6.3.7 To Remove the Probe Interface Board and the Mainboard



Steps:

1. Remove the two PM3*6 screws on the probe interface board, unplug the connecting cable and remove the probe interface board.
2. Remove the four nuts from the front BNC connectors.
3. Remove the twelve PM3*6 screws on the mainboard and remove the mainboard.

6.3.8 To Remove the Rubber Keypad and Keyboard

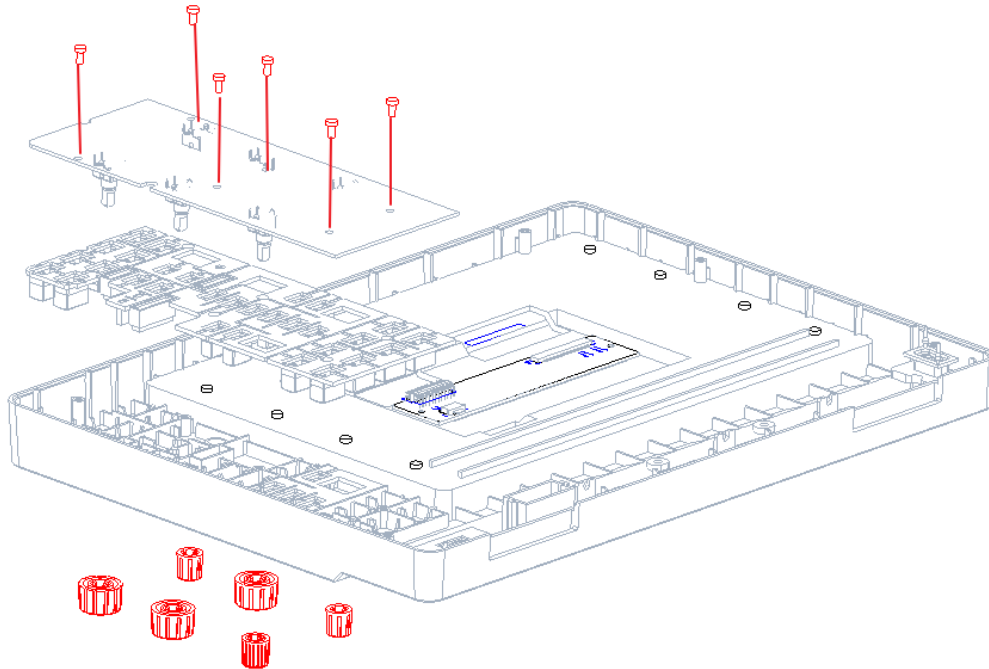

Figure 17 To remove the rubber keypad and keyboard

Steps:

1. Remove each front-panel knob by firmly grasping the knob (with pliers protected by a soft cloth to prevent scratches, if necessary) and pull it away from the front panel.
2. Remove the six PC3*6 screws on the keyboard.
3. Remove the keyboard.
4. Remove the rubber keypad.

This section describes how to remove the modules in the oscilloscope in detail. To install the removed parts or replace a new part, follow the instructions in reverse order.

7 Solving General Problems

This chapter includes suggestions for solving general problems.

1. The screen is still dark (no display) after power on:
 - Check if the power button is illuminated. Orange indicates the oscilloscope is in standby status and it needs a press to power on. White indicates that the oscilloscope is in the power-on status.
 - If the power button is not lit, check whether the power is correctly connected.
 - Check whether the fuse is burned out. If the fuse needs to be changed, please contact **SIGLENT** timely and return the instrument to the factory for replacement by the maintenance personnel authorized by **SIGLENT**.
 - Restart the instrument after finishing the above inspections.
 - Go to the **Troubleshooting** chapter and check the power supply modules and acquisition board.
 - If it still does not work correctly, please contact **SIGLENT**.

2. The screen displays only the logo. The instrument is frozen or unresponsive:
 - Remove all the USB devices plugged into the oscilloscope and power cycle the oscilloscope to try again.
 - If not working, try to power cycle the oscilloscope and press the math button on the front panel multiple times when the oscilloscope is booting up.
 - If not working, wait ten minutes to see if the oscilloscope can boot successfully. After the successful boot, try to upgrade to the latest firmware to solve the problem.
 - Try to recover the system using a U-disk including the recovery package. Contact **SIGLENT** for the recovery package and further instructions.
 - If the display is still stuck at the logo screen, contact **SIGLENT** for further instructions.

3. The signal is sampled but no waveform of the signal is displayed:
 - Check whether the probe is correctly connected to the signal connecting wire.
 - Check whether the signal connecting wire is correctly connected to the BNC (namely channel connector).
 - Check whether the probe is correctly connected to the item to be tested.

- Check whether there are signals generated from the item to be tested.
 - Check the **Trace** option of the associated channel is **Visible**, not **Hidden**.
 - Check the acquisition is running and trigger status is **Trig'd** or **Auto**.
 - Check the horizontal time/division setting is reasonable and the acquisition time is short enough for fast display.
 - Disconnect associated channel input and recall the default setup following the procedures in the User Manual.
 - Turn on the associated channel again and press the Auto Setup key.
 - If there is still no trace displayed, contact **SIGLENT** for further instructions.
4. The baseline trace drifts out of specification
- Check that the fan is running.
 - Check that the vertical position setting is working.
 - Perform self-calibration following the procedures in the User Manual.
 - If self-calibration does not work, contact **SIGLENT** for further instructions.
5. There is an unexpected trace when no input is connected to channel input
- Power cycle the oscilloscope.
 - Upgrade to the latest firmware.
 - Contact **SIGLENT** for further instructions.
6. The tested voltage amplitude is greater or lower than the actual value (Note that this problem usually occurs when the probe is used):
- Check whether the attenuation coefficient of the channel complies with the attenuation ratio of the physical probe.
 - Disconnect the oscilloscope from the external signal and do a self-cal.
7. There is a waveform display but not stable:
- Check the trigger signal source: Check whether the source item at the trigger panel complies with the signal channel used.
 - Check whether it is a " false wave ": When the signal frequency is very large (more than half of the sample rate), it is easy to appear as a " false wave " because of the violation of the Nyquist theorem. At this point, a smaller time base should be set to make the sample

rate is more than 2 times the signal frequency.

- Check the trigger type: General signals should use the “ Edge ” trigger and video signals should use the “ Video ” trigger. Only when the proper trigger type is used, can the waveform be displayed stably.
- Change the trigger holdoff setting.

8. No display after pressing Run / Stop :

- Check the trigger mode in the trigger menu (TRIGGER). Set to “ Normal ” or “ Single ” and ensure that the trigger level is set near the middle of the expected waveform amplitude or set the mode to “ Auto ”.

Note: Using Auto Setup can automatically finish the above setting.

9. Touch screen does not respond to touch operation:

- Check whether the Touch button backlight on the front panel is lighted up. If not, the touch screen is not turned on. Press the button to enable the touch screen
- Restart the instrument.

10. The USB storage device cannot be recognized:

- Check whether the USB storage device is operating correctly on another piece of equipment or computer.
- Make sure the USB interface is working normally.
- Make sure that the USB storage device being used is flash storage type. This oscilloscope does not support hardware storage types.
- Make sure that the U disk system format is FAT32.
- Restart the instrument and then insert the USB storage device to check it.
- If the USB storage device still cannot be used normally, please contact **SIGLENT**.

8 Troubleshooting

This chapter contains information and procedures to troubleshoot general hardware failures.

8.1 Safety Consideration and Cautions

Only qualified personnel should perform troubleshooting procedures. Disconnect the power cord whenever possible. DO NOT try to troubleshoot if visible damage is detected on the power supply module and the acquisition board, return it to SIGLENT for further repair.

WARNING



HAZARDOUS VOLTAGES

In case maintenance is performed with power supply on and without protective covers. Only qualified personnel with proper tools and protection should perform the maintenance. The equipment must be well-grounded during operation.

WARNING



AVOID ELECTRICAL SHOCK

Hazardous voltages exist on the power supply and LCD modules. To avoid electrical shock, disconnect the power cord and wait at least three minutes for the capacitors to discharge before you begin disassembly.

CAUTION



ESD CAUTION

Electrostatic discharge (ESD) sensitive devices inside. Electronic components may be damaged without protection. Proper ESD precautions should be taken to avoid performance degeneration or loss of functionality. As a minimum, place the oscilloscope on a properly grounded ESD mat and wear a properly grounded ESD strap.

CAUTION



REMOVE POWER SUPPLY TO AVOID DAMAGE

Remove the power supply before you start to disassemble or replace parts. Disassembling or replacing parts with power on is not allowed. Damage to the components may occur.

CAUTION



USE AN EXTERNAL FAN

When you remove the oscilloscope metal cover, always use an external fan to provide airflow over the heat sinks and the acquisition board.

8.2 Required Equipment

Table 16 Required Equipment

Equipment	Critical Specifications	Recommended Model
Digital Multi-meter	Accuracy $\pm 0.05\%$ 1 mV resolution	SIGLENT SDM3065X or Agilent 34401A
Oscilloscope	200 MHz BW 1 M Ω impedance	SIGLENT SDS1204X-E

8.3 Troubleshooting Flowchart

The following flowchart describes how to troubleshoot the oscilloscope in the most general case. This does not guarantee a 100% recovery of all possible hardware failures. Contact SIGLENT if you cannot solve the problem.

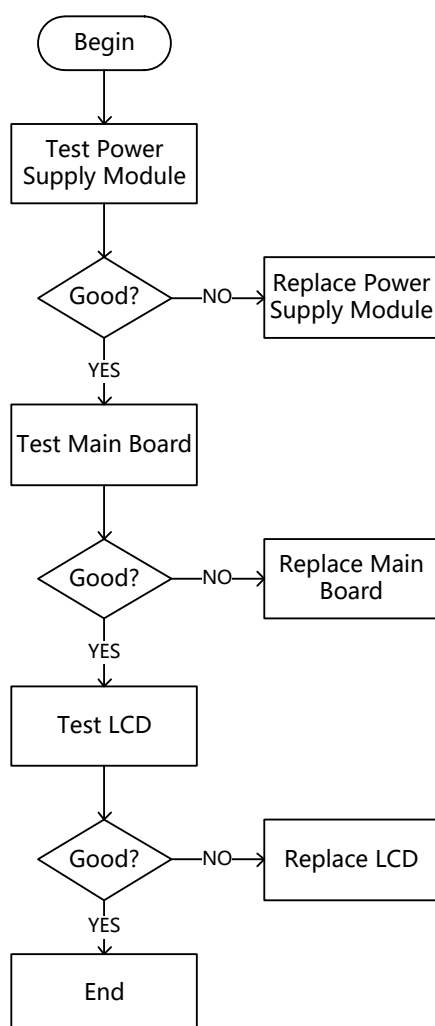

8.4 To Check the Power Supply Module

- Disconnect all the external cables and devices from the front and back panel.
- Disconnect the power cord of the oscilloscope.
- Remove the rear plastic cover and metal cover following the instructions in chapter **Disassembly Procedures**.
- Note that the power supply module is on the metal frame and you do not have to remove the power supply module to check it.
- Disconnect power supply cable from the acquisition board.
- Reconnect the power cord to the receptacle of the power supply module. Be cautious when working near the power supply module without the protective cover, high voltage may exist on the heat sink and other exposed conductors.
- Test the power supply with a multi-meter.

Table 17 Pin assignments of connectors on board

Connector	Pin Number	Wire Color	Specification
Power Supply	1, 2	Black	COM / GND
	3, 4	Red	12.4~ 12.8 VDC
	5, 6	Black	COM / GND
	7, 8	Red	12.4~ 12.8 VDC

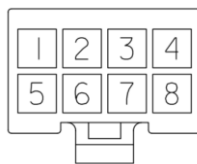

Figure 18 Pin definition of the power supply connector

8.5 To Check the Acquisition Board

This guide is based on the acquisition board revision C (labeled SDY8.007.262C). Future revisions will be compatible unless described differently.



8.5.1 Acquisition Board Drawing

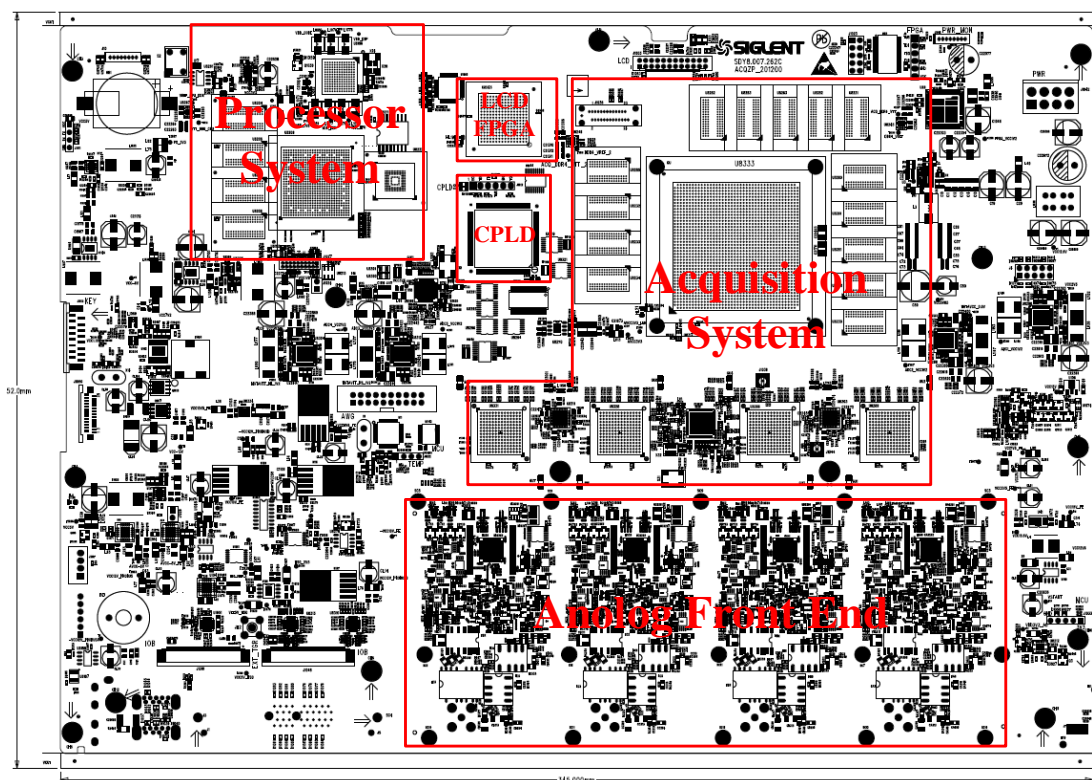

- Most of the test points are located on the top side of the board, it is not necessary to completely remove the board from the chassis to do the troubleshooting unless noticed. It is recommended to re-assemble the power supply module to the metal frame for safety considerations. Follow the instructions in chapter **Disassembly Procedures**.

- Reconnect the power cable to the acquisition board after you have confirmed that the power supply module is in good condition.
- Power up the acquisition board by pushing the front panel power button.
- In most cases, you can hear the relays click if the acquisition board power up successfully. If you cannot hear the click or there is no sign that the acquisition board is powering up, go to **To Check the Power Supply Module** section to check the stand-by power and the main power.
- If the power or the signal under test is abnormal, replace the acquisition board.

8.5.2 Check the board-level power supplies

Check the board-level power supplies. Find and measure those test points using a multi-meter.

Table 18 Voltage parameters of the board level power supplies

Number	Test Points	Net Name	Specification
1	T2087	PS_3V3	$3.3V_{DC} \pm 0.165V_{DC}$
2	T2222	VCC3V3	$3.3V_{DC} \pm 0.1V_{DC}$
3	T2117	VDD_CORE	$1.15V_{DC} \pm 0.1V_{DC}$
4	T2121	VDD_DSP	$1.15V_{DC} \pm 0.1V_{DC}$
5	T2118	VDD_1V8	$1.8V_{DC} \pm 90mV_{DC}$
6	T2120	VDD_DDR	$1.35V_{DC} \pm 70mV_{DC}$
7	T2119	VDD_MPU	$1.15V_{DC} \pm 0.1V_{DC}$
8	T11	VCC-6V	$-6V_{DC} \pm 0.3V_{DC}$
9	T8	VCC7V2	$7.2V_{DC} \pm 0.2V_{DC}$
10	T2228	VCC1.1V	$1.1V_{DC} \pm 0.1V_{DC}$
11	T2224	VCC1V8	$1.8V_{DC} \pm 54mV_{DC}$
12	T2234	ADC4_VCC3V3	$3.3V_{DC} \pm 0.165V_{DC}$
13	T2233	ADC4_VCC1V2	$1.2V_{DC} \pm 60mV_{DC}$
14	T2232	ADC3_VCC3V3	$3.3V_{DC} \pm 0.165V_{DC}$
15	T2231	ADC3_VCC1V2	$1.2V_{DC} \pm 60mV_{DC}$
16	T2229	MGTAVTT_RN_1V2	$1.2V_{DC} \pm 36mV_{DC}$
17	T2230	MGTAVTT_RS_1V2	$1.2V_{DC} \pm 36mV_{DC}$
18	T2200	FPGA_VCC1V2	$1.2V_{DC} \pm 60mV_{DC}$
19	T1	VCC12.6V	$12.6V_{DC} \pm 0.2V_{DC}$
20	T19	VCC0V85	$0.85V_{DC} \pm 25mV_{DC}$

21	T2221	MGTAVCC_0.9	$0.9V_{DC} \pm 27mV_{DC}$
22	T2220	VCC2V5	$2.5V_{DC} \pm 0.1V_{DC}$
23	T2216	ADC1_VCC3V3	$3.3V_{DC} \pm 0.165V_{DC}$
24	T2215	ADC1_VCC1V2	$1.2V_{DC} \pm 60mV_{DC}$
25	T2218	ADC2_VCC3V3	$3.3V_{DC} \pm 0.165V_{DC}$
26	T2217	ADC2_VCC1V2	$1.2V_{DC} \pm 60mV_{DC}$

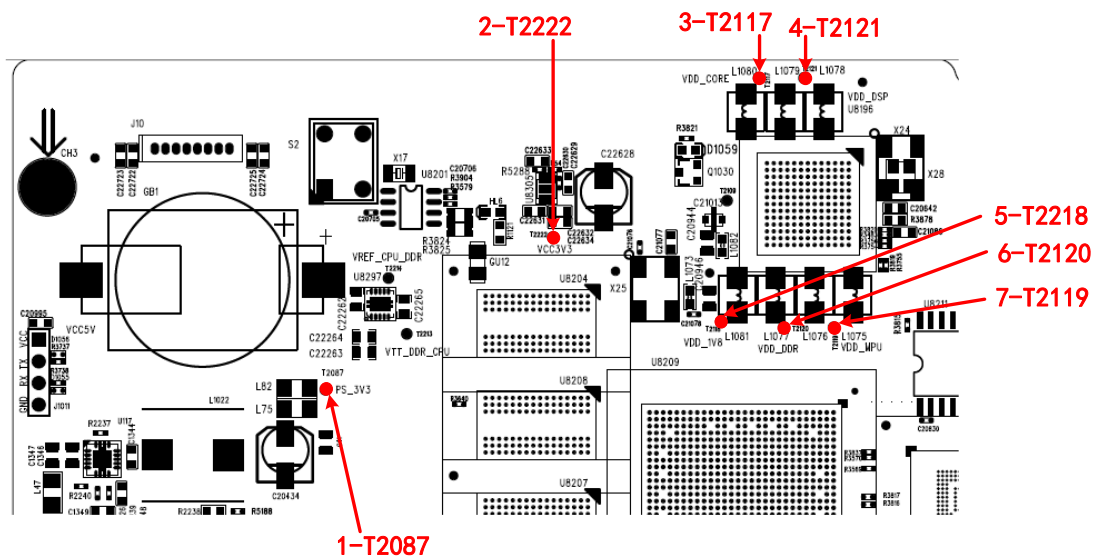

Figure 19 Test points for the Acquisition board power supplies

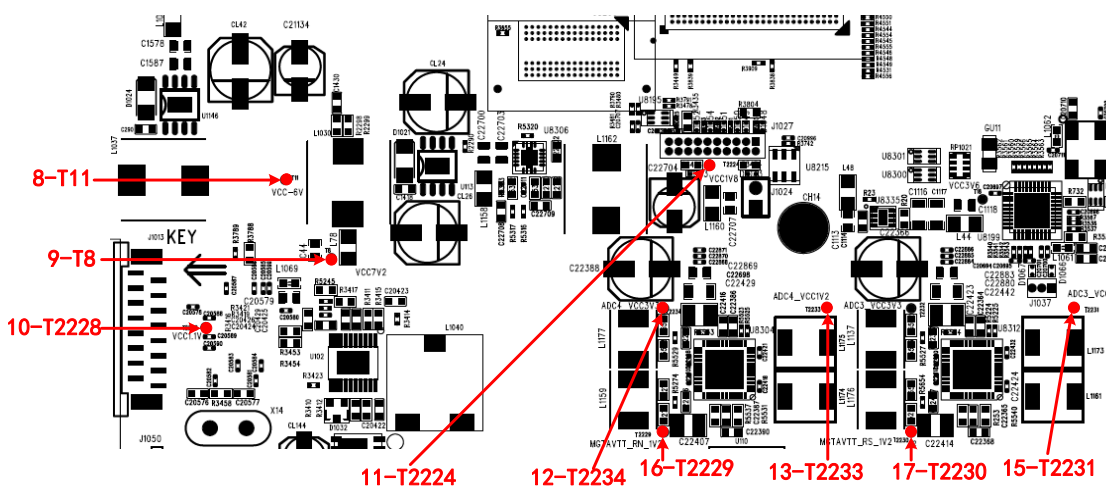

Figure 20 Test points for the Acquisition board power supplies (continued)

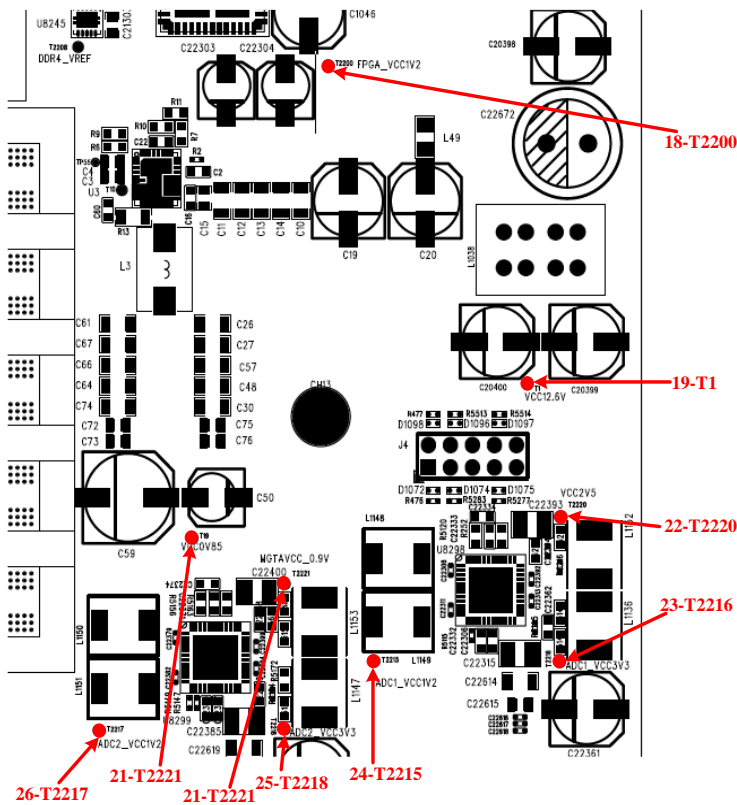

Figure 21 Test points for the Acquisition board power supplies (continued)

8.5.3 Check the clock

There are 3 clock oscillators and associated fanout buffers on board to source different circuits. Each of them serves one or more functions. The voltage compliance of all the clocks under test is LVCMOS33 or LVCMOS18.

Table 19 Clock parameters of the Acquisition System

Clock Frequency	Test Point	Served Function
25MHz ±20ppm	R732	Reference Clock for Ethernet
	R733	Reference Clock for CPLD
20MHz ±25ppm	X25	Reference Clock for CPU
10MHz ±1ppm	X31	Reference Clock for PLL
		Tolerance may be larger if the software has malfunctioned.

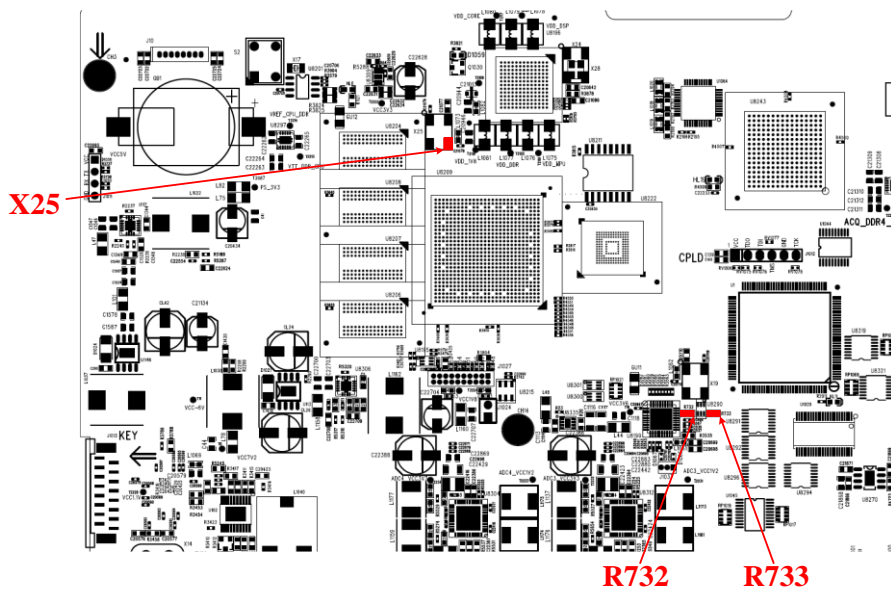

Figure 22 Test points for clock

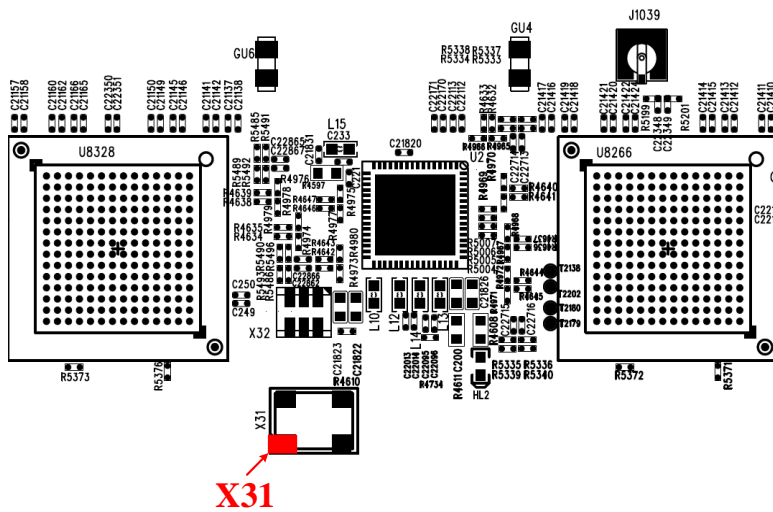

Figure 23 Test points for clock (continued)

8.6 To Check the LCD

- Reconnect the power cable to the acquisition board after you have confirmed that the power supply module is in good condition.
- Connect the LCD cable to the acquisition board.
- Power up the acquisition board by pushing the front panel power button.

8.6.1 To Check the LCD Power Supply

Find connector J1003 and measure those test points using a multi-meter.

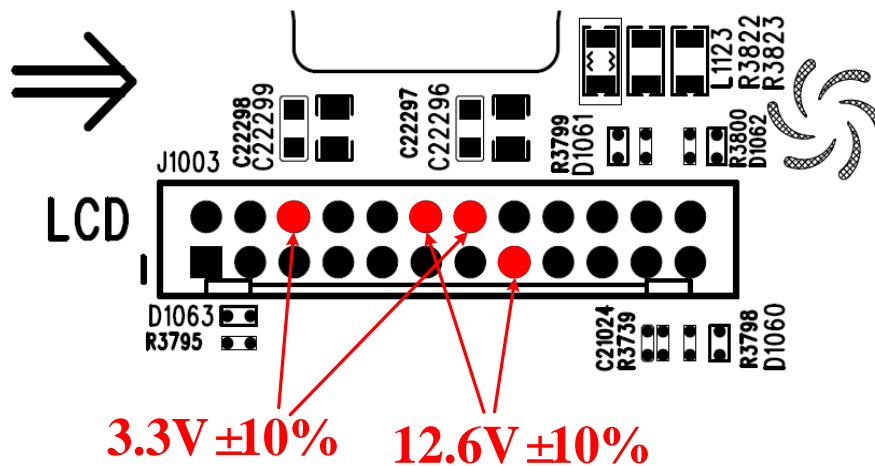

Figure 24 Test points for the LCD power supplies

If the power supply is out-of-specification, double-check with LCD cable disconnected. If the power supply is still out-of-specification, replace the acquisition board. If the power supply is good when the LCD cable is disconnected, replace the LCD panel or the LCDI board (the board between the acquisition board and the LCD panel).

8.6.2 To Check the LCD Signal

Find connector J1003, use an oscilloscope to measure the signal using the method below. Be aware that a 200 MHz oscilloscope may not be suitable for signal quality check, but good enough for signal presence detection.

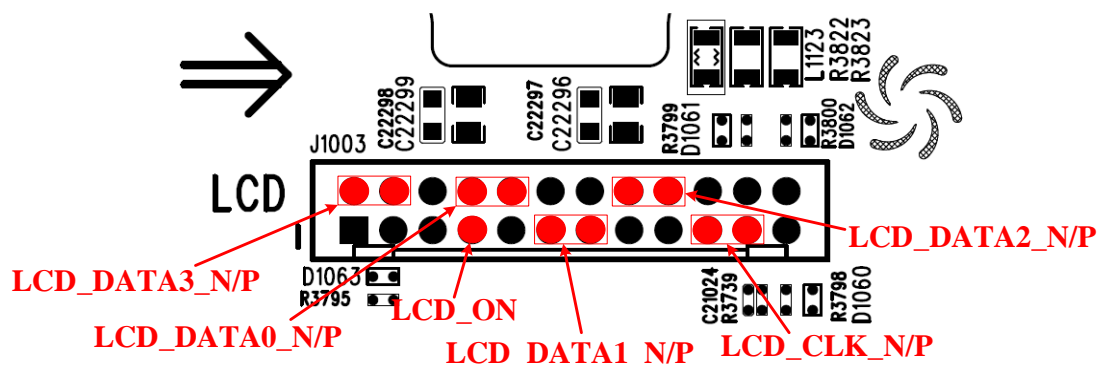

Figure 25 Test points for LCD signal

Table 20 Signal parameters of the LCD

Test Point	Signal	Compliance	Description
J1003 PIN7	LCD_ON	LVC MOS33	PWM signal to control the brightness of the LCD. Normally HIGH.
J1003 PIN8/10	LCD_DATA0_N/P	LVDS	LCD DATA signal. Always active.
J1003 PIN11/13	LCD_DATA1_N/P	LVDS	LCD DATA signal. Always active
J1003 PIN16/18	LCD_DATA2_N/P	LVDS	LCD DATA signal. Always active
J1003 PIN2/4	LCD_DATA3_N/P	LVDS	LCD DATA signal. Always active
J1003 PIN19/21	LCD_CLK_N/P	LVDS	LCD reference clock, typically 71MHz

- If the signal is active, replace the LCD panel.
- If the signal is stuck, double-check with the LCD cable disconnected. If the signal is still stuck, replace the acquisition board. If not, replace the LCD panel or the LCDI board.



About SIGLENT

SIGLENT is an international high-tech company, concentrating on R&D, sales, production and services of electronic test & measurement instruments.

SIGLENT first began developing digital oscilloscopes independently in 2002. After more than a decade of continuous development, SIGLENT has extended its product line to include digital oscilloscopes, isolated handheld oscilloscopes, function/arbitrary waveform generators, RF/MW signal generators, spectrum analyzers, vector network analyzers, digital multimeters, DC power supplies, electronic loads and other general purpose test instrumentation. Since its first oscilloscope was launched in 2005, SIGLENT has become the fastest growing manufacturer of digital oscilloscopes. We firmly believe that today SIGLENT is the best value in electronic test & measurement.

Headquarters:

SIGLENT Technologies Co., Ltd

Add: Bldg No.4 & No.5, Antongda Industrial Zone, 3rd Liuxian Road, Bao'an District, Shenzhen, 518101, China

Tel: + 86 755 3688 7876

Fax: + 86 755 3359 1582

Email: sales@siglent.com

Website: int.siglent.com

North America:

SIGLENT Technologies America, Inc

6557 Cochran Rd Solon, Ohio 44139

Tel: 440-398-5800

Toll Free: 877-515-5551

Fax: 440-399-1211

Email: info@siglent.com

Website: www.siglentna.com

Europe:

SIGLENT Technologies Germany GmbH

Add: Staetzlinger Str. 70

86165 Augsburg, Germany

Tel: +49(0)-821-666 0 111 0

Fax: +49(0)-821-666 0 111 22

Email: info-eu@siglent.com

Website: www.siglenteu.com

Follow us on
Facebook: SiglentTech

