

ST5680

Instruction Manual

DC HIPOT TESTER



**Read carefully before use.
Keep for future reference.**



When using the instrument for the first time

- Safety Notes ▶ p. 13
- Parts Names and Functions ▶ p. 20
- Basic Operation ▶ p. 31



Troubleshooting

- Maintenance and Service ▶ p. 221
- Error Display ▶ p. 226

EN



Contents

Introduction.....	7	4.5	Setting the Upper-Limit Value for Judgment.....	43
Confirming Package Contents.....	8	4.6	Setting the Lower-Limit Value for Judgment.....	44
Options.....	9	4.7	Setting the Auto-Range Function.....	46
Measurement Procedure.....	10	4.8	Setting the Data Maintaining Function during Auto-Ranging.....	47
Notations.....	11	4.9	Setting the Test Time.....	48
Safety Notes.....	13	4.10	Setting the Voltage Rise Time.....	50
Usage Notes.....	15	4.11	Setting the Voltage Drop Time.....	51
1 Overview	19	4.12	Setting the Judgment Wait Time (Delay Time).....	52
1.1 Product Overview.....	19	4.13	Setting the Arc Detection (DCW Only).....	54
1.2 Features.....	19	4.14	Offset Cancel (Open Compensation).....	56
1.3 Parts Names and Functions.....	20		Acquiring the compensation value.....	57
2 Preparation	23	4.15	Starting and Ending a Test.....	58
2.1 Wearing Rubber Gloves.....	23		Output voltage time rating.....	58
2.2 Connecting the Power Cord.....	24		Starting a test.....	59
2.3 Turn On and Off the Instrument.....	25		Operations during a test.....	60
2.4 Connecting the High Voltage Test Lead.....	26		Screen display in the TEST mode.....	61
2.5 Inspecting the Instrument Before Use.....	28		Stopping a test.....	63
Startup check.....	29	4.16	Making a Pass/Fail Judgment.....	64
2.6 Connection to the Test Target.....	30		Judgment type and operation.....	64
		4.17	Automatic Discharge Function.....	66
3 Basic Operation	31	5 W-IR/IR-W Test Mode	67	
3.1 Basic Screen Transition Diagram.....	32	5.1	Setting the Test Conditions.....	68
3.2 Screen Display.....	33		Displaying the setting screen.....	68
3.3 Basic Screen Operation.....	35		Test conditions.....	68
3.4 Selecting the Test Mode.....	36	5.2	Setting the Interval Time.....	69
		5.3	Operations for Fail Judgment.....	70
4 Withstand Voltage Test/ Insulation Resistance Test Mode	37	5.4	Starting and Ending a Test.....	71
4.1 Setting the Test Conditions.....	37		Starting a test.....	71
Displaying the setting screen.....	37		Stopping a test.....	71
Test conditions.....	38		Ending a test.....	71
4.2 Setting the Test Voltage.....	39	5.5	Making a pass/fail Judgment.....	71
4.3 Setting the Limit Voltage Value.....	40		Judgment type and operation.....	71
4.4 Setting the Start Voltage (DCW Only).....	42	5.6	Automatic Discharge Function.....	72
		6 Program Mode	73	
		6.1	Setting the Test Conditions.....	73
			Displaying the setting screen.....	73
			Setting the number of steps.....	74
			Editing test conditions of each step.....	75

- Editing all test conditions together76
- Inserting a step77
- Deleting a step77
- Copying and pasting a step78
- 6.2 Setting the Interval Time Between Steps79
- 6.3 Operations for Fail Judgment80
- 6.4 Starting and Ending a Test81
 - Starting a test81
 - Stopping a test81
 - Ending a test81
- 6.5 Making a Pass/Fail Judgment81
 - Judgment type and operation81
- 6.6 Automatic Discharge Function82
- 6.7 Individually Executing Specific Steps82
 - Measurement screen82
 - Compensation execution screen83

7 Dielectric Breakdown Voltage (BDV) Measurement Mode 85

- BDV test details85
- 7.1 Setting the Test Conditions87
 - Displaying the setting screen.....87
- 7.2 Continuous Voltage Rise Test.....88
 - Setting the test conditions88
 - Measurement details.....93
 - Starting a test93
 - Stopping a test93
 - Ending a test93
- 7.3 Gradual Voltage Rise Test.....94
 - Setting the test conditions94
 - Measurement details.....100
 - Starting a test100
 - Stopping a test100
 - Ending a test100

8 Various Functions 101

- 8.1 Waveform Graph Display101
- 8.2 Contact Check105
 - Contact check procedure105
 - Acquiring the compensation value.....106
- 8.3 Insulation Resistance Test End Mode108
- 8.4 Data Memory Function109
 - Setting the memory function.....109
 - Saving memory data110

- Clearing memory data..... 111
- 8.5 GFI Function (DCW Only)..... 112
- 8.6 Adjusting the Buzzer Volume..... 113
- 8.7 Momentary Out..... 114
- 8.8 Key Lock 115
 - Activating the key lock function for the instrument115
 - Releasing the key lock function116
 - Setting a passcode 117

9 Panel Memory Function 119

- Screen configuration 120
- Saving test conditions (panel save function)..... 121
- Loading test conditions (panel load function) 121
- Changing the panel name 121
- Deleting panel data 122

10 USB Flash Drive 123

- 10.1 Using USB Flash Drive..... 124
- 10.2 Inserting and Removing a USB Flash Drive 125
- 10.3 Checking File Contents on a USB Flash Drive 126
- 10.4 Settings for Saving the Data 127
 - Setting the save method and items to be saved 127
 - Setting the text save format..... 129
 - Setting the file and folder names 130
 - Setting the screen save format..... 131
- 10.5 Saving the Test Results 132
 - Save method 132
 - Checking the test results that have been saved..... 133
- 10.6 Saving and Importing the Test Conditions..... 137
 - Saving test conditions 137
 - Loading test conditions 138
- 10.7 Editing Files and Folders..... 139
 - Formatting the USB flash drive..... 139
 - Creating a folder 141
 - Deleting a file or folder 141
 - Change the name of a file or folder..... 142
 - Displaying the information 142

11	System Settings	143	13	Communications (USB, LAN, RS-232C, GP-IB)	183
11.1	Checking the Instrument Information	143	13.1	Interface Overview and Features.....	184
11.2	Self-test Function	144		USB	185
	Touch screen test	144		LAN.....	185
	Calibrating the touch screen.....	145		RS-232C	185
	Testing the instrument buttons and rotary knob	146		GP-IB	186
	Testing the Remote Control Box switches	147		Total	186
	Testing the screen display	148	13.2	Mounting and Removing an Interface.....	187
	ROM/RAM test	149	13.3	Interface Settings	188
	Full test	150	13.4	Connecting and Setting USB.....	189
	I/O handler test.....	151		Installing the USB driver.....	189
11.3	Setting the Date and Time.....	152		Connection method.....	189
11.4	Calibration Expiration Check Function	153		Instrument settings	189
12	External Control (EXT. I/O)	155	13.5	Connecting and Setting LAN	190
12.1	Switching the Current Sink (NPN) and Current Source (PNP).....	157		Connection method.....	190
12.2	External Input and Output Terminals and Signals.....	158		Setting procedure	191
	Instrument connector and compatible connectors.....	158	13.6	Connecting and Setting RS-232C (Z3001)	193
	Instrument connector signal arrangement.....	158		Connection method.....	193
	Signal functions	160		Setting procedure	194
	Setting the judgment signal output timing	161	13.7	Connecting and Setting GP-IB (Z3000)	195
	Setting the test signal output timing	162		Connection method.....	195
	Selecting the test conditions saved using the panel save function	164		Setting procedure	195
	Interlock function	165	13.8	Control Using Communications Commands	196
12.3	Timing Charts	166		Remote state	196
	Timing chart for pass judgment	166		Local state	196
	Timing chart for fail judgment	168	13.9	Command Compatibility Function	197
	Timing chart for forced termination with a STOP signal	172	13.10	Command Header Function.....	198
	Timing chart for the program test mode.....	174	13.11	Command Monitor Function	199
	Calling panel memory	178	13.12	Command Log Screen.....	200
	Interlock	178	14	Specifications	201
12.4	Internal Circuit Configuration	179	14.1	General Specifications.....	201
	Electrical specifications	180	14.2	Input Specifications, Output Specifications, Measurement Specifications	202
	Connection examples	180	14.3	Functional Specifications	207
			14.4	Interface Specifications	217
			14.5	Option Specifications	218
				L2260 High Voltage Test Lead.....	218
				L2261 Unterminated Lead Cable	219

15 Maintenance and Service 221

- 15.1 Troubleshooting221
 - Frequently Asked Questions.....221
- 15.2 Repairs, Inspections, and Cleaning.....224
- 15.3 Error Display226
- 15.4 Disposal of the Instrument (How to Remove the Lithium Battery)229

16 Appendix 231

- 16.1 Internal Circuit Block Diagram231
- 16.2 Table of Default Settings232
- 16.3 Rackmount236
- 16.4 External View238
- 16.5 Remote Control Box (Option)239
 - 9613 Remote Control Box (Single) and 9614 Remote Control Box (Dual) (option).....240
 - Connection method.....241
- 16.6 Timer Calibration242

17 License Information 243

Index 251

Introduction

Thank you for purchasing the Hioki ST5680 DC Hipot Tester. To obtain maximum performance from the product, please read the Instruction Manuals first and handle and store them with care.

The latest edition of the instruction manuals

The contents of this manual are subject to change, for example as a result of product improvements or changes to specifications.

The latest edition can be downloaded from Hioki's website.

<https://www.hioki.com/global/support/download/>



Request for product user registration

Please register this product so that important information regarding the product can be received.

<https://www.hioki.com/global/support/myhioki/registration/>



The following instruction manuals are supplied with the instrument. Refer to these instruction manuals in accordance with your application. Be sure to also read the separate document "Operating Precautions" before use.

Type	Description	Printed edition	CD edition
Operating Precautions	Information for using the instrument safely	✓	–
Instruction Manual (This manual)	Functions and operation methods of this instrument, etc.	–	✓
Startup Guide	Information for using the instrument safely, basic operation methods, specifications (selected relevant information), warranty certificate, etc.	✓	–
Communication Instruction Manual	Instrument control methods using a communication interface, etc.	–	✓

Target audience

This manual has been written for use by individuals who use the product in question or who teach others to do so. It is assumed that the reader possesses basic electrical knowledge (equivalent to that of someone who graduated from the electrical program at a technical high school).

Trademarks

- Adobe and Adobe Reader are either registered trademarks or trademarks of Adobe in the United States and other countries.
- Windows is either registered trademarks or trademarks of Microsoft Corporation in the United States and other countries.

Confirming Package Contents

When you receive the instrument, inspect it carefully to ensure that no damage occurred during shipping. In particular, check the accessories, keys and switches on the panel, and connectors. If damage is evident, or if it fails to operate according to the specifications, contact your authorized Hioki distributor or reseller.

Confirm that these contents are provided.

Instrument

- ST5680 DC Hipot Tester

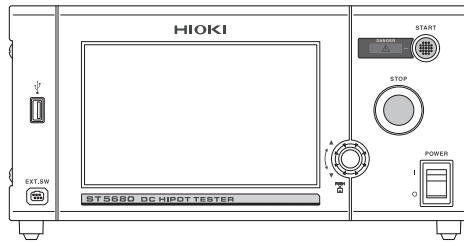

Accessories

- Operating Precautions (0990A903)
- Startup Guide
- Application disc (CD)
 - Instruction Manual (this document)
 - Communication Instruction Manual
- Power cord
- Plug and hoods for the external I/O terminal
- Custom-made interlock-canceling connector for the external I/O terminal

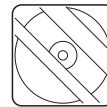

Options

The options listed below are available for the instrument. To order an option, please contact your authorized Hioki distributor or reseller.

Options are subject to change. Please check Hioki's website for the latest information.

Measurement leads

- L2260 High Voltage Test Lead (1.5 m)



- L2261 Unterminated Lead Cable (5 m)



Interfaces

- Z3000 GP-IB Interface



- Z3001 RS-232C Interface



Communication cables

- L9637 RS-232C Cable (9-pin/9-pin, 3 m)



- 9151-02 GP-IB Connector Cable (2 m)



Remote control boxes

- 9613 Remote Control Box (Single) (1.5 m)



- 9614 Remote Control Box (Dual) (1.5 m)



Measurement Procedure

Before using the instrument, be sure to read “Usage Notes” (p. 15).

Installation, connection, startup

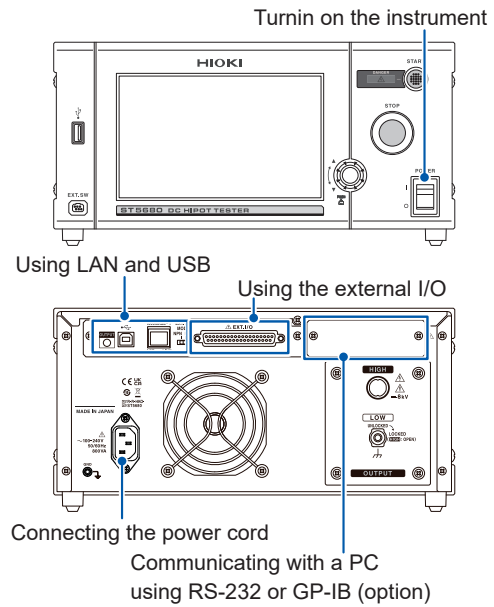
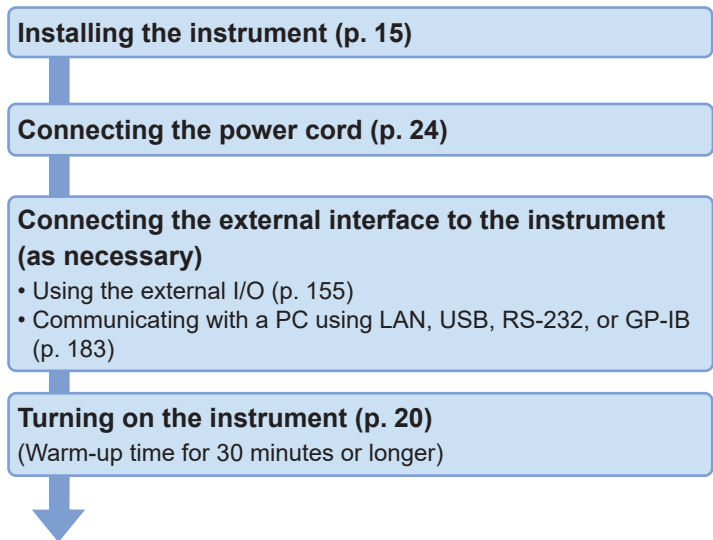

Instrument settings

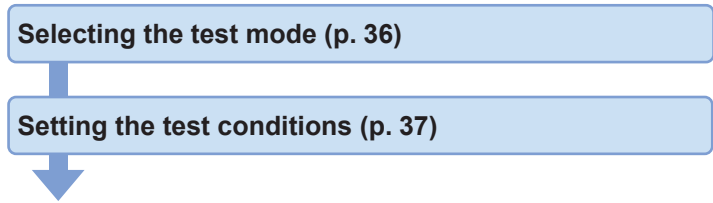

Start of measurement

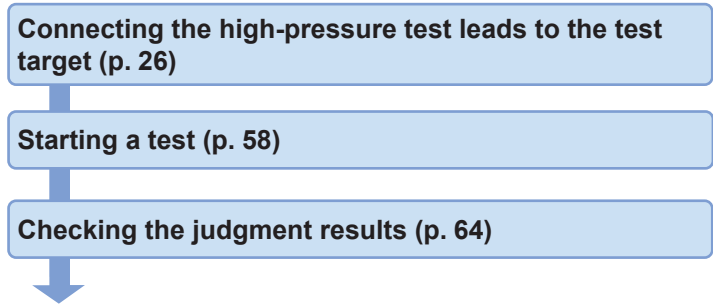



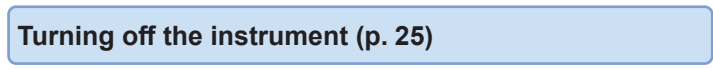



Finish









Notations

Safety symbols



In this manual, the risk seriousness and the hazard levels are classified as follows.

 DANGER	Indicates an imminently hazardous situation that, if not avoided, will result in serious injury or death.
 WARNING	Indicates a potentially hazardous situation that, if not avoided, could result in serious injury or death.
 CAUTION	Indicates a potentially hazardous situation that could result in minor or moderate injury or could damage the target product (or other property) if not avoided.
IMPORTANT	Indicates information or content that is particularly important from the standpoint of operating or maintaining the instrument.
	Indicates a high voltage hazard. If a particular safety check is not carried out or the product is mishandled, this may give rise to a hazardous situation; the operator may receive an electric shock, may get burnt or may even be fatally injured.
	Indicates an action that is prohibited.
	Indicates an action that must be performed.

Symbols affixed to the product

	Indicates the presence of a potential hazard. For more information about locations where this symbol appears on instrument components, see the section "Usage Notes" (p. 15), warning messages listed at the beginning of operating instructions, and the accompanying document entitled "Operating Precautions."
	Indicates a terminal that generates hazardous voltage.
	Indicates the "on" side of the power switch.
	Indicates the "off" side of the power switch.
	Indicates a chassis terminal, connected to the enclosure of the instrument.
	Indicates DC (Direct Current).
	Indicates AC (Alternating Current).

Symbols for various standards

	<p>Indicates that the product is subject to the Waste Electrical and Electronic Equipment (WEEE) Directive in EU member nations. Dispose of the product in accordance with local regulations.</p>
	<p>Indicates that the product complies with standards imposed by EU directives.</p>

Others

	<p>Indicates useful advice concerning instrument performance and operation.</p>
<p>*</p>	<p>Indicates additional information is provided below.</p>
<p>(p.)</p>	<p>Indicates the page number to reference.</p>
<p>START (Boldface)</p>	<p>Indicates the names and keys on the screens in boldface.</p>
<p>[]</p>	<p>Indicates the names of user interface elements on the screen.</p>
<p>Windows</p>	<p>Unless otherwise noted, the term “Windows” is used generically to refer to Windows 7, Windows 8, and Windows 10.</p>

Accuracy descriptions

The accuracy is expressed using the following formats together.

- Limit values for errors are defined using the same unit as for the measured values.
- Limit values for errors are defined using the percentages of reading and setting, and the digits.

<p>Reading (display value)</p>	<p>Indicates the value displayed by the instrument. Limit values for reading errors are expressed as a percentage of the reading (“% rdg”).</p>
<p>Setting (Set value)</p>	<p>Indicates the voltage and current values specified to be output from the measuring instrument. Limit values for setting errors are expressed as a percentage of the setting.</p>
<p>Digit (Resolution)</p>	<p>Indicates the minimum display unit (in other words, the smallest digit that can have a value of 1) for a digital measuring instrument. Limit values for digit errors are expressed using digits (“dgt”).</p>

Safety Notes

This instrument is designed to conform to IEC 61010 Safety Standards and has been thoroughly tested for safety prior to shipment. Using the instrument in a way not described in the Instruction Manuals may negate the provided safety features.

Before using the instrument, be sure to carefully read the following safety precautions.

DANGER



- **Read the instruction manual and understand the contents.**

Otherwise, the user may use the instrument improperly, which could result in serious bodily injury or damage to the instrument.

WARNING



- **If using electric measuring instruments for the first time, perform measurement under the supervision of someone with experience.**

Failure to do so could cause the operator to experience an electric shock. In addition, there are risks of heat generation, fire, and arc discharge due to short circuits.

Protective gear

DANGER

Be sure to observe the following to avoid fatal electric shock accidents.



- **Be sure to wear high-voltage protective rubber gloves while performing procedures.**

The internal components of the instrument carry high voltages and may become very hot during operation. Touching them could cause burns or electric shock.

Measurement categories

IEC 61010 defines measurement categories to facilitate safe use of measuring instruments. Test and measurement circuits designed to be connected to a main power supply circuit are classified into three categories depending on the type of main power supply circuit.

⚠ DANGER

- Do not use a measuring instrument to measure a main power supply circuit whose category exceeds the instrument's rated measurement category.



- Do not use any measuring instruments for which the rated measurement category is not specified for measurement of main circuits.

Doing so may result in serious bodily injury or damage to the instrument or other equipment.

Measurement category II (CAT II)	Applicable to test and measuring circuits connected directly to utilization points (socket outlets and similar points) of the low-voltage mains installation. Example: Measurements on household appliances, portable tools, and similar equipment, and on the consumer side only of socket outlets in the fixed installation.
Measurement category III (CAT III)	Applicable to test and measuring circuits connected to the distribution part of the building's low-voltage mains installation. Example: Measurements on distribution boards (including secondary meters), photovoltaic panels, circuit breakers, wiring, including cables, bus-bars, junction boxes, switches, and socket outlets in a fixed installation, as well as equipment for industrial use and some other equipment such as stationary motors with permanent connection to the fixed installation.
Measurement category IV (CAT IV)	Applicable to test and measuring circuits connected at the source of the building's low-voltage MAINS installation. Example: Measurements on devices installed before the main fuse or circuit breaker in the building installation.

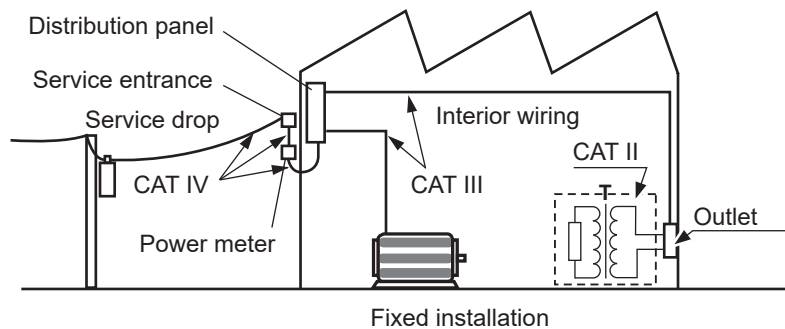

Usage Notes

Follow these precautions to ensure safe operation and to obtain the full benefits of the various functions.

Use the instrument following the specifications of not only the instrument itself but also the relevant accessories and options.

Checking before use

DANGER

- **Before using the instrument, check that the coating of the test leads are neither ripped nor torn and that no metal parts are exposed.**



- **Inspect the instrument and verify proper operation before use.**

Using a damaged probe or instrument could result in serious bodily injury. If any damage is found, replace the parts with those specified by Hioki.

Installing the instrument

WARNING

- **Do not install the instrument in the following locations:**

- Exposed to direct sunlight or high temperatures
- Exposed to corrosive or combustible gases
- Exposed to powerful electromagnetic radiation or close to objects carrying an electric charge
- Near induction heating systems (such as high-frequency induction heating systems and IH cooking equipment)
- Susceptible to mechanical vibration
- Exposed to water, oil, chemicals, or solvents
- Exposed to high humidity or condensation
- Exposed to high quantities of dust particles



Doing so could damage the instrument or cause it to malfunction, resulting in bodily injury.

CAUTION

- **Do not place the instrument on an unstable stand or angled surface.**

Doing so could cause the instrument to fall or overturn, resulting in bodily injury or damage to the instrument.



- **Do not let the connectors expose to water drops.**

This instrument is not water-proof. When the connectors are exposed to water drops, the instrument could fail.

Installation

- Leave at least the specified space on every surface to keep the instrument's temperature from rising.
- Place with its bottom side facing downward.
- Leave at least 15 mm of space underneath the installation surface (the height of its feet).
- Do not block vent openings.

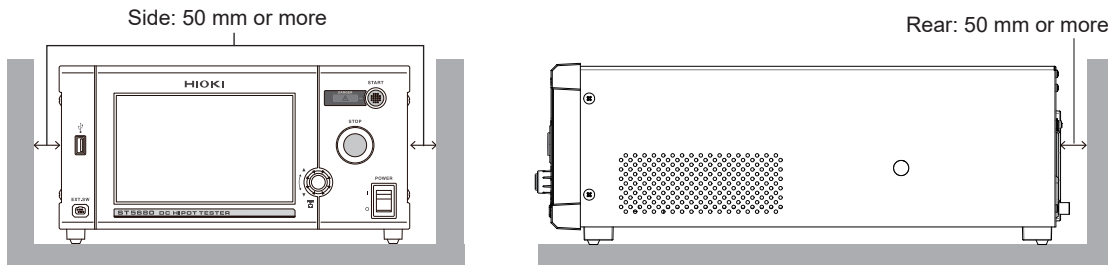

Handling the instrument

DANGER

- **Never remove the enclosure.**
The internal components of the instrument carry high voltages and may become very hot during operation. Touching them could cause burns or electric shock.

CAUTION

- **Do not subject the instrument to vibration or mechanical shock while transporting or handling it.**
- **Do not drop the instrument onto a floor or other surface.**
Doing so could damage the instrument.

The instrument is an EN 61326 Class A product.

This instrument may cause interference if used in residential areas. Such use must be avoided unless the user takes special measures to reduce electromagnetic emissions to prevent interference to the reception of radio and television broadcasts.

Precautions during measurement

DANGER



- **Exercise caution during output and never touch the instrument, connected subject to be tested (test target), clips of the high voltage test leads, and cables.**

Doing so could result in serious bodily injury or a short circuit.

WARNING



- **Do not perform a withstand voltage or insulation resistance test under the live-line condition.**

Doing so could damage the instrument, resulting in bodily injury.
Turn off the test target before starting measurement.



- **Turn off the instrument and remove all cables before attaching or detaching the Z3000 or Z3001.**

Failure to do so could cause the operator to experience an electric shock or damage the instrument, Z3000, or Z3001.

- **Mount the blank panel when the Z3000 or Z3001 is not to be connected.**

Failure to do so could cause the operator to experience an electric shock or damage the instrument.

Before removing the test target

WARNING



- **Remove the test target after the **DANGER** lamp has turned off.**

Trying to remove the test target immediately after the measurement could cause electric shock as the measurement voltage still remains inside the test target when performing measurement using high voltage.

Precautions during shipment

CAUTION

When shipping the instrument, make sure to observe the following items.



- **Remove the recording media, accessories, and options from the instrument.**
- **Include details of the problem.**
- **Double-pack the instrument using the original packaging materials.**

Otherwise, the instrument could be damaged during transportation.

Precautions related to disc usage

- Exercise care to keep the recorded side of discs free of dirt and scratches. When writing text on a disc's label, use a pen or marker with a soft tip.
- Store discs in protective cases. Avoid exposing the disc to direct sunlight, high temperatures, or high humidity.
- Hioki is not liable for any issues your computer system experiences in the course of using this disc.

1.1 Product Overview

This instrument is a safety tester that can perform DC withstand voltage and insulation resistance tests according to various safety standards. It can be used to perform safety tests for test targets including electronic equipment, parts, and materials in various fields from R&D to production lines.

1.2 Features

Test mode

- DCW: DC withstand voltage test
- IR: Insulation resistance test

Display of applied voltage waveform and measured value graph

The applied voltage waveform of when the test target fails a test and the startup behavior waveform at the start of a test can be monitored. In addition, the measured voltage, current, and resistance values can be displayed in chronological order and the behavior can be checked.

Insulation resistance test of large capacity output of 100 mA, up to 2000 V, and 100 GΩ measurement

Due to high-voltage resistance and improved insulation performance of automotive electric parts, etc., demands for insulation tests using high voltage are rising. This instrument can be used for such tests with peace of mind. With large capacity output of 100 mA, the charging time and inspection takt time can be reduced for large capacity capacitor insulation resistance tests compared with previous tests.

Stable DC output against capacitive load

Since stable output can be generated, a test can be performed with peace of mind even if the test target contains capacitive components.

Equipped with BDV (dielectric breakdown voltage) measurement function

Tests that are compliant with JIS C2110 and IEC 60243 voltage rise test and gradual voltage rise test can be performed.

Safety features for the safety of operators

The GFI function is installed as a safety feature to prevent electric shock.

Standard LAN and USB connectors

LAN and USB connectors come with the instrument as a standard feature. GP-IB and RS-232C can also be added as options.

Color LCD with touch screen

The 7-inch color LCD with a touch screen is used for improved visibility and easy operation.

1.3 Parts Names and Functions

Front

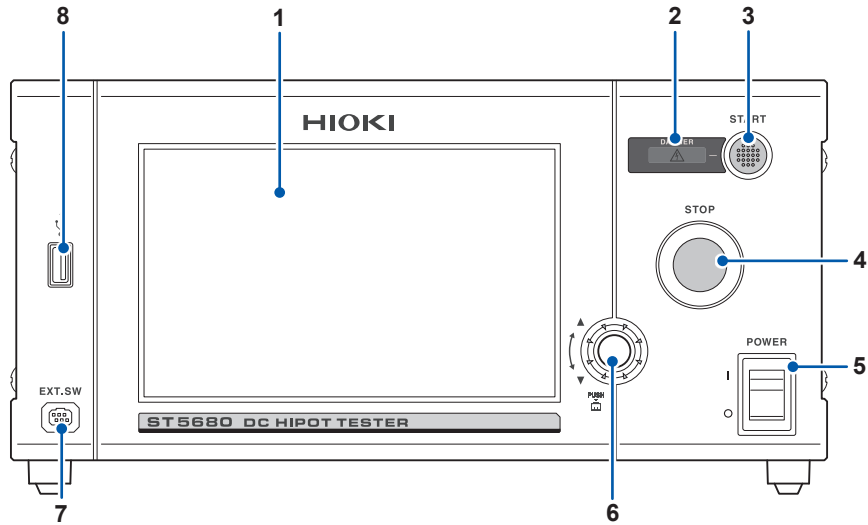

No.	Name	Function
1	Display	Color LCD with a touch screen
2	DANGER lamp	Lights up and warns you when a hazardous voltage is applied to the output terminals.
3	START button	Used to start a test.
4	STOP button	Used to forcefully terminate a test.
5	Main power switch	Used to turn on and off the instrument.
6	Rotary knob	Used for set items to change numerical values.
7	External switch terminal	Connects the Remote Control Box. (p. 239)
8	USB flash drive interface	Connect a USB flash drive to save various types of data, including the measurement data, setting details, and screen images. (p. 123) Computer peripherals, such as a mouse, keyboard, cannot be connected.

Key lock function

See “8.8 Key Lock” (p. 115).

- All touch screen operations except for the **START** button, **STOP** button, and key lock release operations are disabled while the key lock function is enabled.
- The key lock state will persist even if the instrument is cycled.

Handling the touch screen

CAUTION



- Do not press too hard on the touch screen.
 - Do not use hard or sharp objects to operate the touch screen.
- Doing so could damage the instrument.

Rear

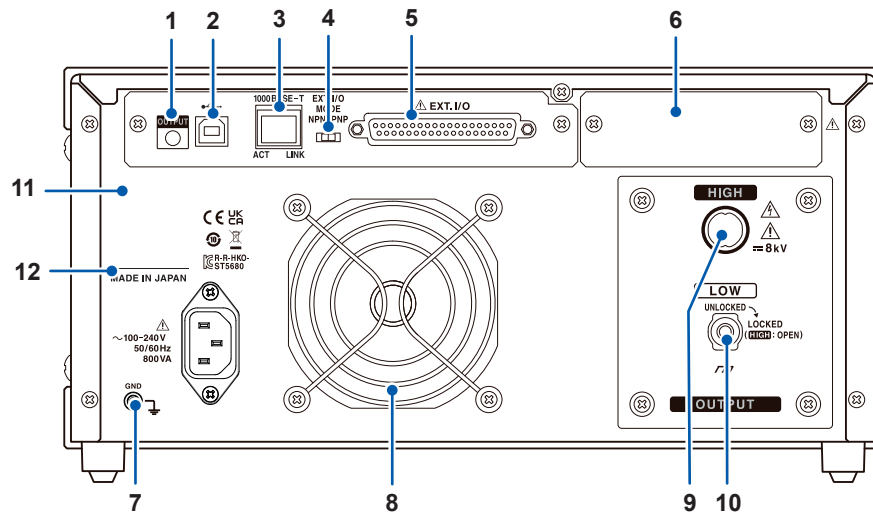

No.	Name	Description	Reference
1	Output LED lamp	Lights up in red during test voltage output.	-
2	USB connector	Controls the instrument remotely.	p. 123
3	LAN connector	Controls the instrument remotely over a LAN.	p. 190
4	External I/O MODE switch (NPN/PNP)	Switches the type of the programmable logic controller (PLC) to be connected to the external I/O terminal.	p. 157
5	External I/O terminal	Controls the instrument with a PLC and other connected external devices.	p. 155
6	(any one of the following:) Blank panel GP-IB connector RS-232C connector	Used to externally control the instrument using GP-IB or RS-232C. An optional Z3000 GP-IB interface or Z3001 RS-232C interface can be connected.	p. 193 p. 195
7	Power supply inlet	Connect the included power cord.	p. 24
8	Vents	Ventilates the instrument to prevent the temperature of the inside from going up excessively.	p. 16
9	Voltage-output high terminal	High-voltage-side terminal for voltage output	p. 26
10	Voltage-output low terminal	Low-voltage-side terminal for voltage output	p. 26
11	MAC address	Shows the MAC address.	-
12	Serial number	The serial No. consists of 9 digits numbers. The first two digits from the left show the last two digits of the year of manufacture and the next two digits show the month of manufacture. Required for production control. Do not remove it.	-
13	Ground terminal	Used to ground the instrument.	

Right side

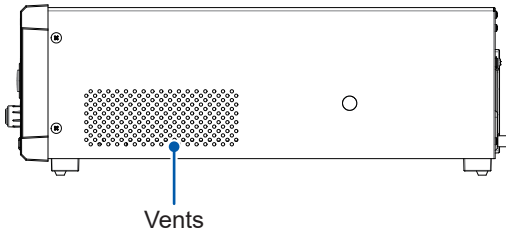

Left side

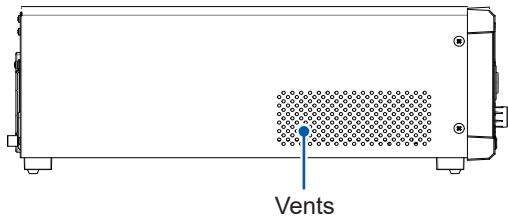

Bottom

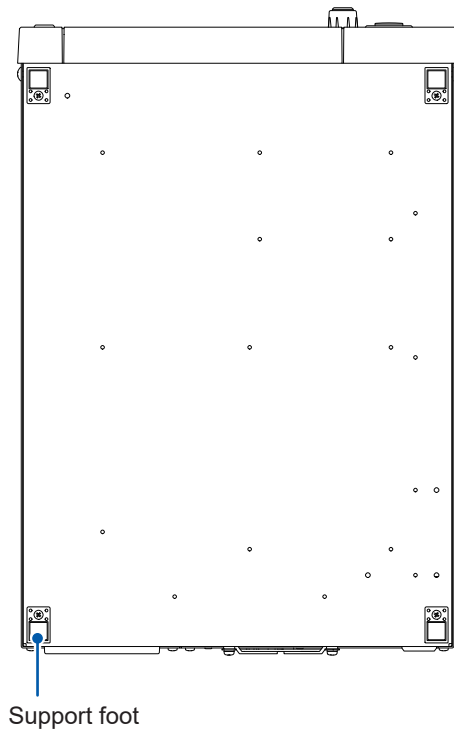

Leave at least 50 mm of space between the installation surface and the instrument vents. (p. 16)

2 Preparation

2.1 Wearing Rubber Gloves

When using this instrument, be sure to wear high-voltage protective rubber gloves.

DANGER



- **Exercise caution during output and never touch the instrument, connected test target, clips of the High Voltage Test Leads, and cables.**

Doing so could result in serious bodily injury or a short circuit.

Be sure to observe the following to avoid fatal electric shock accidents.



- **Be sure to wear high-voltage protective rubber gloves while performing procedures.**

The internal components of the instrument carry high voltages and may become very hot during operation. Touching them could cause burns or electric shock.

If high-voltage protective rubber gloves are not available, contact your authorized Hioki distributor or reseller.

2.2 Connecting the Power Cord

⚠ WARNING

- **Connect the plug of the power cord to a grounded bipolar outlet.**



Connecting the power cord to an ungrounded outlet could cause the user to experience electric shock.

⚠ CAUTION

- **Before connecting the power cord, verify that the supply voltage you plan to use falls within the supply voltage range noted on the instrument's AC inlet.**

Supplying a voltage that falls outside the specified range to the instrument could damage the instrument, causing bodily injury.



- **When unplugging the power cord from the outlet or instrument, pull on the plug (not the cord).**

The cable could be broken or the output terminal could be damaged.

- **Connect the power supply correctly.**

Failure to do so could damage the instrument, resulting in bodily injury.

- 1** Make sure that the instrument power switch is set to off (O).
- 2** Check that the supply voltage to be used falls within the supply voltage range (100 V to 240 V AC) noted on the back of the instrument.
- 3** Connect the power cord to the power inlet.
- 4** Connect the plug of the power cord to an outlet.

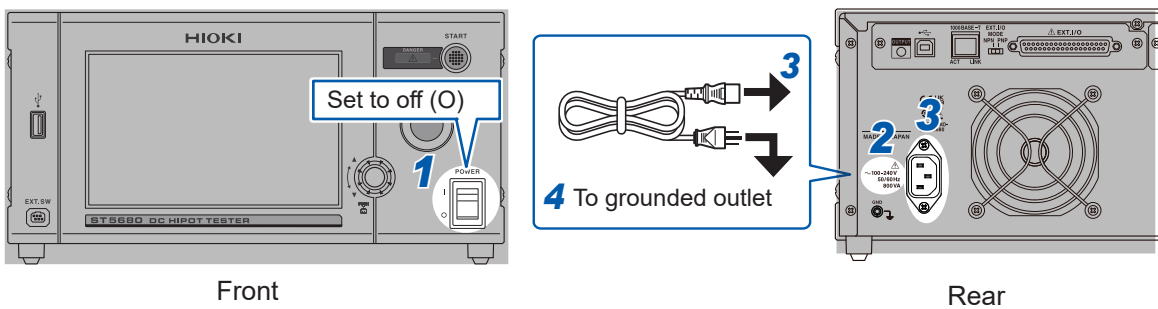

IMPORTANT

If the power supply is cut off while the main power switch is set to on (by a breaker tripping, etc.), the instrument starts automatically when the power is supplied again.

2.3 Turn On and Off the Instrument

Turn on and off the instrument using the main power switch on the front of the instrument.

⚠ CAUTION

- **Wait for at least 10 seconds set the power switch to on again after set it to off.**

Repeatedly setting the power switch to on and off at brief intervals may not provide protection against rush current. The fuse service life may be shortened or the fuses may melt causing the instrument to fail.



- **Do not turn off the instrument during output except for emergencies. Do not shut down the supplied power.**

Doing so may cause a malfunction of the instrument.



To perform high accuracy measurement, be sure to leave the instrument to warm up for 30 minutes or longer after turning on the instrument.

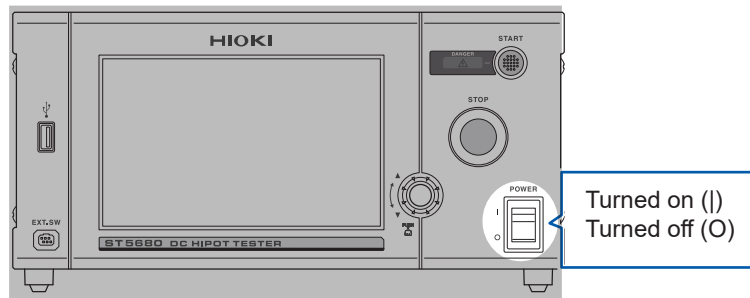

Front

If an error is displayed, repairs are required. Please contact your authorized Hioki distributor or reseller.

See “15.3 Error Display” (p. 226).

2.4 Connecting the High Voltage Test Lead

Connect the L2260 High Voltage Test Lead (option) to the voltage output terminal on the back of the instrument.

The voltage output terminal on this instrument has a mechanism to prevent the LOW side lead from coming off.

DANGER

- **Before using the instrument, check that the coating of the test leads are neither ripped nor torn and that no metal parts are exposed.**



Using the damaged test leads or instrument could result in serious bodily injury. If any damage is found, replace the parts with those specified by Hioki.

- **Inspect the instrument and verify proper operation before use.**

Use of the instrument while it is malfunctioning could result in serious bodily injury. If you find any damage, contact your dealer or Hioki representative.

- **Never touch the test lead tip during testing ([TEST] lit).**

Doing so could result in serious bodily injury or a short circuit.



- **Do not let the end of the test lead short-circuit two lines with voltage applied.**

A short circuit could result in serious bodily injury.

WARNING



- **Do not use test leads or the like whose insulation is damaged or whose metal portion is exposed.**

A hazardous voltage is applied to the measurement terminals. Doing so could result in serious bodily injury.

- **Before connecting the L2260 High Voltage Test Lead and L2261 Unterminated Lead Cable, turn off the instrument and check that a high voltage is not applied to the voltage output terminal.**

- The **DANGER** lamp is off.
- **[TEST]** is not lit in the display area.

Failure to do so could cause the operator to experience an electric shock or damage the instrument.



- **Before starting a test, make sure that the L2260 High Voltage Test Lead is properly connected.**

Applying a voltage while the L2260 High Voltage Test Lead is not properly connected could result in serious bodily injury.

- **When using the instrument, use the test leads specified by Hioki.**

Using test leads other than those specified could cause bodily injury or short-circuit accidents.

Connection method

- 1** Turn off the instrument.
- 2** Connect the black lead to the low-side terminal on the back of the instrument and turn it clockwise.

The black lead is locked and the shutter of the HIGH side terminal opens.

- 3** Connect the red lead to the high-side terminal.

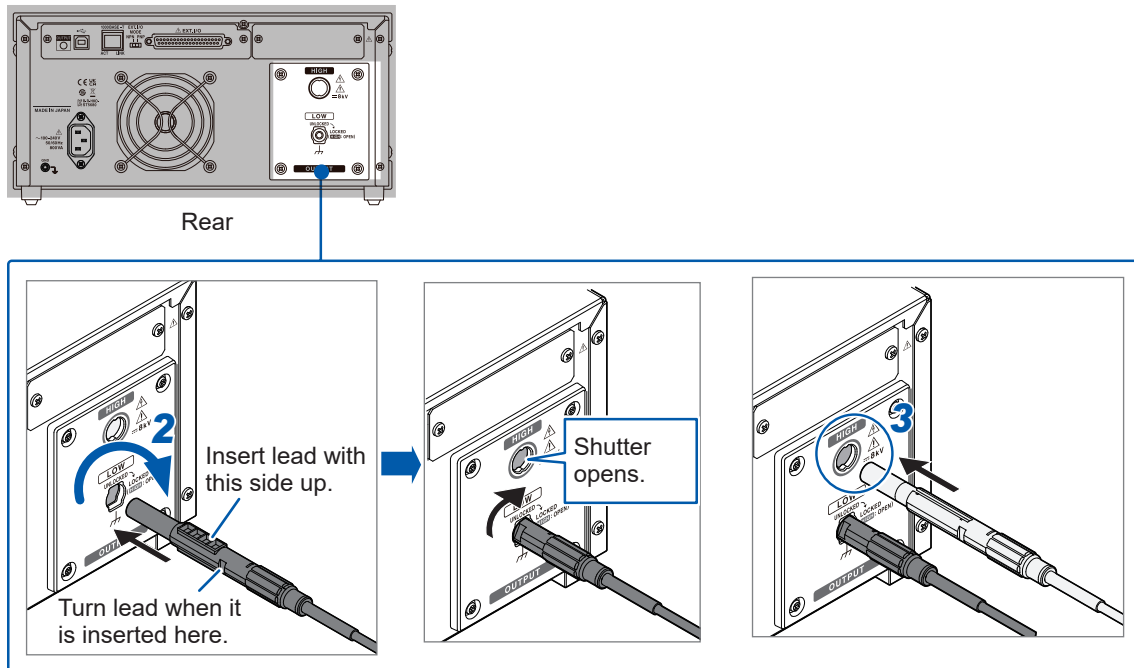

Removing the High Voltage Test Lead

- 1** Turn off the instrument.
- 2** Disconnect the red lead from the HIGH side terminal.
- 3** Turn the black lead counterclockwise.
- 4** Disconnect the black lead.

2.5 Inspecting the Instrument Before Use

Before starting measurement, inspect the instrument and peripherals.

DANGER



■ **Inspect the instrument and verify proper operation before use.**

Use of the instrument while it is malfunctioning could result in serious bodily injury. If you find any damage, contact your dealer or Hioki representative.

Checking the instrument and peripherals

Check item	Action
The power cord's insulation is not worn or no metal is exposed.	If you find any damage, do not use the instrument as the damage may result in an electric shock or short circuit. Please contact your authorized Hioki distributor or reseller.
There is no damage to the instrument.	
The insulation of the leads and cords to be used is not worn or no metal is exposed.	If any damage is found, there is a risk of electric shock. Do not use any damaged part and promptly replace it with the specified one.

Check when the instrument is turned on

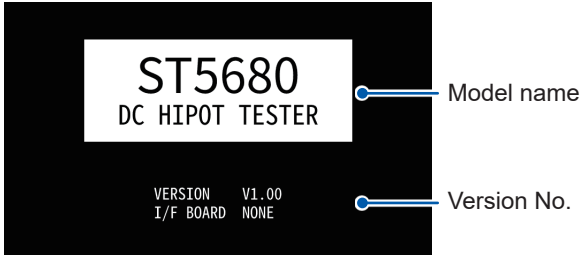
Check item	Action
When the instrument is turned on, "Model" and "Version No." are displayed in the display area.	<p>If "Model" and "Version No." are not displayed, the instrument may be damaged. Make a repair request.</p> 
After a self-test is completed, the measurement screen is displayed.	If the measurement screen is not displayed, the instrument's internal circuits may be damaged. Make a repair request.

Startup check

In order to perform a test safely, inspect the instrument prior to startup.

Interrupting current (withstand voltage test mode)

- 1** Prepare a resistor with a resistance less than the resistance value calculated from the output voltage and the test upper-limit value (interrupting current) set for the withstand voltage test.*1
- 2** Set the test upper-limit value.
- 3** Connect the High Voltage Test Lead to the prepared resistor.
- 4** Starting a test (p. 58)

Check that the fail judgment is displayed. If the fail judgment is not displayed, the instrument may be damaged. Please contact your authorized Hioki distributor or reseller.

Resistance measurement (insulation resistance test mode)

- 1** Prepare a resistor with a value more than the lower limit for the insulation resistance test and close to the test lower limit.*1
- 2** Setting the test voltage
- 3** Connect the High Voltage Test Lead to the prepared resistor.
- 4** Starting a test (p. 58)

Check that the measured resistance value matches the resistance value of the prepared resistor. If the resistance values do not match, the instrument may be damaged. Please contact your authorized Hioki distributor or reseller.

*1. A high-voltage resistor with a rated power more than the power calculated from the output voltage and resistance value is recommended.

Recommended resistor: High-voltage/high-resistance thick film resistor GS series (Koa) or equivalent

Interlock

Check the interlock function for proper operation before starting a test.
See "Interlock function" (p. 165).

2.6 Connection to the Test Target

DANGER



- When the **DANGER** lamp is lit, never touch the voltage output terminals, High Voltage Test Lead, and test target.

Doing so could result in serious bodily injury.

- Before connecting the High Voltage Test Lead to the instrument, make sure that a high voltage is not applied to the voltage output terminals.

Failure to do so could result in serious bodily injury.



- When touching the voltage output terminals, High Voltage Test Lead, or test target, make sure that a high voltage is not applied to the voltage output terminals.

- The **DANGER** lamp is off.
- **[TEST]** is not lit in the display area.

There may be residual voltage in the voltage output terminal even after the test is completed, the residual voltage could cause electric shock.

- 1** Check that the **DANGER** lamp is not lit.
- 2** Check that **[TEST]** is not lit in the display area. (p. 61)
- 3** Connect the voltage output **LOW** side test lead to the test target.
Securely connect the test lead so that it does not come off during the test.
- 4** Connect the voltage output **HIGH** side test lead to the test target.

IMPORTANT

- Do not perform measurements in high temperature and high humidity environments. Also, do not route the High Voltage Test Lead long or do not subject it to vibration or other disturbances. Doing so may cause errors in measured values of the insulation resistance test, resulting in deviation from the accuracy specifications.
- If a short circuit occurs between the HIGH and LOW voltage output terminals of the instrument or a dielectric breakdown occurs in the test target during a test, noise is generated. The noise may cause the instrument and surrounding electronic equipment to malfunction. In such a case, connect a ferrite core to the high-voltage side test lead or connect a resistor in series. Consider the rated power and withstand voltage when selecting a resistor and check for a voltage drop in the test voltage, etc. When connecting a resistor, turn off the instrument to prevent electric shock.
- Do not connect the external I/O cable and communication cable near the test lead. Connecting these cables near the test lead could cause communication to malfunction due to noise. When the test lead comes in contact with the peripherals or the metal portion of a jig, leakage current may increase and a larger measurement error may occur.
- Make sure that the test lead and insulators are clean. Errors may occur during an insulation resistance test.

The instrument uses a touch screen for setting and changing the test conditions. Gently touch the onscreen keys to select the items and values set for those keys. Gentle “touching” of the screen is expressed as “pressing” hereafter.



CAUTION



- Do not press too hard on the touch screen.
- Do not use hard or sharp objects to operate the touch screen.

Doing so could damage the instrument.

3.1 Basic Screen Transition Diagram

Example: Withstand voltage test mode

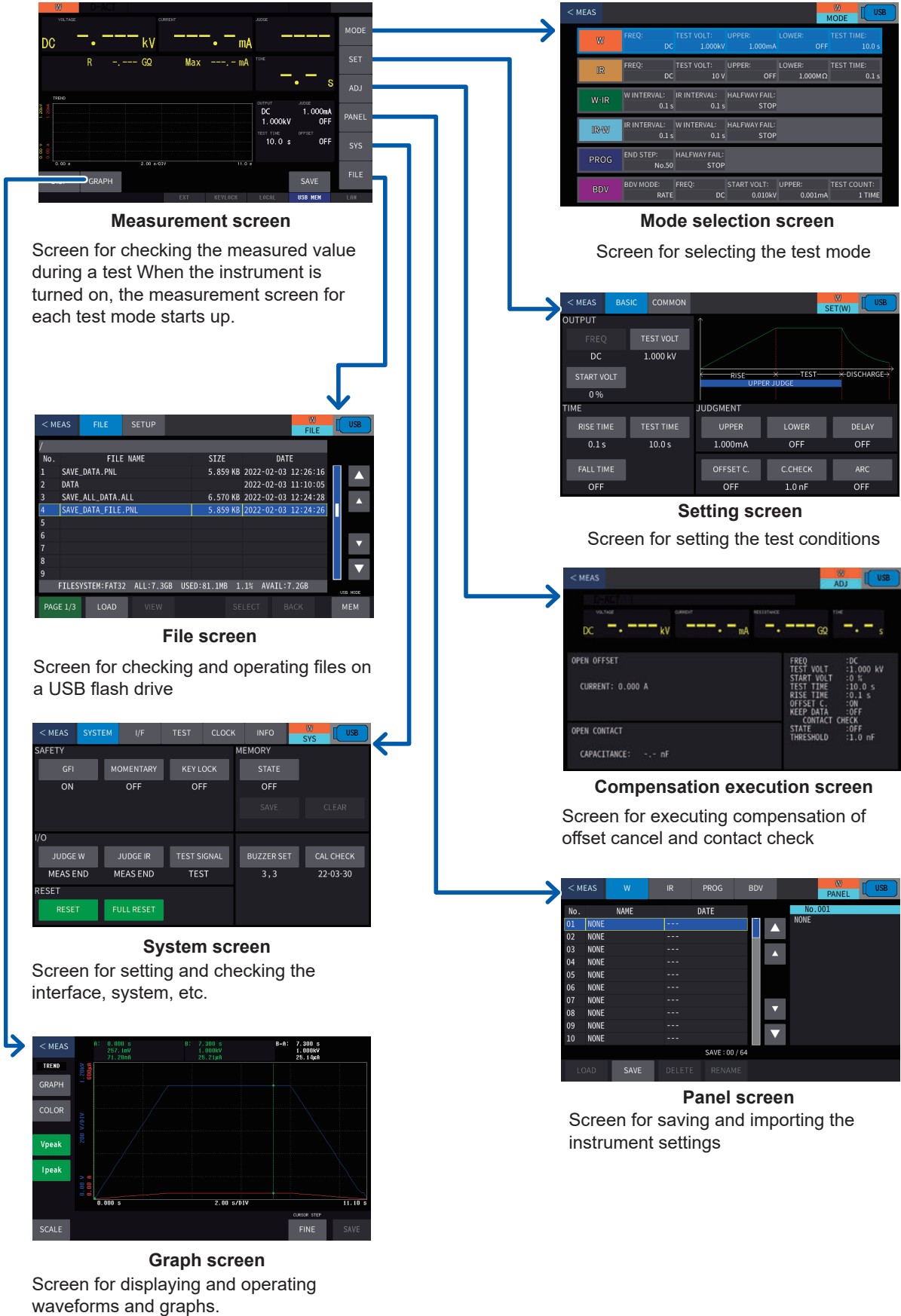

3.2 Screen Display

Measurement screen

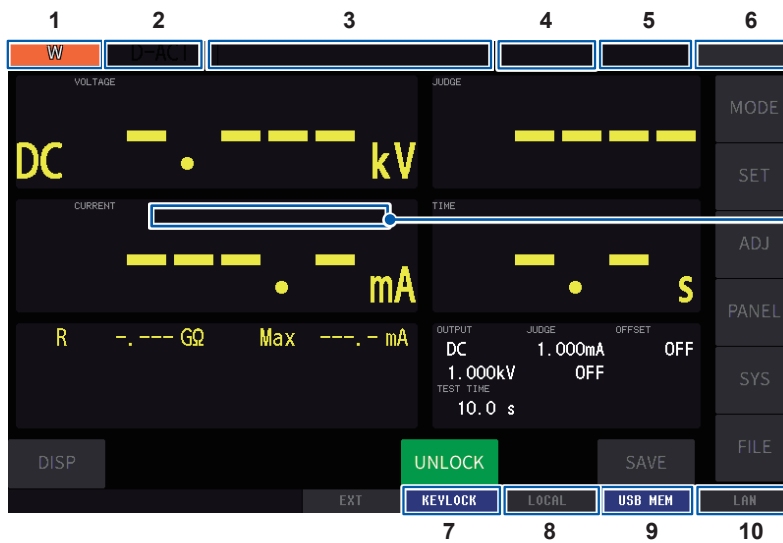

Display status of measured values

[REF VALUE]

Values for reference purpose (outside accuracy guarantee range)

[AUTO RANGE]

Switching range to another

When nothing appears
Normally measured value (Not switching range, inside accuracy guarantee range)

1 Mode

W	Withstand voltage test
IR	Insulation resistance test
W-IR	Withstand voltage/insulation resistance test
IR-W	Insulation resistance/withstand voltage test
PROG	Program test
BDV	Dielectric breakdown voltage measurement

2 Measurement status

D-ACT	Double action
READY	Test start ready
START	Start of measurement
RISE	Voltage rise in progress
TEST	Test in progress
FALL	Voltage drop in progress
END	Test end
DCHG	Discharge in progress
INTERVAL	Between steps
STOP	Force stop
DSTOP	Forced discharge stop
ERROR	Error
PROTECT	Protection

3 Error messages

See "15.3 Error Display" (p. 226).

4 Arc function

	Invalid
ARC	Valid
ARC DET	Arc detected

5 Data memory function

	Invalid
MEM:00005	Number of memories
MEM:FULL	Data memory full

6 External I/O input signal

EXT	Invalid
EXT	Valid

7 Key lock setting

KEYLOCK	Off
KEYLOCK	On

8 Communication status

LOCAL	Local state
REMOTE	Remote state

9 USB

USB COM	Communication (not connected)
USB COM	Communication (connected)
USB MEM	Memory (unmounted)
USB MEM	Memory (mounted)

10 LAN

LAN	Invalid
LAN	Link
LAN	Valid

Setting screen

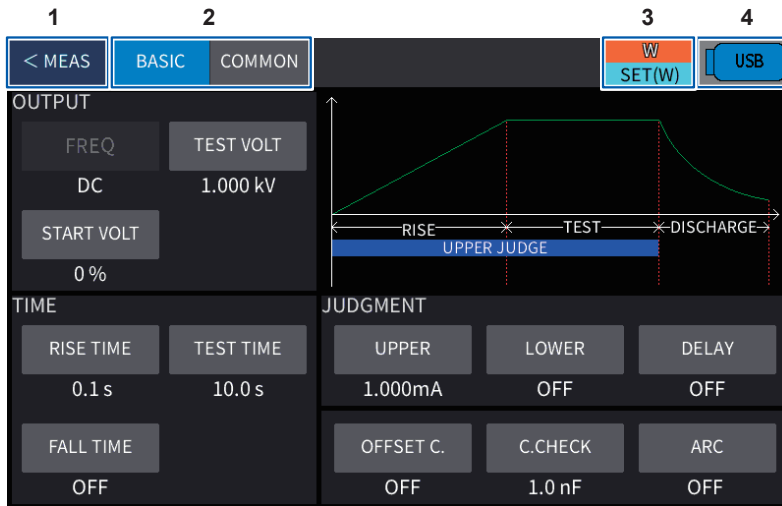

1	Return button	Returns to the measurement screen.
2	Tab	Switches between the setting screens.
3	Screen description	Top: Measurement mode Bottom: Screen name
4	Save screen	Saves images to a USB flash drive when this button is held down for a specific time.

3.3 Basic Screen Operation

Screens	Description
---------	-------------

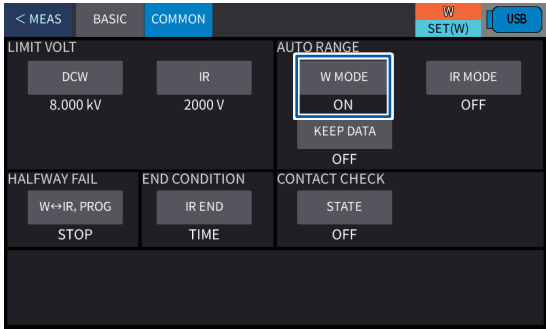

On/off
Press the button to toggle it between the [ON] and [OFF] settings.

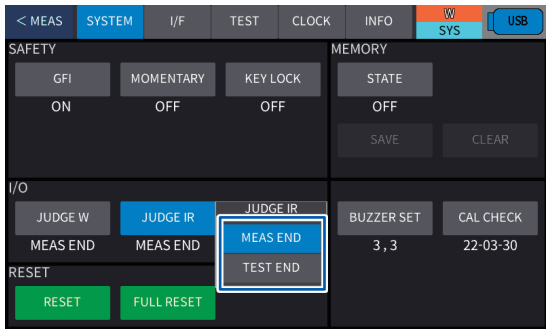

Settings
Press to select one of the options. Pressing outside the list of options closes the list without changing the setting.

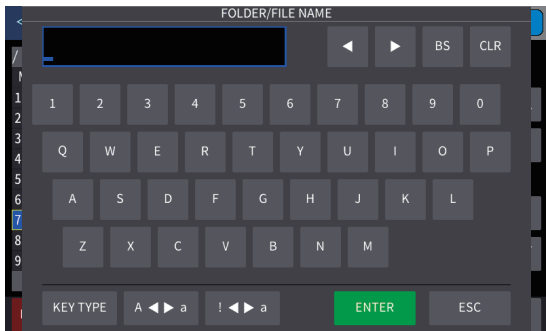

Keyboard windows
Enter a folder name or file name on the keyboard.

	Moves the cursor to the left.
	Moves the cursor to the right.
BS	Deletes 1 character.
CLR	Deletes all.
KEY TYPE	Switches the keyboard type.
A <> a	Switches between upper and lower case.
! <> a	Switches between symbols, numbers, and the alphabet.
ENTER	Accepts the entered text and closes the window.
ESC	Cancels text entry and closes the window.

3.4 Selecting the Test Mode

The following test modes are available for this instrument.

Test mode	Screen display	Description
DC withstand voltage test (DCW)	[W]	Allows you to check whether an electric product or part has sufficient insulation resistance against the service voltage (dielectric breakdown does not occur). This test is performed when the dielectric breakdown cannot be determined because the capacitive components of the test target are large and a high AC current flows.
Insulation resistance test (IR)	[IR]	Allows you to check whether an electric product or part has a sufficient insulation resistance value against the service voltage.
W-IR/IR-W test	[W-IR] [IR-W]	Allows you to consecutively perform withstand voltage and insulation resistance tests. Withstand voltage test → Insulation resistance test, or Insulation resistance test → withstand voltage test
Program test	[PROG]	Allows you to consecutively perform withstand voltage and insulation resistance tests under various conditions.
BDV measurement	[BDV]	Allows you to measure the start voltage for dielectric breakdown with the test voltage raised automatically during a withstand voltage test.

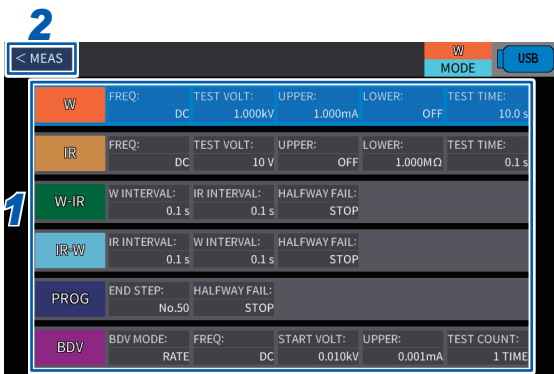

- 1 Select the test mode on the mode selection screen.
- 2 Press [**< MEAS**].

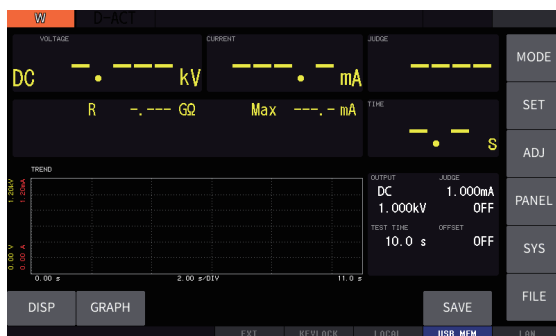

Returns to the measurement screen.



Holding down a test mode button on the mode selection screen opens the setting screen for the selected test mode.

4

Withstand Voltage Test/ Insulation Resistance Test Mode

This chapter describes how to set test conditions, start testing, and make a pass/fail judgment for DC withstand voltage test (DCW) and insulation resistance test (IR).

The test flow is as follows.

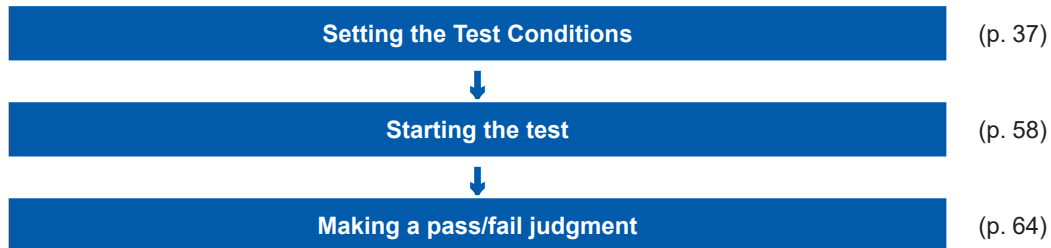

4.1 Setting the Test Conditions

Displaying the setting screen

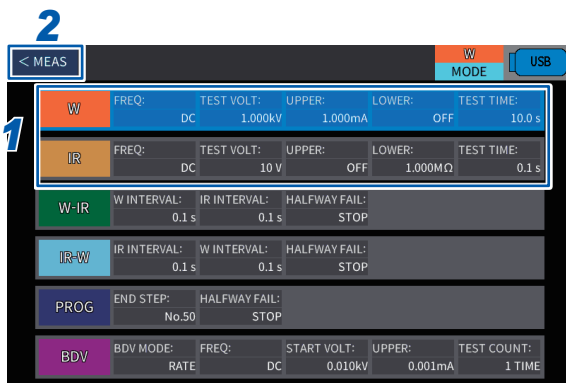

Mode selection screen

- 1 Select [W] or [IR] on the mode selection screen.
- 2 Press [**< MEAS**].

Tips Holding down a test mode button on the mode selection screen opens the setting screen for the selected test mode.

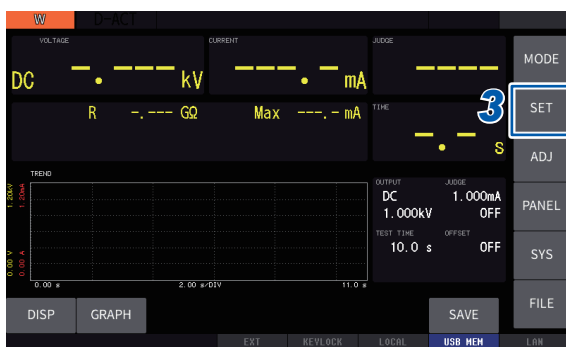

DCW measurement screen

- 3 Press [**SET**].

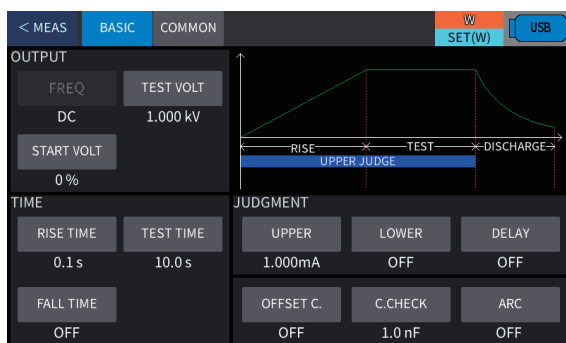

DCW setting screen

Displays various setting screens.

Test conditions

Test conditions that can be set are different for DCW and IR.

Test correspondence table for test conditions

Test conditions	Description	DCW	IR	Reference
Test voltage	Voltage value to be applied to the test target	✓	✓	p. 39
Limit voltage	Upper-limit value for the voltage to be applied to the test target	✓	✓	p. 40
Start voltage	Voltage value after 0.1 seconds from the start of test	✓	–	p. 42
Judgment upper-limit value	Upper-limit judgment reference value of the current or resistance value	✓	✓	p. 43
Judgment lower-limit value	Lower-limit judgment reference value of the current or resistance value	✓	✓	p. 44
Automatic range	The function that switch the range to another according to a measured value	✓	✓	p. 46
Test time	Time period from the elapsed voltage rise time to the end of test	✓	✓	p. 48
Voltage rise time	Time period from the start of test until the test voltage is reached or time period from the start voltage until the test voltage is reached	✓	✓	p. 50
Voltage drop time	Voltage drop time after a pass judgment is made	✓	✓	p. 51
Judgment wait time	Time period from the start of test until a current value upper-limit judgment is started or time period from the start of test until a resistance value lower-limit judgment is started	✓	✓	p. 52
Insulation resistance test end mode	Sets the conditions to end an insulation resistance test.	–	✓	p. 108
Arc detection	Detects the discharge current of arc according to fluctuation of test voltage.	✓	–	p. 54
Contact check	Checks whether the test lead is properly connected to the test target.	✓	✓	p. 105
Offset cancel	Measures the current flowing a stray capacitance, such as a test lead and measurement jig, and cancels the current according to the measurement result.	✓	✓	p. 56

4.2 Setting the Test Voltage

Sets the test voltage. A test voltage value over the limit voltage (p. 40) cannot be set.

DCW setting

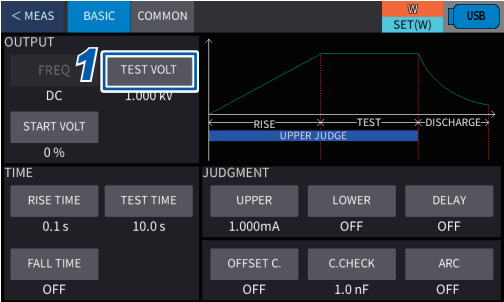

1 Press [BASIC] > [TEST VOLT] on the setting screen.

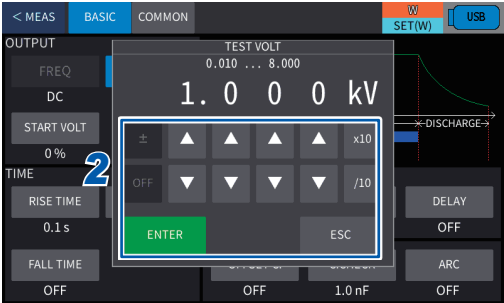

2 Change the value using [▲] or [▼] and then press [ENTER].

0.010 kV to 8.000 kV

Default setting: 0.100 kV

IR setting

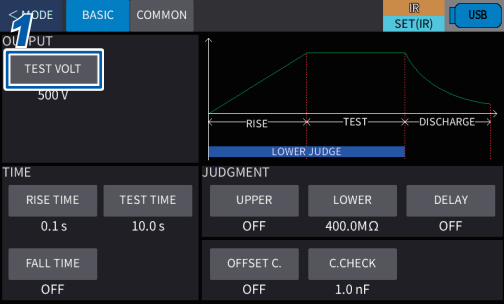

1 Press [BASIC] > [TEST VOLT] on the setting screen.

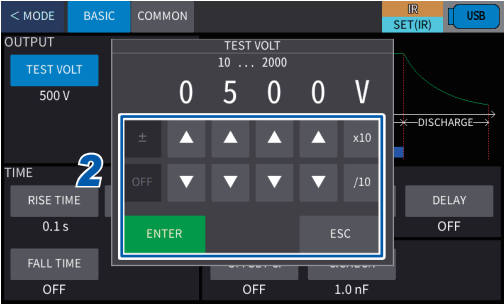

2 Change the value using [▲] or [▼] and then press [ENTER].

10 V to 2000 V

Default setting: 100 V

4

Withstand Voltage Test/Insulation Resistance Test Mode

4.3 Setting the Limit Voltage Value

The upper-limit value for the voltage output from this instrument is set. With the upper-limit value set, accidents due to an incorrect setting, etc. can be prevented.

DCW setting

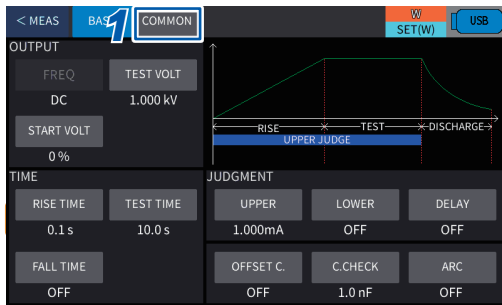

1 Press [COMMON] on the setting screen.

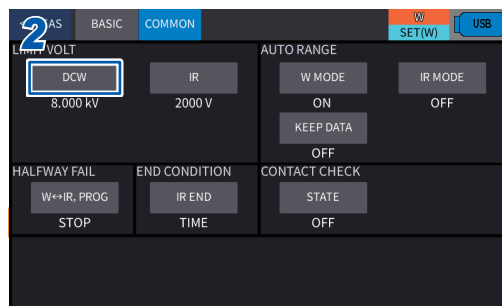

2 Press [DCW].

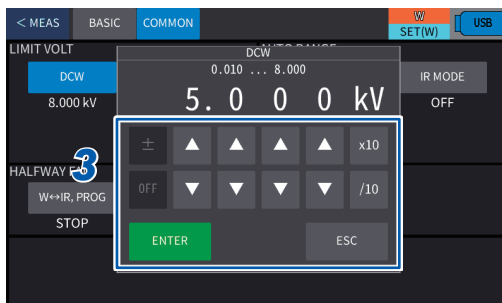

3 Change the value using [▲] or [▼] and then press [ENTER].

0.010 kV to 8.000 kV*1

*1. Default setting

IR setting

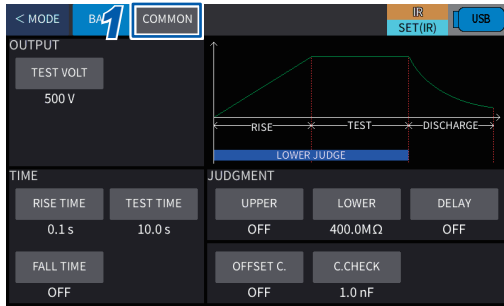

1 Press [COMMON] on the setting screen.

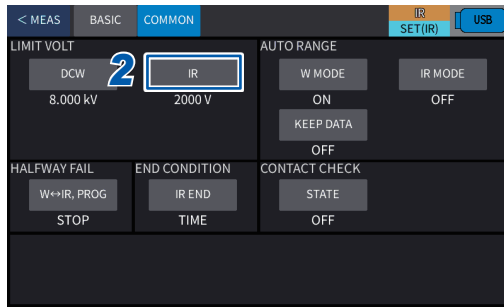

2 Press [IR].

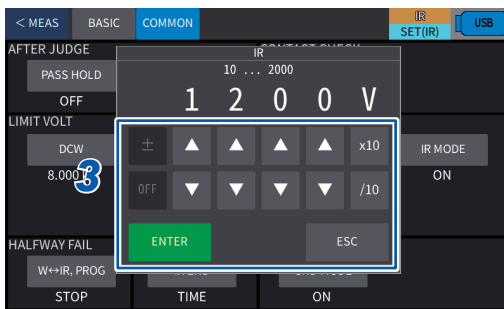

3 Change the value using [▲] or [▼] and then press [ENTER].

10 V to 2000 V*1

*1. Default setting

4

Withstand Voltage Test/Insulation Resistance Test Mode

4.4 Setting the Start Voltage (DCW Only)

The voltage (start voltage) after 0.1 second from the start of a test is set as a percentage of the test voltage.

When the test starts, the test voltage rises linearly to the set start voltage within 0.1 second. Then the output voltage rises linearly to the test voltage within the set voltage rise time (RISE TIME).

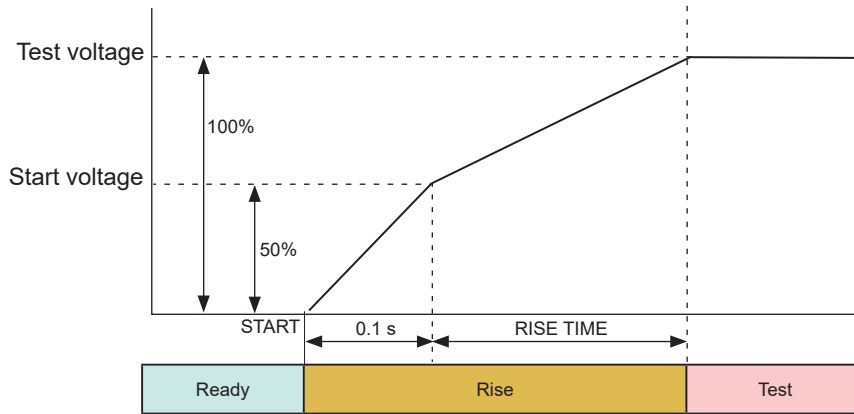

When the start voltage is 50%

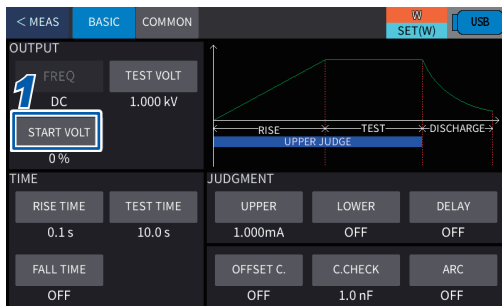

1 Press **[BASIC]** > **[START VOLT]** on the setting screen.

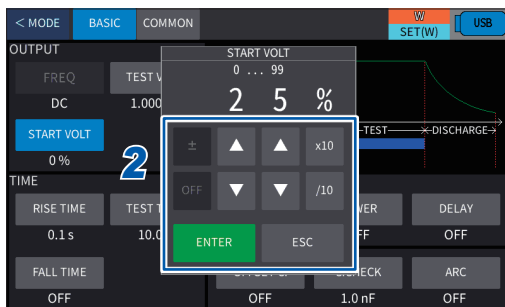

2 Change the value using **[▲]** or **[▼]** and then press **[ENTER]**.

0%*1 to 99%

*1. Default setting

4.5 Setting the Upper-Limit Value for Judgment

The upper limit for the current value or resistance value is set as the reference for pass/fail judgment.

When the measured current value or resistance value exceeds the reference value, a fail judgment is determined for the test target.

If a pass/fail judgment is not to be performed based on the upper-limit value for an IR test, the test upper-limit value can be set to off.

DCW setting

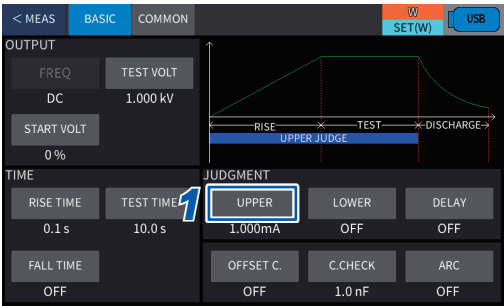

1 Press [BASIC] > [UPPER] on the setting screen.

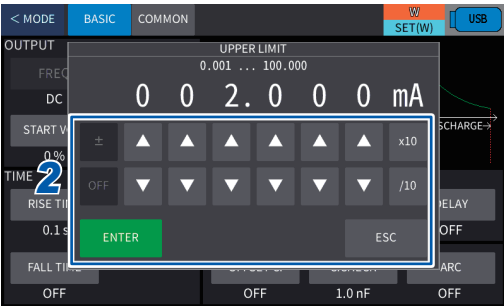

2 Change the value using [▲] or [▼] and then press [ENTER].

0.010 mA to 100 mA

Default setting: 0.011 mA

The lower limit is set by the [LOWER] value for the lower-limit value for judgment.

[LOWER] < [UPPER]

(Only when [STATE] is set to on)

IR setting

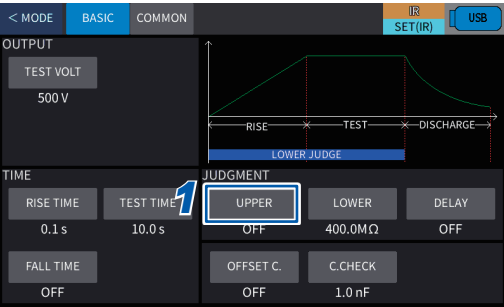

1 Press [BASIC] > [UPPER] on the setting screen.

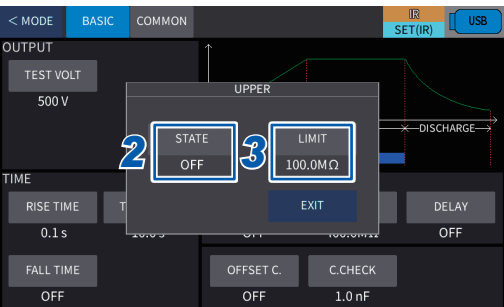

2 Switch [ON] and [OFF] under [STATE].

Default setting: OFF

3 When [ON] is set, press [LIMIT].

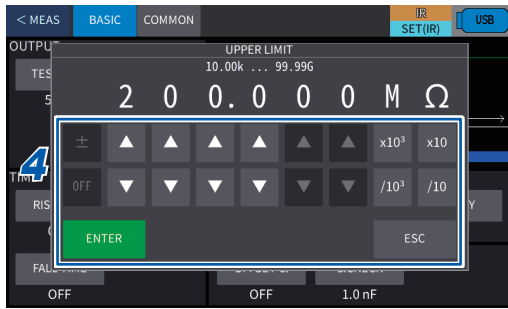

4 Change the value using [**▲**] or [**▼**] and then press [**ENTER**].

10 kΩ to 99.99 GΩ

Default setting: 100 MΩ

The lower limit is set by the [**LOWER**] value for the lower-limit value for judgment.

[**LOWER**] < [**UPPER**]

(Only when [**STATE**] is set to on)

4.6 Setting the Lower-Limit Value for Judgment

The lower-limit for the current value or resistance value is set as the reference for pass/fail judgment.

When the measured current value or resistance value is below the reference value, a fail judgment is determined for the test target.

If a pass/fail judgment is not to be performed based on the lower-limit value for a DCW test, the test lower-limit value can be set to off.

Tips In case of a DCW test, setting a lower-limit value slightly less than the leakage current specific to the test target can be used as a simplified contact check. It is also useful for detecting disconnected test leads and test target problems.

DCW setting

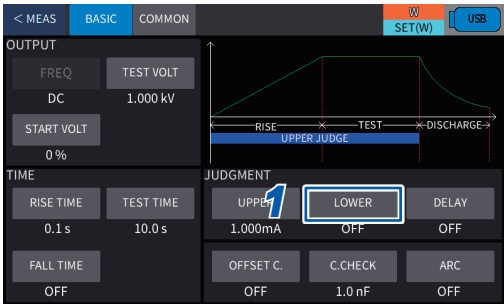

1 Press [BASIC] > [LOWER] on the setting screen.

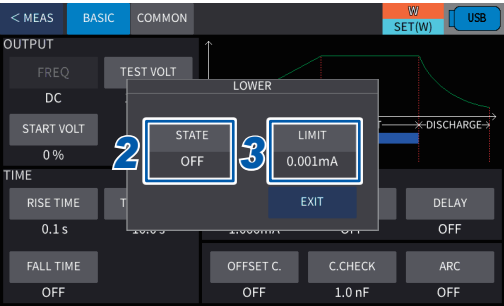

2 Switch [ON] and [OFF] under [STATE].

Default setting: OFF

3 When [ON] is set, press [LIMIT].

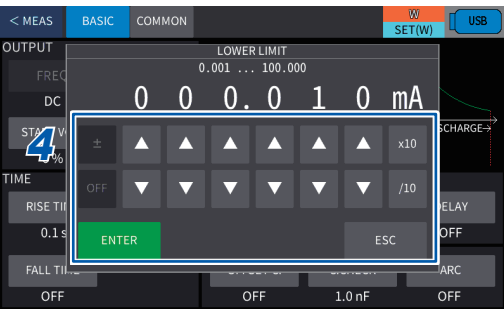

4 Change the value using [▲] or [▼] and then press [ENTER].

0.010 mA*1 to 100 mA

*1. Default setting

The upper limit is set by [UPPER] (upper-limit value for judgment).

[LOWER] < [UPPER]

(Only when [STATE] is set to on)

4

Withstand Voltage Test/Insulation Resistance Test Mode

IR setting

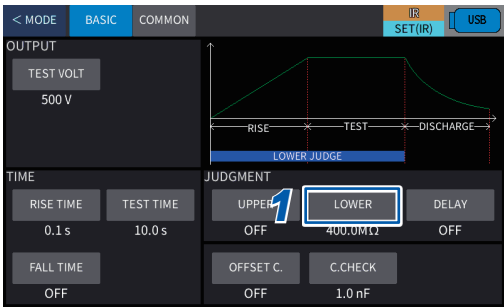

1 Press [BASIC] > [LOWER] on the setting screen.

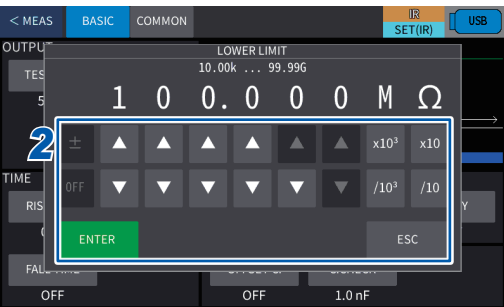

2 Change the value using [▲] or [▼] and then press [ENTER].

10 kΩ to 99.99 GΩ

Default setting: 1 MΩ

The upper limit is set by [UPPER] (upper-limit value for judgment).

[LOWER] < [UPPER]

(Only when [STATE] is set to on)

4.7 Setting the Auto-Range Function

For withstand voltage and insulation resistance tests, the range (measured value display range) is determined based on the test conditions. Any measured values outside the range are not displayed. When the auto-range function is used, the range is automatically switched in accordance with the measured value, and the measured value within the measurable range can always be displayed.

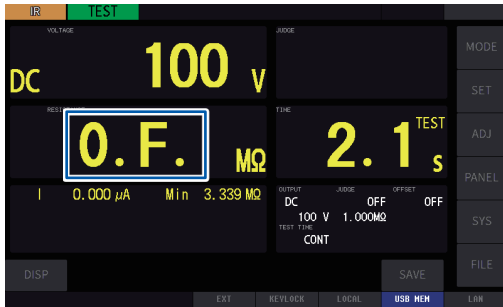

When the measured value is above the range: **[O.F.]** is displayed.

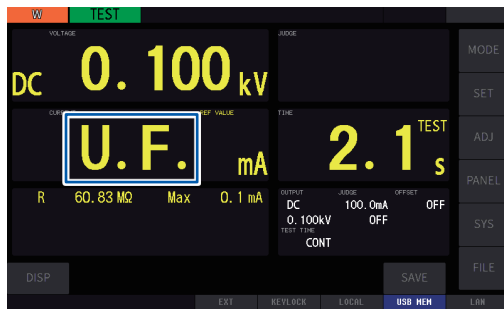

When the measured value is below the range: **[U.F.]** is displayed.

For the range based on the test conditions and the accuracy guarantee range, see “Specifications” (p. 201).

DCW setting

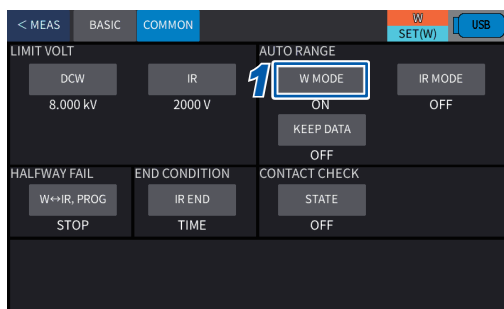

- 1 Press **[COMMON]** > **[W MODE]** on the setting screen.

OFF *1	Disables the auto-range function.
ON	Enables the auto-range function.

*1. Default setting

IR setting

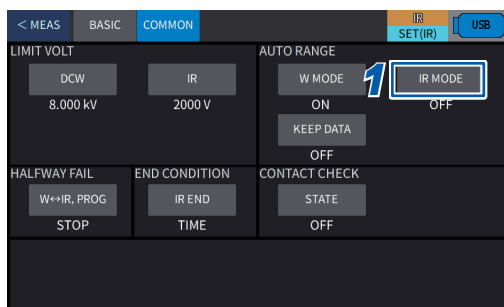

- 1 Press **[COMMON]** > **[IR MODE]** on the setting screen.

OFF *2	Disables the auto-range function.
ON	Enables the auto-range function.

*2. Default setting

IMPORTANT

When the auto-range function switches the range, the waveform data before the range switching is cleared.

4.8 Setting the Data Maintaining Function during Auto-Ranging

The function to maintain the display of the last measured value is set while the range is switched using the auto-range function.

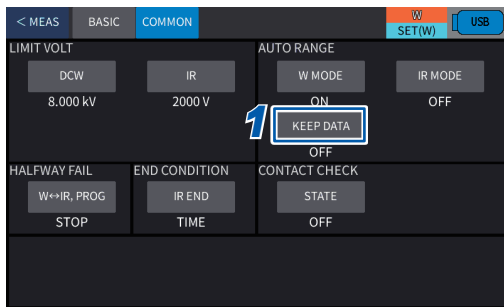

1 Press **[COMMON]** > **[KEEP DATA]** on the setting screen.

OFF *1	Disables the data maintaining function during auto-range.
ON	Enables the data maintaining function during auto-range.

*1. Default setting

IMPORTANT

- When the data maintaining function during auto-ranging is set to off
A pass/fail judgment is not made when the test ends during a range movement.
- When the data maintaining function during auto-ranging is set to on
When the test is completed while the range switches, the pass/fail is judged using the last measured value. Since the measured value (value immediately before a range movement) is displayed, the instrument cannot determine whether a range movement is being performed. For example, even when the insulation resistance value drops due to dielectric breakdown immediately before the test end time during the insulation resistance test, the measured value during dielectric breakdown is not determined if the test ends during the range movement.

4.9 Setting the Test Time

The time period from the elapsed voltage rise time to the end of a test is set. If the upper-limit or lower-limit judgment is not made within the test time, a pass judgment is determined for the test target and the test is automatically ended.

When the test is not to be ended automatically, set the test time to **[CONT]**. When **[CONT]** is set, the test is continued until the **STOP** button is pressed for each test or the following conditions are met.

DCW: fail judgment

IR: Insulation resistance test end mode (p. 108)

IMPORTANT

- A range movement by the auto-range function may take time. The test may end without displaying the measured value if a short test time is set. When the auto-range function is selected, check the time until the measured value is stabilized and set the test time. See “4.7 Setting the Auto-Range Function” (p. 46).
- The measured value may not be stabilized due to environmental influences, such as temperature and humidity. Check the time until the measured value is stabilized and set the test time.
- Depending on the test target, the measured value may change as time passes.
Example: When the ground to ground capacitance is high, the resistance value drops as time passes.
When an improper test time is set, false judgment could occur.

DCW setting

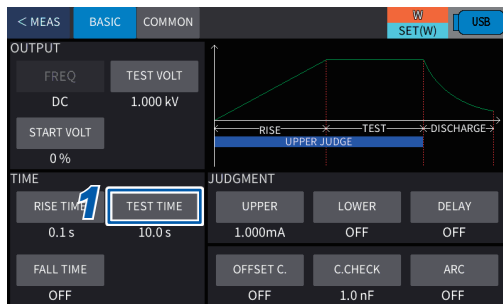

- 1 Press **[BASIC]** > **[TEST TIME]** on the setting screen.

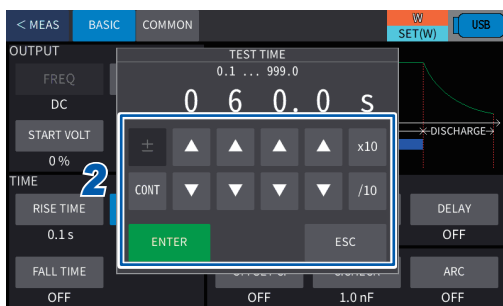

- 2 Change the value using **[▲]** or **[▼]** and then press **[ENTER]**.

0.1 s to 999 s, CONT

Default setting: 1.0 s

The lower limit is set by **[RISE TIME]** (voltage rise time) and **[DELAY]** (judgment wait time).

[DELAY] < [RISE TIME] + [TEST TIME]

(Only when **[DELAY]** is not set to off)

IR setting

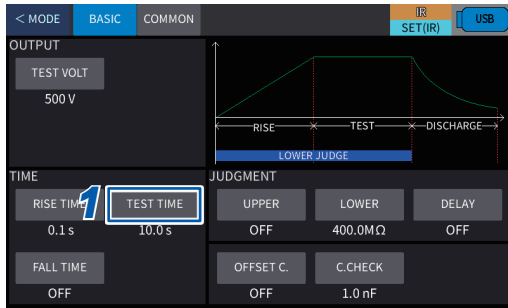

1 Press **[BASIC]** > **[TEST TIME]** on the setting screen.

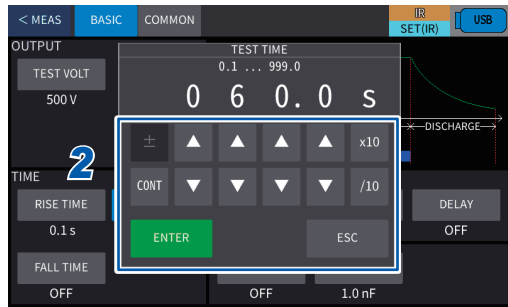

2 Change the value using **[▲]** or **[▼]** and then press **[ENTER]**.

0.1 s to 999 s, CONT

Default setting: 1.0 s

The lower limit is set by **[RISE TIME]** (voltage rise time) and **[DELAY]** (judgment wait time).

[DELAY] < [RISE TIME] + [TEST TIME]

(Only when **[DELAY]** is not set to off)

4

Withstand Voltage Test/Insulation Resistance Test Mode

4.10 Setting the Voltage Rise Time

The time period from the start of a test until the test voltage is reached or from the start voltage until the test voltage is reached can be set.

DCW setting

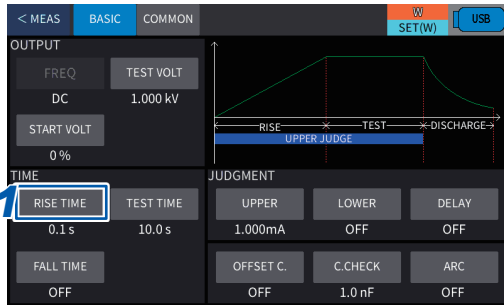

- 1 Press **[BASIC]** > **[RISE TIME]** on the setting screen.

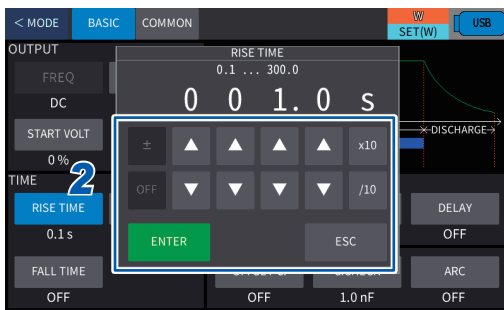

- 2 Change the value using **[▲]** or **[▼]** and then press **[ENTER]**.

0.1 s*1 to 300 s

*1. Default setting

The lower limit is set by **[TEST TIME]** (test time) and **[DELAY]** (judgment wait time).

[DELAY] < [RISE TIME] + [TEST TIME]

(Only when **[DELAY]** is not set to off)

IR setting

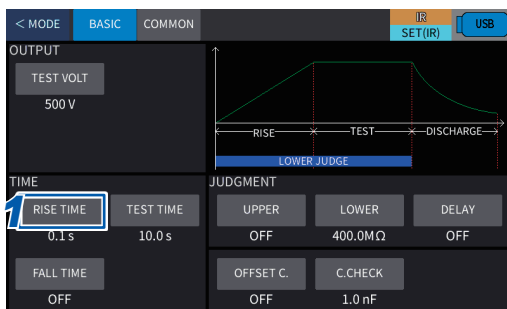

- 1 Press **[BASIC]** > **[RISE TIME]** on the setting screen.



- 2 Change the value using **[▲]** or **[▼]** and then press **[ENTER]**.

0.1 s*2 to 300 s

*2. Default setting

The lower limit is set by **[TEST TIME]** (test time) and **[DELAY]** (judgment wait time).

[DELAY] < [RISE TIME] + [TEST TIME]

(Only when **[DELAY]** is not set to off)

4.11 Setting the Voltage Drop Time

The time period from the end of a test with a pass judgment until the test voltage drops to around 0 V can be set.

When the contact check function is [ON], the voltage drop time cannot be set. (p. 105)

DCW setting

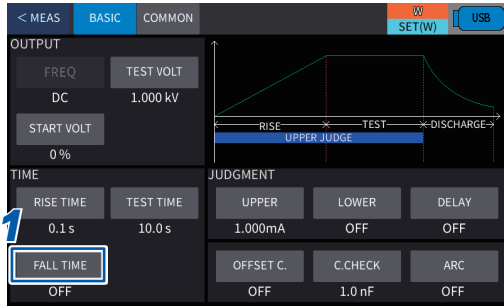

- 1 Press [BASIC] > [FALL TIME] on the setting screen.

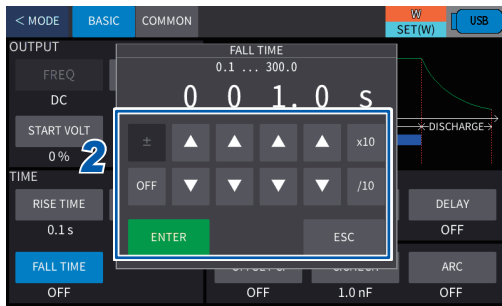

- 2 Change the value using [▲] or [▼] and then press [ENTER].

0.1 s to 300 s, OFF*1

*1. Default setting

IR setting

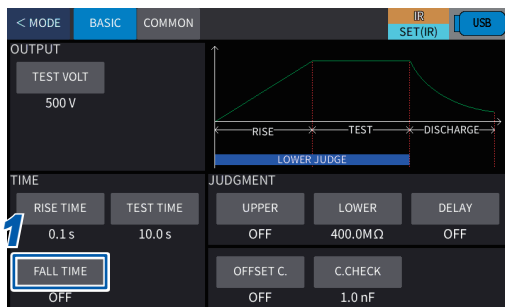

- 1 Press [BASIC] > [FALL TIME] on the setting screen.



- 2 Change the value using [▲] or [▼] and then press [ENTER].

0.1 s to 300 s, OFF*2

*2. Default setting

4.12 Setting the Judgment Wait Time (Delay Time)

When the test voltage is applied to the capacitive test target, a high charging current may flow. Setting the time period for not making the upper-limit judgment (lower-limit judgment for IR test) can prevent false judgment due to the influence of charging current.

DCW setting

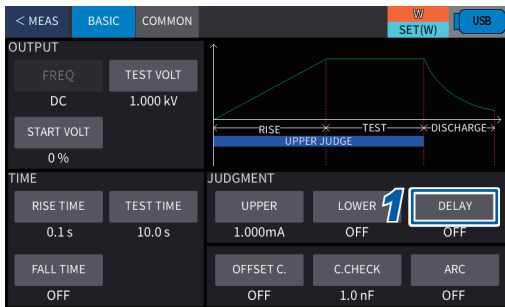

1 Press **[BASIC]** > **[DELAY]** on the setting screen.

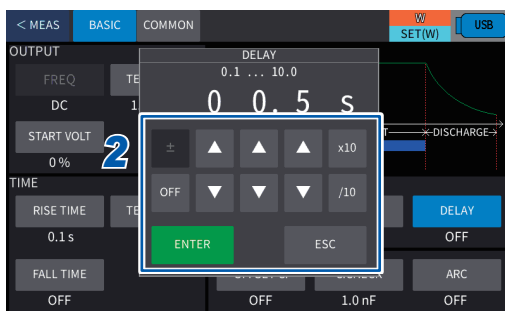

2 Change the value using **[▲]** or **[▼]** and then press **[ENTER]**.

0.1 s to 99.9 s, OFF*1

*1. Default setting

The upper limit is set by **[RISE TIME]** (voltage rise time) and **[TEST TIME]** (test time).

[DELAY] < [RISE TIME] + [TEST TIME]

(Only when **[DELAY]** is not set to off)

IR setting

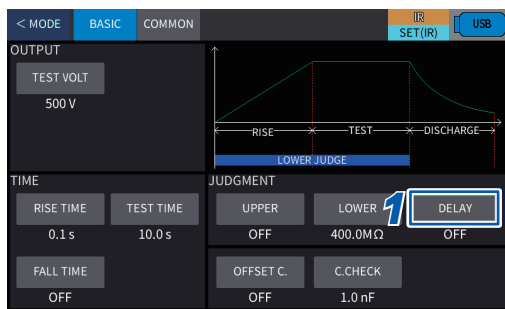

1 Press **[BASIC]** > **[DELAY]** on the setting screen.

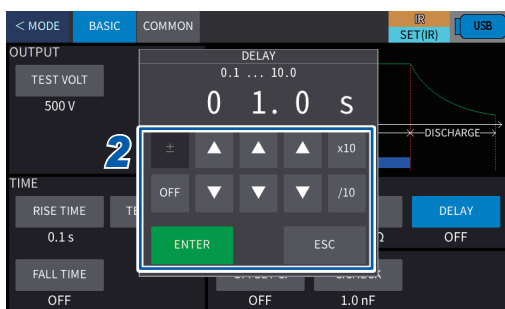

2 Change the value using **[▲]** or **[▼]** and then press **[ENTER]**.

0.1 s to 99.9 s, OFF*2

*2. Default setting

The upper limit is set by **[RISE TIME]** (voltage rise time) and **[TEST TIME]** (test time).

[DELAY] < [RISE TIME] + [TEST TIME]

(Only when **[DELAY]** is not set to off)

DCW test (pass judgment)

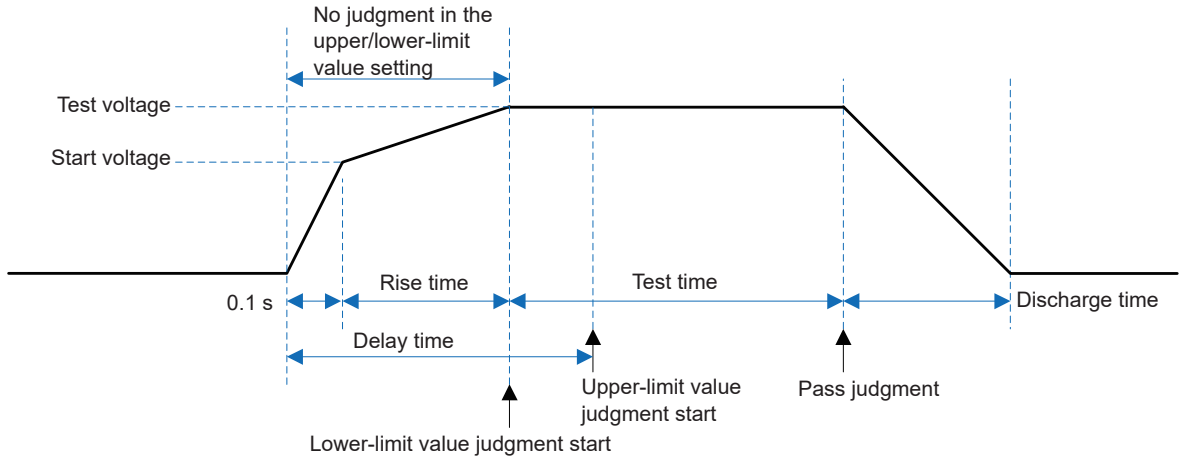

DCW test (fail judgment)

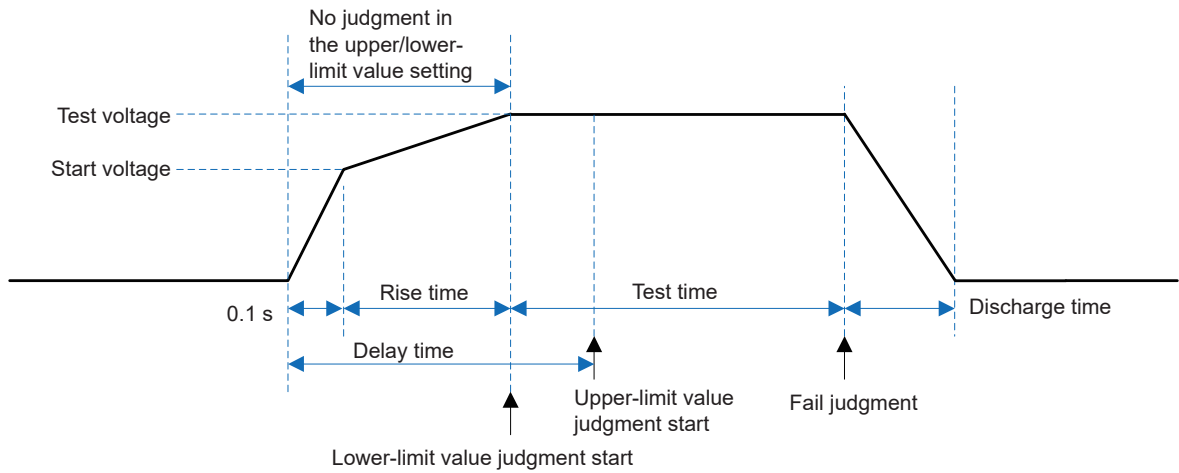

IR test (pass judgment)

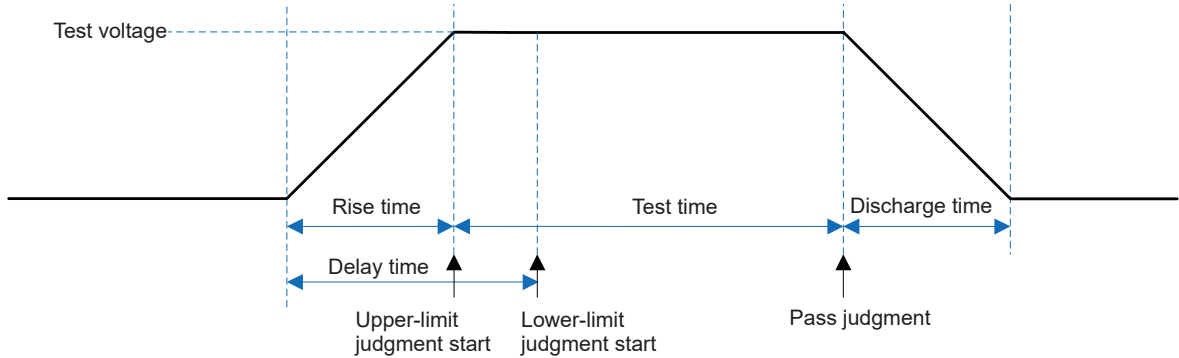

4.13 Setting the Arc Detection (DCW Only)

The arc detection function can detect the fluctuation of the test voltage when a discharge occurs during a test, and the instrument judges it as an arc discharge. Set the ratio of the test voltage fluctuation range as the threshold value.

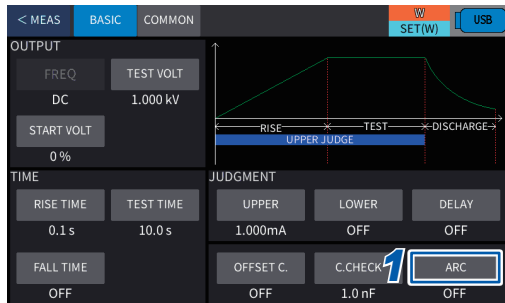

1 Press **[BASIC]** > **[ARC]** on the setting screen.

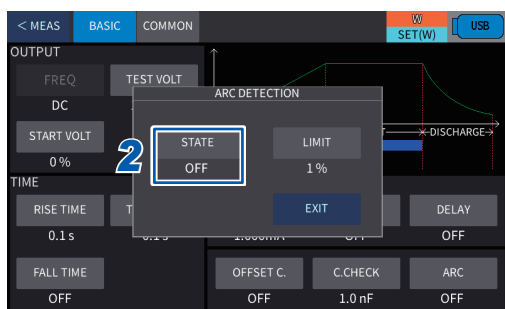

2 Press **[STATE]**.

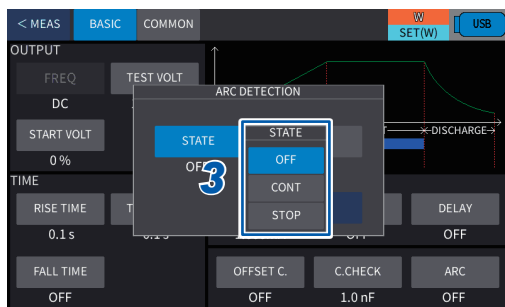

3 Set the arc detection operation mode.

OFF *1	No arc detection
CONT	Detects arc and continues the test.
STOP	Detects arc and stops the test.

*1. Default setting

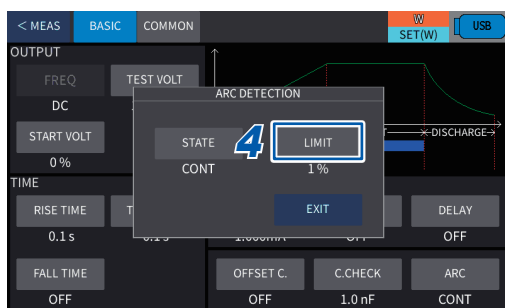

4 When **[STATE]** is set to **[CONT]** or **[STOP]**, press **[LIMIT]**.

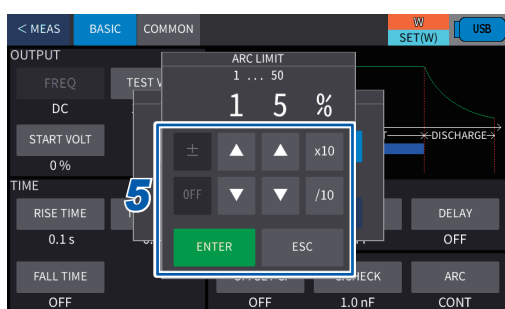

5 Change the value using **[▲]** or **[▼]** and then press **[ENTER]**.

1%*2 to 50%

*2. Default setting

Example of detection of arc (with STOP operation mode)

Test conditions

Test voltage	1.2 kV	
Upper judgment reference value	3 mA	
Arc setting	STATE	STOP
	LIMIT	1%

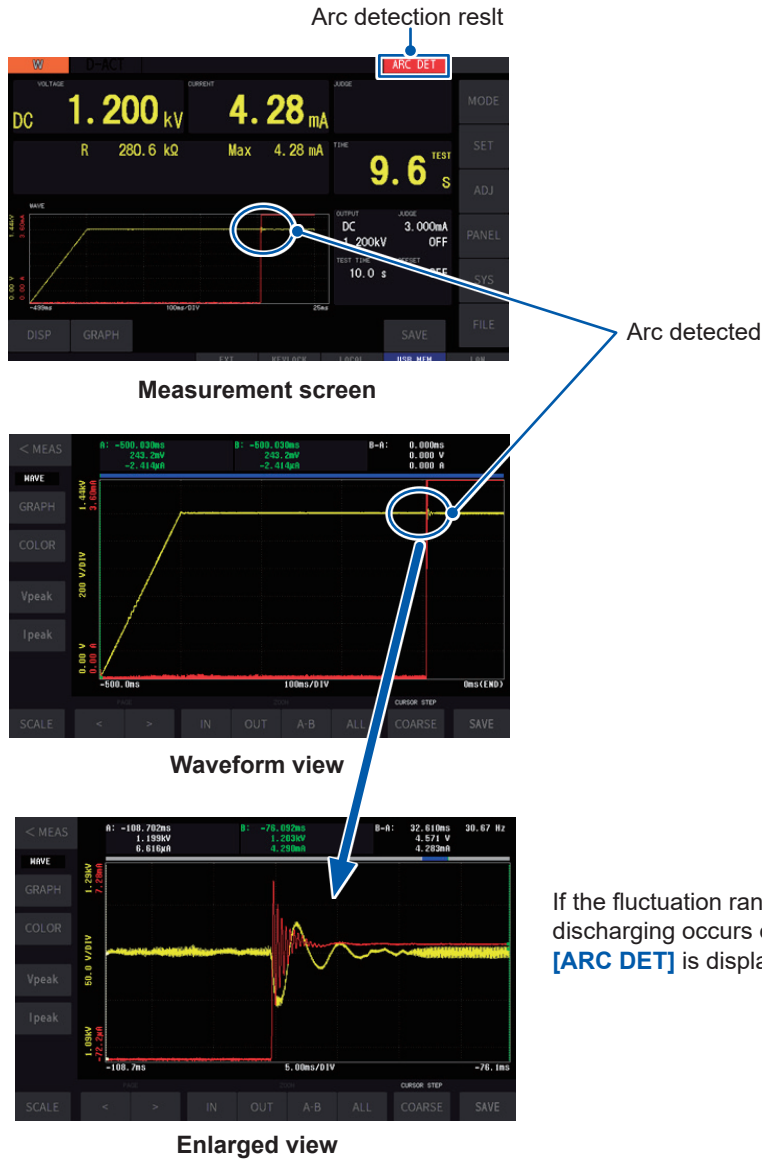

If the fluctuation range of the test voltage when discharging occurs exceeds the set limit value, **[ARC DET]** is displayed, and the test ends.

4.14 Offset Cancel (Open Compensation)

The current that flows when the test lead or jig is open is measured in advance and is subtracted from the test measurement result.

Valid test mode: DCW mode, IR mode, W-IR/IR-W mode, and program mode

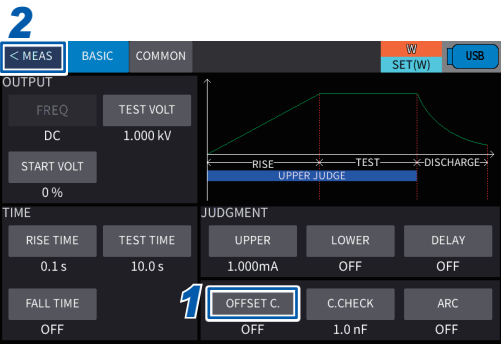

1 On the setting screen, press [**BASIC**] > [**OFFSET C.**] to set the offset cancel function to [**ON**].

The offset cancel function is enabled and [**OFS**] is displayed on the measurement screen during a test.
Default setting: OFF

2 Press [**< MEAS**].



3 Press [**ADJ**].

The set test conditions are displayed on the compensation execution screen.

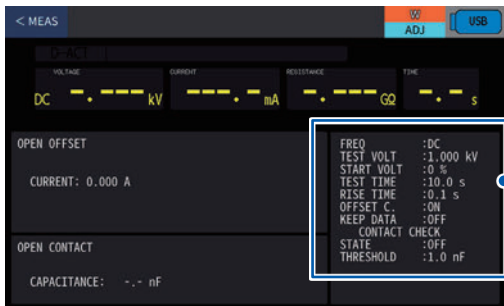

Preset test conditions

- The current compensation values are acquired based on the set test conditions.
- In the W-IR/IR-W mode, a compensation cannot be executed. Execute a compensation in the DCW mode and IR mode.

Acquiring the compensation value

The current compensation value is acquired using the same procedure for starting a normal test with the open circuit without connecting the test target.



- 1 Press **[ADJ]** on the measurement screen and start the test on the compensation execution screen.

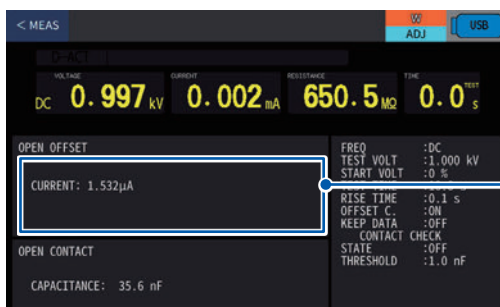

When the test ends, the current compensation values are acquired.

Acquired compensation values

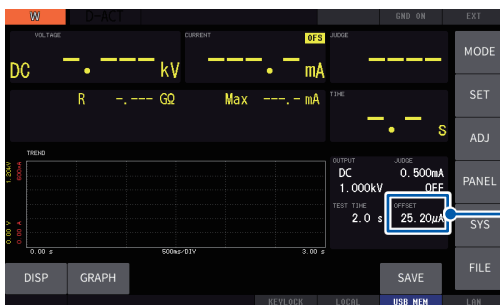

The current compensation values can also be checked on the measurement screen.

Acquired compensation values

- Current compensation values are acquired at the following timings.
 - When the set test time ends
 - When the **STOP** button is pressed halfway
- When the test time is set to **[CONT]**, press the **STOP** button to acquire the current compensation values once the measured value is stabilized.
- Even if the instrument is turned off, the acquired current compensation values are backed up.

IMPORTANT

- If the test voltage is changed in DCW or IR mode, the correction value is initialized and the offset cancel function is turned off. If you change the test voltage, acquire the correction value again.
- A current of up to 10 mA can be compensated. If a current exceeding the compensation range is detected, a compensation failure error (ADJUST FAILED) occurs. Depending on the test conditions, the test may be interrupted without waiting for the test time to elapse. When the test is interrupted, the correction value cannot be acquired (except when the **STOP** button is pressed during the test).

4.15 Starting and Ending a Test

Output voltage time rating

⚠ CAUTION

- Use the instrument within the time rating in the table below.

When the instrument is to be used consecutively, the output time is limited by the test voltage. The maximum test time and standby time vary depending on the test voltage. If the instrument is used over the time rating, it could be damaged due to heating.

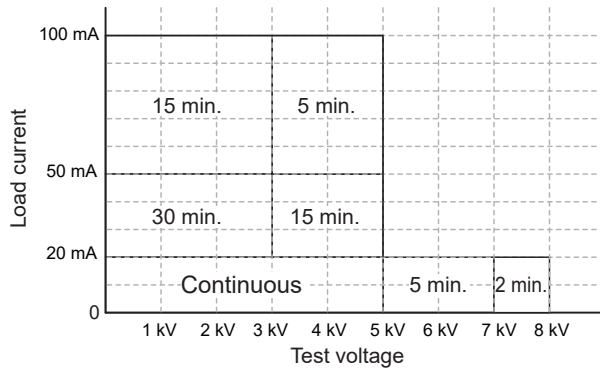

DC withstand voltage test mode

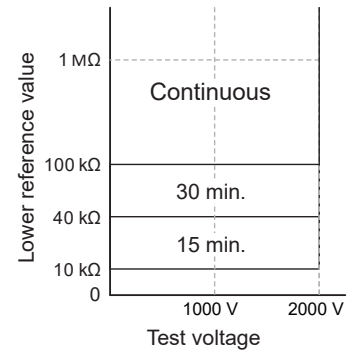

Insulation resistance test mode

If a test continues for the maximum test time, leave the instrument for 30 minutes.

Starting a test

The two-stage operation using the **STOP** button and **START** button avoids unnecessary output and allows a test to start safely (double action function).

⚠ WARNING

- **Do not touch the test lead during a withstand voltage withstand voltage test or insulation resistance test.**

A hazardous voltage is applied to the measurement terminals during the test. Doing so could cause the operator to experience an electric shock.



- **Do not touch the metal area to which a voltage is applied until the **DANGER** lamp turns off.**

After the test ends, the test voltage may still remain in the test target. Touching the metal areas with the voltage applied may cause electric shock accidents.

- **Do not measure the insulation resistance under the live-line condition.**

Doing so could damage the instrument, resulting in bodily injury. Turn off the test target before starting measurement.

1 Make sure that the instrument and test target are properly connected.

2 Press the **STOP** button.

[READY] is displayed for approximately 0.5 seconds at the upper left of the display area.

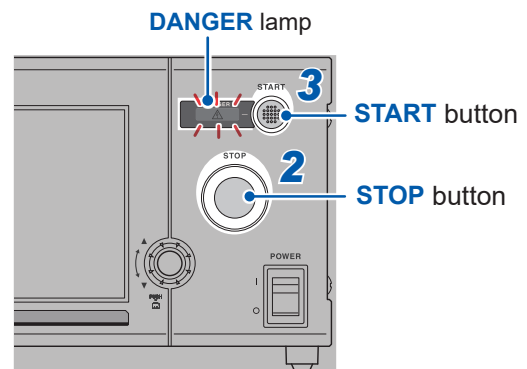

Front

3 Press the **START** button while [READY] is displayed.

The **DANGER** lamp lights up and the instrument is in the TEST mode (p. 61) and ready for starting the test.



If the test does not start, see “Frequently Asked Questions” (p. 221).

The test ends and **[VOLTAGE ERROR]** is displayed in the following cases.

- When the output voltage does not reach $\pm 5\%$ of the set test voltage
- When the voltage deviates from the set test voltage (± 10 dgt) during the test and does not fall within ± 10 dgt of the set voltage within 5 seconds

When the test is to be forcefully terminated

Press the **STOP** button to stop the voltage output. In this case, a pass/fail judgment is not made.

Operations during a test

The following is an example of the operation after a test starts.

DCW test (pass judgment)

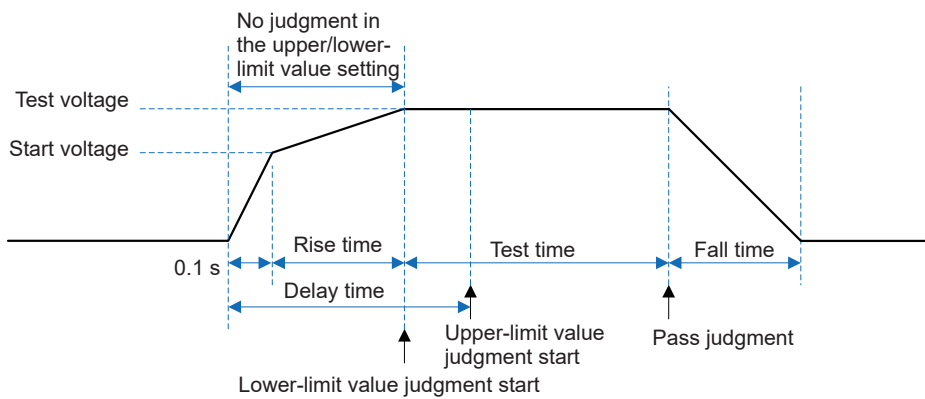

DCW test (fail judgment)

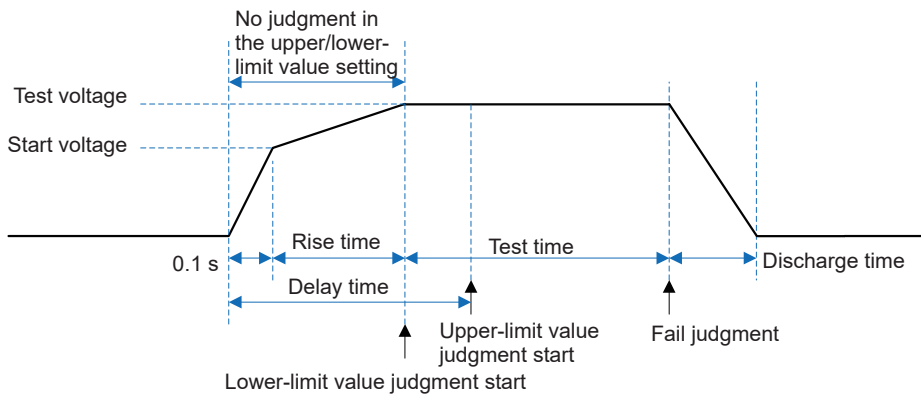

IR test (pass judgment)

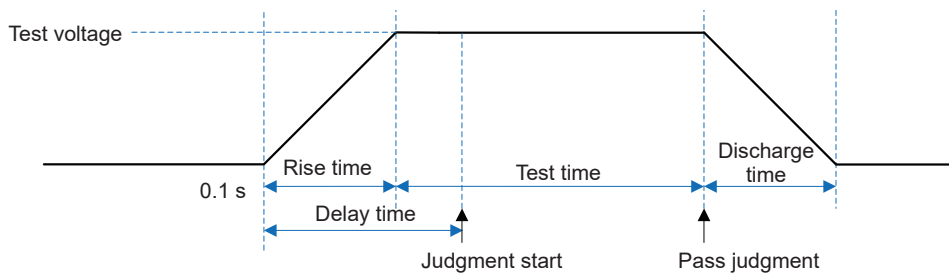

Screen display in the TEST mode

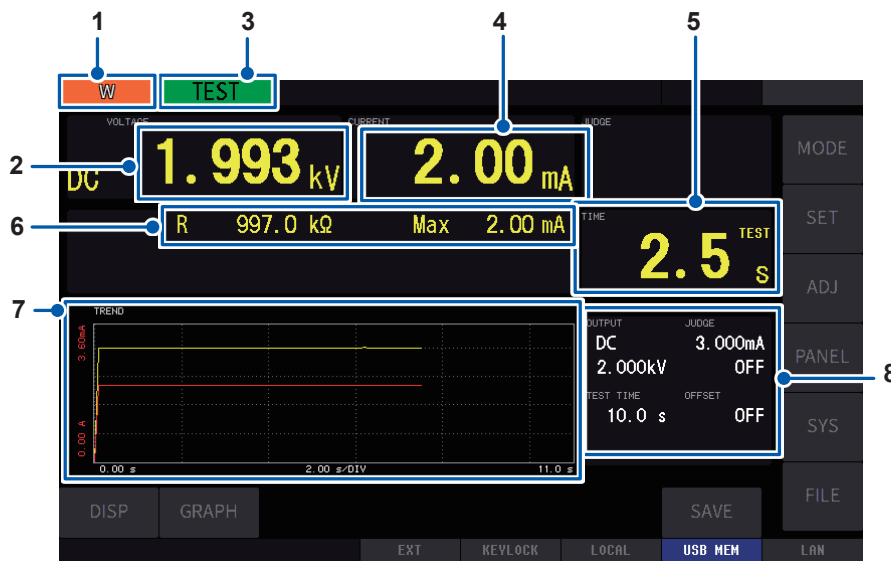

The screen shown above is displayed when **[DISP]** is set to **[NUM+GRAPH]**.

For information on how to switch the measurement screen, see “8.1 Waveform Graph Display” (p. 101).

For DCW

1	Test mode	Displays the test mode.
2	Voltage measured value	Displays the output voltage value.
3	TEST	Displayed during a test. When the output voltage does not reach the set test voltage during the test, [RISE] continues to be displayed.
4	Current measured value	Displays the value of the current flowing between the voltage output HIGH terminal and LOW terminal.
5	Test time	<ul style="list-style-type: none"> Displays the remaining time that counts down from the set test time when the test time is set. Displays the elapsed time since the start of a test when the test time is set to [CONT]. When the elapsed test time exceeds 9999 seconds, [--- is displayed.
6	Resistance Maximum current value	Displays the resistance value of the test target and maximum value of the measured current value during a test. The resistance value is calculated from the measured voltage value and measured current value.
7	Waveform and graph	Displays the applied voltage waveform of when the test target fails a test. In addition, the measured voltage, current, and resistance values are displayed in chronological order.
8	Test conditions	Displays the test conditions. [OUTPUT] : DC, test voltage [JUDGE] : Upper- and lower-limit values for judgment [TEST TIME] : Test time [OFFSET] : Compensation value

For IR

4	Measured resistance value	Displays the measured resistance value.
6	Current value Minimum resistance value	Displays the current value and minimum value of the measured resistance value during a test.

DANGER lamp

This is the lamp indicating a voltage is being output. It lights up during a test (including the voltage rise time and voltage drop time). This lamp lights up if a voltage over the safe voltage (approx. 0.06 kV DC) remains in the output terminal even after the test ends.

External I/O

- The TEST signal is turned on at the same time when the [TEST] display lights up. In addition, the H.V.ON signal is also turned on at the same time when the DANGER lamp lights up.
- The TEST signal and H.V.ON signal are turned off at the same time when the [TEST] display and the DANGER lamp is turned off.

Stopping a test

When stopping the test forcefully or ending the test when the test time is set to **[CONT]**, press the **STOP** button. A pass/fail judgment is not made at this time.

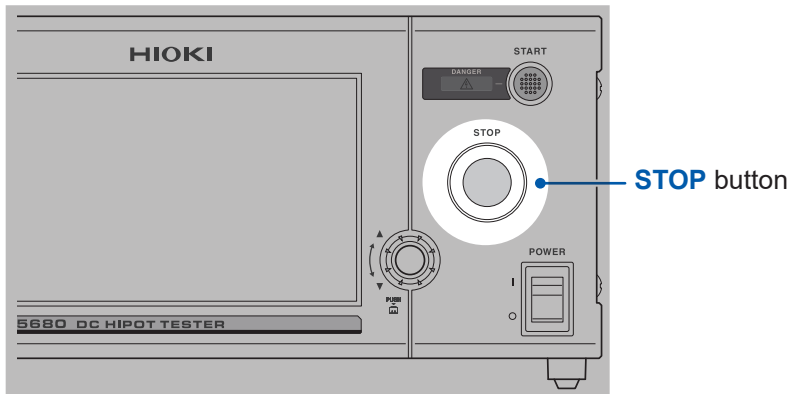

Front

Ending a test

The test ends in the following cases.

- (1) When a current over the upper-limit judgment reference value or below the lower-limit judgment reference value is detected
- (2) When the test time is not set to **[CONT]** and the test time has elapsed
- (3) When the **STOP** button is pressed

When the test ends, **[TEST]** in the display area turns off.

When the output terminals are discharged and the residual voltage in the output terminals becomes zero, the **DANGER** lamp turns off.

If the test ends in (1) and (2) above, the judgment result is displayed in the display area.

IMPORTANT

If the time setting (such as the test time **[TEST TIME]**, voltage rise time **[RISE TIME]**, voltage fall time **[FALL TIME]**, interval time **[INTERVAL]**, delay time **[DELAY]**) is set to the shortest time, and the test is repeated at the fastest time, the display of the screen may be delayed from the actual measurement. If the screen display is delayed, set a longer time.

4.16 Making a Pass/Fail Judgment

Judgment type and operation

When the test ends, the judgment result is displayed in the display area.



	UPPER FAIL	LOWER FAIL	PASS
Condition	A current over the upper-limit judgment reference value is detected. (measured value) > (upper judgement reference value)	A current below the lower-limit judgment reference value is detected. (measured value) < (lower judgement reference value)	After the test time has elapsed, the following two conditions are satisfied: (1) (upper judgment reference value) ≥ (measured value) ≥ (lower judgment reference value) and (2) no contact check error
Display	[UPPER FAIL] is displayed on the screen.	[LOWER FAIL] is displayed on the screen.	[PASS] is displayed on the screen.
Buzzer	For approx. 1 s.	For approx. 1 s.	For approx. 0.05 s.
External I/O	The U_FAIL signal is output.	The L_FAIL signal is output.	The PASS signal is output.
	Contact check error	No judgment	
Condition	Capacitance below the threshold has been detected in a contact check.	The test was terminated during range switching by the auto range function.	
Display	[UPPER LOWER FAIL] is displayed on the screen.		
Buzzer	For approx. 1 s.		
External I/O	The U_FAIL, L_FAIL, and CONT_ERR signals are output.	The U_FAIL and L_FAIL signals are output.	

If some settings and readings satisfy the following requirements, an UPPER LOWER FAIL judgment will be given.

Withstand voltage testing mode

Judgment upper value	Judgment lower value	Measured current value	Magnitude relationship	Judgment result
Inside accuracy guarantee range	Outside accuracy guarantee range	Below lower accuracy guarantee limit	(measured current value) < (lower judgment limit value) < (upper judgment limit value)	UPPER LOWER FAIL
			(upper judgment limit) ≤ (current measured value) ≤ (upper judgment limit)	

Insulation resistance testing mode

Judgment upper value	Judgment lower value	Measured resistance value	Magnitude relationship	Judgment result
Outside accuracy guarantee range	Inside accuracy guarantee range	Over upper accuracy guarantee limit	(upper judgment limit) < (current measured value) < (upper judgment limit)	UPPER LOWER FAIL
			(upper judgment limit) < (current measured value) ≤ (upper judgment limit)	

4.17 Automatic Discharge Function

This function automatically switches the discharge circuit to discharge the internal circuit after each test.

DANGER

- **Until the **DANGER** lamp turns off, never touch the voltage output terminals, test lead, and test target.**



When a withstand voltage test or insulation resistance test is performed for the test target containing capacitive components, these areas remain charged, which could cause serious bodily injury.

This instrument releases residual electric charge after each test and discharges these areas (Discharge resistance: 700 kΩ).

- The **DANGER** lamp is lit during discharge.
- When the voltage between output terminals falls below the safe voltage (approx. 60 V DC), the **DANGER** lamp turns off.
- The larger the capacitance is, the longer the discharge takes.

5

W-IR/IR-W Test Mode

The W-IR/IR-W test is a function to consecutively perform one preset condition each for a withstand voltage test (DCW) and insulation resistance test (IR). The following two test modes are available.

[W-IR] mode

A withstand voltage test and then an insulation resistance test are performed in that order.

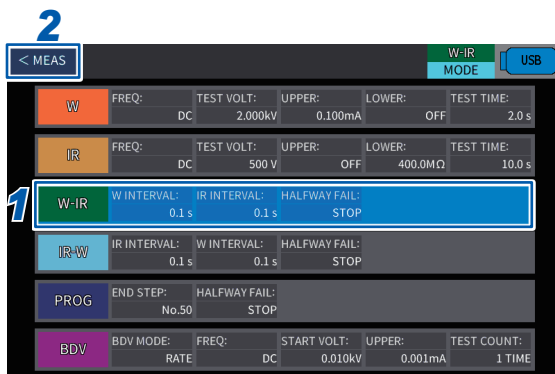

- 1 Select [W-IR] on the mode screen.
- 2 Press [< MEAS].

[IR-W] mode

An insulation resistance test and then a withstand voltage test are performed in that order.

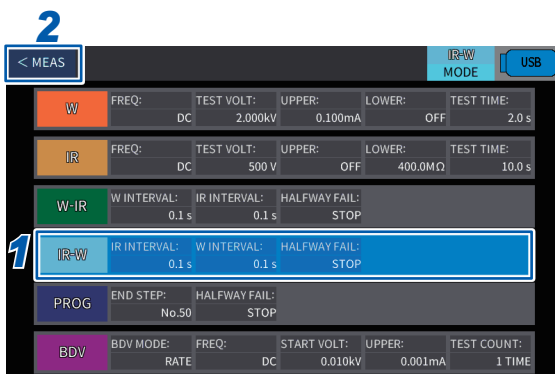

- 1 Select [IR-W] on the mode screen.
- 2 Press [< MEAS].

5.1 Setting the Test Conditions

Displaying the setting screen

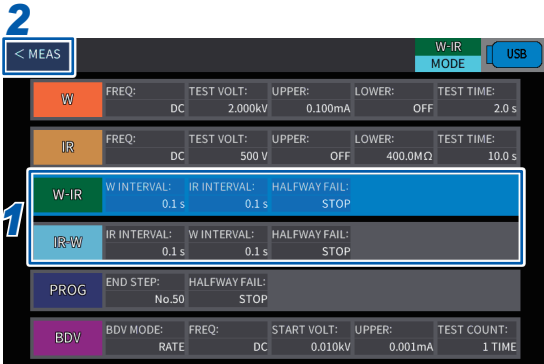

1 Select **[W-IR]** or **[IR-W]** on the mode selection screen.

2 Press **[< MEAS]**.

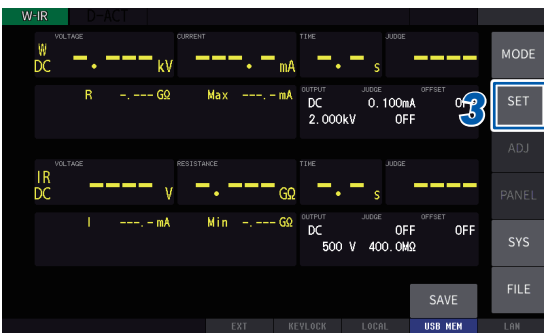

3 Press **[SET]**.

Displays various setting screens.

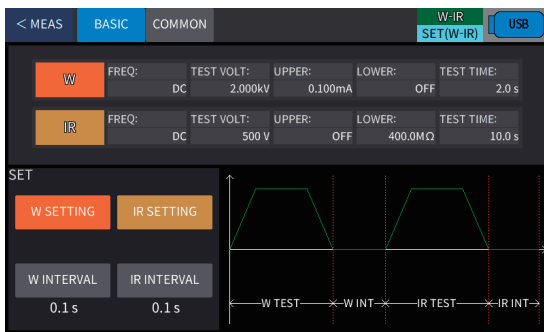

Test conditions

The current test conditions in the W-IR test mode and IR-W test mode can be checked on the setting screen.

When changing the withstand voltage test and insulation resistance test settings, press **[W SETTING]** or **[IR Setting]** and change the settings on each setting screen.

For details about the display information and the setting procedure, see “4.1 Setting the Test Conditions” (p. 37).

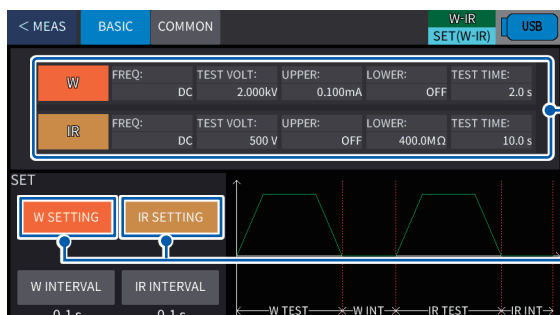

The current test conditions set in the withstand voltage test mode and insulation resistance test mode are displayed.

Changing test settings
Press one of the buttons to change the setting on the setting screen.

5.2 Setting the Interval Time

Set the interval time for withstand voltage test and insulation resistance test.

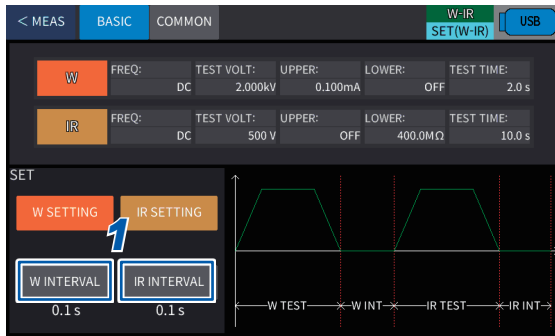

- 1 Press **[BASIC]** > **[W INTERVAL]** or **[IR INTERVAL]** on the setting screen.

[W INTERVAL] Sets the interval time for a withstand voltage test.

[IR INTERVAL] Sets the interval time for an insulation resistance test.

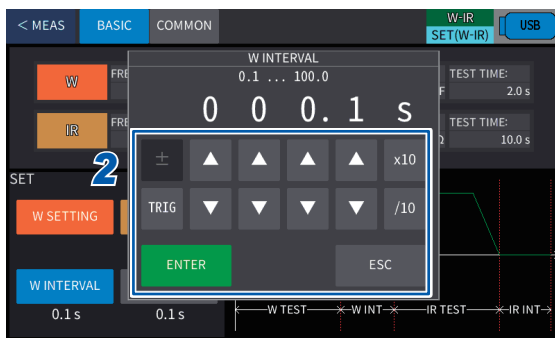

- 2 Change the value using **[▲]** or **[▼]** and then press **[ENTER]**.

0.1 s^{*1} to 100.0 s, TRIG

*1. Default setting

When **[TRIG]** is set, the trigger operation is performed. Pressing the **START** button proceeds to the next step.

5

W-IR/IR-W Test Mode

5.3 Operations for Fail Judgment

The operations when a fail judgment is determined for the test target after the first test in the [W-IR] mode or [IR-W] mode are set.

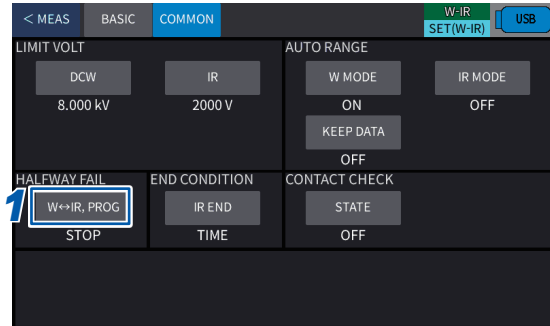

1 Press [COMMON] > [W↔IR, PROG] on the setting screen.

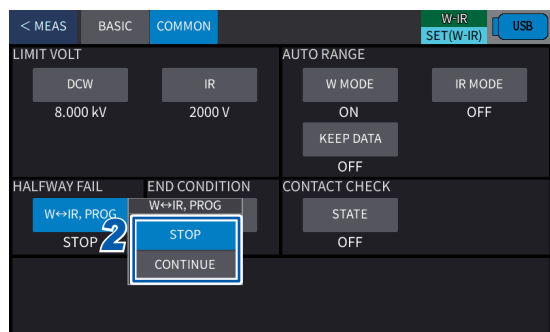

2 Select the setting.

STOP *1	Ends all tests when a fail judgment is determined for the test target after the first test.
CONTINUE	Continues the next test even when a fail judgment is determined for the test target after the first test.

*1. Default setting

5.4 Starting and Ending a Test

Starting a test

See “Starting a test” (p. 59).

Stopping a test

See “Stopping a test” (p. 63).

Ending a test

See “Ending a test” (p. 63).

5.5 Making a pass/fail Judgment

Judgment type and operation

See “Judgment type and operation” (p. 64).

When the test ends, the judgment result is displayed in the display area.



5.6 Automatic Discharge Function

See "4.17 Automatic Discharge Function" (p. 66).

6 Program Mode

The program mode is a function to automatically execute withstand voltage (DCW) and insulation resistance (IR) tests combined.

Up to 50 patterns of tests may be combined.

6.1 Setting the Test Conditions

Displaying the setting screen

2

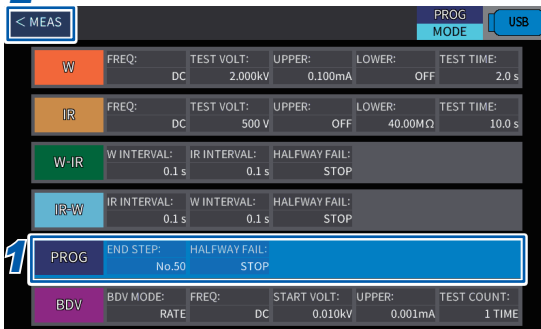

1 Select [PROG] on the mode screen.

2 Press [< MEAS].

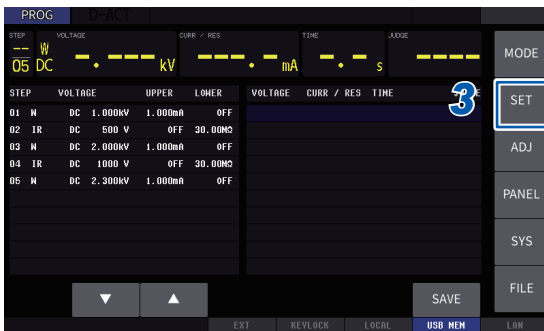

3 Press [SET].

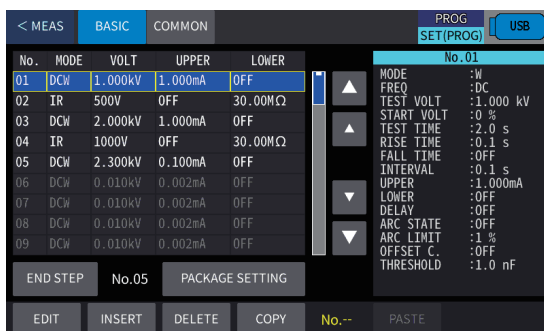

Displays various setting screens.

Setting the number of steps

The number of tests (number of steps) are set for DCW and IR tests.

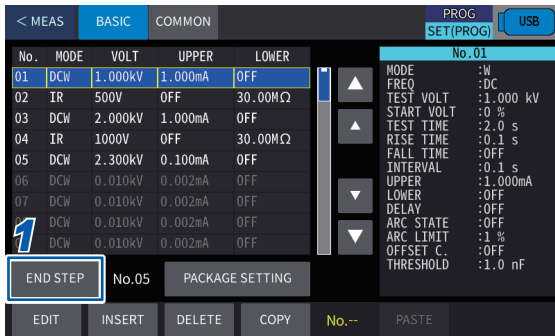

- 1 Press **[BASIC]** > **[END STEP]** on the setting screen.



- 2 Change the value using **[▲]** or **[▼]** and then press **[ENTER]**.

1 to 50*¹

*1. Default setting

Editing test conditions of each step

- 1 Press **[BASIC]** on the setting screen.
- 2 Select the step to be edited, and press **[EDIT]**.

Displays the test conditions of each step.

Scroll bar and scroll key



Press this button to switch the test mode.

The setting screen of the selected step is displayed.

For details about the settings of test conditions and the setting procedure, see “4.1 Setting the Test Conditions” (p. 37).

Editing all test conditions together

Some test conditions of all DCW and IR tests are edited together.

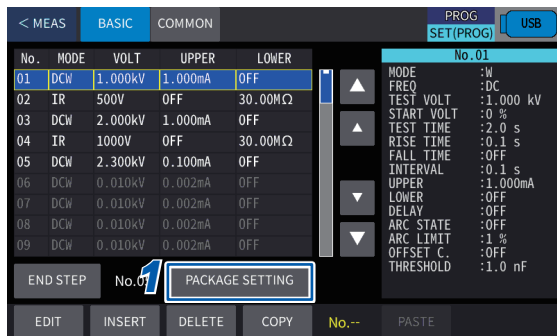

1 Press **[BASIC]** > **[PACKAGE SETTING]** on the setting screen.

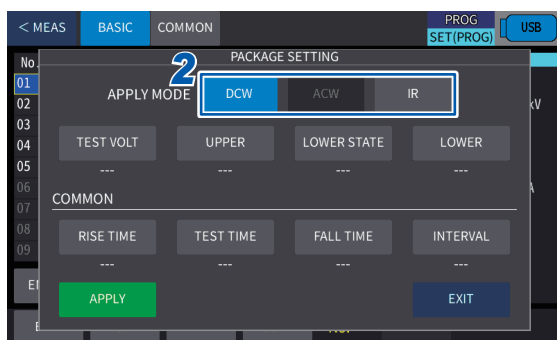

2 Select the test mode to be edited together by **APPLY MODE**.

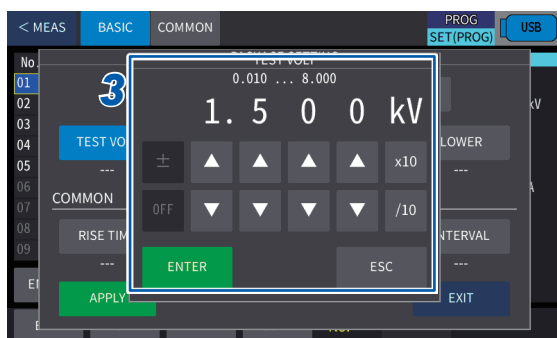

3 Set the test conditions to be edited together.

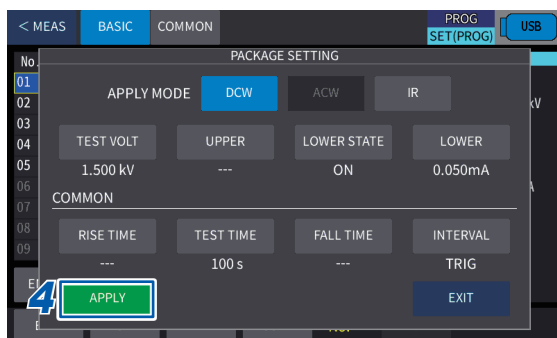

4 Press **[APPLY]**.

The settings with **[---]** cannot be edited.

IMPORTANT

Combinations that are generally not set can be set because other setting values are not considered in batch editing.

[LOWER] >= [UPPER]

or

[DELAY] >= [RIST TIME] + [TEST TIME]

If a set of steps for a combination that cannot be set, the test cannot be started.

Inserting a step

A new step is inserted between existing steps.

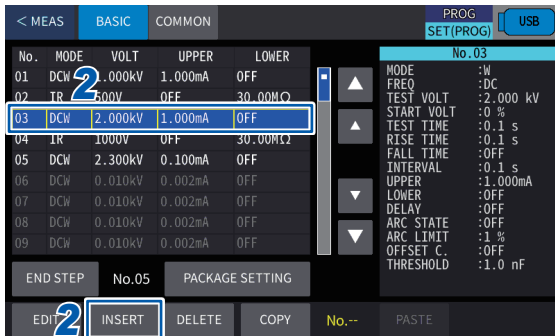

- 1 Press **[BASIC]** on the setting screen.
- 2 Select the step at which a new step is to be inserted and press **[INSERT]**.

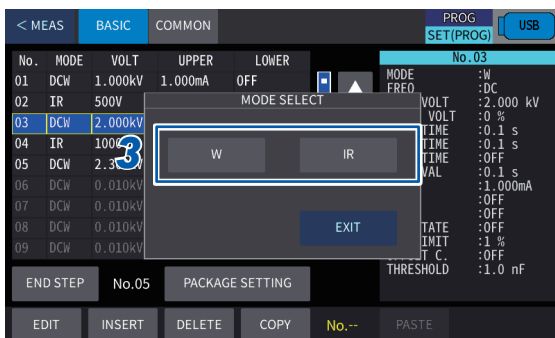

- 3 Select the test mode of the step to be inserted.
When the step is inserted, the edit screen of the test conditions for the inserted step is displayed.
When the step is inserted, the existing No. 50 (50th step) setting is deleted.

Deleting a step

A selected step is deleted.

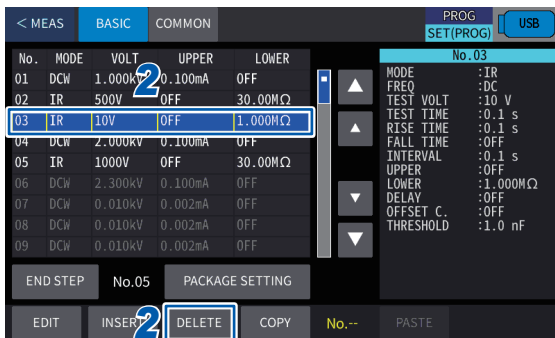

- 1 Press **[BASIC]** on the setting screen.
- 2 Select the step to be deleted, and press **[DELETE]**.

A confirmation message is displayed.

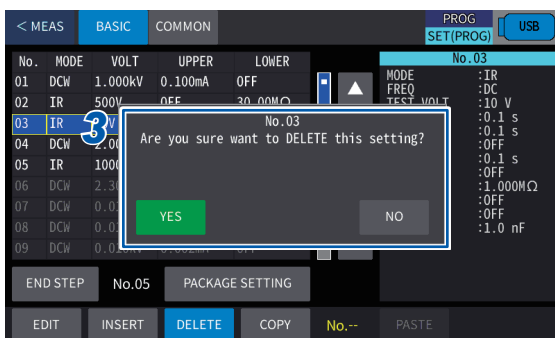

- 3 Confirm the step to be deleted, and press **[YES]**.

When the step is deleted, the DCW test default step is added to the existing No. 50 (50th step) setting.

Copying and pasting a step

A step is copied and pasted to another step.

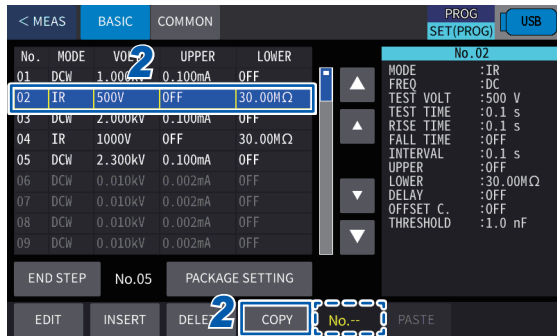

- 1 Press **[BASIC]** on the setting screen.
- 2 Select the step to be copied, and press **[COPY]**.
The selected step is displayed in **[No.--]** on the right side of **[COPY]**.
Copying the same step with the step copied deletes the number of the copied step.



- 3 Press **[PASTE]**.

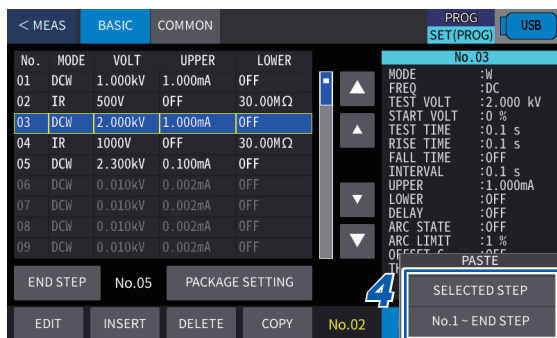

- 4 Select the range of the step or steps to which the new step is pasted.

SELECTED STEP	Pastes a new step to the selected step.
No.1 to END STEP	Paste a step to the No. 01 step to the final step (END STEP).

A confirmation message is displayed.



- 5 Confirm the range of the step or steps to which the new step is pasted and press **[YES]**.

6.2 Setting the Interval Time Between Steps

The interval time between steps is set.

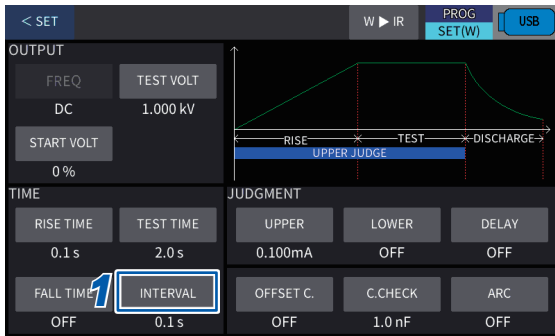

- 1 Press **[BASIC]** > **[EDIT]** > **[INTERVAL]** on the setting screen.

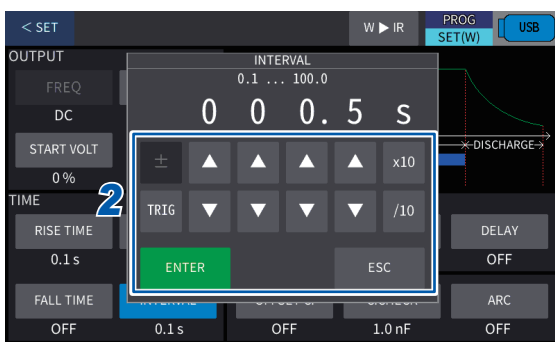

- 2 Change the value using **[▲]** or **[▼]** and then press **[ENTER]**.

0.1 s*1 to 100.0 s, TRIG

*1. Default setting

When **[TRIG]** is set, TRIG operation is performed. Press the **START** button to proceed to the next step.

6.3 Operations for Fail Judgment

The operations when a fail judgment is determined for the test target in the middle of a program test are set.

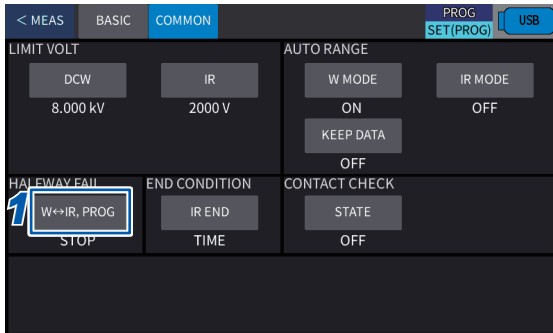

1 Press [COMMON] > [W↔IR, PROG] on the setting screen.

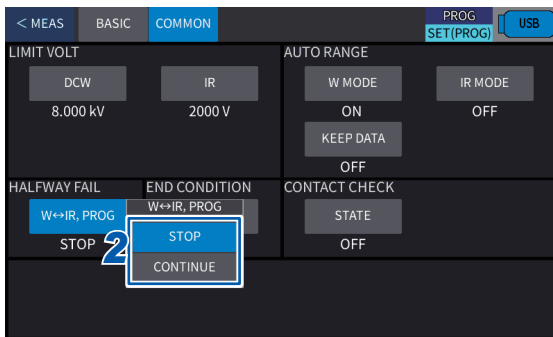

2 Select the setting.

STOP *1	Ends all tests when a fail judgment is determined for the test target in the middle of a test.
CONTINUE	Continues the next test even when a fail judgment is determined for the test target in the middle of a test.

*1. Default setting

6.4 Starting and Ending a Test

Starting a test

See “Starting a test” (p. 59).

Stopping a test

See “Stopping a test” (p. 63).

Ending a test

See “Ending a test” (p. 63).

6.5 Making a Pass/Fail Judgment

Judgment type and operation

See “Judgment type and operation” (p. 64).

When the test ends, the judgment result is displayed in the display area.

STEP	VOLTAGE	CURR / RES	TIME	JUDGE			
05				PASS			
STEP	VOLTAGE	UPPER	LOWER	VOLTAGE	CURR / RES	TIME	JUDGE
01	M DC 1.000kV	1.000mA	OFF	0.997kV	0.829µA	0.0 s(TEST)	PASS
02	IR DC 500 V	OFF	30.00MΩ	499 V	0. F. GΩ	0.0 s(TEST)	PASS
03	M DC 2.000kV	1.000mA	OFF	1.993kV	2.151µA	0.0 s(TEST)	PASS
04	IR DC 1000 V	OFF	30.00MΩ	997 V	28.39GΩ	0.0 s(TEST)	PASS
05	M DC 2.300kV	1.000mA	OFF	2.290kV	0.099µA	0.0 s(TEST)	PASS

6.6 Automatic Discharge Function

See “4.17 Automatic Discharge Function” (p. 66).

6.7 Individually Executing Specific Steps

A program test is executed from the No. 01 step, however, a specific step can be specified and executed.

- A step number larger than the final step (END STEP) cannot be specified.
- After the individual execution is completed, the program test is changed back to the normal sequence from No. 01 to the final step. When executing a specific step again, specify a step to be executed.

Measurement screen



1 Press the area of [STEP].

2 Change the value using [▲] or [▼], and then press [SET].

When [ALL] is pressed, the value changes to ALL and the normal program test is performed from the No. 01 step to the final step.



When measurement begins, only the test of the specified step is performed.

Compensation execution screen

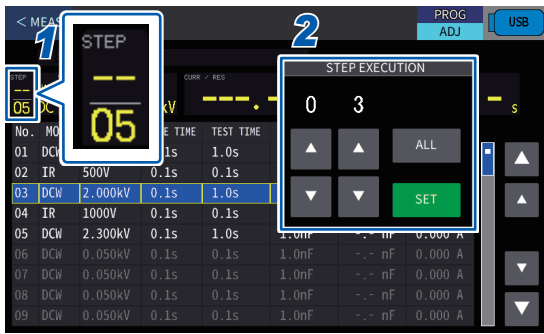

- 1 Press the area of [STEP].
- 2 Change the value using [▲] or [▼], and then press [SET].

When [ALL] is pressed, the value changes to ALL and the normal program test is performed from the No. 01 step to the final step.

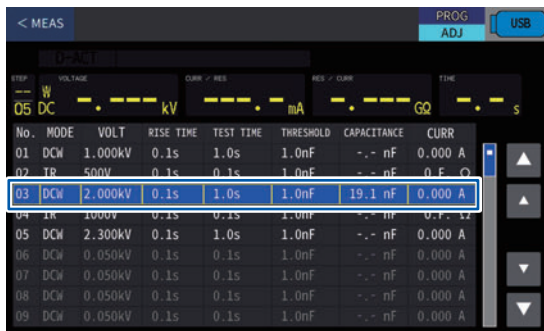

When measurement begins, only the test of the specified step is performed.

7

Dielectric Breakdown Voltage (BDV) Measurement Mode

The dielectric breakdown voltage (BDV) mode is a function to automatically raise the test voltage for a withstand voltage test and measure the breakdown voltage.

In the BDV measurement mode for this instrument, tests that conform to the following standard requirements can be performed.

- JIS C 2110-2 Solid electrical insulating materials - Test methods for dielectric breakdown strength ("electric strength") - Part 2:
Tests using direct voltage
- IEC 60243-2 Solid electrical insulating materials-Test methods for electric strength- Part 2:
Tests using direct voltage

BDV test details

Test method

Continuous voltage rise test: Raises the test voltage at a constant rate from the initial voltage.

Gradual voltage rise test: Raises the test voltage gradually from the initial voltage.

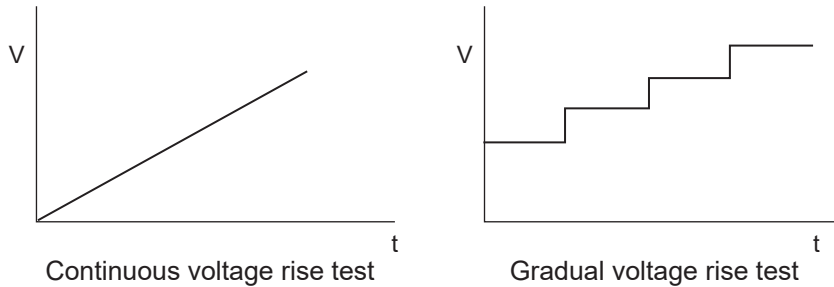

Setting details

Continuous voltage rise test	Initial voltage, end voltage, voltage rise speed, distance between electrodes, number of tests
Gradual voltage rise test	Initial voltage, voltage holding time at each phase, voltage step, maximum number of steps, distance between electrode, number of tests

Measurement details

Continuous voltage rise test	Dielectric breakdown voltage:	Voltage when a dielectric breakdown occurs in the test target under the specified test conditions
	Dielectric breakdown strength:	Value obtained by dividing the dielectric breakdown voltage by the distance between two electrodes used for a test
	The median, average, and standard deviation of dielectric breakdown voltage and dielectric breakdown strength are displayed.	
Gradual voltage rise test	Dielectric breakdown voltage:	Highest voltage at which no dielectric breakdown occurs in the test target for the specified holding time
	Dielectric breakdown strength:	Value obtained by dividing the dielectric breakdown voltage by the distance between two electrodes used for a test
	The median, average, and standard deviation of dielectric breakdown voltage and dielectric breakdown strength are displayed.	

Dielectric breakdown judgment procedure

Either the current upper-limit reference value setting or arc discharge detection

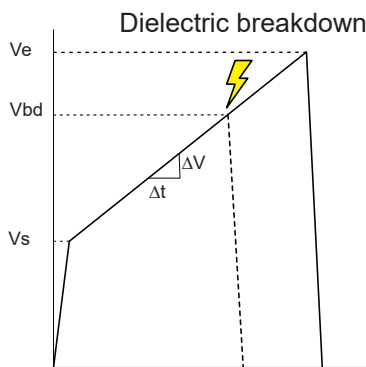

Continuous voltage rise test

V_s : Initial voltage (V)
 V_e : End voltage (V)
 V_{bd} : Dielectric breakdown voltage
 Voltage rise speed: $\Delta V / \Delta t$

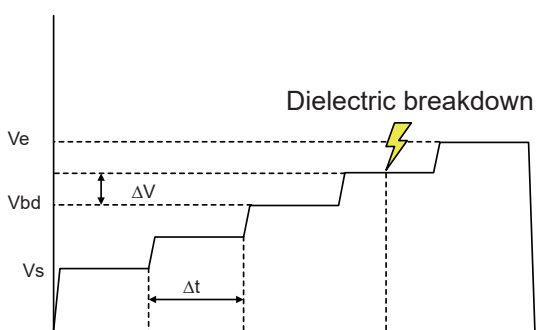

Gradual voltage rise test

V_s : Initial voltage
 V_e : End voltage
 V_{bd} : Dielectric breakdown voltage
 ΔV : Voltage steps
 Δt : Holding time

7.1 Setting the Test Conditions

Displaying the setting screen

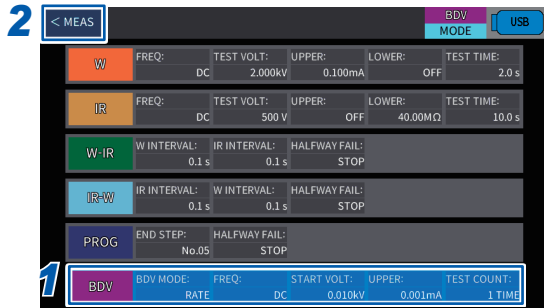

- 1 Select [BDV] on the mode screen.
- 2 Press [< MEAS].

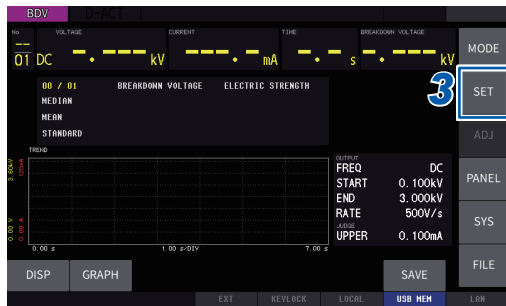

- 3 Press [SET].

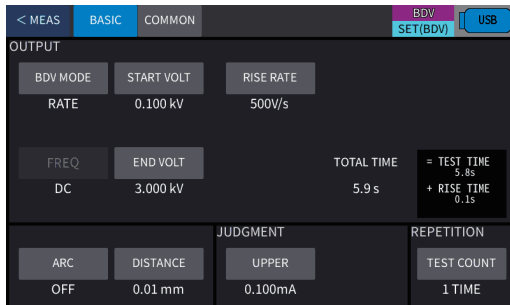

Displays various setting screens.

IMPORTANT

The time displayed below [TOTAL TIME] on the Setup window is the theoretical test time for one test. The actual test time may be longer than the time displayed below [TOTAL TIME] by approximately 0.1 s.

7.2 Continuous Voltage Rise Test

Setting the test conditions

Setting the test method

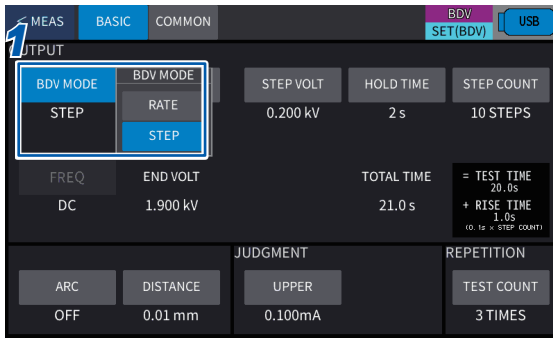

1 On the setting screen, press **[BASIC]** > **[BDV MODE]** to set the test method to **[RATE]**.

(When **[BDV MODE]** is set to **[STEP]**)
A confirmation message is displayed.



2 Press **[YES]**.

When **[RATE]** is set, all the output settings are initialized.

Setting the initial voltage

The initial voltage is set.

Press the **START** button and wait till the voltage reaches the initial voltage after 0.1 seconds. Raise the test voltage to the end voltage at the set voltage raise speed to perform the test.

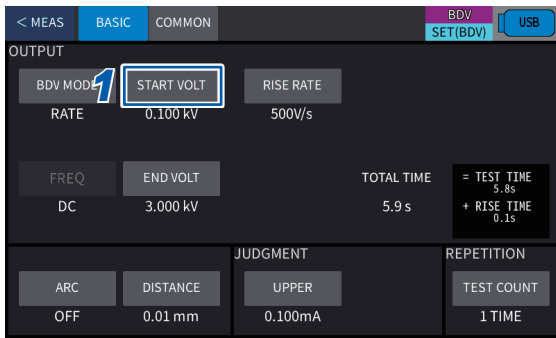

- 1 Press **[BASIC]** > **[START VOLT]** on the setting screen.

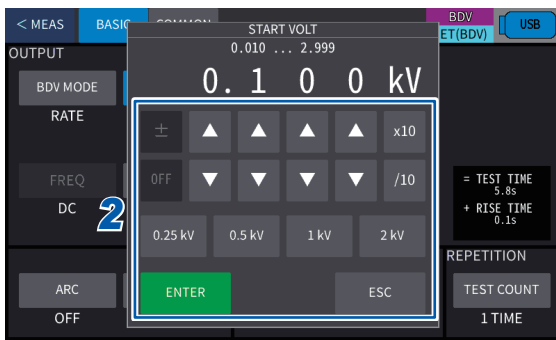

- 2 Change the value using **[▲]** or **[▼]** and then press **[ENTER]**.

0.25 kV, 0.5 kV, 1 kV, 2 kV, any voltage
Setting range: 0.010 kV*1 to 7.999 kV

*1. Default setting

The upper limit is automatically set based on the end voltage value in **[END VOLT]**.

[START VOLT] < **[END VOLT]**

Setting the end voltage

The end voltage is set.

When no dielectric breakdown occurred under the set test conditions, shut off the output of the test voltage at the end voltage and finish the test.

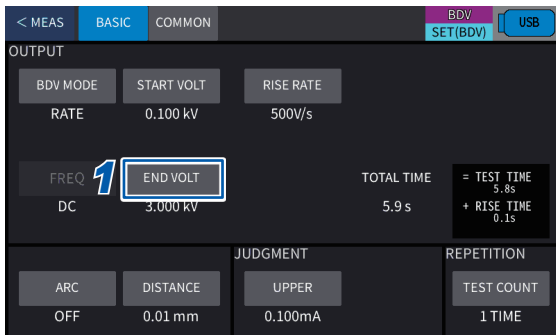

- 1 Press **[BASIC]** > **[END VOLT]** on the setting screen.

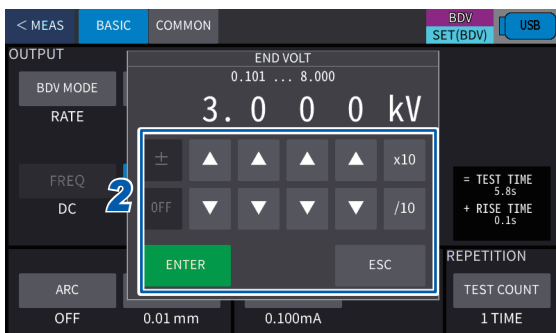

- 2 Change the value using **[▲]** or **[▼]** and then press **[ENTER]**.

0.011 kV to 8.000 kV

Default setting: 5.000 kV

The lower-limit is automatically set based on the initial voltage value in **[START VOLT]**.

([START VOLT] < [END VOLT])

Setting the voltage rise speed

The voltage rise speed is set.

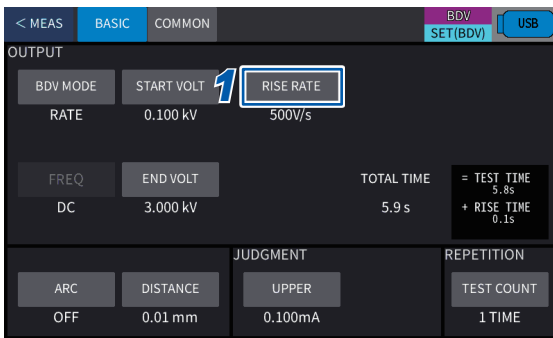

- 1 Press **[BASIC]** > **[RISE RATE]** on the setting screen.

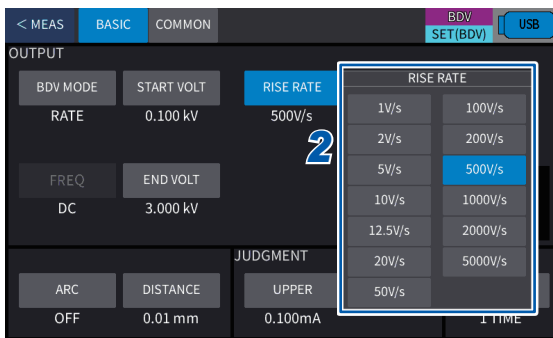

- 2 The voltage rise speed is set.

1V/s, 2V/s, 5V/s, 10V/s, 12V/s, 20V/s, 50V/s, 100V/s, 200V/s, 500V/s*1, 1000V/s, 2000V/s, 5000V/s

*1. Default setting

Setting the distance between electrodes

The thickness of the test piece to be used for calculation of the dielectric breakdown strength or the distance between electrodes is set.

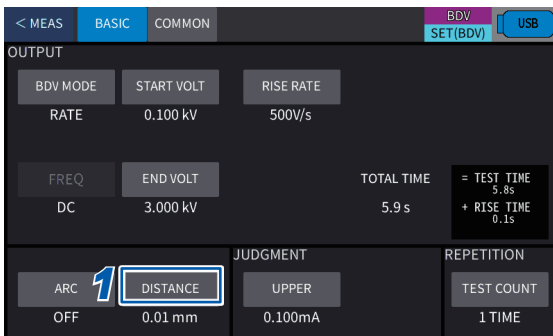

- 1 Press **[BASIC]** > **[DISTANCE]** on the setting screen.

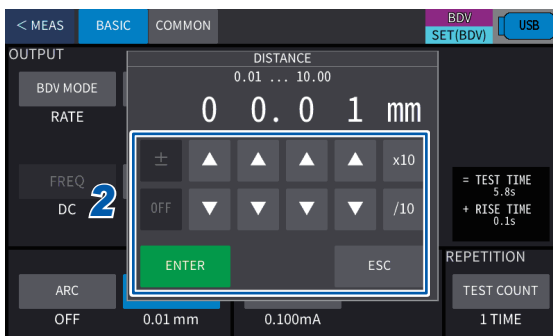

- 2 Change the value using **[▲]** or **[▼]** and then press **[ENTER]**.

0.01 mm*2 to 10.00 mm

*2. Default setting

Setting the number of tests

The number of tests is set.

In a BDV test, determine the dielectric breakdown strength or dielectric breakdown voltage from the median of the result of the set number of tests.

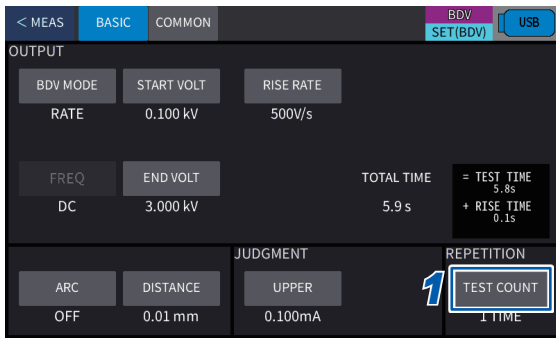

- 1 Press **[BASIC]** > **[TEST COUNT]** on the setting screen.

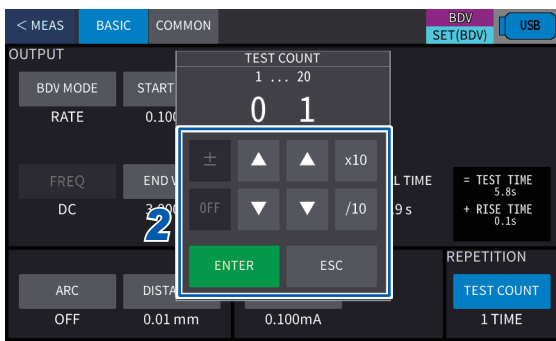

- 2 Change the value using **[▲]** or **[▼]** and then press **[ENTER]**.

1*¹ to 20

*1. Default setting

Setting the dielectric breakdown judgment reference value

The dielectric breakdown judgment method and reference value are set.

There are two judgment methods, judgment by the current upper-limit reference value and the arc discharge detection.

(1) Setting the current upper-limit value

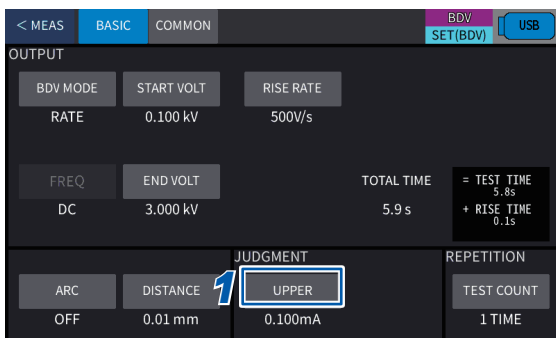

- 1 Press **[BASIC]** > **[UPPER]** on the setting screen.

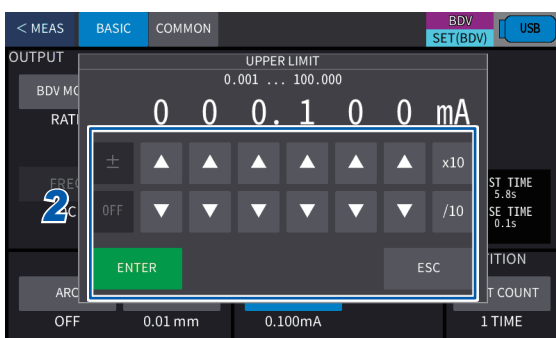

- 2 Change the value using **[▲]** or **[▼]** and then press **[ENTER]**.

0.010 mA*² to 100 mA

*2. Default setting

(2) Setting the arc discharge detection

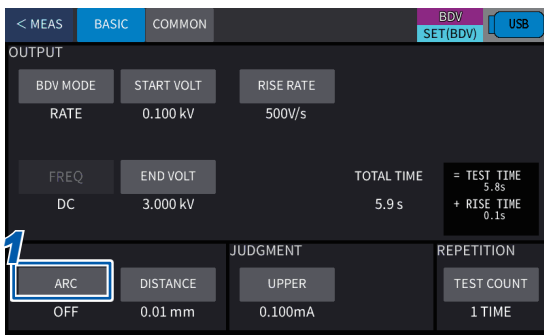

1 Press **[BASIC]** > **[ARC]** on the setting screen.

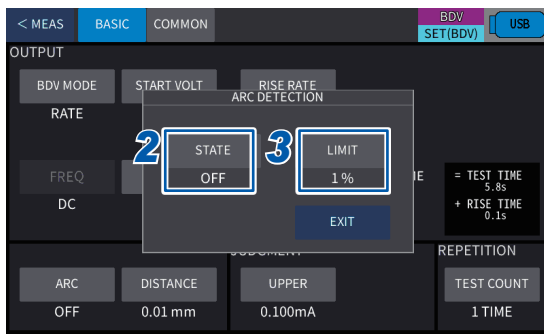

2 Switch **[ON]** between **[OFF]** under **[STATE]**.

OFF *1	Does not detect arc.
ON	If the test voltage at the time of discharging fluctuates beyond the set ratio, an arc is detected, and the test is stopped.

*1. Default setting

3 When **[ON]** is set, press **[LIMIT]**.

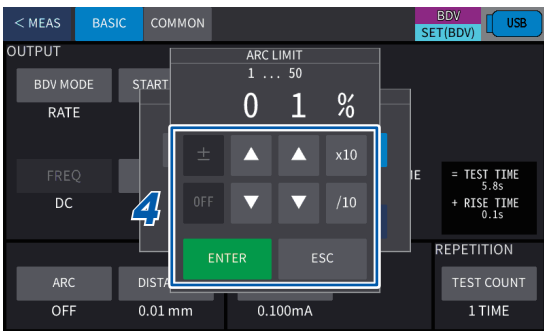

4 Change the value using **[▲]** or **[▼]** and then press **[ENTER]**.

1%*2 to **50%**

*2. Default setting

Measurement details

The following information is displayed for a continuous voltage rise test.

- Dielectric breakdown voltage: Voltage when a dielectric breakdown occurs in the test piece under the specified test conditions
- Dielectric breakdown strength: Value obtained by dividing the dielectric breakdown voltage by the distance between two electrodes used for a test
- The median, average, and standard deviation over the number of all tests for the dielectric breakdown voltage and dielectric breakdown strength

Number of times used for calculation
(Number of dielectric breakdowns)

Dielectric breakdown voltage and dielectric breakdown strength
(Median, average, and standard deviation over the number of all tests)

Test result by the number of tests for the dielectric breakdown voltage and dielectric breakdown strength

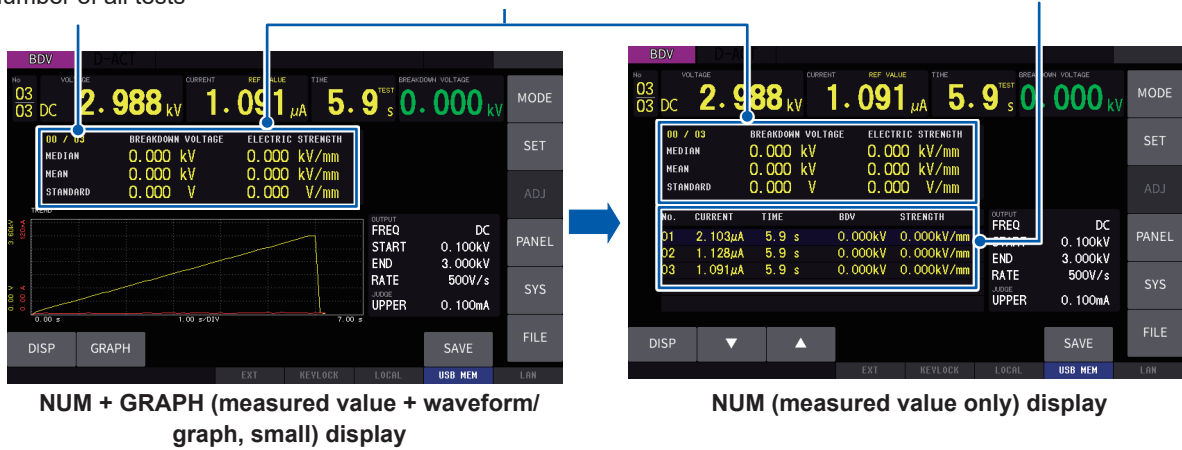

In the NUM display, the test result by the number of tests for the dielectric breakdown voltage and dielectric breakdown strength can be displayed.

For information on how to switch the measurement screen, see “8.1 Waveform Graph Display” (p. 101).

Starting a test

See “Starting a test” (p. 59).

Stopping a test

See “Stopping a test” (p. 63).

Ending a test

See “Ending a test” (p. 63).

7.3 Gradual Voltage Rise Test

Setting the test conditions

Setting the test method

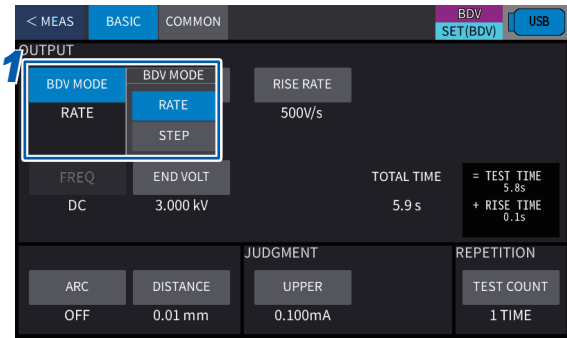

1 Press **[BASIC]** > **[BDV MODE]** to set the test method to **[STEP]**.

(When **[BDV MODE]** is set to **[RATE]**)

A confirmation message is displayed.



2 Press **[YES]**.

The output settings are initialized.

Setting the initial voltage

The initial voltage is set.

Press the **START** button and wait till the voltage reaches the initial voltage after 0.1 seconds.

Perform the test according to the set voltage holding time, voltage step, and number of steps.

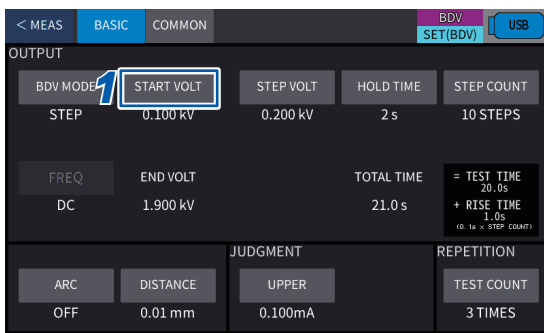

1 Press **[BASIC]** > **[START VOLT]** on the setting screen.

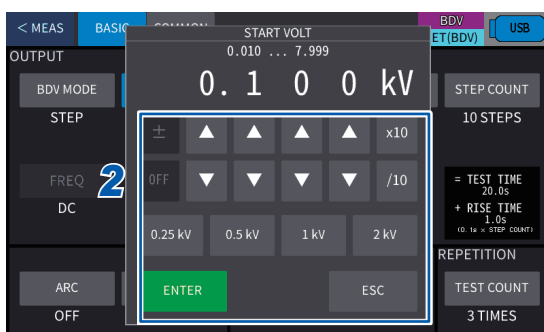

2 Change the value using **[▲]** or **[▼]** and then press **[ENTER]**.

0.25 kV, 0.5 kV, 1 kV, 2 kV, any voltage
Setting range: **0.010 kV^{*1}** to **7.999 kV**

*1. Default setting

Setting the voltage steps

The voltage steps are set.

The test voltage is raised by the set voltage steps from the initial voltage after the holding time and the voltage set for each step is applied continuously to the highest step.

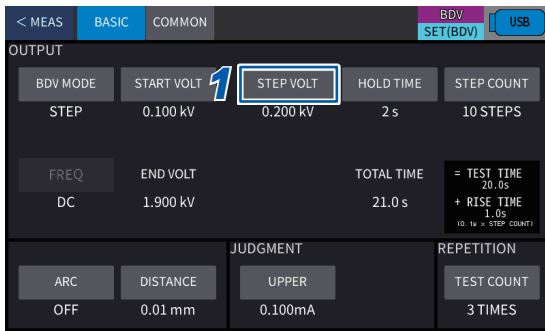

1 Press **[BASIC]** > **[STEP VOLT]** on the setting screen.

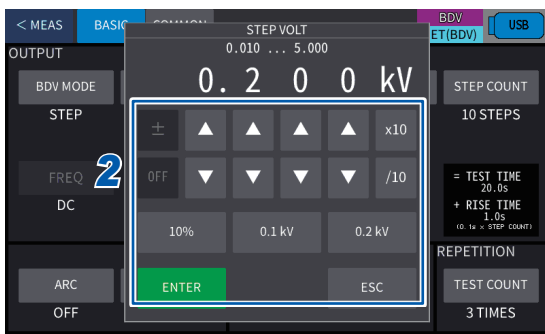

2 Change the value using **[▲]** or **[▼]** and then press **[ENTER]**.

10% of the initial voltage*¹, 0.1 kV, 0.2 kV, any voltage
Setting range: 0.010 kV to 5.000 kV

*1. Default setting

Setting the voltage holding time for each step

The voltage holding time for each step is set.



1 Press **[BASIC]** > **[HOLD TIME]** on the setting screen.



2 Change the value using **[▲]** or **[▼]** and then press **[ENTER]**.

20 s*1, 60 s, 300 s, TRIG, any time
Setting range: 1 s to 300 s

*1. Default setting

When **[TRIG]** is set, TRIG operation is performed. Press the **START** button to proceed to the next step.

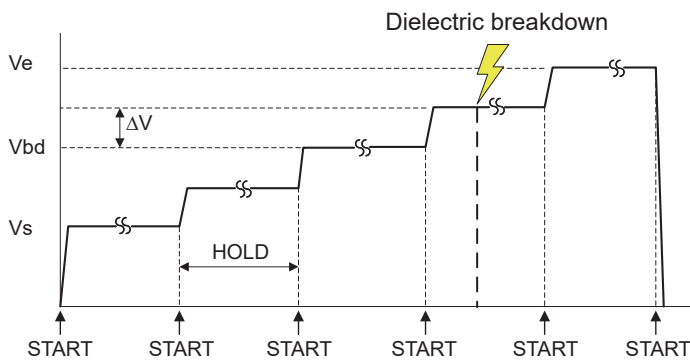

Vs: Initial voltage
Ve: End voltage
Vbd: Dielectric breakdown voltage
 ΔV : Voltage steps

Setting the number of steps

The maximum number of steps for all tests is set.

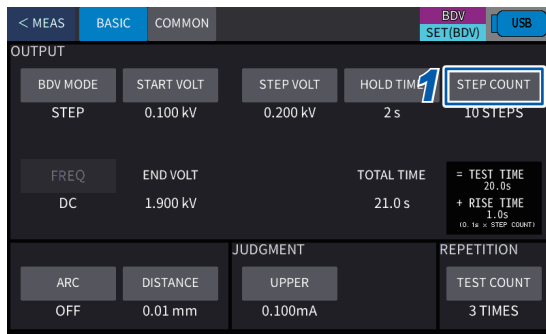

- 1 Press **[BASIC]** > **[STEP COUNT]** on the setting screen.

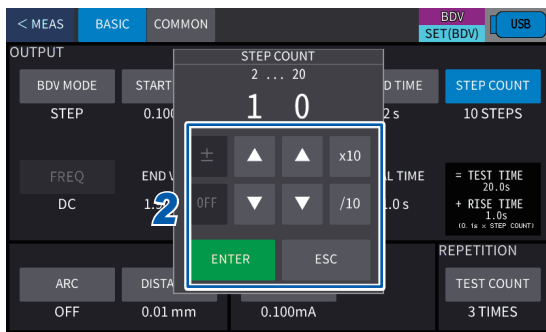

- 2 Change the value using **[▲]** or **[▼]** and then press **[ENTER]**.

2 to 20

Default setting: 10

Setting the distance between electrodes

The thickness of the test piece to be used for calculation of the dielectric breakdown strength or the distance between electrodes is set.

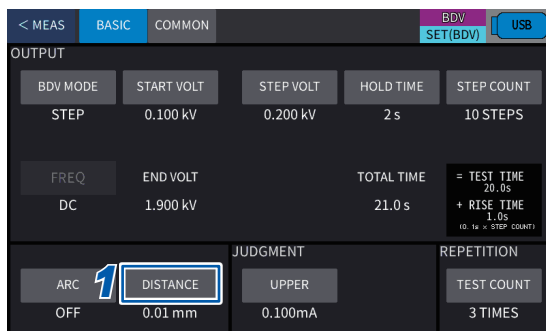

- 1 Press **[BASIC]** > **[DISTANCE]** on the setting screen.



- 2 Change the value using **[▲]** or **[▼]** and then press **[ENTER]**.

0.01 mm*1 to 10.00 mm

*1. Default setting

Setting the number of tests

The number of tests is set.

In a BDV test, determine the dielectric breakdown strength or dielectric breakdown voltage from the median of the result of the set number of tests.

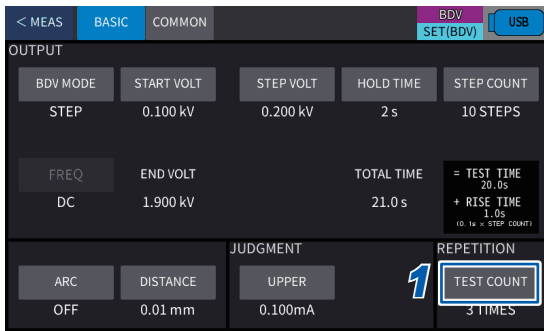

1 Press [BASIC] > [TEST COUNT] on the setting screen.



2 Change the value using [▲] or [▼] and then press [ENTER].

1*1 to 20

*1. Default setting

Setting the dielectric breakdown judgment reference value

The dielectric breakdown judgment method and reference value are set.

There are two judgment methods, judgment by the current upper-limit reference value and the arc discharge detection.

(1) Setting the current upper-limit reference value

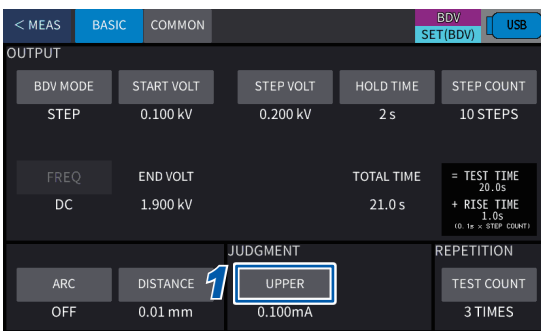

1 Press [BASIC] > [UPPER] on the setting screen.

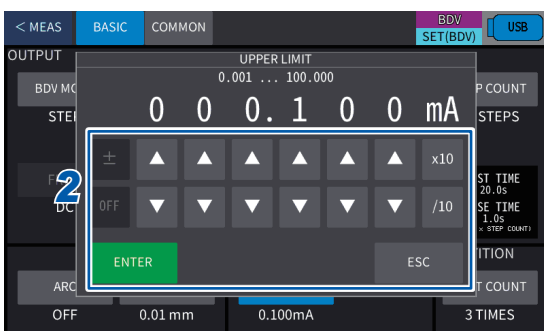

2 Change the value using [▲] or [▼] and then press [ENTER].

0.010 mA*1 to 100 mA

*1. Default setting

(2) Setting the arc discharge detection

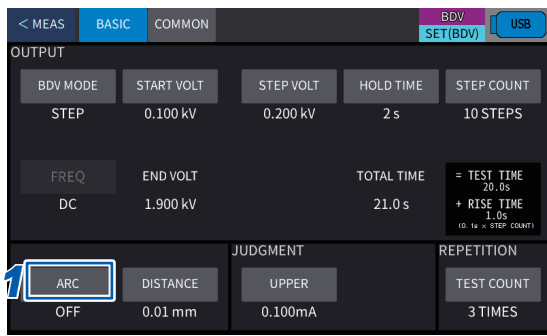

1 Press [BASIC] > [ARC] on the setting screen.

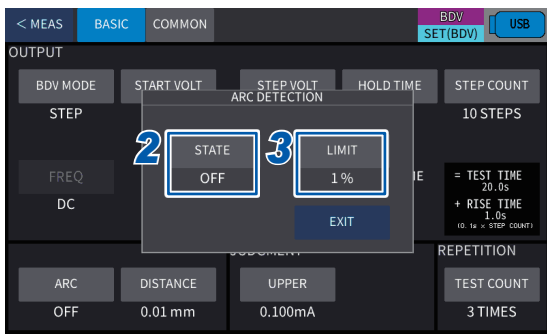

2 Switch [ON] and [OFF] under [STATE].

OFF*1	Does not detect arc.
ON	If the test voltage at the time of discharging fluctuates beyond the set ratio, an arc is detected, and the test is stopped.

*1. Default setting

3 When [ON] is set, press [LIMIT].

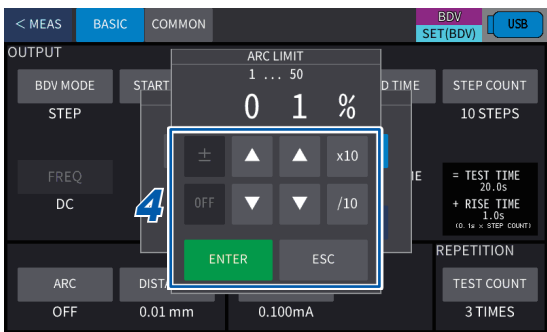

4 Change the value using [▲] or [▼] and then press [ENTER].

1%*2 to 50%

*2. Default setting

Measurement details

The following information is displayed for a gradual voltage rise test.

- Dielectric breakdown voltage: Highest voltage at which no dielectric breakdown occurs in the test piece for the specified holding time
- Dielectric breakdown strength: Value obtained by dividing the dielectric breakdown voltage by the distance between two electrodes used for a test
- The median, average, and standard deviation over the number of all tests for the dielectric breakdown voltage and dielectric breakdown strength

Number of times used for calculation
(Number of dielectric breakdowns)
Number of all tests

Dielectric breakdown voltage and dielectric breakdown strength
(Median, average, and standard deviation of all tests)

Test result by the number of tests for the dielectric breakdown voltage and dielectric breakdown strength



NUM + GRAPH (measured value + waveform/graph, small) display



NUM (measured value only) display

In the NUM display, the test result by the number of tests for the dielectric breakdown voltage and dielectric breakdown strength can be displayed.

For information on how to switch the measurement screen, see “8.1 Waveform Graph Display” (p. 101).

IMPORTANT

When the voltage hold time of each phase is set to TRIG, the voltage rise timing may be shifted with respect to the measurement timing. Thus, the voltage rise time may appear at 200 ms in the graph display (TREND), but the actual voltage rise time is 100 ms.

When you switch to the waveform display (WAVE), you can confirm that the voltage rise time is 100 ms.

Starting a test

See “Starting a test” (p. 59).

Stopping a test

See “Stopping a test” (p. 63).

Ending a test

See “Ending a test” (p. 63).

8

Various Functions

8.1 Waveform Graph Display

This instrument provides a function to display the waveform when a test is ended and a function to display the measured values as a graph in chronological order.

Waveform display function: Displays the waveform when a test ends (fail judgment and pass judgment).

Graph display function: Displays the measured values during a test (voltage, current, and resistance values) in chronological order.

Switching the measurement screen

- 1 Press **[DISP]** > **[NUM + GRAPH]**, **[NUM]**, or **[GRAPH]** on the measurement screen.

Default setting: NUM

The diagram illustrates the process of switching between measurement screens. It starts with a 'Measurement screen' showing a waveform graph and numerical data. A menu is displayed over the screen with three options: 'NUM+GRAPH', 'NUM', and 'GRAPH'. Arrows indicate the selection of each option, leading to three different screen views:

- NUM + GRAPH (measured value + waveform/graph, small):** This screen shows a smaller version of the waveform graph and numerical data.
- NUM (measured value only):** This screen displays only the numerical data, with the waveform graph hidden.
- GRAPH (measured value, small + waveform/graph, large):** This screen shows a larger version of the waveform graph and numerical data.

Switching between the graph and waveform displays

- 1 Press [DISP] > [NUM + GRAPH] or [GRAPH] on the measurement screen.
- 2 Press [GRAPH].

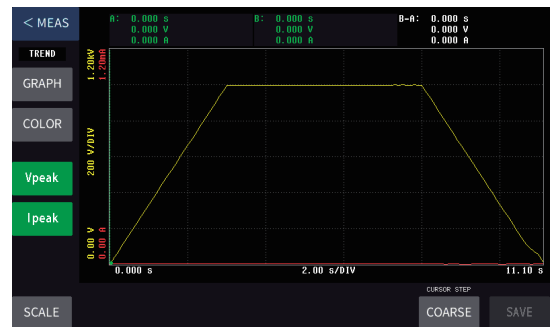

- 3 Press [TREND] or [WAVE].

Default setting: TREND

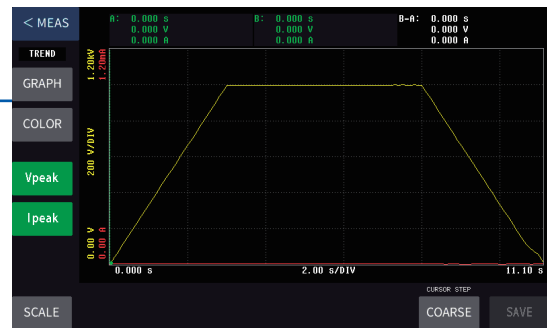
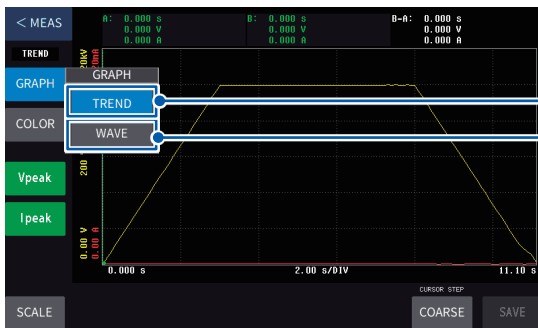

TREND (chronological) display



WAVE (waveform) display

(1) Graph display (TREND)

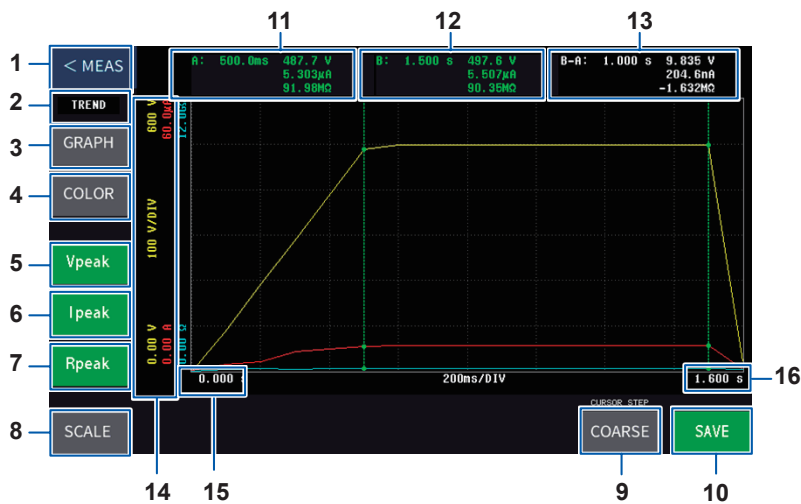

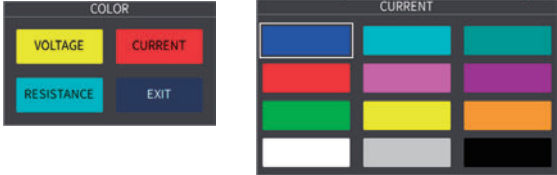
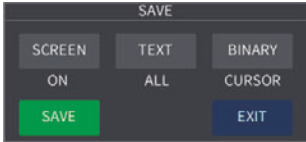
1	Return button	Returns to the measurement screen.
2	TREND/WAVE	Allows you to check the current display (graph or waveform display).
3	GRAPH	Switches between the graph and waveform displays.
4	COLOR	<p>Allows you to set the waveform color.</p> <ul style="list-style-type: none"> The waveform colors can be selected for the voltage, current, and resistance values (only the insulation resistance test mode for the resistance value). The waveform colors can be selected from 14 colors (waveforms are not displayed if black is selected). 
5	Vpeak	Moves cursor A to the minimum voltage value and cursor B to the maximum voltage value.
6	Ipeak	Moves cursor A to the minimum current value and cursor B to the maximum current value.
7	Rpeak	Moves cursor A to the minimum resistance value and cursor B to the maximum resistance value.
8	SCALE	Changes the vertical axis scale. The scaling by the setting conditions and by the measured value can be switched.
9	CURSOR STEP	Allows you to change the amount of cursor movement when the cursor is moved using the rotary knob. FINE: Movement for one set of data COARSE: Movement for about 10% of all data (depending on the situation)
10	SAVE	Saves images displayed on the screen and data in the text format and binary format. You can select to save either all data or data between cursor A and cursor B. 
11	Cursor A value	Displays the value at the cursor A position. The voltage, current, and resistance values (only the insulation resistance test mode) are displayed. Touching inside the value display area makes the data to be moved using the rotary knob. Green: To be moved White: Not to be moved
12	Cursor B value	Displays the value at the cursor B position. The voltage, current, and resistance values (only the insulation resistance test mode) are displayed. Touching inside the value display area makes the data to be moved using the rotary knob. Green: To be moved White: Not to be moved
13	B-A value	Displays the difference in the value between the cursor B position and cursor A position.
14	Grid	Switches the grid line. Touching the area switches the grid line from voltage to current and then resistance.
15	Moving cursor A	Moves cursor A to the left end.
16	Moving cursor B	Moves cursor B to the right end.

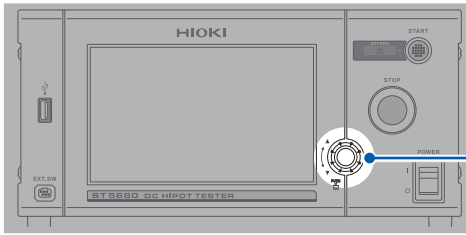

Rotary knob

- Turning the rotary knob allows you to move the cursor.
- Pressing the rotary knob allows you to change the cursor to be moved.
Cursors A and B → cursor A → Cursor B

(2) Waveform display (WAVE)

The target cursor moves to the position where it is touched.
If both cursors A and B are to be moved, the closer cursor moves.

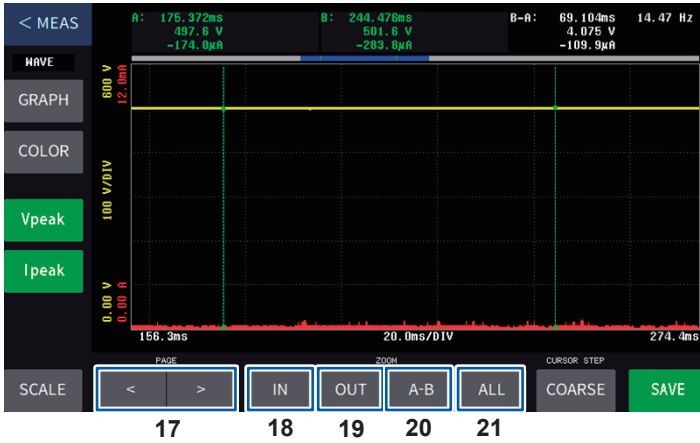

17	<	Moves the cursor to the previous (left) page when the display is zoomed in.
	>	Moves the cursor to the next (right) page when the display is zoomed in.
18	IN	Zooms in the waveform.
19	OUT	Zooms out the waveform.
20	A-B	Zooms in the waveform between the cursors.
21	ALL	Displays all sets of waveform data in the memory.

8.2 Contact Check

When a measurement is performed with the measurement jig of the measurement system not in contact with the test target during a withstand voltage test or insulation resistance test, a false judgment is made for insulation defects. A contact check is a function to check whether the measurement jig is in contact with the test target to prevent such false judgment. The contact check function for this instrument is an electrostatic capacitance detection method type. A contact check can be performed for connections of normal withstand voltage and insulation resistance tests.

When the contact check function is enabled, the connection between the HIGH terminal and LOW terminal of the High Voltage Test Lead can be checked.

- A contact check is executed at the end of the tests for this instrument.
- Since this instrument is an electrostatic capacitive detection method type, it cannot be used for a test target with a low amount of electrostatic capacitive components, such as pure resistance.
- Even if the contact check function is set to [ON], a contact check is not executed when the test result is fail and the test is forcefully terminated by a STOP signal.
- When the contact check function is set to [ON], the output timing of the external control judgment signal is [MEAS END] (p. 161) only.

Contact check procedure

Connect the test target to the test lead and measure the capacitance. When the capacitance value is more than the threshold value, a contact error occurs. In this case, inspect the instrument and measurement jig.

Contact check setting (enabled/disabled)

Set whether to perform a contact check or not.

This is a common setting for all test modes except for the BDV measurement mode.

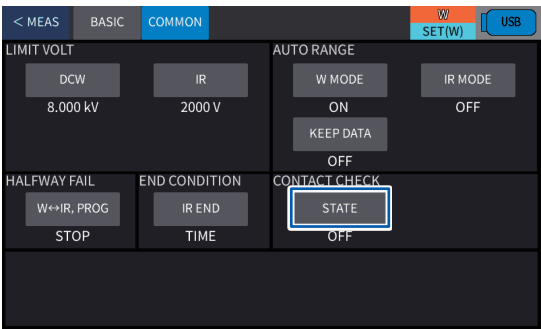

1 Press [COMMON] > [STATE] on the setting screen.

When the contact check setting is changed from [OFF] to [ON], a confirmation message is displayed.

ON	Enables the contact check function.
OFF*1	Disables the contact check function.

*1. Default setting

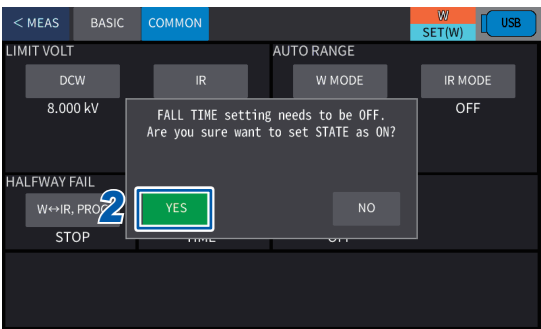

2 Press [YES].

When the contact check function is enabled, set the voltage drop time [FALL TIME] to [OFF]. (p. 51)

Setting the judgment threshold value

The threshold value of a contact check judgment is set as an electrostatic capacitance value for this instrument.

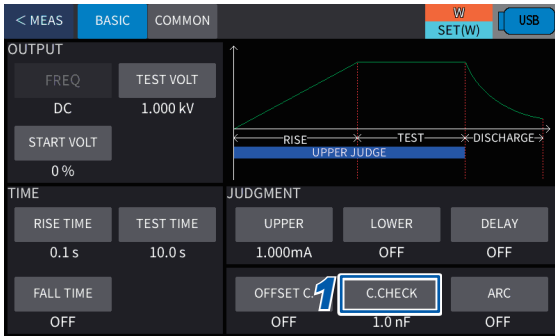

- 1 Press **[BASIC]** > **[C.CHECK]** on the setting screen.

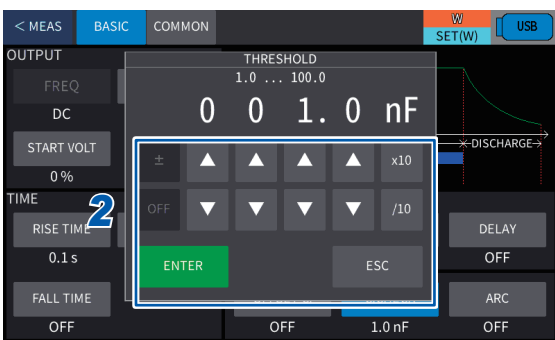

- 2 Change the value using **[▲]** or **[▼]**, and then press **[ENTER]**.

1.0 nF*1 to 100.0 nF

*1. Default setting

Executing a contact check

When the contact check function is enabled, a contact check judgment is executed at the end of a withstand voltage test or insulation resistance test.

See “12.3 Timing Charts” (p. 166).

Acquiring the compensation value

When the contact check function is set to **[ON]**, execute open compensation before testing.

Acquire the compensation value in an open state, without a DUT connected, by the same operation as at the usual start of a test.



- 1 Press **[ADJ]** on the measurement screen to start a test on the compensation execution screen.

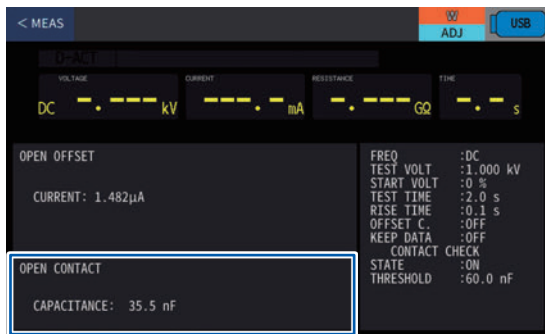

After the test finishes, the compensation value is acquired.

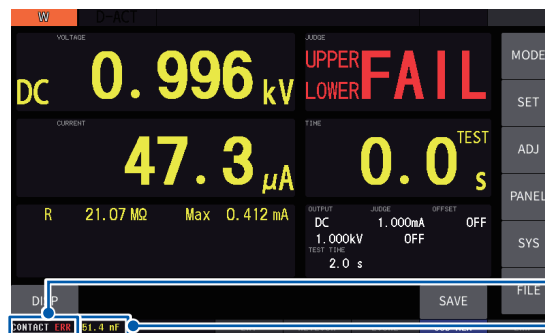

On the measurement screen, a contact check is executed at the end of the test.

If the DUT's capacitance value (the value obtained by subtracting the correction value from the measured capacitance value) is smaller than the judgment threshold, a failed judgment is given for the contact check.

If a pass judgment is given at the end of the test and a fail judgment is given for the contact check, an UPPER LOWER FAIL judgment is given.

Contact check result

DUT's capacitance value

- The correction value is acquired under the test conditions that have been set.
- Compensation cannot be performed in W-IR/IR-W mode. Perform compensation in DCW mode and IR mode each.
- The compensation value is acquired when the set test time ends. The compensation value is not acquired if the STOP button is pressed in the middle.
- The compensation value will not be acquired if the test time is set to [CONT]. To acquire the compensation value, set the test time to a setting other than [CONT].
- Even when the instrument is turned off, the obtained correction value is backed up.
- When the contact check function is set to on, compensation cannot be performed if the test voltage [TEST VOLT] is set to less than 100 V.
- When the contact check function is set to off, compensation can be performed even when the test voltage [TEST VOLT] is set to less than 100 V, but the contact check correction value is not obtained.

IMPORTANT

Changing the test voltage initializes the compensation value.

When the test voltage is changed, acquire the compensation value again.

8.3 Insulation Resistance Test End Mode

The timing to end an insulation resistance test (IR) mode (p. 37) is set.

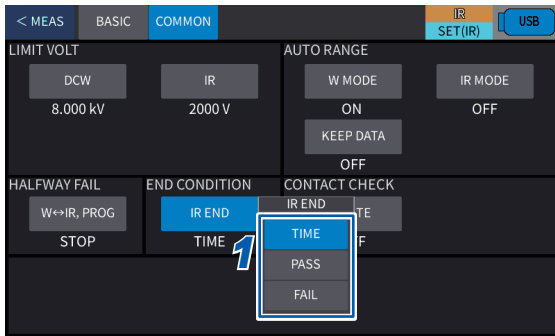

1 Press **[COMMON]** > **[IR END]** on the setting screen.

TIME *1	Performs a test for the set duration and makes a judgment with the value at the end of the test.
PASS	Ends a test at the time of pass judgment within the set duration (excluding the delay time).
FAIL	Ends a test at the time of fail judgment within the set duration (excluding the delay time).

*1. Default setting

8.4 Data Memory Function

Test results (up to 32,000 results) can be saved to the internal memory of the instrument. The measurement results saved inside the instrument can be acquired either by saving them to a USB flash drive or by using a communications command.

Information to be saved

Test mode	DCW, IR, W-IR, IR-W, program
Test start date and time	yy-mm-dd hh:mm:ss
Measured value	Voltage, current, resistance
Measurement range	Withstand voltage test mode, insulation resistance test mode
Remaining test time (Elapsed test time for CONT)	Seconds
Judgment results	PASS, UPPER FAIL, LOWER FAIL, UPPER LOWER FAIL, other
Timer type	Test time, voltage rise time

- There is no memory backup function available. Memory data is cleared when the instrument is turned off.
- Save the measurement results saved inside the instrument to a USB flash drive or acquire them using the `:MEMory:FETCh?` command.
- Internal memory is automatically deleted if memory data is saved to a USB flash drive or is acquired using a communications command.
- When the number of the measurement results saved in the instrument reaches 32,000, **[MEM:FULL]** is displayed and no more measured values are saved. If restarting data saving, either load the memory from the instrument internal memory or clear the memory data.
- For information using a USB flash drive, see “10.1 Using USB Flash Drive” (p. 124).

Setting the memory function

Sets whether to enable or disable the memory functions. If enabled, the test results are automatically saved to the internal memory in the instrument when the test finishes.

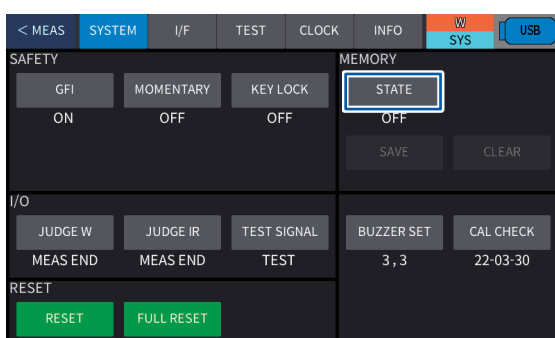

- 1 Press **[SYSTEM]** > **[STATE]** on the setting screen.

ON The memory function is activated.

OFF*1 Disables the memory function.

*1. Default setting

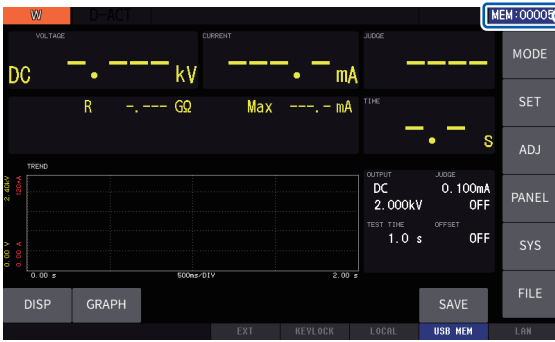

MEM:00000 — Number of measurement results saved in memory

When the memory function is enabled, the number of measurement results currently stored in memory is displayed on the measuring screen (up to 32,000).

Saving memory data

The data in the internal memory is saved to the USB flash drive. The data in the internal memory is automatically deleted after it is saved.

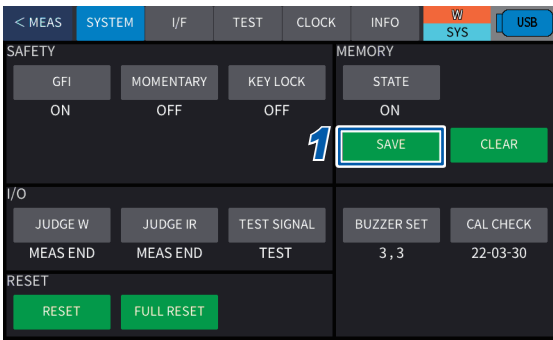

1 Press [SYSTEM] > [SAVE] on the system screen.

A confirmation message is displayed.

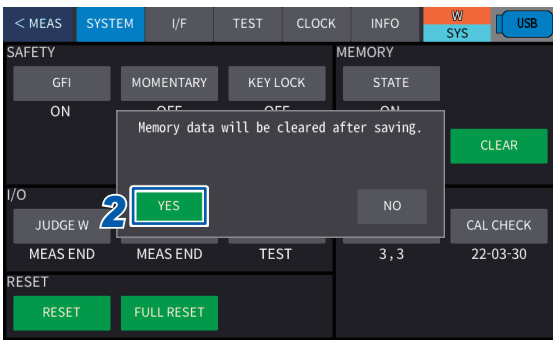

2 Press [YES].

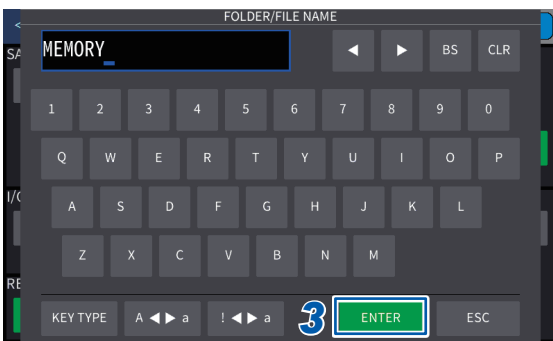

3 Enter a name for the saved file and press [ENTER].

Clearing memory data

The data in the internal memory is deleted without saving to the USB flash drive.

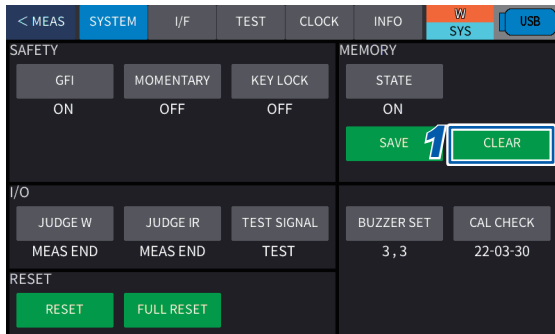

- 1 Press **[SYSTEM]** > **[CLEAR]** on the system screen.

A confirmation message is displayed.

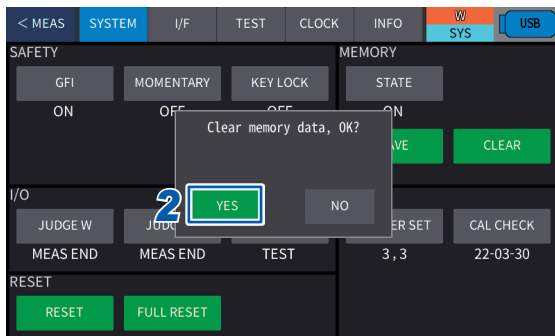

- 2 Press **[YES]**.

8.5 GFI Function (DCW Only)

When the operator accidentally comes in contact with high voltage, serious damage or fatal hazards could occur to the operator. This function shuts off the output when a current over 0.5 mA flows from the earth of the test target to the ground to protect the operator from such electric shock hazards.

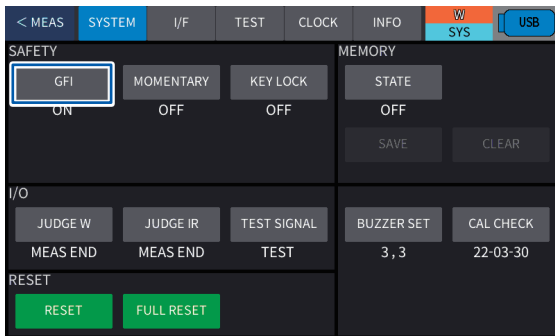

1 Press [SYSTEM] > [GFI] on the measurement screen.

OFF	Disables the GFI function.
ON*1	Enables the GFI function.

*1. Default setting

IMPORTANT

The output may be cut off by ground fault if the instrument is used in an environment susceptible to common mode noise.

False detection of GFI due to noise

<p>When the difference between the two ammeters inside the tester becomes 0.5 mA or more, the tester judges it as a ground fault and shuts off the output signal.</p>	<p>The output may be cut off by ground fault if the instrument is used in an environment susceptible to common mode noise.</p>
<p>(a) GFI fault detection principle</p>	<p>(b) Ground fault detected by noises</p>

8.6 Adjusting the Buzzer Volume

When a pass or fail judgment is made or an error occurs (key operation error, etc.), a buzzer sounds.

The buzzer volume for pass judgment and fail judgment can be adjusted. The buzzer volume for when an error occurs is the same as the volume for fail judgment.

When a pass or fail judgment is given, the buzzer sounds for approximately 50 ms.

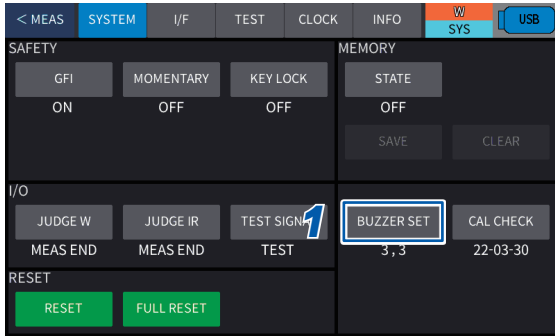

- 1 Press **[SYSTEM]** > **[BUZZER SET]** on the system screen.

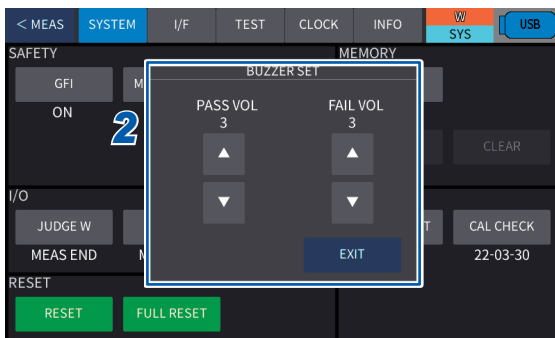

- 2 Change the value using **[▲]** or **[▼]**, and then press **[EXIT]**.

[PASS VOL]: Buzzer volume for pass judgment

[FAIL VOL]: Buzzer volume for fail judgment

0 to 5

Default setting: 3

8.7 Momentary Out

This function allows a test to be performed only when the **START** button is pressed.

When the **START** button is released, the test is forcefully terminated (same operation as for when the **STOP** button is pressed).

The **START** button must be held down until the set test time elapses to make a test judgment.

The **START** button can be enabled on the instrument, as well as using the Remote Control Box and by the external I/O start signal.

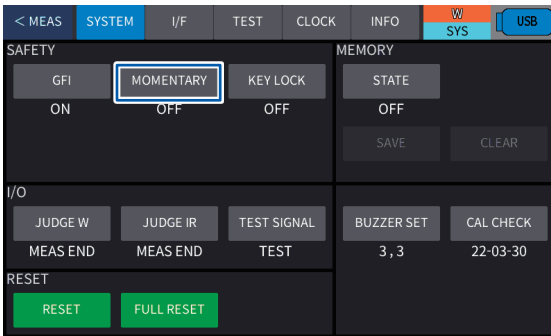

1 Press **[SYSTEM]** > **[MOMENTARY]** on the system screen.

OFF*1 Disables the momentary out function.

ON Enables the momentary out function.

*1. Default setting

8.8 Key Lock

When the key lock function is set to on, the **START** button, **STOP** button, and other buttons except for the key lock release button become disabled so that the test mode and test set values, etc. cannot be changed.

Activating the key lock function for the instrument

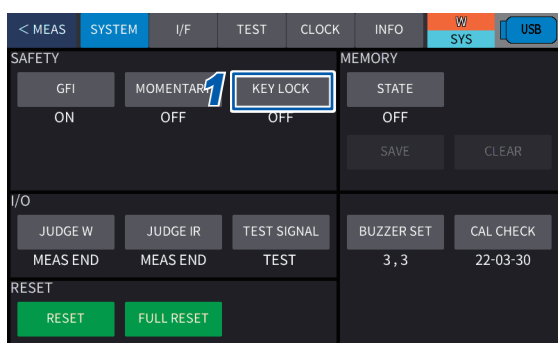

- 1 Press **[SYSTEM]** > **[KEY LOCK]** on the system screen.

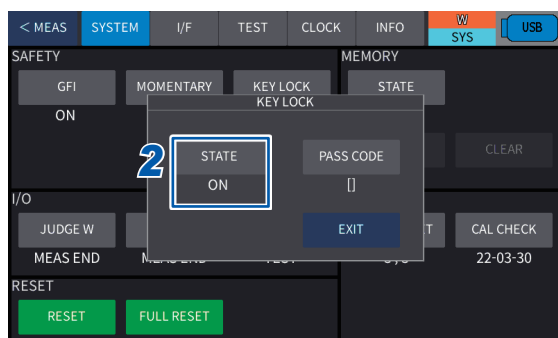

- 2 Switch between **[ON]** and **[OFF]** under **[STATE]**.

OFF *1	Disables the key lock function.
ON	Enables the key lock function.

*1. Default setting

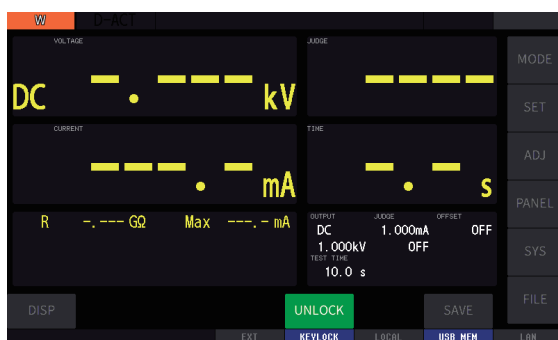

When the key lock function is set to **[ON]**, the keys are locked when the measurement screen is displayed again.

Releasing the key lock function

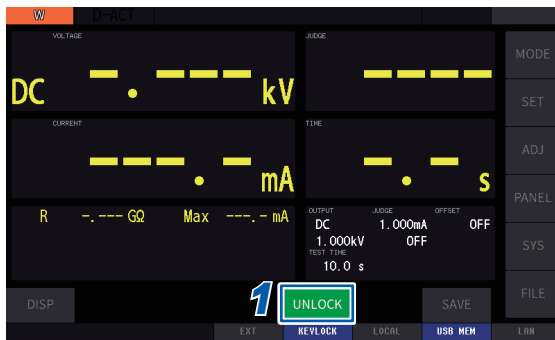

1 Press [UNLOCK].

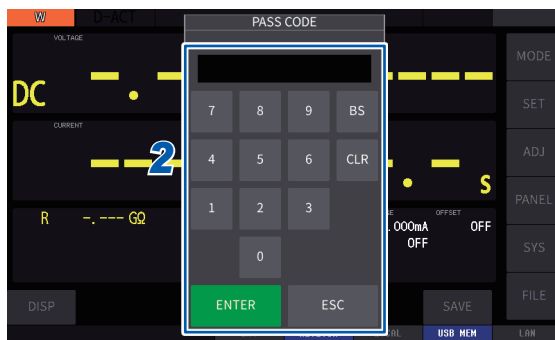

2 Enter the pass code using the numeric keypad and then press [ENTER].

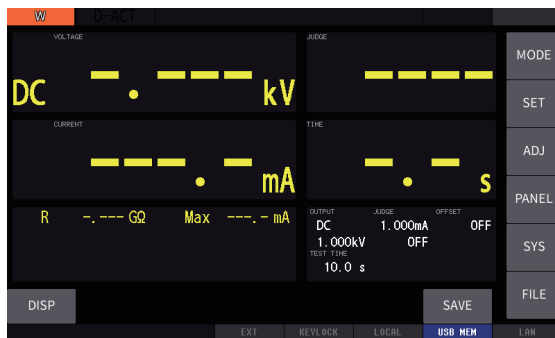

The key lock function is released.

Setting a passcode

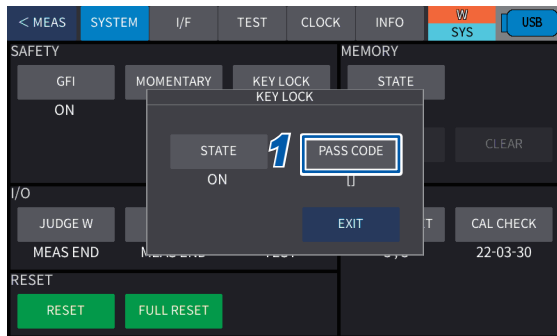

- 1 When the key lock state setting is on, press **[PASS CODE]**.

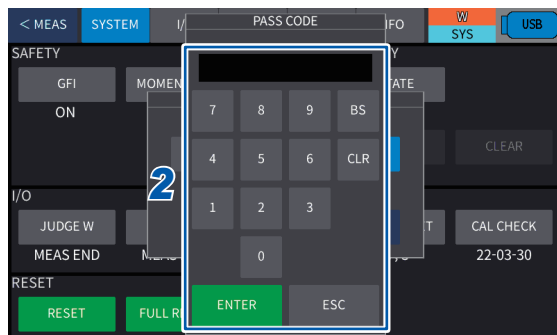

- 2 Enter the pass code using the numeric keypad and then press **[ENTER]**.

0 to 9999

Default setting: None

Key lock functions are not disabled even if the instrument is turned off.

9

Panel Memory Function

Test condition settings are saved in the internal memory of the instrument.

Test conditions can be loaded in the following ways.

- Instrument key operation
 - Communications command by each interface
 - Inputting of a signal to external I/O terminal
- See “12.2 External Input and Output Terminals and Signals” (p. 158).

Even if the instrument is turned off, the data saved in the internal memory is retained.

Test mode	Data in memory	Maximum number of measured values to be saved in memory
DCW test	Test voltage, start voltage, test time, voltage rising/falling times, judgment waiting time, current judgment upper/lower-limit values, arc detection function, offset canceling function/current compensation value, contact-check threshold value/compensation value, interval time	64
IR test	Test voltage, test time, voltage rising/falling times, judgment waiting time, resistance judgment upper/lower-limit values, offset canceling function/resistance compensation value, contact-check threshold value/compensation value, interval time	64
Program test	Test conditions/compensation value of each step, number of test steps	30
BDV measurement	Test method, initial voltage, end voltage, voltage rising speed, voltage step, voltage holding time, number of steps, arc detection function, distance between electrodes, upper reference value, number of tests	10

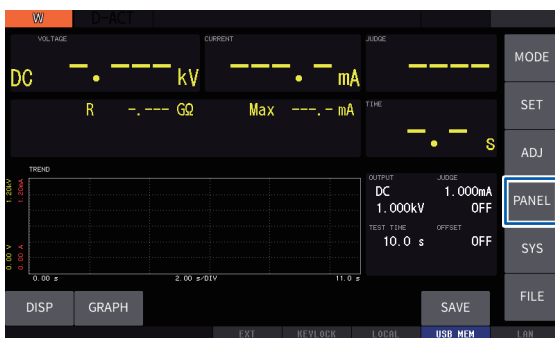

1 Press [PANEL] on the measurement screen.

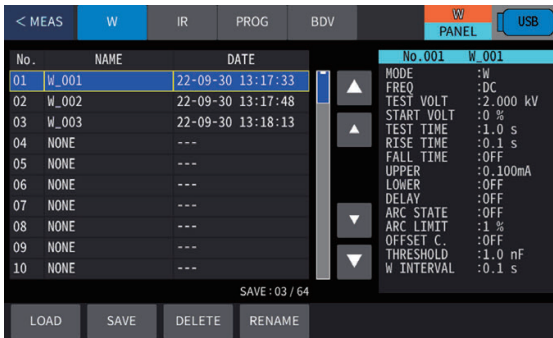

The panel screen is displayed.

Screen configuration

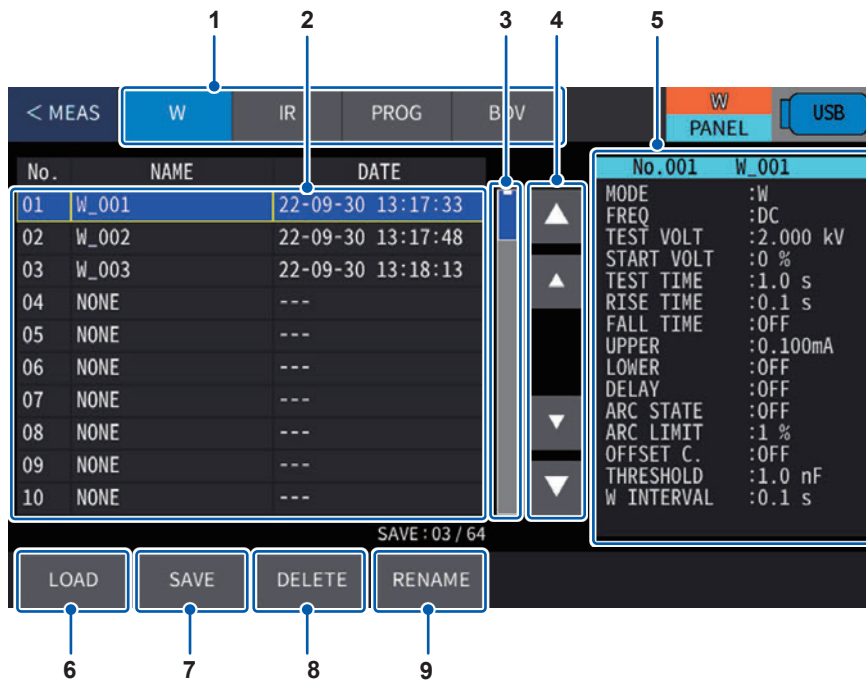

	Name	Description
1	Test mode	Displays the test mode for the test conditions.
2	Panel list	Displays a list of the panels that have been saved.
3	Scroll bar	Dragging allows you to scroll the panel.
4	Scroll key	Moves up or down the panel that is displayed.
5	Panel setting description	Displays the settings descriptions for the panel selected on the screen.
6	LOAD	Reads the selected panel.
7	SAVE	Saves the test conditions currently displayed on the measurement screen.
8	DELETE	Deletes the selected panel.
9	RENAME	Changes the name of the selected panel.

Saving test conditions (panel save function)

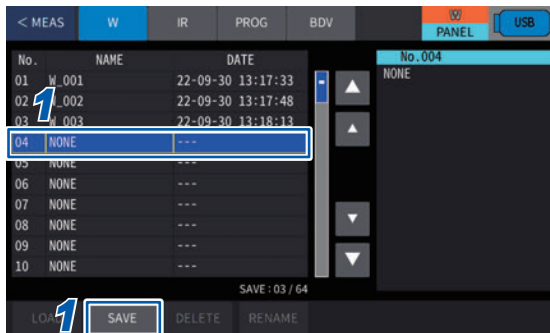

- 1 Select the No. of the panel to be saved and press **[SAVE]**.

The test conditions currently displayed on the measurement screen are saved.

A confirmation message is displayed if there is panel data for the selected No.

Loading test conditions (panel load function)

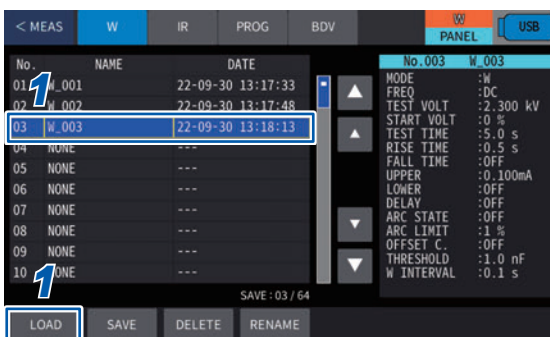

- 1 Select the panel to be loaded and press **[LOAD]**.

A confirmation message is displayed.



- 2 Press **[YES]**.

Changing the panel name

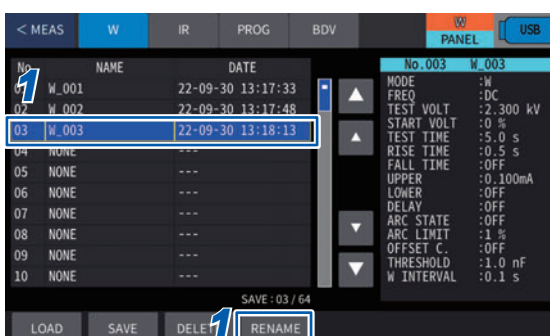

- 1 Select the panel to be renamed, and press **[RENAME]**.

The keyboard window is displayed.

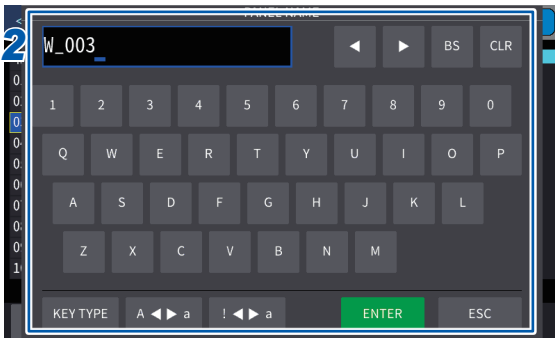

2 Enter a new name and press [ENTER].

Deleting panel data

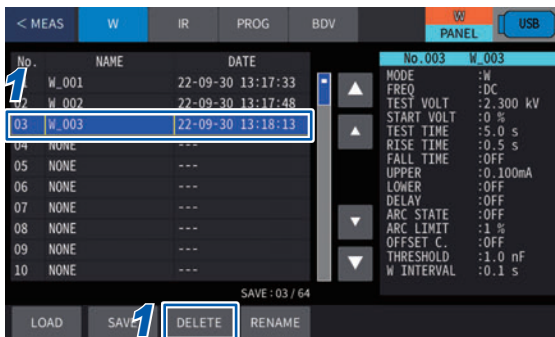

1 Select the panel to be deleted, and press [DELETE].

A confirmation message is displayed.

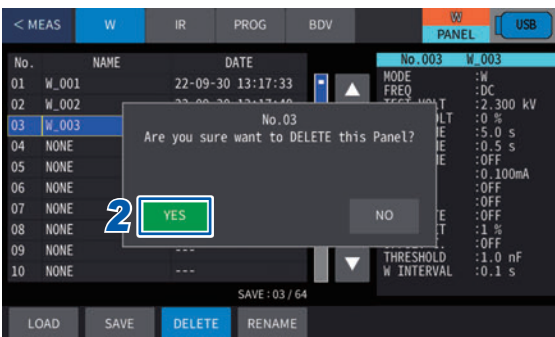

2 Press [YES].

10 USB Flash Drive

Measurement data, instrument settings, etc. can be saved to a USB flash drive. Further, you can also import the settings that have been saved to a USB flash drive.

Checking the file contents

▶ File contents saved to a USB flash drive can be checked. (p. 126)

Saving data

▶ Measurement data of the instrument, etc. can be saved to a USB flash drive. (p. 127)

- Measurement results, waveform data
- Captured screen
- Panel (test conditions), instrument settings

Importing setting data

▶ Setting data of the instrument, etc. can be imported to the instrument from the USB flash drive. (p. 137)

- Panel (test conditions), instrument settings

Others

▶

- Files or folders on a USB flash drive can be deleted. (p. 141)
- A folder can be created on a USB flash drive. (p. 141)
- You can check the use rate of the USB flash drive and the file system. (p. 142)

CAUTION



■ **Do not transport the instrument while it is connected to a USB flash drive.**

Doing so could damage the USB flash drive.

File formats

The following files can be used for this instrument.

Contents	File type	Extension	Create	Import	Display
Measurement data	CSV files	.CSV	✓	–	✓
Text	TXT files	.TXT	–	–	✓
Captured screen	BMP files	.BMP	✓	–	–
	PNG files	.PNG			
Test conditions	PNL files	.PNL	✓	✓	–
All settings	ALL files	.ALL	✓	✓	–

The instrument cannot display double-byte characters (Japanese, etc.) Double-byte characters are replaced by “??”

Specifications of USB flash drives to be used

Connector	USB type A connector
Electrical specifications	USB2.0
Power supply	500 mA max.
Number of ports	1
Supported USB flash drives	USB Mass Storage Class compatible

10.1 Using USB Flash Drive

A USB flash drive and USB communications (function) cannot be used simultaneously for this instrument.

When using a USB flash drive, set the USB memory interface.

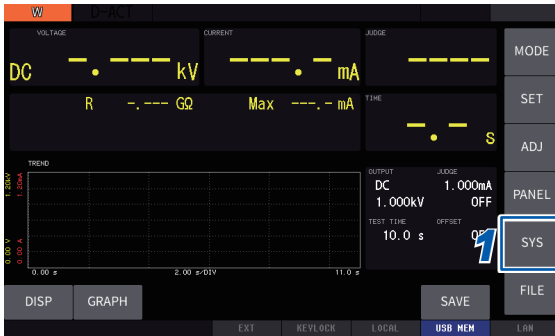

1 Press [SYS] on the measurement screen.

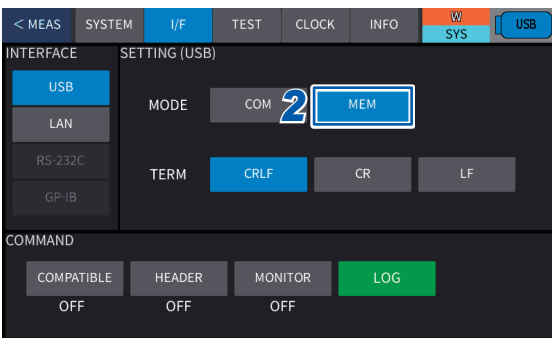

2 Press [I/F] > [USB] > [MEM] on the system screen.

10.2 Inserting and Removing a USB Flash Drive

⚠ CAUTION

- **Do not insert a USB flash drive by force in the wrong direction.**

The instrument could be damaged.

- **Do not transport the instrument while it is connected to a USB flash drive.**



Doing so could damage the USB flash drive.

- **Do not apply vibration or impact to the instrument when it is accessing the USB flash drive. Do not turn off the instrument. Do not remove the USB flash drive from the instrument.**

The data saved on the USB flash drive could be damaged or lost.

- **Take steps to ensure that static electricity is not applied to USB flash drives.**

Application of static electricity could damage the USB flash drive, or cause the instrument to malfunction. The instrument could fail to start up if it is turned on while a USB flash drive is inserted.



- **Back up and store important data in a safe place.**

USB flash drives have a service life since they use flash memory. They lose the ability to save and import data after extended and frequent use. In such cases, buy a new memory. Hioki is not liable for data stored on USB flash drives, regardless of the nature or cause of the accident or damage involved.

Inserting the USB flash drive

Insert the USB flash drive into the USB memory interface on the front of the instrument.

- Do not insert anything other than a mass storage class-compatible USB flash drive.
- Not all commercially-available USB flash drives are compatible.
- If the USB flash drive is not detected, try another USB flash drive.
- USB hubs cannot be used.
- It may take longer to recognize and process a USB flash drive over 100 GB.

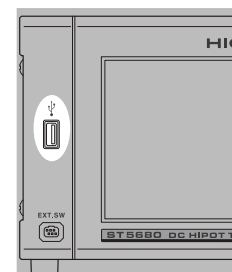

Front

Removing the USB flash drive

Check that the USB flash drive is not being accessed by the device before removing. Instrument removal operations are not required.

Screen display when a USB flash drive is in use

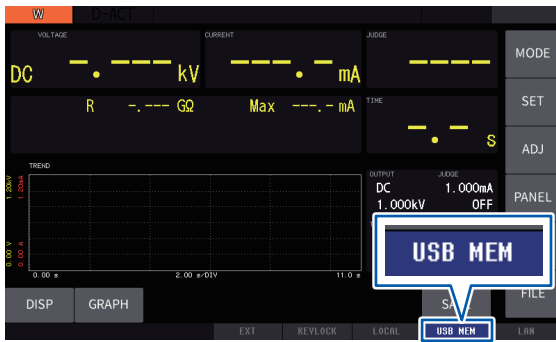

Measurement screen

When the USB flash drive is properly recognized, the USB memory icon turns blue.

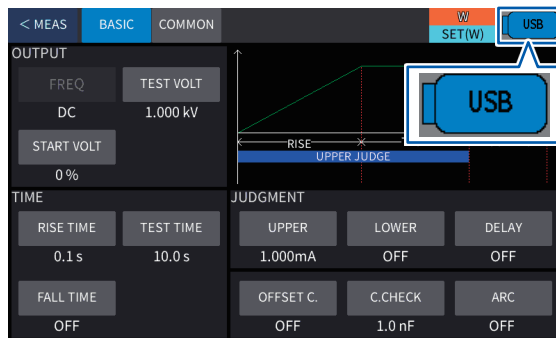

Screens other than measurement screen

10.3 Checking File Contents on a USB Flash Drive

Files are displayed for you to check the contents.

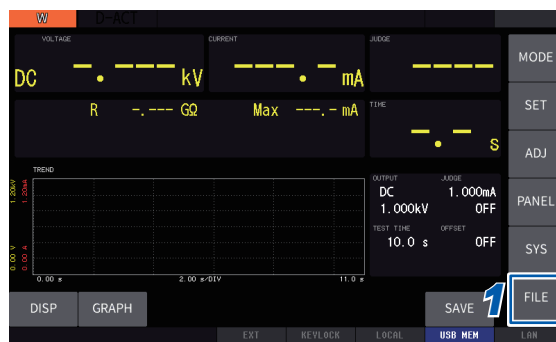

1 Press [FILE] on the measurement screen.

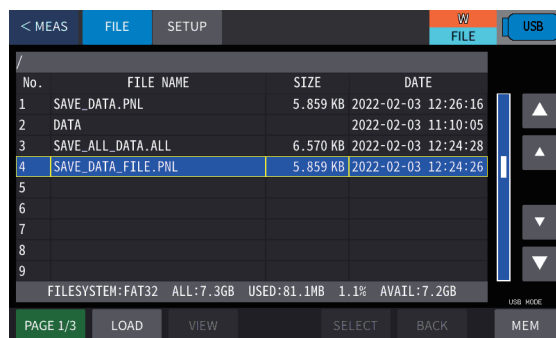

The file screen is displayed.

Up to 127 characters can be recognized for a file name.

10.4 Settings for Saving the Data

Set beforehand to save the measurement results to the USB flash drive.

Setting the save method and items to be saved

The save method and items to be saved when [SAVE] is pressed on the measurement screen are set.

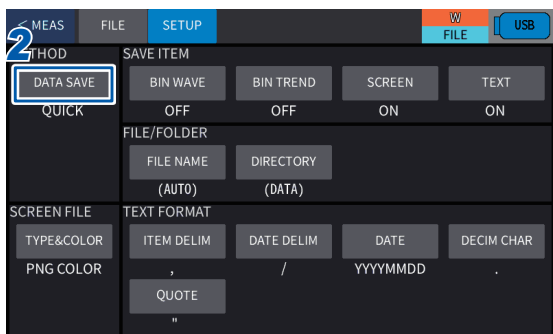

- 1 Press [FILE] > [SETUP] on the measurement screen.
- 2 Press [DATA SAVE].

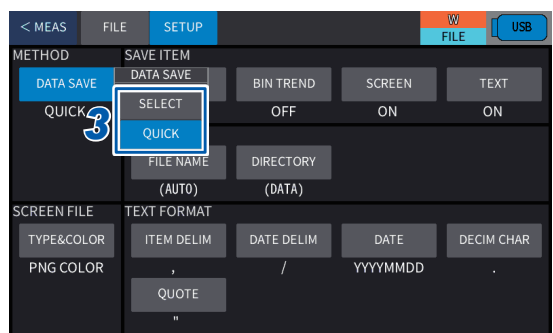

- 3 Set the operations when [SAVE] is pressed.

SELECT	Displays the save details selection window.
QUICK*1	Saves the saved items that have been set immediately.

*1. Default setting

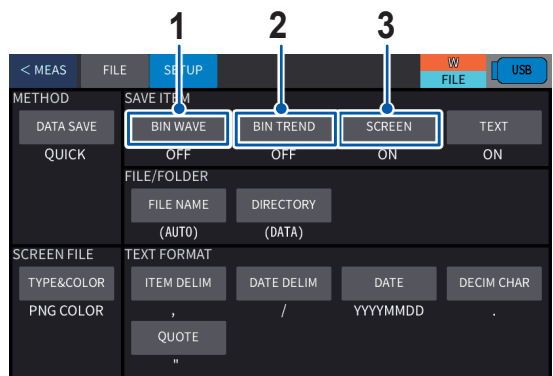

- 4 Set the items to be saved.

	Type	Description	
1	BIN WAVE	ON	Saves waveform data in the binary file format.
		OFF*1	Not saved.
2	BIN TREND	ON	Saves trend (chronological) waveform data in the binary file format.
		OFF*1	Not saved.
3	SCREEN	ON	Saves measurement screen images.
		OFF*1	Not saved.

*1. Default setting

Pressing **[TEXT]** displays the window for selecting items to be saved in the text format (CSV file format).

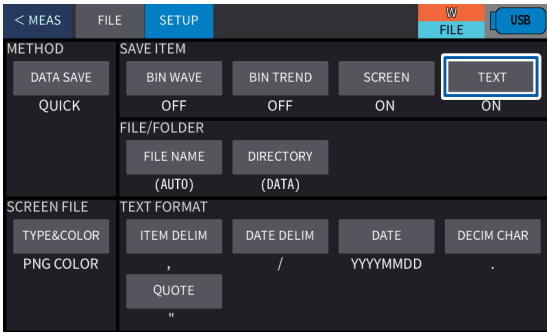

Type		Description
SAVE	ON* ¹	Saves test results in the text format.
	OFF	Not saved.
JUDGE	ON* ¹	Saves judgment results in the text format when the [SAVE] setting is on.
	OFF	Not saved.
WAVE	ON	Saves waveform data in the text format when the [SAVE] setting is on.
	OFF* ¹	Not saved.
TREND	ON	Saves trend (chronological) waveform data in the text format when the [SAVE] setting is on.
	OFF* ¹	Not saved.

*1. Default setting

Setting the text save format

The delimiters and quote marks for when the test results are saved in the text format (CSV file format) are set.

- 1 Press **[FILE]** > **[SETUP]** on the measurement screen.

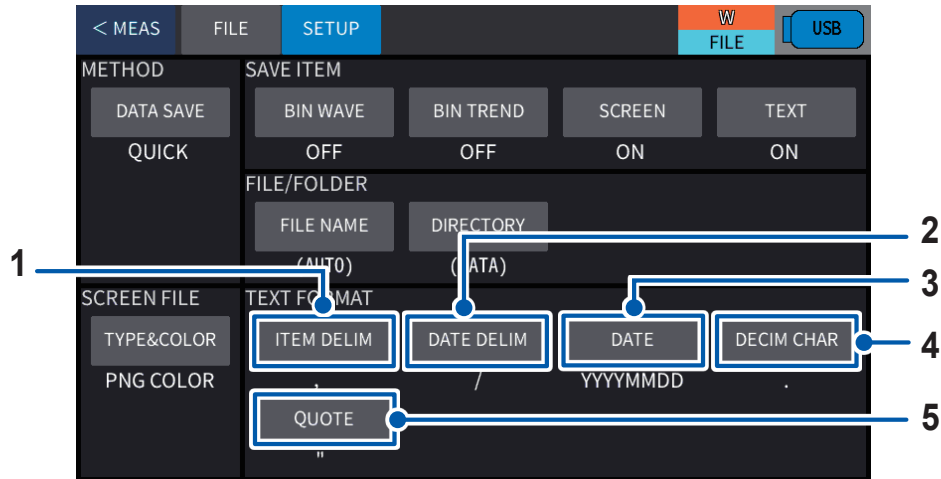

1. **[ITEM DELIM]**: Delimiter for items

, *1	Comma
TAB	Tab
;	Semicolon
.	Period
SPACE	Space

*1. Default setting

2. **[DATE DELIM]**: Delimiter for date

/ *2	Slash
-	Hyphen
.	Period

*2. Default setting

3. **[DATE]**: Date format

YYYYMMDD *3, MMDDYYYY , DDMMYYYY , YYMMDD , MMDDYY , DDMMYY

*3. Default setting

4. **[DECIM CHAR]**: Decimal point character

. *4	Period
,	Comma

*4. Default setting

5. **[QUOTE]**: Quotation for items

OFF	None
" *5	Double quotes
'	Single quotes

*5. Default setting

Setting the file and folder names

The file and folder names when test results are saved are set.

File name

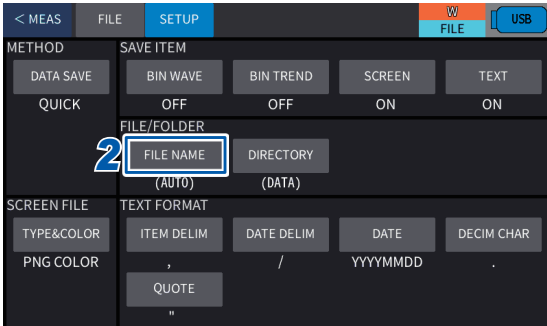

1 Press [FILE] > [SETUP] on the measurement screen.

2 Press [FILE NAME].

The keyboard window is displayed.

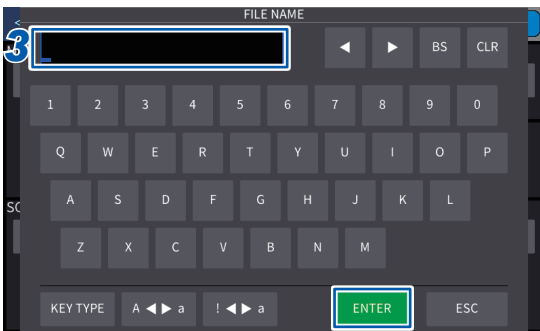

3 Enter a name for the saved file and press [ENTER].

Up to 32 characters

When the file name is not to be specified, a name is automatically set (date and time of when the file is saved).

Folder name

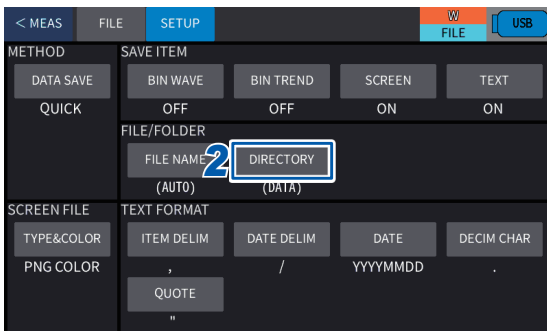

1 Press [FILE] > [SETUP] on the measurement screen.

2 Press [DIRECTORY].

The keyboard window is displayed.

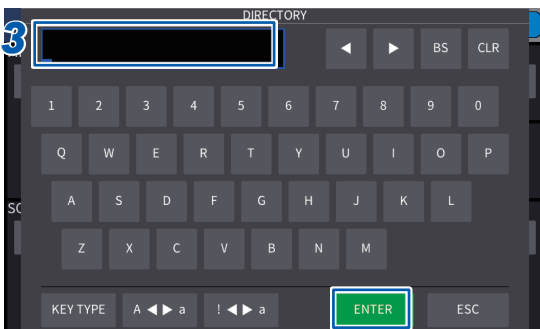

3 Enter a name for the save destination holder and press [ENTER].

Up to 32 characters

When the folder name is not to be specified, a name is automatically set (DATA).

Setting the screen save format

The format and color for when a screen is saved are set.

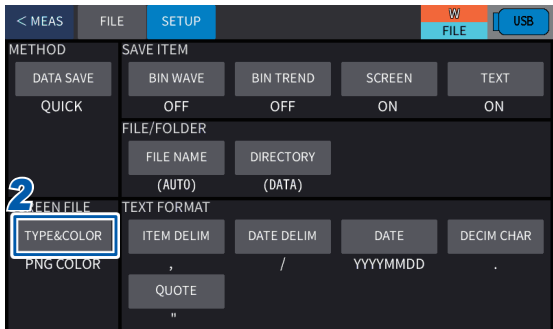

1 Press **[FILE]** > **[SETUP]** on the measurement screen.

2 Press **[TYPE&COLOR]**.

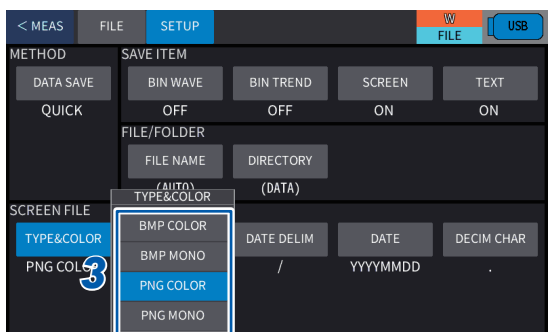

3 Set the format and color.

BMP COLOR ^{*1}	Color BMP format
BMP MONO	Gray-scale BMP format
PNG COLOR	Color PNG format
PNG MONO	Gray-scale PNG format

*1. Default setting

10.5 Saving the Test Results

Save method



- 1 After finishing a measurement, press **[SAVE]** on the measurement screen.

The save operation varies depending on the save method and items to be saved (p. 127).

[SAVE] is enabled only when a USB flash drive has been inserted into the instrument.

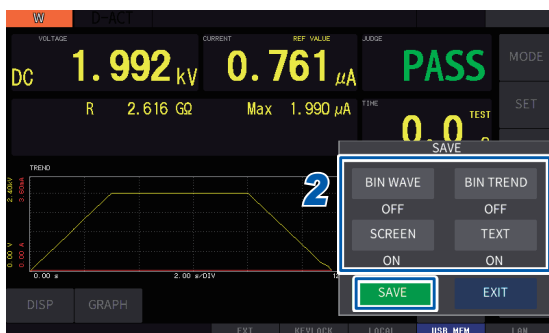

- 2 When **[DATA SAVE]** is set to **[SELECT]**, select the items to be saved and press **[SAVE]**.

Checking the test results that have been saved

Saves using DCW mode

"HIOKI E.E. CORPORATION","ST5680","Ver.,""V1.00" "Serial No.,""123456789"	Header
"DATE","2021/10/25" "TIME","12:34:37"	Save date and time
"MODE","W" "FREQUENCY","DC ","" "TEST VOLTAGE"," 1000","V" "START VOLTAGE"," 0","%" "TEST TIME"," 0.4","s" "RISE TIME"," 0.1","s" "FALL TIME","OFF","" "DELAY TIME","OFF","" "UPPER LIMIT"," 2.000","mA" "LOWER LIMIT","OFF","" "ARC","OFF" "ARC LIMIT"," 1","mA" "OFFSET CANCEL","0" "CONTACT CHECK","OFF" "AUTO RANGE","1" "KEEP DATA","0"	Test conditions
"MODE","W" "START TIME","2021/10/25 12:34:29" "VOLTAGE"," 9.960E+02","V" "CURRENT"," 5.729E-05","A" "RESISTANCE"," 0.000E+00","ohm" "ELAPSED TIME"," 0.0","s" "TIMER TYPE","0" "JUDGE","PASS"	Test results, judgment results (JUDGE setting is on)
"WAVEFORM","INSTANT","250010" "VOLTAGE","CURRENT" "-9.375E+00"," 7.233E-06" "-7.617E+00"," 7.233E-06" "-5.859E+00"," 8.881E-06" "-2.930E+00"," 1.172E-05" : :	Measurement waveform (WAVE setting is on)
"WAVEFORM","TREND","3" "VOLTAGE","CURRENT" " 4.922E+02"," 3.396E-05" " 9.961E+02"," 5.727E-05" " 9.960E+02"," 5.729E-05"	Trend waveform (TREND setting is on)

Saves using W-IR mode

<p>"HIOKI E.E. CORPORATION","ST5680","Ver. ","V1.00" "Serial No. ","123456789"</p>	<p>Header</p>
<p>"DATE","2021/10/25" "TIME","20:03:01"</p>	<p>Save date and time</p>
<p>"MODE","WIR" "MODE","W" "FREQUENCY","DC ", "" "TEST VOLTAGE"," 300","V" "START VOLTAGE"," 0","%" "TEST TIME"," 0.4","s" "RISE TIME"," 0.1","s" "FALL TIME","OFF", "" "DELAY TIME","OFF", "" "UPPER LIMIT"," 2.000","mA" "LOWER LIMIT","OFF", "" "ARC","OFF" "ARC LIMIT"," 1","mA" "OFFSET CANCEL","0" "CONTACT CHECK","OFF" "AUTO RANGE","1" "KEEP DATA","0" "MODE","IR" "TEST VOLTAGE"," 1000","V" "TEST TIME"," 0.4","s" "RISE TIME"," 0.1","s" "FALL TIME","OFF", "" "DELAY TIME","OFF", "" "UPPER LIMIT","OFF", "" "LOWER LIMIT"," 0.5000 ","Mohm" "OFFSET CANCEL","0" "CONTACT CHECK","OFF" "AUTO RANGE","1" "KEEP DATA","0"</p>	<p>Test conditions</p>
<p>"MODE","W" "START TIME","2021/10/25 20:02:54" "VOLTAGE"," 2.957E+02","V" "CURRENT"," 2.441E-05","A" "RESISTANCE"," 0.000E+00","ohm" "ELAPSED TIME"," 0.0","s" "TIMER TYPE","0" "JUDGE","PASS" "MODE","IR" "START TIME","2021/10/25 20:02:54" "VOLTAGE"," 9.943E+02","V" "RESISTANCE"," 9.500E+05","ohm" "ELAPSED TIME"," 0.0","s" "TIMER TYPE","0" "JUDGE","PASS"</p>	<p>Test results, judgment results (JUDGE setting is on)</p>

Save in the program mode

"HIOKI E.E. CORPORATION","ST5680","Ver.,""V1.00" "Serial No.,""123456789"	Header
"DATE","2021/10/25" "TIME","20:12:52"	Save date and time
"STEP NO.,"" 1" "MODE","W" "FREQUENCY","DC ", "" "TEST VOLTAGE"," 500","V" "START VOLTAGE"," 0", "%" "TEST TIME"," 0.4","s" "RISE TIME"," 0.1","s" "FALL TIME"," 0.1","s" "DELAY TIME","OFF", "" "UPPER LIMIT"," 1.000","mA" "LOWER LIMIT","OFF", "" "ARC","OFF" "ARC LIMIT"," 1","mA" "OFFSET CANCEL","0" "CONTACT CHECK","OFF" "AUTO RANGE","1" "KEEP DATA","0" "STEP NO.,"" 2" "MODE","IR" "TEST VOLTAGE"," 500","V" "TEST TIME"," 0.4","s" "RISE TIME"," 0.1","s" "FALL TIME","OFF", "" "DELAY TIME","OFF", "" "UPPER LIMIT","OFF", "" "LOWER LIMIT"," 0.5000 ","Mohm" "OFFSET CANCEL","0" "CONTACT CHECK","OFF" "AUTO RANGE","1" "KEEP DATA","0"	Test conditions
"STEP NO.,"" 1" "MODE","W" "START TIME","2021/10/25 20:12:29" "VOLTAGE"," 4.956E+02","V" "CURRENT"," 3.387E-05","A" "RESISTANCE"," 0.000E+00","ohm" "ELAPSED TIME"," 0.0","s" "TIMER TYPE","0" "JUDGE","PASS" "STEP NO.,"" 2" "MODE","IR" "START TIME","2021/10/25 20:12:29" "VOLTAGE"," 4.955E+02","V" "RESISTANCE"," 4.830E+05","ohm" "ELAPSED TIME"," 0.0","s" "TIMER TYPE","0" "JUDGE","LFAIL" "JUDGE","FAIL"	Test results, judgment results (JUDGE setting is on)

Saves using BDV mode

<p>"HIOKI E.E. CORPORATION","ST5680","Ver. ","V1.00" "Serial No. ","123456789"</p>	<p>Header</p>
<p>"DATE","2021/10/25" "TIME","19:41:08"</p>	<p>Save date and time</p>
<p>"MODE","BDV" "METHOD","RATE" "DISTANCE"," 0.01","mm" "FREQUENCY","DC ","" "TEST COUNT"," 1" "START VOLTAGE"," 100","V" "END VOLTAGE"," 1000","V" "RISE RATE"," 200 ","V/s" "UPPER LIMIT"," 1.000","mA" "ARC LIMIT","OFF",""</p>	<p>Test conditions</p>
<p>"MODE","BDV" "START TIME","2021/10/25 19:40:35" "BREAKDOWN VOLTAGE MEDIAN"," 0","V" "BREAKDOWN VOLTAGE MEAN"," 0","V" "BREAKDOWN VOLTAGE STANDARD"," 0","V" "ELECTRIC STRENGTH MEDIAN"," 0","V/mm" "ELECTRIC STRENGTH MEAN"," 0","V/mm" "ELECTRIC STRENGTH STANDARD"," 0","V/mm" "ELAPSED TIME"," 0.0","s"</p>	<p>Test results (JUDGE setting is on)</p>
<p>"TEST NO. "," 1" "CURRENT"," 0","A" "ELAPSED TIME"," 0.0","s" "BREAKDOWN VOLTAGE"," 0","V" "ELECTRIC STRENGTH"," 0","kV/mm"</p>	<p>Test results for each test</p>
<p>"WAVEFORM","INSTANT","262144" "VOLTAGE","CURRENT" " 9.076E+02"," 4.614E-05" " 9.158E+02"," 5.777E-05" " 9.076E+02"," 6.592E-05" " 9.059E+02"," 5.960E-05" : :</p>	<p>Measurement waveform (WAVE setting is on)</p>
<p>"WAVEFORM","TREND","23" "VOLTAGE","CURRENT" " 1.060E+02"," 1.516E-05" " 1.465E+02"," 1.732E-05" " 1.862E+02"," 1.921E-05" : :</p>	<p>Trend waveform (TREND setting is on)</p>

10.6 Saving and Importing the Test Conditions

Saves the instrument settings information to the USB flash drive as a settings file.

Imports the settings file that has been saved to the USB flash drive and restores the settings.

Saving test conditions

The following two types of items can be saved.

Type	Information to be saved	Extension
SAVE	Test conditions The current test conditions and all test conditions saved in the panel memory can be saved for all modes.	.PNL
ALL SAVE	All settings The interface, system, file settings, and other settings including the test conditions saved by [SAVE] can be saved together.	.ALL

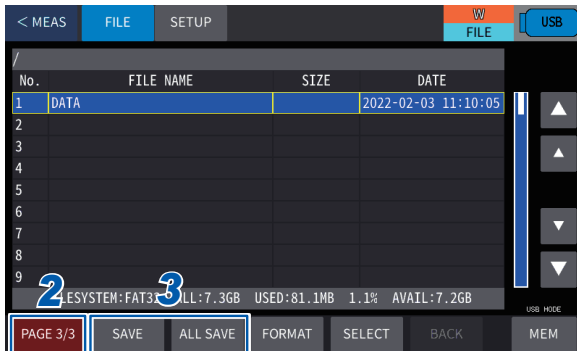

1 Press **[FILE]** > **[FILE]** on the measurement screen.

2 Press **[PAGE]** to switch to **[PAGE 3/3]**.

3 Press **[SAVE]** or **[ALL SAVE]**.

The keyboard window is displayed.

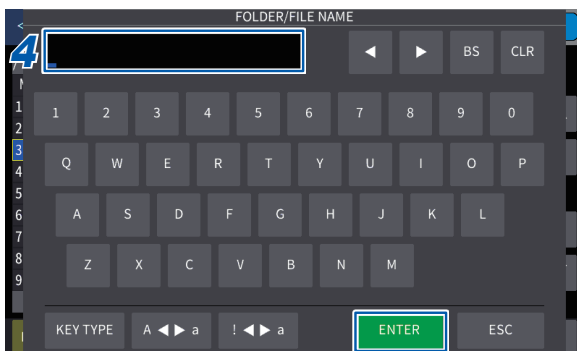

4 Enter a name for the file and press **[ENTER]**.

Up to 31 characters

See "3.3 Basic Screen Operation" (p. 35).

Loading test conditions

The following two types of settings files can be imported.

- PNL file (test conditions)
- ALL file (all settings)

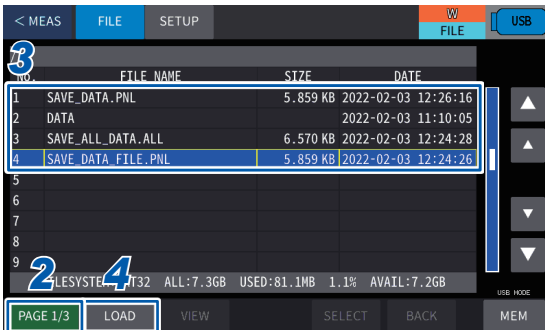

- 1 Press **[FILE]** > **[FILE]** on the measurement screen.
- 2 Press **[PAGE]** to switch to **[PAGE 1/3]**.
- 3 Select files with a “.PNL” or “.ALL” extension.
- 4 Press **[LOAD]**.
A confirmation message is displayed.

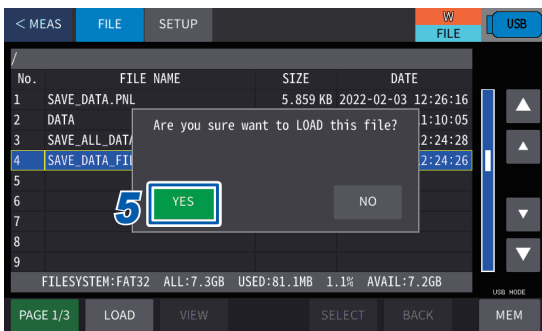

- 5 Press **[YES]**.

10.7 Editing Files and Folders

You can edit the files and folders that have been saved to the USB flash drive.

- Formatting USB flash drive (p. 139)
- Creating folders (p. 141)
- Deleting a file or folder (p. 141)
- Renaming a file or folder (p. 142)
- Information display (measurement results and measurement screen) (p. 142)

Formatting the USB flash drive

Format (initialize) the USB flash drive to be used.

Insert the USB flash drive to be formatted into the USB memory interface on the front and start formatting.

The instrument formats using either FAT32 or FAT16.

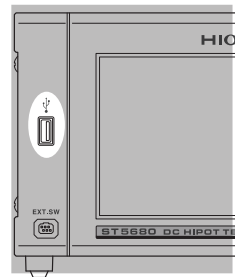

IMPORTANT

- When formatting, all data saved to the USB flash drive will be deleted and cannot be restored. Check the content carefully before implementing.
- It is recommended that you make sure to back up all important data saved to the USB flash drive.

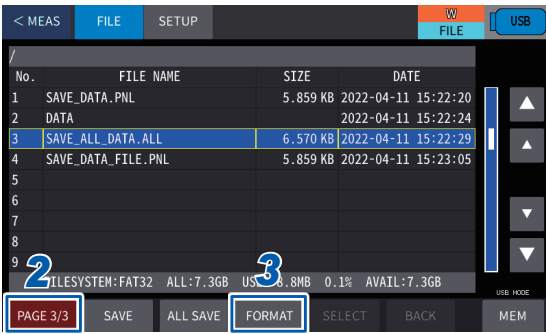

1 Press [FILE] > [FILE] on the measurement screen.

2 Press [PAGE] to switch to [PAGE 3/3].

3 Press [FORMAT].

A confirmation message is displayed.

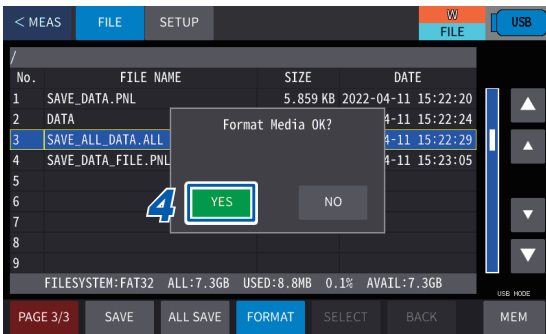

4 Press [YES].

A confirmation message is displayed again.

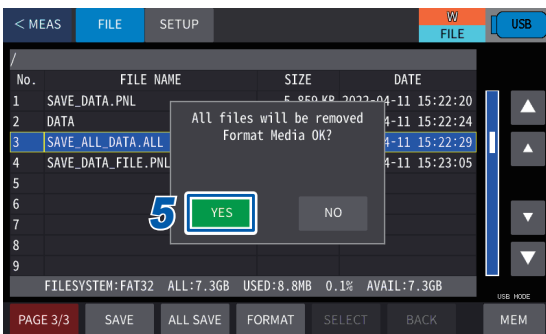

5 Press [YES].

Creating a folder

Create a folder on the USB flash drive.

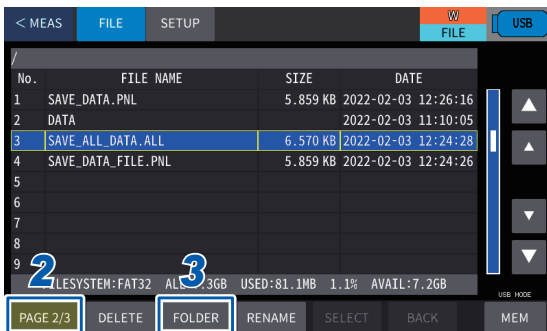

1 Press **[FILE]** > **[FILE]** on the measurement screen.

2 Press **[PAGE]** to switch to **[PAGE 2/3]**.

3 Press **[FOLDER]**.

The keyboard window is displayed.

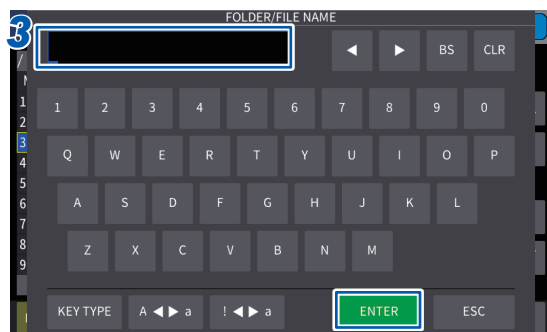

4 Enter a name for the holder and press **[ENTER]**.

Up to 31 characters

See "3.3 Basic Screen Operation" (p. 35).

Deleting a file or folder

Deletes the files or folders that have been saved to the USB flash drive.

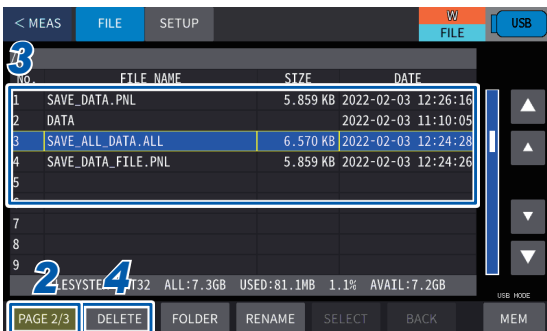

1 Press **[FILE]** > **[FILE]** on the measurement screen.

2 Press **[PAGE]** to switch to **[PAGE 2/3]**.

3 Select the file or folder to be deleted.

4 Press **[DELETE]**.

A confirmation message is displayed.

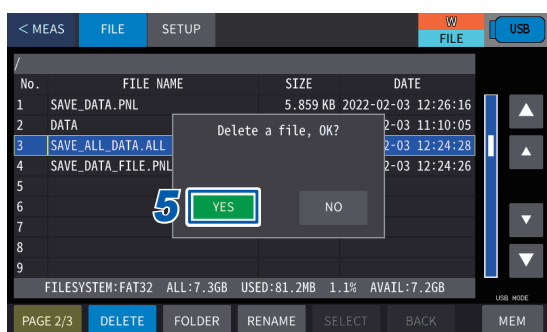

5 Press **[YES]**.

IMPORTANT

Deleted files and folders cannot be restored. Check the content carefully before implementing.

Change the name of a file or folder

Changes the name of the files or folders that have been saved to the USB flash drive.

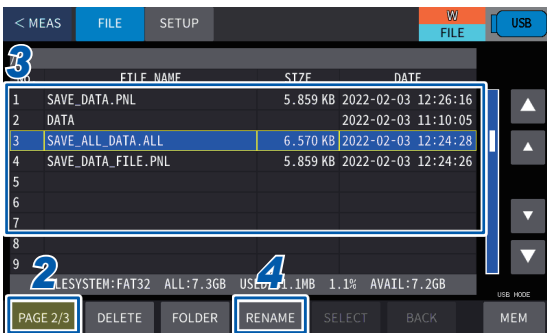

1 Press [FILE] > [FILE] on the measurement screen.

2 Press [PAGE] to switch to [PAGE 2/3].

3 Select the file or folder to be deleted.

4 Press [RENAME].

The keyboard window is displayed.

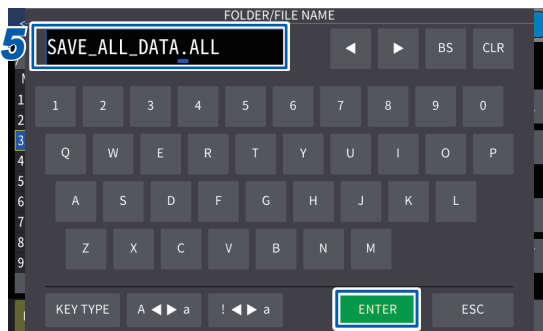

5 Change the name of the file or folder and press [ENTER].

See "3.3 Basic Screen Operation" (p. 35).

Displaying the information

You can use the screen to check the test results files (CSV) that have been saved to the USB flash drive.



1 Press [FILE] > [FILE] on the measurement screen.

2 Press [PAGE] to switch to [PAGE 1/3].

3 Select the file to be checked.

4 Press [VIEW].

The test result screen is displayed.

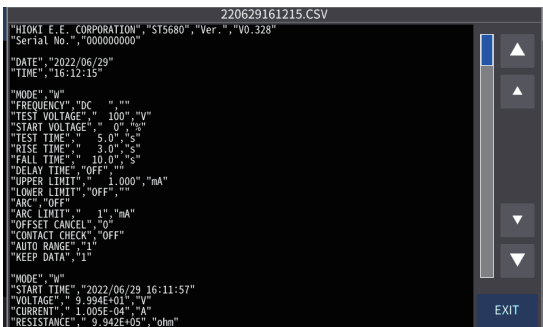

11 System Settings

11.1 Checking the Instrument Information

You can check the system information in the instrument.

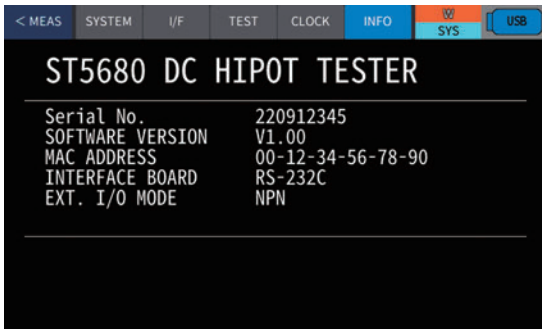

1 Press **[SYS]** > **[INFO]** on the measurement screen.

Serial No.	This is the serial number.
SOFTWARE VERSION	This is the software version.
MAC ADDRESS	This is the MAC address.
INTERFACE BOARD	This is the name of the optional interface board that is in use. NONE: Interface board not used RS-232C: The Z3001 RS-232C interface is installed. GP-IB: The Z3000 GP-IB interface is installed.
EXT. I/O MODE	External I/O output mode NPN: Current sink output mode PNP: Current source output mode

11.2 Self-test Function

You can self-test for errors in the instrument.

Touch screen test

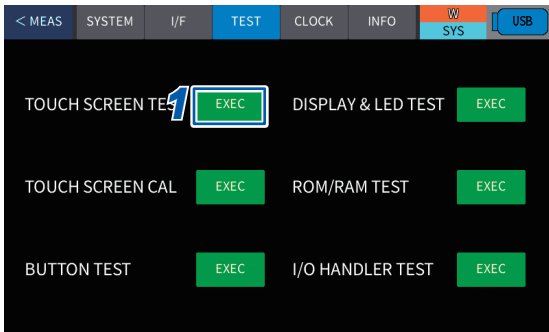

You can check that the touch screen is operating normally.

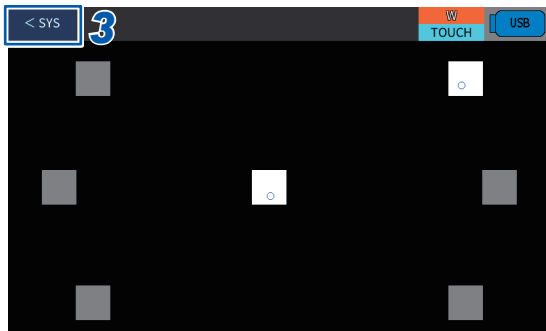

1 Press [SYS] > [TEST] > [EXEC] of [TOUCH SCREEN TEST] on the measurement screen.



2 Press each gray square in order.

 (Gray)	Testing is not implemented.
 (White)	The touch screen recognized that the gray squares had been properly pressed.
 (Red)	Areas other than the gray squares have been pressed. If the gray squares do not turn white when they are pressed a few times, calibrate the touch screen. (p. 145)

3 When the test is finished, press [< SYS].

The system screen is displayed again.

IMPORTANT

If the gray squares do not turn white when they are pressed after touch screen calibration, the touch screen may be damaged. Please contact your authorized Hioki distributor or reseller.

Calibrating the touch screen

You can calibrate the touch screen position.

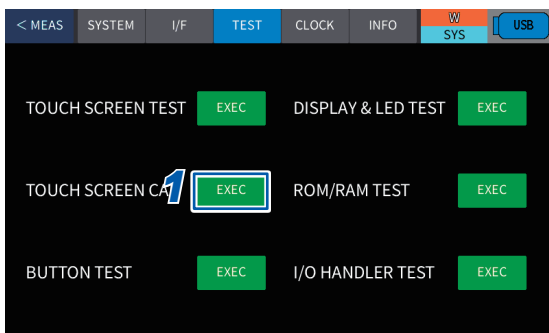

- 1 Press [SYS] > [TEST] > [EXEC] of [TOUCH SCREEN CAL] on the measurement screen.

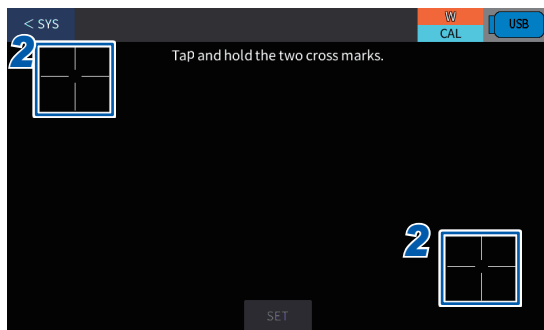

- 2 Press and hold down the center of the two [+] symbols for approximately for 2 seconds.
Green circles appear. When the two [+] symbols change to green circles, [SET] is displayed.

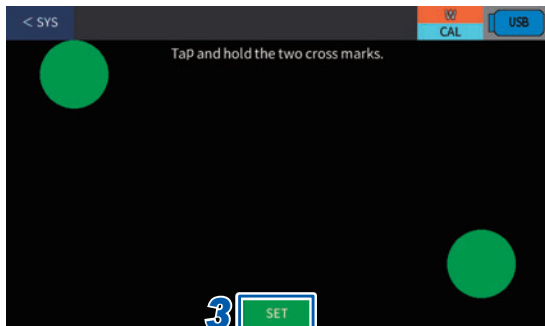

- 3 Press [SET].

IMPORTANT

If [SET] is not displayed, repairs are necessary. Please contact your authorized Hioki distributor or reseller.

Testing the instrument buttons and rotary knob

The operation of the **START** button, **STOP** button, and rotary knob on the instrument is checked.

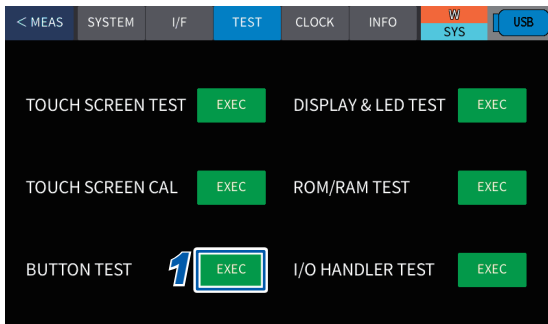

1 Press **[SYS]** > **[TEST]** > **[EXEC]** of **[BUTTON TEST]** on the measurement screen.

- 2** Press the **START** button and check that **[<]** is displayed next to **[START BUTTON]** in the display area.
- 3** Press the **STOP** button and check that **[<]** is displayed next to **[STOP BUTTON]** in the display area.
- 4** Press the rotary knob and check that **[<]** is displayed next to **[KNOB (PUSH)]** in the display area.
- 5** Turn the rotary knob clockwise and check that **[<]** is displayed next to **[KNOB (UP)]** in the display area.
- 6** Turn the rotary knob counterclockwise and check that **[<]** is displayed next to **[KNOB (DOWN)]** in the display area.

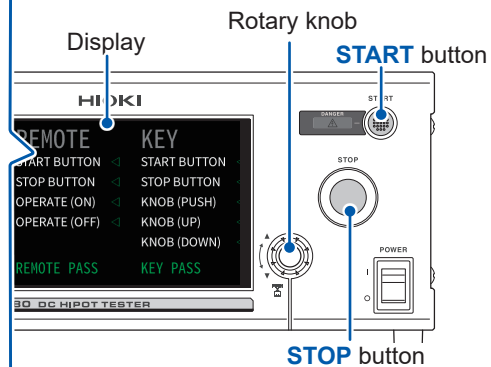
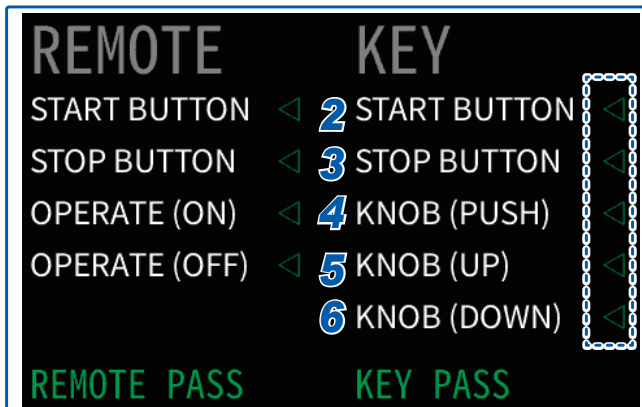

Instrument front side

IMPORTANT

If the operation of the **START** button, **STOP** button, and rotary knob on the instrument cannot be detected properly, repairs are necessary. Please contact your authorized Hioki distributor or reseller.

Testing the Remote Control Box switches

Check the operation of the **START** switch, **STOP** switch, and **OPERATE** switch on the 9613 Remote Control Box (Single) and 9614 Remote Control Box (Dual).

See “16.5 Remote Control Box (Option)” (p. 239).

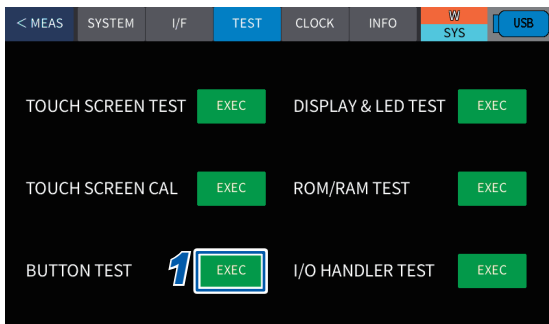

1 Press [SYS] > [TEST] > [EXEC] of [BUTTON TEST] on the measurement screen.

- 2** Press the **START** switch on the remote control and check that [◀] is displayed next to [START BUTTON] in the display area.
- 3** Press the **STOP** switch on the remote control and check that [◀] is displayed next to [STOP BUTTON] in the display area.
- 4** Press the **OPERATE** switch to turn on the remote control and check that [◀] is displayed next to [OPERATE (ON)] in the display area.
- 5** Press the **OPERATE** switch to turn off the remote control and check that [◀] is displayed next to [OPERATE (OFF)] in the display area.

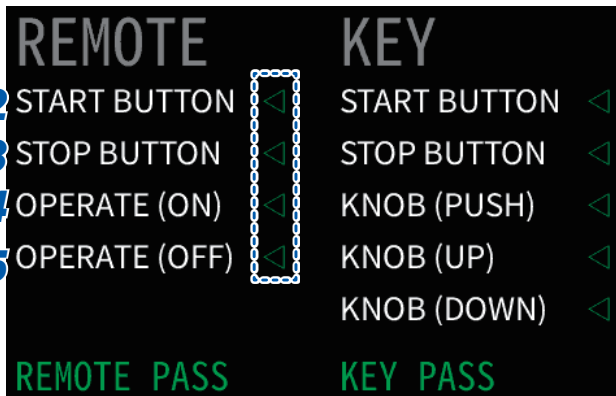

Instrument display area

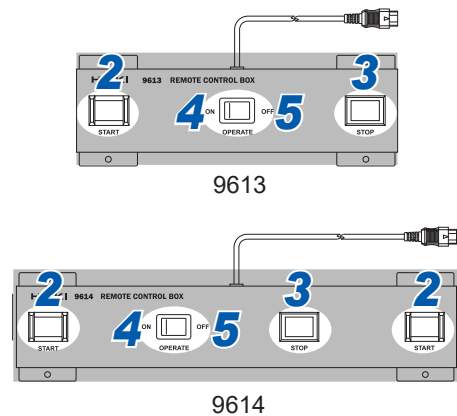

IMPORTANT

If the operation of the **START** switch, **STOP** switch, and **OPERATE** switch on the remote control cannot be detected properly, repairs are necessary. Please contact your authorized Hioki distributor or reseller.

Testing the screen display

The screen display status and **DANGER** lamp on/off status are checked.

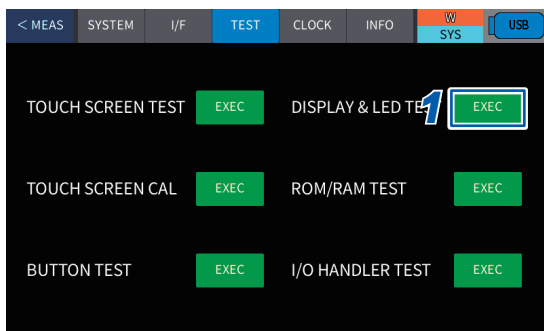
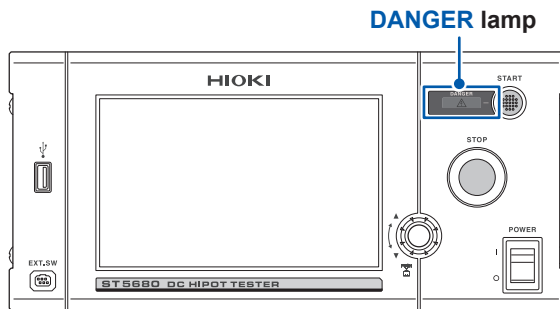

1 Press **[SYS]** > **[TEST]** > **[EXEC]** of **[DISPLAY & LED TEST]** on the measurement screen.

2 Press the screen 5 times.
The screen color will toggle in order.

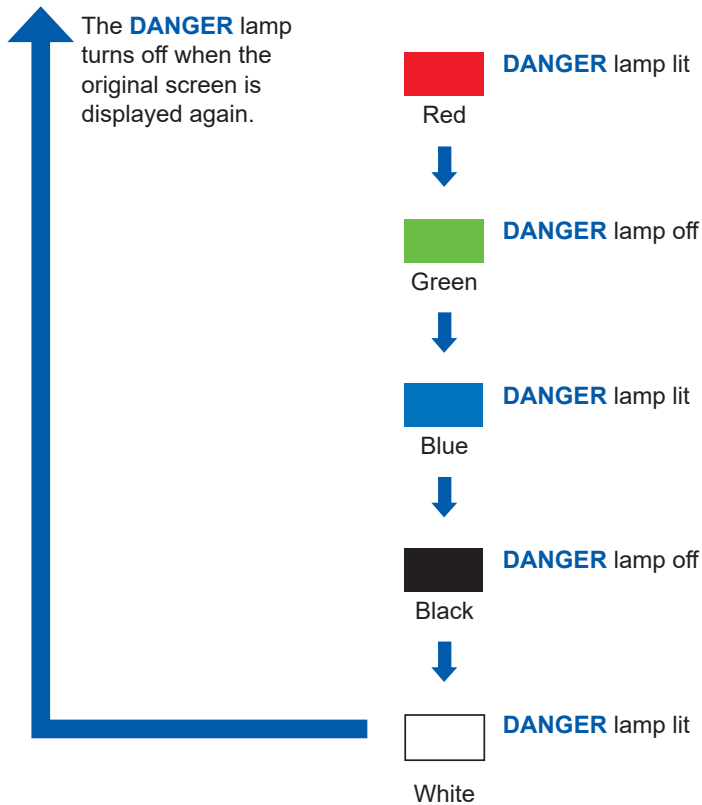

IMPORTANT

If the full screen is not the same color, repairs are necessary. Please contact your authorized Hioki distributor or reseller.

ROM/RAM test

The instrument internal memory (ROM and RAM) is checked.

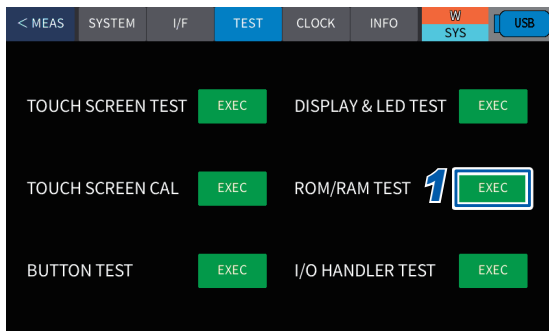

- 1 Press [SYS] > [TEST] > [EXEC] of [ROM/RAM TEST] on the measurement screen.

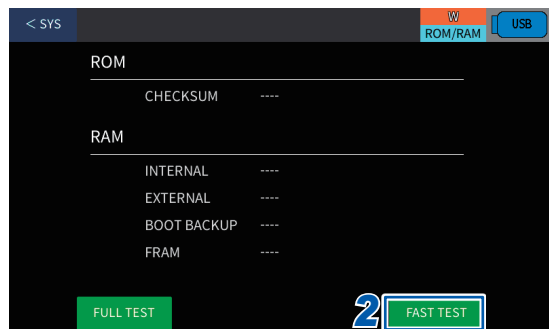

- 2 Press [FAST TEST].
The test starts automatically.

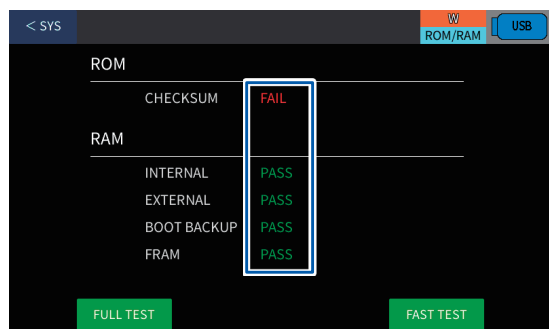

When the test has finished, the test results are displayed.

PASS	All ROM/RAM memories are normal.
FAIL	One or more of the ROM/RAM memories is abnormal.

IMPORTANT

- All operations are disabled during ROM/RAM tests.
- If the judgment results display is [FAIL], repairs are necessary. Please contact your authorized Hioki distributor or reseller.

Full test

Checks the details of all memory conditions.

This check takes approx. 9 minutes. Execute a full test when the instrument operation is unstable (normally a full test is not necessary).

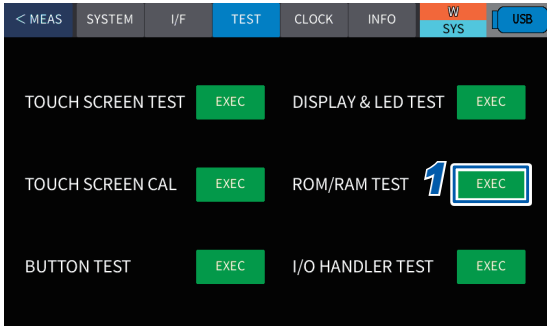

1 Press **[SYS]** > **[TEST]** > **[EXEC]** of **[ROM/RAM TEST]** on the measurement screen.

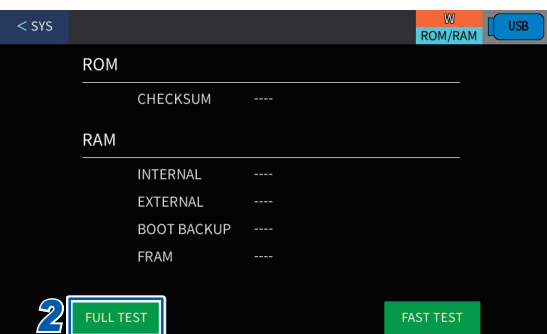

2 Press **[FULL TEST]**.
A confirmation message is displayed.

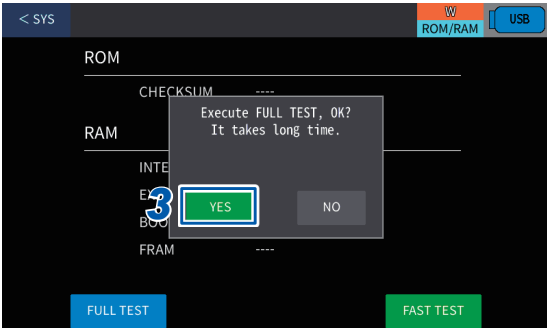

3 Press **[YES]**.

The full test starts.

When the test has finished, the test results are displayed.

PASS	All ROM/RAM memories are normal.
FAIL	One or more of the ROM/RAM memories is abnormal.

IMPORTANT

If the judgment results display is **[FAIL]**, repairs are necessary. Please contact your authorized Hioki distributor or reseller.

I/O handler test

Checks whether the output signals from the external I/O terminal are normal, and whether the input signals can be read normally.

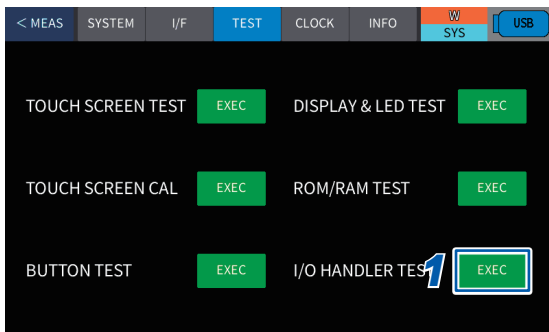

- 1 Press **[SYS] > [TEST] > [EXEC]** of **[I/O HANDLER TEST]** on the measurement screen.

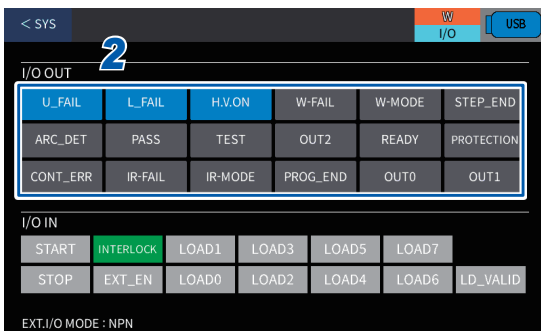

- 2 Perform an output signal test (I/O OUT).

Implements output signal tests.

When a button is pressed, the signal is output from the I/O output pin with the name of that button (on).

When a button that is outputting the signal is pressed, no signal is output from the I/O output pin with the name of that button.

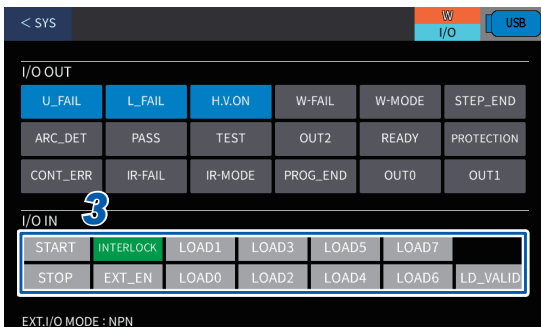

- 3 Perform an input signal test (I/O IN).

The signal wire names for signals that are being input (on) from among the input signals will be lit green.

Signal wires from which signals are not being input will be grayed out (unavailable).

11.3 Setting the Date and Time

Sets the instrument date and time. You can record and manage data using the set date and time.

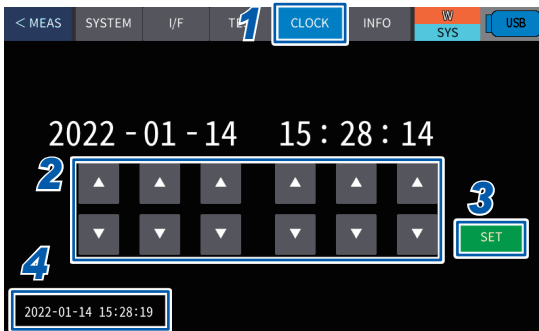

1 Press **[SYS]** > **[CLOCK]** on the measurement screen.

2 Change the value using **[▲]** or **[▼]**.

Settings range: from 00:00:00 on January 1, 2000
to 23:59:59 on December 31, 2099

3 Press **[SET]**.

4 Check the set time.

11.4 Calibration Expiration Check Function

If the calibration expiration date is set in advance, a warning message is displayed on the screen when the instrument is turned on after the calibration expiration date.

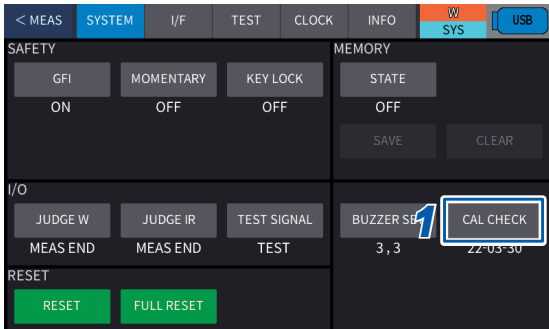

1 Press **[SYS]** > **[SYSTEM]** > **[CAL CHECK]** on the measurement screen.

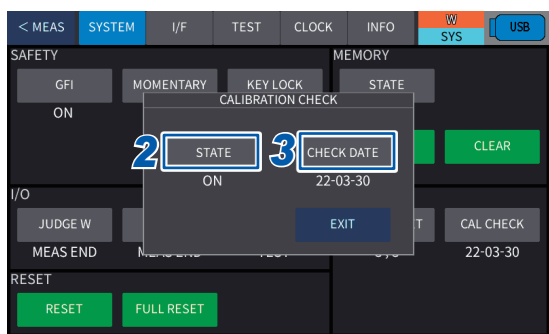

2 Press **[STATE]** and set whether to perform a calibration expiration check.

ON *1	A calibration expiration check is enabled.
OFF	A calibration expiration check is disabled.

*1. Default setting

3 When **[ON]** is set, press **[CHECK DATE]**.

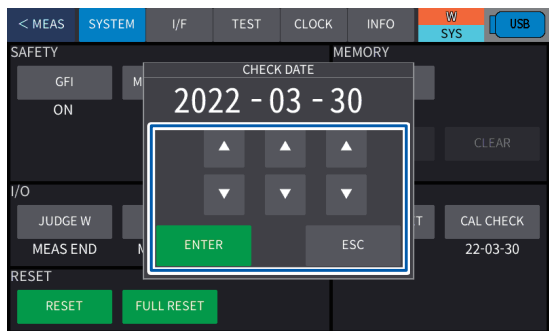

4 Change the value using **[▲]** or **[▼]** and then press **[ENTER]**.

Setting range: January 1, 2000 to December 31, 2099



A warning message is displayed when the instrument is turned on after the calibration expiration date.

12 External Control (EXT. I/O)

You can control the instrument with a PLC (programmable controller) and other external devices connected using the external I/O terminal on the back of the instrument.

- Outputting signals to external devices from the instrument (judgment result signal, etc.)
- Inputting signals to the instrument from external devices (measurement start signal, etc.)

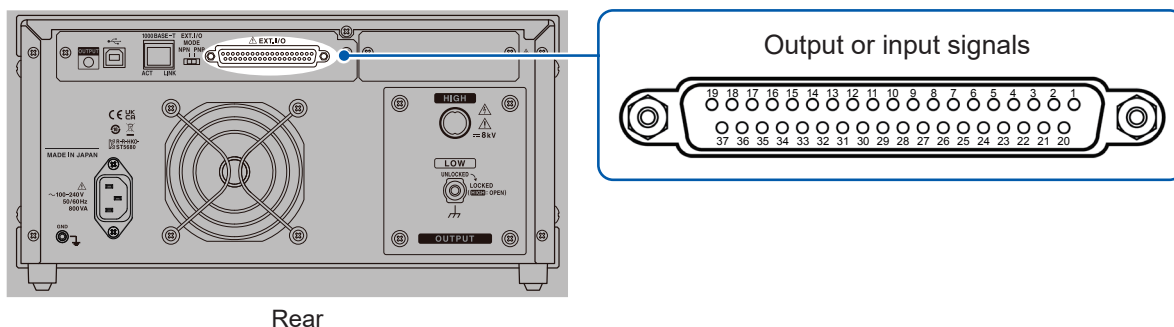

Rear

All signals are isolated from the measuring circuit and the ground (earth) (the input/output common is shared).

The input circuit can be switched for current sink output (NPN) or current source output (PNP). Check the input rating and internal circuit configuration (p. 179), and then understand the safety precautions. After that, connect the control system and use it in a correct manner.

WARNING



- **Do not operate the external I/O mode switch (NPN/PNP) with the instrument turned on.**

Otherwise, the devices connected to the external I/O terminal could be damaged.

- **Use specified wires. As an alternative way, use wires with a sufficient margin for the withstand voltage and current capacitance.**

Otherwise, electric shock or short-circuit accidents could occur.

- **Turn off the instrument and the devices to be connected. After that, connect the devices to the external I/O terminal of the instrument.**

Otherwise, electric shock accidents or instrument/device damage could occur.

- **When connecting a device to the external I/O terminal of the instrument, make sure that the input/output signals do not exceed the rating of the external I/O terminal.**

Otherwise, electric shock accidents or instrument/device damage could occur.



- **When connecting a device to the external I/O terminal of the instrument, secure the connector using screws.**

There is a danger of electric shock accidents if the connector comes off during operation and comes in contact with another conductive object.

- **Follow the procedure below before wiring the external I/O terminal.**

1. Turn off the instrument and the devices to be connected.
2. Discharge static electricity from your body.
3. Check that the signal does not exceed the external input and output rating.
4. Properly isolate the instrument and the devices to be connected.

Failure to do so could cause the operator to experience an electric shock or damage the instrument.

12.1 Switching the Current Sink (NPN) and Current Source (PNP)

The external I/O MODE switch (NPN/PNP) allows you to change the type of the compatible PLC. NPN is sinking current and PNP is sourcing current. It is set to NPN at the time of shipment from the factory.

⚠ CAUTION



- Turn off the instrument and then switch the external I/O mode switch (NPN/PNP).
- Set the NPN/PNP setting according to the devices to be connected externally. Otherwise, the devices connected to the external I/O terminal could be damaged.

Use the NPN/PNP switch on the back of the instrument.

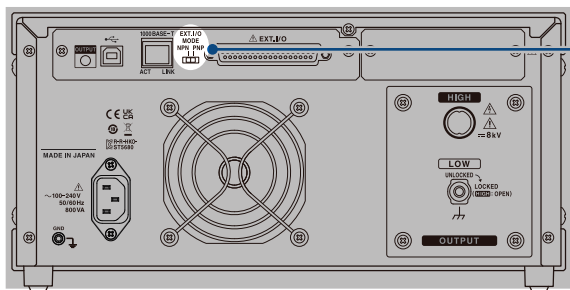

Rear

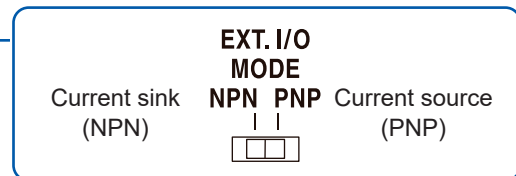

	EXT. I/O MODE switch (NPN/PNP) setting	
	NPN	PNP
Instrument input circuit	Compatible with sink output	Compatible with source output
Instrument output circuit	Non-polar	Non-polar
ISO_5 V output	+5 V output	-5 V output

12.2 External Input and Output Terminals and Signals

Instrument connector and compatible connectors

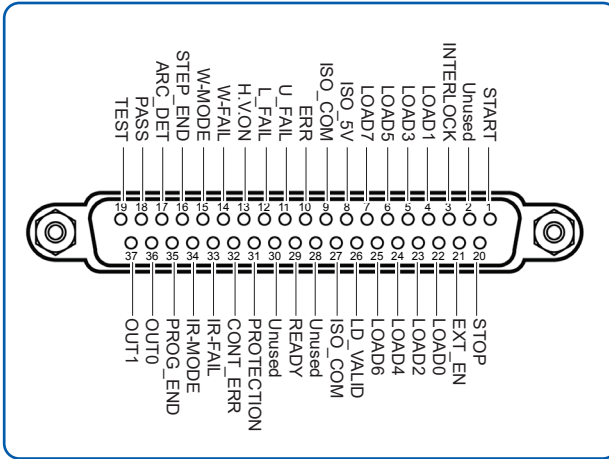

Instrument connector

- D-SUB 37 pin and socket connection
- #4-40 inch screw

Compatible connector

- DC-37P-ULR (solder type)
- DCSP-JB37PR (pressure welded type)
Japan Aviation Electronics Industry, Ltd.
- Other equivalent connectors

Instrument connector signal arrangement

IMPORTANT

The connector frame is connected to the instrument case (a metal area) and protective ground terminal of the power inlet. Be aware that it is not isolated from the ground.

Pin No.	Signal name	I/O	Function	Operation
1	START	IN	Trigger signal for test start and W-IR/IR-W, program, and BDV mode	Edge
2	NC	IN	–	–
3	INTERLOCK	IN	Interlock unlocked	Level
4	LOAD1	IN	Panel load	Level
5	LOAD3	IN		
6	LOAD5	IN		
7	LOAD7	IN		
8	ISO_5V	–	Isolated power supply; 5 V (–5 V) output	–
9	ISO_COM	–	Isolated power supply common	–
10	ERR	OUT	Measurement error output	–
11	U_FAIL	OUT	On for UPPER_FAIL judgment	–
12	L_FAIL	OUT	On for LOWER_FAIL judgment	–
13	H.V.ON	OUT	On while a voltage is applied	–
14	W-FAIL	OUT	On when the instrument give a fail judgment after a withstand voltage test	–
15	W-MODE	OUT	On during a withstand voltage test	–
16	STEP_END	OUT	On at the end of each step during a program test	–
17	ARC_DET	OUT	On during arc detection	–
18	PASS	OUT	On for pass judgment	–
19	TEST	OUT	On during a test (with custom function)	–
20	STOP	IN	Test stop and pass/fail hold released	Edge
21	EXT_EN	IN	External I/O signal input signal enabled	Level
22	LOAD0	IN	Panel load	Level
23	LOAD2	IN		
24	LOAD4	IN		
25	LOAD6	IN		
26	LD_VALID	IN	Execute panel load	Edge
27	ISO_COM	–	Isolated power supply common	–
28	NC	OUT	–	–
29	READY	OUT	On during standby	–
30	NC	OUT	–	–
31	PROTECTION	OUT	On when the protection function is in operation	–
32	CONT_ERR	OUT	On when a contact error occurs	–
33	IR-FAIL	OUT	On when the instrument give a fail judgment after an insulation resistance test	–
34	IR-MODE	OUT	On during an insulation resistance test	–
35	PROG_END	OUT	On at the end of final step during a program test	–
36	OUT0	OUT	General purpose output	–
37	OUT1	OUT	General purpose output	–

Signal functions

Input signal

START	Starts a test when it is on.
INTERLOCK	Releases the interlock and allows the instrument to be operated when it is on. The interlock is activated and the instrument enters the protection state when this signal is turned off. This signal is enabled regardless of the EXT_EN signal status. See "Interlock function" (p. 165).
LOAD0 to LOAD7	Allows you to select the test conditions saved using the panel save function.
STOP	Ends the test when it is on. This signal is enabled regardless of the EXT_EN signal status.
EXT_EN	Enables the external I/O input signal when it is on. The INTERLOCK and STOP signals are enabled regardless of the status of this signal.
LD_VALID	Executes panel load selected by LOAD0 - LOAD7 when it is on.

Output signal

ERR	Outputs on when a measurement system error occurs
U_FAIL	Outputs on when the instrument fails with a test upper-limit value error. The output timing can be selected from two patterns.
L_FAIL	Outputs on when the instrument fails with a test lower-limit value error. The output timing can be selected from two patterns.
H.V.ON	Outputs on when a voltage is applied and remains in the voltage output terminals.
W-FAIL	Outputs on when the instrument fails a withstand voltage test.
W-MODE	Outputs on while a withstand voltage test is selected in the test mode.
STEP_END	Outputs on when one step is completed during a program test.
ARC_DET	Outputs on when the arc discharge is detected during a withstand voltage test. (p. 92)
PASS	Outputs on during pass judgment. The output timing can be selected from two patterns.
OUT0 to OUT1	General purpose output signals. On is output when the instrument enters the set state.
TEST	Outputs on during a test time. A signal can be selected from four types with varying output timing.
READY	Outputs on when the instrument enters the ready state.
PROTECTION	Outputs on when the protection function is activated.
CONT_ERR	Outputs on when a contact check error occurs.
IR-FAIL	Outputs on when the instrument fails an insulation resistance test.
IR-MODE	Outputs on while an insulation resistance test is selected in the test mode.
PROG_END	Outputs on when one program is completed during a program test.

Setting the judgment signal output timing

- The output timing for judgment output signals (PASS, U_FAIL, and L_FAIL) can be selected from two patterns.
- The DCW and IR judgment output timing can be set individually.
- When the contact check function is **[ON]**, the output timing for judgment signals is **[MEAS END]** (p. 105) only.

DCW judgment output timing

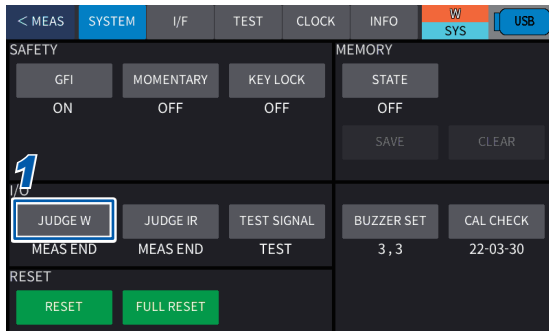

- 1 Press **[SYSTEM]** > **[JUDGE W]** on the system screen.

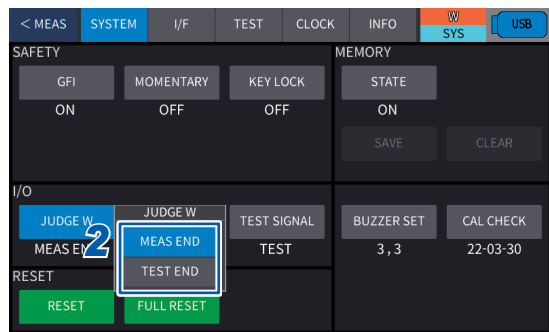

- 2 Select the setting.

MEAS END *1	Turns on the output as soon as the test voltage is turned off when a test is completed.
TEST END	Turns on the output as soon as a test is completed.

*1. Default setting

IR judgment output timing

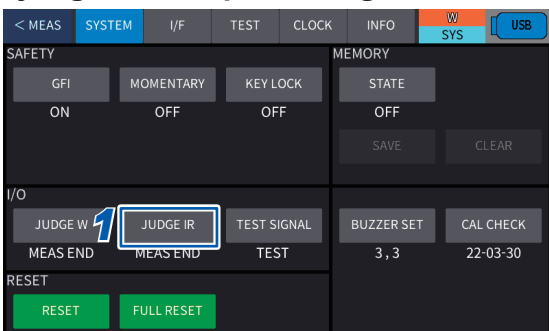

- 1 Press **[SYSTEM]** > **[JUDGE IR]** on the system screen.

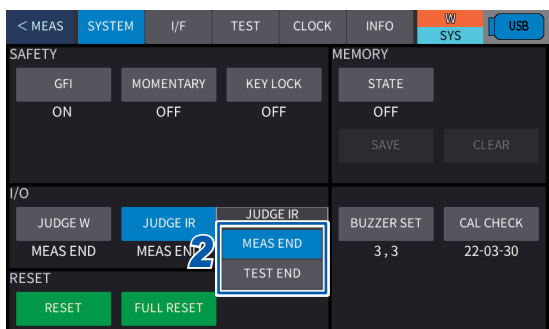

- 2 Select the setting.

MEAS END *2	Turns on the output as soon as the test voltage is turned off when a test is completed.
TEST END	Turns on the output as soon as a test is completed.

*2. Default setting

Setting the test signal output timing

The output timing for a test signal can be selected from four patterns.

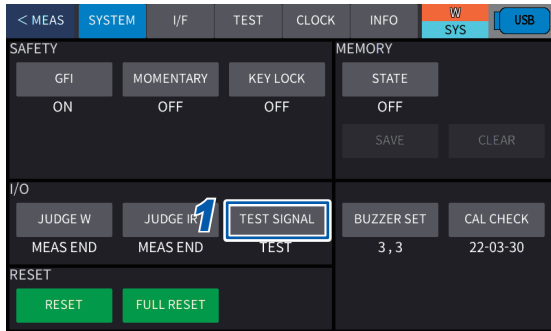

1 Press [SYSTEM] > [TEST SIGNAL] on the system screen.

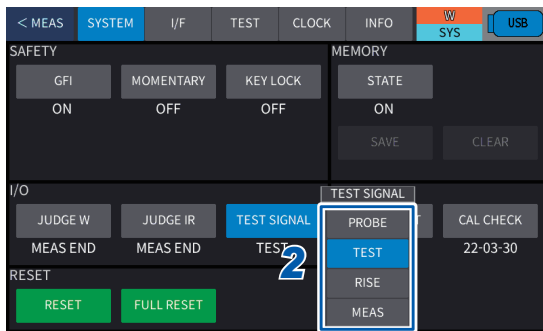

2 Select the setting.

PROBE	Turns on the output from the start of a test until the test voltage is turned off.
TEST*1	Turns on the output during the test time.
RISE	Turns on the output from the start of a test until the test voltage is reached.
MEAS	Turns on the output from the start of a test until the end of it.

*1. Default setting

Example 1: Test mode DCW

Judgment output timing: MEAS END

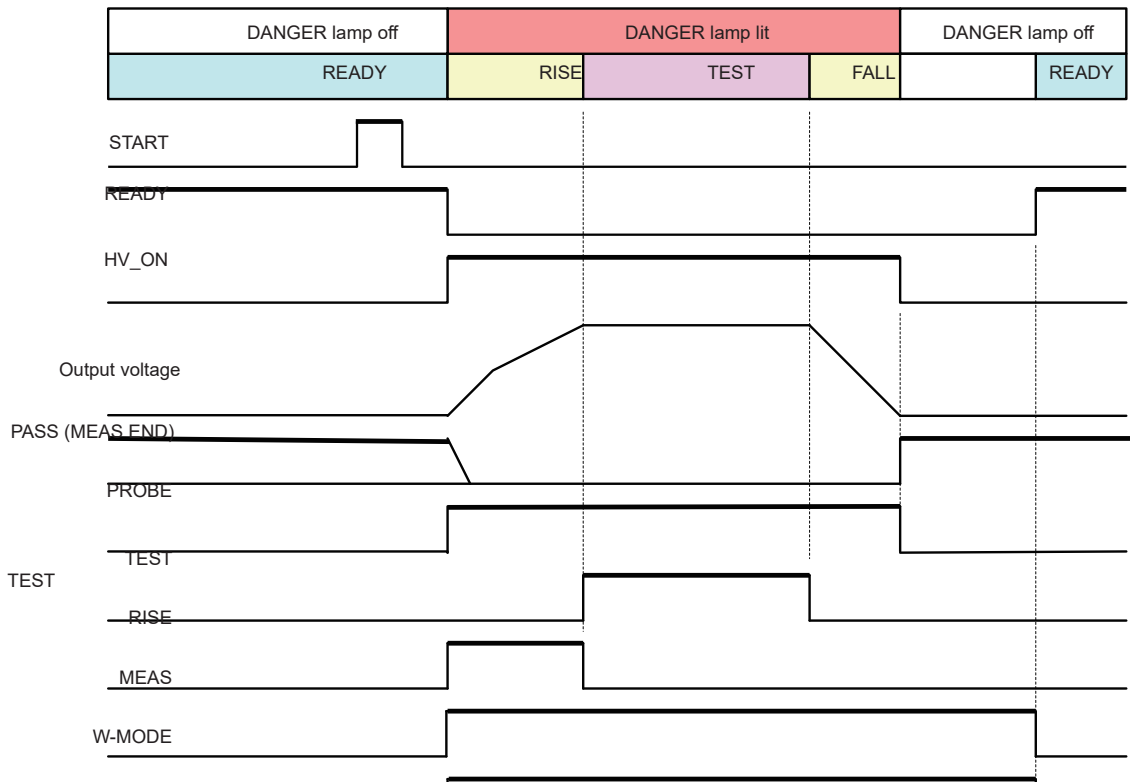

Example 2: Test mode DCW

Judgment output timing: TEST END

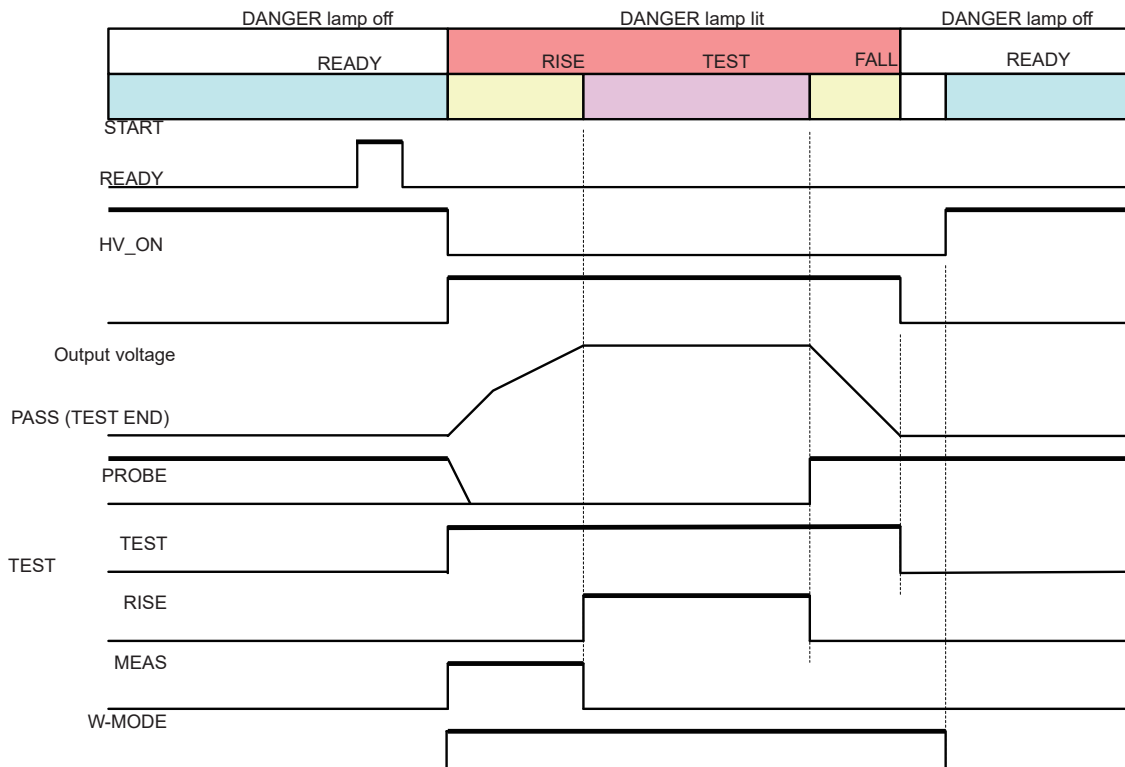

Selecting the test conditions saved using the panel save function

The test conditions saved in “Saving test conditions (panel save function)” (p. 121) of the instrument can be selected using the external input terminals.

Test condition selection

- 1** Select the memory number of the test conditions with a combination of signals LOAD0 to LOAD7.
- 2** Turn on the LD_VALID signal with the test stopped.

The test conditions selected in **1** are imported.

Test mode	No.	Mode switch bit		Memory number switch bit					
		LOAD7	LOAD6	LOAD5	LOAD4	LOAD3	LOAD2	LOAD1	LOAD0
DCW	1	Off	Off	Off	Off	Off	Off	Off	Off
	2			Off	Off	Off	Off	Off	On
	⋮			⋮	⋮	⋮	⋮	⋮	⋮
	⋮			⋮	⋮	⋮	⋮	⋮	⋮
	⋮			⋮	⋮	⋮	⋮	⋮	⋮
	64			On	On	On	On	On	On
IR	1	Off	On	Off	Off	Off	Off	Off	Off
	2			Off	Off	Off	Off	Off	On
	⋮			⋮	⋮	⋮	⋮	⋮	⋮
	⋮			⋮	⋮	⋮	⋮	⋮	⋮
	⋮			⋮	⋮	⋮	⋮	⋮	⋮
	64			On	On	On	On	On	On
BDV	1	On	Off	Off	Off	Off	Off	Off	Off
	2			Off	Off	Off	Off	Off	On
	⋮			⋮	⋮	⋮	⋮	⋮	⋮
	⋮			⋮	⋮	⋮	⋮	⋮	⋮
	⋮			⋮	⋮	⋮	⋮	⋮	⋮
	10			Off	Off	On	Off	Off	On
Invalid	Invalid	On	Off	Off	Off	On	Off	On	Off
				⋮	⋮	⋮	⋮	⋮	⋮
				⋮	⋮	⋮	⋮	⋮	⋮
				⋮	⋮	⋮	⋮	⋮	⋮
Program test	1	On	On	Off	Off	Off	Off	Off	Off
	2			Off	Off	Off	Off	Off	On
	⋮			⋮	⋮	⋮	⋮	⋮	⋮
	⋮			⋮	⋮	⋮	⋮	⋮	⋮
	⋮			⋮	⋮	⋮	⋮	⋮	⋮
	30			Off	On	On	On	Off	On
Invalid	Invalid	On	On	Off	On	On	On	On	Off
				⋮	⋮	⋮	⋮	⋮	⋮
				⋮	⋮	⋮	⋮	⋮	⋮
				⋮	⋮	⋮	⋮	⋮	⋮
				On	On	On	On	On	On

Interlock function

The interlock function is a function to shut down the output of the instrument by linking with external equipment, etc. to secure the safety of the operators.

When the interlock is activated, the instrument enters the protection state and all the key operations are disabled. Due to this, any test cannot be started even with the START signal from the external I/O terminal or a communications command.



Interlock activation

When the No. 3 pin (INTERLOCK) of the external I/O terminal is turned off, the interlock function is activated and the instrument outputs are shut down.

Unlocking the interlocks

After short-circuiting the external I/O terminal INTERLOCK pin (No. 3 pin) and ISO_COM pin (No. 9 and No. 27 pins), press the **STOP** button or input a STOP signal of the external I/O terminal.

IMPORTANT

- Since the No. 3 pin (INTERLOCK) of the external I/O terminal is open in the factory setting, the interlock is activated when the main power switch is set to on. To temporarily release it, use the attached custom-made interlock-canceling connector for the external I/O terminal. Alternatively, short-circuit the INTERLOCK and ISO_COM pins of the external I/O terminal.
- It is recommended to use the interlock function to ensure the safety of the operator for actual withstand voltage and insulation resistance tests.

Interlock connection example

Prepare a box where the DUT will be placed to prevent workers from touching the tester and DUT during high-voltage output. Attach a switch on the cover of the box and link the switch to the interlock function. The interlock is activated when the cover is opened and released when the cover is closed to allow a test to be performed. When the interlock is activated, all the key operations are disabled.

12.3 Timing Charts

The level of each signal shows the contact on/off status. In the current source (PNP) setting, the voltage level is high when the contact is on and low when the contact is off. For the voltage level in the current sink (NPN) setting, high and low are reversed.

Timing chart for pass judgment

DCW test (pass judgment): Without contact check

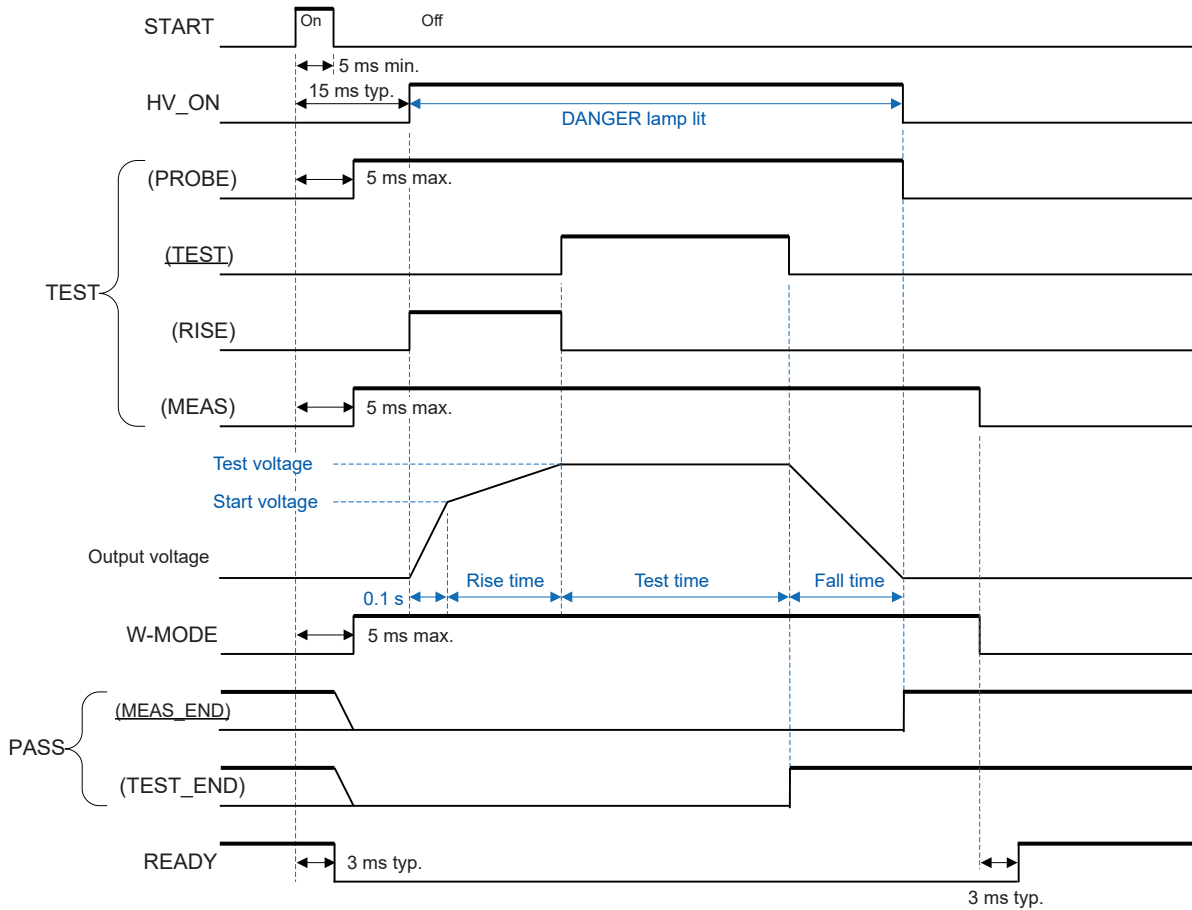

IR test (pass judgment): With contact check (good contact)

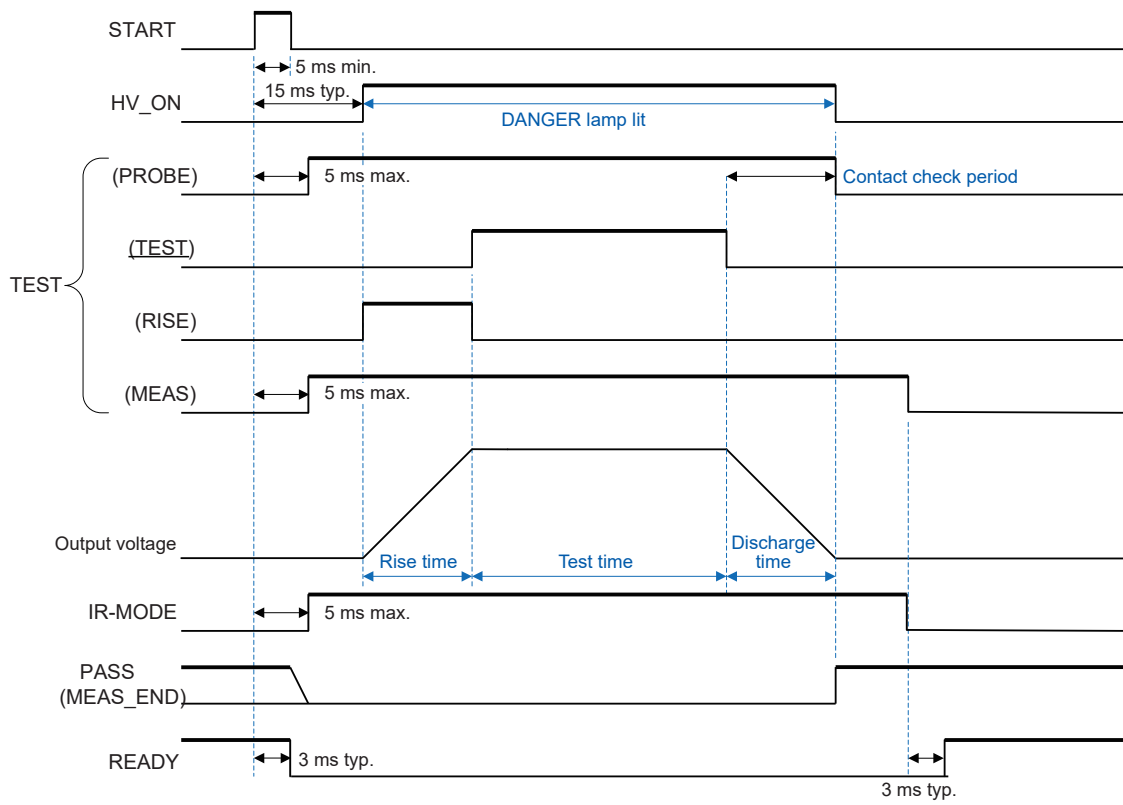

Timing chart for fail judgment

DCW test (fail judgment): Without contact check

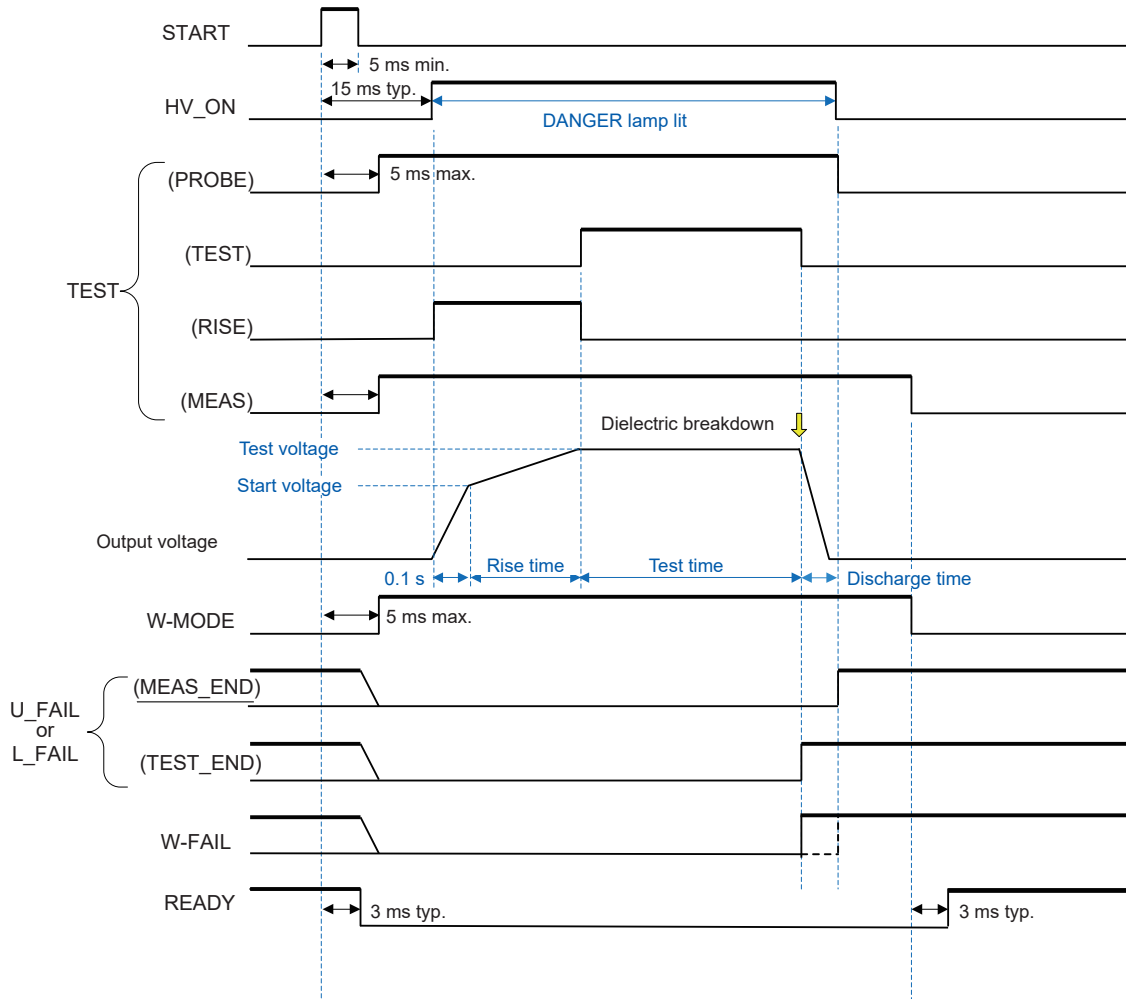

DCW test (fail judgment): With delay time setting (delay time < rinse time) and contact check (contact error)

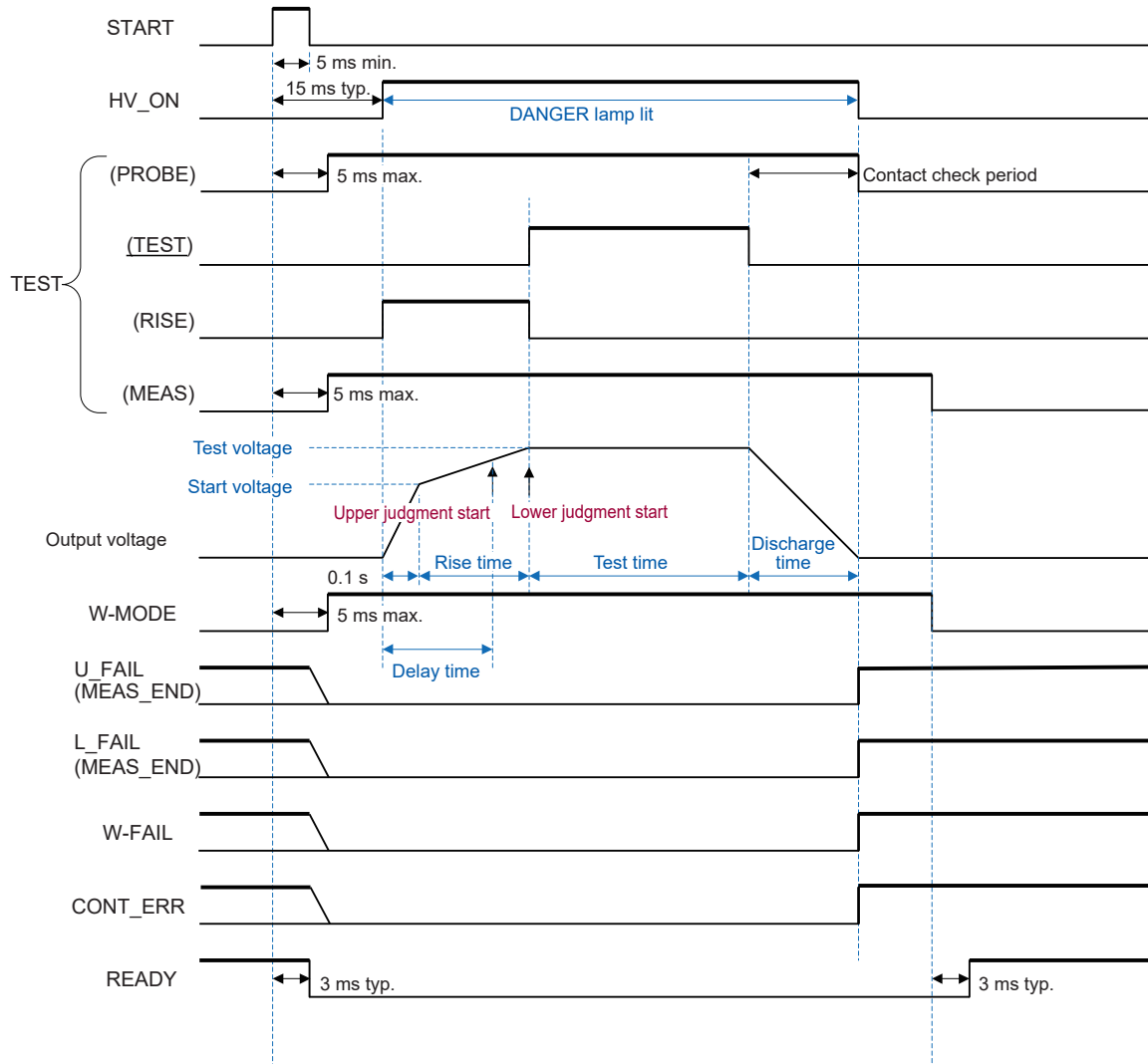

IR test (fail judgment): With delay time setting (delay time < rinse time), without contact check, insulation resistance test end mode time

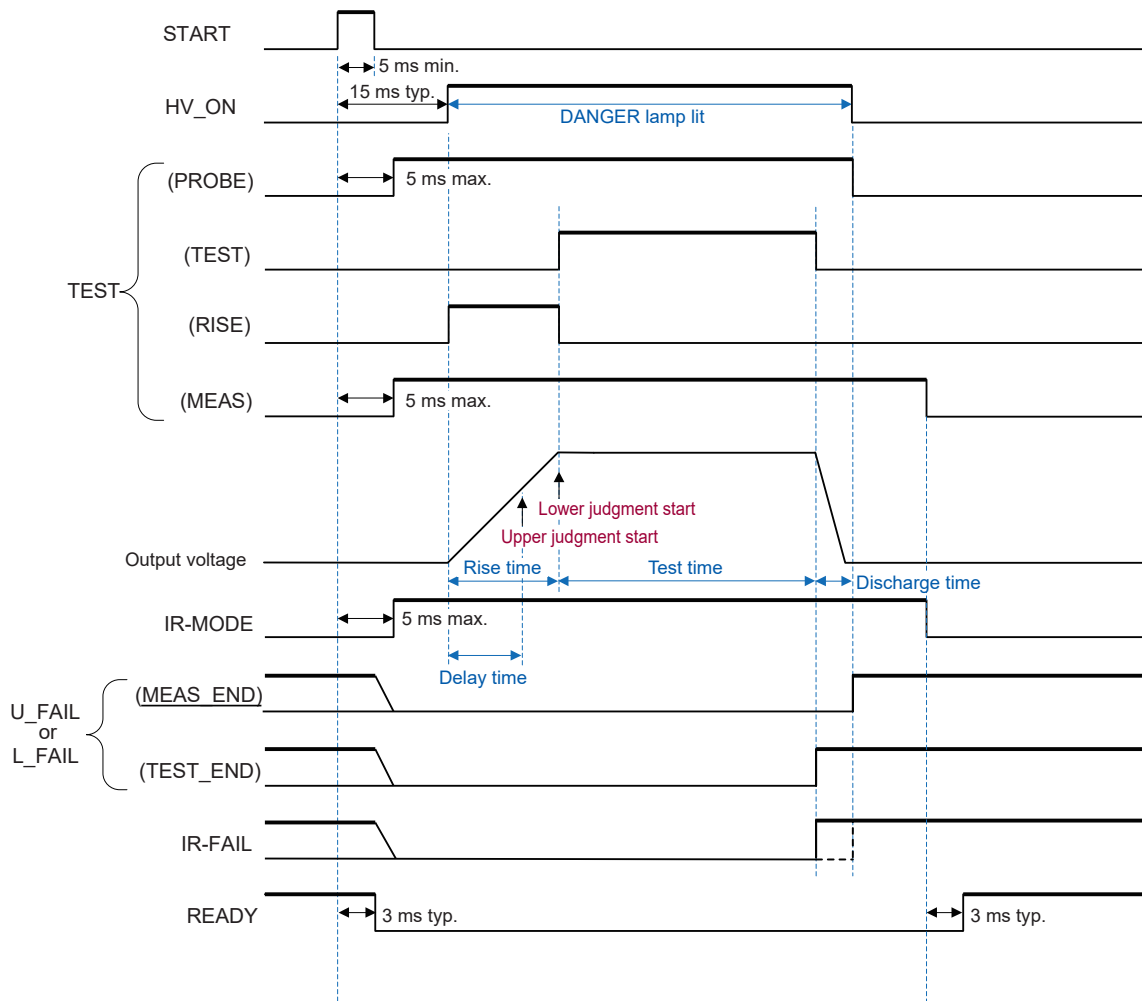

IR test (fail judgment): With delay time setting (delay time > rise time) and contact check (contact error)

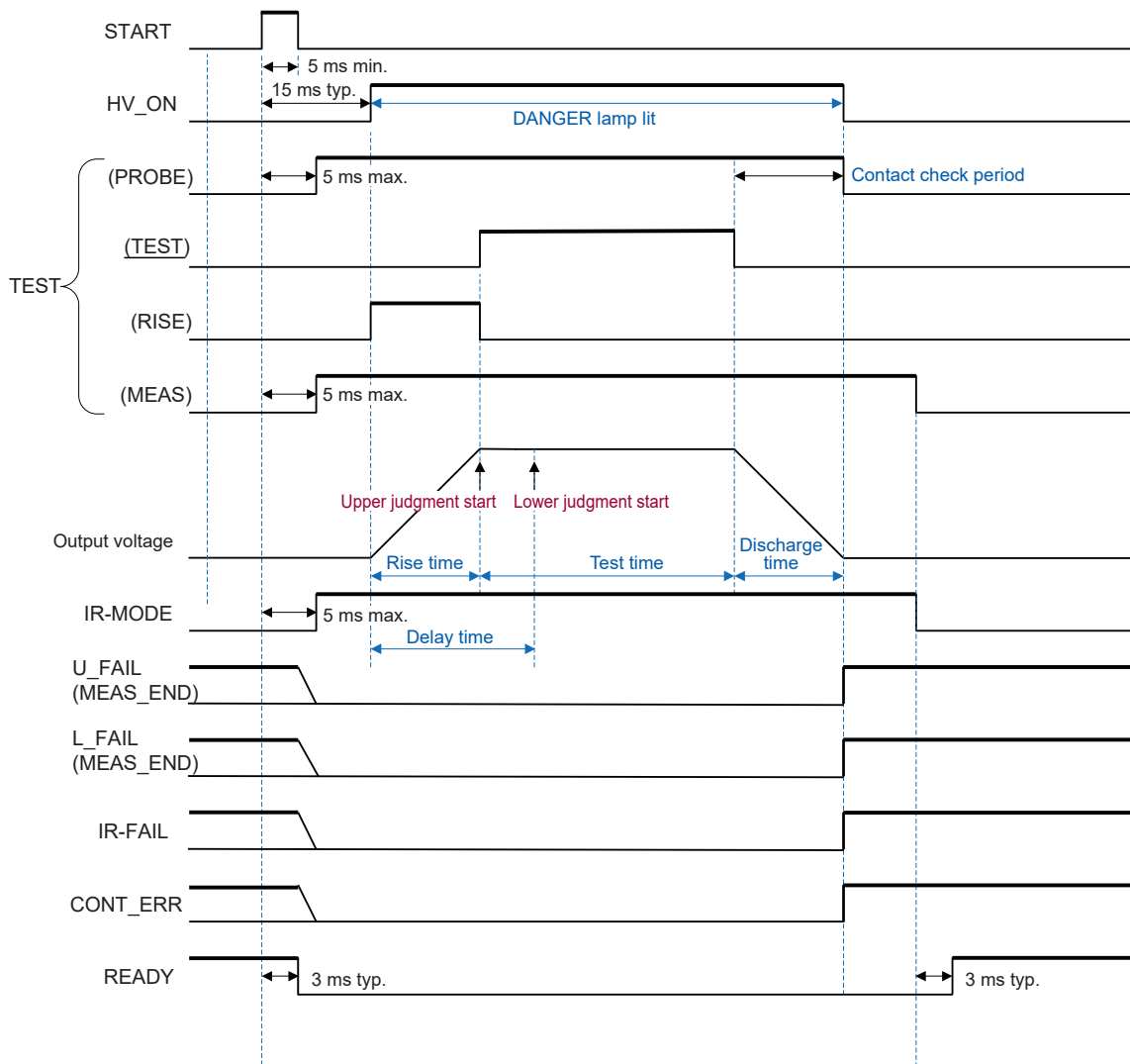

Timing chart for forced termination with a STOP signal

DCW test (forced termination with the **STOP** button): With delay time setting (delay time > rise time)

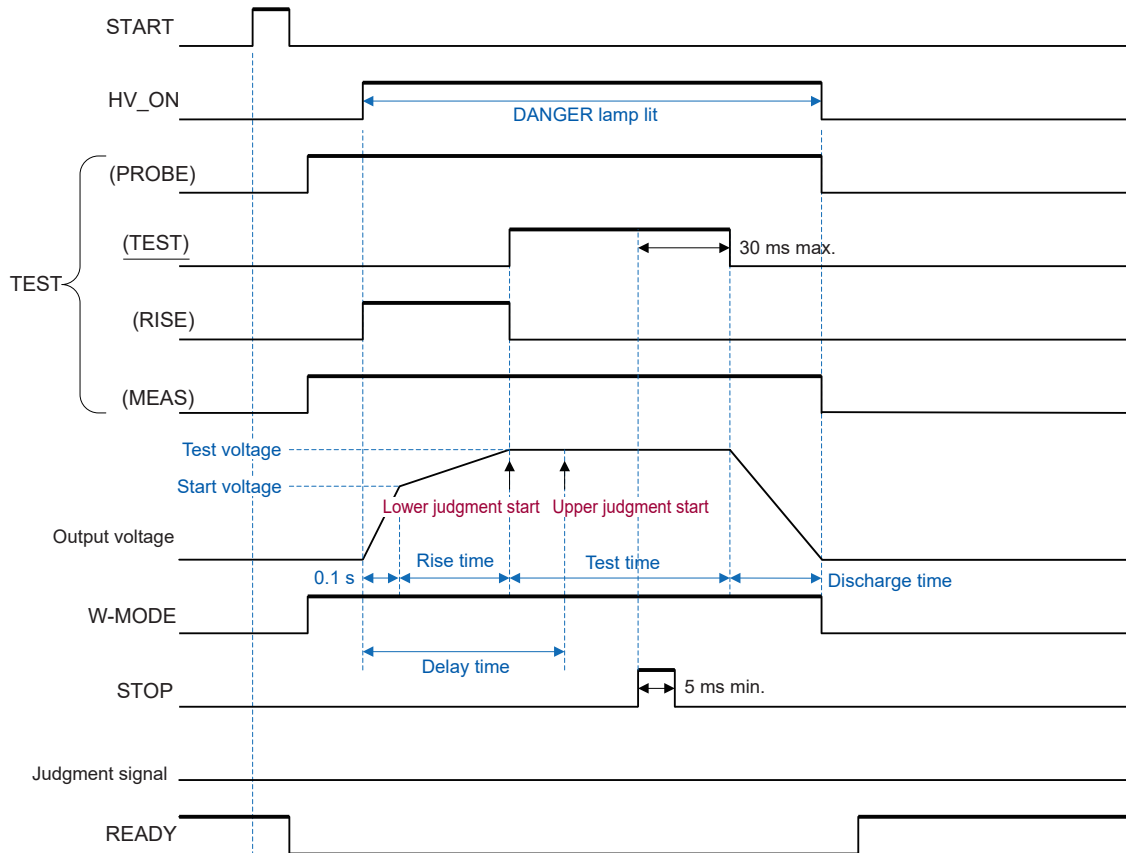

IR test (forced termination with the **STOP** button): With delay time setting (delay time < rinse time)

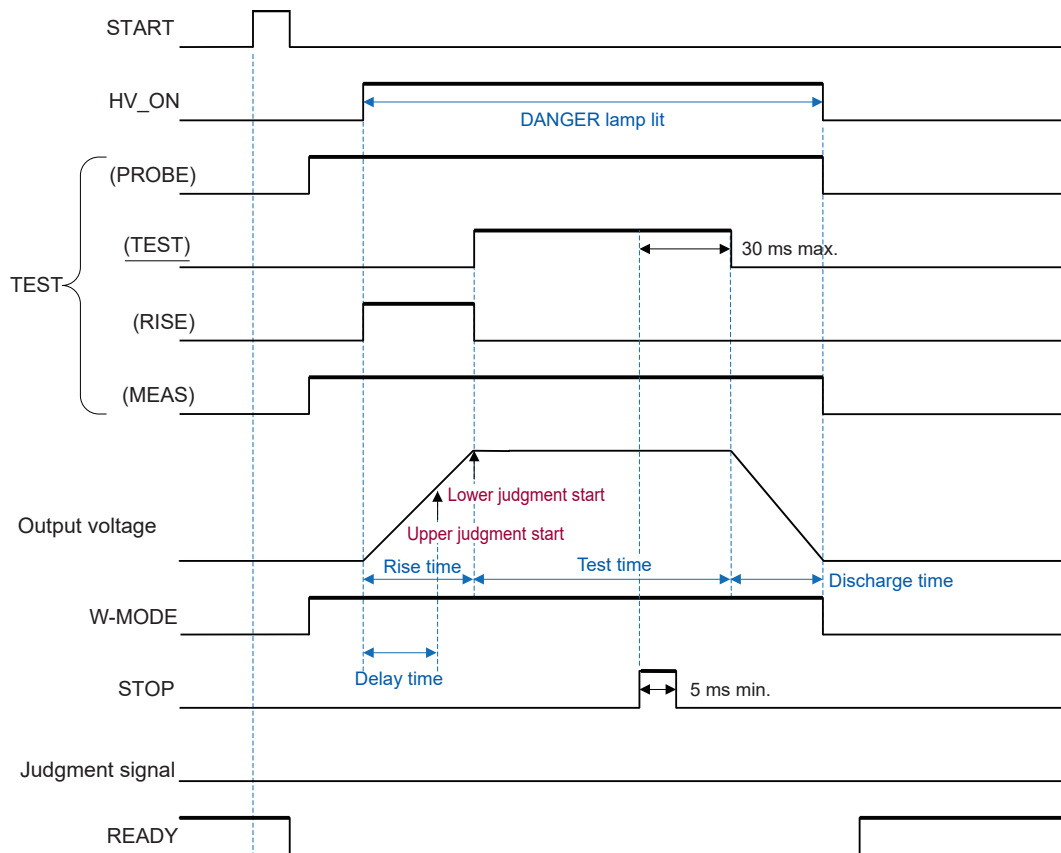

Fail judgment in the program mode (continue setting)

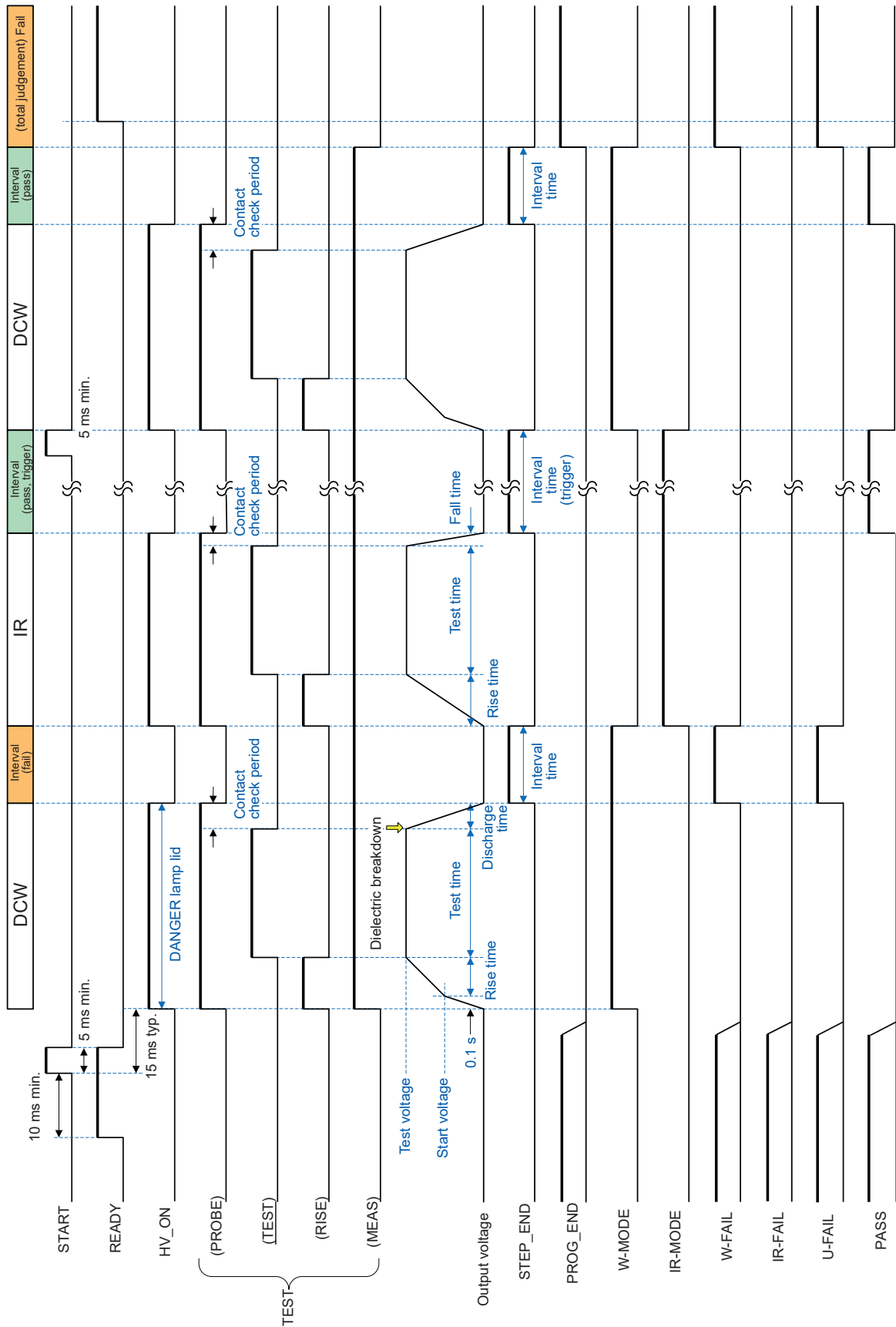

Fail judgment in the program mode (test end setting)

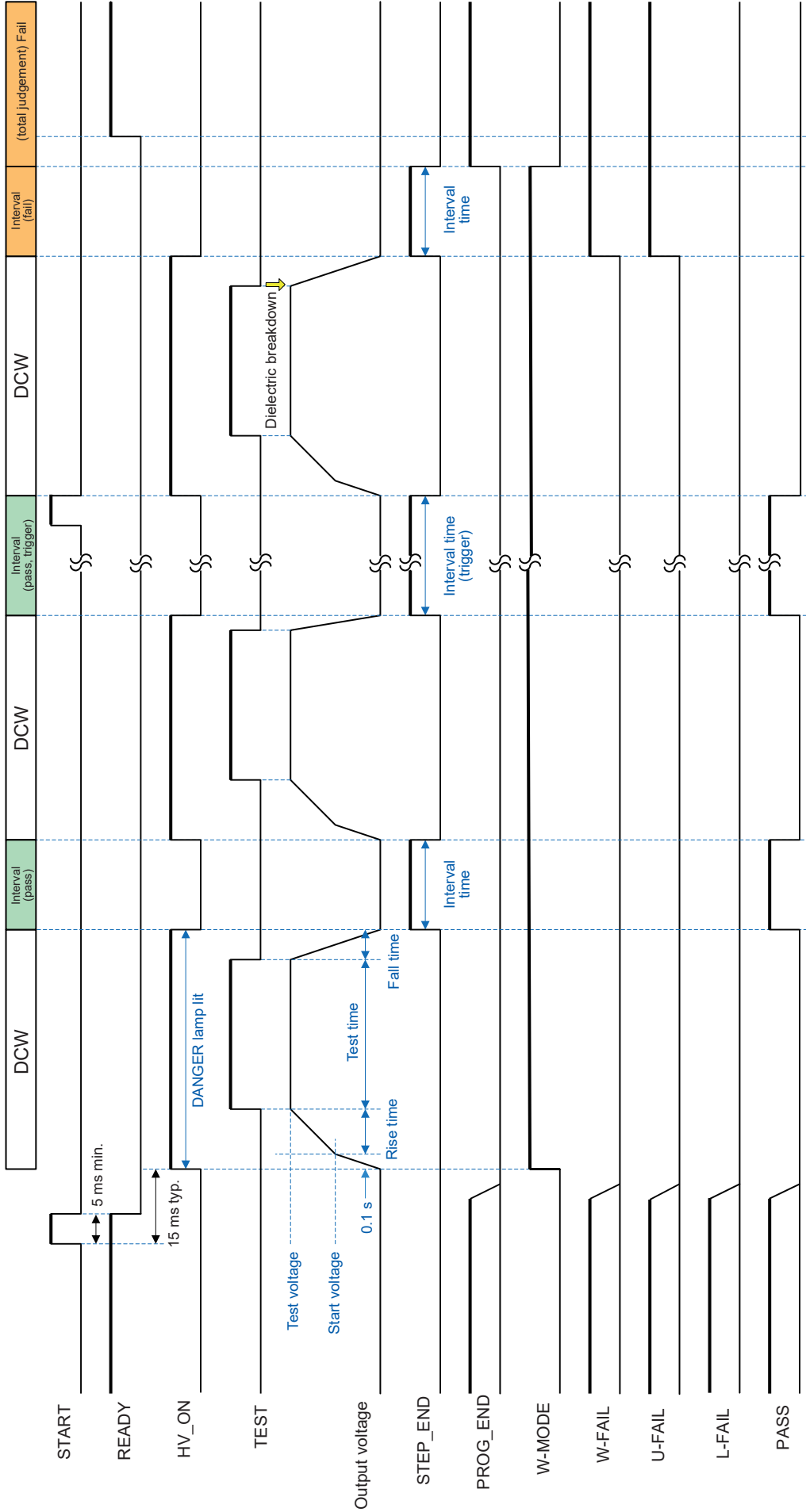

Fail judgment in the program mode (continue setting, fail judgment in multiple steps)

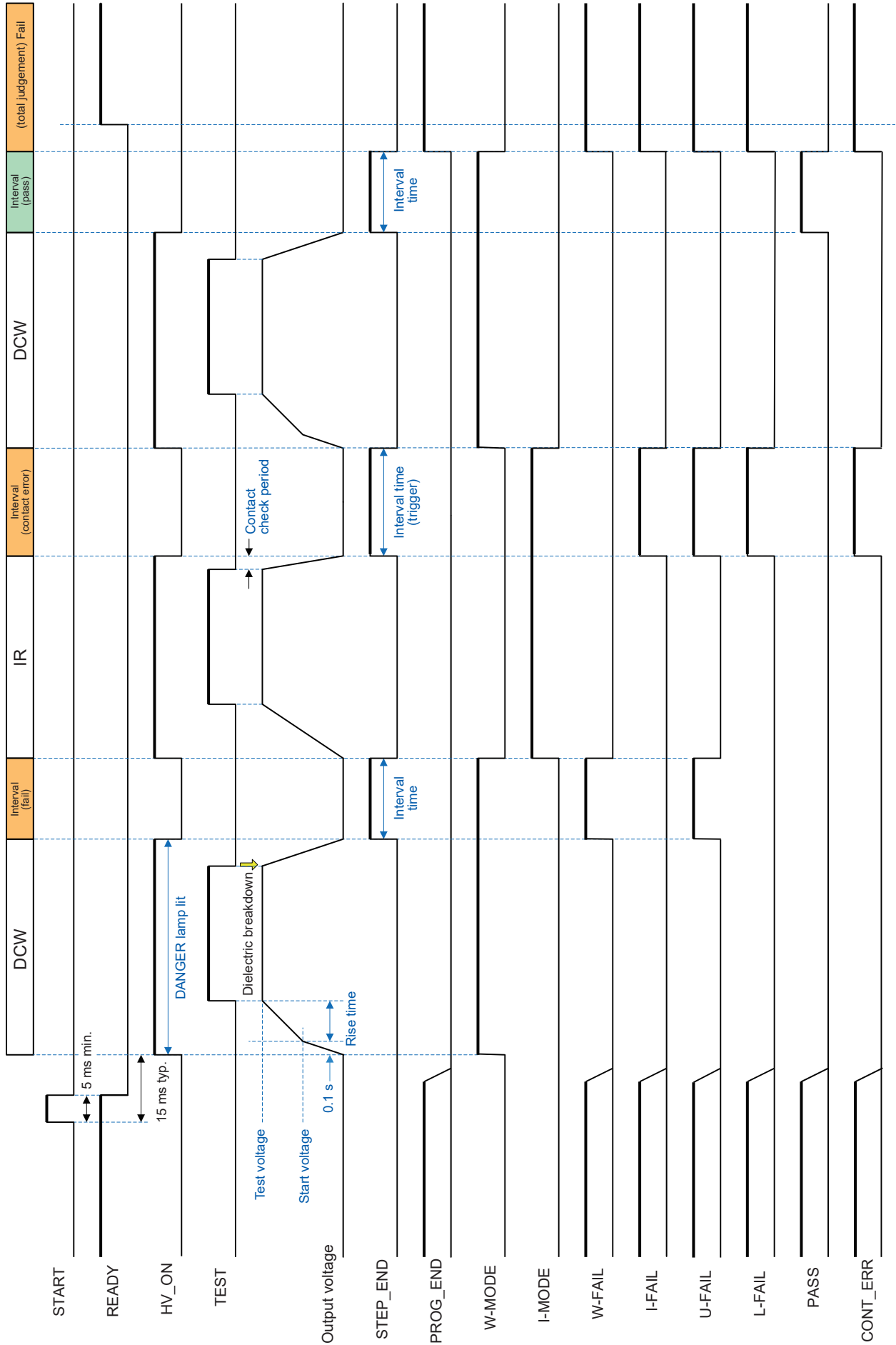

12.4 Internal Circuit Configuration

NPN setting

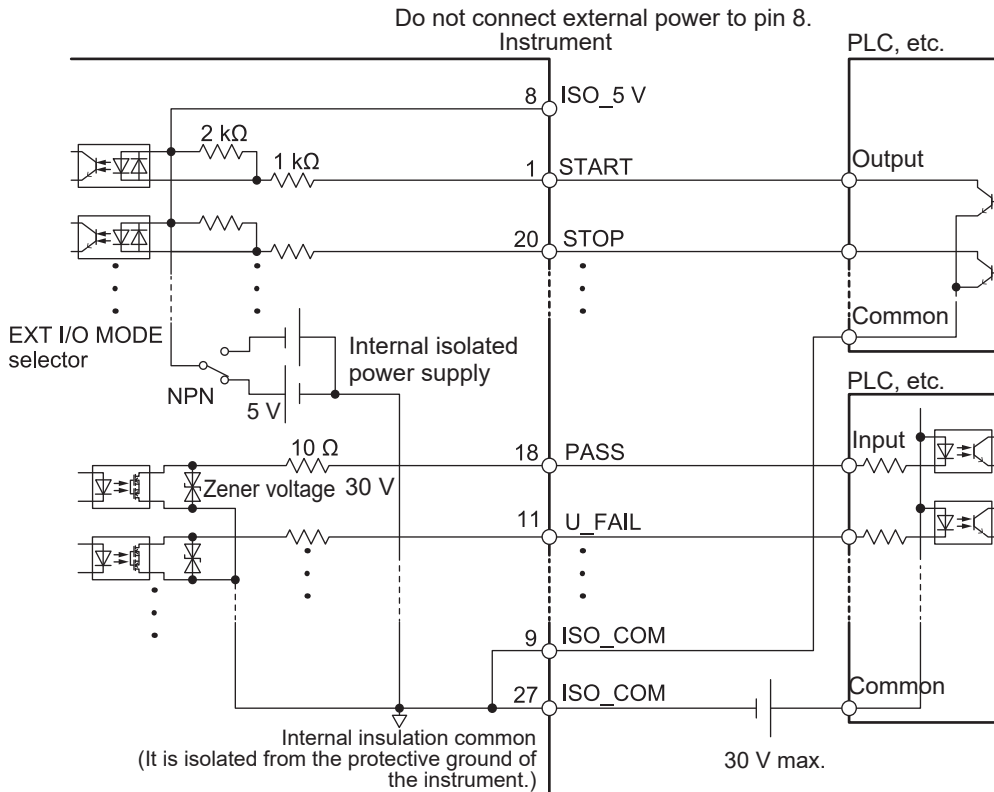

PNP setting

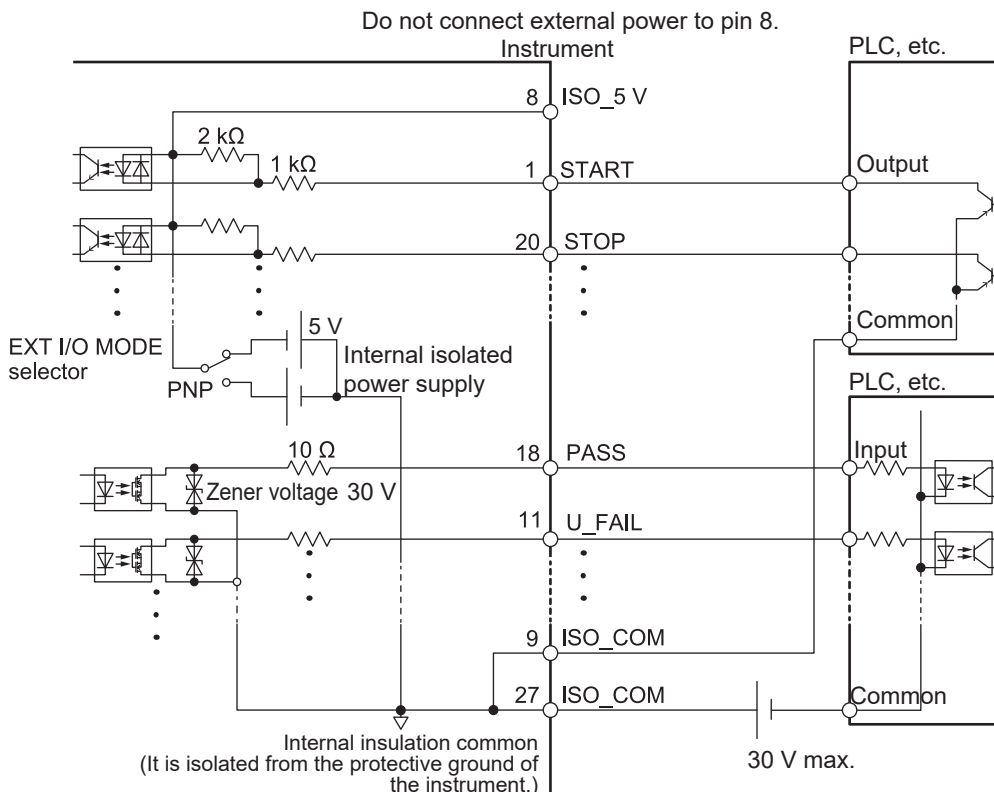

Use ISO_COM for the common terminal for both the input and output signals.

Electrical specifications

Connector used	D-sub 37-pin female, #4-40 locking screw	
Input	Photocoupler-isolated no-voltage-contact input (current sink and current source output compatible)	
	Input on	Residual voltage 1 V or less
	Input off	Open (interrupting current 100 μ A or less)
Output	Photocoupler-isolated open-drain output (non-polar)	
	Maximum load voltage	30 V
	Residual voltage	1 V or less
	Maximum output current	50 mA/channel
Power supply output	Output voltage	Sink output: 5.0 V \pm 10% Source output: -5.0 V \pm 10%
	Maximum output current	100 mA
	Isolation	Isolated from protective ground potential and measurement circuit
	Line-to-earth voltage	50 V DC, 33 V AC rms, 46.7 V AC peak or less

Connection examples

Input circuit

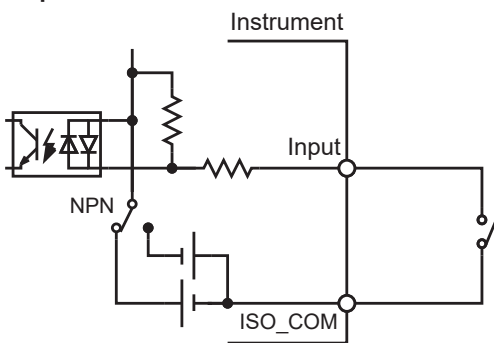

Connection to the switch

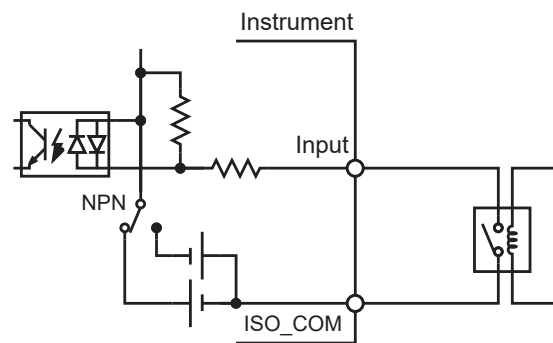

Connection to the relay

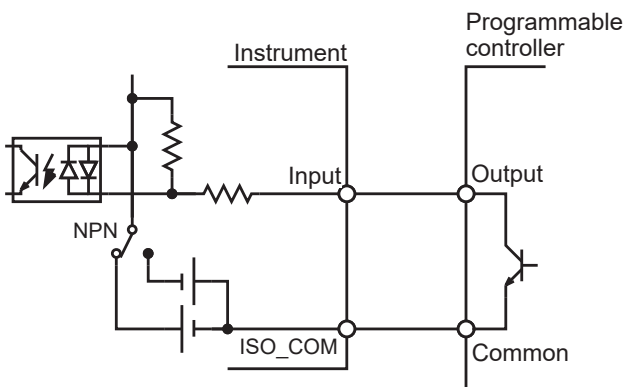

Programmable controller
Connection with (negative common output)

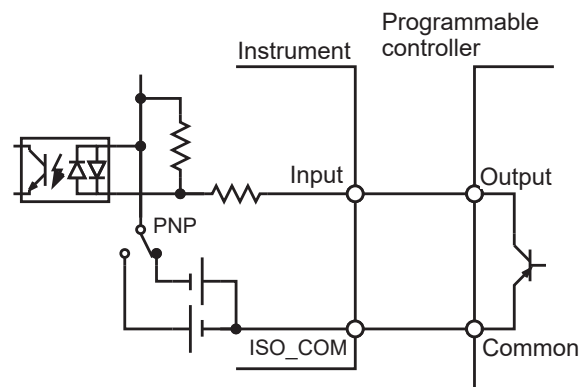

Programmable controller
Connection with (positive common output)

Output circuit

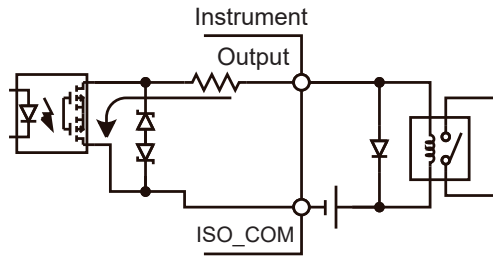

Connection to the relay

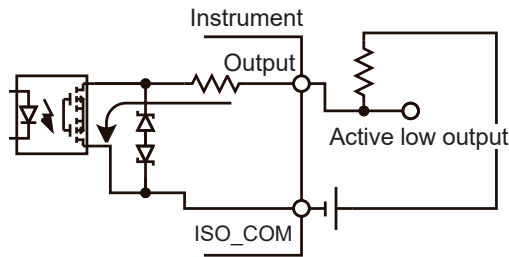

Negative-true logic output

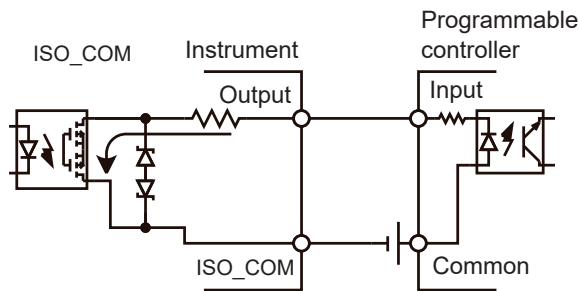

Connection to programmable controller (positive common inputs)

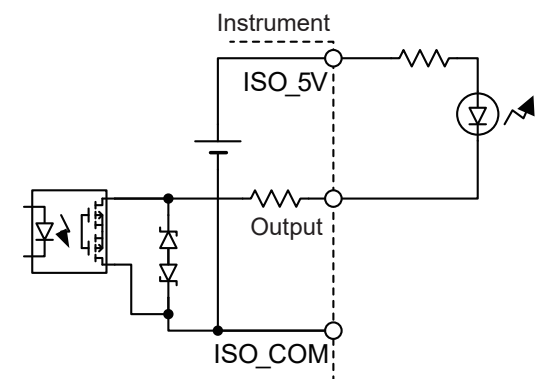

Connection to LED (using ISO_5V, NPN setting)

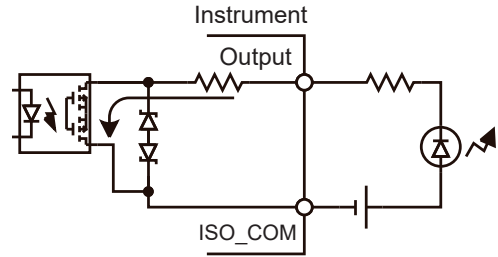

Connection to the LED

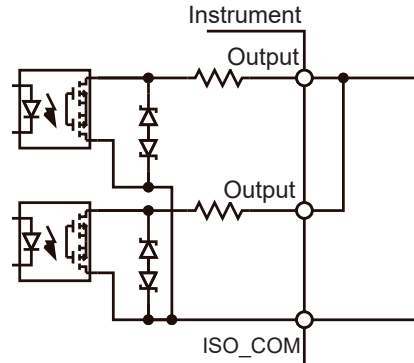

Wired OR

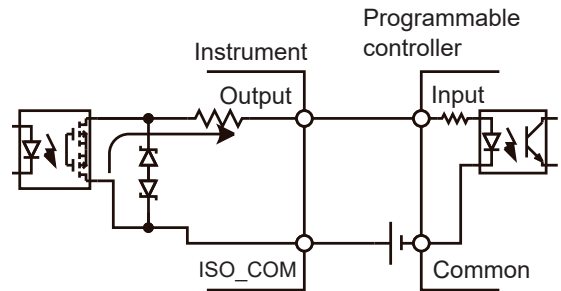

Connection to programmable controller (negative common inputs)

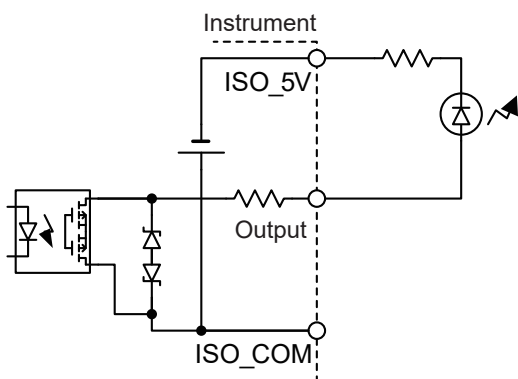

Connection to LED (using ISO_5V, PNP setting)

Communications (USB, LAN, RS-232C, GP-IB)

WARNING

- **Turn off all devices before connecting or disconnecting interface connectors.**

Failure to do so could cause the operator to experience an electric shock.



- **Use the screws supplied with the instrument when shipped from the factory to secure the interface.**

If other screws are used to secure the interface, the instrument could be damaged, causing a risk of bodily injury. If you lose or damage the screws, contact your authorized Hioki distributor or reseller.

Failure to do so could cause the operator to experience an electric shock.

CAUTION

- **Do not unplug the communication cable while the instrument is sending or receiving data.**



Doing so could damage the instrument and the PC.

- **Do not short-circuit or input any voltage to the output unit.**

The instrument could be damaged.

- **Seat connectors securely.**

Failure to do so could damage the instrument or prevent the instrument from meeting the specifications.

- **Use the same ground for the instrument and the PC.**

Connecting a communication cable while there is a potential difference between the instrument and PC's ground levels could damage the instrument and PC or cause them to malfunction.



- **Turn off the instrument and PC before connecting or disconnecting communication cables.**

Failure to do so could damage the instrument and the PC being connected or cause them to malfunction.

- **Once the communication cable is connected, tighten the screws on the connector.**

Otherwise, data could not be transferred properly.

- **Turn off the instrument and PC before connecting or disconnecting communication cables or USB cables.**

Failure to do so could damage the instrument or cause them to malfunction.

13.1 Interface Overview and Features

Using a communication interface, you can control the instrument and acquire data with a communications command.

There are 4 types of interface, as described below. It is necessary to set the instrument communication conditions to communicate.

- USB communications
(p. 189)

You can implement command control using the USB communications compatible with the communication class.

- LAN communications
(p. 190)

You can implement command control using TCP/IP protocols.

- RS-232C communications
(p. 193)

You can implement command control using ES-232C serial communications when a Z3001 RS-232C interface is connected.

- GP-IB communication
(p. 195)

You can use IEEE-488-21987 common commands (required) when a Z3000 GP-IB interface is connected. The communications commands for the instrument are designed with reference to IEEE-488.2 1997.

Multiple interfaces of this instrument can be used simultaneously.

You can check the available interfaces and change those settings on the **[I/F]** screen included in the system screen.

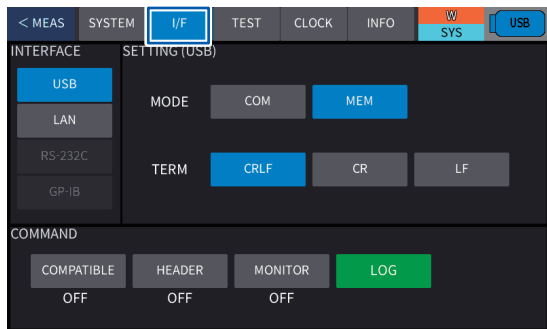

For the communications commands, see the Communications Command Instruction Manual in the provided CD.

The specifications can also be downloaded from our Internet website.

<https://www.hioki.com/global/support/download>

USB

Connector	Type B receptacle
Electrical specifications	USB2.0 (Full-Speed)
Number of ports	1
Class	CDC class
Compatible OS	Windows 7, Windows 8, Windows 10

LAN

Connector	RJ-45 connector × 1
Electrical specifications	Conforms to IEEE802.3
Transmission method	10BASE-T/100BASE-TX
Protocol	TCP/IP
Function	Command control

RS-232C

Transmission method	Communication method: Full duplex Sync method: Asynchronous transmission system
Transmission speed	9600 bps, 19200 bps, 38400 bps, 57600 bps
Data length	8 bits
Parity	None
Stop bit:	1
Flow control	Software (XON/XOFF control)
Electrical specifications	Input voltage level 5 V to 15 V: on, -15 V to -5 V: off Output voltage level 5 V to 9 V: on, -9 V to -5 V: off

Handshaking (Buffer flow control)

Control during reception

XON/XOFF control

- If the data in the reception buffer exceeds 75% of the buffer, XOFF (13H) is sent to notify the controller that there is little space remaining in the buffer.
- If data processing in the buffer is proceeding and the data amount is less than 25%, XON (11H) is sent to notify the controller that there is sufficient space in the buffer.

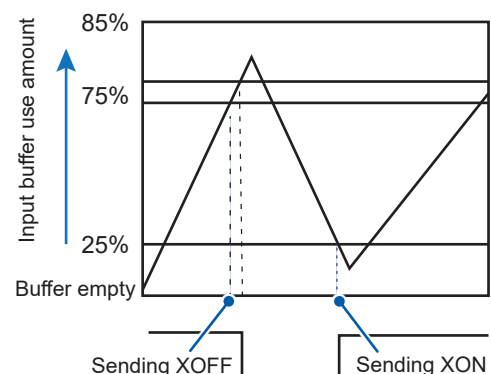

Control during transmission

XON/XOFF control

When XOFF is received, data transmission stops. When XON is received, data transmission starts.

IMPORTANT

In a noisy environment, there is a risk of data mismatch during RS-232C communications. If using RS-232C communications, acquire the data multiple times to check its conformance.

GP-IB

SH1	There is a full range of source handshake functions.
AH1	There is a full range of acceptor handshake functions.
T6	There are basic talker functions. There are serial poll functions. There is no talk only mode. There is a talker unlock function using MLA (My Listen Address).
L4	There are basic listener functions. There is no listen only mode. There is a listener unlock function using MTA (My Talk Address).
SR1	There is a full range of service request functions.
RL1	There is a full range of remote local functions.
PP0	There is no parallel polling function.
DC1	There is a full range of device clear functions.
DT1	There is a full range of device trigger functions.
C0	There are no controller functions.

Code used: ASCII code

Total

Command system	Unique HIOKI SCPI
-----------------------	-------------------

13.2 Mounting and Removing an Interface

You can check onscreen information for interfaces mounted to the device.

See “11.1 Checking the Instrument Information” (p. 143) and “13.3 Interface Settings” (p. 188).

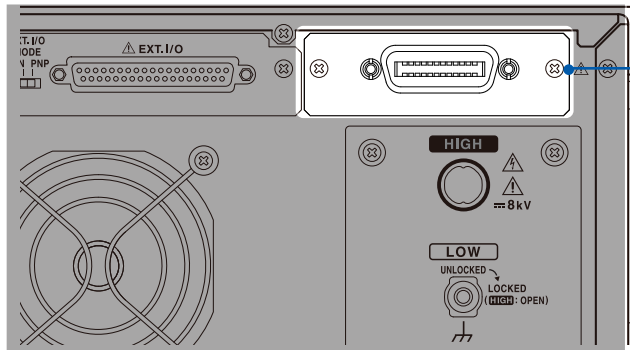

Rear

- Z3000: “13.7 Connecting and Setting GP-IB (Z3000)” (p. 195)
- Z3001: “13.6 Connecting and Setting RS-232C (Z3001)” (p. 193)

13

Communications (USB, LAN, RS-232C, GP-IB)

Installation method

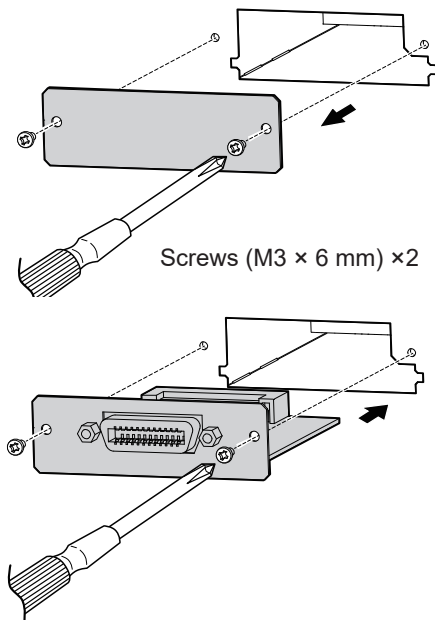

Required items: Phillips screwdriver (No. 2)

- 1 Remove the power cord from the outlet and remove all cables connected to the instrument.
- 2 Use a Phillips screwdriver to loosen the two screws securing the blank panel.
- 3 Remove the blank panel.
- 4 Pay attention to the interface orientation, and insert firmly all the way to the back.
- 5 Firmly tighten the two screws using a Phillips screwdriver to secure the interface.

Removal method

Remove the power cord from the outlet, and remove the interface using the reverse order to the mounting procedure.

When not using the interface after its removal

Mount the blank panel. The specifications cannot be satisfied if measuring without mounting the blank panel. To purchase an additional blank panel, contact your authorized Hioki distributor or reseller.

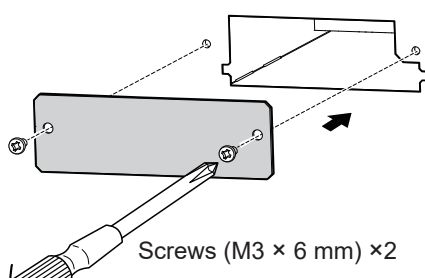

- 1 Mount the blank panel.
- 2 Firmly tighten the two screws using the Phillips screwdriver to secure the blank panel.

13.3 Interface Settings

You can control the instrument from a PC via USB, LAN, RS-232C, or GP-IB.

RS-232C: Can be set only when the optional Z3001 RS-232C interface is mounted to the instrument.

GP-IB: Can be set only when the optional Z3000 GP-IB interface is mounted to the instrument.

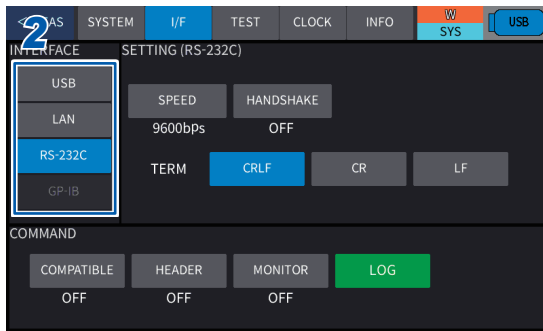

- 1 Press [SYS] > [I/F] on the measurement screen.
- 2 Check for any interfaces available for communication.

USB, LAN, RS-232C, GP-IB

Communication can also be established using interfaces that are not selected.

When the Z3000 GP-IB and Z3001 RS-232C interfaces are not mounted, only **[USB]** and **[LAN]** are displayed.

13.4 Connecting and Setting USB

Installing the USB driver

When the instrument is connected to a PC, the USB driver is automatically installed. Since the driver that comes with the OS is used, another driver does not need to be installed.

Installation procedure

- 1** Log in to the PC with administrator privileges, such as “administrator.”
The USB driver is automatically installed.
 - 2** Connect the instrument and the PC using a USB cable.
The instrument is recognized.
- For Windows 10, [USB Serial Port(COMx)] is displayed at the device manager's port (COM and LPT) when the USB is properly recognized. The COM number varies depending on the environment.
 - Even if the instrument with a different serial number is connected, you might receive a notification stating that a new device has been detected.

Connection method

- 1** Connect one end of a (commercially available) USB cable to the USB connector on the instrument.
- 2** Connect the other end of the USB cable to the USB interface on the PC.

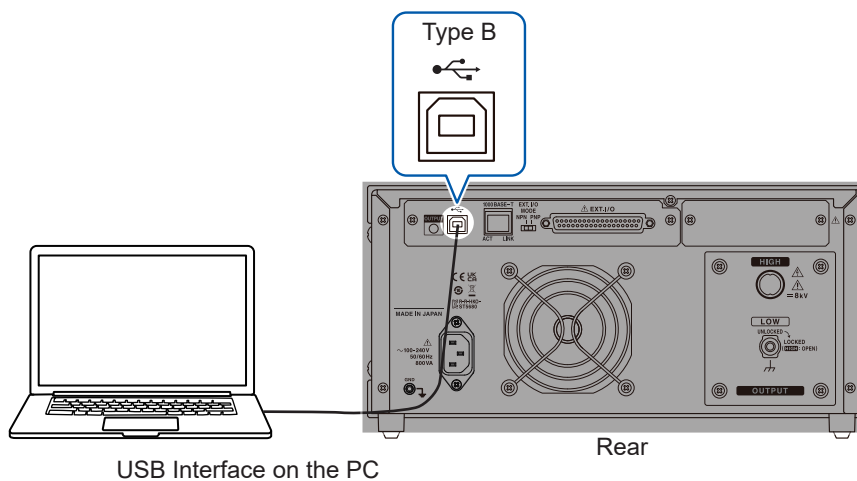

Instrument settings

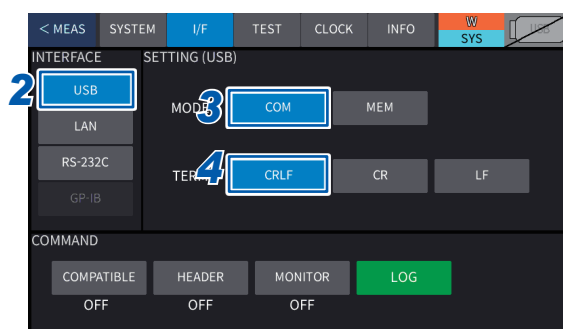

- 1** Press [I/F] on the system screen.
- 2** Press [USB].
- 3** Press [COM].
- 4** Select the terminator.

CRLF*1, CR, LF

*1. Default setting

13.5 Connecting and Setting LAN

Connection method

When connecting the instrument and PC using a LAN cable, you can control and monitor the instrument from the PC.

⚠ CAUTION



- If routing a LAN cable outdoors or using a LAN cable longer than 30 m, attach a LAN surge protector or other suitable protective device.

Failure to do so could cause damage to the instrument due to increased susceptibility to the effects of induced lightning.

There are 2 connection methods, as described below.

(1) Connect the instrument to an existing network to use.

When connecting the instrument and hub using a LAN cable, you can control and monitor the instrument from the PC.

Connecting a single instrument to multiple PCs

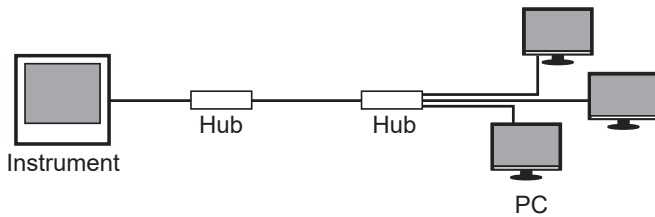

Connecting multiple instruments to a single PC

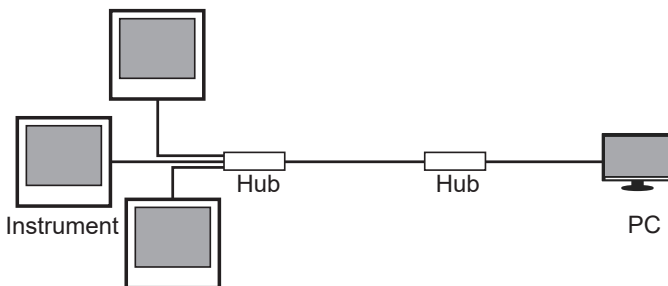

(2) Connect the instrument and PC for 1-to-1 use.

When connecting the instrument and PC using a LAN cable, you can control and monitor the instrument from the PC.

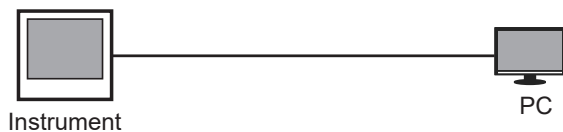

Setting procedure

You can implement command control using TCP/IP protocols.
Set the instrument according to the network environment in use beforehand.

IMPORTANT

- Make sure to make the LAN settings before connecting to the network.
- If you change the settings while the instrument is connected to a network, the instrument may have the same IP address as another device on the LAN, causing incorrect address information to be sent to the LAN.
- The instrument is not compatible with network systems that automatically acquire IP addresses using DHCP.

Explanation of setting items

IP address

An address to identify individual devices that are connected on the network.
Use a unique address that no other device on the network is using.
The instrument uses IP version 4, and IP addresses are expressed as a series of four decimal numbers separated by periods, as in *192.168.0.1*.

Subnet mask

This setting separates the IP address into the network address part showing the network and the host address part showing the device. Displays on the instrument use 4 decimal numbers separated using “.” as in *255.255.255.0*.

Default gateway

If the PC and instrument that are in communication are on different networks, specify the IP address of the device that will act as the gateway.
If not using a gateway, such as with 1-to-1 connections, set the instrument to “0.0.0.0”.

Network environment configuration example

Example 1: Connecting the instrument to the existing network

If connecting the instrument to an existing network, it is necessary to check the network settings beforehand.

It is necessary to allocate IP addresses so that they do not overlap with other network devices.
Check the following items with the network administrator, and keep a memo.

IP address	_____	_____	_____	_____
Subnet mask	_____	_____	_____	_____
Default gateway	_____	_____	_____	_____

Example 2: Connecting one PC and multiple instruments using a hub

If configuring a local network with no external connections, using a private IP address as shown in the example is recommended.

Private IP address example:

IP address	PC: 192.168.0.100
	Instrument: 192.168.0.1* ¹ , 192.168.0.2, 192.168.0.3, ... (Use an IP address that is different from other network devices.)
Subnet mask	255.255.255.0* ¹
Default gateway	Off (0.0.0.0)* ¹

*1. Default setting

Example 3: Connecting one PC and one instrument with a LAN Cable

If connecting the PC and instrument 1-to-1 using a LAN cable, you can set the IP address as desired, but using a private IP address is recommended.

IP address	PC: 192.168.0.100
	Instrument: 192.168.0.1* ² (Set a different IP address from the PC.)
Subnet mask	255.255.255.0* ²
Default gateway	Off (0.0.0.0)* ²

*2. Default setting

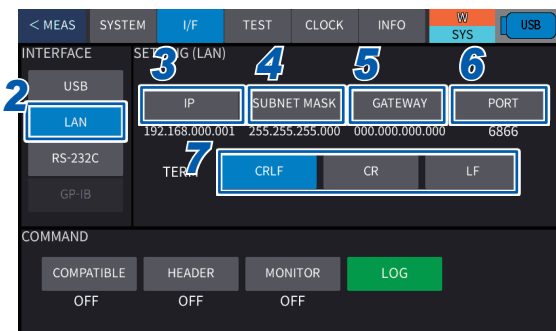

- 1** Press [SYS] > [I/F] on the measurement screen.
- 2** Press [LAN].
- 3** Press [IP] and then set the IP address.
- 4** Press [SUBNET MASK] and then set the subnet mask.
- 5** Press [GATEWAY] and then set the gateway.
If it is not necessary to set a default gateway, for example if setting the instrument and PC 1-to-1, the gateway may remain off (0.0.0.0).
- 6** Press [PORT] and then set the port numbers.

1 to 65535

Default setting: 6866

- 7** Select the terminator.

CRLF*¹, CR, LF

*1. Default setting

13.6 Connecting and Setting RS-232C (Z3001)

Connection method

Connect a RS-232C cable to the RS-232C connector of the instrument.

The L9637 RS-232C Cable (9-pin/9-pin, 1.8 m) is recommended.

Connector: D-sub 9-pin male, #4-40 locking screw

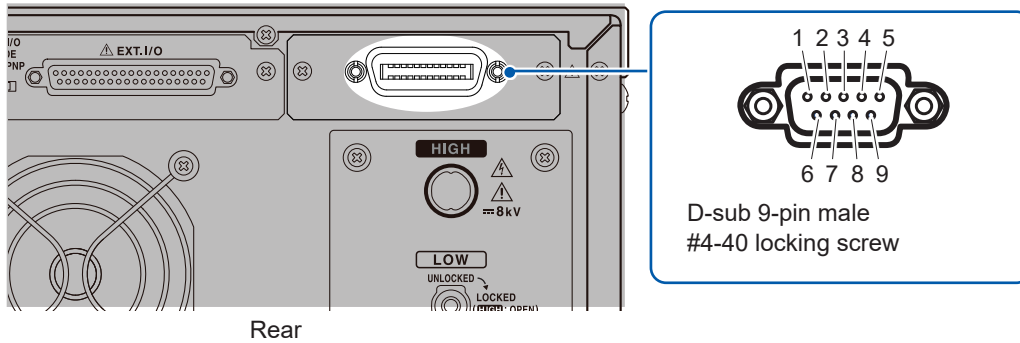

Rear

When connecting a controller (DTE), prepare a cross cable suitable for the specifications of both the instrument and controller connectors.

The I/O connector has terminal (DTE) specifications.

Connector (Dsub) pin No.	Interchange circuit name	CCITT circuit name	EIA code	JIS code	Customary code
1	-	-	-	-	-
2	Receive Data	104	BB	RD	R×D
3	Transmit Data	103	BA	SD	T×D
4	-	-	-	-	-
5	Signal Ground	102	AB	SG	GND
6	-	-	-	-	-
7	-	-	-	-	-
8	-	-	-	-	-
9	-	-	-	-	-

Example: Connecting a PC

Specifications: D-sub 9 pin female connector, reverse wiring

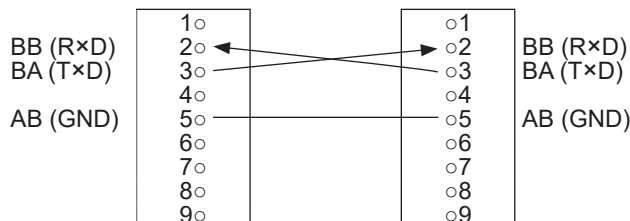

Setting procedure

Set RS-232C communication settings using the system screen. Settable only when a Z3001 RS-232C interface is mounted to the instrument.

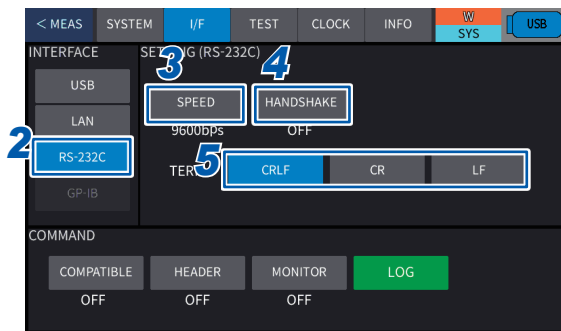

1 Press [SYS] > [I/F] on the measurement screen.

2 Press [RS-232C].

3 Press [SPEED] and then select the Baud rate.

9600^{*1}, 19200, 38400, 57600

*1. Default setting

4 Press [HANDSHAKE] and then select handshake.

OFF^{*2} No flow control

SOFTWARE Software control (XON/XOFF)

*2. Default setting

5 Select the terminator.

CRLF^{*3}, CR, LF

*3. Default setting

13.7 Connecting and Setting GP-IB (Z3000)

Connection method

Connect a GP-IB cable to the GP-IB connector of the instrument.

A 9151-02 GP-IB Connector Cable (2 m) is recommended.

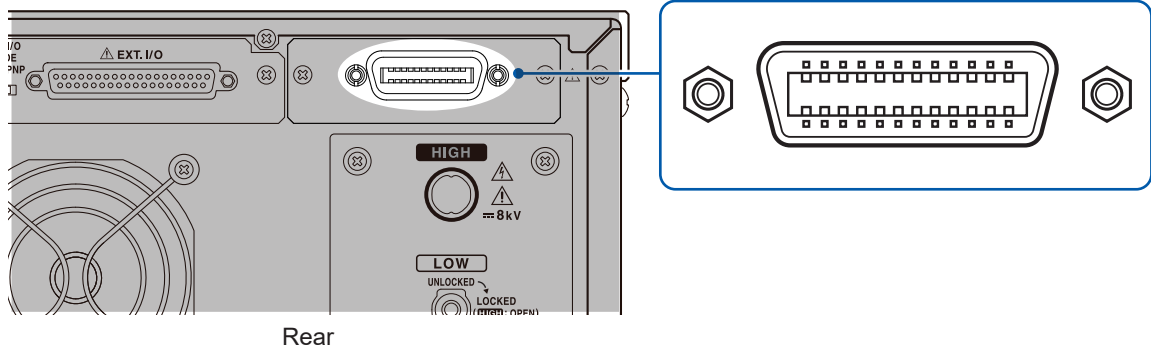

Setting procedure

Set GP-IB communication settings using the system screen. Settable only when a Z3000 GP-IB interface is mounted to the instrument.

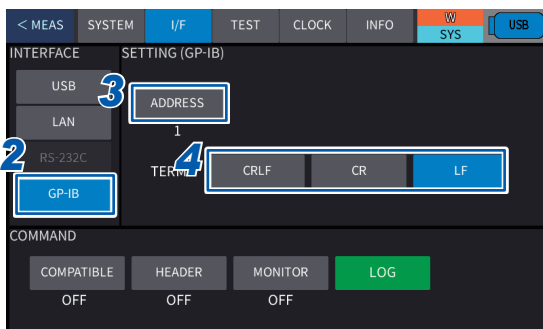

- 1 Press **[SYS]** > **[I/F]** on the measurement screen.
- 2 Press **[GP-IB]**.
- 3 Press **[ADDRESS]** and then set the **GP-IB** address.

0 to 30

Default setting: 1

Select the terminator.

CRLF	CR + LF concomitant with EOI
CR	CR concomitant with EOI
LF*1	LF concomitant with EOI

*1. Default setting

13.8 Control Using Communications Commands

For the communications command and query notations (communication message reference), see the Communications Command Instruction Manual on the provided CD.

Remote state

If starting communications after connecting an interface to the instrument, the instrument enters the remote state (remote operations mode) and **[REMOTE]** is displayed on the measurement screen.

In the remote state, touch screen operations other than **[LOCAL]** become disabled.



Local state

The following operations reset the remote state and allow the instrument to enter the local state that enables touch screen operation.

- Press **[LOCAL]**.
- Turn on the instrument again.
- Send the `:SYSTem:LOCal` command to the instrument via a communication interface.
- Send the `GTL` command to the instrument from GP-IB.



13.9 Command Compatibility Function

Using the command compatibility function allows you to set the model with which commands are interchanged.

- 1 Press [SYS] > [I/F] on the measurement screen.
- 2 Press [COMPATIBLE].

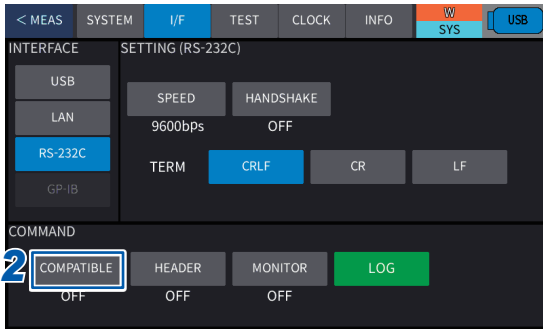

- 3 Select the setting.

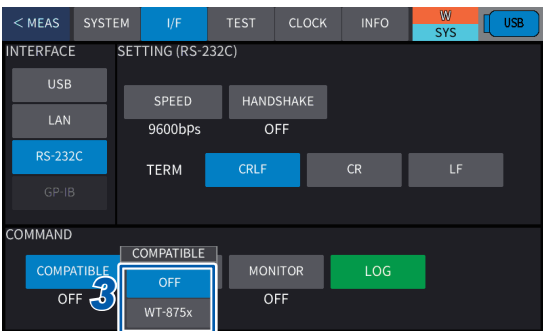

OFF *1	The command compatibility function is not used. Standard command setting
WT-875x	WT-875x command compatibility setting

*1. Default setting

13.10 Command Header Function

Using the command header function allows you to specify whether to set a header to response messages.

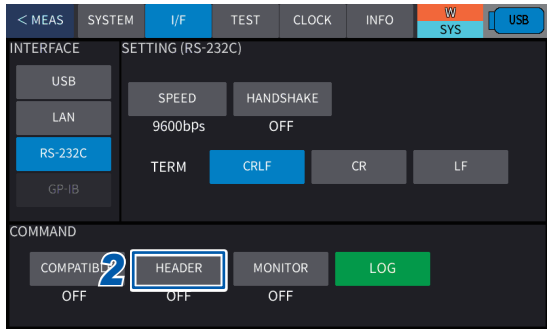

- 1 Press [SYS] > [I/F] on the measurement screen.
- 2 Press [HEADER].

OFF*1	No header is set to query responses
ON	A header is set to query responses

*1. Default setting

IMPORTANT
When the instrument is turned on, the header setting is initialized to off.

13.11 Command Monitor Function

The command monitor function allows communications commands and query responses to be displayed on the screen.

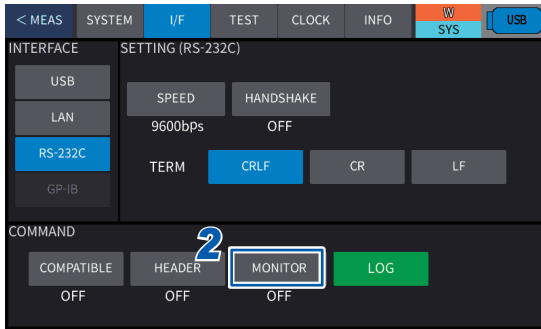

1 Press **[SYS]** > **[I/F]** on the measurement screen.

2 Press **[MONITOR]**.

OFF *1	Communication monitor is not displayed.
ON	Communication monitor is displayed.

*1. Default setting

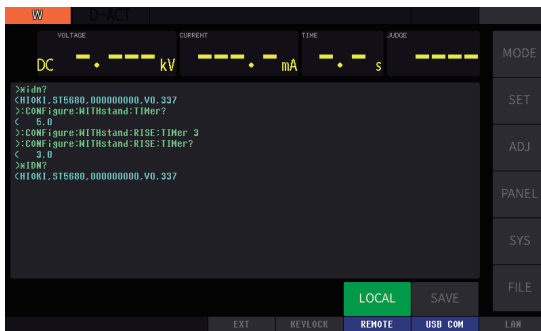

When this function is set to **[ON]**, the communication monitor is displayed on the measurement screen.

IMPORTANT

- If the communication monitor function is turned on, the communication monitor time is displayed onscreen in addition to the communications sending and receiving time. Due to this, the communication time will be lengthened. This lengthening will be particularly conspicuous if the number of response data characters is great.
- When commands are transmitted continuously, the error display position may be misaligned.

13.12 Command Log Screen

Entering the command log screen allows you to check the records of the communications commands that have been sent and received and query responses.

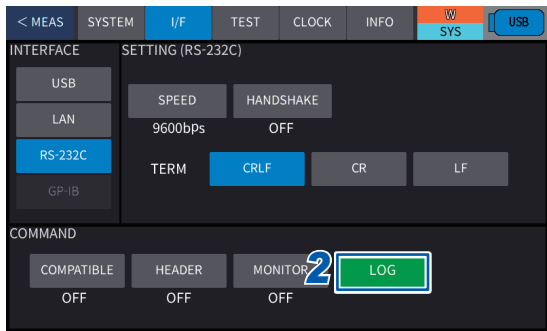

1 Press **[SYS] > [I/F]** on the measurement screen.

2 Press **[LOG]**.

The command log screen is displayed.

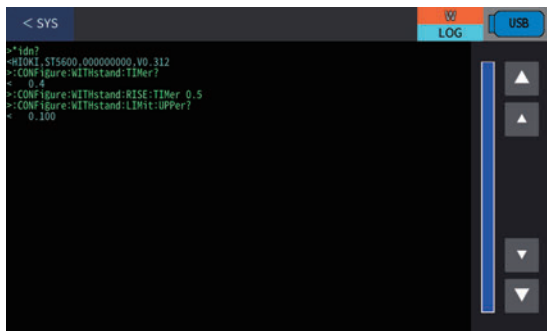

- Communication records are displayed in chronological order.
- Up to 10,000 characters of communication records can be saved in the instrument.
- If communication records exceed 10,000 characters, they are deleted in chronological order.

IMPORTANT
When the instrument is turned on, the records in the command log screen are initialized.

14 Specifications

14.1 General Specifications

Operating environment	Indoor, pollution degree 2, altitude up to 2000 m (6562 ft.)
Operating temperature and humidity range	0°C to 40°C (32°F to 104°F), 80% RH or less (non-condensing)
Storage temperature and humidity range	-10°C to 50°C (14°F to 122°F), 80% RH or less (non-condensing)
Standards	Safety EN 61010 EMC EN 61326 Class A
Power supply	Rated supply voltage: 100 V to 240 V AC (assuming voltage fluctuation of $\pm 10\%$) Rated power-supply frequency: 50 Hz/60 Hz Anticipated transient overvoltage: 2500 V Maximum rated power: 800 VA max.
Clock backup	Approx. 4 months when not used (reference value)
Display	Color TFT 7.0" display with a resistant-film touch screen
Interface	USB function (standardly equipped) USB flash drive (standardly equipped) LAN (standardly equipped) RS-232C (option, the Z3001 required) GP-IB (option, the Z3000 required)
Dimensions	Approx. 305W × 142H × 430D mm (12.01"W × 5.59"H × 16.93"D)
Weight	Approx. 10.0 kg (352.7 oz., without options)
Warranty period	3 years
Accessories	See p. 8.
Option	See p. 9.

14.2 Input Specifications, Output Specifications, Measurement Specifications

Basic specifications

Test mode	DC withstand voltage test mode (DCW) Insulation resistance test mode (IR) W-IR/IR-W test mode Program mode BDV measurement mode	
Output specifications		
-1. DC withstand voltage test mode		
DC output unit	Output voltage range	0.010 kV to 8.000 kV (default setting: 0.100 kV)
	Output setting resolution	1 V
	Maximum rated load	500 W (5 kV, 100 mA)
	Maximum rated current	100 mA
	Ripple	0.6% (peak) or less
	Voltage fluctuation rate	±1% or less (However, when the load changes from maximum rated load to no load, this rate is applied to a voltage of 1 kV or more.)
	Short-circuit current	200 mA or more (when a voltage of 1 kV or more is output)
-2. Insulation resistance test mode		
DC output unit	Output voltage range	10 V to 2000 V (default setting: 100 V)
	Output setting resolution	1 V
	Maximum rated load	200 W (2000 V, 100 mA)
	Maximum rated current	100 mA
	Ripple	1.2% (peak) or less
	Voltage fluctuation rate	±1% or less (However, when the load changes from maximum rated load to no load, this rate is applied to a voltage of 1 kV or more.)
	Short-circuit current	200 mA or more (when a voltage of 1 kV or more is output)
Time rating	See p. 58.	

Measurement specifications																												
-1. DC withstand voltage test mode																												
Voltmeter	Measurement range	0.000 kV to 8.400 kV																										
	Display	□.□□□ kV (resolution: 1 V)																										
Ammeter	Range configuration	Fixed range, auto-range Default setting: fixed range																										
	Accuracy warranty range, display range																											
		<table border="1"> <thead> <tr> <th>Current range</th> <th>Display range</th> <th>Accuracy guarantee range</th> <th>Accuracy</th> </tr> </thead> <tbody> <tr> <td rowspan="2">300 μA range</td> <td>0.000 μA to 9.999 μA</td> <td>-</td> <td>-</td> </tr> <tr> <td>5.0 μA to 299.9 μA</td> <td>10.0 μA to 299.9 μA</td> <td>±(1.5% rdg +2 μA)</td> </tr> <tr> <td>3 mA range</td> <td>0.000 mA to 2.999 mA</td> <td>0.100 mA to 2.999 mA</td> <td>±(1.5% rdg +2 μA)</td> </tr> <tr> <td>30 mA range</td> <td>0.00 mA to 29.99 mA</td> <td>1.00 mA to 29.99 mA</td> <td>±1.5% rdg</td> </tr> <tr> <td rowspan="2">100 mA range</td> <td>0.0 mA to 100.0 mA</td> <td>10.0 mA to 100.0 mA</td> <td>±1.5% rdg</td> </tr> <tr> <td>100.1 mA to 200.0 mA</td> <td>-</td> <td>-</td> </tr> </tbody> </table>	Current range	Display range	Accuracy guarantee range	Accuracy	300 μA range	0.000 μA to 9.999 μA	-	-	5.0 μA to 299.9 μA	10.0 μA to 299.9 μA	±(1.5% rdg +2 μA)	3 mA range	0.000 mA to 2.999 mA	0.100 mA to 2.999 mA	±(1.5% rdg +2 μA)	30 mA range	0.00 mA to 29.99 mA	1.00 mA to 29.99 mA	±1.5% rdg	100 mA range	0.0 mA to 100.0 mA	10.0 mA to 100.0 mA	±1.5% rdg	100.1 mA to 200.0 mA	-	-
Current range	Display range	Accuracy guarantee range	Accuracy																									
300 μA range	0.000 μA to 9.999 μA	-	-																									
	5.0 μA to 299.9 μA	10.0 μA to 299.9 μA	±(1.5% rdg +2 μA)																									
3 mA range	0.000 mA to 2.999 mA	0.100 mA to 2.999 mA	±(1.5% rdg +2 μA)																									
30 mA range	0.00 mA to 29.99 mA	1.00 mA to 29.99 mA	±1.5% rdg																									
100 mA range	0.0 mA to 100.0 mA	10.0 mA to 100.0 mA	±1.5% rdg																									
	100.1 mA to 200.0 mA	-	-																									
Display update speed	5 times/sec. or more																											
Test time	Setting range	0.1 s to 999 s Test-time off (timer off) function available																										
	Set resolution	0.1 s to 99.9 s: 0.1 s, 100 s to 999 s: 1 s																										
	Accuracy	±(100 ppm +20 ms)																										
	Default setting	1.0 s																										
Voltage rise time	Setting range	0.1 s to 300 s																										
	Set resolution	0.1 s to 99.9 s: 0.1 s, 100 s to 300 s: 1 s																										
	Default setting	0.1 s																										
Voltage drop time	Setting range	0.1 s to 300 s, off																										
	Set resolution	0.1 s to 99.9 s: 0.1 s, 100 s to 300 s: 1 s																										
	Default setting	Off																										
	The voltage drop time setting is enabled only for pass judgment.																											
Judgment wait time setting (delay setting)	Operations	Since a large charging current may flow when a test voltage is applied to a capacitive DUT in DCW mode, the delay time, which begins from applying the test voltage to the start of the upper-limit judgment, can be set.																										
	Setting range	0.1 s to 99.9 s, off																										
	Default setting	Off																										

-2. Insulation resistance test mode

Voltmeter	Display range	0 V to 2500 V
	Resolution	1 V

Resistance meter Range configuration Fixed range, auto-range
(default setting: fixed range)

Set voltage (accuracy guaranteed for 50 V or more.)	Resistance range	Display range	Accuracy warranty range
10 V ≤ V < 100 V	100 kΩ	10.00 kΩ to 99.99 kΩ	10.00 kΩ to 999.9 MΩ
	1 MΩ	35.0 kΩ to 999.9 kΩ	
	10 MΩ	0.350 MΩ to 9.999 MΩ	
	100 MΩ	3.50 MΩ to 99.99 MΩ	
	1 GΩ	35.0 MΩ to 999.9 MΩ 0.350 GΩ to 2.000 GΩ	
100 V ≤ V < 1000 V	100 kΩ	10.00 kΩ to 99.99 kΩ	10.00 kΩ to 9.999 GΩ
	1 MΩ	35.0 kΩ to 999.9 kΩ	
	10 MΩ	0.350 MΩ to 9.999 MΩ	
	100 MΩ	3.50 MΩ to 99.99 MΩ	
	1 GΩ	35.0 MΩ to 999.9 MΩ	
	10 GΩ	0.350 GΩ to 9.999 GΩ 3.50 GΩ to 20.00 GΩ	
1000 V ≤ V ≤ 2000 V	100 kΩ	20.00 kΩ to 99.99 kΩ	20.00 kΩ to 99.99 GΩ
	1 MΩ	70.0 kΩ to 999.9 kΩ	
	10 MΩ	0.700 MΩ to 9.999 MΩ	
	100 MΩ	7.00 MΩ to 99.99 MΩ	
	1 GΩ	70.0 MΩ to 999.9 MΩ	
	10 GΩ	0.700 GΩ to 9.999 GΩ	
	100 GΩ	7.00 GΩ to 99.99 GΩ 70.0 GΩ to 200.0 GΩ	

Accuracy guarantee range

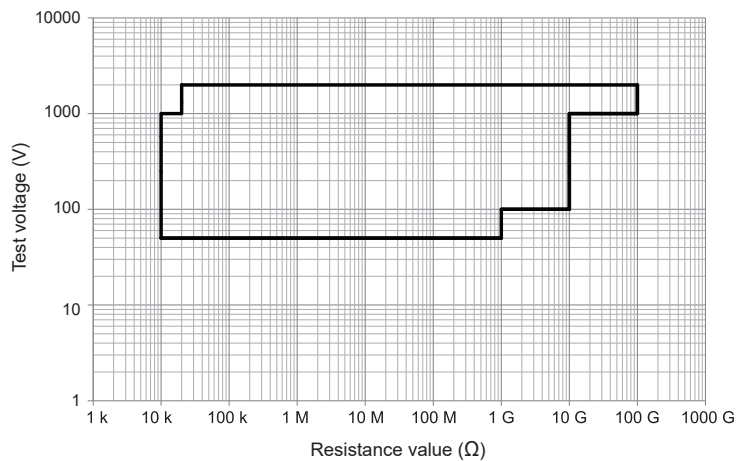

Display update speed	5 times/sec. or more	
Test time	Setting range	0.1 s to 999 s, test-time off (timer off) function available
	Set resolution	0.1 s to 99.9 s: 0.1 s, 100 s to 999 s: 1 s
	Accuracy	±(100 ppm +20 ms)
	Default setting	1.0 s
Voltage rise time	Setting range	0.1 s to 300 s
	Set resolution	0.1 s to 99.9 s: 0.1 s, 100 s to 300 s: 1 s
	Default setting	0.1 s

Voltage drop time	Setting range	0.1 s to 300 s, off
	Set resolution	0.1 s to 99.9 s: 0.1 s, 100 s to 300 s: 1 s
	Default setting	Off
	The voltage drop time setting is enabled only for pass judgment.	
Judgment wait time setting (Delay setting)	Operations	The time period for not making lower-limit judgment from the start of a test (delay time) can be set. It is enabled when the load to be measured contains capacitive components.
	Setting range	0.1 s to 99.9 s, off
	Default setting	Off

Accuracy specifications

Accuracy guarantee conditions	Accuracy warranty period: 1 year	
	Accuracy guarantee temperature and humidity range: 23°C ±5°C (73°C ±9°C), 80% RH or less (non-condensing)	
	Warm-up time: 30 minutes or longer	
	Power supply-frequency range: 50 Hz ±2 Hz, 60 Hz ±2 Hz	
	The High Voltage Test Lead should not be subjected to vibration or other disturbances.	
DC withstand voltage test mode	Output setting accuracy	±(1.2% of setting +20 V), without load
	Voltmeter accuracy	±(1% rdg +5 V)
	Ammeter accuracy	For 3.00 mA or more: ±1.5% rdg For less than 3.00 mA: ±(1.5% rdg +2 µA)

Insulation resistance test mode

Output setting accuracy

$\pm(1.2\%$ of setting +2 V), without load

Voltmeter accuracy

$\pm(1\%$ rdg +5 V)

Resistance meter accuracy (accuracy guaranteed for the test voltage range of 50 V to 2000 V.)

When measurement is performed normally

Measureable range		10 k Ω to 99.99 G Ω (within the range of the maximum rated power of 500 VA)	
IR	10 nA \leq I \leq 3 μ A	100 M Ω to 999.9 M Ω	$\pm(20\%$ of reading) ^{*1, *2, *3}
		1.00 G Ω to 99.99 G Ω	
	100 nA \leq I \leq 30 μ A	10.00 M Ω to 99.99 M Ω	$\pm(5\%$ of reading) ^{*1, *2, *3}
		100.0 M Ω to 999.9 M Ω	
	1 μ A \leq I \leq 300 μ A	1.000 M Ω to 9.999 M Ω	$\pm(2\%$ of reading +5 digits) ^{*1, *2, *3}
		10.00 M Ω to 99.99 M Ω	
	10 μ A \leq I \leq 3 mA	100.0 k Ω to 999.9 k Ω	$\pm(1.5\%$ of reading +3 digits) ^{*1, *2, *3}
1.000 M Ω to 9.999 M Ω			
100 μ A \leq I \leq 30 mA	10.00 k Ω to 99.99 k Ω		
	100.0 k Ω to 999.9 k Ω		
1 mA \leq I \leq 100 mA	10.00 k Ω to 99.99 k Ω		

*1. Add ± 10 percent points to the measurement accuracy when the test voltage is within the range of 50 V to 99 V.

*2. Add ± 5 percent points to the measurement accuracy when the test voltage is within the range of 100 V to 999 V.

*3. Add ± 2 percent points to the measurement accuracy when the test voltage is within the range of 1000 V to 2000 V.

When the offset cancel is enabled

Measureable range		10 k Ω to 99.99 G Ω (within the range of the maximum rated power of 500 VA)	
IR	10 nA \leq I \leq 3 μ A	100 M Ω to 999.9 M Ω	$\pm(30\%$ of reading) ^{*1, *2, *3}
		1.00 G Ω to 99.99 G Ω	
	100 nA \leq I \leq 30 μ A	10.00 M Ω to 99.99 M Ω	$\pm(25\%$ of reading) ^{*1, *2, *3}
		100.0 M Ω to 999.9 M Ω	
	1 μ A \leq I \leq 300 μ A	1.000 M Ω to 9.999 M Ω	$\pm(22\%$ of reading +5 digits) ^{*1, *2, *3}
		10.00 M Ω to 99.99 M Ω	
	10 μ A \leq I \leq 3 mA	100.0 k Ω to 999.9 k Ω	$\pm(8.5\%$ of reading +3 digits) ^{*1, *2, *3}
1.000 M Ω to 9.999 M Ω			
100 μ A \leq I \leq 30 mA	10.00 k Ω to 99.99 k Ω		
	100.0 k Ω to 999.9 k Ω		
1 mA \leq I \leq 100 mA	10.00 k Ω to 99.99 k Ω	$\pm(6\%$ of reading +3 digits) ^{*1, *2, *3}	

*1. Add ± 10 percent points to the measurement accuracy when the test voltage is within the range of 50 V to 99 V.

*2. Add ± 5 percent points to the measurement accuracy when the test voltage is within the range of 100 V to 999 V.

*3. Add ± 2 percent points to the measurement accuracy when the test voltage is within the range of 1000 V to 2000 V.

14.3 Functional Specifications

-1. Withstand voltage test mode

Judgment function	Judgment operation				
	Judgment	Judgment procedure	Display	Buzzer	External I/O
	Upper fail	If (<i>measured value</i>) > (<i>upper reference value</i>) is satisfied, the output is cut off, and an upper-fail judgment is given. Judgment is not performed during the judgment wait time (delay time) beginning from the test start.	Displayed on the LCD	On	U_FAIL signal on
	Lower fail	If (<i>measured value</i>) < (<i>lower reference value</i>) is satisfied, the output is cut off, and a lower-fail judgment is given. Judgment not performed during the voltage rise time.	Displayed on the LCD	On	L_FAIL signal on
	Pass	When (<i>upper reference value</i>) \geq (<i>measured value</i>) \geq (<i>lower reference value</i>) is satisfied after the set time has elapsed, the output is shut off, and a pass judgment is given.	Displayed on the LCD	On	PASS signal on
					<ul style="list-style-type: none"> • The PASS signal is continuously output until the next test starts. • The UPPER FAIL and LOWER FAIL signals are continuously output until the next test starts. • The fail and pass buzzer volume can be adjusted.
	Upper-limit reference value setting	0.010 mA to 100.0 mA (default setting: 0.011 mA)			
	Lower-limit reference value setting	0.010 mA to 100 mA, off (default setting: Off, 0.010 mA)			
	Set resolution	0.001 mA (0.010 mA to 9.999 mA) 0.01 mA (10 mA to 99.99 mA)			
	Judgment accuracy	For 1.000 mA or more: $\pm(1.5\%$ of setting) For less than 1.000 mA: $\pm(1.5\%$ of setting +30 μ A)			
Automatic discharge function	Operations	Residual electric charge is discharged through the internal circuit at the completion of a DC withstand voltage test. (discharge resistance: 700 k Ω)			
Start voltage	Operations	The voltage at the start of a test can be set as a start voltage.			
	Setting range	0% to 99% of the test voltage (resolution: 1%)			
	Default setting	0%			
Limit voltage value	Operations	The upper-limit reference value for the test voltage setting can be set to prevent excessive voltage from being applied to the test target due to operation errors, etc.			
	Setting range	0.010 kV to 8.000 kV			
	Default setting	8.000 kV			
Output voltage monitoring function	Operations	The output is shut down and the test ends when the output voltage exceeds $\pm(5\%$ of setting +50 V) after the voltage rise time or the voltage deviates from the set test voltage during the test and does not fall within ± 10 dgt of the set voltage within 5 seconds.			
Resistance value display	Operations	The resistance value, calculated by dividing the measured voltage value by measured current value, of the test target during a test is displayed.			
Maximum current value display	Operations	The maximum value of the measured current value during a test can be displayed.			

Arc detection function	Operations	The function can detect changes in the test voltage when a discharge occurs during a withstand voltage test, determining an arc discharge occurred.
	Operation mode	
	Off	Detection off
	Cont	Continues the test after detecting an arc.
	Stop	Stops the test after detecting an arc.
	(No arc cannot be detected during the test-voltage rise time.)	
Setting value	Test voltage fluctuation rate: 1% to 50% (resolution: 1%)	
Default setting	Operation mode: off Setting value: 1%	

-2. Insulation resistance test mode

Judgment function	Judgment operation				
	Judgment	Judgment procedure	Display	Buzzer	External I/O
	Upper fail	If (<i>measured value</i>) > (<i>upper reference value</i>) is satisfied, the output is cut off, and an upper-fail judgment is given. Judgment is not performed during the voltage rising time.	Displayed on the LCD	On	U_FAIL signal on
	Lower fail	If (<i>measured value</i>) < (<i>lower reference value</i>) is satisfied, the output is cut off, and a lower-fail judgment is given. Judgment is not performed during the judgment wait time (delay time) beginning from the test start.	Displayed on the LCD	On	L_FAIL signal on
	Pass	When (<i>upper reference value</i>) ≥ (<i>measured value</i>) ≥ (<i>lower reference value</i>) is satisfied after the set time has elapsed, the output is shut off, and a pass judgment is given.	Displayed on the LCD	On	PASS signal on

- The PASS signal is continuously output until the next test starts.
- The UPPER FAIL and LOWER FAIL signals are continuously output until the next test starts.
- The fail and pass buzzer volume can be adjusted.

Upper-limit reference value setting 10.00 kΩ to 99.99 GΩ, off
(default setting: off, upper-limit reference value 100 MΩ)

Lower-limit reference value setting 10.00 kΩ to 99.99 GΩ
(default setting: 1.000 MΩ)

Set resolution 0.01 kΩ (10.00 kΩ to 99.99 kΩ)
0.1 kΩ (100.0 kΩ to 999.9 kΩ)
0.001 MΩ (1.000 MΩ to 9.999 MΩ)
0.01 MΩ (10.00 MΩ to 99.99 MΩ)
0.1 MΩ (100.0 MΩ to 999.9 MΩ)
0.001 GΩ (1.000 GΩ to 9.999 GΩ)
0.01 GΩ (10.00 GΩ to 99.99 GΩ)

Judgment accuracy (measurement accuracy) +2 digits

Automatic discharge function	Operations	Residual electric charge is discharged from the test target through the internal circuit at the completion of a test. (discharge resistance: 700 kΩ)
	Limit voltage value	Operations
	Setting range	10 V to 2000 V
	Default setting	2000 V

Output voltage monitoring function	Operations	The output is shut down and the test ends when the output voltage exceeds $\pm(5\%$ of the setting +10 V) after the voltage rise time or the voltage deviates from the test voltage during the test and does not fall within ± 10 dgt of the set voltage within 5 seconds.
Minimum resistance value display	Operations	The minimum value of the measured insulation resistance value during a test can be displayed.
Insulation resistance test end mode	Operations	Sets the conditions to end an insulation resistance test.
	Operation mode	Time: Performs the test for the set duration and makes a judgment with the value at the end of the test.
		Pass: Ends the test at the time of pass judgment within the set duration (excluding the delay time). Fail: Ends the test at the time of fail judgment within the set duration (excluding the delay time).
	Default setting	Time

-3. W-IR/IR-W test mode

Operations	W-IR mode	Performs a withstand voltage test and then an insulation resistance test.
	IR-W mode	Performs an insulation resistance test and then a withstand voltage test.
Setting details	Withstand voltage test	Test conditions set in the withstand voltage test mode
	Insulation resistance test	Test conditions set in the insulation resistance test mode
	Interval time	0.1 s to 100.0 s, TRIG When TRIG is set, pressing the START button proceeds to the next step. Default setting: 0.1 s
	Operations for fail judgment	Test end, test continue Default setting: Test end

-4. Program mode

Operations	Operations are performed automatically with DCW and IR combined.	
Maximum number of steps	50	
Step setting items	The test conditions similar to those for a single test can be set. (The test time cannot be set to off.)	
Program setting items	Step interval time	0.1 s to 100.0 s, TRIG Default setting: 0.1 s When TRIG is set, pressing the START button proceeds to the next step.
	Operations for fail judgment	Test end, test continue Default setting: Test end

-5. BDV measurement mode

Operations	Function to measure the start voltage for dielectric breakdown with the test voltage raised automatically during a withstand voltage test	
Test method	Continuous voltage rise test, gradual voltage rise test Default setting: Continuous voltage rise test	
Continuous voltage rise test		
Setting details	Test frequency	DC
	Initial voltage	Setting range: 0.010 kV to 7.999 kV (Set resolution: 0.001 kV, default setting: 0.010 kV)
	End voltage	Setting range: 0.011 kV to 8.000 kV (Set resolution: 0.001 kV, default setting: 5.000 kV)
	Voltage rise speed	1 V/s, 2 V/s, 5 V/s, 10 V/s, 12 V/s, 20 V/s, 50 V/s, 100 V/s, 200 V/s, 500 V/s, 1000 V/s, 2000 V/s, 5000 V/s (default setting: 500 V/s)
	Arc detection	Operation mode: Off Detection off On After detecting arc, stops test. (default setting: Off) Setting value: Test voltage fluctuation rate 1% to 50% (Set resolution: 1%, default setting: 1%)
	Distance between electrodes	Setting range: 0.01 mm to 10.0 mm (Set resolution: 0.01 mm, default setting: 0.01 mm)
	Upper reference limit	Setting range: 0.010 mA to 100.0 mA (Set resolution: 0.001 mA [0.010 mA to 9.999 mA] 0.01 mA [10 mA to 99.99 mA] Default setting: 0.010 mA)
	Number of tests	Setting range: 1 to 20 times (default setting: 1 time)
Measurement details	<ul style="list-style-type: none"> • Dielectric breakdown voltage (unit: kV) Voltage when a dielectric breakdown occurs in the test piece under the specified test conditions The median, average, and standard deviation are displayed. • Dielectric breakdown strength (unit: kV/mm) Value obtained by dividing the dielectric breakdown voltage by the distance between two electrodes used for a test The median, average, and standard deviation are displayed. 	

Gradual voltage rise test	
Setting details	
Test frequency	DC
Initial voltage	0.25 kV, 0.50 kV, 1 kV, 2 kV, any voltage Setting range: 0.010 kV to 7.999 kV (Set resolution: 0.001 kV, default setting: 0.010 kV)
Voltage holding time for each step	20 s (default setting), 60 s, 300 s, hold, any time Setting range: 1 s to 300 s (set resolution 1 s, default setting: 20 s) When hold is selected, pressing the START button, inputting an START signal to the external I/O terminal, or sending a communication command when the specified step is in the hold state proceeds to the next step.
Voltage steps	10% of the initial voltage, 0.1 kV, 0.2 kV, any voltage Setting range: 0.010 kV to 5.000 kV (set resolution: 0.001 kV, default setting: 10% of initial voltage)
Maximum number of steps	20 steps (default setting: 10 steps)
Arc detection	Operation mode: Off Detection off On After detecting arc, stops test. (No arc cannot be detected during the test-voltage rise time between steps.) (default setting: Off) Setting value: Test voltage fluctuation rate 1% to 50% (Set resolution: 1%, default setting: 1%)
Distance between electrodes	Setting range: 0.01 mm to 10.0 mm (Set resolution: 0.01 mm, default setting: 0.01 mm)
Upper reference limit	Setting range: 0.010 mA to 100.0 mA (Set resolution: 0.001 mA [0.010 mA to 9.999 mA] 0.01 mA [10 mA to 99.99 mA] Default setting: 0.010 mA)
Number of tests	Setting range: 1 to 20 times (default setting: 1 time)
Measurement details	<ul style="list-style-type: none"> • Dielectric breakdown voltage (unit: kV) Highest voltage at which no dielectric breakdown occurs in the test piece for the specified holding time The median, average, and standard deviation are displayed. • Dielectric breakdown strength (unit: kV/mm) Value obtained by dividing the dielectric breakdown voltage by the distance between two electrodes used for a test The median, average, and standard deviation are displayed.
Voltage measurement accuracy	±5% rdg
Dielectric breakdown judgment procedure	Current upper-limit reference value setting, arc discharge detection
Graph display	The voltage value and measured current value of each test are displayed in chronological order.

-6. Other functions

Waveform and graph display	Display	Waveform display: applied voltage, current waveform for DCW and IR tests Graph display: Measured voltage value, measured current value, measured insulation resistance value
	Display method	Measured values and waveforms display, waveform display only
	Cursor function	Voltage value or current value measurement, time measurement
	How to save	The waveform and graph can be saved as data. Saving destination: USB flash drive Data format: BMP, PNG, CSV file format Save method: Manual or communications command
	Waveform color change	Allowed
Contact check	Operations	An error signal is displayed as poor contact when the electrostatic capacity between the high and low drops below the judgment threshold value. Valid when the test voltage is 100 V or more
	Detection method	Electrostatic capacitance measurement method The contact condition is determined at the end of a test.
	Electrostatic capacity monitor	The electrostatic capacity between the high and low can be monitored on the compensation execution screen. Monitoring range: 0.0 nF to 120.0 nF (reference value)
	Setting value	Contact check: On, off Threshold value: 1.0 nF to 100.0 nF (reference value)
	Set resolution	0.1 nF
	Available test mode	DCW, IR, W-IR/IR-W, program mode
	Default setting	Contact check: Off Threshold value: 1 nF
Offset cancel	Operations	The current that flows through the test lead or jig in the DCW or IR mode is measured in advance and the measured value is subtracted from the measurement result.
	Setting value	On, off
	Available test mode	DCW, IR, W-IR/IR-W, program mode
	Default setting	Off

Panel memory function	Operations	Function to save test condition settings in the instrument. Test conditions can be loaded in the following ways. <ul style="list-style-type: none"> • Instrument key operation • Communications command through each interface • Inputting of a signal to the external I/O terminal 							
	Data in memory	<p>DCW test</p> <p>Test voltage, start voltage, test time, voltage rise time, voltage drop time, judgment wait time, current judgment upper-limit value, current judgment lower-limit value, arc detection function, current compensation value of offset canceling function, threshold value and compensation value of contact check</p> <p>IR test</p> <p>Test voltage, test time, voltage rise time, voltage drop time, judgment wait time, resistance judgment upper-limit value, resistance judgment lower-limit value, resistance compensation value of offset canceling function, threshold value and compensation value of contact check</p> <p>Program test</p> <p>Test conditions and compensation value of each step, number of test steps</p> <p>BDV measurement</p> <p>Test mode, initial voltage, end voltage, voltage rising speed, voltage step, voltage holding time, number of steps, arc detection function, distance between electrodes, upper reference value, number of tests</p> <table> <tbody> <tr> <td>DCW:</td> <td>Up to 64 patterns</td> </tr> <tr> <td>IR:</td> <td>Up to 64 patterns</td> </tr> <tr> <td>Program test:</td> <td>Up to 50 steps, 30 patterns</td> </tr> <tr> <td>BDV measurement:</td> <td>Up to 10 patterns</td> </tr> </tbody> </table>	DCW:	Up to 64 patterns	IR:	Up to 64 patterns	Program test:	Up to 50 steps, 30 patterns	BDV measurement:
DCW:	Up to 64 patterns								
IR:	Up to 64 patterns								
Program test:	Up to 50 steps, 30 patterns								
BDV measurement:	Up to 10 patterns								
Data memory function	Operations	Test results (up to 32,000 results) can be saved in the instrument. Data can be loaded using a communications command or USB flash drive. No backup function (Data is deleted when the instrument is turned off.)							
	Information to be saved	Test mode: DCW, IR, W-IR/IR-W, program Judgment result: pass, upper fail, lower fail, stop Elapsed test time (sec.) Voltage measured value Current measured value Measured resistance value Test start time							
	Operation mode	On, off							
	Default setting	Off							
GFI function	Operations	Function to protect operators from electric shock. This function shuts down the output when a current over 0.5 mA flows from the high-voltage output part to the ground during a test.							
	Operation mode	On, off							
	Default setting	On							
Buzzer	Operations	The buzzer volume for pass or fail judgment can be set. The buzzer sounds approximately 50 ms when a pass judgment is made and approximately 1 s when a fail judgment is made.							
		Buzzer volume setting range for pass judgment: 0 to 5 (default setting: 3) Buzzer volume setting range for fail judgment: 0 to 5 (default setting: 3)							

Momentary out	Operations	A voltage is output and a test is performed only while the START button is being pressed. When the START button is released, the test is forcefully terminated.
	Operation mode	On, off
	Default setting	Off
Interlock	Operations	This function cuts off output in conjunction with an external device to ensure operator safety. When the space between INTERLOCK and ISO_COM of the external I/O is opened, the instrument switches to the protection status.
Key lock	Operations	Disable keys other than the START , STOP , and key-lock canceling buttons to prevent changes to the test mode and test setting values.
	Operation mode	On, off
	Pass code setting range	0 to 4 digits (default setting: None)
	Default setting	Off
Clock function	Operations	The clock is set in the format of YY/MM/DD HH:MM:SS.
Calibration expiration check function	Operations	A warning message is displayed when the calibration period expires if the calibration expiration date is set in advance.
	Operation mode	On, off
	On	With check. Set value: YY/MM/DD
	Off	Without check
	Default setting	On (The calibration expiration date is set at the time of shipment.)
USB flash drive operation	1. Saving the test results	
	Function	Saves the test results currently displayed onscreen
	Save items	Test results, measurement results, waveform data
	Data format	CSV file format
	File name	Automatically generated from the date and time
	2. Saving a screenshot	
	Function	Saves the screen that is currently displayed
	Data format	BMP, PNG file format (Color or monochrome)
	File name	Automatically generated from the date and time
	3. Saving and importing instrument settings	
Function	Various settings including the test conditions, etc. are saved as a settings file. The saved settings file is imported and the settings are restored.	
Save items	All setting items	
File name	Automatically generated from the date and time	

Protection function

Operations

The instrument enters the protection state, the output is shut down, and a test is stopped in the following cases. The relevant message is displayed on the screen.

Protection display	Description	Unlock method
POWER SUPPLY ERROR	An error in the power supply circuit has been detected.	Turn off the instrument.
FAN ERROR	A fan stop has been detected	Turn off the instrument.
LED ERROR	The DANGER lamp LED failure has been detected.	Turn off the instrument.
INTERLOCK STATE	Input of an interlock signal has been detected.	Short-circuit the interlock signal to ISO_COM and press the STOP button.
REMOTE CONNECTOR	Connection/disconnection of the external switch terminal has been detected	After checking the test condition, press the STOP button.
GROUND FAULT	The GFI function has been activated.	After checking the test condition, press the STOP button.
OVERLOAD	A current 1.5 to 3 times the maximum rated current has been detected.	After checking the test condition, press the STOP button.
SUPPLY VOLTAGE FREQ ERROR	The mains frequency is less than 45 Hz. Otherwise, it exceeds 65 Hz.	Turn off the instrument.
POWER TEMP ERROR	The temperature is abnormal.	Turn off the instrument.
SUPPLY VOLTAGE ERROR	The output of the power supply circuit dropped due to a momentary power failure or other cause.	Turn off the instrument.
HIGHLOAD POWER OUTAGE	Voltage continues to be generated in the state of a circuit error due to a momentary power loss or other cause.	Turn off the instrument.
OVERLOAD POWER OUTAGE	A relatively longer voltage dip occurs during voltage output when the load is large.	Turn off the instrument.
OUTPUT TIME LIMIT	The test time has exceeded the time rating.	<ul style="list-style-type: none"> • Press the STOP button. • Leave the instrument for 30 minutes.

-7. System settings

Interface settings		
USB	Terminator	CR + LF, CR, LF
	Default setting	CR + LF
LAN	IP address	Four three-digit numbers from 0 to 255 Default setting: 192.168.000.001
	Subnet mask	Four three-digit numbers from 0 to 255 Default setting: 255.255.255.000
	Default gateway	Four three-digit numbers from 0 to 255 Default setting: off
	Port	1 to 65535 Default setting: 6866
	Terminator	CR + LF, CR, LF Default setting: CR + LF
RS-232C	When the Z3001 RS-232C interface is used	
	Communication speed	9600 bps, 19200 bps, 38400 bps, 57600 bps Default setting: 9600 bps
	Flow control	Off, Software Default setting: off
	Terminator	CR + LF, CR, LF Default setting: CR + LF
GP-IB	When the Z3000 GP-IB interface is used	
	Addresses	01 to 30 Default setting: 01
	Terminator	CR+LF, CR, LF Default setting: LF
Instrument information	Serial number information	Displays the manufacturing serial number.
	Version information	Software version FPGA version display MAC address display
	MAC address	MAC address display
Self-check function	Panel test	The touch screen can be checked.
	Panel calibration	The touch screen position can be calibrated.
	Screen display test	The display status and LED on/off status are checked.
	ROM/RAM test	The instrument built-in memory (ROM, RAM) is checked.
	External I/O test	The external I/O input and output signals are checked.
Command monitor function	Operations	Displays the send and receive status of commands and queries
	Operation mode	Off, on
	Default setting	Off

14.4 Interface Specifications

USB (function)	Not available when a USB flash drive is used.	
	Connector	Type B receptacle
	Electrical specifications	USB2.0 (Full-Speed)
	Number of ports	1
	Class	CDC class (USB COM)
USB flash drive	Not available when the USB function is used.	
	Connector	Type A receptacle
	Electrical specifications	USB 2.0 (Full-Speed)
	Power supply	500 mA max.
	Number of ports	1
	Supported USB flash drives	USB Mass Storage Class compatible (VFAT not compatible)
	Function	Test data, copied screens, all data of measured value memory, and panel data can be saved.
	File operations	Settings can be saved, imported, and deleted, names can be changed, and the available space can be displayed.
LAN	Connector	RJ-45 connector
	Transmission method	10Base-T, 100Base-TX (automatic detection)
	Protocol	TCP/IP
RS-232C	Optional Z3001 used	
GP-IB	Optional Z3000 used	
External I/O	See "Electrical specifications" (p. 180) and "Instrument connector and compatible connectors" (p. 158).	
External switch	Operations	The instrument can be started and stopped remotely with the optional 9613 Remote Control Box (Single) or 9614 Remote Control Box (Dual) connected.
	Connector	Front panel 6-pin micro connector
	Input signal	START, STOP, SW_EN
	Output signal	Signal for lighting up the LED (maximum load current 40 mA)

14.5 Option Specifications

L2260 High Voltage Test Lead

General specifications

Operating environment	Indoor, pollution degree 2, altitude up to 2000 m (6562 ft.)
Operating temperature and humidity range	0°C to 40°C (32°F to 104°F), 80% RH or less (non-condensing)
Storage temperature and humidity range	-10°C to 50°C (14°F to 122°F), 80% RH or less (non-condensing)
Dimensions	Approx. 1500 mm (59.06", including connectors and clips)
Weight	Approx. 100 g (3.5 oz.)

Basic specifications

Maximum rated voltage	5000 V AC rms or 8000 V DC
Maximum rated voltage to earth (High-side [red] lead)	5000 V AC rms or 8000 V DC
Maximum rated current	1 A AC peak
Operation frequency range	DC to 1 kHz
Cable coating insulation resistance	1 TΩ/m or more
Max. number of clip opening and closing times (Reference value)	About 500,000 times (when opening and closing approx. 1/2 of the max. fully-open distance)

Supported equipment

Withstand insulation resistance tester	ST5680 DC Hipot Tester
---	------------------------

L2261 Unterminated Lead Cable

General specifications

Operating environment	Indoor, pollution degree 2, altitude up to 2000 m (6562 ft.)
Operating temperature and humidity range	0°C to 40°C (32°F to 104°F), 80% RH or less (non-condensing)
Storage temperature and humidity range	-10°C to 50°C (14°F to 122°F), 80% RH or less (non-condensing)
Dimensions	Approx. 5000 mm (196.85", including connectors and clips)
Weight	Approx. 220 g (7.8 oz.)

Basic specifications

Maximum rated voltage	5000 V AC rms or 8000 V DC
Maximum rated voltage to earth (High-side [red] lead)	5000 V AC rms or 8000 V DC
Maximum rated current	1 AAC peak
Operation frequency range	DC to 1 kHz
Cable coating insulation resistance	1 TΩ/m or more

Supported equipment

Withstand insulation resistance tester	ST5680 DC Hipot Tester
---	------------------------

15 Maintenance and Service

15.1 Troubleshooting

If damage is suspected, read “Frequently Asked Questions” (p. 221) to remedy the issue. If the issue cannot be resolved, contact your authorized Hioki distributor or reseller.

Frequently Asked Questions

General

Issue	Cause	Corrective action and reference page
Nothing is shown on the screen when the instrument is turned on.	The power cord is disconnected.	Check that the power cord is connected correctly. See “2.2 Connecting the Power Cord” (p. 24).
Keys are disabled.	The instrument is in the key-lock state.	Unlock the key lock. See “8.8 Key Lock” (p. 115).
	The communication interface is used and the instrument is in remote mode.	Set to local mode. See “13.8 Control Using Communications Commands” (p. 196).
When I pressed a key onscreen, a different key was operated.	Panel calibration has not been performed.	Implement panel calibration. See “Calibrating the touch screen” (p. 145).

Measurement issues

Issue	Cause	Corrective action and reference page
A test cannot start even when the START button is pressed.	The STOP button is not pressed before the START button is pressed.	Two-step operation using the STOP and START buttons is required to avoid unnecessary output and allow a test to be started safely. See “4.15 Starting and Ending a Test” (p. 58).
	A STOP signal is left to be input from the external I/O terminal.	A START signal has lower priority than a STOP signal. Change the setting so that the STOP signal is off at the start.
	The STOP button is stuck in the down position for some reason.	
	A voltage over the voltage limit value is set.	Check the test voltage and voltage limit value. A test cannot start if the test voltage is set outside the voltage limit value. See “4.3 Setting the Limit Voltage Value” (p. 40).

Communications

Issue	Cause	Corrective action and reference page
<p>Communications are disabled. (The [REMOTE] icon is not displayed.)</p>	<p>Communications have not been established.</p>	<p>Check that the connector connections are correct.</p>
		<p>Check that the interface settings are correct. See “Communications (USB, LAN, RS-232C, GP-IB)” (p. 183).</p>
		<p>USB: Install the driver on the control device. See “13.4 Connecting and Setting USB” (p. 189).</p>
		<p>RS-232C: Use a cross cable. Match the baud rate of the instrument and that of the control device. See “Communications (USB, LAN, RS-232C, GP-IB)” (p. 183).</p>
		<p>USB, RS-232C: Check the COM port number of the control device.</p>
<p>Communications are disabled. (The [REMOTE] icon is displayed.)</p>	<p>The communication settings are not correct.</p>	<p>If commands are not accepted, check the control software delimiters.</p>
		<p>GP-IB: Check the settings of the message terminators. Check that the address settings are correct. See “Communications (USB, LAN, RS-232C, GP-IB)” (p. 183).</p>
<p>A communication error occurred.</p>	<p>A command error has occurred (if commands are not matched).</p>	<ul style="list-style-type: none"> • Check the command spelling. Use $\times 20H$ for space characters. • Do not add a question mark (?) to commands that are not queries. • RS-232C: Match the baud rate of the instrument and that of the control device. See Communication Command Instruction Manual in the provided CD.
	<p>An execution error has occurred.</p>	<p>If command strings are correct, but unable to be implemented, try using modes that can implement each command. See Communication Command Instruction Manual in the provided CD.</p>
	<p>The send and receive command details are not correct.</p>	<p>Check the command send and receive details using the communication monitoring function.</p>

External control (EXT. I/O)

Issue	Cause	Corrective action and reference page
All operations are disabled.	Wiring is incorrect.	Check the external I/O. <ul style="list-style-type: none"> • Connector is disconnected • Pin number • ISO_COM terminal wiring • NPN/PNP settings • Contact (or open-collector) control (not voltage control) • Power supply to external device (Power supply to the instrument is not required) See “External Control (EXT. I/O)” (p. 155).
Deliberate movements are disabled.	The input-pin and output-pin connections do not match.	Test and check the input-pin and output-pin operations. See “I/O hander test” (p. 151).
	The I/O signal control timings do not match.	Check the I/O signal control timings using the timing charts. See “12.2 External Input and Output Terminals and Signals” (p. 158).

15.2 Repairs, Inspections, and Cleaning

Repairs and inspections

If damage is suspected, read “15.1 Troubleshooting” (p. 221) to remedy the issue. If the issue cannot be resolved, contact your authorized Hioki distributor or reseller.

In the following cases, stop using the instrument and disconnect the power cord before contacting your authorized Hioki distributor or reseller.

WARNING



- **Do not attempt to modify, disassemble, or repair the instrument yourself.**

The internal components of the instrument may carry high voltages. Attempting the above may cause bodily injury or fire.

CAUTION



- **If any protective function of the instrument is damaged, immediately make a repair request or dispose of the instrument.**

If you must store the instrument, label it as damaged.

Failure to do so could result in bodily injury.

IMPORTANT

Halt use in the event of the following.

- If the instrument is clearly damaged
- If measurement cannot be performed
- If the instrument has been stored for an extended period of time in an undesirable environment, for example under conditions of high temperature and humidity
- If the instrument has been subjected to stress due to shipment under harsh conditions
- If the instrument is wet or soiled with a large amount of oil or dust (If the instrument gets wet or oil and dust get inside it, internal insulation may deteriorate, posing a significant risk of electric shock or fire.)
- If the instrument is unable to save measurement conditions

Shipment

CAUTION

When shipping the instrument, make sure to observe the following items.



- **Remove the accessories and options from the instrument.**
- **Include details of the problem.**
- **Double-pack the instrument using the original packaging materials.**

Otherwise, the instrument could be damaged during transportation.

Cleaning

CAUTION

- **Periodically clean the vents to avoid blockage.**

When the vents become clogged, the internal cooling effect of the instrument is hampered, and this can lead to damage to the instrument.



- **If the instrument becomes dirty, wipe the instrument softly with a soft cloth moistened with water or a neutral detergent.**

Do not wipe the instrument strongly and never use solvents such as benzene, alcohol, acetone, ether, ketones, thinners, or gasoline. Failure to follow this instructions can deform and discolor the instrument.

Wipe the display gently with a soft, dry cloth.

Calibration

The calibration interval depends on factors such as the operating conditions and environment. Please determine the appropriate calibration interval based on your operating conditions and environment and have Hioki calibrate the instrument accordingly on a regular basis.

Replaceable parts and operating lifetimes

The characteristics of some of the parts used in the product may deteriorate with extended use. To ensure the product can be used over the long term, it is recommended to replace these parts on a periodic basis. When replacing parts, please contact your authorized Hioki distributor or reseller. The service life of parts varies with the operating environment and frequency of use. These parts are not guaranteed to operate throughout the period defined by the recommended replacement interval.

Part name	Recommended replacement period	Remarks and conditions
Electrolytic capacitor	Approx. 10 years	Requires replacement of the printed circuit boards on which such parts are mounted.
Liquid crystal backlight (brightness half-life)	Approx. 10 years	If using 24 hours a day

15.3 Error Display

When an error is displayed in the LCD display area, the instrument requires a check or repair. Please contact your authorized Hioki distributor or reseller.

Errors by the protection function

Error display	Description	Ext. I/O output	Solution
POWER SUPPLY ERROR	An error in the power supply circuit has been detected.	PROTECTION	The instrument is malfunctioning. Turn off the instrument and make a repair request.
FAN ERROR	A fan stop has been detected.	PROTECTION	Turn off the instrument immediately and check the instrument installation and fan condition. If the situation still does not improve, there is a risk of malfunction. Make a repair request.
LED ERROR	DANGER lamp LED failure has been detected.	PROTECTION	Turn off the instrument and make a repair request.
INTERLOCK STATE	Input of an interlock signal has been detected and the interlock has been activated.	PROTECTION	Release the interlock (p. 165).
REMOTE CONNECTOR	Connection/disconnection of the external switch terminal has been detected.	PROTECTION	Check the connection of the Remote Control Box and press the STOP button to clear the error.
GROUND FAULT	The GFI function has been activated (p. 112).	PROTECTION	Check the connection and safety of the test target.
OVERLOAD	A current three times the maximum rated current has been detected.	PROTECTION	Check the connection and the test target and press the STOP button to clear the error.
SUPPLY VOLTAGE FREQ ERROR	The main power frequency is outside the specifications.	PROTECTION	Check the power supply.
POWER TEMP ERROR	A temperature error in the power supply circuit has been detected.	PROTECTION	Turn off the instrument immediately and stop using the instrument. If the situation still does not improve, there is a risk of malfunction. Make a repair request.
SUPPLY VOLTAGE ERROR	The output voltage of the power supply circuit has dropped.	PROTECTION	Check for an instantaneous power outage with the power supply. Press the STOP button to clear the error.
HIGHLOAD POWER OUTAGE	A relatively longer voltage dip occurs during voltage output when the load is large.	PROTECTION	
OVERLOAD POWER OUTAGE		PROTECTION	
OUTPUT TIME LIMIT	The test time has exceeded the rated time.	PROTECTION	Perform a test in the protection time rating (p. 58). Press the STOP button to cancel.

Errors during measurement

Error Display	Description	Ext. I/O output	Solution
DISCHARGE TIMEOUT ERROR	Forced termination due to incomplete discharge	ERR	Check the safety and then check the test target, connection, and wiring.
CONTACT ERROR	Contact check error	CONT_ERR	Check the contact of the test target to the High Voltage Test Lead. (p. 105)
VOLTAGE ERROR	<ul style="list-style-type: none"> A voltage over the range specified in the output voltage monitoring function has been detected. Withstand voltage test: $\pm(5\%$ of setting +50 V) Insulation resistance test: $\pm(5\%$ of setting +10 V) The voltage deviates from the test voltage during the test and does not fall within ± 10 dgt of the set voltage within 5 seconds. 	ERR	Check the test target, connection, and wiring.
V CIRCUIT ERROR	An error in the voltage detection circuit power supply has been detected.	ERR	Turn off the instrument and make a repair request.

Error at the start of measurement

Error Display	Description	Ext. I/O output	Solution
DOUBLE ACTION	The instrument cannot start test because the double action function is activated.	–	Press the STOP button and then press the START button within approximately 0.5 second. (p. 59)
TIME SETTING ERROR	There is an error in the test time setting.	–	In the W-IR/IR-W test mode or program mode, the test time is set to [CONT] . Correct the setting.
JUDGE SETTING ERROR	There is an error in the test upper-limit or lower-limit setting (p. 43).	–	The test upper-limit and lower-limit values are reversed. Correct the setting. (p. 43, p. 44)
	The lower reference value falls out of the accuracy guarantee range.	–	Set the lower reference value within the accuracy guarantee range.
DELAY SETTING ERROR	There is an error in the judgment wait time (delay time) setting and/or the test time setting.	–	Set values so that the sum of the voltage rise time and test time is more than the delay time. (p. 48)
VOLTAGE LIMIT ERROR	There is an error in the limit voltage value setting (p. 40).	–	The limit voltage value is set less than the test voltage value. Correct the value so that the test voltage value is less than or equal to the limit voltage value. (p. 40)
POWER OVER ERROR	There is an error in the test voltage setting and/or the test upper-limit value setting.	–	The power value calculated from the test voltage and test upper-limit value is over the rated load capacity. Change the setting so that the product of the test voltage and the test upper-limit value is equal to or more than the rated load capacity (500 W).

CONTACT SETTING ERROR	There is an error in the setting for a contact check.	–	Set the voltage drop time setting to off. (p. 51)
	The compensation value of the contact check has not been acquired.		Execute an open compensation of the contact check. (p. 56)
	There is an error in the test voltage setting. (compensation execution screen only)		Set the test voltage to 100 V or more. (p. 39, p. 75)
HARDWARE ERROR	An error in the internal circuit has been detected.	–	The instrument is malfunctioning. Turn off the instrument and make a repair request.

Other errors

Error Display	Description	Ext. I/O output	Solution
PANEL LOAD FAILED	Panel load has failed.	–	Check the panels that have been saved.
ADJUST FAILED	Offset cancel (open compensation) has failed.	–	The current may be over the current range that can be compensated. Check the connection and execute the offset cancel again. (p. 57)
HARDWARE ERROR (at start up)	An error in the internal circuit has been detected.	–	The instrument is malfunctioning. Turn off the instrument and make a repair request.

15.4 Disposal of the Instrument (How to Remove the Lithium Battery)

The instrument has a built-in lithium battery for backup. When discarding the instrument, remove the lithium battery, and dispose according to local regulations.

Dispose of all optional accessories in accordance with applicable instructions.

WARNING



- **Before removing the lithium battery, turn off the instrument and remove the power cord and the cables from the test target.**

Failure to do so could cause the operator to experience an electric shock.

- **Do not short-circuit the battery.**

- **Do not charge the battery.**



- **Do not disassemble the battery.**

- **Do not throw the battery in the fire or heat the battery.**

Doing so can cause the battery to explode, resulting in bodily injury.



- **Keep the removed battery out of reach of children.**

CALIFORNIA, USA ONLY

Perchlorate Material - special handling may apply.

See www.dtsc.ca.gov/hazardouswaste/perchlorate

Required items:

Phillips screwdriver (No. 2), tweezers, nippers

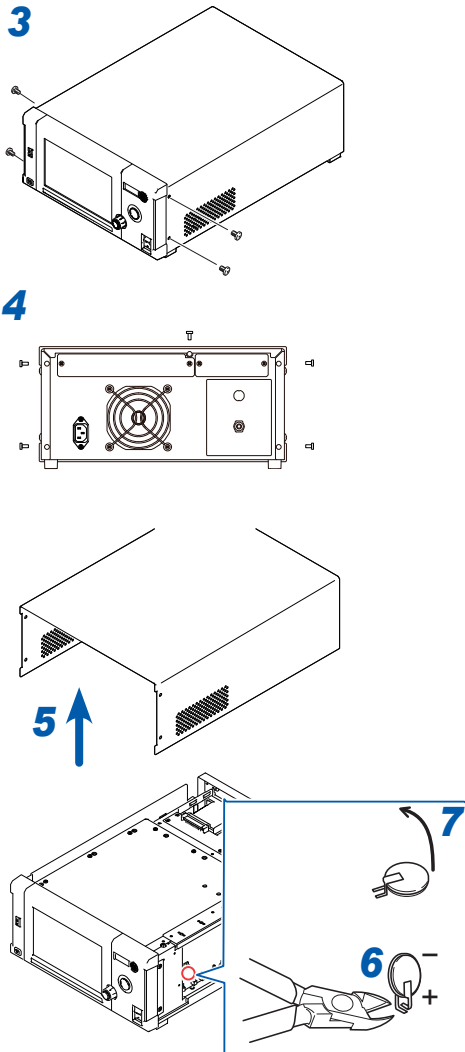

- 1** Turn off the instrument.
- 2** Unplug voltage cords, High Voltage Test Lead, and any other cords or cables.
- 3** Remove the four screws from both sides using a Phillips screwdriver.
- 4** Remove the five screws from the rear cover using a Phillips screwdriver.
- 5** Lift up on the back of the cover to remove it.
- 6** Sever the positive-pole terminal of the battery mounted to the internal plate using the nippers.
- 7** Lift up the battery using tweezers and use the nippers to sever the negative-pole terminal under the battery, and remove the battery.

16 Appendix

16.1 Internal Circuit Block Diagram

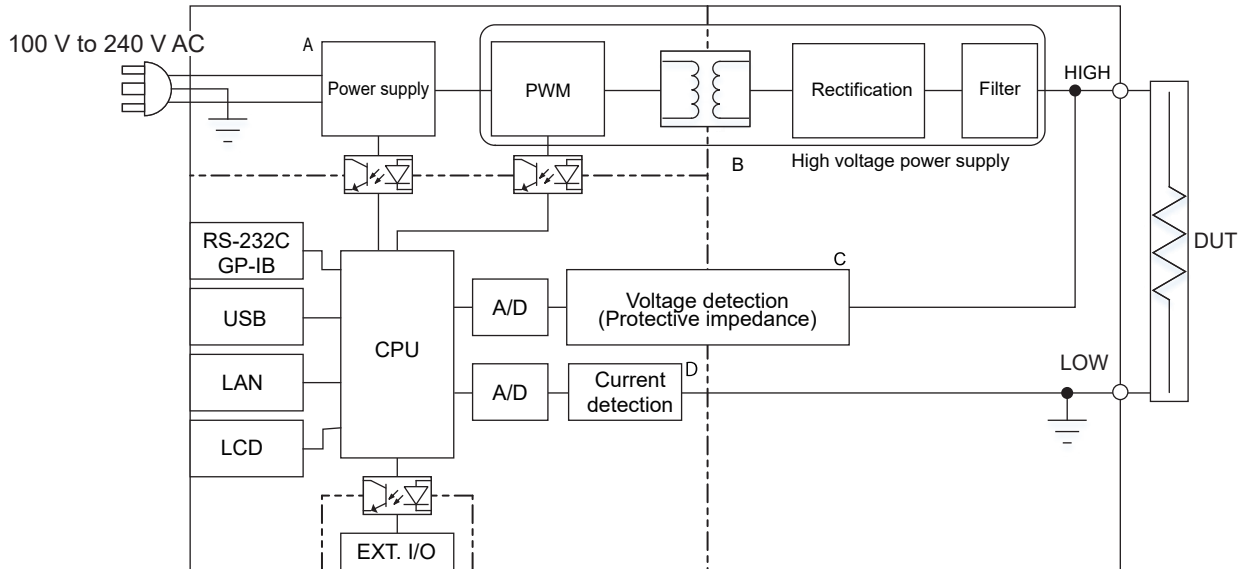

- A switching power supply with a wide input range between 100 V and 240 V is used for the power supply unit. This enables stable measurements even in environments where the power supply is unstable (A).
- Direct voltage from 10 V to 8 kV is output. Stable voltage can be output even if the test target contains capacitive components (B).
- A measurement signal is converted to a digital value by the high-speed and high-resolution A/D converter through the voltage and current detection circuit and stable measured values and waveform display that is very close to the actual waveform can be achieved (C, D).
- The voltage detection circuit also fulfills the role of protection impedance. To satisfy the IEC 61010 safety standard, the accessible parts (i.e., interface and case) and high-voltage circuits are isolated.

16.2 Table of Default Settings

		Display	Default setting
Test mode		MODE	W
Withstand voltage test	Interval time (W-IR and IR-W only)	W INTERVAL	0.1 s
	Test frequency	FREQ	DC
	Test voltage	TEST VOLT	0.100 kV
	Start voltage	START VOLT	0%
	Test time	TEST TIME	1.0 s
	Voltage rise time	RISE TIME	0.1 s
	Voltage drop time	FALL TIME	Off
	Judgment wait time	DELAY	Off
	Upper-limit reference value	UPPER LIMIT	0.011 mA
	Lower-limit reference value on/off	LOWER STATE	Off
	Lower-limit reference value	LOWER LIMIT	0.010 mA
	Arc detection function	ARC STATE	Off
	Test-voltage fluctuating rate of the arc detection function	ARC LIMIT	1%
	Offset cancel function	OFFSET CANCEL	Off
	Contact check threshold	C.CHECK THRESHOLD	1.0 nF
	Offset cancel current compensation value	OFFSET CURRENT	0.000 mA
Contact check compensation value	CAPACITANCE	0.0 nF	
Insulation resistance test	Interval time (W-IR and IR-W only)	IR INTERVAL	0.1 s
	Test voltage	TEST VOLT	100 V
	Test time	TEST TIME	1.0 s
	Voltage rise time	RISE TIME	0.1 s
	Voltage drop time	FALL TIME	Off
	Judgment wait time	DELAY	Off
	Upper-limit reference value on/off	UPPER STATE	Off
	Upper-limit reference value	UPPER LIMIT	100 MΩ
	Lower-limit reference value	LOWER LIMIT	1 MΩ
	Offset cancel function	OFFSET CANCEL	Off
	Contact check threshold	C.CHECK THRESHOLD	1.0 nF
	Offset cancel resistance compensation value	OFFSET RESISTANCE	0.000 Ω
	Contact check compensation value	CAPACITANCE	0.0 nF

		Display	Default setting
Program	Number of test steps	END STEP	50
	Step interval	INTERVAL	0.1 s
	Test mode	MODE	W
	Test frequency	FREQ	DC
	Test voltage	TEST VOLT	0.010 kV
	Start voltage	START VOLT	0%
	Test time	TEST TIME	1.0 s
	Voltage rise time	RISE TIME	0.1 s
	Voltage drop time	FALL TIME	Off
	Judgment wait time	DELAY	Off
	Upper-limit reference value	UPPER LIMIT	0.011 mA
	Lower-limit reference value on/off	LOWER STATE	Off
	Lower-limit reference value	LOWER LIMIT	0.010 mA
	Arc detection function	ARC STATE	Off
	Test-voltage fluctuating rate of the arc detection function	ARC LIMIT	1%
	Offset cancel function	OFFSET CANCEL	Off
	Contact check threshold	C.CHECK THRESHOLD	1.0 nF
	Offset cancel compensation value	CURR/RES	0.000 A
	Contact check compensation value	CAPACITANCE	0.0 nF
BDV measurement	Test method	MODE	RATE
	Test frequency	FREQ	DC
	Initial voltage	START VOLT	0.010 kV
	End voltage	END VOLT	5.000 kV
	Voltage rise speed	RISE RATE	500 V/s
	Arc detection function	ARC STATE	Off
	Test-voltage fluctuating rate of the arc detection function	ARC LIMIT	1%
	Distance between electrodes	DISTANCE	0.01 mm
	Upper-limit reference value	UPPER LIMIT	0.010 mA
	Number of tests	TEST COUNT	1
Common	DC withstand voltage test limit voltage	DCW	8.000 kV
	Insulation resistance test limit voltage	IR	2000 V
	Operations for fail judgment	W↔IR, PROG	STOP
	Insulation resistance test end mode	IR END	TIME
	Contact check function	STATE	Off
	Auto-range function in the DC withstand voltage test	W MODE	Off
	Auto-range function in the insulation resistance test	IR MODE	Off
Data display function during auto-range	KEEP DATA	Off	

Table of Default Settings

		Display	Default setting
System	GFI function	GFI	On
	Momentary out function	MOMENTARY	Off
	Key lock	KEY LOCK	Off
	Key lock passcode (1 to 4 characters)	PASS CODE	""
	Withstand voltage test judgment result output timing	JUDGE W	MEAS END
	Insulation resistance test judgment result output timing	JUDGE IR	MEAS END
	Test signal output	TEST SIGNAL	TEST
	Memory function	STATE	Off
	Buzzer volume for pass judgment	PASS VOL	3
	Buzzer volume for fail judgment	FAIL VOL	3
	Calibration expiration check function	CAL CHECK	On
	Calibration expiration date	CHECK DATE	22-03-30
	Clock	CLOCK	Current date and time
Screens	Display screen	DISP	NUM
	Display graph	GRAPH	TREND
	Display color for voltage waveforms	VOLTAGE	Yellow
	Display color for current waveforms	CURRENT	Red
	Display color for resistance waveforms	RESISTANCE	Light blue
Communication interface	USB function	MODE	COM
	USB message terminator	TERM	CRLF
	LAN IP address	IP	192.168.000.001
	LAN subnet mask	SUBNET MASK	255.255.255.000
	LAN gateway	GATEWAY	000.000.000.000
	LAN command port	PORT	6866
	LAN message terminator	TERM	CRLF
	RS-232C communication speed	SPEED	9600bps
	RS-232C handshake	HANDSHAKE	Off
	RS-232C message terminator	TERM	CRLF
	GP-IB address	ADDRESS	1
	GP-IB message terminator	TERM	LF
	Command compatibility mode	COMPATIBLE	Off
	Presence of a header for response messages	HEADER	Off
Command monitor	MONITOR	Off	

		Display	Default setting
File	How to save	DATA SAVE	QUICK
	Save binary format instantaneous waveform	BIN WAVE	Off
	Save binary format trend waveform	BIN TREND	Off
	Save screen	SCREEN	Off
	Save measurement result	SAVE	On
	Save test result when measurement results are saved	JUDGE	On
	Save instantaneous waveform when measurement results are saved	WAVE	Off
	Save trend waveform when measurement results are saved	TREND	Off
	Name of saved file	FILE NAME	""
	Saving destination folder	DIRECTORY	""
	Image format	TYPE&COLOR	BMP COLOR
	Item delineators	ITEM DELIM	,
	Date delineators	DATE DELIM	/
	Date format	DATE	YYYYMMDD
	Decimal point character	DECIM CHAR	.
	Quotation marks	QUOTE	"

16.3 Rackmount

Rackmount fittings or the like can be attached to this instrument after removing the screws from the bottom.

⚠ WARNING

- When the rackmount fittings are reattached after removal from the instrument, reuse the screws that were initially used (M3 × 6 mm for support feet).



If a fitting is attached with other screws, the instrument may be damaged, causing a risk of bodily injury. If you lose or damage the screws, contact your authorized Hioki distributor or reseller.

Rackmount fitting reference drawing and attachment procedure

Rackmount fitting (EIA)

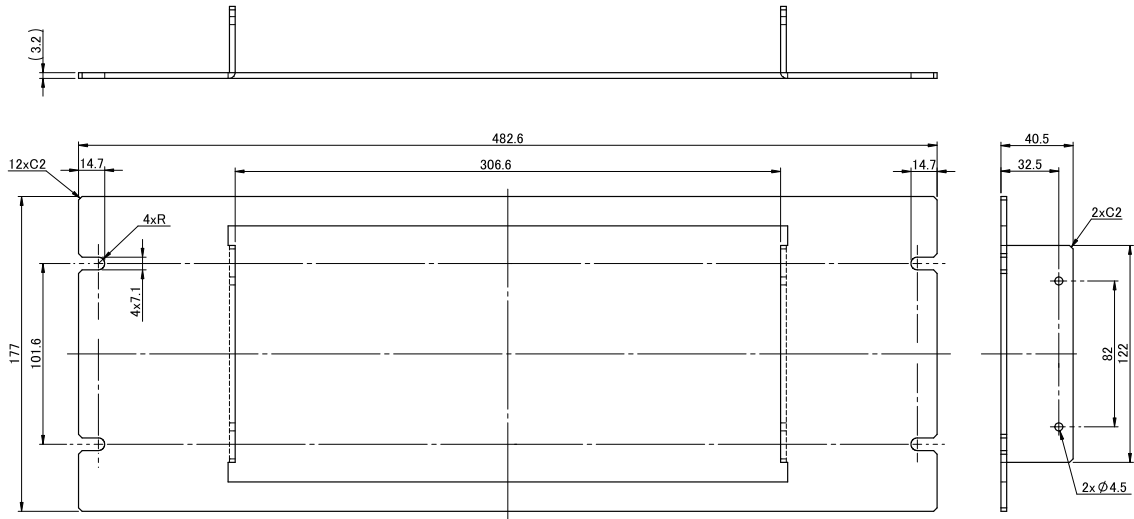

Rackmount fitting (JIS)

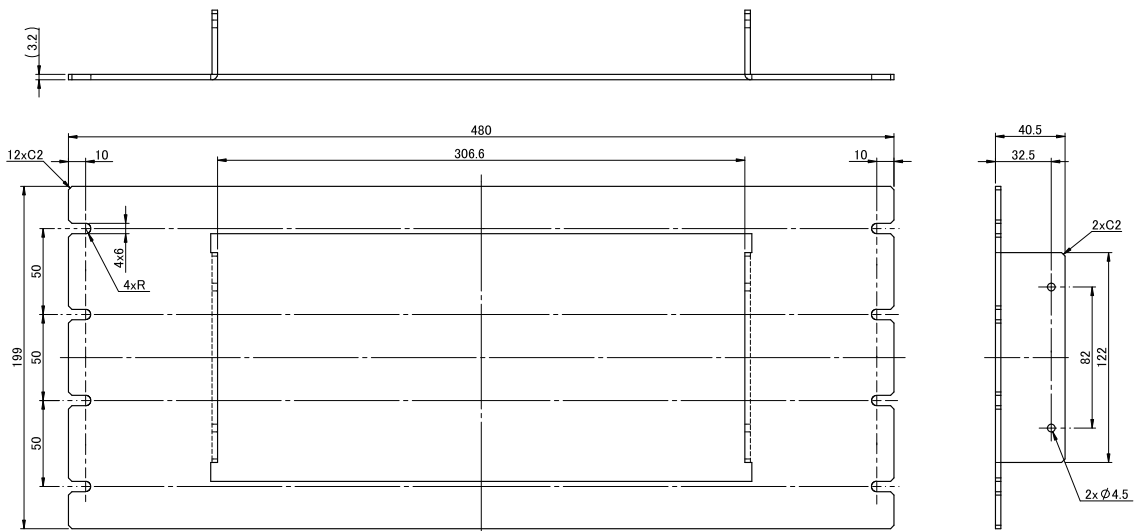

Spacer

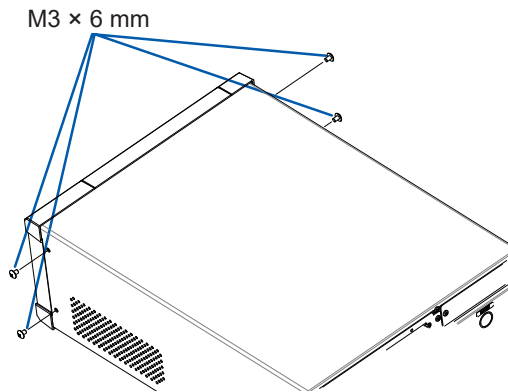
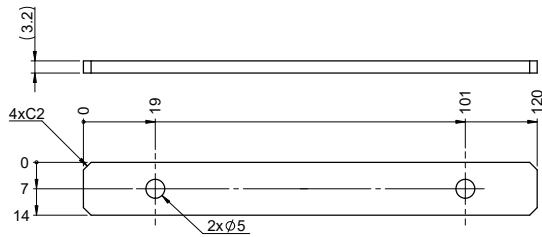

Rackmount fitting (JIS, EIA)

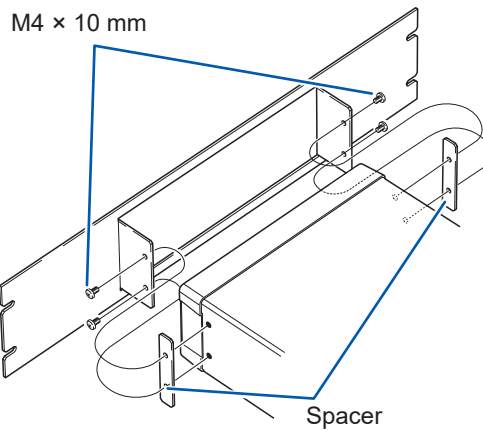

1 Remove the four screws on the side of the instrument.

Keep the removed screws not to lose them.

2 Attach the spacers to both sides of the instrument and secure the rackmount fitting using M4 x 10 mm screws.

IMPORTANT

- Support the instrument in the rack with commercially available support angles because the instrument is heavy.
- Install the instrument more than the specified distance from the surroundings to prevent it from rising in temperature.

Bottom surface: At least 15 mm (the height of the support legs) from the ground surface

Other than the bottom surface: 30 mm or more from the periphery

16.4 External View

Unit: mm

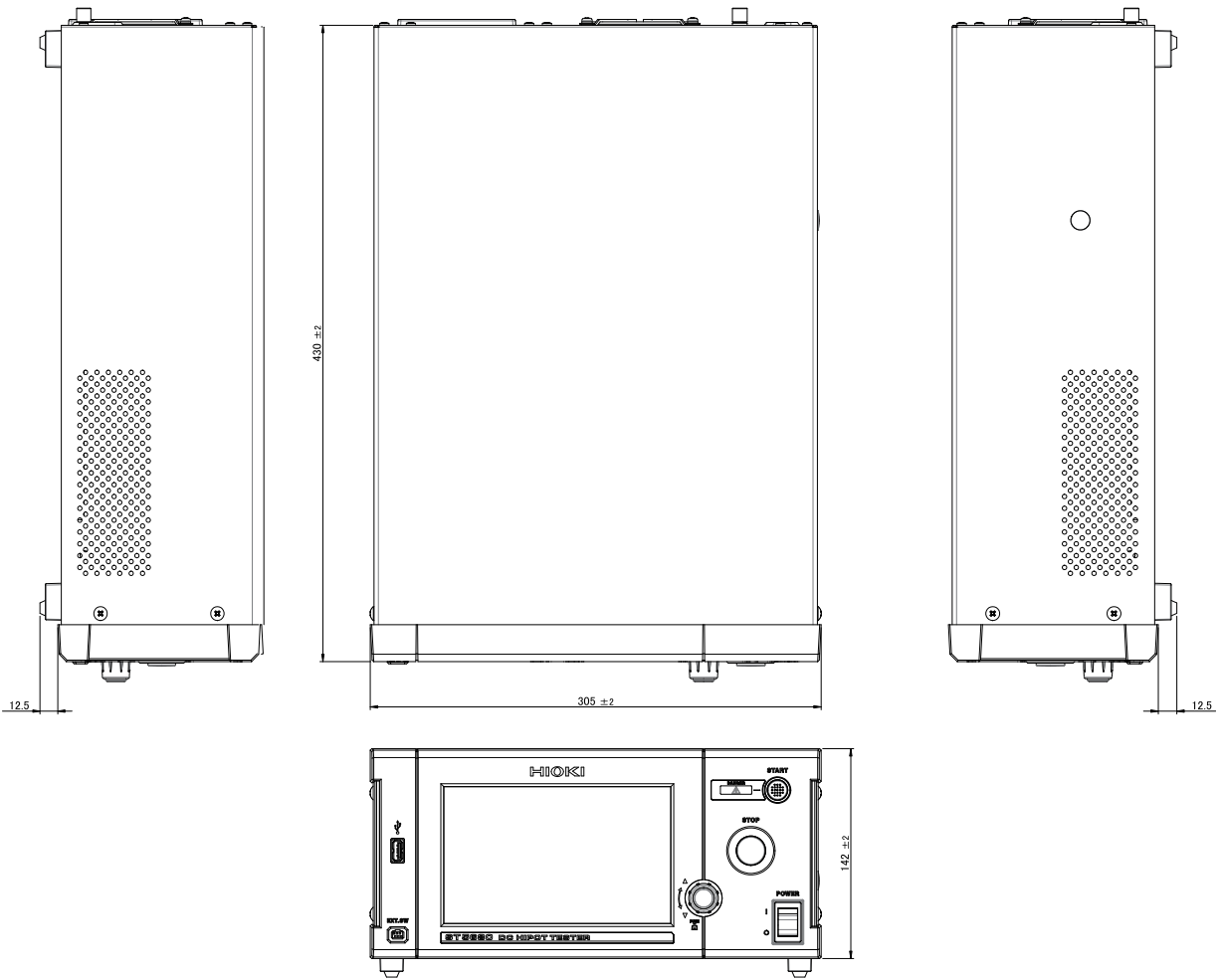

16.5 Remote Control Box (Option)

When the 9613 Remote Control Box (Single) or 9614 Remote Control Box (Dual) is connected to the instrument, a test can be started and stopped at hand. As you can start and stop a test without touching the instrument, the test can be performed more safely.

DANGER

- **Check the following before connecting the remote control to avoid electric shock accidents.**



1. Make sure that the instrument power switch is set to off (O).
2. The **DANGER** lamp is off.

- **Take safety measures so that the operator cannot touch the voltage output terminals, test lead, and test target when **TEST** is lit.**

The internal components of the instrument carry high voltages and may become very hot during operation. Touching them could cause burns or electric shock.

CAUTION



- **Do not remove the Remote Control Box after turning on the instrument.**
Failure to do so could damage the instrument or cause them to malfunction.



- **Be sure to turn off the instrument once when removing the Remote Control Box.**
Failure to do so could damage the instrument or cause them to malfunction.

9613 Remote Control Box (Single) and 9614 Remote Control Box (Dual) (option)

Parts names and functions

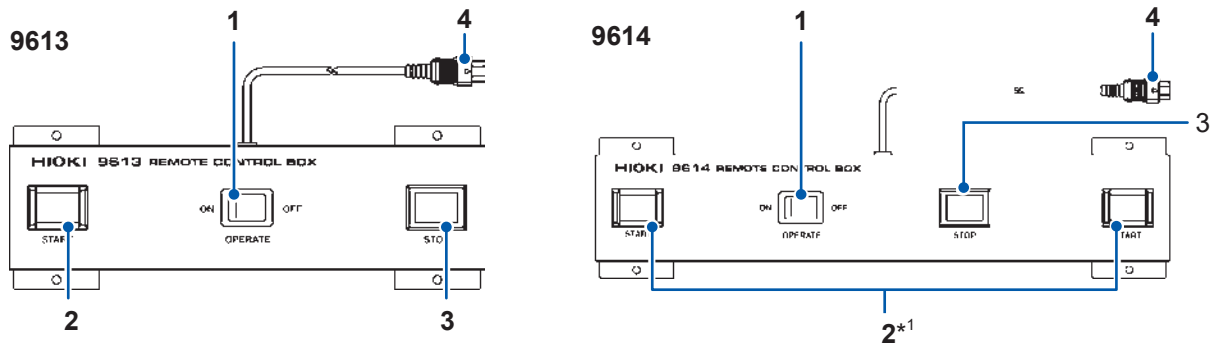

No.	Name	Function
1	OPERATE switch (OPERATE)	Enables the remote control. When this switch is set to on, the START switch and STOP switch of the remote control are enabled. When the setting is switched between on and off during a test, the test is forcefully terminated.
2	START switch	Starts the test. This switch has the same function as that of the START button on the instrument.
3	STOP switch	Stops the test This switch has the same function as that of the STOP button on the instrument. The STOP switch is lit during the test or voltage output.
4	Remote control connection plug	Connected to the external switch terminal on the instrument.



*1. The 9614 Remote Control Box (Dual) has two **START** switches. As you press the **START** switches with both hands to start a test, the test can be performed more safely.

Specifications

	9613	9614
Operating temperature and humidity range	0°C to 40°C (32°F to 104°F), 80% RH or less (non-condensing)	
Storage temperature and humidity range	-10°C to 50°C (14°F to 122°F), 90% RH or less (non-condensing)	
Operating environment	Indoors, altitude up to 2000 m (6562 ft.)	
Dimensions	Approx. 193W × 50H × 32D mm (7.60"W × 1.97"H × 1.26"D, excluding protruding parts)	Approx. 270W × 50H × 32D mm (10.63"W × 1.97"H × 1.26"D, excluding protruding parts)
Weight	Approx. 360 g (12.7 oz.)	Approx. 470 g (16.6 oz.)
Cord length	Approx. 1.5 m	

Connection method

- 1** Make sure that the instrument power switch and remote control OPERATE switch are set to Off.
- 2** Connect the remote control connection plug to the external switch terminal on the instrument.
- 3** Set the OPERATE switch on the remote control to on.
The setting can be changed between on and off after the instrument is turned on.

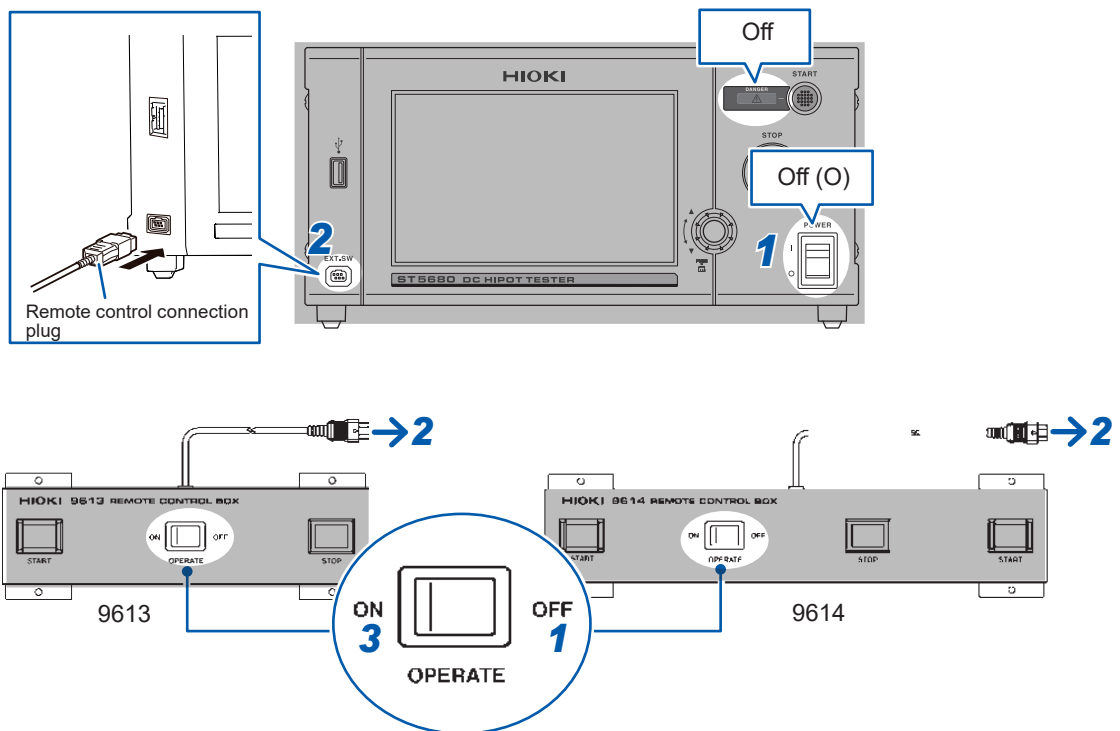

16.6 Timer Calibration

Calibration conditions

Ambient temperature and humidity	23°C ±5°C, 80% RH or less
Warm-up time	30 minutes or more
Power supply	100 V to 240 V 50 Hz or 60 Hz

Calibration equipment

Frequency counter	Keysight 53220A or equivalent
-------------------	-------------------------------

Connection

Use the TEST signal (19 pin) in the external I/O terminal.

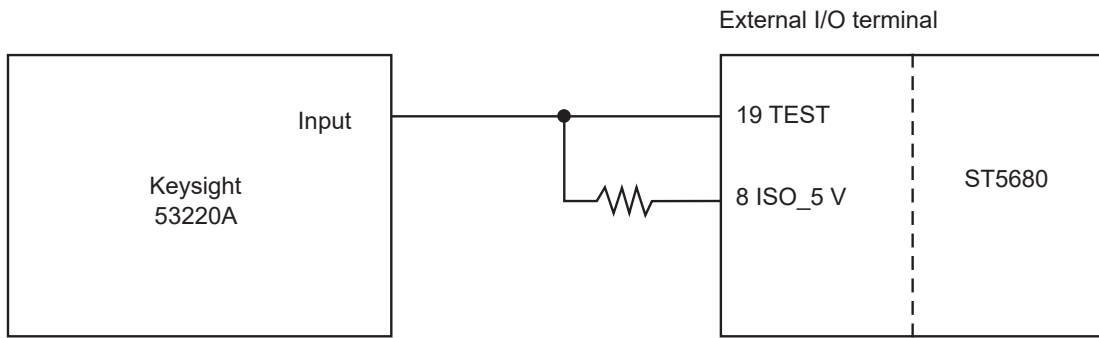

ST5680 settings

Test mode	DCW or IR
Test time	5.0 s
Output voltage	1.000 kV
Load not connected (open)	
TEST signal outputting timing	TEST (Output the signal during the test time)

See "Setting the test signal output timing" (p. 162)

Press the **START** button to start a test and measure the pulse width of the TEST signal.

17 License Information

This instrument uses the following open source software.

Amazon FreeRTOS

Copyright (C) 2020 Amazon.com, Inc. or its affiliates. All Rights Reserved.

Permission is hereby granted, free of charge, to any person obtaining a copy of this software and associated documentation files (the "Software"), to deal in the Software without restriction, including without limitation the rights to use, copy, modify, merge, publish, distribute, sublicense, and/or sell copies of the Software, and to permit persons to whom the Software is furnished to do so, subject to the following conditions:

The above copyright notice and this permission notice shall be included in all copies or substantial portions of the Software.

THE SOFTWARE IS PROVIDED "AS IS", WITHOUT WARRANTY OF ANY KIND, EXPRESS OR IMPLIED, INCLUDING BUT NOT LIMITED TO THE WARRANTIES OF MERCHANTABILITY, FITNESS FOR A PARTICULAR PURPOSE AND NONINFRINGEMENT. IN NO EVENT SHALL THE AUTHORS OR COPYRIGHT HOLDERS BE LIABLE FOR ANY CLAIM, DAMAGES OR OTHER LIABILITY, WHETHER IN AN ACTION OF CONTRACT, TORT OR OTHERWISE, ARISING FROM, OUT OF OR IN CONNECTION WITH THE SOFTWARE OR THE USE OR OTHER DEALINGS IN THE SOFTWARE.

lwlp

lwIP is licenced under the BSD license:

Copyright (c) 2001-2004 Swedish Institute of Computer Science.
All rights reserved.

Redistribution and use in source and binary forms, with or without modification, are permitted provided that the following conditions are met:

1. Redistributions of source code must retain the above copyright notice, this list of conditions and the following disclaimer.
2. Redistributions in binary form must reproduce the above copyright notice, this list of conditions and the following disclaimer in the documentation and/or other materials provided with the distribution.
3. The name of the author may not be used to endorse or promote products derived from this software without specific prior written permission.

THIS SOFTWARE IS PROVIDED BY THE AUTHOR ``AS IS AND ANY EXPRESS OR IMPLIED WARRANTIES, INCLUDING, BUT NOT LIMITED TO, THE IMPLIED WARRANTIES OF MERCHANTABILITY AND FITNESS FOR A PARTICULAR PURPOSE ARE DISCLAIMED. IN NO EVENT SHALL THE AUTHOR BE LIABLE FOR ANY DIRECT, INDIRECT, INCIDENTAL, SPECIAL, EXEMPLARY, OR CONSEQUENTIAL DAMAGES (INCLUDING, BUT NOT LIMITED TO, PROCUREMENT OF SUBSTITUTE GOODS OR SERVICES; LOSS OF USE, DATA, OR PROFITS; OR BUSINESS INTERRUPTION) HOWEVER CAUSED AND ON ANY THEORY OF LIABILITY, WHETHER IN CONTRACT, STRICT LIABILITY, OR TORT (INCLUDING NEGLIGENCE OR OTHERWISE) ARISING IN ANY WAY OUT OF THE USE OF THIS SOFTWARE, EVEN IF ADVISED OF THE POSSIBILITY OF SUCH DAMAGE

FreeType

Copyright (c) 2006-2018 The FreeTypeProject (www.freetype.org). All rights reserved.

The FreeType Project LICENSE
2006-Jan-27

Copyright 1996-2002, 2006 by
David Turner, Robert Wilhelm, and Werner Lemberg

Introduction
=====

The FreeType Project is distributed in several archive packages; some of them may contain, in addition to the FreeType font engine, various tools and contributions which rely on, or relate to, the FreeType Project.

This license applies to all files found in such packages, and which do not fall under their own explicit license. The license affects thus the FreeType font engine, the test programs, documentation and makefiles, at the very least.

This license was inspired by the BSD, Artistic, and IJG (Independent JPEG Group) licenses, which all encourage inclusion and use of free software in commercial and freeware products alike. As a consequence, its main points are that:

- We don't promise that this software works. However, we will be interested in any kind of bug reports. ('as is' distribution)

- You can use this software for whatever you want, in parts or full form, without having to pay us. ('royalty-free' usage)
- You may not pretend that you wrote this software. If you use it, or only parts of it, in a program, you must acknowledge somewhere in your documentation that you have used the FreeType code. ('credits')

We specifically permit and encourage the inclusion of this software, with or without modifications, in commercial products.

We disclaim all warranties covering The FreeType Project and assume no liability related to The FreeType Project.

Finally, many people asked us for a preferred form for a credit/disclaimer to use in compliance with this license. We thus encourage you to use the following text:

```

""
Portions of this software are copyright (c) <year> The FreeType
Project (www.freetype.org). All rights reserved.
""

```

Please replace <year> with the value from the FreeType version you actually use.

Legal Terms

=====

0. Definitions

Throughout this license, the terms 'package', 'FreeType Project', and 'FreeType archive' refer to the set of files originally distributed by the authors (David Turner, Robert Wilhelm, and Werner Lemberg) as the 'FreeType Project', be they named as alpha, beta or final release.

'You' refers to the licensee, or person using the project, where 'using' is a generic term including compiling the project's source code as well as linking it to form a 'program' or 'executable'. This program is referred to as 'a program using the FreeType engine'.

This license applies to all files distributed in the original FreeType Project, including all source code, binaries and documentation, unless otherwise stated in the file in its original, unmodified form as distributed in the original archive.

If you are unsure whether or not a particular file is covered by this license, you must contact us to verify this.

The FreeType Project is copyright (C) 1996-2000 by David Turner, Robert Wilhelm, and Werner Lemberg. All rights reserved except as specified below.

1. No Warranty

THE FREETYPE PROJECT IS PROVIDED `AS IS' WITHOUT WARRANTY OF ANY KIND, EITHER EXPRESS OR IMPLIED, INCLUDING, BUT NOT LIMITED TO, WARRANTIES OF MERCHANTABILITY AND FITNESS FOR A PARTICULAR PURPOSE. IN NO EVENT WILL ANY OF THE AUTHORS OR COPYRIGHT HOLDERS BE LIABLE FOR ANY DAMAGES CAUSED BY THE USE OR THE INABILITY TO USE, OF THE FREETYPE PROJECT.

2. Redistribution

This license grants a worldwide, royalty-free, perpetual and irrevocable right and license to use, execute, perform, compile, display, copy, create derivative works of, distribute and sublicense the FreeType Project (in both source and object code forms) and derivative works thereof for any purpose; and to authorize others to exercise some or all of the rights granted herein, subject to the following conditions:

- Redistribution of source code must retain this license file (`FTL.TXT') unaltered; any additions, deletions or changes to the original files must be clearly indicated in accompanying documentation. The copyright notices of the unaltered, original files must be preserved in all copies of source files.
- Redistribution in binary form must provide a disclaimer that states that the software is based in part of the work of the FreeType Team, in the distribution documentation. We also encourage you to put an URL to the FreeType web page in your documentation, though this isn't mandatory.

These conditions apply to any software derived from or based on the FreeType Project, not just the unmodified files. If you use our work, you must acknowledge us. However, no fee need be paid to us.

3. Advertising

Neither the FreeType authors and contributors nor you shall use the name of the other for commercial, advertising, or promotional purposes without specific prior written permission.

We suggest, but do not require, that you use one or more of the following phrases to refer to this software in your documentation or advertising materials: `FreeType Project', `FreeType Engine', `FreeType library', or `FreeType Distribution'.

As you have not signed this license, you are not required to accept it. However, as the FreeType Project is copyrighted material, only this license, or another one contracted with the authors, grants you the right to use, distribute, and modify it.

Therefore, by using, distributing, or modifying the FreeType Project, you indicate that you understand and accept all the terms of this license.

4. Contacts

There are two mailing lists related to FreeType:

freetype@nongnu.org

Discusses general use and applications of FreeType, as well as future and wanted additions to the library and distribution.

If you are looking for support, start in this list if you haven't found anything to help you in the documentation.

freetype-devel@nongnu.org

Discusses bugs, as well as engine internals, design issues, specific licenses, porting, etc.

Our home page can be found at

<https://www.freetype.org>

Google Noto Fonts

Copyright 2014, 2015 Adobe Systems Incorporated (<http://www.adobe.com/>).

Noto is a trademark of Google Inc.

This Font Software is licensed under the SIL Open Font License, Version 1.1.

This license is copied below, and is also available with a FAQ at:

<http://scripts.sil.org/OFL>

SIL OPEN FONT LICENSE Version 1.1 - 26 February 2007

PREAMBLE

The goals of the Open Font License (OFL) are to stimulate worldwide development of collaborative font projects, to support the font creation efforts of academic and linguistic communities, and to provide a free and open framework in which fonts may be shared and improved in partnership with others.

The OFL allows the licensed fonts to be used, studied, modified and redistributed freely as long as they are not sold by themselves. The fonts, including any derivative works, can be bundled, embedded, redistributed and/or sold with any software provided that any reserved

names are not used by derivative works. The fonts and derivatives, however, cannot be released under any other type of license. The requirement for fonts to remain under this license does not apply to any document created using the fonts or their derivatives.

DEFINITIONS

“Font Software” refers to the set of files released by the Copyright Holder(s) under this license and clearly marked as such. This may include source files, build scripts and documentation.

“Reserved Font Name” refers to any names specified as such after the copyright statement(s).

“Original Version” refers to the collection of Font Software components as distributed by the Copyright Holder(s).

“Modified Version” refers to any derivative made by adding to, deleting, or substituting -- in part or in whole -- any of the components of the Original Version, by changing formats or by porting the Font Software to a new environment.

“Author” refers to any designer, engineer, programmer, technical writer or other person who contributed to the Font Software.

PERMISSION & CONDITIONS

Permission is hereby granted, free of charge, to any person obtaining a copy of the Font Software, to use, study, copy, merge, embed, modify, redistribute, and sell modified and unmodified copies of the Font Software, subject to the following conditions:

- 1) Neither the Font Software nor any of its individual components, in Original or Modified Versions, may be sold by itself.
- 2) Original or Modified Versions of the Font Software may be bundled, redistributed and/or sold with any software, provided that each copy contains the above copyright notice and this license. These can be included either as stand-alone text files, human-readable headers or in the appropriate machine-readable metadata fields within text or binary files as long as those fields can be easily viewed by the user.
- 3) No Modified Version of the Font Software may use the Reserved Font Name(s) unless explicit written permission is granted by the corresponding Copyright Holder. This restriction only applies to the primary font name as presented to the users.
- 4) The name(s) of the Copyright Holder(s) or the Author(s) of the Font Software shall not be used to promote, endorse or advertise any Modified Version, except to acknowledge the contribution(s) of the Copyright Holder(s) and the Author(s) or with their explicit written permission.
- 5) The Font Software, modified or unmodified, in part or in whole, must be distributed entirely under this license, and must not be distributed under any other license. The requirement for fonts to remain under this license does not apply to any document created using the Font Software.

TERMINATION

This license becomes null and void if any of the above conditions are not met.

DISCLAIMER

THE FONT SOFTWARE IS PROVIDED “AS IS”, WITHOUT WARRANTY OF ANY KIND, EXPRESS OR IMPLIED, INCLUDING BUT NOT LIMITED TO ANY WARRANTIES OF MERCHANTABILITY, FITNESS FOR A PARTICULAR PURPOSE AND NONINFRINGEMENT OF COPYRIGHT, PATENT, TRADEMARK, OR OTHER RIGHT. IN NO EVENT SHALL THE COPYRIGHT HOLDER BE LIABLE FOR ANY CLAIM, DAMAGES OR OTHER LIABILITY, INCLUDING ANY GENERAL, SPECIAL, INDIRECT, INCIDENTAL, OR CONSEQUENTIAL DAMAGES, WHETHER IN AN ACTION OF CONTRACT, TORT OR OTHERWISE, ARISING FROM, OUT OF THE USE OR INABILITY TO USE THE FONT SOFTWARE OR FROM OTHER DEALINGS IN THE FONT SOFTWARE.

Index

A

Automatic discharge function	66
Auto-range function	46
Data display function setting	46

B

BDV	85
Blank panel	187
Buzzer	113

C

Calibration expiration check function	153
Cleaning	224
Command	196
Command compatibility function	197
Command header function	198
Command monitor function	199
Contact check	105
Continuous voltage rise test	88

D

Data memory function	109
Delay time	52
Dielectric breakdown voltage measurement mode	85
Disposal	229

E

External control	155
EXT. I/O	155

G

GFI function	112
GP-IB	188, 195
Gradual voltage rise test	94

H

High Voltage Test Lead	26
Hub	190

I

Insulation resistance test end mode	108
Interface	188
Interlock function	165
Internal circuit configuration	179
IR-W test mode	67

J

Judgment lower-limit value	44
Judgment upper-limit value	43
Judgment wait time	52

K

Key lock	115
----------------	-----

L

LAN	188, 190
Limit voltage value	40

M

Momentary out	114
---------------------	-----

N

Network	190
---------------	-----

O

Offset cancel	56
Open compensation	56
Options	9

P

Panel memory function	119
Pass/fail judgment	64, 71, 81
Power cord	24
Program mode	73

R

Rackmount	236
Remote Control Box	239
RS-232C	188, 193

S

Screen operation	35
Self-test function	144
Specifications	201
Start voltage	42

T

TCP/IP	191
Test conditions	37
Test mode	36

Test voltage 39
Timer calibration 242
Timing chart..... 166
Turning on/off the instrument..... 25

U

USB 123, 188, 189

W

W-IR test mode..... 67

HIOKI
www.hioki.com/



**All regional
contact
information**

HEADQUARTERS

81 Koizumi
Ueda, Nagano 386-1192 Japan

HIOKI EUROPE GmbH

Helfmann-Park 2
65760 Eschborn, Germany
hioki@hioki.eu

2111 EN

Edited and published by HIOKI E.E. CORPORATION

Printed in Japan

- CE declarations of conformity can be downloaded from our website.
- Contents subject to change without notice.
- This document contains copyrighted content.
- It is prohibited to copy, reproduce, or modify the content of this document without permission.
- Company names, product names, etc. mentioned in this document are trademarks or registered trademarks of their respective companies.