

# GL1425C



[spectraprecision.com](http://spectraprecision.com)

**User Guide**  
**Bedienungsanleitung**  
**Manuel de l'utilisateur**  
**Guida per l'uso**



GL1425C

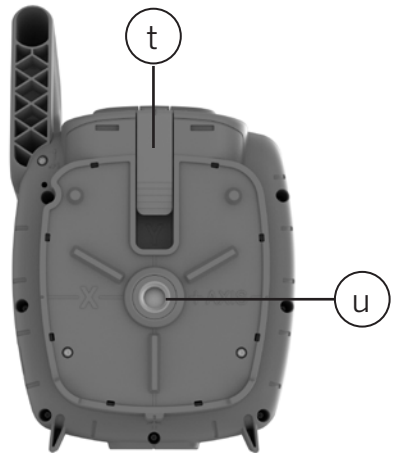
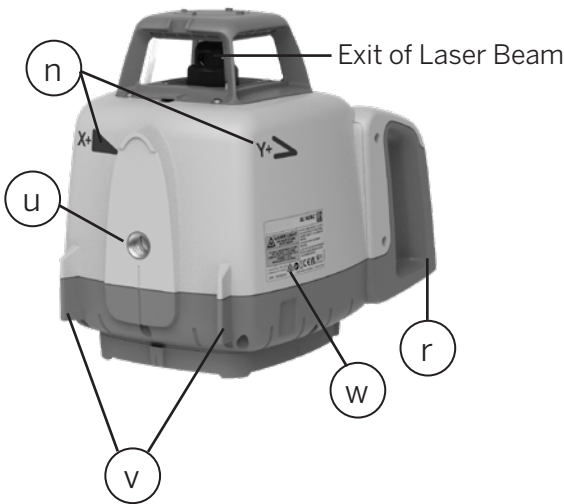
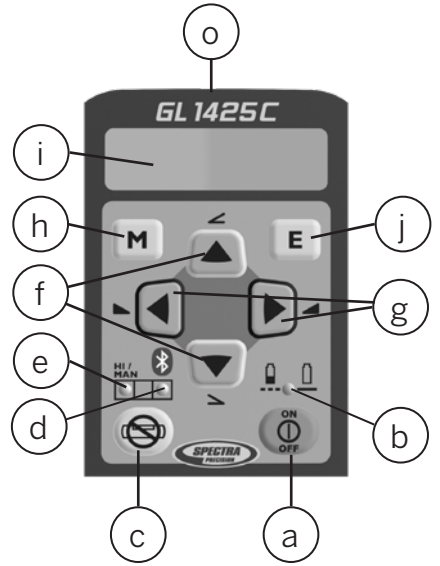
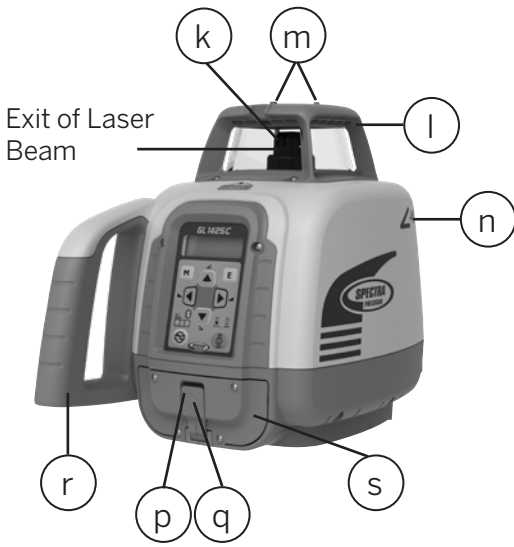

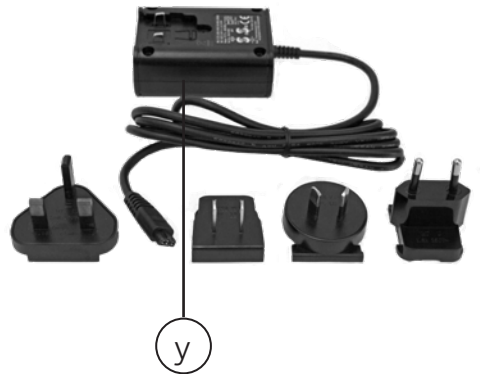
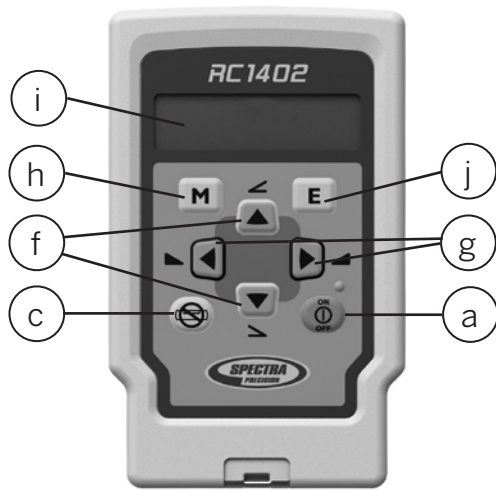

This page intentionally left blank.

# Contents

1	Introduction.....	7
2	Safety Instructions.....	7
3	Product .....	8
3.1	General description.....	8
3.2	Product Components.....	8
3.3	RC1402 Remote Control .....	9
3.4	Batteries .....	9
3.4.1	Installing batteries.....	9
3.4.2	Battery indication.....	10
3.4.3	Recharging the batteries .....	10
3.4.4	LED indication on the charger .....	10
4	Laser Setup.....	11
5	Turn On/Off the laser .....	11
6	Menu Navigation .....	12
7	Bluetooth® Connectivity.....	13
8	Horizontal automatic, self-leveling mode.....	13
9	Horizontal manual mode .....	14
10	Grade.....	14
10.1	Grade Input.....	14
10.2	Grade value from +/- 9% to +/- 15%; laser pre-tilt is needed.....	16
11	Rotation Speed.....	16
12	Mask Mode .....	16
13	Temperature Reference Check.....	17
14	Standby Mode .....	18
15	GradeMatch (Y-Axis).....	18
16	PlaneLok .....	19
17	Settings.....	22
17.1	Pairing .....	21
17.1.1	Bluetooth .....	21
17.1.2	Radio .....	22
17.2	Shock Warning (HI-alert).....	22
17.3	Grade Display .....	23
17.4	Start Grade .....	23
17.5	Backlight .....	23
17.6	Sensitivity .....	24
17.7	Language .....	24
17.8	Radio Channel .....	24

18	Info .....	25
19	Determining the Height of Instrument (HI) .....	26
20	Vertical Application.....	27
20.1	Vertical Automatic Mode.....	27
20.1.1	Laser Line Position .....	27
20.1.2	Line Scan.....	27
20.1.3	PlaneLok in Vertical .....	28
20.2	Vertical Manual mode.....	28
21	Use Receiver .....	28
21.1	Pair the laser with HL760 receiver .....	28
21.2	Pair the laser with CR700 .....	29
22	Remote Control RC1402 .....	30
22.1	Powering the RC1402 .....	30
22.2	Turning On/Off the radio remote control RC1402.....	30
22.3	Pairing the remote control RC1402 with the laser .....	30
22.4	RC1402 Menu Navigation.....	31
22.5	RC1402 LCD Display.....	31
23	Troubleshooting .....	31
24	Check Calibration .....	33
24.1	Checking calibration of the Y- and X-Axis .....	33
24.2	Checking calibration of the Z-Axis (vertical).....	33
25	Service.....	33
25.1	Technician Menu.....	34
26	Protect the unit .....	34
27	Cleaning and maintenance .....	34
28	Protecting the environment.....	34
29	Warranty.....	35
30	Technical Specification .....	36
30.1	Technical Specification Laser GL1425C.....	36
30.2	Technical Specification Laser Remote RC1402.....	36
31	Declaration of Conformity.....	37
32	UKCA .....	37
33	Electro-Magnetic Compatibility.....	37

# 1 Introduction

Thank you for choosing the GL1425C dual grade laser from the family of Spectra Precision professional lasers. The GL1425C is an easy-to-use self-leveling laser that offers accurate horizontal, grade and vertical laser reference using a receiver.

# 2 Safety Instructions

For hazardless and safe operation, read all the user guide instructions.

- Use of this product by people other than those trained on this product may result in exposure to hazardous laser light.
- The users of this product ensure they have read and understand the user guide.
- Do not remove warning labels from the unit.
- The GL1425C is a class 2 laser (IEC 60825-1:2014).

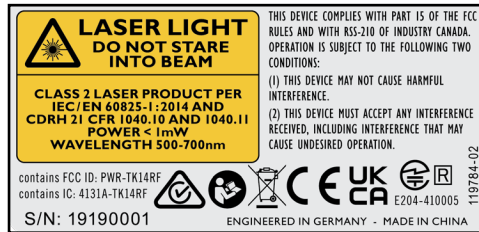

- Never look into the laser beam or direct it to the eyes of other people.
- Always operate the unit in a way that prevents the beam from getting into people's eyes. Watch for reflections from surfaces like windows or flat metal surfaces.
- If initial service is required, which results in the removal of the outer protective cover, removal must only be performed by factory-trained personnel.
- Do not use the product in aggressive or explosive environment.
- There is a risk of electrocution when using leveling rods and poles near electrical installations such as power cables.
- Ensure the product is not damaged so that any unsafe usage can happen.
- Before starting your work, always check the leveling accuracy of the product (see chapter 24).
- Spectra Precision LLC is not responsible for any inaccuracy that is caused by not reading the user guide and by any misuse of the product.
- The user of the product is responsible to check the result for the measurement.
- Never put a wet laser or wet accessories in the carrying case for storage.

**Caution:** Use of other than the described user and calibration tools or other procedures may result in exposure to hazardous laser light.

**Caution:** Using the laser different than described in the GL1425C user guide may result in unsafe operation.

**Note:** Any local or national laws and regulations for the use of machines or products described in this document have to be followed.

**Note:** Reflections from some surfaces like windows or flat metal surfaces can lead to wrong receiver readings.

**Note:** After storage or transportation let the product acclimate to the ambient temperature before use of high accurate measurements.

**Warning:** NiMH batteries or alkaline batteries shipped with the product may contain small amounts of harmful substances.

Do not open the battery, dispose of in fire or short circuit; it may ignite, explode, leak or get hot causing personal injury.

Dispose in accordance with all applicable federal, state and local regulations.

Keep the batteries away from children, If swallowed, do not induce vomiting.

Seek medical attention immediately.

Charge only with specified chargers according to device manufacturer's instructions.

Charge the batteries only within the specific temperature range (see chapter 30.1)

Be sure to charge the battery before using it for the first time and after not using it for an extended length of time.

Do not open the rechargeable batteries cage.

## 3 Product

### 3.1 General description

The laser ships with a rechargeable NiMH battery pack. Alkaline batteries can be used as a backup to power the laser on the jobsite.

The rechargeable NiMH battery pack can only be inserted one way and can be charged inside or outside the unit.

**Note:** Charging the rechargeable NiMH battery pack beyond the temperature mentioned in the technical specifications may lead to decreased battery lifetime or undercharged batteries.

### 3.2 Product Components GL1425C Laser

a	Power Button	Press for one second to turn on; press and hold for 2 seconds to turn off
b	Battery LED	Indicates battery charge status
c	Manual/Standby Button	Quickly press and release activates/deactivates the manual mode
d	Leveling/Bluetooth® LED	Indicates the automatic level status of the Laser as well as Bluetooth® connection; in standard mode the LED color is green; in Bluetooth® advertising or connection mode the color is blue
e	Manual/Hi-Warning LED	Indicates the manual level status or a HI alarm of the laser
f	Up and Down Arrow Buttons	
g	Left and Right Arrow Buttons	
h	M – Menu Button	Quickly press and release enters the Menu and returns to the previous menu
i	LCD	
j	E – Enter Button	Quickly press and release enters the sub-menu or starts the selected mode



k	Rotorhead	
l	Sunshade	
m	Sighting Guides	
n	Slope Indication Marks	
o	Laser Keypad	
p	Recharge Port	
q	Recharge Cover	
r	Handle	
s	Battery Door	
t	Battery Door Latch	
u	Tripod Mounts 5/8x11	
v	Stands	Support for vertical setup
w	Serial Number/Laser Safety Label	
x	Rechargeable Battery Pack	B10
y	Universal Charger	CH10

### 3.3 RC1402 Remote Control

The remote control offers the same functions as the GL1425C keypad.

a	Power Button	Press for one second to turn on; press and hold for two seconds to turn off
b	Battery LED	Shows the amount of battery charge
c	Manual Button	Quickly press and release activates/deactivates the manual mode/single axis slope mode
f	Up and Down Arrow Buttons	
g	Left and Right Arrow Buttons	
h	M – Menu Button	Quickly press and release enters the Menu and can be used to return to previous menu position
j	E – Enter Button	Quickly press and release starts the selected mode

### 3.4 Batteries

#### 3.4.1 Installing batteries

Open the battery door. Insert the rechargeable battery pack or alkaline batteries into the housing. If using alkaline, install per the “+” and “-” symbols noted in the battery compartment.

**Note:** DO NOT REMOVE RECHARGEABLE BATTERIES FROM THEIR CAGE AND INSTALL ALKALINE BATTERIES. SEVERE DAMAGE TO THE UNIT WILL RESULT IF CHARGING IS ATTEMPTED.

Close the battery door.



### 3.4.2 Battery indication

WHY: Displays the battery status prior to starting work on the job site.

WHAT: The battery indication shows the remaining battery capacity for the rechargeable or alkaline batteries. Actual capacity depends on battery brand, environmental factors, age, and recharge cycles.

HOW: When the laser battery LED (b) is off, the battery capacity is good. Blinking once every second indicates the batteries are weak and remaining operating time is limited. The batteries should be charged. A permanently on LED indicates the batteries are empty and remaining battery capacity of 5 minutes. Times may vary depending on environmental factors.

On the RC1402 or on the laser on the standard display press the E button (j). The battery symbol will appear and is shown on the screen for app. 5 seconds. The symbol represents relative battery capacity: Empty, almost empty, good, and full. (pic 1)

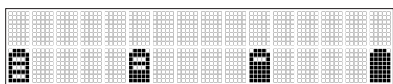

Pic 1: battery symbols

### 3.4.3 Recharging the batteries

It typically requires less than ten hours to fully charge empty rechargeable batteries. For charging, connect the plug of the charger to the recharge jack of the battery pack. Plug the charger into the appropriate outlet. The battery pack can be charged in or out of the laser.

New or long-time out-of-use rechargeable batteries reach their best performance after being charged and recharged five times. For indoor applications, the charger can be used as a power supply for the laser.

### 3.4.4 LED indication on the charger

Green LED flashes: charging in progress

Green LED permanently on: charging has stopped

Red LED permanently on: Error (batteries too cold or too warm, battery failure etc.)

**Note:** The batteries should only be charged when the temperature is between 41°F and 104°F (5°C to 40°C). Charging at temperature other than specified may give an error indication.

**Note:** The charger has a security timer. The maximum charging time is twelve hours. After twelve hours, the charger will always stop the charging process, independently from the charging status of the batteries.

**Note:** The batteries can be charged during use.

## 4 Laser Setup

Position the laser horizontally or vertically on a stable platform, wall mount or tripod at the desired elevation. The laser automatically recognizes the horizontal or vertical orientation when switched on.

Position the laser within its self-leveling range (see chapter 30.1). When the laser is not positioned within the self-leveling range, the manual and leveling indicator LEDs (d and e) flash simultaneously and a warning sound is emitted. Take the appropriate action to set up the laser within the self-leveling range.

## 5 Turn On/Off the laser

Turn on the laser pressing the power button (a) for one second. The LEDs (b, d and e) illuminate for one second. The LCD shows 'Initialization' (pic 2) and then for one second the 'model number' (pic 3)

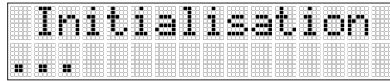

Pic 2 Initialization

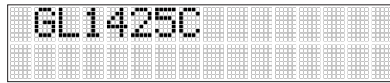

Pic 3 Model number

The laser starts self-leveling at once. During the self-leveling process, the laser will not rotate and the laser beam as well as the leveling LED (d) will flash once every second. When the laser is switched on, it always starts in automatic self-leveling mode. As soon as it is leveled, the rotor will start to spin and the laser beam will turn on. The laser always starts with the last used rotation speed and with the last used grade value (default). If the preference is to start the laser with grade value of zero, see chapter 18.4 (how to change the default).

The leveling LED (d) will illuminate solid as long as the laser is in automatic mode, but the shock warning or HI-alert is not active. When the HI-alert is active, the leveling LED flashes every four seconds and 'HI' appears in the display of the laser and remote control. The laser constantly monitors the level condition as long as the HI-alert is active.

If a grade value has been dialed in, the unit starts the temperature reference check while the thermometer symbols are flashing. See pic 4.

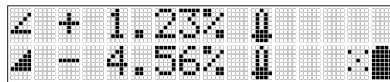

Pic 4 Temperature reference check

When the temperature reference check has been finished, the standard display appears and the Automatic (A) symbols flash until self-leveling has been completed.

When the A symbols is solid, the laser starts rotating. See pic 5 for horizontal and pic 6 for vertical.

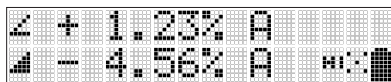

Pic 5 Standard display horizontal

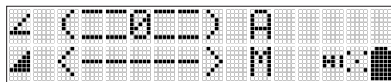

Pic 6 Standard display vertical

Pressing and holding the E button (j) shows the actual rotation speed and the internal product temperature. (Pic 7). This temperature can be different from the ambient temperature.

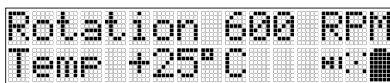

Pic 7 E button info

**Note:** For HI-alert (shock warning) description and how to change, see chapter 18.1.

To turn Off the laser, press and hold the power button for two seconds.

Note: If the laser is out of its self-leveling range and remains out of it for more than 10 minutes, the unit shuts down completely.

## 6 Menu Navigation

**WHY:** A menu driven interface can access all features of the GL1425C. This is an intuitive way to operate the laser. It is easy to use since it does not require various two or three finger button presses.

**WHAT:** Both the laser and the remote control RC1402 have a keypad for menu access. The menu selections vary depending on horizontal or vertical setup.

**HOW:** Press M button (h) to enter the menu and to see a function in the menu or to see a sub menu. Press E button (j) to start the function or to enter the submenu. Scroll within the menu or submenu with the UP/DOWN arrow buttons (f). The selected function is indicated by arrow brackets >> <<. An up or down arrow at the right side indicates there are more features accessed by scrolling up or down. Press M button (h) to go back to next level until the standard display is shown.

Menu functions when GL1425C set up in horizontal mode:

>>Grade<<  
>>Rotation<<  
>>GradeMatch<<  
>>PlaneLok<<  
>>Mask Mode<<  
>>Temp Check<<

**>>Settings<<**  
**>>Info<<**  
**>>Service<<**

Menu functions when GL1425C set up in vertical mode:

**>>Rotation<<**  
**>>PlaneLok<<**  
**>>Linecsan<<**  
**>>Mask Mode<<**  
**>>Settings<<**  
**>>Info<<**  
**>>Service<<**

## **7 Bluetooth® Connectivity**

**WHY:** Bluetooth® is an easy way to connect your laser with another device that also provides Bluetooth®. The GL1425C provides Bluetooth® connectivity to connect your smartphone with the laser when using the Spectra Precision Laser Remote App.

**WHAT:** The Spectra Precision Laser Remote App is available on Google Play Store and App store. Download the app from the store to your smartphone and install it.

**HOW:** Option 1: When powering on the GL1425C, it is in connectivity mode for the first thirty seconds. During this time, start the Laser Remote App. When starting the Laser Remote App for the very first time after installation, accept the EULA. If the EULA is not accepted, the App cannot be used. Also enable the GPS function on the smartphone. When the Bluetooth® connection was successful, the laser status LED (d) will be blue and the Laser Remote App shows the standard display of the GL1425C.

Option 2: Press M button (h) on the laser (not the remote control) to enter the menu. Scroll to >>Settings<< and press E button (j) to enter the sub menu. Scroll to >>Pairing<< and press E button (j) to enter the sub menu. Scroll to Bluetooth and press E button (j) to start the connectivity mode for the Bluetooth. The laser is in Bluetooth connectivity mode for 30 seconds. Now start the Laser Remote App. When the Bluetooth® connection was successful, the Laser status LED (d) will turn blue and the Laser Remote App shows the standard display of the GL1425C.

**Note:** In manual mode, the laser status LED (d) will continue with a short blinking in blue color every two seconds indicating the Bluetooth® connectivity.

**>>Settings<< → >>Pairing<< → >>Bluetooth<<**

## **8 Horizontal automatic, self-leveling mode**

**WHY:** The laser GL1425C provides a horizontal laser reference for measurements on a jobsite. This laser reference is used to establish and check horizontal heights for elevation control on jobsites

**WHAT:** By rotating the laser head, the laser provides a horizontal laser plane, which is detected with a laser receiver. Under very low ambient light conditions, the laser beam may be visible, but the laser is designed to be used with a receiver.

HOW: The laser should be setup in a stable manner, typically mounted on a tripod. The solid or flashing green leveling LED (d) confirms the automatic self-leveling mode. The laser always starts in automatic mode when turned on.

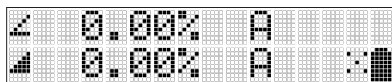

Pic 8 Horizontal automatic mode

## 9 Horizontal manual mode

WHY: For some applications the user may require a non-leveled laser plane. This can be used to align non-leveled elevations or reference hubs. The laser can be sloped in both axes when in horizontal manual mode.

WHAT: When in manual mode the laser does not self-level. The laser does not use any sensors for horizontal leveling or for grade. There is no control for the grade accuracy and no warning for the Height of the Instrument (HI-alert).

HOW: In horizontal mode press the manual button (c) on the laser or remote control once to change from automatic self-leveling mode to manual mode. Manual mode is indicated by the flashing red LED (e) once every second.

In manual mode (horizontal), the Y-axis can be sloped by pressing the Up or Down arrow button (f) on the laser keypad or remote control. The X-axis can be sloped by pressing the Left or Right arrow button (t) on the laser keypad or remote control. Manual mode is indicated on the laser and remote control display by horizontal lines next to the axis symbols and the letter M (pic 9) as well as the blinking manual LED (e). A manual inclination of the laser using a tilting base, a tripod or similar accessory is possible in the manual mode.

To resume automatic self-leveling, press the manual button once again, so the green leveling LED (d) is on and the laser self-levels.

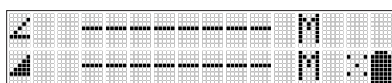

Pic 9 Horizontal manual mode

Note: In horizontal manual mode, it is mandatory the user watch the laser plane for any unforeseen behavior since there is no warning for the height of instrument or any changes caused by wind, vibrations or temperature changes.

## 10 Grade

### 10.1 Grade Input

WHY: Jobsite often requirement sloped grades for drainage and other reasons. The grade laser eliminates time consuming and error prone distance vs. height calculations. Just align the laser in the grade direction, and input desired grade into the laser.

WHAT: The GL1425C automatically levels to the specific grade value that is entered.

HOW: Option 1: Digit Select Mode (Default)

Press and release M button (h) to open the menu. >>Grade<< will be shown, Press and release E button (j) to enter the grade function. The grade values for both the Y

axis as well as the X axis are shown. A cursor flashes at the + sign of the Y axis. Pressing and releasing Right or Left arrow buttons (g) moves the cursor to the right or left and in a circle to the next row.

Use Down or Up arrow button (f) to change the sign (grade reverse), (see pic 10) or to set the desired digit at the cursor position, (see pic 11).

For a quick cursor toggle between the Y and X axis, press and release manual button quickly.

Press and hold the manual button for two seconds to set the grade to 0%.

Quickly press and release E button (j) to confirm the selected grade value and return to the standard display. The laser will automatically self-level to the required grade value.

Note: The A symbols on the LCD next to the grade value will flash until the laser has finished the self-leveling process.

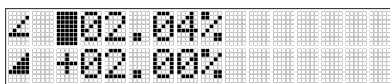

Pic 10 Grade reverse

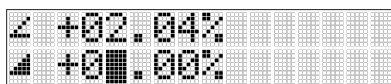

Pic 11 Grade change

### Option 2: Step & Go Mode

Press and hold Up or Down arrow button (f) for at least three seconds to change the Y-axis grade value. Pressing the Up arrow button will change the grade value into the positive direction. Pressing the Down arrow button will change the grade value into the negative direction.

Pressing the Up and Down arrow button simultaneously starts the quick change mode for the Y axis where the grade value will be set to 0% and then starts changing in 1% increments.

Press and hold the Left or Right arrow button (g) for at least three seconds to changing the X axis grade value. Pressing the Left arrow button will change the grade value into the negative direction. Pressing the Right arrow button will change the grade value into the positive direction.

Pressing the Left and Right arrow buttons simultaneously starts the quick-change mode for the X axis where the grade value will be set to 0% and then starts changing in 1% increments.

The laser will self-level to the required grade position after releasing the arrow buttons with a delay of one second.

**Note:** An asterisk at the right side of the grade value indicates which grade value will be changed, (see pic 12).

**Note:** When the highest or lowest grade value has been reached, the grade value starts with 0% again.

**Note:** The A symbols at the LCD will flash until the laser has been self-leveled to the requested grade position.

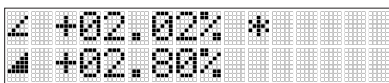

Pic 12 Grade change Step & Go mode

## 10.2 Grade value from +/- 9% to +/- 15%; Laser pre-tilt is needed

**WHY:** The grade range from 0% up to +/- 9% is achieved with a regular setup of the tripod. When a grade range more than 9% is required, there is some limitation of the free movement of the rotor head. A grade range up to +/- 15% can be achieved with a pre-tilt of the laser.

**WHAT:** When a grade range has been entered that the laser cannot level to, there will be an alarm (beep) and the display will show an arrow next to the grade value, (see pic 13). This arrow indicates the direction in which the product has to be adjusted. This is achieved by lowering or lifting a tripod leg or with a tilting base (p/n M401).

**HOW:** Enter the grade value (see chapter 10.1) that is more than 9%. Wait for the product to level. When the pre-tilt is not enough the laser display will show the axis direction where the laser needs to be raised. Mount either a tilting base to the tripod that allows to tilt the laser up in the Y+ direction or lift the tripod leg that is orientated in the Y+ direction or lower the tripod leg that is orientated in the Y- direction. It is recommended to have only one tripod leg oriented in the directions that is required to lift or to lower.

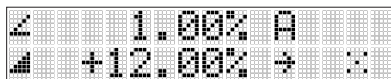

Pic 13 Pre-Tilt indication

## 11 Rotation Speed

**WHY:** Different applications or use cases may require different rotation speeds. Slow rotation speed increases visibility and high rotation speeds may enhance receiver performance.

**WHAT:** The GL1425C provides 3 rotation speeds: 300, 600 and 900 RPM.

**HOW:** Press 'M' button to enter the menu. Using the Up or Down buttons (f), scroll to and select >>Rotation<<. When selected, press 'E' button to enter the rotation menu. Using the Up or Down buttons (f), choose the rotation speed 300, 600 or 900 RPM. When selected, press 'E' button to confirm and start the rotation speed.

>>Rotation<<            →            >>300 RPM<<  
    >>600 RPM<<  
    >>900 RPM<<

## 12 Mask Mode

**WHY:** In some applications or jobsites, the laser beam may cause issues in some directions. Maybe the laser could disturb workers or the laser may hit reflective surfaces like windows or glossy metal surfaces. These surfaces may create laser reflections detected by the laser receiver and lead to erroneous readings.



WHAT: The mask mode allows electronic shut off the laser beam in up to 3 of 4 quadrants. The status of the mask mode is shown on the standard LCD (pic 17).

HOW: There are two options to activate the mask mode.

Option 1: To activate the mask mode on the + or – Y axis, press the Up or Down arrow button (f) and the manual button (c) within one second. To activate the mask mode on the + or – X axis, press the Left or Right arrow button (g) and the manual button (c) within one second.

Option 2: Press and release the M button (h) at the keypad to enter the menu. Select >>Mask Mode<<. To select the sector, press and release one of the corresponding arrow buttons. When the desired sectors have been set, press E button (j) to store the selection.

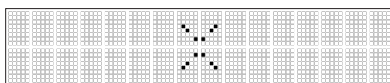

Pic 14 Display no mask mode

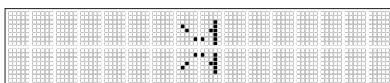

Pic 15 Mask Mode +X-Axis

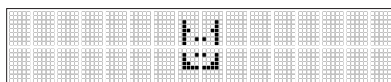

Pic 16 Mask Mode +X, -Y, -X-Axis

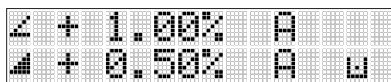

Pic 17 Mask Mode on Standard Display

**Note:** Maximum of three sectors can be selected.

**Note:** The laser always powers up with the mask mode deactivated.

## 13 Temperature Reference Check

WHY: When working during temperature changes and over long distances, the laser requires a frequent reference check to maintain accuracy and avoid errors caused by drift. When carrying out work where accuracy is paramount, it is advised to manually prompt a reference check at regular intervals. This feature allows grade accuracy verification after sudden changes in the jobsite climate, e.g. sunshine after rain or vice versa.

WHAT: The laser performs an automatic reference check when grade has been entered and will repeat the reference check when there is a 5°C (9°F) change within the product. When this is not enough for the accuracy requirements, a manual reference check can be started.

HOW: Press and release the M button (h) and scroll to >>Temp Check<<. Press and release the E button (j) to start the reference check. While the laser is doing the reference check, the laser rotation will be stopped.

**Note:** A grade value has to be entered before the laser starts the reference check.

## 14 Standby Mode

**WHY:** There might be times when the laser is not used for a period of time (e.g. lunch break), and the laser can be put in Standby Mode to conserve battery life. Standby Mode retains the laser settings.

**WHAT:** In Standby mode, the self-leveling will be stopped and the beam will be turned off while the HI-alert is still active. The display shows “--Standby--”. The HI/MAN LED (e) flashes red every five seconds. The standby mode ends automatically if the device orientation changes from horizontal to vertical or vice versa. When the laser is in Standby Mode for more than 8 hours or when the batteries are empty, it automatically switches off.

**HOW:** Press and hold the manual button (c) at the laser or remote control for three seconds to bring the laser into the standby mode. Press and hold the manual button (c) again for three seconds to deactivate the standby mode and to restore full operation of the laser.

## 15 GradeMatch (Y-Axis)

**WHY:** GradeMatch is designed to match the rise or fall of the ground between two existing unknown elevations. This will eliminate the need of complex calculations and will avoid errors.

**WHAT:** The automatic grade matching function can match the current rise or fall and will show the value on the display of the laser, remote control or app. The feature will typically work to a maximum distance of 80 m (240 ft.).

**HOW:** GradeMatch is available in the Y axis in the horizontal automatic mode only. If started in manual mode, the laser will switch into automatic mode.

- 1.) Set up the laser over the first reference point.
- 2.) Attach the HL760 or CR700 receiver to a grade rod. Place the rod next to the laser and adjust the height of the receiver next to the laser until the laser receiver is on-grade. Now the on-grade position of the receiver has the same elevation as the laser beam.
- 3.) Without changing the receiver's elevation on the rod, position the rod at the second reference point with the front of the receiver facing the laser.
- 4.) Use the sighting guides on the top of the laser to align the laser to the receiver.
- 5.) Press and release the M button (h) and select >>Grade Match<<.
- 6.) Press and release E button (j) to enter the GradeMatch submenu; confirm Y-axis by pressing the E button (j) again to start the GradeMatch function (see pic 18).
- 7.) The laser starts to search for the receiver. The laser as well as the HL760/CR700 display shows a flashing --GM-- during the time the laser is searching and adjusting the beam to the on-grade position. When GradeMatch has been completed, the HL760/CR700 go back to the standard elevation display. The remote control and laser will display the final measured grade value. Press the Manual button to exit the GradeMatch. The laser will return to automatic mode.
- 8.) When the function GradeMatch is complete, the laser will show the calculated grade value and will change to standard grade display. The laser will keep the grade value for the Y-axis. The HL760/CR700 shows the on-grade for the laser. Even when the receiver has been moved to take measurements, the laser will stay with the grade value.

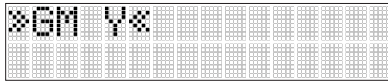

Pic 18 GradeMatch submenu

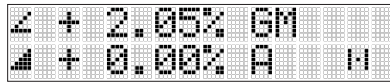

Pic 19 GradeMatch laser display

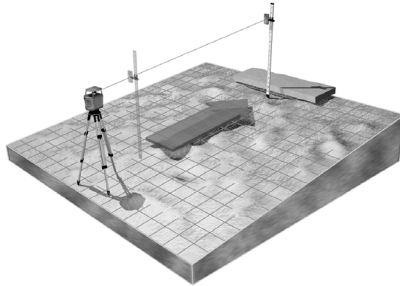

Pic 20 GradeMatch set up

## 16 PlaneLok

**WHY:** On some jobsites, there is the need to lock the laser onto a fixed position. This helps with high accuracy requirements or to overcome job site circumstances like vibrations, moving objects (high buildings), or temperature drift.

**WHAT:** A radio in the laser and the receiver communicate with each other and keep the laser beam locked to a fixed horizontal elevation or vertical direction. Using PlaneLok, the GL1425C connects a first elevation reference point, where the laser is positioned, with a second elevation reference point where the laser receiver is positioned with the correct grade. The PlaneLok mode will automatically guide the laser beam of the Y-axis to the on-grade position of the HL760/CR700 receiver. As a result of the PlaneLok, the laser is sloped in the Y-axis while the X-axis will remain in the automatic self-leveling mode. The HL760/CR700 receiver continuously shows the on-grade position of the laser. It is necessary to leave the receiver at the fixed position and to use another receiver to do the measurements. It is not recommended to switch the laser into manual mode and to remove the receiver.

**HOW:** The PlaneLok mode can be activated either in horizontal automatic mode or in vertical automatic and manual mode.

In horizontal mode, PlaneLok is only available on the Y axis.

In vertical mode, PlaneLok is available in the Y or X axes. When used in vertical mode, the receiver has to be placed with the photocell on the bottom.

When used in Y-axis vertical mode, the top of the laser and top of the receiver should be oriented the same.

- 1.) Set up the laser over the first reference point.
- 2.) Attach the HL760/CR700 receiver to a grade rod. Place the rod next to the laser and adjust the height of the receiver next to the laser until the laser receiver is on-grade. Now the on-grade position of the receiver has the same elevation as the laser beam.

3.) Without changing the receiver's elevation on the rod, position the rod at the second reference point with the front of the receiver facing the laser.

4.) Use the sighting guides on the top of the laser and align the laser to the receiver.

5.) Press and release the M button (h) to enter the menu and scroll to >>PlaneLok<<.

6.) Horizontal: Press and release E button (j) to enter the PlaneLok submenu. Select >>PL Y<< to confirm PlaneLok for the Y-axis. Press E button (j) to start PlaneLok (see pic 21).

Vertical: Press and release E button (j) to open the PlaneLok submenu. Select either >>PL Y<< for the Y-axis (see pic 34) or >>PL X<< for the X-axis (see pic 22) and press E button (j) to start PlaneLok.

7.) The laser starts to search for the receiver. The laser and the receiver display show the flashing —PL— during the time the laser is searching and adjusting the beam to the on-grade position (see pic 23). When PlaneLok is complete, —PL— stops flashing on the laser and receiver display.

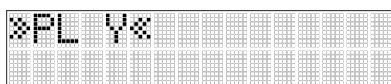

Pic 21 PlaneLok horizontal Y-axis

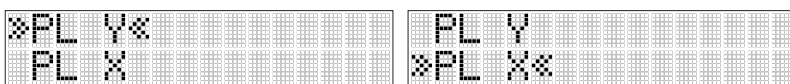

Pic 22 PlaneLok vertical Y-axis / X-axis

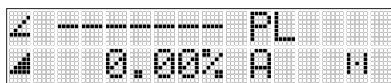

Pic 23 PlaneLok laser display

**Note:** For the best performance and longer operating range, set up the receiver at least 1 m (3 ft.) above the ground.

**Note:** In PlaneLok mode, the laser continues to servo to the receiver's signals. Any loss of signal over an extended period of time (1 minute) causes an error (beam turns off, rotor stops and a warning message occurs at the LCD). PlaneLok mode can be reactivated after the Error message (see pic 24) has been deleted with the E button (j). Exiting of PlaneLok can be done by pressing Manual button (c) on the laser or remote control, any button on the receiver, or ESC in the laser remote app.

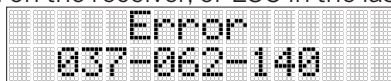

Pic 24 Error code blocked beam

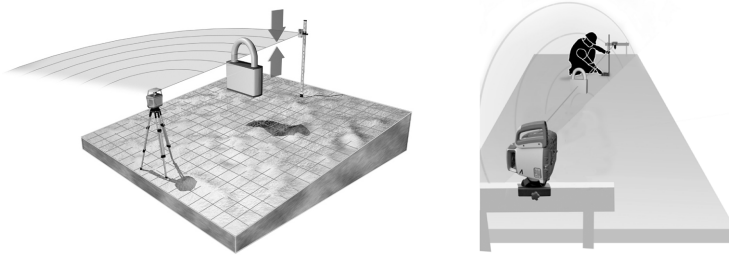

Pic 25 Horizontal/Vertical PlaneLok

## 17 Settings

**WHY:** Different use cases, job sites, users and applications require different settings for the laser.

**WHAT:** The >>Settings<< describe how the laser can be adjusted according to the requirements of the application or user preferences.

**HOW:** Press the M button (h) to enter the menu. Scroll to >>Settings<<, press the E button to enter the Settings menu. With arrow buttons UP/DOWN, scroll to the sub-menus.

### 17.1 Pairing

#### 17.1.1 Bluetooth

**WHY:** Bluetooth® is an easy way to connect your laser with another device that also provides Bluetooth. The GL1425C provides Bluetooth connectivity to connect your smartphone with the laser when using the Spectra Precision Laser Remote App.

**WHAT:** The Spectra Precision Laser Remote App is available on Google Play Store and the Apple store. Download the app from the store to your smartphone and install.

**HOW:**

**Option 1:** When powering the GL1425C, it is in connectivity mode for the first thirty seconds. During this time start the Laser Remote App. When starting the Laser Remote App for the first time, accept the EULA. If the EULA is not accepted, the App can't be used. Also enable the GPS function on the smartphone. When the Bluetooth connection was successful, the Laser status LED (d) will continue with a blue color and the Laser Remote App shows the standard display of the GL1425C.

**Option 2:** Press M button (h) on the laser (not remote control) to enter the menu. Scroll to >>Settings<< and press E button (j) to enter the sub menu. Scroll to >>Pairing<< (first item) and press E button (j) to enter the sub menu. Scroll to >>Bluetooth<< (first item) and press E button (j) to start the connectivity mode for the Bluetooth. The laser is in Bluetooth connectivity mode for 30 seconds. Now start the Laser Remote App. When the Bluetooth connection was successful, the Laser status LED (d) will turn into blue and the Laser Remote App shows the standard display of the GL1425C

## 17.1.2 Radio

WHY: A radio communication is needed for the remote control to control the laser and for receiver to perform automatic features. When the laser has been shipped with the remote control and the receiver, both are usually paired with the laser. Sometimes this radio pairing may be lost. When the remote control or receiver has been bought separately from the laser, there is no radio connectivity.

WHAT: The radio connectivity has to be set up to ensure the radio communication between the laser and the remote control and/or the receiver.

HOW: Option 1: Start with the laser off. Press and hold the Manual button (c) and power the laser with the on/off button (a). The laser is now in radio pairing mode for six seconds.

Option 2: Press M button (h) on the laser to enter the menu. Scroll to >>Settings<<, and press E button (j) to enter the sub menu. Scroll to >>Pairing<< (first item) and press E button (j) to enter the sub menu. Scroll to >>Radio<< and press E button (j) to start the radio pairing process. The laser will be in radio pairing mode for eight seconds.

## 17.2 Shock Warning (HI-alert)

WHY: The Shock Warning (HI-alert) function monitors the height of your instrument on the job site. Any changes of the Height of Instrument by bumping a tripod leg or sinking of a tripod leg will cause an alert. This ensures the accuracy of your work. When this change would cause a level error of more than 30mm at 10m (1-1/4 in at 30 ft) the laser would give a warning. This is equal to a change of tripod height of about 3 mm (1/8 in).

During laser setup, the Shock Warning is not activated since this may result in a constant alarm when the height and position of the laser or tripod is being changed. This is why the GL1425C provides a delay time for the Shock Warning. The Shock Warning is active when the delay time is over and the setup has been completed within this time frame.

WHAT: When entering into alert mode, the rotation stops, the laser beam turns off, a warning sound is heard and the HI/MAN LED (e) flashes every 4 seconds and HI symbols appears at the right corner of the main display in the app. The user now has to check the set up of the laser and reset the laser to ensure the initial setup is achieved.

To allow for the setup, the GL1425C provides three options for the Shock Warning (HI-alert) delay time. Under the menu item HI-alert the user can switch off the Shock Warning (not recommended) or can change the delay time to activate the Shock Warning. This delay time can be changed between 30 seconds or five minutes (default).

HOW: Press the M button (h) to enter the menu. Scroll to >>Settings<<, press the E button (j), scroll to >>HI Alert<<, press E-button (j) to open the HI-alert submenu. Choose delay time by scrolling to the option and confirming by pressing the E button.

**>>HI 5 min<< (default)**

**>>HI 30 sec<<**

**>>HI-off<<**

### 17.3 Grade Display

WHY: Some jobsite plans mention the slope requirements in different units. Depending on planning or regional requirements, the plan may require the slope in percentage, per mill or degree.

WHAT: The GL1425C provides three different possibilities to display the slope value: percentage, per mill or degree. This can be changed in the Settings menu. Changing the grade display will result in the correct calculation from percentage into per mill and into degrees accordingly.

HOW: Press the M button (h) to enter the menu. Scroll to >>Grade Display<< and press the E button (j) to enter the sub menu. Scroll to the desired grade display mode and select percent (%), per mill (‰) or degree (°). Press E button (j) to confirm the selected display mode.

**>>%<< (default)**  
**>> ‰<<**  
**>> °<<**

**Note:** The grade value for % and ° is shown with maximum two digits after the point. The grade value for ‰ is shown with maximum one digit after the point.

### 17.4 Start Grade

WHY: The laser always starts with the latest grade value stored when the unit was shut off. This is convenient when starting the job at the next day with the same value for the grade. For some users this is a risk when the laser is shared within different teams. There is a chance that the wrong grade value is used when the user does not check the grade value before the work starts.

WHAT: Change the settings to start with the previous stored grade value or start with zero grade.

HOW: Press M button (h) to enter the menu. Scroll to >>Settings<< and press the E button (j) to enter the sub menu. Scroll to >>Start Grade<< and press the E button (j) to enter the sub-menu. Choose Saved(default) or 0 Grade.

**>>Saved<< (default)**  
**>>0 Grade<<**

### 17.5 Backlight

WHY: Under dark ambient light conditions, the display is often hard to read. A backlight helps to view the display on the laser and remote control. Using the backlight too long reduces battery life.

WHAT: Depending on the need of longer visibility for the backlight or saving the battery life, the laser provides two different times to shut off the backlight: 8 seconds or 60 seconds.

HOW: Press the M button (h) to enter the menu, scroll to >>Settings<<, press the E button (j) to enter the sub menu. Scroll to >>Backlight<< and press the E button (j) to enter the sub menu. Choose backlight time of 8 seconds (default) or 60 seconds. Press the E button (j) to confirm the selection.

**>>8 seconds<< (default)**  
**>>60 seconds<<**

## 17.6 Sensitivity

WHY: The job site conditions might be different as well as the requirements according to accuracy. On some job sites there are a lot of vibrations caused by machines there is a lot of wind.

WHAT: The GL1425C provides different levels of sensitivity depending on the job site conditions. In all levels of sensitivity the laser will level to the most accurate level or grade value. Nevertheless the tolerance allowing for a disturbance by vibration or wind will be different. The three different levels of sensitivity provided by the GL1425C are low to work with high wind and vibrations, middle to work under normal job site conditions (default) and high to work in very calm conditions.

HOW: Press M button (h) to enter the menu, scroll to >>Settings<< and press E button (j) to enter the sub menu. Scroll to Sensitivity and press E button (j) again to enter the sub menu. Choose the desired level of sensitivity Low, Middle(default), or High.

>>Low<<  
>>Middle<<  
>>High<<

## 17.7 Language

WHY: The laser is used worldwide or the company using the GL1425C may have employees from different countries. Each person on a job site using the GL1425C wants to use the laser in the known language.

WHAT: The GL1425C provides many different languages for the interface. Standard language is English. Using the laser remote app with the laser, there is no need to change the language for the app. The laser remote app will use the language that is used for the smart phone when this language is supported by the laser. If the smart phone uses a language that is not supported by the laser, the laser remote app uses English as the language.

HOW: Press M button (h) to enter the menu. Using Up/Down buttons (f) scroll to >>Settings<<, then >>Language<<. Press E button (j) to enter the sub-menu. Scroll to the language, select the language moving these >> << symbols by scrolling and press E button to confirm.

>>English<<	>>Deutsch<<
>>Italiano<<	>>Francais<<
>>Portugues<<	>>Nederlands<<
>>Dansk<<	>>Norsk<<
>>Svenska<<	>>Suomi<<
>>Polski<<	>>Turkce<<
>>Cestina<<	

## 17.8 Radio Channel

WHY: The laser GL1425C is using radio communication between the laser and the remote control and the laser and the receiver HL760/CR700. On some jobsites there can be radio pollution within the radio channels. When the radio communication is not working properly, one solution can be to change the radio channel and use a radio channel that is more open.



WHAT: The GL1425C provides six different radio channels. Those are 0 (default), 1, 2, 3, 4 and 5.

HOW: The radio channel can be changed only at the laser. Press M button (h) to enter the menu. Scroll to >>Settings<<, then >>Radio Channel<< and press the E button (j) to open the sub menu. The desired radio channel 0 to 5 can be selected by scrolling the >> << symbols using the UP/DOWN buttons. Press the E button (j) to confirm the selected radio channel.

Note: After changing the radio channel on the laser, the remote control RC1402 and the HL760/CR700 have to be paired again. During pairing process, they will adopt to the new radio channel.

>>0<<

>>1<<

>>2<<

>>3<<

>>4<<

>>5<<

## 18 Info

WHY: The info menu provides information about the laser. This information may be helpful for communication with your dealer or service technician if a problem occurs with the laser during usage.

WHAT: Information about the laser: laser model number, battery status, temperature within the laser in °C and °F, PWR-FW-REV, SENS-FW-REV, RADIO-FW-REV, and the internal serial number (SN) in HEX-code (that is different to the serial number printed on the label).

Information about the runtime of the laser. This is the time the laser has been used since it was produced. The runtime is shown in hours and minutes. It cannot be reset to zero. Information about the current radio channel selected.

HOW: Press the M button (h) to enter the menu. Use the Up or Down buttons (f) and scroll to >>Info<<. Press E button (j) to enter the Info submenu. Scroll to >>About LS<<, and press E button (j) to enter the sub-menu. Scroll to >>Runtime<< and press E button (j) to see the current runtime. Scroll to >>Radio<< and press E button (j) to show the current radio channel.

Sub-menus in >>About LS<<:

Scroll to >>Model<<, and press E button (j) to read the model number of the laser.

Scroll to >>Battery<< and press E button (j) to show the battery status of the laser:

>>Good<<   >>Weak<<   >>Empty<<

Scroll to >>Temperature<< and press E button (j) to show the current temperature within the product in °C and °F.

**Note:** this is the internal product temperature and this can be different to the ambient temperature.

Scroll to >>PWR-FW-REV<< and press E button (j) to read out the revision of the PWR-Firmware.

Scroll to >>SENS-FW-REV<< and press E button (j) to read out the SENS-Firmware revision.

Scroll to >>RADIO-FW-REV<< and press E button (j) to read out the RADIO-Firmware revision.

Scroll to >>Serial Number<< and press E button (j) to read out the internal serial number of the laser in HEX code (see pic 81).

In menu >>Runtime<<, press E button (j) to enter the menu and to see the current runtime of the laser.

In menu >>Radio<< press E button (j) to enter the menu and to read the laser IP-address and the current used radio channel.

## 19 Determining the Height of Instrument (HI)

**WHY:** For most applications it is necessary that the height of instrument (HI) is known because it is used as a reference height and control elevation on a regular basis.

**WHAT:** The height of instrument (HI) is the elevation of the laser beam in relation to a benchmark or reference point. The HI is determined by adding the grade-rod reading to a benchmark or known elevation.

**HOW:** Set up the laser and place the grade-rod on a jobsite benchmark (BM) or known elevation. Slide the receiver up or down the grade-rod until it shows an on-grade reading. Add the grade-rod reading to the benchmark to determine the height of instrument.

Example:

Benchmark = 30.55m (100.23ft)

Rod reading = +1.32m (4.34ft)

Height of instrument = 31.87m (104.57ft)

Use this HI as a reference for all other elevations.

See pic 26 for a calculation example.

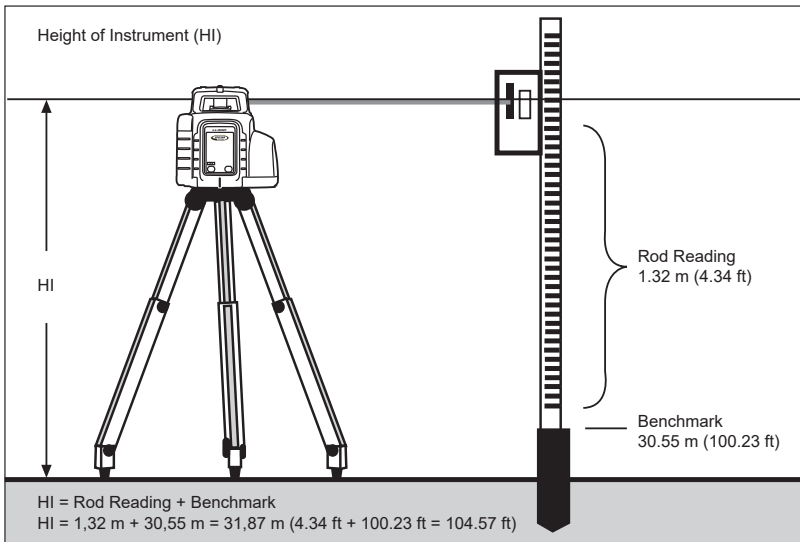

Pic 26 Height of Instrument Example

## 20 Vertical Application

### 20.1 Vertical Automatic Mode

#### 20.1.1 Laser Line Position

**WHY:** For many applications, two reference points need to be aligned to each other. Between the two reference points, a trench can be excavated or a vertical setup is needed to install formwork, fences or similar items.

**WHAT:** In vertical automatic mode, the laser provides a laser plane that is leveled vertically (along the Y-axis) and can be adjusted horizontal (along the X-axis)

**HOW:** The unit is in vertical position in the automatic mode (see pic 27). In this mode, pressing the Left or Right arrow buttons (g) will align the position of the laser plane in the direction of the X-axis.

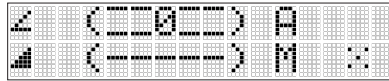

Pic 27 Vertical Automatic mode

**Note:** In vertical automatic mode, the X-axis is always in manual mode and there is no sensor that watches this axis. It is mandatory the user watches the laser plane in X-axis for any unforeseen behavior since there is no compensation and no warning for the position or any changes caused by wind, vibrations or temperature changes.

#### 20.1.2 Line Scan

**WHY:** For many vertical applications, it is helpful to have the laser centered to the housing to start with the alignment. The Line Scan function centers the rotor in relation to the housing.

**WHAT:** Activation of line scan can be done by two different options. The rotor checks the limits of the X-axis (laser beam is flashing, all laser LEDs are turned off) and stops at the center position.

**HOW:** Option 1: Pressing the Left or Right arrow buttons (g) simultaneously starts the Line Scan (pic 29). The rotor will stop at the center position. Pressing the manual button (c) stops the movement and changes the laser into manual mode (pic 30). Corrections left and right can be done using Left or Right arrow buttons (g). Press and release the manual button (c) to change the unit back to full automatic mode.

Option 2: Press M button (h) to enter the menu. Scroll to >>Line Scan<< (pic 28) and press E button (j) to start the function (see pic 29). Pressing the manual button (c) stops the movement and changes the unit into manual mode (see pic 30). Corrections left and right can be done using Left or Right arrow buttons (g). Press manual button (h) again to change the unit back to full automatic mode.

**Note:** In vertical automatic mode, the X-axis is always in manual mode and there is no sensor that watches this axis. It is mandatory the user watches the laser plane in X-axis for any unforeseen behavior since there is no compensation and no warning for the position or any changes caused by wind, vibrations or temperature changes.

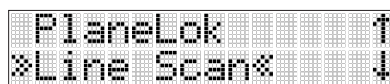

Pic 28 Line Scan menu

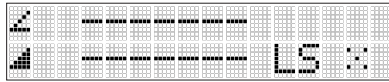

Pic 29 Line Scan in progress

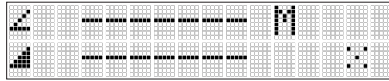

Pic 30 Line Position

### 20.1.3 PlaneLok in Vertical

See chapter 16

## 20.2 Vertical Manual mode

HOW: When unit is in vertical automatic mode, press the manual button (c) to switch into vertical manual mode.

Now the laser plane can be adjusted using the Up/Down arrow buttons (f) for the Y-axis or using the Left/Right arrow buttons (g) for the X-axis.

Note: In vertical manual mode, both the X-axis and Y-axis are always in manual mode and there is no sensor that watches the axis. It is mandatory the user watch the laser plane in X and Y axes for any unforeseen behavior since there is no compensation and no warning for the position or any changes caused by wind, vibrations or temperature changes.

## 21 Use Receiver

### 21.1 Pair the laser with HL760 receiver

WHY: If the laser is to perform GradeMatch or PlaneLok functions, the laser and the receiver need to be paired so they can communicate with each other.

WHAT: The pairing of the laser and the receiver will establish a radio communication between them.

HOW: Make sure the laser is turned off.

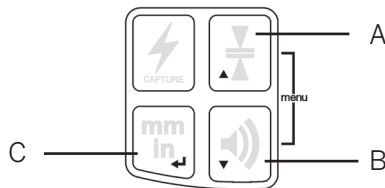

First, turn on the receiver, then press and hold the Deadband/Scroll up (A) and Loudness/Scroll down (B) button for two seconds simultaneously. After two seconds, the display shows MENU first, then RDIO. Press and release the Enter button (C). The display shows the current radio mode.

Mode LS means the receiver is ready to pair with a compatible laser;

Mode HL means the receiver is ready to pair with another HL760 or CR700;

Mode OF means the radio function of the receiver is disabled.

If the display does not show Mode LS, press Units button (C). The current mode flashes, now press deadband button (A) or audio button (B) until LS is flashing. Press Units button (C) button to enter selection Press and release the Loudness button (B) to display "PAIR". Press the Units button (C) again to start the pairing process; the display shows a rotating bar. The HL760 is now in pairing mode.

Now continue with the laser. Press and hold the Manual button (c) on the laser and turn on the laser. The laser starts and a fast flashing Battery LED (b) indicates that the laser is in pairing mode. After completing, PAIR, "OK" will be displayed on the receiver and a long beep occurs. The GL1425C has been paired with this receiver and turns back to the standard function. On the HL760 press and release the power button twice to exit the menu at the receiver. A laser symbol and an antenna is indicated to confirm the receiver is ready for communication with the laser.

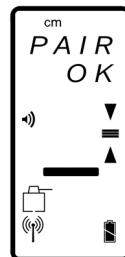

**INFO:** The laser with antenna symbol in the display is indication for the connection status of receiver and laser. When an automatic function with laser and receiver fails, the missing symbol is a first indication of a root cause. When the symbol is missing this can be the reason:

- The laser is off. Check the laser, it may have shut off for some reason. Turn it on and check if the symbols will come back after a few seconds.
- The laser is not paired with the receiver. Maybe this laser was paired with the receiver before but for some reason the pairing has been lost. Start the pairing process described in this chapter.

## 21.2 Pair the laser with CR700

Make sure the laser is turned off.



Menu



Scroll Up



Scroll Down

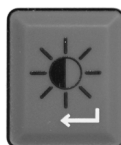

Enter

First turn on the CR700, press on/off (menu) button quickly, scroll to RDIO menu. Make sure RDIO LS is shown. If not, press enter button, symbol starts to blink. Scroll until LS is blinking. Press enter button. Make sure LS is no longer blinking. Scroll to PAIR. Press enter button. CR700 is now in pairing mode.

Now continue with the laser. Press and hold the Manual button (c) on the laser and turn on the laser. The laser starts and a fast flashing Battery LED (b) indicates that the laser is in pairing mode. After completing PAIR, "OK" will be displayed on the receiver and a long beep occurs.

The GL1425C has been paired with this receiver and turns back to the standard function. On the CR700 press and release the power button once to exit the menu at the receiver. A laser symbol and an antenna is indicated to confirm the receiver is ready for communication with the laser.

**INFO:** The laser with antenna symbol in the display is indication for the connection status of receiver and laser. When an automatic function with laser and receiver fails, the missing symbol is a first indication of a root cause. When the symbol is missing this can be the reason:

-The laser is off. Check the laser, it may have shut off for some reason. Turn it on and check if the symbols will come back after a few seconds.

The laser is not paired with the receiver. Maybe this laser was paired with the receiver before but for some reason the pairing has been lost. Start the pairing process described in this chapter.

## 22 Remote Control RC1402

### 22.1 Powering the RC1402

a) Open the battery door using a coin or similar pry device to release the battery door tab on the RC1402. Alkaline batteries are typically used. User provided rechargeable batteries can be used but need to be charged externally.

b) Insert two AA batteries noting the plus (+) and minus (-) diagrams inside the battery housing.

c) Close the battery door. Push down until it "clicks" into the locked position.

### 22.2 Turning On/Off the radio remote control RC1402

The radio remote control is a hand-held device that allows you to send operational commands to the laser from a distance.

Press the power button to turn on the radio remote control.

To turn off the radio remote control, press and hold the power button for two seconds.

When the remote control is initially turned on, the standard display (model number and software version) appear for the first three seconds (see pic 31), then the RC1402 LCD shows the actual laser function. This standard display is also shown when the RC1402 is out of operating range or is not paired with the laser or the paired laser is not switched on.

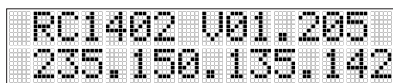

Pic 31 RC1402 standard display

With every button press, the LCD backlight is activated and turns off automatically if no button is pressed for 8 seconds or 60 seconds, depending on the settings. See chapter 17.5 on how to change the settings for the backlight.

**Note:** Five minutes after the last button press, the remote control turns off automatically to save battery.

### 22.3 Pairing the RC1402 remote control with the laser

**WHY:** The communication between RC1402 remote control and the GL1425C laser is based on a radio communication path. This enables a unique communication path that ensures only the paired laser will be controlled by the paired remote control.

**WHAT:** When the pairing has been lost for some reason, when the radio channel has been changed or when the remote has been added or replaced, the pairing needs to be reestablished.

HOW: First, make sure the laser and the remote control are turned off. Start with the laser by pressing and holding the Manual button when turning on the laser. Now the laser is in paring mode for the next six seconds. Within this time frame continue with the remote control. Press and hold the manual button on the remote control and turn on the remote control.

The laser beeps and the remote's display shows "Pairing OK" for one second and then the display shows the current working mode.

## 22.4 RC1402 Menu Navigation

Press and release 'M' button to enter the Menu.

The actual available function will be marked in arrow brackets >> <<. A down or up arrow on the right side indicates that the user can scroll up or down through the menu using the Up or Down arrow buttons. Press and release button 'E' to open the submenu or start the selected function.

Press and release the 'M' button to go back to the previous or standard display.

Press and release the Up or Down buttons until the desired function at the selected menu row is selected.

Menu functions for the GL1425C:

In Horizontal Orientation

>>Grade<<  
 >>Rotation<<  
 >>GradeMatch<<  
 >>PlaneLok<<  
 >>Mask Mode<<  
 >>Temp Check<<  
 >>Settings<<  
 >>Info<<  
 >>Service<<

In Vertical Orientation

>>Rotation<<  
 >>PlaneLok<<  
 >>Line Scan<<  
 >>Mask Mode<<  
 >>Settings<<  
 >>Info<<  
 >>Service<<

## 23 Troubleshooting

Any error message at the laser, the RC1402 remote control, or the app can be confirmed with a short press on the 'E' button or on the OK button on the app. The table below shows the related description and possible solutions. The laser or remote control show a string of numbers where only the last two or three digits are needed for the error code list down below. Using the laser remote app, the text shown below will be provided directly through the app depending on the error code.

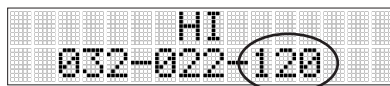

Pic 32 example error code HI-alert

The service center should be contacted if a different error message as shown on the table is displayed.

Error code	Description	Solution
030	PWR-Board data recovered	Press E button (j) on the laser or remote control or OK button in the app to confirm the error message. The laser has changed to default settings. You may need to redo your personal settings. The laser may have lost the pairing to the remote control, to the HL760/CR700 or the smartphone. Please check. You may need to redo the pairing.
035	SENS-Board data recovered	Press E button (j) on the laser or remote control or OK button in the app to confirm the error message. It is recommended to check the laser accuracy.
120	HI-alert – Unit height has changed	Press E button (j) on the laser or remote control or the OK button in the app to delete the error message. Check Laser Beam Elevation and Laser Setup.
130	Mechanical Limit during GradeMatch / PlaneLok	Press E button on the laser, remote control, or the OK button in the app to delete the error message. Check if existing grade is above or below +/- 15% or if the laser needs to be pre-tilted.
140	Laser beam blocked	Press E button (j) on the laser or remote control or the OK button in the app to delete the error message. Make sure there are no obstacles between the laser and HL760/CR700 receiver during the operation. The receiver needs to receive the laser beam all the time during this function.
141	Time out – Alignment could not be completed in the allowed time.	Press E button (j) on the laser or remote control or the OK button in the app to delete the error message. Check radio operating range/ connection. Check if the laser setup is stable.
150	No receiver – HL760/CR700 Receiver not available for single axis automatic function	Press E button (j) on the laser or remote control or the OK button in the app to delete the error message. Make sure the HL760/CR700 has been switched on and is paired with the laser. The HL760/CR700 may have turned off automatically. Check if receiver is within radio range.
152	No receiver - The laser searched for the receiver but could not find it	Press E button (j) on the laser or remote control or the OK button in the app to delete the error message. Check the operating range for auto function and restart the function. The receiver has been placed too far away, too high or too low. Check if the receiver has been placed along the wrong axis. If so place the receiver along the correct axis.
153	Lost receiver - The laser searched and found the receiver but then lost it.	Press E button (j) on the laser or remote control or the OK button in the app to delete the error message. Check the operating range for auto function and restart the function. The receiver has been placed too far away, too high or too low. Check if the receiver has been placed along the wrong axis. If so place the receiver along the correct axis.
155	More than one paired receivers are available during automatic alignment function	Press E button (j) on the laser or remote control or the OK button in the app to delete the error message. Make sure only one receiver is turned on.
157	After an established and started receiver operation this error indicates a lost communication	Press E button (j) on the laser or remote control or the OK button in the app to delete the error message. Check the operating range for auto function and restart the function. The receiver has been placed too far away
160	X or Y level sensor defect	Contact your service dealer.



## 24 Check Calibration

### 24.1 Checking calibration of the Y and X Axis

1. Set up the laser 30 m (100 ft.) from a wall and allow it to level.
2. Allow the unit to acclimate to ambient temperature.
3. Set the grade to 0.00% in both axis.
4. Rotate the +Y axis towards the wall.
5. Raise / lower the receiver until you get an on-grade reading for the +Y axis. Using the on-grade marking notch of the receiver as a reference, make a mark on the wall.
- Note: For increased precision, use the ultra fine-sensitivity setting (0.5 mm / 1/32 in.) on the receiver.
6. Rotate the laser 180° (-Y axis towards the wall) and allow the laser to re-level.
7. Rais / lower the receiver until you get an on-grade reading for the -Y axis. Using the on-grade marking notch as a reference, make a mark on the wall.
8. Measure the difference between the two marks. If they differ more than 3 mm at 30 m (1/8 inch at 100 feet), the laser needs calibrating.
9. After checking the Y-axis, rotate the laser 90°. Repeat the above starting with the +X axis facing the wall.

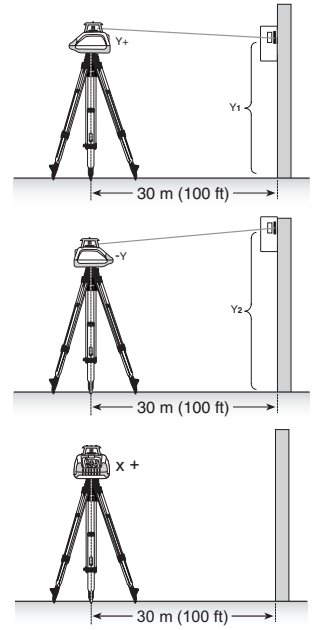

### 24.2 Checking calibration of the Z-Axis (vertical)

To check vertical calibration, you need a plumb bob with 10 m (30 ft.) of string.

1. Suspend the plumb bob in front of a structure i.e., attached to a window frame whose window height is at least 10 m (30 ft.).
2. Set up the laser in vertical so that the laser beam strikes the receiver's on-grade position at the top of the string.
3. Look for any deviation using the receiver from the top of the string to the bottom of it. If the deviation is more than 1 mm (1/16 in), the vertical axis needs calibrating.

## 25 Service

Spectra Precision (Kaiserslautern) GmbH  
Am Sportplatz 5  
67661 Kaiserslautern  
GERMANY  
Phone +49-6301-711414  
Fax +49-6301-32213

Spectra Precision (USA) LLC  
3265 Logistics Lane, Suite 200  
Dayton, OH 45377  
USA  
Phone +1 888-527-3771

## 25.1 Technician Menu

Access to Technician menu (pic 33), is only possible for trained service dealer personnel.

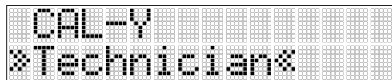

Pic 33 Technician menu

## 26 Protect the unit

Do not expose the unit to extreme temperatures or temperature changes (do not leave inside the car). The unit is very robust and can resist damage if dropped even from tripod height. Before continuing your work, always check the leveling accuracy. See section 24 'Calibration'.

The laser is waterproof and can be used indoors and outdoors.

## 27 Cleaning and maintenance

Dirt and water on the glass parts of the laser will influence beam quality and operating range considerably. Clean with cotton swabs.

Remove dirt on the housing with a lint-free, warm, wet and smooth cloth. Do not use harsh cleaners or solvents.

Allow the unit to air dry after cleaning it. Never put a wet laser or accessories into the carrying case for storage.

## 28 Protecting the environment

The laser, accessories and packaging ought to be recycled.

All plastic parts are marked for recycling according to material type.

**Note:** Do not throw used batteries into the garbage, water or fire. Remove them in compliance with local environmental requirements

## 29 Warranty

Spectra Precision LLC warrants the GL1425C to be free of defects in material and workmanship for a period of five years. Spectra Precision LLC or its authorized service center will repair or replace, at its option, any defective part, or the entire product, for which notice has been given during the warranty period. If required, travel and per diem expenses to and from the place where repairs are made will be charged to the customer at the prevailing rates. Customer should send the product to Spectra Precision LLC or the nearest authorized service center for warranty repairs or exchange, freight prepaid. Any evidence of negligent, abnormal use, accident, or any attempt to repair the product by other than factory-authorized personnel using Spectra Precision LLC certified or recommended parts, automatically voids the warranty. Special precautions have been taken to ensure the calibration of the laser; however, calibration is not covered by this warranty. Maintenance of the calibration is the responsibility of the user.

The foregoing states the entire liability of Spectra Precision LLC regarding the purchase and use of its equipment. Spectra Precision LLC will not be held responsible for any consequential loss or damage of any kind. This warranty is in lieu of all other warranties, except as set forth above, including any implied warranty merchantability of fitness for a particular purpose, are hereby disclaimed. This warranty is in lieu of all other warranties, expressed or implied.

## 30 Technical Specification

### 30.1 Technical Specification Laser GL1425C

Leveling Accuracy <sup>1,2</sup> vertical, horizontal	± 1,5mm / 30m; 1/16" @ 100ft; 10 arc seconds
Grade Accuracy <sup>1,2</sup>	± 3,0mm / 30m; 1/8" @ 100ft.; 20 arc seconds
Grade temperature drift	± 0,9mm / 30m / 1°C; 1/16" @ 310ft. @ 1°F
Grade range no pre-tilt	typ. ± 9 %
Grade range with pre-tilt	± 15 %
Rotation Speed <sup>1</sup>	300, 600, 900 rpm
Operational Diameter <sup>1</sup> , with HL760	Typ. 400 m (1300 ft) radius
GradeMatch Distance	Typ. 80 m / 260 ft
PlaneLok Distance	Typ. 80 m / 260 ft
Laser Type	630 – 643 nm
Laser Class	Class 2,
Self Leveling Range	Typ. ± 5° (± 8.7%)
Radio Range (HL760) <sup>1,3,4</sup>	Up to 100m (330 ft)
Operating Temperature	-20°C to +50°C (-4°F to +122°F)
Storage Temperature	-25°C to +70°C (-13°F to +158°F)
Power Source	10000 mAh NiMH battery back or 4 x 1.5V D alkaline batteries
Battery Life Time <sup>1</sup>	Typ. 45 hours
Battery Charging Time	< 10 hours
Battery Charging Temperature	5°C to +40°C (+41°F to +104°F)
Tripod Attachments	5/8 x 11 horizontally and vertically
Dust and Water Proof (IP)	IP66
Weight (incl. Battery pack)	3.49 kg / 7.7 lbs (incl. Battery pack)
Product Dimensions (LxWxH)	280 x 180 x 240 mm (11.0 x 7.1 x 9.5 in)

### 30.2 Technical Specification Laser Remote RC1402

Radio operating range <sup>1,3,4</sup>	Up to 100m (330ft)
Power Source	2 x 1.5V AA alkaline batteries
Battery life <sup>1</sup>	Typ. 130 hours
Dust and Water proof	IP66
Weight (incl. batteries)	0,26kg (0.57lbs)

<sup>1</sup> At 21°C/70°F

<sup>2</sup> along the axis

<sup>3</sup> under optimal atmospheric conditions

<sup>4</sup> when product is setup at a min. height of 1 m / 3 ft.

## **31 Declaration of Conformity**

We  
Spectra Precision LLC  
declare under our sole responsibility that the products  
GL1425C and optional RC1402  
to which this declaration relates is in conformity with the following standards:  
EN300 440-2 V1.1.1:2004, EN301 489-03 V1.4.1:2002, EN301 489-01 V1.4.1:2002,  
EN50371:2002 following the provision of directive R&TTE 1999/5/EC.

## **32 UKCA**

We declare under our sole responsibility that the GL1425C and RC1402 comply with  
all applicable provisions of the regulations listed below and are in conformity with the  
following standards.

EN 60825-1:2014  
EN IEC 62368-1:2020 + A11:2020  
EN61000-6-3:2007 + A1:2011  
EN IEC 61000-6-2:2019

## **33 Electro-Magnetic Compatibility**

Compliance statement (part 15.19): This device complies with part 15 of the FCC  
Rules. Operations is subject to the following tow conditions: (1) this device may not  
cause harmful interference, and (2) this device must accept any interference received,  
including interference that may cause undesired operation.

Warning (part 15.21): Changes or modifications not expressly approved by the party  
responsible for compliance could void the user's authority to operate the equipment.  
This in particular is applicable for the antenna, which has been delivered with the  
GL1425C and RC1402. Under Industry Canada regulations, this radio transmitter  
may only operate using an antenna of a type and maximum (or lesser) gain approved  
for the transmitter by Industry Canada. To reduce potential radio interference to  
other users, the antenna type and its gain should be so chosen that the equivalent  
isotropically radiated power (e.i.r.p.) is not more than that necessary for successful  
communication.



Spectra Precision LLC  
3265 Logistics Lane, Suite 200  
Dayton, OH 45377  
U.S.A.  
Phone +1 888-527-3771

Spectra Precision (Kaiserslautern) GmbH  
Am Sportplatz 5  
67661 Kaiserslautern  
GERMANY  
Phone +49-6301-711414

[spectraprecision.com](https://www.spectraprecision.com)

