



# Thermo Scientific AQUANEX™ Ultrapure Water Purification Systems

## Installation and Operation

274583-001 • Revision B • November 2023

**IMPORTANT** Read this instruction manual. Failure to follow the instructions in this manual can result in damage to the unit, injury to operating personnel, and poor equipment performance.

**CAUTION** All internal adjustments and maintenance must be performed by qualified service personnel.

Material in this manual is for informational purposes only. The contents and the product it describes are subject to change without notice. Thermo Fisher Scientific makes no representations or warranties with respect to this manual. In no event shall Thermo be held liable for any damages, direct or incidental, arising from or related to the use of this manual.

© 2023 Thermo Fisher Scientific Inc. All rights reserved.

### **Revision History:**

Revision A released September 2023: Initial product release

Revision B released November 2023: Removal of 30L Tank Mount and adjusting dispense rate specification.

Updated Aquanex RO assembly permeate flow.

Updated maximum distance in tubing connections of Main Unit to 30L External Tank and vice versa.

Update flow diagram.

Added footnote for 3 tubings in Aquanex System Shipping List.

Updated maximum tube distance between system and storage tank.

Added Notes at several instances.

Updated UI images.

# Contents

Preface .....	1
About this Manual .....	1
Intended Use.....	1
Signal Words and Symbols .....	1
Safety Instructions.....	2
Regulatory Compliance .....	4
Technical Specifications .....	8
Technical Data .....	8
Product Overview .....	11
Description of Features .....	13
Description.....	13
Installation.....	21
Unpacking.....	21
Location Requirements .....	24
Installation .....	26
Connecting Aquanex System .....	32
Operation.....	41
Initial Startup .....	41
Operation .....	46
Maintenance and Care .....	62
Maintenance Intervals.....	62
Consumable Replacement .....	63
System Disinfection .....	72

Appendix .....	75
Troubleshooting .....	75
Full List of Aquanex Alarms and Alerts.....	78
Aquanex Accessories .....	80
Warranty .....	81
Warranty Information.....	81
IF YOU NEED ASSISTANCE: .....	83

# 1 Preface

## 1.1 About this Manual

The Thermo Scientific™ Aquanex™ Ultrapure Water Purification System is designed to produce Type I and Type II water from a tap water source. The Aquanex system includes features such as ergonomic and easy to use smart volumetric Type I dispense capability, high-capacity de-ionization (DI) technology, water saving capability, easy access consumables, operational flexibility, connectivity, ease-of-use, and system intelligence.

This user manual provides important details on installation, operation, and maintenance of the Aquanex System to ensure the consistency of water quality and operation of the system.

## 1.2 Intended Use

The Aquanex Ultrapure Water Purification System is a general purpose, laboratory benchtop or wall-mount water purification system, intended to treat tap water (pretreatment required in most cases) to deliver Type I (Ultrapure) and Type II (Pure) water in a laboratory setting by filtering and treating the tap water with a Reverse Osmosis (RO) assembly, followed by Ultraviolet (UV) oxidation, deionization and Ultra Filtration (UF) and Point of Use (POU) filtration.

The intended users of the Aquanex System are individuals with experience and training in using laboratory equipments.

## 1.3 Signal Words and Symbols



This symbol used alone indicates important operating instruction(s) which can reduce the risk of injury or poor performance of the unit.



**DANGER:** When used with the word **DANGER**, this symbol indicates a potentially hazardous situation which, if not avoided, could result in serious injury or death.



**WARNING:** When used with the word **WARNING**, this symbol indicates a potentially hazardous situation which, if not avoided, could result in serious injury or death.



**CAUTION:** When used with the word **CAUTION**, this symbol indicates a potentially hazardous situation which, if not avoided, could result in minor to moderate injury.



**WARNING:** This symbol indicates situations where dangerous voltages exist and potential for electrical shock is present. Electrical work on the system must be carried out by qualified personnel.



This symbol indicates protective terminal ground conductor.



This symbol indicates earth ground terminal.



This symbol indicates that the unit is ON. A blue light illuminates the symbol when the unit is on.



This symbol indicates alternating current.



This symbol indicates direct current.



**PPE Required:** This symbol indicates a need to use eye protection during the indicated procedures. Local laws/regulations must be followed while using the proper PPE.



**PPE Required:** This symbol indicates a need to use gloves during the indicated procedures. If performing decontamination procedures, use chemically resistant gloves. Local laws/regulations must be followed while using the proper PPE.



**PPE Required:** This symbol indicates a need to use respiratory protection during the indicated procedures. Local laws/regulations must be followed while using the proper PPE.

**Note:** Information and notices are shared in the form of **Note** in this manual to provide the user with basic information.

## 1.4 Safety Instructions

Observe the precautions below for your own safety:



**DANGER:** Work must be performed on the system electronics when the system is switched OFF and when Electrostatic Discharge (ESD) protection is in place. Only specially trained personnel must work on the system's electronics.



**WARNING:** During operation, UV lamps emit electromagnetic radiation at a wavelength of approximately 254 nm. UVC radiation is hazardous to eyes and skin and causes skin rashes to severe burns, eye conjunctiva inflammation, corneal infections and potential long-term eye damage. Never look directly into a UV lamp which is powered ON, as UV light may damage eyesight and exposure to body may cause skin irritation.



**CAUTION:** The Thermo Scientific™ Aquanex™ Ultrapure Water Purification Systems are intended solely for the treatment of pretreated tap water. This system must not be used in production of water intended to be consumed or water that is used in manufacturing food and pharmaceuticals.

- Do not install or operate the system until you have carefully read the operating instructions and the notes and notices contained therein.
- The Aquanex System must not be used with liquids other than water or for domestic purpose.
- Do not place materials or stack other equipment on the top of the product.
- Do not remove any labels.
- Make sure that the system is properly drained of water before attempting to move it.
- Lifting and carrying the Aquanex Ultrapure Water Purification System, e.g., to the installation location, must be carried out by two people. To do this, lift the system in tandem using the handles on the bottom and back of the unit.
- Do not attempt to assemble, repair, or modify this product on your own as this will void the warranty and may create a hazardous situation.
- Only accessories specified by the manufacturer must be used with the product.

- Always observe the applicable, pertinent codes and regulations valid at the installation location of the system and follow all applicable accident prevention regulations.
- A grounded 100 - 240 V, 50/60 Hz electrical outlet must be available.
- Access to the power supply cord and plug must not be restricted or obstructed.
- Power supply must be properly grounded.
- Do not operate the system with a damaged power cord.
- Ensure the system is operated only with the provided power cord. Use of other cords may result in malfunctioning of the product.
- Unplug the system from the power outlet for all maintenance work on the system. Follow the procedure below if the system is has not been used for an extended period of time, e.g., over extended weekends or during a vacation period:
  - Switch the system **OFF** and unplug the power cord from its outlet.
  - Close the feedwater supply valve.
  - The system must be disinfected or rinsed after extended down time.
- The pumps will be damaged if the system runs without any supply of feedwater. The manufacturer will not accept any liability if this occurs.
- The surface on which the system is installed must be leveled and stable. Ensure that the installation surface is not uneven.
- Visually inspect the system at a regular interval. Never operate damaged or leaking equipment/accessories. Clean up any water or spills found around the system immediately.



**CAUTION:** To avoid the risk of pinching, crushing, cutting or electrical shock, never perform maintenance on the system without its protective housing or while it is in operation. Maintenance work on the system must only be performed by trained, authorized specialists.

- For safety information about disinfection, refer to SDS for the respective disinfection product in use.
- Wear safety gloves when changing the UV lamp to prevent skin from contacting the UV lamp glass and to avoid potential contact with the mercury (Hg) housed with the UV lamp. Maintenance work on the system must be performed only by trained, authorized specialists.
- Wear safety glasses when working with disinfection solutions.
- If the UV lamp is broken:
  - Wear breathing protection, filter category FFP3, and replace the UV lamp.
  - Ventilate the room well.
- To avoid tripping, ensure that the tubing does not lay over the floor in high-traffic areas.
- Apply the general rules of hygiene for laboratories when working with the system.
- Proceed as follows when the system has a defect:
  - Switch the system **OFF** and unplug the system from the power outlet.
  - Shut off the feedwater supply.
  - Contact your local service organization.

# 1.5 Regulatory Compliance

## 1.5.1 European Union



The European CE marking is applied on products that meet all the applicable requirements of the European Directives and are marketed in the EU. These Directives are captured in the EU Declaration of Conformity which may be obtained from the manufacturer.

Products not marked with a CE marking either do not operate in the 230V / 50Hz voltage range or are not intended to be sold to the EU Member States or European Economic Area (EEA). Please reach out to the manufacturer for questions regarding regulatory conformity.

## 1.5.2 United Kingdom



The UKCA marking is applied on products that meet all the applicable requirements of the UK Directives and are marketed in the UK. These Directives are captured in the UKCA Declaration of Conformity which may be obtained from the manufacturer.

Products not marked with a UKCA marking either do not operate in the 230V / 50Hz voltage range or are not intended to be sold to the UK region. Please reach out to the manufacturer for questions regarding regulatory conformity.

## 1.5.3 Product Safety

This product family has been tested to applicable product safety standards by a Nationally Recognized Test Laboratory (NRTL) and may hold the NRTL's mark of safety compliance to the applicable standards.

## 1.5.4 Electromagnetic Compatibility

This product family was tested for compatibility with shielded cabling at a maximum length of 6 ft (1.8 m).

### 1.5.4.1 FCC Statement (USA)



This device complies with Part 15 Subpart B of the FCC Rules. Operation is subject to the following two conditions:

1. This device may not cause harmful interference, and
2. This device must accept any interference received, including interference that may cause undesired operation. Any changes or modifications not expressly approved by the manufacturer could void the user's authority to operate the equipment.

**Note:** This equipment has been tested and found to comply with the limits for a Class B digital device, pursuant to part 15 of the FCC Rules. These limits are designed to provide reasonable protection against harmful interference in a residential installation. This equipment generates, uses and can radiate radio frequency energy and, if not installed and used in



accordance with the instructions, may cause harmful interference to radio communications. However, there is no guarantee that interference will not occur in a particular installation. If this equipment does cause harmful interference to radio or television reception, which can be determined by turning the equipment off and on, the user is encouraged to try to correct the interference by one or more of the following measures:

- Reorient or relocate the receiving antenna.
- Increase the separation between the equipment and receiver.
- Connect the equipment into an outlet on a circuit different from that to which the receiver is connected.
- Consult the dealer or an experienced radio/TV technician for help.

### 1.5.4.2 Canadian ISED IC Notice

This ISM digital apparatus complies with Canadian ICES-001, Class B.

Cet appareil ISM est conforme la norme NMB-001 du Canada, Classe B.

### 1.5.4.3 Korean KC Registration



사용자 안내문

이 기기는 업무용 환경에서 사용할 목적으로 적합성평가를 받은 기기로서 가정용 환경에서 사용하는 경우 전파간섭의 우려가 있습니다.

**WARNING:** EMC registration is done on this equipment only for business use only. It may cause interference when the product would be used in home. This warning statement applies for business purpose.

## 1.5.5 Material Content and Evaluation of Chemicals

### 1.5.5.1 REACH – EUROPE

Thermo Fisher Scientific is committed to meeting all the compliance obligations to evaluate, communicate and register any Substances of Very High Concern (SVHC), and finding alternates where appropriate.

### 1.5.5.2 RoHS – EUROPE

Thermo Fisher Scientific is determined to reduce the impact on the environment, and so can declare that this product complies with the European Parliament's RoHS2 (Restriction of Hazardous Substances) Directive 2011/65/EU and 2015/863 Annex II (RoHS2 Amendment) with respect to the limitation of the following substances:

- Lead (0.1%)
- Mercury (0.1%)
- Cadmium (0.01%)
- Hexavalent Chromium (0.1%)
- Polybrominated Biphenyls (PBB) (0.1%)

- Polybrominated Diphenyl Ethers (PBDE) (0.1%)
- Bis(2-ethylhexyl) Phthalate (DEHP) (0.1%)
- Butyl Benzyl Phthalate (BBP) (0.1%)
- Dibutyl Phthalate (DBP) (0.1%)
- Diisobutyl Phthalate (DIBP) (0.1%)

Our compliance is witnessed by written declaration from our suppliers and/or component testing. This confirms that any potential trace contamination levels of the substances listed above are below the maximum level set by the latest regulations or follow established exemptions of the regulation due to their application.

### 1.5.5.3 RoHS – China

This product complies with the requirements of the legislative act Administration on the Control of Pollution Caused by Electronic Information Products (ACPEIP). A label of conformance, such as one of the following, may be found on the product:



A declaration may be obtained from the manufacturer with greater detail of this conformance.

### 1.5.5.4 Proposition 65 – California



**WARNING:** This product may expose you to the chemicals like Mercury which is known to the State of California to cause cancer/birth defect and/or other reproductive harm. For more information, go to [www.P65Warnings.ca.gov](http://www.P65Warnings.ca.gov)

### 1.5.6 WEEE Compliance

This product is required to comply with the European Union’s Waste Electrical & Electronic Equipment (WEEE) Directive 2012/19/EU. It is marked with the following symbol. Thermo Fisher Scientific has contracted with one or more recycling/disposal companies in each EU member state and this product should be disposed of or recycled through them. Further information on our compliance with these Directives, the recyclers in your country and information on Thermo Fisher Scientific products which may assist the detection of substances subject to applicable directives are available at [www.thermofisher.com/WEEERoHS](http://www.thermofisher.com/WEEERoHS).



## 1.5.7 End of Life Care

Some considerations and suggestions are listed below for proper disposal of this product. While addressing these actions for safe recycling and disposal, please follow all the guidelines, Safety Data Sheets (SDS), or regulations applicable to your country and region.

- This product has materials and components that may be recycled or reused according to local guidelines and regulations.
- Remove any batteries present before disposal. Batteries, battery packs, and accumulators should not be disposed of as unsorted household waste. Please use the public collection system to return, recycle, or treat them in compliance with local regulations.
- Check the local laws and regulations for the proper disposal of the UV lamp.
- Before returning the Thermo Scientific™ Aquanex™ Ultrapure Water Purification Systems for waste disposal, contact your local waste disposal company for proper disposal of the system and its components. Only specially trained personnel should take the system out of operation and dispose it properly.

# 2 Technical Specifications

## 2.1 Technical Data

### 2.1.1 Aquanex™ System Technical Specifications

**Table 1. Aquanex System Components Technical Specifications**

	10L Main Unit	30L Main Unit	Smart Dispenser	30L Tank
Height	622 mm / 25 in	622 mm / 25 in	882 mm / 35 in	606 mm / 24 in
Height with CO <sub>2</sub> Adsorber	727 mm / 29 in	-	-	778 mm / 31 in
Width	610 mm / 24 in	610 mm / 24 in	271 mm / 11 in	388 mm / 16 in
Depth	406 mm / 16 in	406 mm / 16 in	380 mm / 15 in	384 mm / 15 in
Touchscreen Size	5.7 in	5.7 in	1.54 in	-
Tank Capacity	10L	-	-	30L
Dry Weight	32 kg / 70 lbs (without DI Packs)	31 kg / 68 lbs (without DI Packs)	9 kg / 20 lbs	6 kg / 14 lbs
Wet Weight	57 kg / 125 lbs (includes DI Packs)	46 kg / 101 lbs (includes DI Packs)	-	38 kg / 83 lbs
Sound Emissions	< 60 dB	< 60 dB	-	-
Horizontal Clearance	Minimum 250 mm / 10 inch		Minimum 360 mm / 14 in	Minimum 300 mm / 12 in
Vertical Clearance	Minimum 250 mm / 10 inch		Minimum 1065 mm / 42 in	Minimum 400 mm / 16 in

### 2.1.2 Aquanex System Electrical Requirements and Connections

**Table 2. Aquanex System Electrical Requirements and Connections**

Parameters	Values
Power adapter AC input voltage	AC 100 – 240 VAC, 50 – 60 Hz
Power adapter DC output voltage	DC 24 V, 5.0 A Max
Aquanex DC input	DC 24 V, 5.0 A, 120 W
User Interface	2 USB Type A, 1 USB Type B, 1 Ethernet
Protection class	Class II (external SMPS certified as Class I)

## 2.1.3 Aquanex System ASTM Type I and Type II Water Quality

**Table 3. Aquanex System ASTM Type I Water Quality\***

Parameters	Value	Unit
Conductivity (reference temperature +25°C)	0.055	μS/cm
Resistance (reference temperature +25°C)	18.2	MΩ·cm
Total Organic Carbon (TOC)	< 3	ppb
RNase	1	pg/mL
DNase	5	pg/mL
Protease	0.15	μg/mL
Bacteria	0.001	CFU/mL
Bacterial endotoxins	0.001	EU/mL
Particle	99.9	% Reduction > 0.1 μm
Sodium	< 1	ppb
Chloride	< 1	ppb
Silica total	< 3	ppb
Dispense Rate (10L system)	≥ 2.0	L/min
Dispense Rate (30L system)	≥ 1.5	L/min
**Volumetric Dispense Accuracy at >100mL	±2	%

\*When dispensed from Aquanex Touch Smart Dispenser with 0.1 μm POU final filter.

\*\*Volumetric Dispense Accuracy at 20-100 mL is ±5%.

**Table 4. Aquanex System ASTM Type II Water Quality**

Parameters	Value	Unit
Conductivity (reference temperature +25 °C)	0.1 - 1.0	μS/cm
Resistance (reference temperature +25 °C)	1 - 10	MΩ·cm
Retention rate for bacteria and particles	99	%
Aquanex RO assembly permeate flow at 25 °C	16 ± 20%	L/hr

## 2.1.4 Tubing Connections for the Aquanex System

**Table 5. List of Tubing Connections for the Aquanex System**

Connection	Tubing OD	Max Distance (m)
Feedwater to Pretreatment	1/4"	3
Pretreatment to Main Unit	1/4"	3
Wastewater (Aquanex 30L)	8 mm	3
Overflow (Aquanex 30L)	8 mm	
Wastewater (Aquanex 10L)	3/8"	3
Overflow (Aquanex 10L)	8 mm	
Main Unit to 30L External Tank	3/8"	1.8
30L External Tank to Main Unit	8 mm	1.8
Dispenser to Main Unit	8 mm	3
Main Unit to Dispenser	8 mm	3

## 2.1.5 Aquanex System Materials in contact with High Purity Water

**Table 6. Aquanex System Materials in contact with High Purity Water**

Component	Material(s) in contact
Pump head	Nylon with glass fiber
UV lamp	High-purity synthetic quartz
UV housing	Stainless steel
DI packs	Polypropylene housing
UF filter	PES (Polyether Sulfone)
Conductivity measuring cell	POM (Polyoxymethylene)
Dispensing valve	PET (Polyethylene terephthalate)
Conductivity measuring cell	POM, stainless steel
Distributor block	POM
Connections	POM
Tubing	PE (Polyethylene)
O-Rings	EPDM (Ethylene propylene diene rubber)
Solenoids	Stainless steel

## 2.2 Product Overview

### 2.2.1 Aquanex Ultrapure Water Purification System Components



**Figure 1. Aquanex Ultrapure 10L and 30L Water Purification Systems**

The Aquanex Ultrapure Water Purification System (see **Figure 1**) is comprised of an automated Water Treatment Unit with intuitive touchscreen interface and an Aquanex™ Touch Smart Dispenser for Type I water.

The system is equipped with either a 10L built-in water storage tank or 30L external water storage tank, based on ordered components.

The dispenser comes with a built-in UI screen that reflects the main display for ease of use and a benchtop dispenser stand which can be transformed into a wall mount stand. Making changes to the smart dispenser UI screen automatically updates information on the main screen of the instrument.

Users can select between manual and volumetric dispense operation. Users can also add an optional second smart dispenser to take advantage of smart dispensing capability on both sides of the system.

The Aquanex System provides flexibility of assembly by supporting both a benchtop or wall-mounted configuration.

The Aquanex System is designed for easy access to consumables to enable quick replacement and hassle-free maintenance. The system comes with one set of consumables, consisting of (1) RO assembly, (1) UV lamp, (2) Aquanex DI packs, (1) UF filter, (1) 0.1 µm Point of Use (POU) filter, and (1) CO<sub>2</sub> adsorber with filter. The system also comes with all feedwater tubes, waste-water drain tubes, disinfectant bypass adapters, sterile overflow, and other necessary fittings for initial setup.

In operation, the source tap water is routed through the pretreatment device into the inlet of the Aquanex System's main unit. From the main unit, the water is routed to Dispenser 1 (D1) or Dispenser 2 (D2) depending on the configuration chosen by the user.

A user can also dispense Type II water by adding a hand-held dispenser. In the 30L system, users can also access Type II water from the tap on the 30L tank.

The Aquanex System helps in protecting the lab environment from leaks in and around the system with a leak detector installed in the main unit. Additionally, the 30L system has a supplementary external leak detector that can be placed at a desired location near the system.

## 2.2.2 Modes of Operation

The unit supports the following modes of operation:

- **Pack saver mode:** The unit automatically operates to increase the lifespan of the Aquanex DI packs based on feedwater quality and average usage.
- **Water saver mode:** Saves water compared to pack saver mode by recycling the RO concentrate waste stream and combining it with source tap water as the feed to the instrument. The waste stream out of the system is reduced in this mode.
- **Dynamic mode:** Intelligently switches between water saver and pack saver modes, depending on the feedwater quality. User can set the transition point.

## 2.2.3 Pretreatment of Feedwater

To meet feedwater quality requirement, (see **Table 7**), it is recommended to use external pretreatment, such as the Barnstead™ Pretreatment System (P/N 50157886). Pretreatment is intended to protect the RO assembly from particles, hardness and to eliminate chlorine that can be present in tap feedwater. Barnstead Pretreatment comes with a built-in pressure reducer to meet the source inlet feedwater pressure requirement for the Aquanex System.

**Note:** Check feedwater quality at regular intervals.

**Note:** Absence of adequate pretreatment and the pressure reducer devices may lead to premature failure of the Aquanex System and its components.

**Note:** It is recommended to rinse new pretreatment cartridges with a few liters of tap water prior to connecting to the Aquanex System.

**Table 7. Feedwater Requirements for Aquanex Ultrapure Water Purification System**

Parameters	Description
Source	Potable tap water
Silt Density Index (SDI)	< 3
Turbidity*	< 1 NTU
Conductivity (reference temperature +25 °C)	Up to 1500 µS/cm (670 Ω·cm)
Hardness*	Hardness stabilized
Chlorine*	Max. 0.1 ppm
pH Range	4 - 11
Temperature	+2 °C to +35 °C
Pressure*	2 to 6 bar / 29 to 87 PSI At Pressure > 6 bar / 87 PSI install a pressure reducer upstream of the system

\* Use of Barnstead Pretreatment System (P/N 50157886) ensures feedwater meets these requirements.



# 3 Description of Features

## 3.1 Description

The Aquanex Ultrapure Water Purification System is an easy-to-use water purification system for use in laboratories. The system comes with several advantageous features as described below.

The Aquanex System includes (1) Aquanex main unit, (1) Touch Type I smart dispenser, (1) set of consumables, and the respective tank (10L internal tank or 30L external tank). The system can also be purchased with Barnstead Pretreatment System. Additional accessories are also available for users to purchase separately.

### 3.1.1 Aquanex Main Unit

#### 3.1.1.1 Front View

The front part of the Aquanex main unit features the Upper Front Panel, Left DI Pack, Right DI Pack, Consumables Access Panel, and a CO<sub>2</sub> adsorber (see **Figure 2**).



**Figure 2. Aquanex Main Unit – Front View**

- **Upper Front Panel:** This panel houses the touch screen display, a USB port, and the Power ON/OFF button.
- **Left and Right DI Packs:** The DI packs can slide in and out of the system. The left and right DI packs are non-interchangeable to provide the correct configuration for deionization and purification. DI packs are labeled A (right) and B (left) to distinguish from each other but are replaced as a set.
- **Consumables Access Panel:** This panel is magnetically held in place. It can be easily removed for access to consumables.

- **CO<sub>2</sub> Adsorber:** The CO<sub>2</sub> adsorber is fitted onto the top of the 10L tank in the 10L in-built main unit for air to pass through the unit without compromising the air quality in the laboratory. For 30L main unit, the CO<sub>2</sub> adsorber is fitted on the 30L tank.

### 3.1.1.2 Side View

The side views show the Side Access Panels as well as the DI Packs Panels (see **Figure 3**).



**Figure 3. Aquanex Main Unit – Left and Right-Side Views**

**Aquanex DI Packs:** Each side of the main unit has one DI pack. These packs are non-interchangeable with each other. The docking slot present at the bottom of the panels help the packs to slide into place.

**Note:** Both the DI packs must be replaced at the same time.

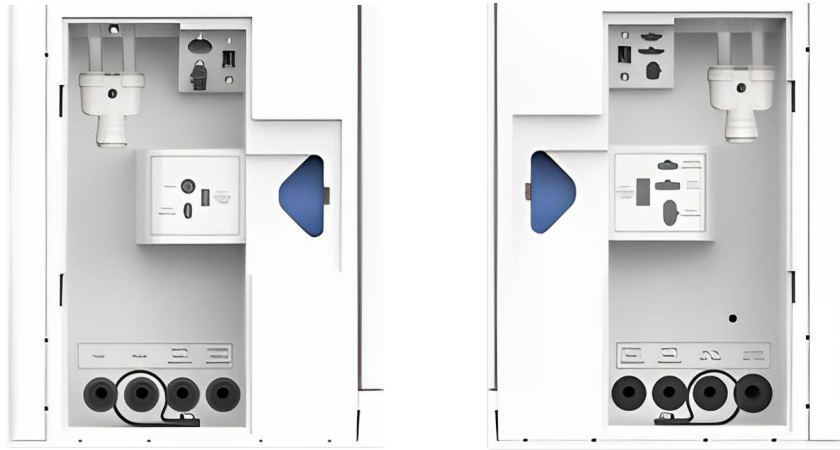
**Side Access Panels:** The side access panels include fluid tubing ports and electrical connection ports on both sides. Type I dispenser tubing ports are available on both the sides of the main unit. The system also has tubing ports to dispense Type II water located on the right-side panel.

The Aquanex system comes with dispenser tubing ports on both left and right side for Type I and Type II (optional) dispenser(s). All dispenser tubing ports come with a bypass installed in them to protect the unit during shipment (see **Figure 4 & Figure 5**).

**Note:** While connecting the dispensers, the user must ensure to remove the bypass from the ports.



**Figure 4. Left and Right-Side Access Panels Removed for Aquanex 10L System**

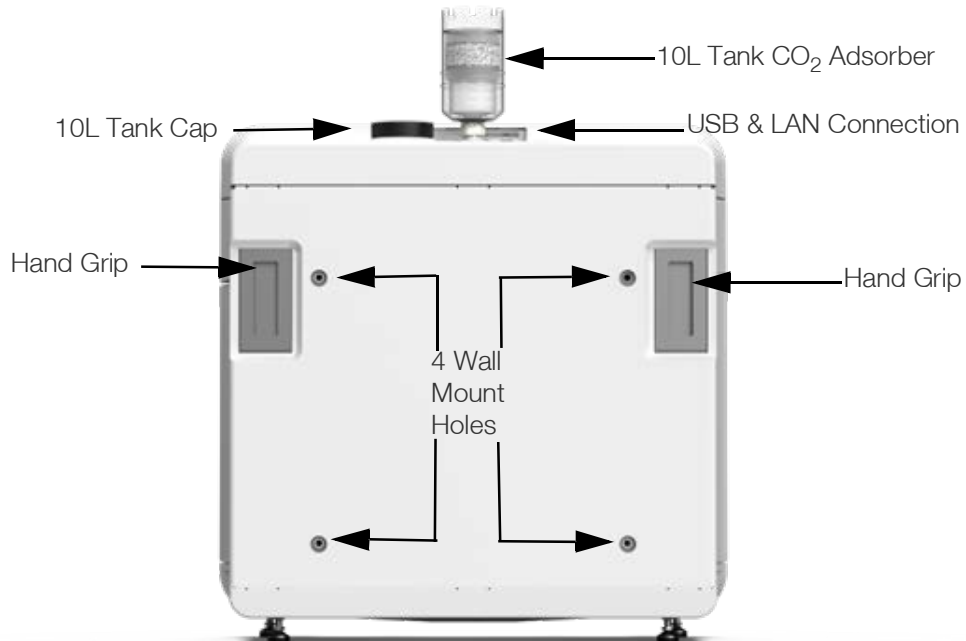


**Figure 5. Left and Right-Side Access Panels Removed for Aquanex 30L System**

### 3.1.1.3 Rear View

#### Exterior View

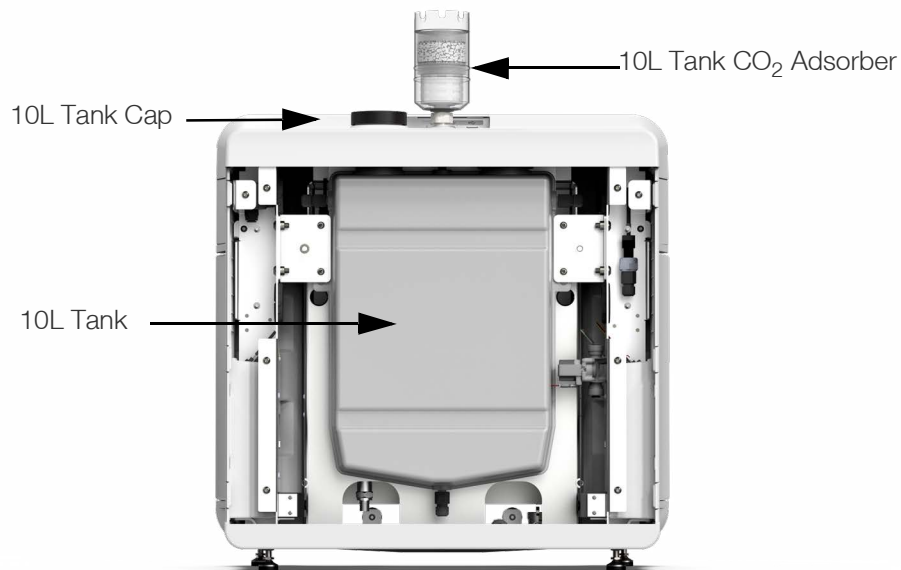
The rear view (see **Figure 6**) has three different connectors for USB and LAN connections. Four wall mount holes for wall mounting and two hand grips to lift the unit are available on the rear side for the ease of handling.



**Figure 6. Aquanex Main Unit – Rear View**

#### Interior View of 10L Main Unit

Within the 10L Main Unit, the 10L water tank is placed at the rear side of the unit (see **Figure 7**).



**Figure 7. Aquanex 10L Main Unit Rear View – Interior 10L Water Storage Tank**

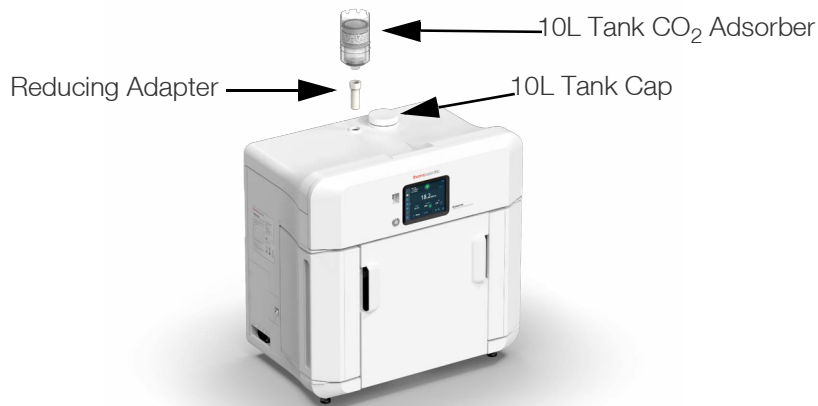
### 3.1.1.4 Top View

Aquanex 10L System main unit top view (see **Figure 8**) has a CO<sub>2</sub> adsorber with sterile filter (0.2 µm), a reducing adapter for the in-built 10L tank and a cap.

Aquanex 30L System comes with an external 30L tank with a CO<sub>2</sub> adsorber and sterile filter and a cap.

**CO<sub>2</sub> Adsorber and Sterile Filter 0.2 µm:** The purpose of the CO<sub>2</sub> adsorber and sterile filter is to prevent carbon dioxide and other particles from entering the water tank, helping to preserve the life of the DI Packs.

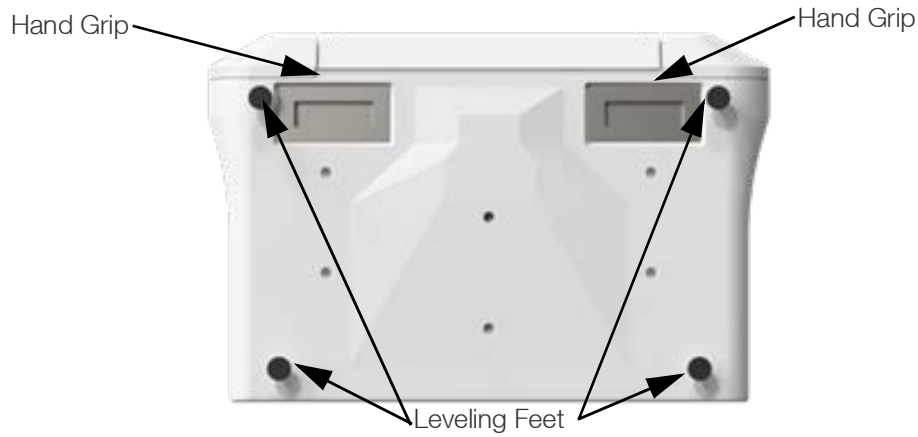
**Cap:** The cap on 10L tank serves the purpose of providing access to the storage tank to initiate disinfection procedure.



**Figure 8. Aquanex 10L Main Unit – Top View**

### 3.1.1.5 Bottom View

The bottom view (see **Figure 9**) shows four leveling feet and two hand grips that help in handling the unit.



**Figure 9. Aquanex Main Unit – Bottom View**

### 3.1.2 System Consumables

The Consumables Access Panel consists of the components: UV lamp, UV lamp housing, RO assembly and UF (see **Figure 10**). The Aquanex DI Packs (see **Figure 11**) are also mounted directly in the main unit for easy access. See **Table 8** below for estimated lifespan of all consumables.



**Figure 10. Aquanex Main Unit with Consumables Access Panel Removed**



**Figure 11. Aquanex DI Pack Consumable**

**Table 8. List of Aquanex Consumables**

Consumables	Part Number	Estimated Lifespan*
RO Assembly	50157608	Up to 12 months
DI Packs	7501050	Up to 12 months
Ultrafilter	50133980	Up to 24 months
UV Lamp	9.1002	Up to 24 months
CO <sub>2</sub> Adsorber with Sterile Filter	06.5002	Up to 12 months
0.1 µm POU Final Filter	50157375	Up to 6 months

\* The actual lifespan of the consumables depends on the quality of the feedwater and the amount of water used by the system.

### 3.1.3 Aquanex Touch Smart Dispenser

The Aquanex Touch Smart Dispenser assembly (see **Figure 12**) consists of a stand with an integrated docking station and a pipette-style dispenser with embedded touch screen display. The dispenser can be used on the benchtop or as a wall-mounted assembly.

The Aquanex Touch Smart Dispenser stand can be maneuvered 360° that allows the user to select the dispense location. The pipette-style dispenser is held to the stand, with magnets and is removable to allow for optimal maneuverability in the lab.

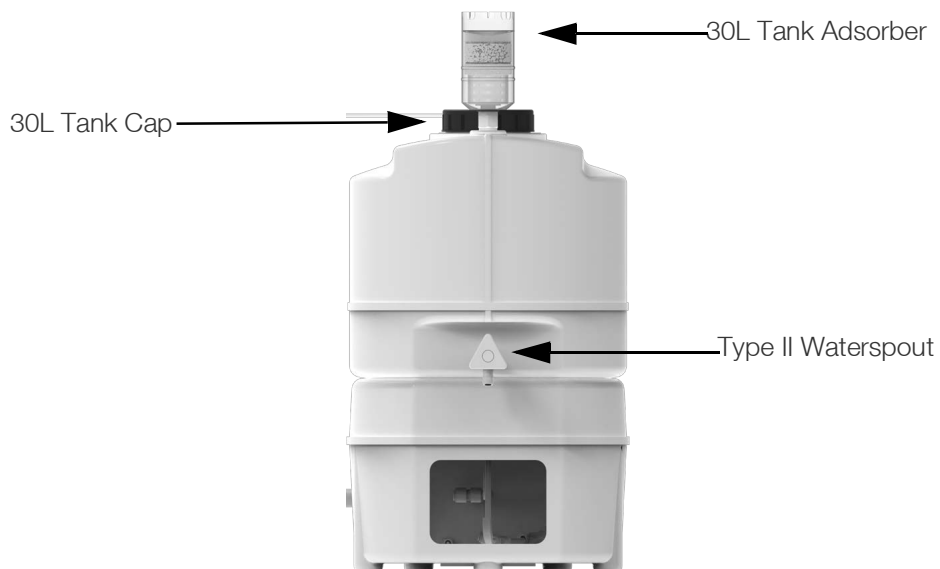
The Aquanex Type I Touch Smart Water Dispenser features a POU User Interface (UI). Using its touch screen display, users can perform various operations with the tap of a thumb. Users can select up to 7 different dispense volumes, 5 dispense flow rates (with a maximum flow rate of 2 L/min), can monitor water quality, and check alarms using the POU UI. The dispenser also includes a 0.1 µm POU filter for high quality particulate filtration.



**Figure 12. Aquanex Touch Smart Dispenser with 0.1 µm POU Final Filter**

### 3.1.4 Optional 30L Tank

The Aquanex 30L System comes with an external 30L water storage tank (see **Figure 13**). In this configuration, the CO<sub>2</sub> adsorber is installed at the top of the 30L tank.



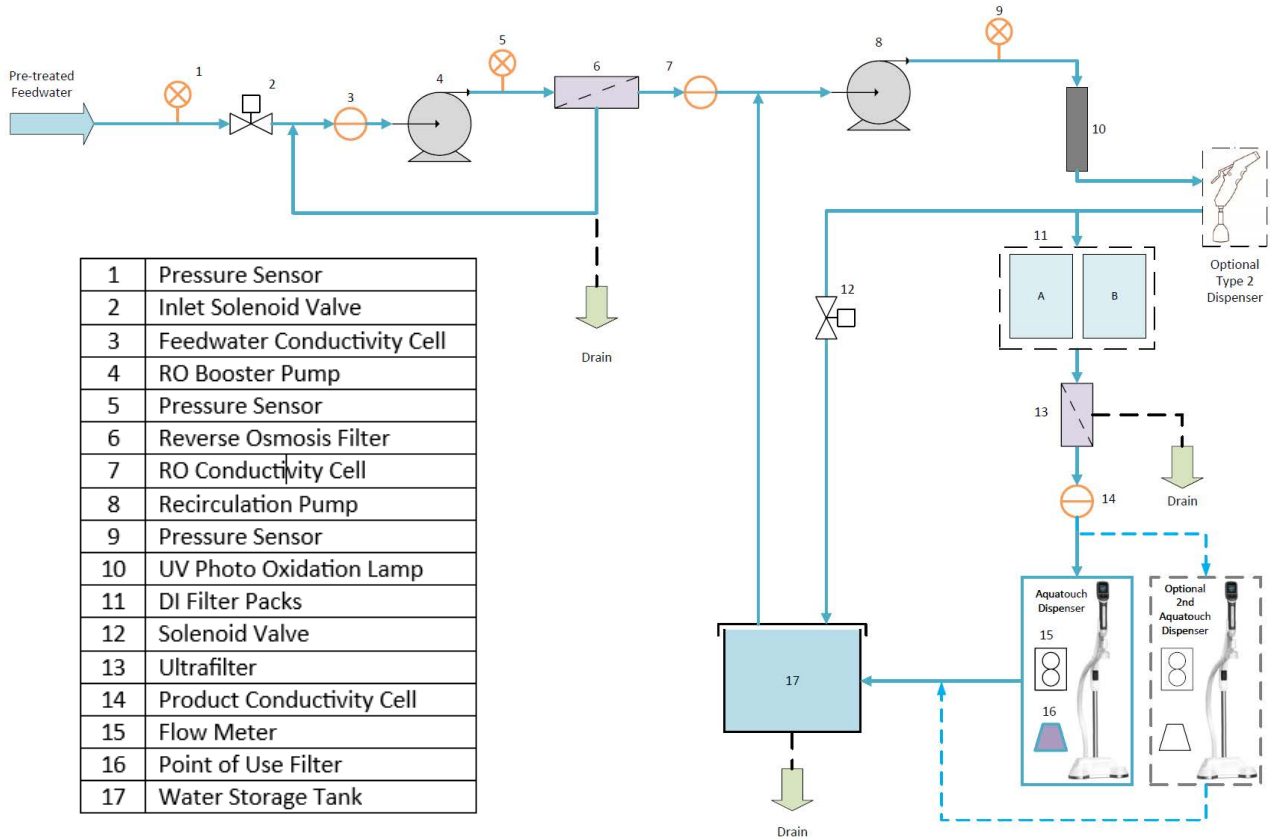
**Figure 13. Aquanex 30L Tank**

### 3.1.5 Optional Type II Dispenser

Both the Aquanex 10L and 30L units allow the dispensing of Type II water from the main unit using a remote hand dispenser. The Aquanex 30L unit also allows dispensing of Type II water from the attached 30L storage tank dispense valve.

The Thermo Scientific Hand Dispenser Kit can be purchased separately, (Catalog Number: 50138221).

### 3.1.6 Flow Diagram



**Figure 14. Aquanex Water Purification System Flow Diagram**



# 4 Installation

## 4.1 Unpacking

### 4.1.1 Unboxing



**DANGER:** Do not put the plastic packaging over your nose or mouth. There is a risk of suffocation. Ensure that you dispose off all the packaging materials properly.

Ensure that the site inspection is completed before receiving the unit and that the site meets all the necessary installation requirements.

The shipping carton must be inspected upon delivery for damage during transport. Lifting and carrying the Thermo Scientific™ Aquanex™ Ultrapure Water Purification System, e.g., to the installation location, must be carried out by two people.

## 4.1.2 Shipping Content List

**Table 9. Aquanex System Shipping List**

Box	Items	P/N	Quantity Included			
			10L Unit		30L Unit	
			710100	7101011	7301030	7301031
Box 1 - 10L	Aquanex Ultrapure 10L Main Unit	274000-A01	1	1		
Box 1 - 30L	Aquanex Ultrapure 30L Main Unit	274500-A01			1	1
Box 1 - Accessory Box	RO Assembly	50157608	1	1	1	1
Box 1 - Accessory Box	Aquanex 110 V US/Japan Power Cord	50132200	1	1	1	1
Box 1 - Accessory Box	Aquanex 220 V EURO Power Cord	50132215	1	1	1	1
Box 1 - Accessory Box	Aquanex 240 V UK/Singapore Power Cord	50132203	1	1	1	1
Box 1 - Accessory Box	Aquanex 230 V Australia/New Zealand Power Cord	274546-A01	1	1	1	1
Box 1 - Accessory Box	Aquanex 220 V China Power Cord	274546-A02	1	1	1	1
Box 1 - Accessory Box	AC/DC Power Supply	274196-001	1	1	1	1
Box 1 - Accessory Box	Universal Adapter (for mounting power pack)	21.1006	1	1	1	1
Box 1 - Accessory Box	Universal Holder (mounting power pack)	21.1007	1	1	1	1
Box 1 - Accessory Box	Nylon Dowel Plug S6 6x30 mm (mounting power pack)	21.0002	2	2	2	2
Box 1 - Accessory Box	Screw DIN 7997 4x35 ZNPL (mounting power pack)	21.0069	2	2	2	2
Box 1 - Accessory Box	Tubing*, LLDPE, ¼" OD, White	18.0137	1	1	1	1
Box 1 - Accessory Box	Tubing*, LLDPE, 8 mm OD, Natural	18.0036	1	1	2	2
Box 1 - Accessory Box	Tubing*, LLDPE, ⅜" OD	274469-001	1	1	-	-
Box 1 - Accessory Box	CO <sub>2</sub> Adsorber and Sterile Vent filter	06.5002	1	1	1	1
Box 1 - Accessory Box	Feedwater Connection Kit	25.0071	1	1	1	1

**Table 9. Aquanex System Shipping List (Continued)**

Box	Items	P/N	Quantity Included			
			10L Unit		30L Unit	
			710100	7101011	7301030	7301031
Box 1 - Accessory Box	Adapter, ¼" Tube to ½" BSP (F)	50157861	1	1	1	1
Box 1 - Accessory Box	Push-connect Release Tool (disconnecting tubing)	274529-001	1	1	1	1
Box 1 - Accessory Box	USB drive with User Manual	274473-A01	1	1	1	1
Box 1 - Accessory Box	Aquanex™ Quick Reference Guide	274006-001	1	1	1	1
<b>CO<sub>2</sub> Filter Mounting Accessories</b>						
Box 1 - Accessory Box	90° Elbow Adapter, ½" NPT (M) x ½" NPT (F)	274538-001	1	1	-	-
Box 1 - Accessory Box	Bushing Adapter, ½" NPT (M) x ¼" NPT (F)	274539-001	1	1	-	-
Box 1 - Accessory Box	Straight Adapter, 8mm Push-Fit to ¼" BSPP (F)	274142-001	1	1	-	-
Box 1 - Accessory Box	Straight Reducing Adapter	274540-001	1	1	-	-
Box 1 - Accessory Box	Cable Tie	274541-001	2	2	-	-
Box 1 - Accessory Box	Adhesive-Backed Cable Tie Mount	274542-001	2	2	-	-
Box 1 - Accessory Box	90° Tubing Bend Guide (8 mm)	50147529	1	1	-	-
Box 2	Aquanex DI Packs Set	7501050	1	1	1	1
Box 3	Aquanex Touch Smart Dispenser and Stand	7601040	1	1	1	1
Box 3	0.1 µm POU Filter	50157375	1	1	1	1
Box 4 - 30L Only	Aquanex 30L Tank Assembly	7301035	-	-	1	1
Box 4 - 30L Only	Sterile Tank Overflow	06.5001	-	-	1	1
Box 4 - 30L Only	External Leak Sensor	274483-A01	-	-	1	1
Box 5 - Optional	Barnstead Pretreatment System	50157886	-	1	-	1

\*Replacement tubing is sold by foot.

## 4.1.3 Examination on Receipt

Open the boxes carefully and ensure that all the parts have been received before the packaging materials are discarded.

Ensure that all the required components for the Aquanex System have been received. The following items are packed in separate boxes:

**Box 1:** Aquanex™ Ultrapure Water Purification Main Unit including Accessory Box.

**Box 2:** Aquanex™ Touch Smart Dispenser (Type I), Stand and 0.1 µm POU filter.

**Box 3:** Aquanex™ DI packs.

**Box 4:** Aquanex™ 30L Water Storage Tank (included with Aquanex 30L units only).

**Box 5:** Barnstead Pretreatment System (included with SKU 7101011 and 7301031 only).

**Note:** Barnstead Pretreatment System (P/N 50157886) is the recommended pretreatment to use with the Aquanex Systems and can be purchased separately or as a part of the complete system. Check order to ensure that this was received. Otherwise, suitable pretreatment is required for proper functioning of the system.

Additional accessories can be purchased, including:

- Wall bracket for Aquanex™ System (if wall mounting) (P/N 7601060)
- Hand Dispenser Kit for Type II water (P/N 50138221)

Carefully unpack the system and inspect for any damage. Use proper PPE and be careful while using sharp instruments to remove packaging. If any items are missing or damaged, please contact Thermo Fisher Scientific.

**Note:** To claim shipping damages, respond within 6 days of the time of receipt of the goods.

## 4.2 Location Requirements

### 4.2.1 Installation Location Requirements

The area, wall, and/or bench where the Aquanex System, to be placed, must be inspected properly prior to installation to determine structural integrity, sufficient to hold the weight of the system, and the area allows for proper clearances, as defined in **Table 1**.

**Note:** The operator is obligated to ensure that the installation of the water purification unit and its operations are carried out in compliance with all national and international guidelines, applicable and valid for the place of installation.

#### 4.2.1.1 Site Installation Requirements

Consider the following requirements while selecting the installation area:

- Determine the best layout of the system to fit lab space and allow recommended clearance. Place the Aquanex System and the storage tank (in case of external 30L tank) at the desired location.

**Note:** Space requirements for the system components are listed in **Table 1**.

**Note:** The 30L tank must be installed at the same height or higher than Aquanex System.

- Ensure that the bench or wall supports the weight of the Aquanex System (see **Table 1**).
- Ensure that the surface, on which the system is installed, is level and even. It must not exceed a maximum deviation of 2% from level.

**Note:** A smooth wall is required when the system is wall-mounted.

- Set or mount Barnstead or other pretreatment, Aquanex System, Aquanex Touch Smart Dispenser and 30L Tank (if applicable) in their final position.

**Note:** If the pretreatment system is wall-mounted, refer to **Barnstead Pretreatment System** manual for instructions.

## 4.2.1.2 Ambient System Operation Requirements

**Table 10. Aquanex System Operation Conditions**

Parameters	During Operation
Operation area	Indoor rooms
Maximum altitude above sea level	up to 2000 m
Temperature range	2 °C to 40 °C, 80% rH, non-condensing
Line-voltage variation	Not more than $\pm 10\%$ of the line voltage
Transient over voltages*	As usually occur in the supply network (over-voltage category II acc. to IEC 60364-4-443)
Ventilation requirements	No specific requirements
Degree of pollution	2

\*The rated level of transient over-voltage is the withstand impulse voltage acc. to over-voltage category II of IEC 60364-4-443.

## 4.2.1.3 Electrical Requirements

- System is supplied with a power supply and plug options. Use only supplied plug for installation.
- User must provide a grounded AC 100 - 250 V, 50 - 60 Hz, 2.0 A max electrical outlet within 2 m (6 ft) of the installation location.

## 4.2.1.4 Other Requirements

- Refer to **Table 7** for feedwater requirements.

**Note:** Barnstead Pretreatment built-in pressure reducer comes at a preset of 50 PSI.

- A drain with an outside diameter of 63 mm (2.48 inch) (DN 50 tube) is required.

**Note:** Make sure that the gravity flow to the drain is unrestricted.

- The maximum tube distance between system and storage tank should be 1.8 m (71 inch).
- The minimum tube distance between the system and storage tank should be 0.5 m (20 inch).

## 4.3 Installation

### 4.3.1 Installation Configurations

The Aquanex Ultrapure Water Purification System is customizable for the laboratory space available. Each part of the system is positioned easily on a benchtop, or wall mounted to save space.

**Note:** The 30L tank must be positioned at the same height or higher than the 30L main unit for operation. Ensure that the tank is not installed below the unit.

### 4.3.2 Benchtop Installation



**Figure 15. Benchtop Installation of 10L Aquanex Main Unit with 2 Touch Smart Dispensers and the Barnstead Pretreatment Box**

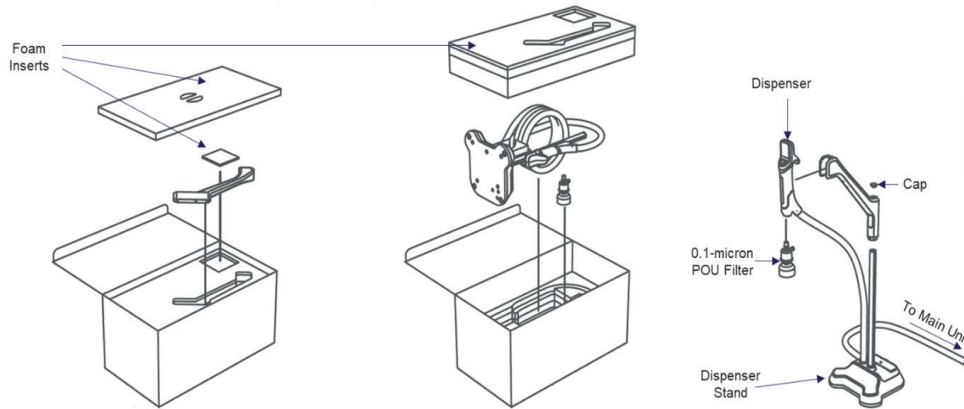
#### 4.3.2.1 Aquanex Main Unit

Ensure that the surface on which the system is installed is level and stable and can support the weight of the Aquanex System at full capacity (see **Table 1**). The benchtop must not exceed a maximum deviation of 2% from level.

- Position the Aquanex Main Unit on the benchtop in the desired position.
- Make sure that the gravity flow from the waste and overflow lines is unrestricted, downward flow to an atmospheric drain.
- Make sure that a grounded electrical outlet is within 2 m (6 ft) of the installation location.

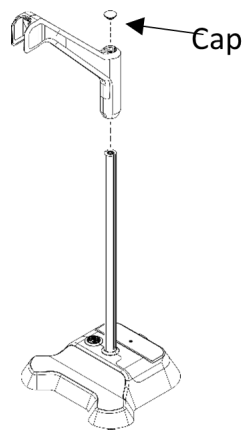
### 4.3.2.2 Aquanex Touch Smart Dispenser

Aquanex Touch Smart dispenser is a Type I water dispenser which comes as a standard accessory for all Aquanex Systems. The assembly consists of a smart dispenser, a dispenser arm, and a stand post (See **Figure 15**).



**Figure 16. Unpacking the Aquanex Touch Smart Dispenser**

- Place the Aquanex Touch Smart Dispenser and its components on the benchtop.
- Unscrew the cap from the top of the stand post.
- Press the button on the dispenser arm and slide it down the stand post (See **Figure 17**).
- Screw the cap on the top of the stand post.
- Gently place the dispenser handle into the magnetic cradle on the stand arm.



**Figure 17. Assembly of the Aquanex Touch Smart Dispenser**

### 4.3.2.3 Optional 30L Tank

Install the 30L water tank on the benchtop at the desired position to the right of the Aquanex Main Unit.

**Note:** The 30 L tank must be installed at same height or higher than Aquanex System.

**Note:** The maximum tube distance between the system and the storage tank should be 1.8 m (71 inch).

**Note:** The minimum tube distance between the system and the storage tank should be 0.5 m (20 inch).

## 4.3.3 Wall Mount Installation



**Figure 18. Installation of Aquanex 10L Main Unit with wall mounted Aquanex Touch Smart Dispenser**

### 4.3.3.1 Aquanex Main Unit



**CAUTION:** The wall mounting bracket is purchased as an optional accessory. Before mounting the system on the wall, verify the strength of the wall to ensure that it is suitable for supporting the system



**CAUTION:** The screws and anchors supplied with the wall mounting brackets are only suitable for attaching the wall mounted bracket to a 16-inch wooden stud construction, concrete, or solid masonry wall.



**CAUTION:** Always lift and carry the system in tandem (with two people), never alone, to avoid any risk of injury. Lift the system using the handles on the bottom and back of the unit.

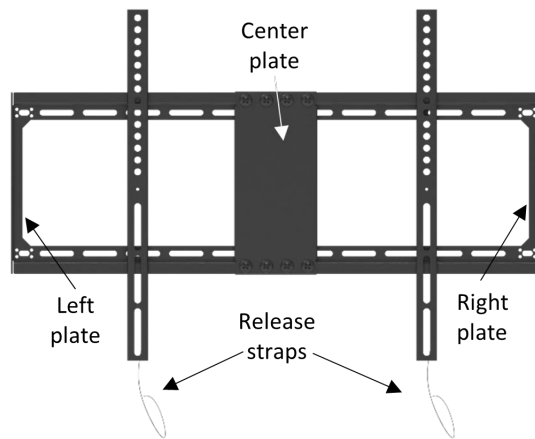


**WARNING:** Only use the wall mounting bracket and hardware provided by the manufacturer.



**CAUTION:** Improper installation can lead to water leakage and slippery surfaces. Please follow instructions carefully.





**Figure 19. Fully Assembled Wall Plate for Wall Mounting the Aquanex Main Unit**

**Wall Mounting the Aquanex Main Unit:**

**Pre-Installation:** Follow the instructions provided with wall mount accessory (P/N 7601060), to assemble the wall plate. Anchor the assembled wall plate to the wall (concrete or wood-based wall) following the guidelines below.

- **Step 1:** Attach both the wall mount brackets to the back of the Aquanex Main Unit (see **Figure 20**).
  - Insert the thin and thick spacer provided with wall bracket in the 4 screw locations.
- **Step 2:** Hang the top hooks of the brackets over the top bars of the assembled wall plate. Make sure the hooks securely hang in the bars.
  - Make sure that the release straps of the wall mount hangs down.

**Note:** While handling the unit, make sure that at least two people lift the unit.

- **Step 3:** Attach the lower ends of the brackets to the lower bars of the assembled wall plate. Pull down release straps to lock the brackets in the bars.

To remove the unit from the wall, pull both the release straps at the bottom of the mounting brackets to release the hooks from the top bar. Lift the unit slightly and pull away from the wall bracket. **To avoid injury, this MUST be done with at least two people.**



**Figure 20. Wall Mount Brackets on the back of the 10L Aquanex Main Unit**

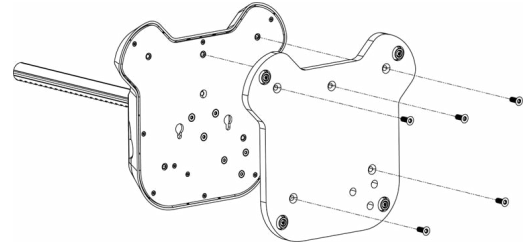
### 4.3.3.2 Aquanex Touch Smart Dispenser

Aquanex Touch Smart Dispenser is a Type I water dispenser which comes as a standard accessory for all Aquanex Systems. The assembly consists of a smart dispenser, a dispenser arm, and a stand post (see **Figure 15**).

**Note:** This process requires a use of Torx-drivers in sizes T10, T25, and T30. The wall on which the dispenser is to be mounted must have an adequate load-carrying capacity.

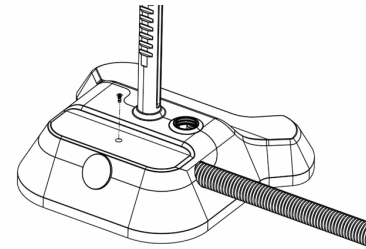
#### Place the Aquanex Touch Dispenser and its components on the benchtop.

- a. Position the stand on its back, exposing the stainless-steel weight at the bottom. Remove the weight by unscrewing the five (5) M6 Torx screws holding the weight onto the stand (see **Figure 21**). Keep the screws in a safe place for future use.



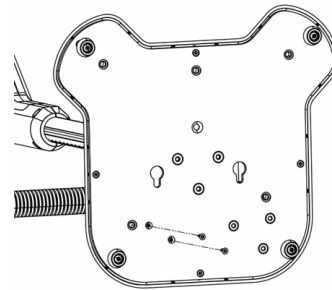
**Figure 21. Remove the Weighted Base**

- b. Place the stand back in an upright position. Remove the dispenser stand base cover by unscrewing the M3 Torx screw from the top of the base and lifting the edges of plastic cover away from the rest of the base (see **Figure 22**).



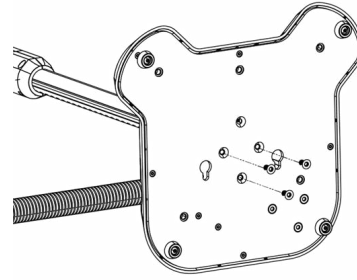
**Figure 22. Plastic Cover of the Dispenser**

- c. After removing the base cover, take out the benchtop configuration hole plug from the back of the base. Keep the screws in a safe place for future use.
- d. Again, lay the stand on its back to expose the bottom plate. Unscrew the two (2) M3 Torx screws as shown in **Figure 23** and remove the base corner mount bracket from inside the stand base.



**Figure 23. M3 Torx Screws on Base**

- e. Unscrew the three (3) M5 Torx screws shown in **Figure 24** to release the stand post from its vertical position. Gently move the post back and forth to release it.



**Figure 24. M5 Torx Screws**

- f. Place the stand post into the slot at the back of the base as shown in **Figure 25**. Ensure that the mounting holes in the post holder are aligned with the corresponding mounting holes in the base plate and attach the post with the three (3) M5 Torx screws removed in **Step E**.



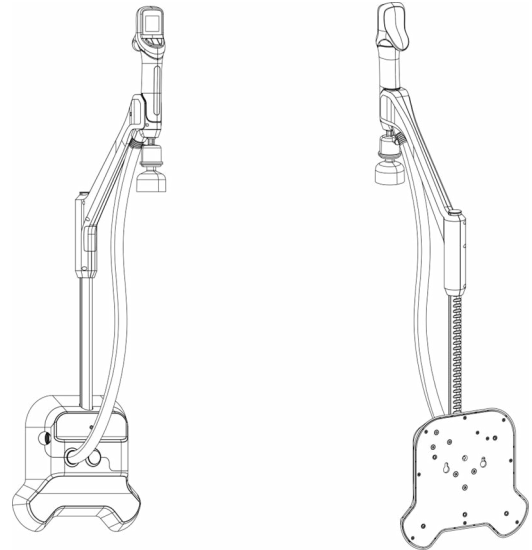
**Figure 25. Stand laid back for Wall Mounting**

- g. Reassemble the base corner bracket in its position by reinstalling the two (2) M3 screws removed in **Step D**.
- h. Install the wall mount configuration hole plug (present in the accessories kit) to cover the opening where post was located before.
- i. Replace the base cover and make sure that no tubing is pinched. Reinstall the (1) M3 Torx screw removed in **Step A** on the base cover.
- j. Unscrew the cap from the top of the stand post and install the dispenser arm holder by pressing the button and sliding it onto the post. Screw the cap back onto the top of the stand post.

k. Place the Aquanex Touch Dispenser on the wall using two (2) supplied screws.

**Note:** Before putting the screws into the wall, measure the distance between the two mounting holes on the dispenser base to ensure that the screws are placed appropriately.

l. Hang the dispenser on the dispenser stand arm by gently placing it into the magnetic cradle.



**Figure 26. Wall Mount configuration of the Aquanex Touch Smart Dispenser**

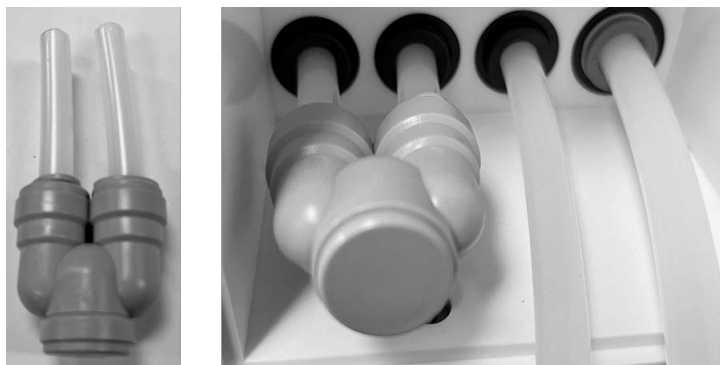
## 4.4 Connecting Aquanex System

### 4.4.1 System Connections

The Aquanex System comes with electrical connection ports and fluid tubing ports on both left and the right side for Type I (D1 & D2) dispenser and Type II (optional) hand dispenser, on right side only.

**Note:** Identify the location of the plumbing connections for the Aquanex 10L and 30L Systems before cutting any tubing for installation.

Dispenser ports come with dispenser bypass accessories installed (see **Figure 27**). These must remain assembled if not using a dispenser on that side of the unit to prevent water leaks.



**Figure 27. Dispenser Bypass installed in Aquanex Main Unit**

## 4.4.1.1 Aquanex 10L System Connections

Dispenser bypasses must be in dispenser ports that are not in use.

Overflows and system waste drains must be connected to atmospheric drains.

- a. Feedwater (1/4" OD)
- b. Out to Type I Dispenser (D1; 8 mm OD)
- c. In from Type I Dispenser (D1; 8 mm OD)
- d. In from Type I Dispenser (D2; 8 mm OD)
- e. Out to Type I Dispenser (D2; 8 mm OD)
- f. Overflow waste drain (8 mm OD)
- g. System waste drain (3/8" OD)
- h. 24 VDC system power port
- i. Type I Dispenser USB port (D1)
- j. Type I Dispenser USB port (D2)
- k. External Leak Sensor (optional)
- l. Type I Dispenser (D1) 6-pin power port
- m. Type I Dispenser (D2) 6-pin power port



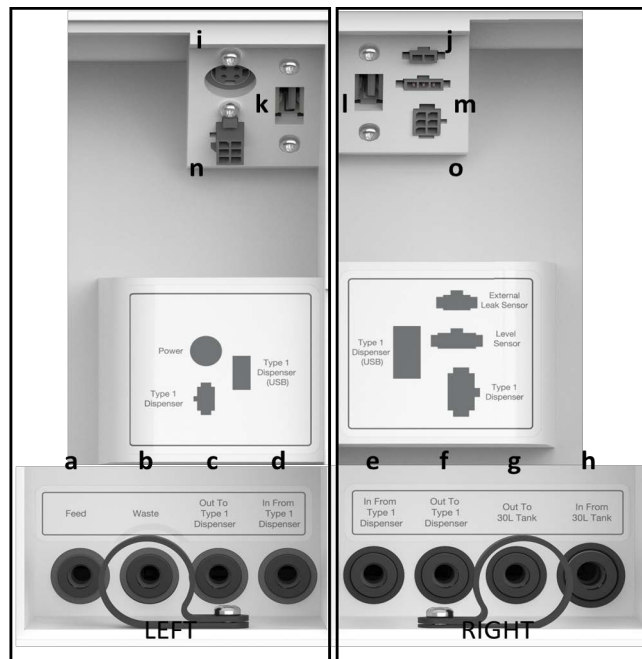
**Figure 28. Aquanex 10L System Connections – Annotated**

## 4.4.1.2 Aquanex 30L System Connections

Dispenser bypasses must be in unused ports.

Overflows and system waste drains must be connected to atmospheric drain.

- a. Feedwater (1/4" OD)
- b. System Waste drain (8 mm OD)
- c. Out to Type I Dispenser (D1; 8 mm OD)
- d. In from Type I Dispenser (D1; 8 mm OD)
- e. In from Type I Dispenser (D2; 8 mm OD)
- f. Out to Type I Dispenser (D2; 8 mm OD)
- g. Out to 30L Tank (8 mm OD)
- h. In from 30L Tank (3/8" OD)
- i. 24 VDC system power port
- j. External Leak Sensor
- k. Type I Dispenser USB port (D1)
- l. Type I Dispenser USB port (D2)
- m. 30L Tank Level Sensor
- n. Type I Dispenser (D1) 6-pin power port
- o. Type I Dispenser (D2) 6-pin power port



**Figure 29. Aquanex 30L System Connections – Annotated**

## 4.4.2 Water Connections

Ensure that an appropriate pretreatment system and pressure reducer is installed upstream of the Aquanex System so that feedwater meets system specifications.

**Note:** Thermo Fisher recommends the Barnstead Pretreatment System (P/N 50157886) to ensure that the feedwater meet system requirements.

**Note:** To ensure a leak free connection, use a tube cutter to ensure that the ends of tubing are flat and free of burrs. Push the tubing into each fitting 12 - 13 mm (½") until the tubing locks in place.



**CAUTION:** Improper installation can lead to water leakage and slippery surfaces. Please follow instructions carefully.

### 4.4.2.1 Connecting Aquanex Main Unit to Barnstead Pretreatment Box

Refer to **Barnstead Pretreatment (P/N 50157886) user manual** for complete installation instructions.

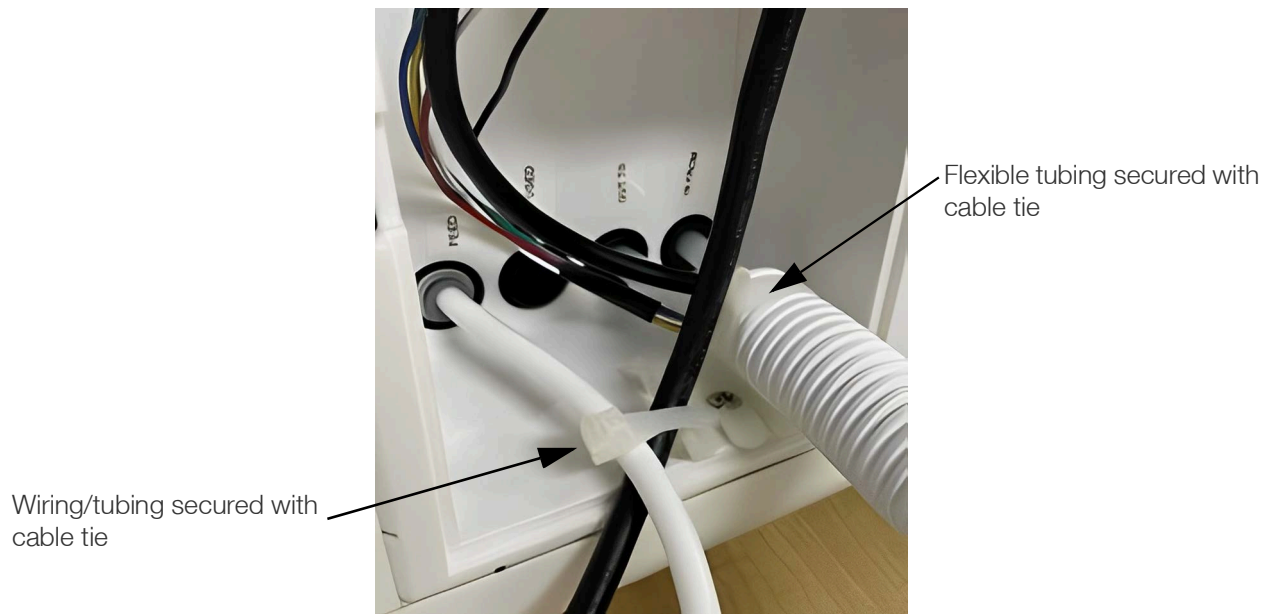
- a. Push-connect the ¼" OD tube to the "Water Inlet" port located on the right side of Barnstead Pretreatment System.
- b. Use fitting supplied with Barnstead Pretreatment System to connect the other end of the ¼" outer diameter tube to the tap.
- c. Remove the side access panel from the left side of Aquanex System.
- d. Use ¼" OD tube to push connect to the "Water Outlet" port, located on the left side of the Barnstead Pretreatment System, to the feedwater port on the left side of Aquanex Unit.

**Note:** Tube length between pretreatment and Aquanex Unit should not be more than 3 m (10 ft).

**Note:** Pretreatment cartridges should be rinsed prior to use with the Aquanex System. Flush with up to 1 L of water through the pretreatment system to the drain before connecting tubing to inlet port.

### 4.4.2.2 Connecting Aquanex Main Unit to Aquanex Touch Smart Dispenser

- a. Remove the side access panels of the main unit to expose all fluid and electrical ports.
- b. Remove the selected Dispenser Bypass (see **Figure 27**).
- c. All dispenser water tubings and electrical connections are bundled together inside the white flexible tube attached to the dispenser, ready to connect with the main unit.
- d. Connect the dispenser inlet tube to the "OUT to Type I Dispenser" port and the recirculation water return tube from the dispenser to the "IN from Type I Dispenser" port of the main unit.
- e. Connect the 6-pin power connector to the Type I Dispenser power connection port.
- f. Connect the USB connector of the dispenser to the Type I Dispenser USB port.
- g. The Aquanex Touch Smart Dispenser is now connected to the Main Unit.



**Figure 30. Securing Tubing with Cable Ties**

**Note:** This procedure is same irrespective of the side to which the dispenser is being connected.

#### 4.4.2.3 Connecting Aquanex Main Unit to 30L Tank

- Connect the 8 mm tubing between the “OUT to 30L Tank” port of the main unit and the tank inlet.
- Connect 3/8" tubing between the “IN from 30L Tank” port of the main unit and the tank outlet.
- Connect tank level sensor cable to the “Level Sensor” connector on the main unit.
- Connect the external leak sensor cable to the “External Leak Sensor” port.
- Place the leak detector either beneath the tank or near a convenient place to detect any external leaks.

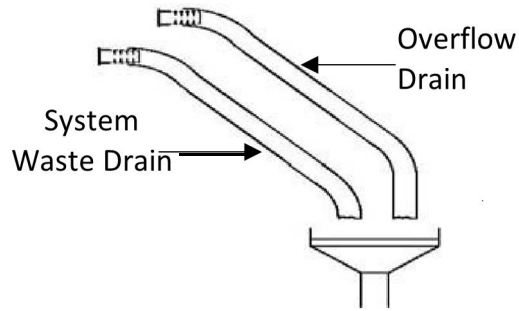
#### 4.4.2.4 Routing Tubes from Aquanex System Overflow and Drain Ports

**30L Only:** Mount the tank overflow as described in the given Installation Guide.

Connect the tubing as follows from the waste/overflow ports to drain:

- 10L Overflow (from Main Unit): 8 mm
- 10L System Waste (from Main Unit): 3/8"
- 30L Overflow (from 30L External Tank): 8 mm
- 30L System Waste (from Main Unit): 8 mm





**Figure 31. Waste and Overflow Tubing Configuration**

Route all drains with a downward slope and without any kinks or restrictions, as it may result in backing the draining water into the storage tank.

If a standard drain siphon is in place, the ends of the tubes must be located at least 20 mm (0.75 inch) above the drain. Make sure that the tubes remain in position after being attached.

#### 4.4.2.5 Connecting Aquanex Main Unit Type II Hand Dispenser

Connect the optional Type II remote hand dispenser (P/N 50138221) to the Dispenser Flow and Dispenser Back Flow connector on right side of Aquanex System.

### 4.4.3 Tank Connections

#### 4.4.3.1 Install Aquanex 10L CO<sub>2</sub> Adsorber and Sterile Filter

CO<sub>2</sub> adsorber and sterile filter for Aquanex 10L can be adapted for three different configurations depending on the space above the unit. The three configurations are as follows (see **Figure 32**):



**Figure 32. Optional Configurations for CO<sub>2</sub> adsorber installed on 10L Tank**

### Vertical Installation:

- a. Screw the filter into the custom adapter on the top of the main unit.

### Horizontal Installation:

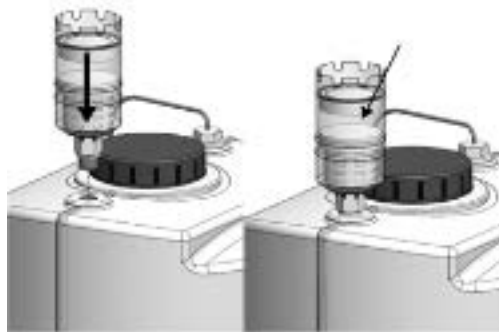
- a. Screw the 90° elbow adapter (provided in the accessory box) onto the filter.
- b. Stick the adhesive-backed cable tie mounts (x2) on the top of the unit at a distance of 3.5 inch and 5 inch from the custom adapter.
- c. Screw the filter assembly (filter plus elbow adapter) to the custom adapter on the main unit.
- d. Tighten the filter assembly and ensure that it aligns with the adhesive-backed cable tie mounts.
- e. Secure the CO<sub>2</sub> adsorber and sterile filter with cable ties (x2).

### Side-Hang Installation:

- a. Push to connect the straight reducing adapter (provided in the 10L accessory box) to the CO<sub>2</sub> adsorber and sterile filter.
- b. Attach the 90° elbow adapter to the custom adapter.
- c. Screw the bushing adapter to the 90° elbow adapter.
- d. Connect the straight adapter (with push-to-connect tubing) to the bushing adapter.
- e. Connect the CO<sub>2</sub> adsorber and sterile filter to the adapter on the main unit using a piece of 8 mm tubing.
- f. Stick the adhesive-backed cable tie mount (x2) to the side wall beneath the hanging location of the CO<sub>2</sub> adsorber and sterile filter. Secure the CO<sub>2</sub> adsorber and sterile filter with the cable ties (x2).

## 4.4.3.2 Install Aquanex 30L System CO<sub>2</sub> Adsorber and Sterile Filter

Remove the plug from top of the tank and thread CO<sub>2</sub> adsorber and sterile filter into place (see **Figure 33**).

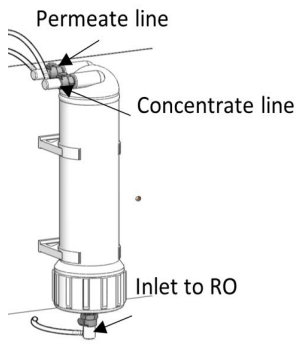


**Figure 33. 30L Tank Plug and CO<sub>2</sub> adsorber Installation**

## 4.4.4 RO Assembly

The RO assembly must be properly installed to protect DI Pack longevity.

- a. Locate the RO Assembly in the accessory box.
- b. Remove the magnetic front panel from the system and place the RO assembly into the mounting clips.
- c. Plug the three quick connectors into the RO assembly as shown in **Figure 34**. The connectors are secured when an audible “**click**” can be heard.



**Figure 34. RO Assembly and Quick Connections**

**Note:** After installation, all tubing must be checked for their correct positioning on the systems panel. Ensure that no leakage or blockage occurs after opening the feedwater supply.

## 4.4.5 DI Packs

- a. Locate the right (A) and left (B) DI packs.
- b. Match the label (A or B) on the DI pack with the corresponding label (A or B) on the Aquanex Unit.
- c. Align the appropriate DI pack with docking slots and slide towards the back of the unit until it clicks into place (see **Figure 35**).

**Note:** The DI packs are designed to be installed in only one configuration. Match the labels when installing the DI packs to ensure proper operation of the unit.



**Figure 35. DI Pack Insertion in 10L Aquanex Main Unit**

## 4.4.6 0.1 $\mu\text{m}$ POU Final Filter

Follow the instructions below to install 0.1  $\mu\text{m}$  POU Final Filter:

- a. To install 0.1  $\mu\text{m}$  POU filter, screw the filter into the point of dispense location of the Aquanex Touch Smart Dispenser.
- b. When the system is turned ON, dispense the water through the POU filter.
- c. Release air from filter by slightly loosening the white knurled screw.
- d. Close the knurled screw and ensure not to overtighten.
- e. To rinse, dispense the water through the 0.1  $\mu\text{m}$  POU filter for 10 minutes or until the tank is empty.



**Figure 36. Aquanex Touch Smart Dispenser with 0.1  $\mu\text{m}$  POU Final Filter**

# 5 Operation

## 5.1 Initial Startup

### 5.1.1 Powering the Aquanex System

Do not plug system into power supply until all the DI packs, RO Assembly and filters are installed, and system is ready for startup.



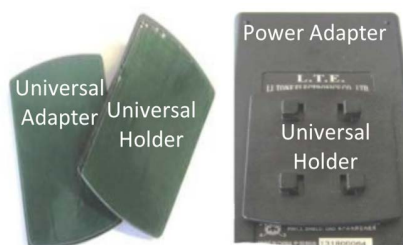
**CAUTION:** Make sure that all connections are made as per Installation Instructions.



**DANGER:** Risk of an electrical shock. Make sure that the suitable plug and the power cable do not get wet. Mount the AC/DC external power supply with dry hands.

#### 5.1.1.1 Mounting the AC/DC External Power Supply

- Remove the protective foil from the back of the universal holder and from the universal adapter. Connect the male universal holder to the center of the back of the main power adapter (see **Figure 37**).
- Connect the female universal adapter to a smooth wall surface or screw it to the wall (screws not provided).
- Take the universal holder side of the power supply unit and press it into the universal holder on the wall and then slide it down.



**Figure 37. Universal Holder and Universal Adapter for Mounting the AC/DC Power Supply**

**Note:** If possible, mount the AC/DC external power supply on the wall to the left or right of the water purification system where it is easily accessible and does not come in contact with water.

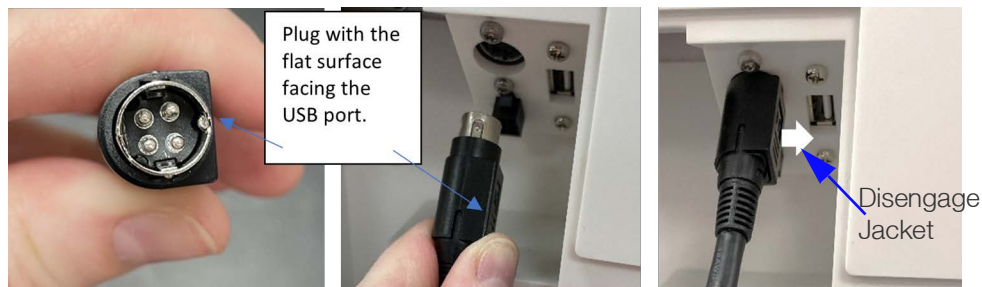
## 5.1.1.2 Powering the Aquanex System



**DANGER:** Do not bring the AC/DC external power supply in contact with water. There is risk of an electrical shock.

- a. Plug the country specific appropriate power cable (See accessory box) into the power supply unit.
- b. Connect the power supply cable to the “Power supply” connection on the right side of the Aquanex Unit.

**Note:** The power supply male connection is designed to connect with the female connection (installed in the Aquanex Unit) in only one position. Refer to **Figure 38** to follow the correct positioning. Connecting the power supply in other positions may damage the connector.



**Figure 38. Connecting Power Cable to the Aquanex Main Unit**

- c. Plug the power supply into a grounded 100 - 240 V, 50/60 Hz power outlet.

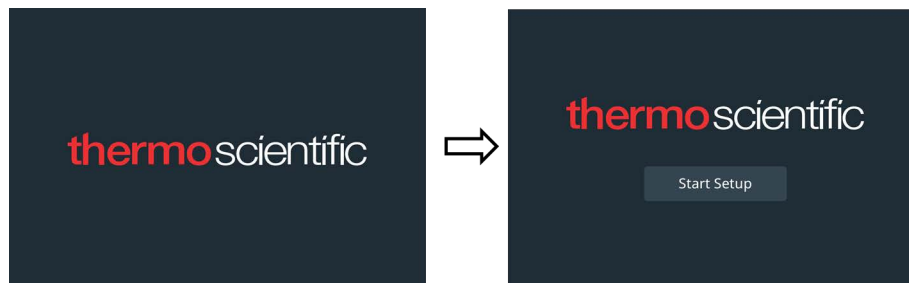
**Note:** Removing the power cord, does not disconnect the power cable from the main unit. To disconnect the power supply from the main unit, simply pull the “Disengage Jacket” downward (see **Figure 38**). The Disengage Jacket will slightly slide downward. Keep pulling the “Disengage Jacket” to uncouple power supply from the main unit.

## 5.1.2 GUI Startup

### 5.1.2.1 Initial Setup


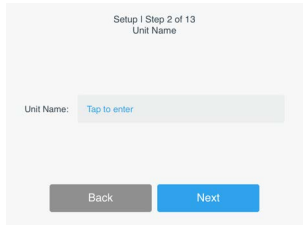
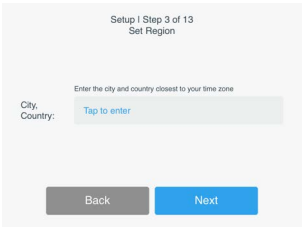

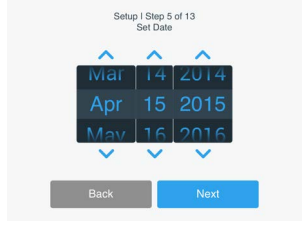
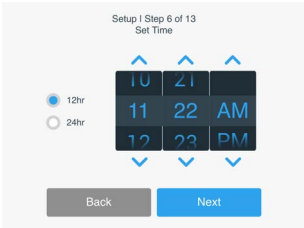
For initial start-up, there is a series of screens that display the settings to be done step by step to complete the initial set up.

Turn on the power switch of the Aquanex System. The power-up screen with the Thermo Scientific logo appears followed by a screen with the **Start Setup** button (see **Figure 39**).

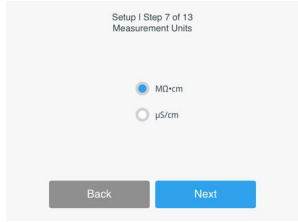

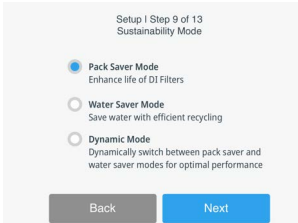
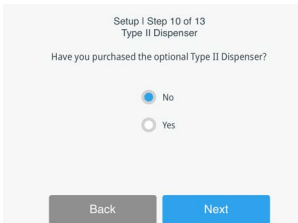
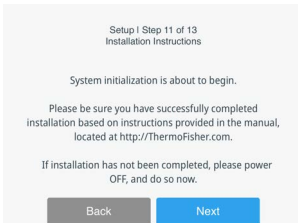



**Figure 39. Initial Startup Screen**

**Table 11. Initial Setup Instructions**

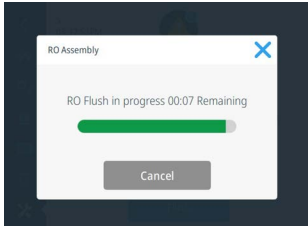

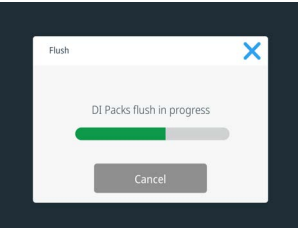
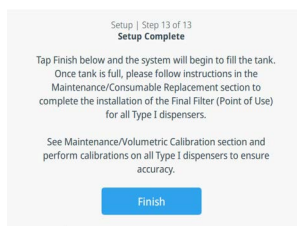
Step No.	Description	Screens
1	<p>Tap <b>Start Setup</b>. A wheel picker to set language appears.</p> <p>Select the preferred language (English is set by default).</p> <p>Tap <b>Next</b>.</p>	
2	<p>The <b>Setup: Unit Name</b> screen appears.</p> <p>Give the unit a name, with a maximum of 20 characters. The special characters allowed are dash (-) and underscore (_).</p> <p>Tap <b>Next</b>.</p>	
3	<p>The <b>Setup: Set Region</b> screen appears.</p> <p>Enter the city and country closest to your time zone.</p> <p>Tap <b>Next</b>.</p>	
4	<p>The <b>Setup Date Display Format</b> screen appears.</p> <p>Select the preferred format.</p> <p>Tap <b>Next</b>.</p>	
5	<p>The <b>Set: Date</b> screen appears.</p> <p>Use the wheel picker on the screen to specify the current date.</p> <p>Tap <b>Next</b>.</p>	
6	<p>The <b>Setup: Set Time</b> screen appears.</p> <p>Choose between <b>12 hr</b> and <b>24 hr</b>. Use the wheel picker to select the correct time.</p> <p>Tap <b>Next</b>.</p>	

**Table 11. Initial Setup Instructions (Continued)**

Step No.	Description	Screens
7	<p>The <b>Setup: Measurement Units</b> screen appears.</p> <p>Choose between <b>MΩcm</b> and <b>µS/cm</b>.</p> <p>Tap <b>Next</b>.</p>	
8	<p>The <b>Setup: Temperature Units</b> screen appears.</p> <p>Choose between <b>°C</b> and <b>°F</b>.</p> <p>Tap <b>Next</b>.</p>	
9	<p>The <b>Setup: Sustainability Mode</b> screen appears.</p> <p>Choose between <b>Pack Saver Mode</b>, <b>Water Saver Mode</b>, and <b>Dynamic Mode</b>.</p> <p>Tap <b>Next</b>.</p>	
10	<p>The <b>Setup: Type II Dispenser</b> screen appears.</p> <p>Select <b>Yes</b> or <b>No</b> to indicate if a Type II dispenser is installed.</p> <p>Tap <b>Next</b>.</p>	
11	<p>The <b>Setup: Installation Instructions</b> appears on the screen.</p> <p>This screen displays information about the installation of the Aquanex System.</p> <p>Tap <b>Next</b>.</p>	
12a	<p>Tap <b>Start</b> for <b>System Initialization</b>.</p> <p>It takes the system through the initial flushing routine sequence to flush RO Assembly.</p>	



**Table 11. Initial Setup Instructions (Continued)**

Step No.	Description	Screens
12b	During flush, the <b>RO Assembly flush in progress</b> screen appears. Tap <b>Cancel</b> to exit Setup.	
12c	Tap <b>Continue</b> to flush DI Packs.	
12d	During flush, the <b>DI Packs flush in progress</b> screen appears. Tap <b>Cancel</b> to exit Setup.	
13	Tap <b>Finish</b> to proceed to home screen.	

### 5.1.2.2 Volumetric Dispense Calibration using Volumetric Measurement

**Note:** Use 250 ml and 1000 ml graduated cylinders while using this calibration.

**Note:** If more than one Aquanex Smart Touch Dispenser is use, each dispenser needs to be calibrated. Calibration is done at 150 ml and 500 ml.

**Note:** The Type II dispenser does not require calibration.

- a. Place the 250 ml graduated cylinder under the D1 or D2 dispenser.
- b. Tap the **Next** to put the selected Aquanex Touch Smart Dispenser in **Calibration ready** mode.
- c. Press the dispense button on the black touch pad of the Aquanex Touch Smart Dispenser being calibrated to dispense 150 ml of water.
- d. Measure and enter the volume of water actually dispensed on the screen and tap **Next**.
- e. Similarly repeat the process for 500 ml calibration (1000 ml graduated cylinder needed).

## 5.1.2.3 Volumetric Dispense Calibration using Mass Measurement

**Note:** Use 250 ml and 1000 ml beakers and a calibrated balance with at least 2000 g measurement capacity when using this calibration.

- Tare the 250 ml beaker on a balance.
- Place the beaker under the D1 or D2 dispenser.
- Tap **Next**, Aquanex Touch Dispenser enters **Calibration Ready** mode.
- Press the dispense button on the black touch pad of the Aquanex Touch Dispenser being calibrated to dispense 150 ml of water.
- Weigh the water in the beaker and enter the mass of water in grams (g) actually dispensed on the screen and tap **Next**.
- Similarly repeat the process for 500 g calibration (1000 ml beaker needed for this step).

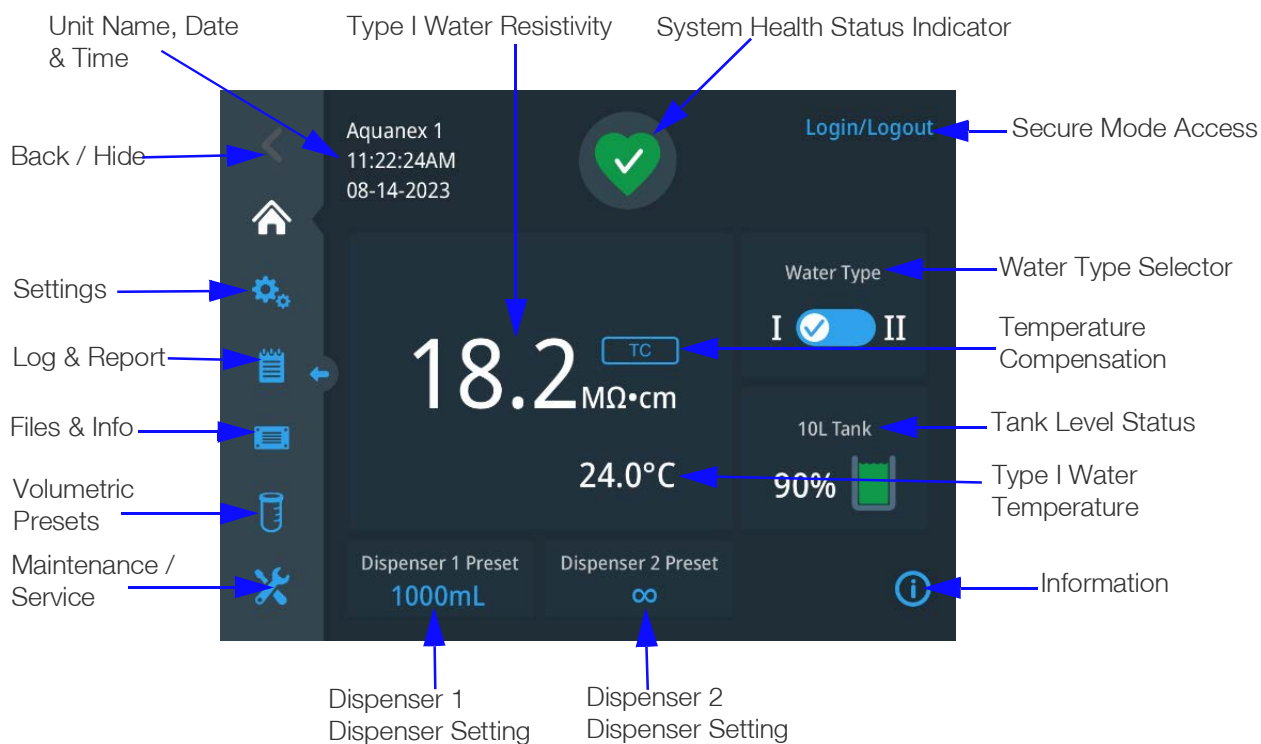
## 5.2 Operation

When the unit is switched ON, a startup screen with Thermo Scientific logo appears, followed by the Home Screen.

The home screen will display Resistivity or Conductivity depending on the settings on the main unit, Tank Level, System Health Status, Type I water Temperature, and the Volumetric Preset Volume selected or the infinite symbol displaying the dispenser is in Manual Mode. Note that the preset icons will not show up if a dispenser is not connected.

### 5.2.1 Aquanex Main Unit Home Screen

The Home screen includes various navigational and operational features.



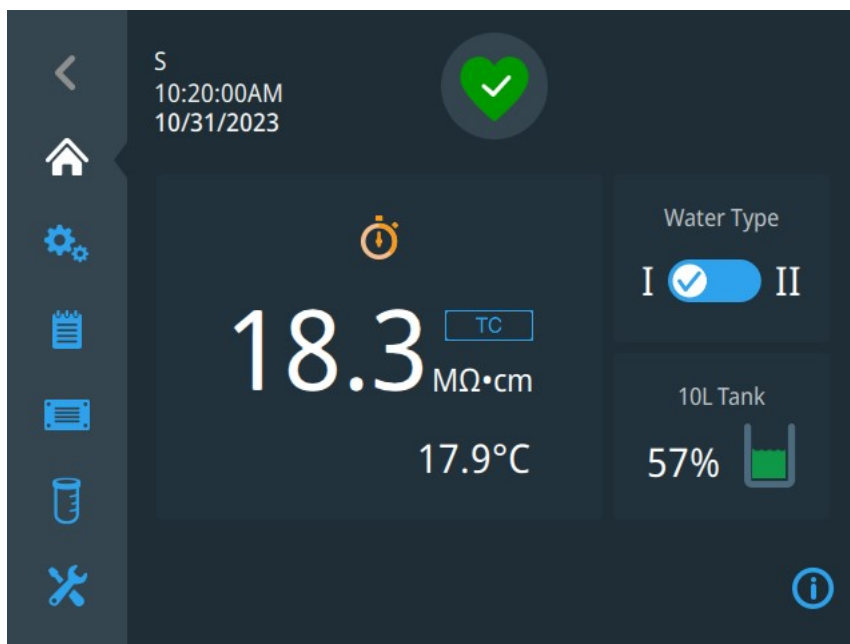
**Figure 40. Home Screen**

## 5.2.2 Type I Water Operation

Type I water purity is expressed in conductivity (to 0.055  $\mu\text{S}/\text{cm}$ ) or Resistivity (to 18.2 Mohm-cm based on selection in the Settings section).

The purity reading, if showing TC, will be Temperature Compensated to 25 °C. This is the recommended default setting. If NTC is displayed, the purity will not be temperature compensated and will change as the water temperature changes.

When the system comes out of sleep mode, the stop-watch icon (see **Figure 41**) appears above the reading as the water purity stabilizes. Wait until the reading is stable before dispensing Type I water.



**Figure 41. Stop Watch Screen**

**Note:** Type I water can be dispensed through the Aquanex Touch Smart Dispenser only.

## 5.2.3 Type II Water Operation

From the Home screen, easily switch between Type I and Type II water dispense mode by utilizing the Water Type selector.

The primary readings for Type II water are not displayed on the home screen but is typically between 1.0-10.0  $\text{M}\Omega\cdot\text{cm}$  for resistivity or 1.000 – 0.100  $\mu\text{S}/\text{cm}$  for conductivity.

Toggle to Type II on the toggle switch to log the approximate volume of Type II water dispensed from the Aquanex System. The user must toggle the switch button before dispensing and then tap it again once dispensing is completed to register the dispense record to the log. The switch toggles back to Type I water 5 min after the end of the Type II dispense or when the tank is empty. Tank filling will be paused while the system is in Type II mode, tank filling will resume once the system returns to Type I.

**Note:** The Type II volume log is an approximation based on the change in the tank volume while the device was in Type II mode. The total volume dispensed while in Type II mode will be logged as one dispense.

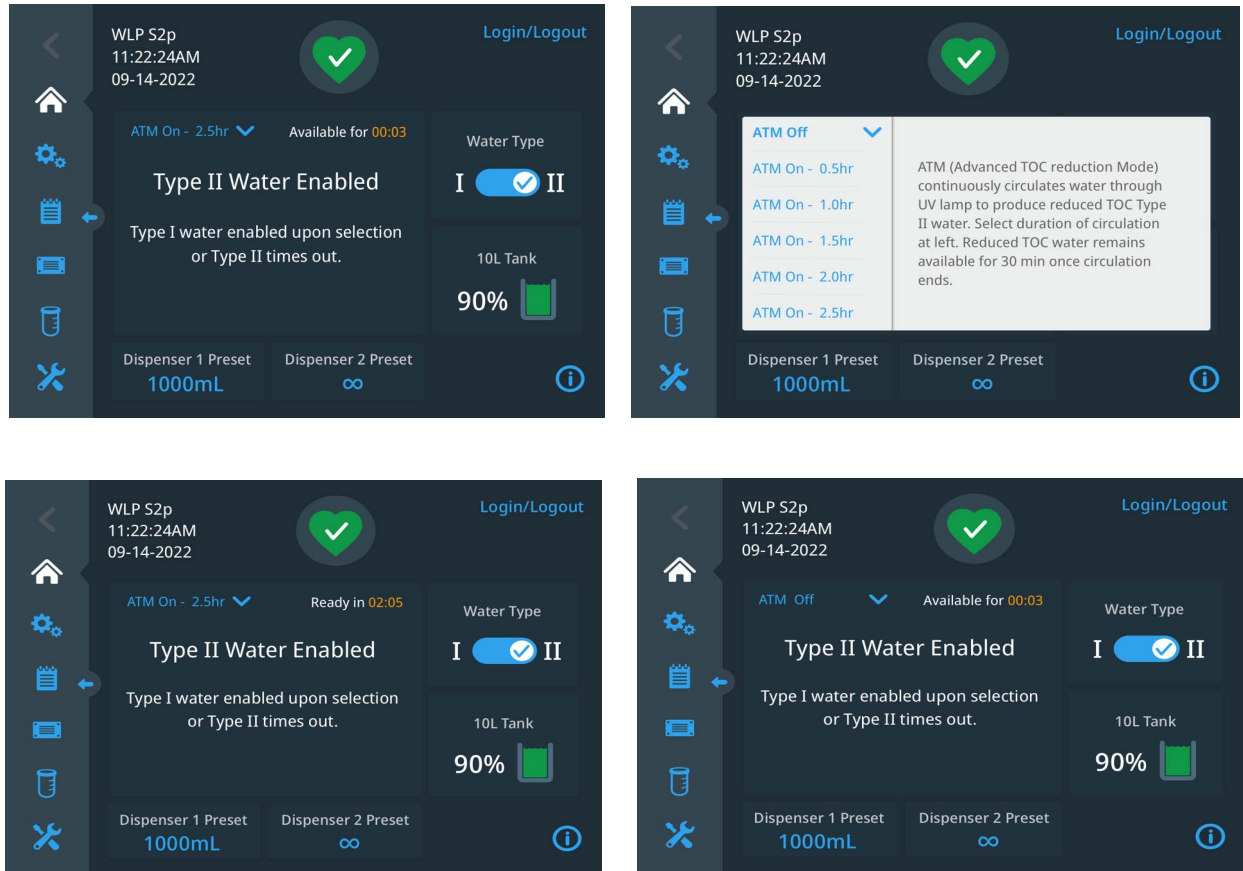
**Note:** The user cannot dispense Type I water if Type II water is being dispensed.

## 5.2.3.1 Advanced TOC Reduction Mode (ATM)

While dispensing Type II water, the system can operate in a specially designed mode to produce Total Organic Carbon (TOC) reduced Type II water, this mode is called Advanced TOC Reduction (ATM) mode.

In ATM mode, Aquanex System circulates water continuously through the UV lamp to produce reduced TOC Type II water.

To access the ATM mode, toggle the system to Type II, and select the ATM drop down menu (see **Figure 42**). Select the time duration for which the system should recirculate water to ensure that the entire dispense will be in ATM mode. When the system ends circulation, the reduced TOC water remains available for up to 30 minutes.



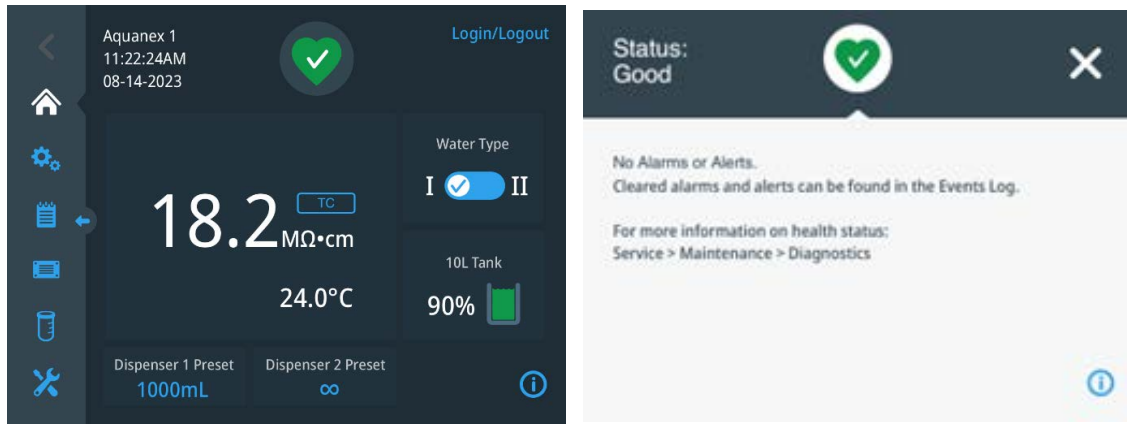
**Figure 42. Type II Water Dispense and ATM Mode Screens**

## 5.2.4 System Controls

### 5.2.4.1 System Health Status Indicator

The green heart at the top center of the **Home** screen gives you an indication of health status of the system.

When the user taps on the green heart icon, the **Health Status** screen displays the following information:



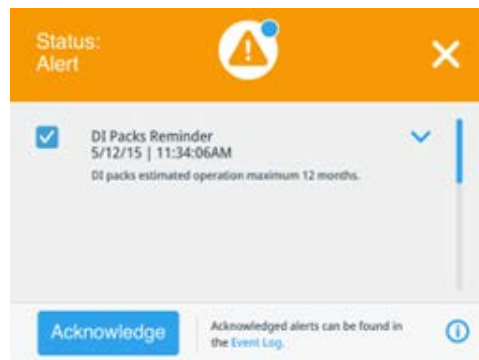
**Figure 43. System Health Status Indicator - System Health Good**

**Health Alerts and Alarms:**

**Alerts:** In the Aquanex System, alerts are used to notify about general, non-urgent matters. The green heart icon changes into a yellow alert icon with a message in the yellow banner below it.

**To respond to an alert:**

- a. Tap the **Alert** symbol.
- b. The **Status: Alert** screen appears with details about the reason for the alert.
- c. Read and note the alert information carefully.
- d. Select check box to the left of each alert you wish to acknowledge, and tap **Acknowledge** button.
- e. The alert notification stops. If the problem has not been resolved, the alert will show again.



**Figure 44. Alert Screen**

**Alarms:** In the Aquanex System, audible and visual alarms are used to notify about the information that requires urgent attention. The green heart icon changes into a red alarm-bell icon with a message below it. In addition, unless the alarm mode is kept on silent, you will also hear an alarm sound.

**To respond to an alarm:**

- a. Tap the **Alarm** symbol.
- b. The **Status: Alarm** screen appears with details about the reason for the alert.
- c. Read the alarm information correctly.

- d. Select checkbox to the left of each alarm you wish to acknowledge, and tap **Acknowledge** button.
- e. The alarm notification stops.
- f. Acknowledging the alarm, restarts the system.

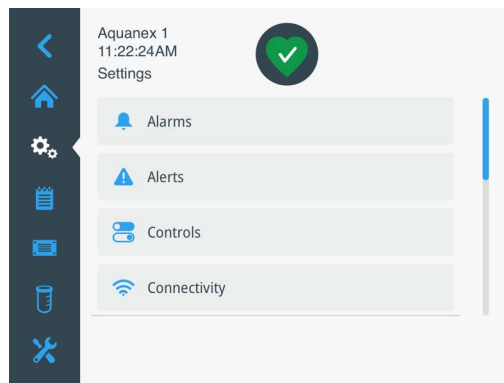


**Figure 45. Alarm Screen**

**Note:** The number displayed in the blue circle on the bell icon indicates the number of alarms that are yet to be acknowledged. Once all alerts and alarms are acknowledged, the home screen displays the green-heart icon indicating the health status is **Good**.

## 5.2.4.2 Settings

To access System Setting, tap **Settings** icon on the Navigation bar.

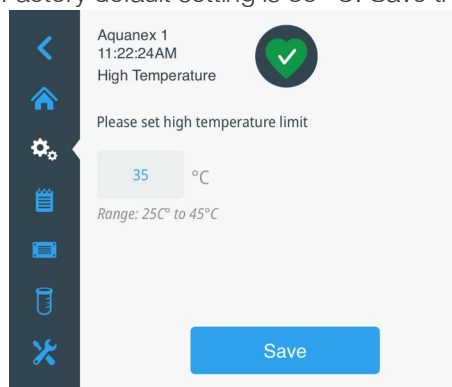


**Figure 46. Setting Screen**

### a. Alarms

The **Alarm** screen displays two options: **High Temperature** and **Snooze Timeout**.

- i. **High Temperature** screen sets the high temperature limit for the recirculated water. It also displays the range within which the temperature can be set. Factory default setting is 35 °C. Save the setting by tapping **Save** button.



**Figure 47. High Temperature Alarm Screen**

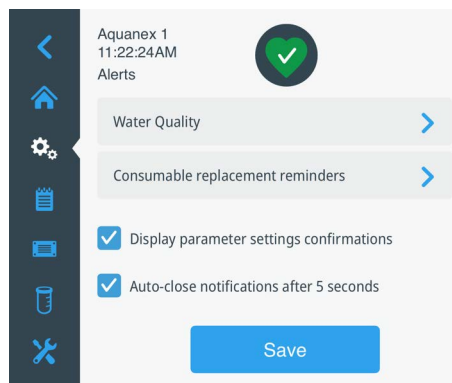
- ii. **Snooze Timeout** drop down list facilitates to snooze the alarm (to set the alarm on silent) for a certain time duration. The drop-down list has three durations for which the alarm can go silent. User can select the duration and tap **Save** to save the changes.

**Note:** If the alarm condition is not acknowledged within the duration set by the user, the alarm returns.

**Note:** To see complete list of alarms refer to Alarms table in **Troubleshooting** section.

**b. Alerts**

The **Alert** screen displays user customizable settings for water quality alerts and consumable replacement reminders.



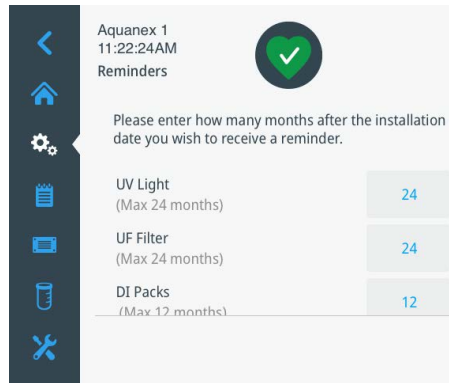
**Figure 48. Alerts Screen**

- i. **Water quality** alerts about the system Type 1 water quality is not meeting the set point range. The user can set a **Low Resistivity** or **High Conductivity** by tapping the **Water Quality** button.

**Note:** The Resistivity or Conductivity screen appears based on your selection to measure in MΩ•cm or μS/cm on the **Measurement Units** screen during the initial setup.

**Note:** To see complete list of Alerts refer to Alerts table in **Troubleshooting** section.

- ii. **Consumable Replacement Reminder** sets time frame for consumable alerts on the Home Screen. The Aquanex System comes with default consumable change over reminder settings. It is also possible to set the desired consumable replacement reminders based on historical data regarding the frequency of replacements due to usage and feedwater quality. Set time (in months) for each consumable listed.



**Figure 49. Consumables Replacement Reminder Screen**

**Note:** Tap water available in laboratories across the globe varies in quality. For this reason, consumable replacement will also be different for different users.

**Note:** All consumables can be self-serviceable except the UV lamp. The UV lamp must be replaced by authorized personnel (Authorized personnel are personnel who are approved by the Laboratory Manager).

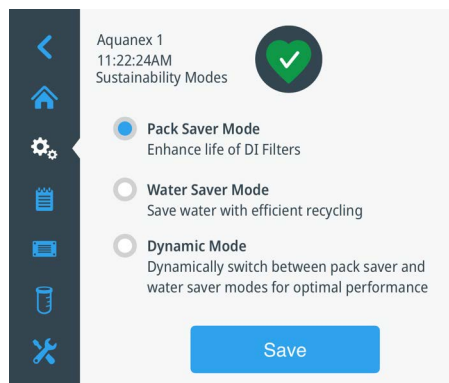
**Note:** Pretreatment only comes with SKUs 7101011 and 7201031. Otherwise, purchase separately.

### c. Controls

The control screen displays four options:

- i. **Sustainability Modes:** Allows the user to select between water savings and / or DI pack savings.
  - a. **Pack Saver Mode:** Improves life of the DI packs.
  - b. **Water Saver Mode:** Saves water by preventing excessive amounts of water flushing into the drain from the RO assembly.
  - c. **Dynamic Mode:** Intelligently switches between water saver and pack saver modes depending on the feedwater quality to optimize overall system performance.

**Note:** Using **Water Saver Mode** may result in shortening the life of DI packs.



**Figure 50. Sustainability Modes Screen**

- ii. **Standby Recirculation:** Sets how often and how long the water in the system will recirculate.
  - a. **Standby Recirculation Duration:** Set how many minutes the system remains in recirculation when in sleep mode. Factory default = 15 minutes.
  - b. **Standby Recirculation Frequency:** Set the frequency, in hours, the system restart recirculation when in sleep mode. Factory default = 2 hours.
- iii. **UV Lamp:** The UV lamp switch allows the user to manually turn the UV lamp off.



- iv. **Type II Dispenser Connected:** The Type II Dispenser switch will disable the Type II toggle on the main screen if turned off.

#### d. Connectivity

Connectivity screen displays information about the date, time, region, and any connected IP addresses (will be blank if not connected to any).

#### e. Display

The Display screen includes general settings like language, time/date, region, unit name, and screen brightness.

#### f. Measurement

- i. **Measurement Units:** Choose either **Resistivity** or **Conductivity** mode, depending on the need of the user for display on the Home Screen.
- ii. **Temperature Units:** Set the **temperature unit** in Celsius (°C) or Fahrenheit (°F).
- iii. **Temperature Compensation:** The temperature compensation at 25 °C can be put in either **Ultrapure** mode or in **OFF** mode. To stabilize the displayed conductivity, check the box for normalization on the screen.

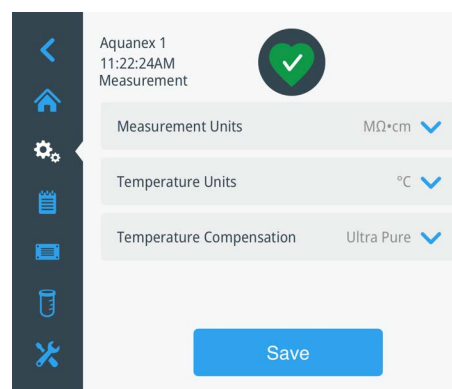


Figure 51. Measurements Screen

#### g. Access control Open or Secure modes

This screen displays **Open** and **Secure** mode.

- i. **Open Mode:** Allows access to all users to dispense and operate the system without user login required. Best for quick access to all lab personnel.
- ii. **Secure Modes:** Requires Administrator to give User Level accounts to all users. Users must log in with a unique user name and password to dispense water to keep a record of the event for recording purposes. Certain functions can only be carried out by Admin level. Best for traceability unit protection.

### 5.2.4.3 Secure Mode and Admin Account Setup

To operate in Secure mode, Go into **Settings > Access Control** and select **Secure**. Press **OK** to proceed to **Secure mode**. The Login/Logout link for secure mode access appears in the top right corner of the **Home** screen. Secure mode requires users to log in to operate the system so it can be properly logged in event and dispense log.

Before the Administrator starts the initial set-up, ensure that all the installation steps have been completed. If user cannot confirm, then power off the device and complete the following steps before proceeding:

- a. Main unit is on a flat surface or securely wall mounted.
- b. DI Packs, both A and B, have been properly installed in the main unit.
- c. RO assembly is installed.

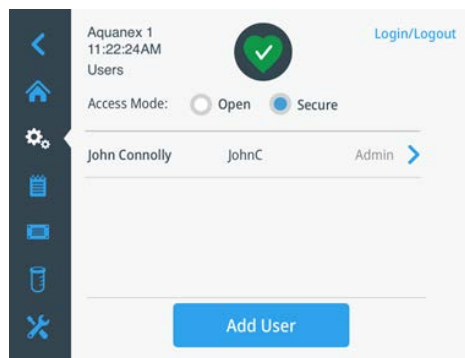
- d. Dispenser is properly connected to main unit and has the POU filter installed.
- e. Water supply is connected to pretreatment and to the Aquanex System.
- f. System waste and storage tank overflow tubes are connected and routed to drain.
- g. Power supply is correctly connected to the unit.

**Note:** The Aquanex System will start in Open mode which does not require a password set up. Once the initial set up is complete, the Administrator can decide to operate in **Open** or **Secure mode**. If Admin selects **Secure Mode**, they will enable users to create unique usernames and passwords to log in to the system.

**Note:** If this is the first admin account, you cannot exit account creation screen without creating an Admin account.

**Administrator Account Set up:**

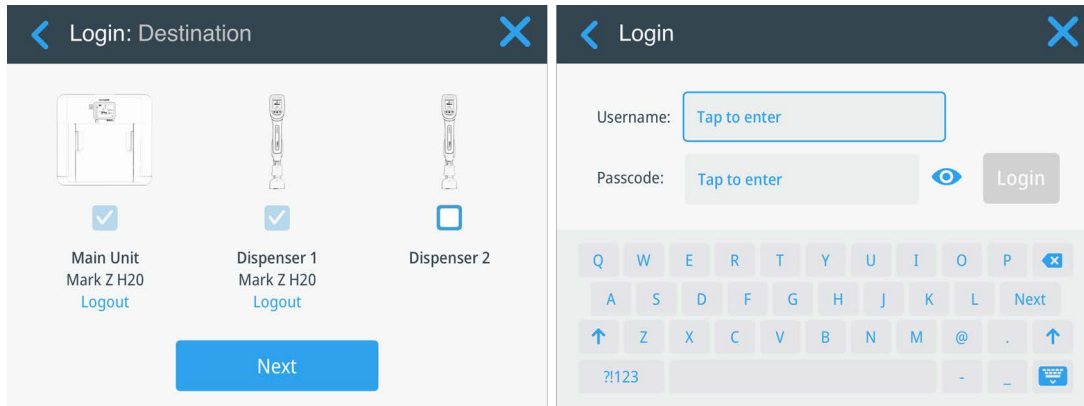
- a. Setup **Administrator Account** by entering the Administrator’s name and email information.
- b. Tap **Next** to enter information to move through the screens. In the next few screens, Administrator will select and answer security question and setup password.
- c. Administrator is now ready to set up to provide access to other users.



**Figure 52. Administrator Access for Adding Users**

**To login into the system:**

- a. Tap **Login/Logout** on the top right corner of the Home screen. The **Login: Destination** screen appears showing the three destinations you can log into: **Main Unit, Dispenser 1, and Dispenser 2**.
- b. User can select multiple destinations to have access to operate system, however login with username and password in must be done on Main screen.
- c. Click **Next**, the **Login** screen appears.
- d. Enter your **Username** and **Passcode**.
- e. Tap **Login** button to log into the system. Tap **Logout** to unselect, when activity with system is completed.
- f. Administrator must login, go to **Settings> Access Control** and select **Open**. Press **OK** to save.



**Figure 53. User Login in Secure Mode Operation**

## 5.2.5 Volumetric Dispense Calibration

The last step in the initial setup is to calibrate the volumetric dispense.

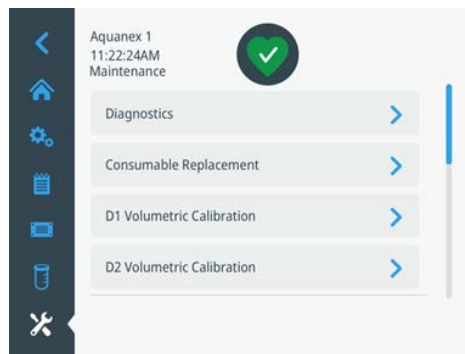
- Tap **Maintenance / Service** icon on the Navigation bar.
- Tap **Maintenance** and then tap **D1 Volumetric Calibration** to enter calibration sequence.
- Follow system instructions on the screen (and below) to complete calibrations for 150 mL and 500 mL respectively.

**Note:** System will start with 150 mL (g) calibration and provide a choice of values in g or mL.

**Note:** If there are two Touch dispensers (D1 and D2) connected, system will show D1 and D2 calibration separately.

Press **Next** when done, and the screen will prompt the message indicating the completion of the calibration. Your Aquanex Touch Smart Dispenser is now ready to accurately dispense desired volume.

Visit operation section for more information on adjusting and selected desired volume for volumetric dispense.



**Figure 54. Maintenance / Service Screen**

### 5.2.5.1 Logs & Reports

To access Logs & Reports, tap **Logs & Reports** icon on the **Navigation bar**.

This provides access to the Dispense Log and Event Log.

- a. **Dispense log:** It provides dispense details including volume dispensed, temperature, and water quality reading of dispensed water. A user can sort and acquire data about a specific date or a specific period (weeks or months). The report provides entire dispense data in CSV or in PDF format.

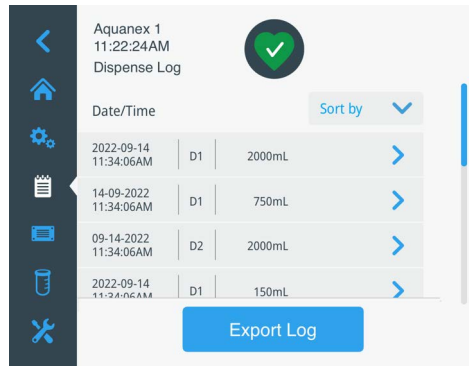


Figure 55. Dispense Log Screen

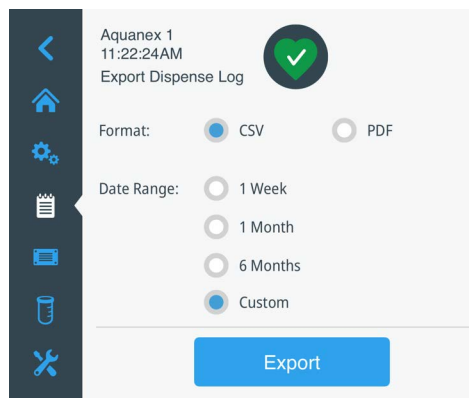


Figure 56. Dispense Log Export Options

- b. **Event log:** This log provides detailed events with date and time. It provides detail about the events like **Alarms/Alerts, Maintenance and Service**, etc. A user can filter the log by a specific event by selecting from the filters in the drop-down menu top right. The user may export the log files by tapping on **Export Log** button in either CSV or PDF format. Select the time period for which the log is required from the radio buttons. If user selects the custom radio button, the duration may be set by selecting start and end dates using the wheel pickers.

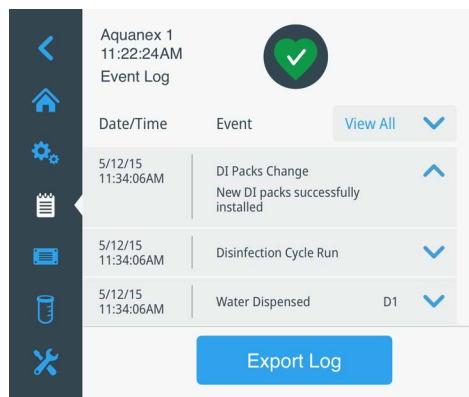
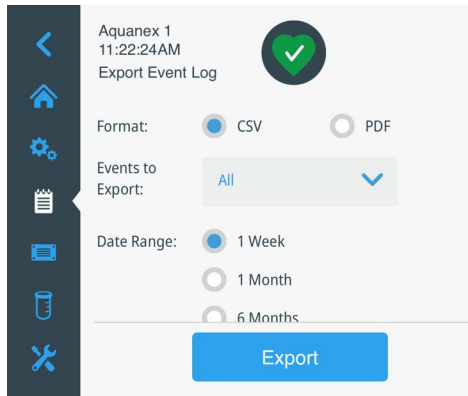


Figure 57. Event Log Screen

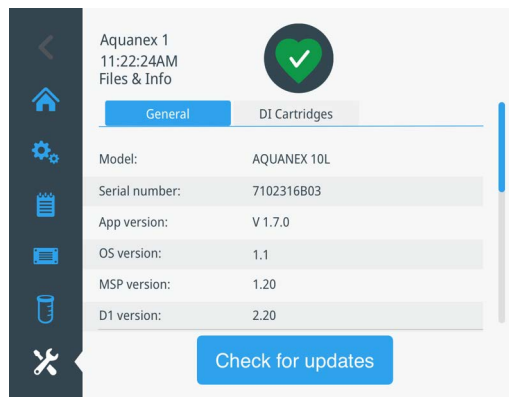


**Figure 58. Export Log Export Options**

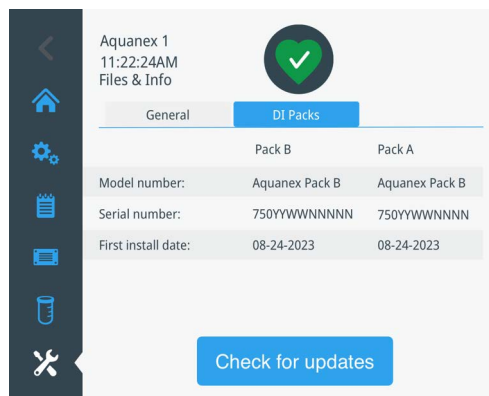
## 5.2.5.2 Files & Info

To access Files & Info, tap **Files & Info** icon on the **Navigation bar**.

This provides general information about system and DI packs such as version of the software in main unit and Dispenser, systems and DI pack serial numbers, date of installation of DI pack, etc.



**Figure 59. Files and Info Screen – General**

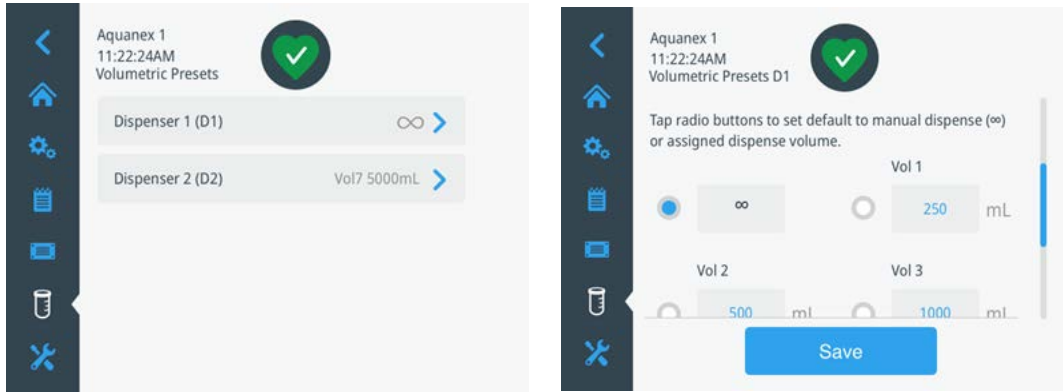


**Figure 60. Files and Info Screen – DI Cartridges**

## 5.2.5.3 Volumetric Presets

To access Volumetric Presets, tap **Volumetric Presets** on the **Navigation bar**.

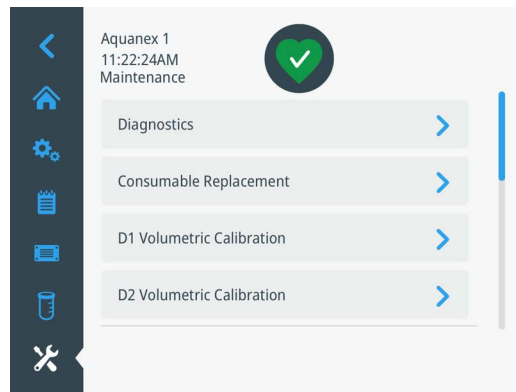
The volumetric presets are available for Aquanex Touch Smart D1 Dispenser and D2 Dispenser. User can tap either dispenser on the screen to set volume of water to be dispensed (in mL). If it is set to infinity, the Type I water is dispensed manually.



**Figure 61. Volumetric Presets Screens**

## 5.2.5.4 Maintenance/Service

To access Maintenance/Service, tap **Maintenance/Service** icon on the **Navigation bar**. Maintenance enables the users to see Diagnostics, drive Consumables Replacement, Perform Volumetric Calibration, Depressurize, and do a Factory reset.



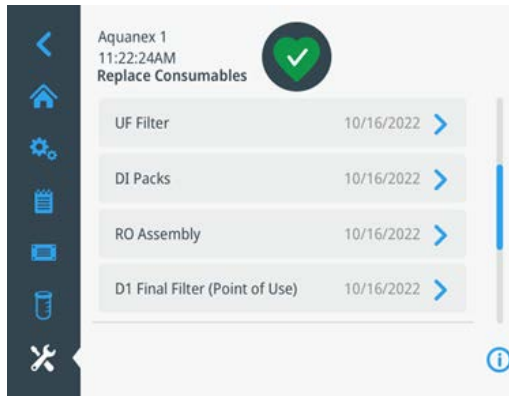
**Figure 62. Maintenance Screen**

a. **Diagnostics** displays three functions.

- i. **Values:** shows the current value of different pressures and conductivity.
- ii. **Status:** shows ON/OFF status and drive level of the functions.
- iii. **Consumables:** This screen shows the change and replacement date of consumables in the unit.

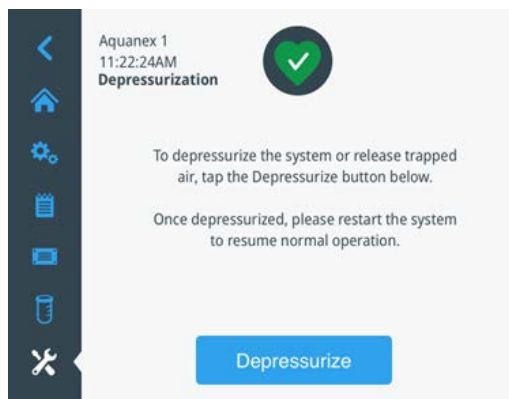
**Note:** The log history of all the functions can be retrieved using the export log history button export log history.

b. **Consumables Replacement:** displays the consumables to be replaced on the scheduled time interval. Each respective screen provides instruction to change or replace the consumable. See Chapter **Maintenance and Care** for more information.



**Figure 63. Consumables Replacement Screen**

c. Depressurize displays the depressurize screen. Tap **Depressurize** to depressurize the system before changing consumables like the RO assembly, the UF, and the UV lamp.

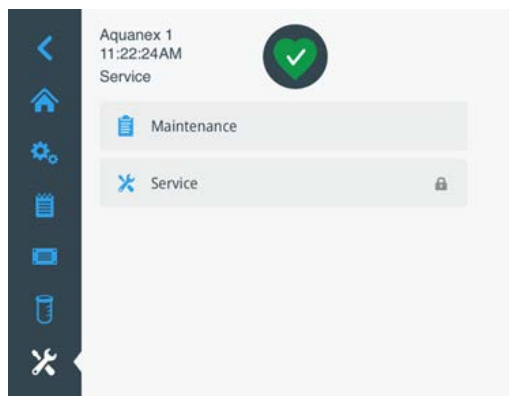


**Figure 64. Depressurize Screen**

d. **Factory Reset** provides a factory reset capability. Selecting factory reset will reset the system but will not delete startup settings or calibrations. During the **Reset**, option is given to save or erase all logs.

**Service**

The Service operation is passcode protected. When Service is onsite, they will access these menus through Service Password. For temporary access to this menu, contact Thermo Fisher.



**Figure 65. Service Screens only for Thermo Fisher Service Personnel**

## 5.2.6 Aquanex Touch Smart Dispenser Home Screen

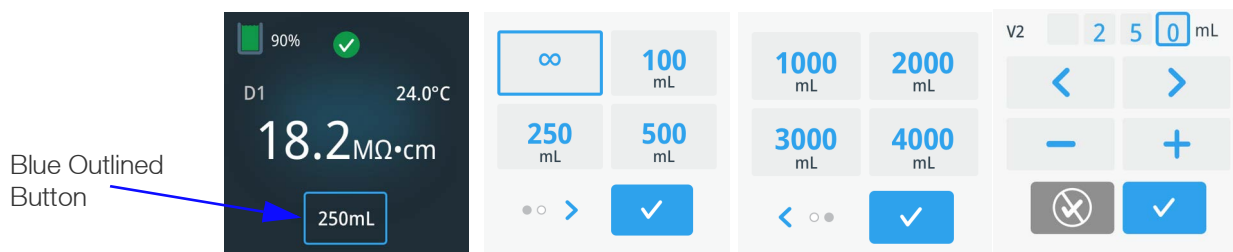


**Figure 66. Aquanex Touch Smart Dispenser POU UI and Dispense Buttons**

Aquanex Touch Smart is a smart ultrapure water dispenser. It features a unique ergonomic design for a comfortable grip and single hand operation. The point of dispense Touch Screen not only provides user with information about system health and critical operation parameters but also allows the user to operate the system from the point of dispense location.

Aquanex System ON also turns ON the Aquanex Touch Smart Dispenser. A startup screen with Thermo Scientific logo appears prior to appearance of the dispenser home screen. This Home Screen is similar to the home screen on the main unit in regards that it displays Resistivity/Conductivity, tank level, health status of the system, temperature and dispenser ID (Tap on the dispenser ID D1 or D2 sign on the **home screen** to reach the **About** screen).

At the bottom of the dispenser home screen, there is a blue outlined button. To select a volumetric preset from the dispenser screen, tap on the blue outlined button, select the preset you wish to dispense. To change the presets from the dispenser screen, tap and hold on the volume you wish to change. Use the editing screen to update the volume. Tap the blue button with the checkmark to save. The blue outline in the volumetric preset screens indicates the current volume to be dispensed. This number will be displayed in the blue outlined button on the home screen if a volumetric preset has been selected.



**Figure 67. Aquanex Touch UI Home Screen and Volumetric Dispense Buttons**

## 5.2.7 Dispensing Type I Water

To dispense, tap the middle button (Dispense button) on the black rubber pad of the Aquanex Touch Smart Dispenser.

### a. Volumetric Dispense:

- i. This operation allows a user to dispense a predetermined amount of water from the dispenser.
- ii. The volume of the water to be dispensed can be altered.
- iii. Progress of a volumetric dispense can be monitored on the screen as a blue bar which appears after selecting the preset volume.
- iv. To pause the volumetric dispense, press the **Dispense** button.



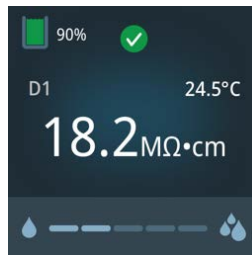
- v. To resume volumetric dispense, press the **Dispense** button again.
- vi. To cancel the volumetric dispense, tap the **Cancel Drop** icon on home screen on the POU UI.



**Figure 68. Aqanex Touch Screen Before and During Volumetric Dispense**

**b. Manual Dispense (∞):**

- i. This operation allows a user to manually dispense water.
- ii. To dispense, press the center **Dispense** button. The Flow rate indicator appears on the dispenser screen. The user can adjust the flow rate by pressing the < or > buttons on the dispenser.
- iii. To stop the dispense, press the **Dispense** button again. User does not need to hold the dispense button throughout the dispense.



**Figure 69. Aqanex Touch Screen during Manual Dispense**

# 6 Maintenance and Care

To ensure that your system functions without any errors it must be checked, maintained, and serviced at regular intervals, as described in these operating instructions. The operating instructions must, therefore, be kept in an easily accessible location for anyone who is using or servicing the system.

**Note:** Calibration of the conductivity may only be performed by a service technician authorized by the manufacturer.

Disinfection of the system must be performed annually. Disinfection procedures must also be performed in the event of a high bacteria content or impurities in the product water. It is also suggested to be performed when changing the Aquanex DI Packs.



**DANGER:** Make sure that the checks and maintenance work on electrical equipments are carried out only by qualified, factory trained and authorized service representatives. Unplug the system from the power outlet for all maintenance work on the system.

## 6.1 Maintenance Intervals

Consumables must be replaced in accordance with the table as follows. The intervals are established for the user and depends on the actual and exact water quality and the volume of water that is used daily.

**Table 12. Maximum Replacement Intervals of Aquanex Consumables and Replacement Indication**

Consumables	Flow Chart No.	Item No.	Max. Replacement Interval	Replacement Indications
Aquanex DI packs	DI	7501050	12 months	System alerts for maximum replacement interval. System alarms when pure water limit value is exceeded.
0.1 µm POU filter	F2	50157375	12 months	System alerts for maximum replacement interval. Flow rate is markedly slower. DI packs are replaced.
Ultrafilter (UF)	UF	50133980	24 months	System alerts for maximum replacement interval. Flow rate is markedly slower. Evidence to endotoxin breakthrough.
UV lamp	UV	09.2002	24 months	System alerts for maximum replacement interval. UV lamp does not light, as seen by green light on opaque plastic bulb on top of UV assembly. UV intensity is below 50% or > 3000 hours.
RO Assembly	RO	50157608	12 months	System alarms for maximum replacement interval. Salt rejection is below 90%.

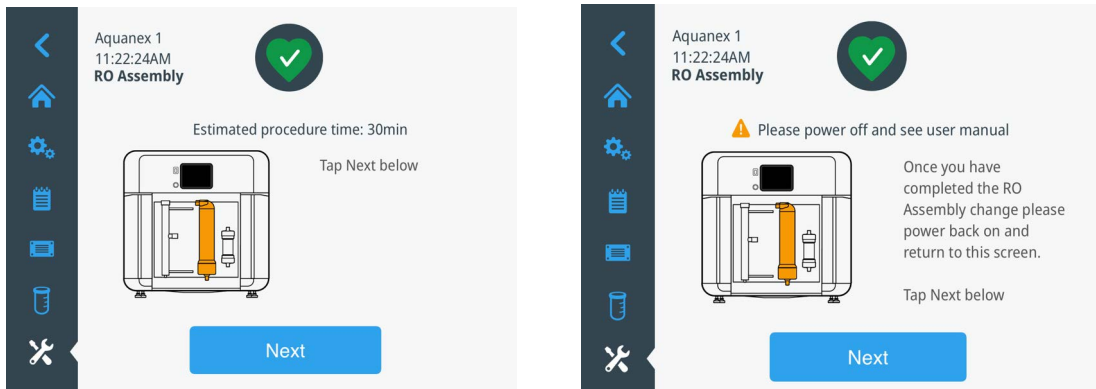
**Note:** The lifetime of the consumables is a direct function of the quality of feedwater and the daily volume of water that is used.

## 6.2 Consumable Replacement

From the **Home Screen**, select the **Maintenance/Service Icon**, then select **Maintenance**. Select **Consumables Replacement**, then select the consumable you want to replace. Follow the on-screen instructions to complete the consumable replacement procedure.

### 6.2.1 RO Assembly

Tap on **RO Assembly** to go to RO Assembly Replacement Screen. A message appears to switch off the system to start the replacement process and display the required following step.



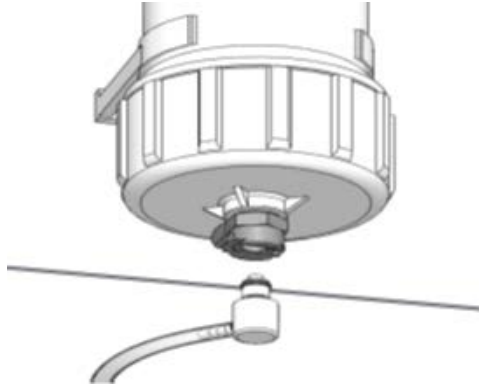
**Figure 70. RO Assembly Replacement Start Screens**

#### Replacement Procedure:

- Switch the system **OFF**.
- Remove the old RO assembly:** Press the metal quick release with your thumb and disconnect the inlet tube from the bottom of the RO assembly.

**Note:** The RO assembly has two tubing ports at the top of it; one port at higher level than the other. The top lower port is connected to the concentrate line (yellow-connector) while the top higher port is connected to the permeate line (white-connector).

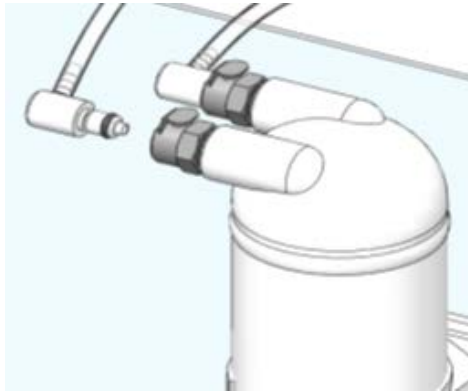
- Disconnect the concentrate and permeate lines from the top ports by pressing the metal quick release using your thumb. Disconnect the concentrate and permeate tubing.
- Pull the existing RO assembly gently out of the plastic bracket.



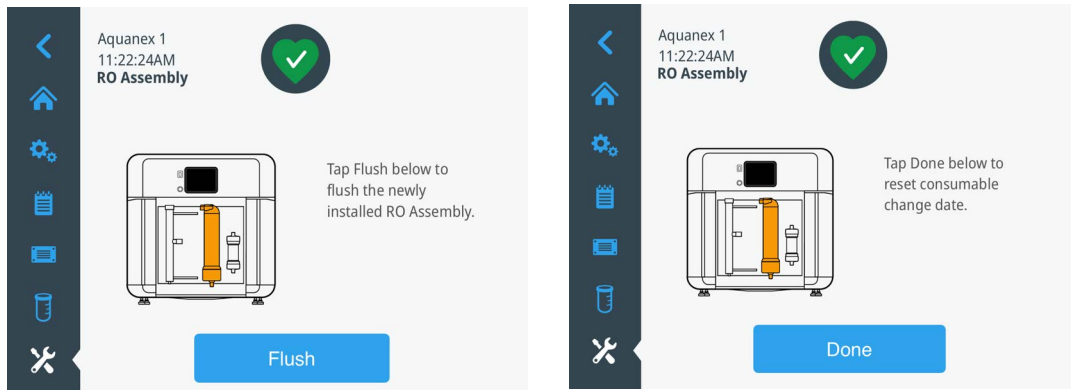
**Figure 71. RO Assembly Inlet**

**c. Install a new RO Assembly:**

- i. Install the new RO assembly in the plastic brackets. Connect the inlet tube to the bottom of the RO assembly by pushing the male quick connect fixture into the bottom female quick release fixture.
  - ii. Similarly, connect the concentrate line to the top lower port and permeate line to the top higher port.
- d. Switch the system **ON**. Navigate back to RO Assembly replacement menu:  
**Maintenance/Service Icon > Maintenance > Consumables Replacement > RO Assembly.**
- e. Tap **Next** to go the next screen.
- f. Select **Flush** to initiate the RO flush.
- g. The flush runs for 15 minutes.
- h. Tap **Done** on the final screen.



**Figure 72. RO Assembly Concentrate and Permeate Lines**



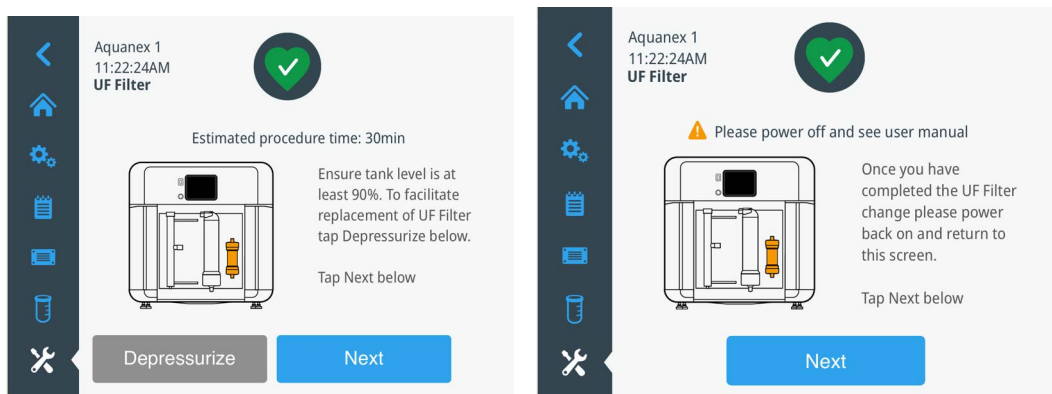
**Figure 73. RO Assembly Replacement Final Screen**

Empty storage tank to <70% to start RO. After operating the system for at least 10 minutes, go to the **Diagnostics** screen to access the RO permeate conductivity. RO conductivity should be < 100  $\mu\Omega/cm$ .

**Note:** The Concentrate flow is controlled by a non-adjustable flow restrictor. Only specially trained personnel may replace this part. The restrictor has a flow arrow and correct direction is pointing to drain.

## 6.2.2 Ultrafilter

**Note:** Make sure that the tank level is higher than 90%.

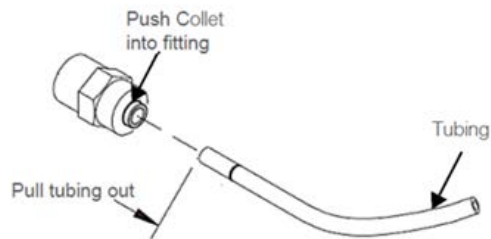


**Figure 74. Ultrafilter Replacement Starting Screens**

### Replacement Procedure:

- a. Tap **UF Filter** on UI screen, the screen displays a message to depressurize the system.
- b. Tap **Depressurize**. Display reads: “The system has been depressurized. Tap the triangle icon for more information”. Acknowledge the depressurizing step. When completed, press **Next**.
- c. Switch the system **OFF**.
- d. Replace the ultrafilter:
  - i. Disconnect the bottom inlet tube from black John Guest fitting UF filter using blue quick release tool. Press the connector (It is named as collet as shown in **Figure 75**) into the adapter and pull the tubing out.
  - ii. Disconnect the top outlet tube in the same manner (see **Figure 75**).
  - iii. Unscrew the black adapter from the top and bottom of the ultrafilter.

- iv. Thread the adapters onto the new ultrafilter, noting the orientation of the ultrafilter with the arrow pointed up. Teflon tape may be used to ensure a good seal.

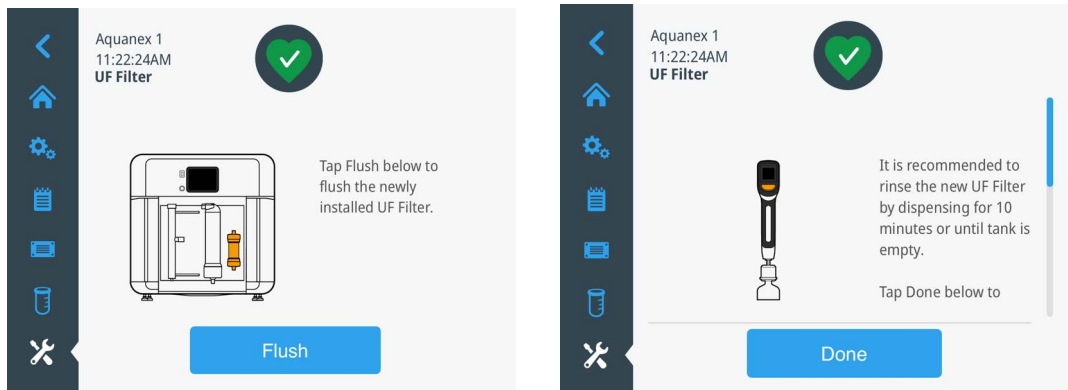


**Figure 75. Ultrafilter Replacement (Only Upper Tubing Port is used)**

- v. Turn the female lure fitting on upper left side of ultrafilter counterclockwise until it comes off of the UF Filter to disconnect the tube from the upper port of the ultrafilter.

**Note:** One of the ultrafilter has two tubing ports. The upper port is connected to the tube while the lower port is closed.

- vi. Pull the existing ultrafilter gently out of the plastic bracket.
  - vii. Place the new ultrafilter in the same plastic bracket oriented, so the arrow with mark **Flow** is pointing upward.
  - viii. Connect the inlet tube at the bottom of the ultrafilter by pushing it into the quick connect fitting.
  - ix. Connect the outlet tube at the top of the ultrafilter by pushing it into the quick connect fitting.
  - x. Reconnect the female Luer fitting on the upper side port by placing it on the port and turning it in a clockwise direction until secure.
- e. Switch the system ON. Navigate back to UF replacement menu:  
**Maintenance/Service Icon > Maintenance > Consumables Replacement > UF filter.**
  - f. Tap **Next** to go the next screen.
  - g. Select **Flush** to initiate the UF flush.
  - h. The flush runs for 2 minutes. When completed, the screen will instruct to flush the ultrafilter by dispensing water for 10 minutes or one tank full of water.
  - i. Press **Done** when complete. This indicates that the user has successfully completed the replacement of ultrafilter.
  - j. In case, the flush fails to complete, a screen will pop up to inform the user. Tap **OK** to repeat the flush if necessary.

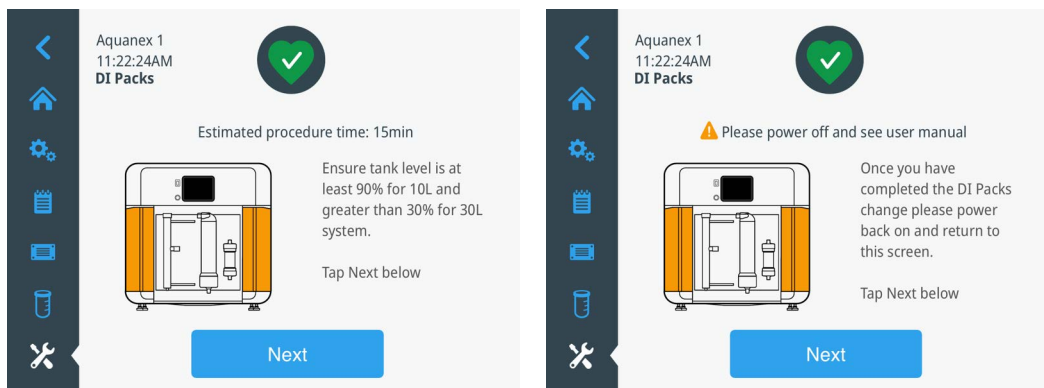


**Figure 76. Ultrafilter Replacement Finish Screens**

## 6.2.3 DI Packs

New Aquanex DI Packs come in a box which contains (1) Right DI pack (A) and (1) Left DI pack (B). The two DI packs are installed on both the sides of the Aquanex Main Unit.

Both the left and the right packs need to be replaced together when exhausted as they are functionally one part. Follow the steps given below to replace the DI packs. Ensure the tank level is at least 90%.



**Figure 77. DI Pack Replacement Starting Screens**

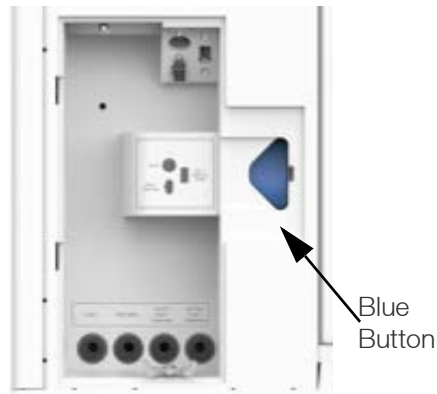
### Replacement Procedure:

- To remove the existing DI packs, first navigate to **DI packs** replacement menu **Maintenance/Service Icon > Maintenance > Consumables Replacement > DI Packs**. Switch the system OFF.
- Remove the side panel cover from both sides to access a triangular blue button.
- Press the button to disengage the DI pack and slide it out from the unit. Repeat for the DI pack on the other side.
- Slide each of the new DI packs in their respective slots and push into place until a firm click is heard.
- The new DI packs are installed.
- Replace the side panel covers removed in **Step b**.

**Note:** The DI packs are non-interchangeable, and are clearly labeled. The panel inside is also labeled (A or B) to assist with installation.

- Navigate back to DI packs replacement menu: **Maintenance/Service Icon > Maintenance > Consumables Replacement > DI Packs**.

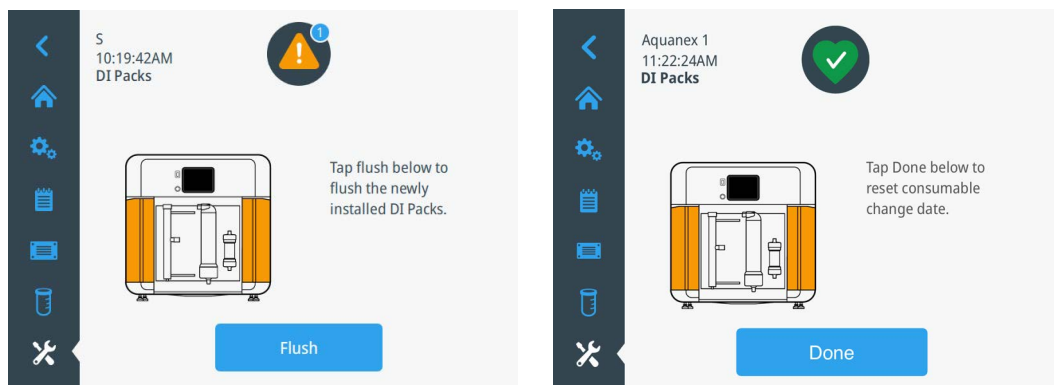
- h. Tap **Flush**. System will generate a flush routine.
- i. System would inform the user if the flush routine passed or failed.
- j. A successful completion of the flush routine concludes the installation of DI packs.
- k. Press **Done** to automatically update the DI Pack change date in the system.



**Figure 78. Triangular Blue Button Releasing DI Packs**



**Figure 79. DI Pack Replacement**



**Figure 80. DI Pack Replacement Final Screens**



## 6.2.4 UV Lamp



**DANGER:** The UV-lamp within the system contains Mercury (Hg) which is hazardous to humans if inhaled or touched. If the UV-lamp within the system is broken, appropriate PPE (eye protection, respiratory protection, and the use of gloves) should be worn.



**WARNING:** The UV-lamp within the system contains Mercury (Hg) which is hazardous to the environment. Disposal of the UV-lamp to a licensed chemical disposal agency in accordance with local laws and regulations is advised.



**PPE Required:** Always wear safety gloves while changing the UV-lamp so that your skin does not come in contact with the UV-lamp glass.



**PPE Required:** Wear directly a breathing protector if the glass of the UV-lamp is broken and ventilate the room well.



Figure 81. UV Lamp Assembly

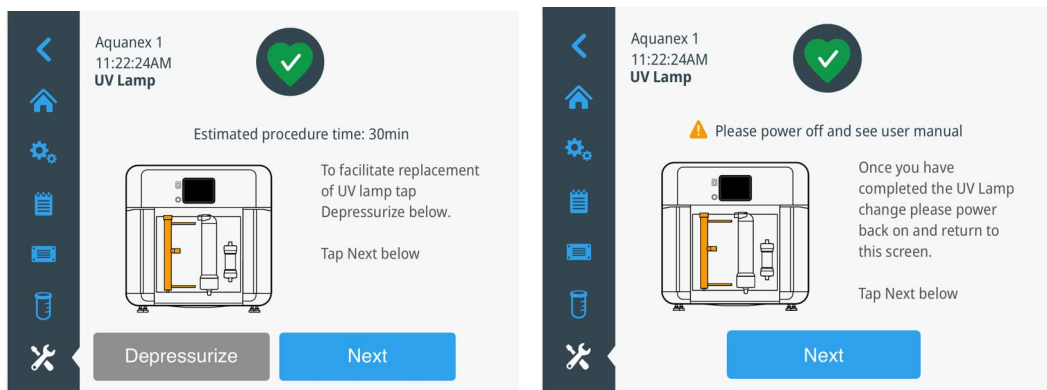


Figure 82. UV Lamp Replacement Starting Screens

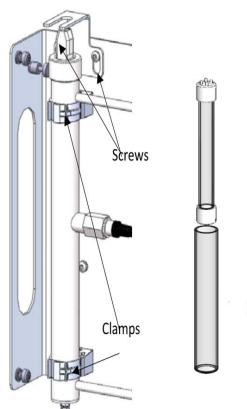
### Replacement Procedure:

- a. Tap **UV Lamp** on UI screen on the consumable replacement screen, the screen displays a message to switch off the system to start the replacement process.
- b. Depressurize the system using the **Depressurize** screen.
- c. Switch the Aquanex System **OFF**.
- d. **Unplug the unit from main power supply.**
- e. The UV reactor assembly is held in place by two clamps.
- f. Decouple the two easy-release clamps holding the UV housing assembly. If necessary, use a flat-head screwdriver to separate the halves of the clamps.



**Figure 83. Using Flat-Head Screwdriver to separate the halves of the Clamps**

- g. Now, gently pull out the UV lamp reactor by holding the clamps in open position. Disconnect the plug of the UV lamp carefully.
- h. Remove the union nut from the UV reactor assembly.
- i. Carefully, pull the glass tube (that holds UV bulb inside it) from the metal casing of the reactor while turning it slightly in the clockwise direction (see **Figure 84**). Entire tube does not need to be removed from the metal housing.



**Figure 84. Removing the Glass Tube from the Metal Casing**



**CAUTION:** When you are removing the UV lamp you must ensure that the glass of the UV lamp is not soiled or that you do not touch it with your fingers. This could impair proper functioning of the lamp. We, therefore, recommend that you wear clean, disposable gloves while performing this work.



**CAUTION:** While placing the UV lamp back into the housing, ensure that the two parallel white lines that runs down on the UV lamp must be on the opposite sides of the UV intensity sensor (by simply rotating the glass tube).



**CAUTION:** When installing a new UV lamp ensure that the flat seal ring and the O-ring are on the correct position. The flat seal ring must fit exactly in the groove provided for it on the top of the union nut. The O-ring fits in the bottom groove in the union nut. If these items do not fit exactly in the grooves and you restart the system, the UV assembly will not be leak-tight at these locations.

- j. Gently pull the UV lamp and glass tube up partially out of the metal assembly lightly turning it clockwise.
- k. Completely remove the UV lamp. Wearing gloves, gently install the new UV lamp into the glass tube. Carefully push the glass tube down into the metal housing with a slight turning motion, if necessary.
- l. Tighten the union nut to the UV reactor assembly using the flat washer and O-ring to seal the assembly.
- m. Plug in the UV lamp. Slide the UV assembly back into the clamps by pushing the UV assembly into the clamps. Lock the clamp by hand pushing them till you hear a click sound.
- n. Switch the system ON (connect main power supply).
- o. Tap **Next** to continue to the UV calibration screen.
- p. Tap **Calibrate**.

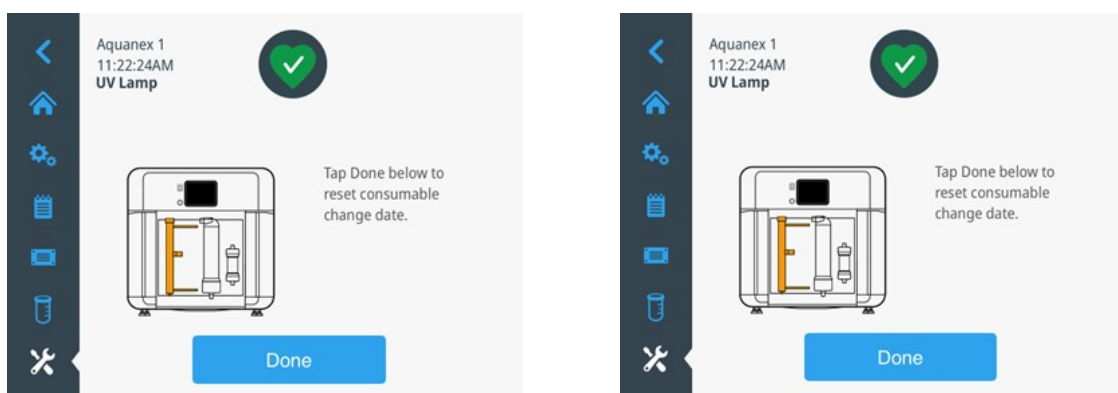


Figure 85. UV Lamp Replacement Final Screens

## 6.2.5 0.1 $\mu\text{m}$ POU Final Filter

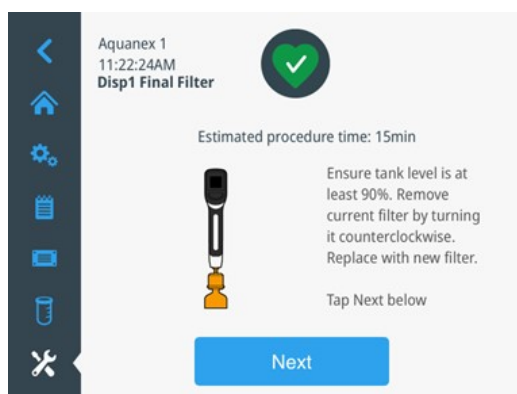
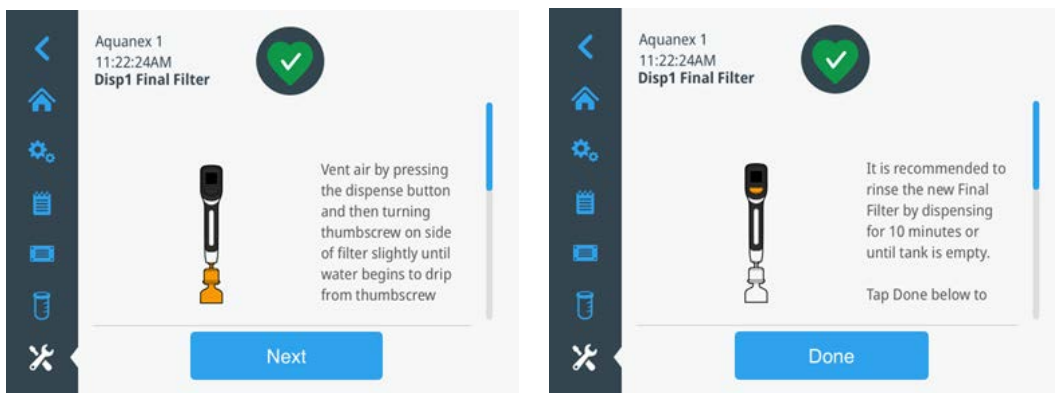


Figure 86. 0.1  $\mu\text{m}$  POU Final Filter Replacement Starting Screens

- Tap **Final Filter** on the consumable replacement UI screen.
- Remove the 0.1  $\mu\text{m}$  POU filter by rotating it in counter-clockwise direction.
- Install new 0.1  $\mu\text{m}$  POU filter by screwing it into the bottom of the dispenser outlet.
- Vent air from the 0.1  $\mu\text{m}$  POU filter by turning the thumb screw and dispense to rinse minimum 1 liter through it.
- Flush the POU filter by running Type I water through for 10 min, or until the tank is empty.



**Figure 87. 0.1  $\mu\text{m}$  POU Final Filter**



**Figure 88. 0.1  $\mu\text{m}$  POU Final Filter Replacement Final Screens**

## 6.3 System Disinfection

**Note:** It is suggested that the system should be disinfected before installing the new DI pack, if bacterial growth is suspected in the system or at a minimum once a year. Use bleach disinfection solution to thoroughly disinfect the system as follows:

### Requirements for disinfection:

- DI Bypass Kit (Supplied with Aquanex System)
- Bleach solution (obtained locally, concentrations and amounts listed below)
- New DI packs
- New POU final filter
- New UF (optional)

Table of Volume (mL) of bleach concentrate (refer to **Table 13**) to use for disinfection based on storage tank volume.

**Note:** Do not use a higher than recommended volume of bleach solutions during the disinfection procedure. Inefficient removal of bleach can have an adverse effect on DI Pack performance.

**Table 13. Volume of bleach needed per bleach concentration**

Bleach Concentration (%)	10L Tank	30L Tank
5.25	40 mL	120 mL
6	35 mL	105 mL
7.5	30 mL	89 mL
8.25	27 mL	80 mL



**PPE Required:** Wear chemically resistant gloves for handling bleach disinfection solution. Refer to the chemical SDS for specific handling instructions



**PPE Required:** Wear safety goggles while working with bleach disinfection solution. Refer to the chemical SDS for specific handling instructions.

**Note:** During disinfection process, the room should be well ventilated to prevent concentration of chlorine vapors.

**Note:** Aquanex System UI Disinfection screens guides the user through the disinfection process.

**Disinfection Procedure:**

**Note:** If the Pretreatment and/or RO assembly are to be replaced, complete their replacement before disinfection. Remove both left and right DI packs from the main unit.

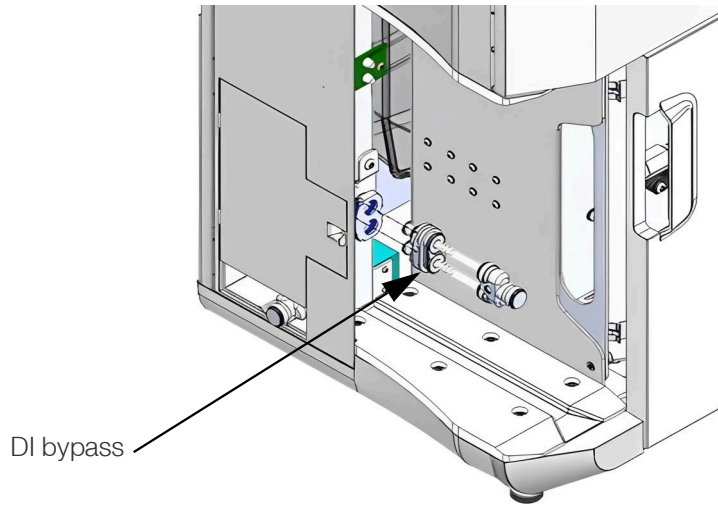
- a. Install DI bypass kit in the tubing ports of the DI packs.
- b. Turn on the system. On main screen select, access disinfection menu in **Service > Maintenance > Disinfection**. Follow prompts on the system screen to progress through disinfection process.

**Note:** Ensure the tank is full (if not, wait until it is full).

- c. Open new bottle of bleach. Prepare the proper amount of bleach per **Table 13**.

**Note:** The strength of commercially-available bleach can vary, so few most common concentrations are listed.

- d. Remove the user access cap from the top of the tank and pour in the premeasured bleach. Replace the cap.
- e. Press **Next**.
- f. At system prompt, press **Start** to start the system recirculation mode and let it run for an hour.
- g. Dispense equal amount of water through Type 1 and Type II dispensers, one at a time, until tank is empty.
- h. Press **Start** to start tank refill.
- i. Turn the system on and fill the tank to 100%. When the tank reaches 100%, the tank will be emptied from UF flush port automatically.
- j. System will repeat fill/drain process, for a total of two cycles.
- k. Install new DI Packs (refer to **DI Packs**).
- l. Replace POU final filter (refer to **0.1 µm POU Final Filter**).
- m. Replace UF if necessary (refer to **Ultrafilter**).
- n. System disinfection is now complete.



**Figure 89. Installation DI bypass Kit before the Disinfection Procedure**

# 7 Appendix

## 7.1 Troubleshooting

**Note:** Contact the service department if you cannot rectify these or other errors.

**Table 14. Troubleshooting of Aquanex System**

Issue	Possible Cause(s)	Possible Solution(s)
System does not power ON, Display is blank	<ul style="list-style-type: none"> <li>No supply of power.</li> <li>Power switched OFF.</li> <li>AC/DC external power supply or system control defect.</li> </ul>	<ul style="list-style-type: none"> <li>If green light on the adopter is not ON, check power supply connections.</li> <li>Press power ON switch on the display.</li> <li>Contact Thermo Fisher Scientific service department.</li> </ul>
Storage tank does not fill	<ul style="list-style-type: none"> <li>Feedwater supply is closed.</li> <li>Feedwater pressure is too low.</li> <li>Pretreatment cartridges are plugged/depleted.</li> <li>RO assembly is not connected or quick connects are not fully inserted.</li> <li>System is in the safe mode.</li> <li>System is depressurized.</li> <li>System component malfunction.</li> </ul>	<ul style="list-style-type: none"> <li>Open the feedwater supply line.</li> <li>Increase feedwater pressure.</li> <li>Replace pretreatment cartridges.</li> <li>Ensure RO assembly is properly installed.</li> <li>Clear alert/alarms and restart the system.</li> <li>Restart the system.</li> <li>Contact Thermo Fisher Scientific service department.</li> </ul>
No water is dispensed by the dispenser or dispense button is not responding	<ul style="list-style-type: none"> <li>Storage tank's water level is &lt; 10%.</li> <li>Type II water mode selected.</li> <li>Another type I dispenser is in use.</li> <li>Air may be trapped in the system.</li> <li>Dispenser connection loose or not connected.</li> <li>Main unit or dispenser malfunction.</li> </ul>	<ul style="list-style-type: none"> <li>Wait until the tank level is &gt;10%.</li> <li>Select the Type I mode on the main unit.</li> <li>Wait until the operation on the other type I dispenser is complete.</li> <li>Depressurize the system using the function in the maintenance menu.</li> <li>Reconnect both USB and 6-pin power port of the dispenser.</li> <li>Contact Thermo Fisher Scientific service department.</li> </ul>
Resistivity consistently drops below pure water limit	<ul style="list-style-type: none"> <li>DI packs are exhausted.</li> <li>Feed water conductivity is too high.</li> <li>Pure water conductivity cell may require recalibration.</li> </ul>	<ul style="list-style-type: none"> <li>Replace DI packs.</li> <li>Ensure feedwater conductivity is within operation range.</li> <li>Contact Thermo Fisher Scientific service department.</li> </ul>

**Table 14. Troubleshooting of Aquanex System (Continued)**

Issue	Possible Cause(s)	Possible Solution(s)
Leak is detected	<p>Leak sensor in contact with water.</p> <p>System waste tubes are causing the leak.</p> <p>Feedwater pressure exceeds operating limit.</p> <p>Leak triggered by excessive condensation.</p> <p>Improper seating of the tubes/components and the mating connection, or component defect.</p>	<p>Turn off the unit, unplug power supply and clear the leak on and around the leak sensor.</p> <p>Connect system waste and overflow tubes to atmospheric floor drain.</p> <p>Install Barnstead Pretreatment equipped with pressure regulator or a separately pressure regulator upstream of the system to achieve feedwater pressure within specified operation limits.</p> <p>Ensure the ambient conditions are within specified operation limits.</p> <p>Turn off the system and the feedwater source and reinstall the connection if accessible. If not, contact the Thermo Fisher Scientific service department.</p>
Dispense water flow rate is too low	<p>Volumetric dispense is too slow.</p> <p>Air may be trapped in the system.</p> <p>The 0.1 µm POU final filter is blocked.</p> <p>Ultrafilter (UF) is blocked.</p>	<p>Low water flow rate for small volumetric dispense is normal to achieve accuracy and to prevent spills.</p> <p>Depressurize the system using the function in the maintenance menu.</p> <p>Replace the 0.1 µm POU final filter.</p> <p>Replace the ultrafilter.</p>
Reduced lifetime of DI packs	<p>Poor feedwater quality.</p> <p>Pretreatment cartridges are exhausted.</p> <p>RO concentrate and permeate flow connections are reversed.</p> <p>RO assembly is damaged or at the end of life.</p> <p>Increased product water usage.</p> <p>The system is in Water Saver or Dynamic Mode.</p> <p>CO<sub>2</sub> adsorber and sterile filter.</p>	<p>Ensure the system is in Pack Saver mode to maximize the DI cartridge life.</p> <p>Replace pretreatment cartridges.</p> <p>Install the RO assembly connections correctly.</p> <p>Replace the RO assembly.</p> <p>Increased product water usage will result in shorter DI cartridge life.</p> <p>Water saver and dynamic modes may result into shorter DI cartridge life. Select Pack Saver mode to maximize the DI cartridge life.</p> <p>Ensure that the CO<sub>2</sub> adsorber and sterile filter is installed and replaced at recommended intervals.</p>



**Table 14. Troubleshooting of Aquanex System (Continued)**

Issue	Possible Cause(s)	Possible Solution(s)
Reduced lifetime of RO assembly	<p>Poor feedwater quality.</p> <p>Pretreatment cartridges are exhausted.</p> <p>Feedwater pressure exceeds operating limit.</p> <p>The system in Water Saver or Dynamic Mode.</p>	<p>Ensure that the feedwater quality is within specified operating limit. Install an appropriate pretreatment system upstream of the system.</p> <p>Replace pretreatment cartridges.</p> <p>Install Barnstead Pretreatment equipped with pressure regulator or a separately pressure regulator upstream of the system to achieve feedwater pressure within specified operation limits.</p> <p>If the feedwater conductivity is too high, it may shorten the RO life in Water saver and Dynamic modes. Select Pack Saver mode to maximize the RO assembly life.</p>
Reduced lifetime of Ultrafilter	<p>Poor sanitation of the system.</p> <p>Product water tank lid is kept open.</p>	<p>Follow the disinfection procedure using the function in the maintenance menu.</p> <p>Ensure to keep the product water tank access lid is closed at all times to prevent the incorporation of foreign matter.</p>

## 7.2 Full List of Aquanex Alarms and Alerts

Table 15. List of Aquanex Alarms (Red Alarm-Bell)

Alarm Messages	Cause	Solution
<p><b>Title:</b> High Product Water Temperature</p> <p><b>Message:</b> The Product water temperature is higher than the set value</p>	Recirculation water temperature set limit reached	<p>Check set temperature.</p> <p>Confirm lab ambient temperature meets specification.</p> <p>Confirm from Diagnostic screen that feedwater temperature meets temperature specification.</p> <p>Manually turn UV off for few minutes.</p> <p>Drain water in the tank using manual value to achieve fast reduction in temperature.</p> <p>If problem persists, contact the Thermo Fisher Scientific service department.</p>
<p><b>Title:</b> Leak detected</p> <p><b>Message:</b> Water leak detected at the leak sensor</p>	Water leak detected in and around the system	<p>System automatically enters safe mode until alarm is addressed. User is advised to check for leaks and clean the leaked water on and around the leak detector (Internal and/or external) prior to acknowledging the alarm.</p> <p><b>Note:</b> 30L system comes with an internal and external leak detector.</p> <p>If problem persists, do not operate the system, and contact the Thermo Fisher Scientific service department.</p>
<p><b>Title:</b> High Pressure Detected</p> <p><b>Message:</b> Recirculation pressure is too high</p>	DI pressure > 90 PSI	<p>Confirm both A and B DI packs are installed correctly.</p> <p>If problem persists, do not operate the system, and contact the Thermo Fisher Scientific service department.</p>
<p><b>Title:</b> High Pressure Detected</p> <p><b>Message:</b> RO input pressure is too high</p>	RO pressure > 105 PSI	<p>Ensure that the feedwater pressure is &lt; 87 PSI in the diagnostic screen.</p> <p>Check if feedwater connection to RO assembly is properly installed.</p> <p>Check the diagnostic screen for RO replacement date. Replace RO assembly in case the end of life is reached.</p> <p>If problem persists, do not operate the system, and contact the Thermo Fisher Scientific service department.</p>
<p><b>Title:</b> High FeedWater Pressure</p> <p><b>Message:</b> Feedwater pressure is too high</p>	Feedwater pressure > 87 PSI	<p>Check if feedwater connection to RO assembly is properly installed.</p> <p>Ensure that a Barnstead Pretreatment system or a pressure reducer upstream of the system is installed.</p> <p>If problem persists, do not operate the system, and contact the Thermo Fisher Scientific service department.</p>

**Table 16. List of Aquanex Alerts (Yellow Alert)**

Alert Message	Cause	Solution
<p><b>Title:</b> Low Product Water Quality</p> <p><b>Message:</b> The product water resistivity has dropped below the set value</p>	<p>Resistivity/Conductivity is lower than the default setting (default 15 MΩ·cm)</p>	<p>System allows a setting range of 1.0-18.2 MΩ·cm. Ensure the set value is at a desired setting to avoid unnecessary Alerts.</p> <p>Check in diagnostic screen if it is time to change the DI packs.</p> <p>If the new DI packs were recently installed and problem persists, contact the Thermo Fisher Scientific service department.</p>
<p><b>Title:</b> Feedwater pressure low</p> <p><b>Message:</b> Feedwater pressure is too low</p>	<p>Pressure less than 15 PSI</p>	<p>Check feedwater pressure in the diagnostic screen when unit is filling the tank.</p> <p>When system is filling the tank, check the pressure drop across the pretreatment cartridges in the Barnstead Pretreatment system. Replace pretreatment cartridges in case it is time for replacement.</p> <p>Contact the Thermo Fisher Scientific service department.</p>
<p><b>Title:</b> UV Lamp Replacement</p> <p><b>Message:</b> Ultraviolet (UV) lamp may require replacement</p>	<p>Consumable Replacement reminder alert</p>	<p>Acknowledge the Alert.</p> <p>Follow the steps mentioned in the Maintenance section to replace the respective consumable.</p>
<p><b>Title:</b> Ultrafilter Replacement</p> <p><b>Message:</b> Ultrafilter may require replacement</p>	<p>Consumable Replacement reminder alert</p>	<p>Acknowledge the Alert.</p> <p>Follow the steps mentioned in the Maintenance section to replace the respective consumable.</p>
<p><b>Title:</b> DI Packs Replacement</p> <p><b>Message:</b> Deionization (DI) packs may require replacement</p>	<p>Consumable Replacement reminder alert</p>	<p>Acknowledge the Alert.</p> <p>Follow the steps mentioned in the Maintenance section to replace the respective consumable.</p>
<p><b>Title:</b> RO Assembly Replacement</p> <p><b>Message:</b> RO Assembly may require replacement</p>	<p>Consumable Replacement reminder alert</p>	<p>Acknowledge the Alert.</p> <p>Follow the steps mentioned in the Maintenance section to replace the respective consumable.</p>
<p><b>Title:</b> POU Final Filter Replacement</p> <p><b>Message:</b> POU may require replacement for DI</p>	<p>Consumable Replacement reminder alert</p>	<p>Acknowledge the Alert</p> <p>Follow the steps mentioned in the Maintenance section to replace the respective consumable.</p>

**Table 16. List of Aquanex Alerts (Yellow Alert) (Continued)**

<b>Alert Message</b>	<b>Cause</b>	<b>Solution</b>
<b>Title:</b> POU Final Filter Replacement <b>Message:</b> POU may require replacement for D2	Consumable Replacement reminder alert	Acknowledge the Alert. Follow the steps mentioned in the Maintenance section to replace the respective consumable.
<b>Title:</b> CO <sub>2</sub> Adsorber Replacement <b>Message:</b> CO <sub>2</sub> adsorber may require replacement	Consumable Replacement reminder alert	Acknowledge the Alert. Follow the steps mentioned in the Maintenance section to replace the respective consumable.

## 7.3 Aquanex Accessories

**Table 17. Optional Aquanex Accessories**

<b>Item Description</b>	<b>Item No.</b>
External Barnstead pretreatment	50157886
Aquanex Touch Smart Dispenser for Type I water	7601040
Accessory Type II water hand dispenser	50138221
Sterile tank overflow for 30L tank	06.5001
CO <sub>2</sub> Adsorber and Sterile Filter	06.5002
Aquanex Wall bracket	7601060
Type II Water Hand Dispenser	50138221

# 8 Warranty

## 8.1 Warranty Information

Thermo Fisher Scientific warrants the operational safety and functions of the Thermo Scientific Aquanex Ultrapure Water Purification Systems only under the condition that:

- The system is installed and operated as per the operation manual. Do not use this product for anything other than its intended use.
- Thermo Fisher Scientific recommended, or equivalent pretreatment is purchased with the system for longevity of system parts and consumables.
- Barnstead Pretreatment is highly recommended but not mandatory to purchase.

**WARNING:** If the system is used without Barnstead Pretreatment, then users should purchase and install a separate pressure reducer in the feedwater line, otherwise there is a high chance of leakage in the system and the potential for subsequent system failure. See **Technical Specifications** for requirements.

**Note:** All warranty claims are dependent on the following:

- Only original spare parts and accessories that have been approved by Thermo Fisher Scientific are used (third-party spares without Thermo Fisher Scientific approval will void the limited warranty).
- Inspections and maintenance are performed at the specified intervals.
- An installation verification test is performed on commissioning the system for the first time and repeated after each preventative maintenance and repair activity.
- The warranty is valid from the date of delivery of the system to the customer.
- The above mentioned warranty conditions are subject to the general terms and conditions of sale, in effect at the time of purchase, which apply as well.

This page is  
intentionally  
left blank.

## IF YOU NEED ASSISTANCE:

Thermo Fisher Scientific products are backed by a global technical support team ready to support your applications. We offer cold storage accessories, including remote alarms, temperature recorders, and validation services.

Visit [www.thermofisher.com/](http://www.thermofisher.com/) or call:

Countries	Sales	Services
North America	+1 866 984 3766	(800) 438-4851
India	1800 22 8374, +91 22 6716 2200	+91 22 6716 2200
China	+800 810 5118, +400 650 5118	+8621 68654588
Japan	+81 3 5826 1616	+81 3 3816 3355
Australia	+61 39757 4300	1 300 735 292
Austria	+43 1 801 40 0	+43 1 801 40 0
Belgium	+32 53 73 42 41	+32 2 482 30 30
France	+33 2 2803 2180	+33 2 2803 2180
Germany	0800 1 536 376, +49 6184 90 6000	0800 1 536 376
Italy	+32 02 95059 552	+39 02 95059 552, 432 254 375
Netherlands	+31 76 579 55 55	+31 76 571 4440
Nordic/Baltic/CIS	+358 9 329 10200	+358 9 329 100
Russia	+7 812 703 4215	+7 812 703 4215
Spain/Portugal	+34 93 223 09 18	+34 93 223 09 18
Switzerland	+41 44 454 12 22	+41 44 454 12 12
UK/Ireland	+44 870 609 9203	+44 870 609 9203
New Zealand	+64 9 980 6700	+64 9 980 6700
Other Asian Countries	+852 2885 4613	+852 2885 4613
Countries not listed	+49 6184 90 6000	+49 6184 90 6000

Thermo Fisher Scientific Inc.  
 275 Aiken Road  
 Asheville, NC 28804  
 United States

Find out more at [thermofisher.com/](http://thermofisher.com/)

This page is  
intentionally  
left blank.