

UNI-T®

Instruments.uni-trend.com

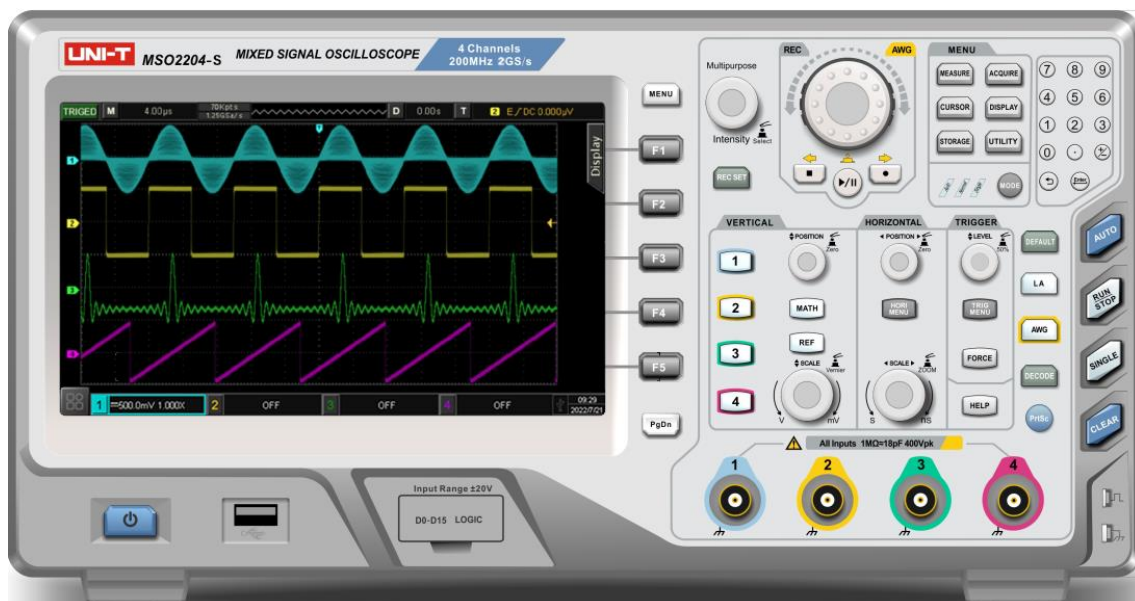

Programming Manual

MSO/UP02000 Series Digital Phosphor Oscilloscope

Warranty and Statement

Copyright

2023 Uni-Trend Technology (China) Co., Ltd.

Brand Information

UNI-T is the registered trademark of Uni-Trend Technology (China) Co., Ltd.

Software Version

01.05.0075

Software upgrade may have some change and add more function, please subscribe UNI-T website to get the new version or contact UNI-T.

Statement

- UNI-T products are protected by patents (including obtained and pending) in China and other countries and regions.
- UNI-T reserves the right to change specifications and prices.
- The information provided in this manual supersedes all previous publications.
- Information provided in this manual is subject to change without prior notice.
- UNI-T shall not be liable for any errors that may be contained in this manual. For any incidental or consequential damages, arising out of the use or the information and deductive functions provided in this manual.
- Without the written permission of UNI-T, this manual cannot be photocopied, reproduced or adapted.

Product Certification

UNI-T has certified that the product conforms to China national product standard and industry product standard as well as ISO9001:2008 standard and ISO14001:2004 standard.

UNI-T will go further to certify product to meet the standard of other member of the international standards organization.

Contact Us

If you have any question or problem, please contact UNI-T.

Official website : <https://www.uni-trend.com>

SCPI

SCPI was defined as an additional layer on top of the IEEE 488.2-1987 specification "Standard Codes, Formats, Protocols, and Common Commands". The standard specifies a common syntax, command structure, and data formats, to be used with all instruments. It introduced generic commands (such as CONFigure and MEASure) that could be used with any instrument. These commands are grouped into subsystems. SCPI also defines several classes of instruments. For example, any controllable power supply would implement the same DCPSUPPLY base functionality class. Instrument classes specify which subsystems they implement, as well as any instrument-specific features.

The physical hardware communications link is not defined by SCPI. While it was originally created for the IEEE-488.1 (GPIB) bus, SCPI can also be used with RS-232, RS-422, Ethernet, USB, VXIbus, HiSLIP, etc.

SCPI commands are ASCII textual strings, which are sent to the instrument over the physical layer (e.g., IEEE-488.1). Commands are a series of one or more keywords, many of which take parameters. In the specification, keywords are written CONFIGure: The entire keyword can be used, or it can be abbreviated to just the uppercase portion. Responses to query commands are typically ASCII strings. However, for bulk data, binary formats can be used.

This section introduces the format, symbols, parameters, and abbreviations of the SCPI command.

Instruction Format

The SCPI command is a tree-like hierarchy consisting of multiple subsystems, each consisting of a root keyword and one or more hierarchical key words. **The command line usually begins with a colon ":"; Keywords are separated by the colon ":", followed by optional parameter settings. The command keyword is separated by spaces from the first parameter. The command string must end with a newline <NL> character. Add the question mark "?" after the command line. It is usually indicated that this feature is being queried.**

Symbol Description

The following four symbols are not part of SCPI command, it cannot send with the command. It usually used as supplementary description of command parameter.

- **Brace { }** usually contains multiple optional parameters, it should select one parameter when send command.
Such as DISPLAY:GRID:MODE { FULL | GRID | CROSS | NONE} command
- **Vertical Bar |** used to separated multiple parameters, it should select one parameter when send command.
Such as DISPLAY:GRID:MODE { FULL | GRID | CROSS | NONE} command
- **Square Brackets []** the contents in square brackets (command keywords) can omissible. If the parameter is ignored, the instrument will set the parameter as the default value.
Such as MEASure:NDUTy? [<source>] command, it presents current channel
- **Triangular Brackets <>** the parameter in the brackets must be replaced with a valid value.
Such as use DISPLAY:GRID:BRIGhtness 30 form to send DISPLAY:GRID:BRIGhtness <count> command

Parameter Description

The parameter in this manual can divide into five types: Boolean, Integer, Real, Discrete, ASCII string

- **Boolean**

Parameter value can set "ON" (1) or "OFF" (0)

Such as SYSTem:LOCK {{1|ON}|{0|OFF}}

- **Integer**

Parameter can take any valid integer value unless there have some other descriptions.

Such as command: DISPlay:GRID:BRIGhtness <count> , parameter of <count> can take integer from 0~100

Note: Do not set decimal as parameter, otherwise it may occur error.

- **Real**

Parameter can take any valid integer value unless there have some other descriptions.

Such as for command CH1, CHANnel: OFFSet <offset>, parameter of <offset> can take integer value.

- **Discrete**

Parameter can only take some specified numbers or characters.

Such as command DISPlay:GRID:MODE { FULL | GRID | CROSS | NONE} parameter can only take FULL, GRID, CROSS, NONE

- **ASCII Character String**

String parameter contain all ASCII string sets. Strings must begin and end with paired quotes; it can use single or double quotation marks. The quotation and delimiter can also be part of a string by typing it twice and not adding any characters.

Such as set IP SYST:COMM:LAN:IPAD "192.168.1.10"

Shorthand Rule

All command can identify capital and small letter, if command need enter shorthand, it should be all capital letter.

Data Return

Data return is divided into single data and batch data. The single data return is the corresponding parameter type, in which the real return type is express in scientific notation. The part before e retains three figure behind the decimal point, and the e part retains three figure; the batch return must be obey IEEE

488.2# string data format, '#'+ the length of character bits [fixed to one character] + ASCII valid value+ valid data+ end string ['\n']

Such as #3123xxxxxxxxxxxxxxxxxxxx\n presents 123 strings batch data return format, '3' presents "123" occupies three character bits.

Note: If return data is invalid data, use * to represent it.

SCPI Command Explanation

IEEE488.2 Common Command

*IDN?

➤ **Command format:**

*IDN?

➤ **Functional description:**

For querying manufacture name, model, product serial number and software version.

➤ **Return format:**

Manufacture name, model, product serial number, software version separated by dot mark.

➤ **For example:**

UNI-T Technologies, MS02000CS, MS01000, 00.00.01

*RST

➤ **Command format:**

*RST

➤ **Functional description:**

Restore factory settings and clear the entire error message, send and receive queue buffers.

*OPC

➤ **Command format:**

*OPC

*OPC?

➤ **Functional description:**

This command is used to force the current instruction to complete and marked as the mark position 1.

➤ **Return format:**

Query returns whether the currently send instruction is executed, 1 represents it's completed, 0 represents it's not complete.

➤ **For example:**

*OPC

Mark the executed instruction at mark position 1.

*OPC?

Query returns 1, it represents the command is executed. Otherwise, it's not.

SYSTem Command

The command is used for the basic operation of oscilloscope, including operating control, full keyboard lock, error queue and system data setting.

:RUN➤ **Command format:**

:RUN

➤ **Functional description:**

This command is used to start the sampling operating of the oscilloscope, if it need to stop, executing: STOP command.

:STOP➤ **Command format:**

:STOP

➤ **Functional description:**

This command is used to stop the sampling operating of the oscilloscope, if it need to restart, executing: RUN command.

:AUTO➤ **Command format:**

:AUTO

➤ **Functional description:**

This command is used to automatically set the control parameter of the instrument, the automatic setting can make the best display effect for the input waveform.

:SYSTem:LOCK➤ **Command format:**

:SYSTem:LOCK {{1|ON}}|{0|OFF}}

:SYSTem:LOCK?

➤ **Functional description:**

This command is used to lock/unlock full keyboard.

➤ **Return format:**

Query returns full keyboard locked status, 0 represents locked, 1 represents unlock.

➤ **For example:**

:SYSTem:LOCK ON/:SYST:LOCK 1

Full keyboard locked.

:SYSTem:LOCK OFF/:SYST:LOCK 0

Unlock full keyboard.

:SYSTem:LOCK?

Query returns 1, it represents locked.

:SYSTem:ERRor➤ **Command format:**

:SYSTem:ERRor

:SYSTem:ERRor?

➤ **Functional description:**

This command is used to empty error message queue.

➤ **Return format:**

Query returns the last error message, Query returns error message in the format of "<Message number>, <Message content>. <Message number> is an integer; <Message content> is an ASCII character string with double quotation marks.

Such as -113,"Undefined header; command cannot be found".

➤ **For example:**

:SYSTem:ERR	Empty error message queue.
:SYSTem:ERR?	Query returns -113,"Undefined header; command cannot be found".

:SYSTem:SETup

➤ **Command format:**

```
:SYSTem:SETup <setup_data>
:SYSTem:SETup?
```

➤ **Functional description:**

This command is used to configure the system setting data. <setup_data> is conform to the [Appendix 2: IEEE 488.2 binary data format](#).

➤ **Return format:**

Query returns the system setting data.

:SYSTem:LANGuage

➤ **Command format:**

```
:SYSTem:LANGuage { ENGLish | SIMPLifiedchinese | TRADitionalchinese }
:SYSTem:LANGuage?
```

➤ **Functional description:**

This command is used to set the system lanauage.

➤ **Return format:**

Query returns { ENGLish | SIMPLifiedchinese | TRADitionalchinese }

➤ **For example:**

:SYSTem:LANGuage ENGL	Set the system language to English.
:SYSTem:LANGuage?	Query returns ENGLish.

:SYSTem:RTC

➤ **Command format:**

```
:SYSTem:RTC <year>,<month>,<day>,<hour>,<minute>,<second>
:SYSTem:RTC?
```

➤ **Functional description:**

This command is used to set the system time.

➤ **Return format:**

Query returns year, month, date, hour, minute and second.

➤ **For example:**

:SYSTem:RTC 2017,7,7,20,8,8	Set the system time to 20:08:08, 7 th , July, 2017.
:SYSTem:RTC?	Query returns 2017,7,7,20,8,8.

:SYSTem:CAL

- **Command format:**
:SYSTem:CAL
- **Functional description:**
This command is used to set the self-calibration of the system, it cannot be normal communicated during self-calibration.

:SYSTem:CLEAR

- **Command format:**
:SYSTem:CLEAR
- **Functional description:**
Empty all the saved waveforms and data settings.

:SYSTem:CYM0meter

- **Command format:**
:SYSTem:CYM0meter {1|ON}|{0|OFF}
:SYSTem:CYM0meter?
- **Functional description:**
This command is used to turn on/off the frequency meter.
- **Return format:**
Query returns the status of frequency meter, 1 represents ON, 0 represents OFF.
- **For example:**
:SYSTem:CYM0meter ON Turn on frequency meter.
:SYSTem:CYM0meter? Query returns 1.

:SYSTem:CYM0meter:FREQuency?

- **Command format:**
:SYSTem:CYM0meter:FREQuency?
- **Functional description:**
This command is used to acquire the frequency value of the frequency meter measurement.
- **Return format:**
Query returns the frequency value of the frequency meter measurement, and invalid value returns *.
- **For example:**
:SYSTem:CYM0meter:FREQuency? Query returns 1.20000E+3.

:SYSTem:SQUare:SELEct

- **Command format:**
:SYSTem:SQUare:SELEct { 10 Hz | 100 Hz | 1 kHz | 10 kHz }
:SYSTem:SQUare:SELEct?
- **Functional description:**
This command is used to select square wave output.

➤ **Return format:**

Query returns { 10 Hz | 100 Hz | 1 kHz | 10 kHz }.

➤ **For example:**

:SYSTem:SQUare:SElect 10 Hz Select 10 Hz square wave output.

:SYSTem:SQUare:SElect? Query returns 10 Hz.

:SYSTem:OUTPut:SElect

➤ **Command format:**

:SYSTem:OUTPut:SElect { TRIGger | PASS_FAIL }

:SYSTem:OUTPut:SElect?

➤ **Functional description:**

This command is used to set output selection TRIGger or PASS_FAIL (pass&fail) .

➤ **Return format:**

Query returns { TRIGger | PASS_FAIL }.

➤ **For example:**

:SYSTem:OUTPut:SElect TRIG Output selection sets to trigger.

:SYSTem:OUTPut:SElect? Query returns TRIG.

:SYSTem:MNUDisplay

➤ **Command format:**

:SYSTem:MNUDisplay { 5S | 10S | 20S | INFinite }

:SYSTem:MNUDisplay?

➤ **Functional description:**

This command is used to set the menu display time, INFinite represents the menu is always displayed.

➤ **Return format:**

Query returns { 5S | 10S | 20S | INFinite }.

➤ **For example:**

:SYSTem:MNUDisplay 5S

Set the menu display time to 5 s, the menu will automatically withdraw after 5 s.

:SYSTem:MNUDisplay? Query returns 5 s.

:SYSTem:BRIGhtness

➤ **Command format:**

:SYSTem:BRIGhtness <count>

:SYSTem:BRIGhtness?

➤ **Functional description:**

This command is used to set the screen brightness, <count> takes value from 1~100, the bigger the number, the brighter the screen.

➤ **Return format:**

Query returns the current screen brightness.

➤ **For example:**

:SYSTem:BRIGhtness 50 Set screen brightness to 50.

:SYSTem:BRIGhtness? Query returns 50.

:SYSTem:VERSion?

- **Command format:**
:SYSTem:VERSion?
- **Return format:**
Query returns version information, which are 128 bytes character string.
HW is hardware version number, SW is software version number, PD is created date, ICV is protocol version number.
- **For example:**
:SYST:VERS? Query returns HW:1.0;SW:1.0;PD:2014-11-20;ICV:1.4.0.

:SYSTem:COMMunicate:LAN:APPLY

- **Command format:**
:SYSTem:COMMunicate:LAN:APPLY
- **Functional description:**
This command is used to take effect the current network parameter immediately.

:SYSTem:COMMunicate:LAN:GATEway

- **Command format:**
:SYSTem:COMMunicate:LAN:GATEway <gateway>
:SYSTem:COMMunicate:LAN:GATEway?
- **Functional description:**
This command is used to set the default gateway. <gateway> is belong to the parameter of ASCII character string, the format is xxx.xxx.xxx.xxx.
- **Return format:**
Query returns the default gateway.
- **For example:**
:SYST:COMM:LAN:GATE "192.168.1.1" Set the default gateway to 192.168.1.1.
:SYST:COMM:LAN:GATE? Query returns 192.168.1.1.

:SYSTem:COMMunicate:LAN:SMASK

- **Command format:**
:SYSTem:COMMunicate:LAN:SMASK <submask>
:SYSTem:COMMunicate:LAN:SMASK?
- **Functional description:**
This command is used to set subnet mask. <submask> is belong to the parameter of ASCII character string, the format is xxx.xxx.xxx.xxx.
- **Return format:**
Query returns subnet mask.
- **For example:**
:SYST:COMM:LAN:SMASK "255.255.255.0" Set subnet mask to 255.255.255.0.
:SYST:COMM:LAN:SMASK? Query returns 255.255.255.0.

:SYSTem:COMMunicate:LAN:IPADdress➤ **Command format:**

```
:SYSTem:COMMunicate:LAN:IPADdress <ip>
```

```
:SYSTem:COMMunicate:LAN:IPADdress?
```

➤ **Functional description:**

This command is used to set IP address. <ip> is belong to the parameter of ASCII character string, the format is xxx.xxx.xxx.xxx.

➤ **Return format:**

Query returns IP address.

➤ **For example:**

```
:SYST:COMM:LAN:IPAD "192.168.1.10"      Set IP address to 192.168.1.10.
```

```
:SYST:COMM:LAN:IPAD?                    Query returns 192.168.1.10.
```

:SYSTem:COMMunicate:LAN:DHCP➤ **Command format:**

```
:SYSTem:COMMunicate:LAN:DHCP {[1|ON]}{[0|OFF]}
```

```
:SYSTem:COMMunicate:LAN:DHCP?
```

➤ **Functional description:**

This command is used to switch the configuration mode to automatic IP or manual IP.

➤ **Return format:**

Query returns dynamic allocation mode, 0 represents manual IP, 1 represents automatic IP.

➤ **For example:**

```
:SYST:COMM:LAN:DHCP ON                  Turn on IP dynamic allocation.
```

```
:SYST:COMM:LAN:DHCP?                   Query returns 1.
```

:SYSTem:COMMunicate:LAN:MAC?➤ **Command format:**

```
:SYSTem:COMMunicate:LAN:MAC?
```

➤ **Return format:**

Query returns MAC physical address.

➤ **For example:**

```
:SYST:COMM:LAN:MAC?                    Query returns 00-2A-A0-AA-E0-56.
```

:SYSTem:AUTO:CHANnel➤ **Command format:**

```
:SYSTem:AUTO:CHANnel {AUTO|KEEP}
```

```
:SYSTem:AUTO:CHANnel?
```

➤ **Functional description:**

This command is used to set whether the channel keeps the current status when in automatic setting.

AUTO represents that the channel is automatically set by the preset parameter; KEEP represents that the

channel is automatically set based on the current status.

➤ **Return format:**

Query {AUTO|KEEP}.

➤ **For example:**

:SYSTem:AUTO:CHANnel KEEP

The channel keeps the automatic setting of the current status.

:SYSTem:AUTO:CHANnel? Query returns KEEP.

:SYSTem:AUTO:ACQuire

➤ **Command format:**

:SYSTem:AUTO:ACQuire {AUTO|KEEP}

:SYSTem:AUTO:ACQuire?

➤ **Functional description:**

This command is used to set whether the sampling mode keeps the current status.

AUTO represents that the sampling mode is automatically set by the preset parameter; KEEP represents that the sampling mode is automatically set based on the current status.

➤ **Return format:**

Query {AUTO|KEEP}.

➤ **For example:**

:SYSTem:AUTO:ACQuire KEEP

The sampling mode keeps the automatic setting of the current status.

:SYSTem:AUTO:ACQuire? Query returns KEEP.

:SYSTem:AUTO:TRIGger

➤ **Command format:**

:SYSTem:AUTO:TRIGger {AUTO|KEEP}

:SYSTem:AUTO:TRIGger?

➤ **Functional description:**

This command is used to set whether the trigger keeps the current status.

AUTO represents that the trigger is automatically set by the preset parameter; KEEP represents that the trigger is automatically set based on the current status.

➤ **Return format:**

Query {AUTO|KEEP}.

➤ **For example:**

:SYSTem:AUTO:TRIGger KEEP

The trigger keeps the automatic setting of the current status.

:SYSTem:AUTO:TRIGger? Query returns KEEP.

:SYSTem:AUTO:SIGNal

➤ **Command format:**

:SYSTem:AUTO:SIGNal {AUTO|KEEP}

:SYSTem:AUTO:SIGNal?

➤ **Functional description:**

This command is used to set whether the channel for input signal (Active channel) keeps the current status when in automatic setting.

AUTO represents that the active channel is automatically set by the preset parameter; KEEP represents by the the active channel is automatically set based on the current status.

➤ **Return format:**

Query {AUTO|KEEP}.

➤ **For example:**

:SYSTem:AUTO:SIGNal KEEP

The active channel keeps the automatic setting of the current status.

:SYSTem:AUTO:SIGNal? Query returns KEEP.

KEY Command

This command is used to control the key and rotary knob on the operating panel of the oscilloscope.

:KEY:<key>

➤ **Command format:**

:KEY:<key>

:KEY:<key>:LOCK {{1|ON}|{0|OFF}}

:KEY:<key>:LOCK?

:KEY:<key>:LED?

➤ **Functional description:**

This command is used to set key function and lock/unlock function. <key> definition and description refer to [Appendix 1: Key List](#)

➤ **Return format:**

Query returns key status or LED indicator status;

Lock status: 0 represents the key is unlock, 1 represents the key is locked;

LED status: 0 represents LED indicator is lightless, 1 represents LED indicator is lit up. For RUN/STOP key, 0 represents in red, 1 represents in green.

➤ **For example:**

:KEY:AUTO

Automatically set the each control parameter of the oscilloscope.

:KEY:AUTO:LOCK ON/OFF Lock/unlock key.

:KEY:AUTO:LOCK? Query returns key status, 1 represents the key is locked.

:KEY:AUTO:LED?

Query returns LED status, 0 represents LED indicator is lightless.

CHANnel Command

This command is used to set each channel independently. <n> takes value from 1/2/3/4, it represents {CH1/CH2/CH3/ CH4} separately.

:CHANnel<n>:BWLimit➤ **Command format:**`:CHANnel<n>:BWLimit {{1|ON}}{0|OFF}}``:CHANnel<n>:BWLimit?`➤ **Functional description:**

This command is used to set the bandwidth limit to ON or OFF.

ON: turn on bandwidth limit to 20 MHz, to reduce display noise.

OFF: turn off bandwidth limit to achieve full bandwidth display.

<n>: {1|2|3|4}, it represents {CH1|CH2|CH3|CH4} separately.

➤ **Return format:**

Query returns 1 or 0, it represents ON or OFF separately.

➤ **For example:**`:CHAN1:BWL ON`

Turn on the bandwidth limit of channel 1.

`:CHAN1:BWL?`

Query returns 1, it represents the bandwidth limit of channel 1 is turned on.

:CHANnel<n>:COUPling➤ **Command format:**`:CHANnel<n>:COUPling {DC|AC|GND}``:CHANnel<n>:COUPling?`➤ **Functional description:**

This command is used to set the channel coupling mode. DC represents the AC and DC component that can be through the input signal; AC represents the DC component that blocks the input signal; GND represents cut-off the input signal.

<n>: {1|2|3|4}, it represents {CH1|CH2|CH3|CH4} separately.

➤ **Return format:**

Query AC, DC or GND.

➤ **For example:**`:CHAN1:COUP DC`

Set the coupling mode of channel 1 to DC.

`:CHAN1:COUP?`

Query returns DC.

:CHANnel<n>:DISPlay➤ **Command format:**`:CHANnel<n>:DISPlay {{1|ON}}{0|OFF}}``:CHANnel<n>:DISPlay?`➤ **Functional description:**

This command is used to turn on/off the specified channel.

<n>: {1|2|3|4}, it represents {CH1|CH2|CH3|CH4} separately.

➤ **Return format:**

Query returns 1 or 0, it represents ON or OFF separately.

➤ **For example:**`:CHAN1:DISP ON`

Turn on Channel 1.

:CHAN1:DISP?

Query returns 1, it represents the channel 1 is turned on.

:CHANnel<n>:INVert

➤ **Command format:**

:CHANnel<n>:INVert { {1|ON} | {0|OFF} }

:CHANnel<n>:INVert?

➤ **Functional description:**

This command is used to turn on/off the waveform phase reverse.

ON: turn on the waveform phase reverse.

OFF: restore the waveform to normal display.

<n>: {1|2|3|4}, it represents {CH1|CH2|CH3|CH4} separately.

➤ **Return format:**

Query returns 1 or 0, it represents ON or OFF.

➤ **For example:**

:CHAN1:INV OFF

Turn off the phase reverse of channel 1.

:CHAN1:INV?

Query returns 0, it represents the phase reverse of channel 1 is turned off.

:CHANnel<n>:PROBe

➤ **Command format:**

:CHANnel<n>:PROBe { <probe> | 0.001X | 0.01X | 0.1X | 1X | 10X | 100X | 1000X }

:CHANnel<n>:PROBe?

➤ **Functional description:**

This command is used to set the probe attenuation factor which corresponding to probe,probe attenuation range 0.001X~1000X.

<probe>: Self-defined probe attenuation factor.

<n>: {1|2|3|4}, it represents {CH1|CH2|CH3|CH4} separately.

➤ **Return format:**

Query returns if the probe attenuation factor of the oscilloscope is self-defind, it returns the current probe attenuation value in scientific notation, unit is X.

➤ **For example:**

:CHAN1:PROB 10X

Set the probe attenuation factor of channel 1 to 10.

:CHAN1:PROB?

Query returns 1.000000e+01.

:CHANnel<n>:OFFSet

➤ **Command format:**

:CHANnel<n>:OFFSet <offset>

:CHANnel<n>:OFFSet?

➤ **Functional description:**

This command is used to set the waveform displacement on vertical direction.

<n>: {1|2|3|4|5|6|7|8|9}, it represents {CH1|CH2|CH3|CH4|MATH|REFA|REFB|REFC|REFD} separately.

➤ **Return format:**

Query returns the setting value of offset in scientific notation. Unit is related to :CHANnel<n>:UNITs.

➤ **For example:**

:CHAN1:OFFS 20V

Set the vertical displacement of channel 1 to 20 V.

:CHAN1:OFFS?

Query returns 2.000e001.

:CHANnel<n>:SCALe

➤ **Command format:**

:CHANnel<n>:SCALe {<scale> | UP | DOWN}

:CHANnel<n>:SCALe?

➤ **Functional description:**

This command is used to set volts/div scale on vertical direction.

<scale>: Volts/div scale value;

UP: Increase one scale based on the current scale of the oscilloscope;

DOWN: Decrease one scale based on the current scale of the oscilloscope.

<n>: {1|2|3|4|5|6|7|8|9}, it represents {CH1|CH2|CH3|CH4|MATH|REFA|REFB|REFC|REFD} separately.

➤ **Return format:**

Query returns the current volts/div scale vaule in scientific notation. Unit is related to :CHANnel<n>:UNITs.

➤ **For example:**

:CHAN1:SCAL 20V

Set the volts/div scale of channel 1 to 20 V.

:CHAN1:SCAL?

Query returns 2.000e001.

:CHAN1:SCAL UP

Increase one scale based on 20 V volts/div scale.

:CHANnel<n>:UNITs

➤ **Command format:**

:CHANnel<n>:UNITs {VOLTs|AMPPeres|WATTs|UNKNown}

:CHANnel<n>:UNITs?

➤ **Functional description:**

This command is used to set the channel unit to VOLTs, AMPPeres, WATTs or UNKNown.

<n>: {1|2|3|4}, it represents {CH1|CH2|CH3|CH4}.

➤ **Return format:**

Query returns VOLTs, AMPPeres, WATTs or UNKNown.

➤ **For example:**

:CHAN1:UNIT VOLT

Set the unit of channel 1 to VOLTs.

:CHAN1:UNIT?

Query returns VOLTs.

:CHANnel<n>:VERNier

➤ **Command format:**

:CHANnel<n>:VERNier { {1|ON} | {0|OFF} }

:CHANnel<n>:VERNier?

➤ **Functional description:**

This command is used to set scale adjusting mode. If scale adjusting mode sets to ON, which is fine tuning.

Fine tuning can further subdivided within coarse tuning range for improving vertical resolution; if scale

adjusting mode sets to OFF, which is coarse tuning. It can adjust vertical sensitivity by system 1-2-5.

<n>: {1|2|3|4}, it represents {CH1|CH2|CH3|CH4} separately.

➤ **Return format:**

Query returns 1 or 0, it represents ON or OFF.

➤ **For example:**

:CHAN1:VERN ON

Turn on fine tuning of channel 1.

:CHAN1:VERN?

Query returns 1.

:CHANnel<n>:SElect

➤ **Command format:**

:CHANnel<n>:SElect

:CHANnel<n>:SElect?

➤ **Functional description:**

This command is used to select channel.

<n>: {1|2|3|4|5|6|7|8|9}, it represents {CH1|CH2|CH3|CH4|MATH|REFA|REFB|REFC|REFD} separately.

➤ **Return format:**

Query returns 1 or 0, it represents ON or OFF.

➤ **For example:**

:CHAN1:SElect

Select channel 1.

:CHAN1:SElect?

Query returns 1, it present the channel is selected.

TIMEbase Command

This command is to change the horizontal scale (timebase) of the current channel and horizontal position of the trigger in memory (trigger displacement). Changing the horizontal scale may casue the waveform extended or compressed relative to the center of the screen; changing the horizontal position may casue waveform position away from the center of screen.

:TIMEbase:MODE

➤ **Command format:**

:TIMEbase:MODE {MAIN | WINDow}

:TIMEbase:MODE?

➤ **Functional description:**

This command is used to set timebase mode, MAIN (main timebase) or WINDow (<Zoomed> timebase) .

➤ **Return format:**

Query returns MAIN or WINDow.

➤ **For example:**

:TIM:MODE MAIN

Set timebase mode to MAIN.

:TIM:MODE?

Query returns MAIN.

:TIMEbase:OFFSet

➤ **Command format:**

:TIMEbase:OFFSet <offset>

:TIMebase:OFFSet?

➤ **Functional description:**

This command is used to adjust the offset of MAIN (main timebase), which is displacement of the waveform position from the center of the screen.

➤ **Return format:**

Query returns <offset> value in scientific notation, unit is s.

➤ **For example:**

:TIM:OFFS 1s Set the offset of MAIN to 1s.

:TIM:OFFS? Query returns 1.000e000.

:TIMebase:WINDow:OFFSet

➤ **Command format:**

:TIMebase:WINDow:OFFSet <offset>

:TIMebase:WINDow:OFFSet?

➤ **Functional description:**

This command is used to adjust the offset of WINDow (<Zoomed> timebase), which is displacement of the waveform position from the center of the screen.

➤ **Return format:**

Query returns <offset> value in scientific notation, unit is s.

➤ **For example:**

:TIM:WIND:OFFS 1 Set the offset of WINDow to 1s.

:TIM:WIND:OFFS? Query returns 1.000e000.

:TIMebase:SCALE

➤ **Command format:**

:TIMebase:SCALE {<scale> | UP | DOWN}

:TIMebase:SCALE?

➤ **Functional description:**

This command is used to set timebase scale of MAIN (main timebase), which is s/div.

<scale>: Timebase scale value;

UP: Increase one scale based on the current scale of the oscilloscope;

DOWN: Decrease one scale based on the current scale of the oscilloscope.

➤ **Return format:**

Query returns < scale> value in scientific notation, unit is s/div.

➤ **For example:**

:TIM:SCALE 2 Set the offset of MAIN to 2 s/div.

:TIM:SCALE? Query returns 2.000e000.

:TIMebase:WINDow:SCALE

➤ **Command format:**

:TIMebase:WINDow:SCALE < scale >

:TIMebase:WINDow:SCALE?

➤ **Functional description:**

This command is used to set timebase scale of WINDow (<Zoomed> timebase) , which is s/div.

➤ **Return format:**

Query returns < scale> value in scientific notation, unit is s/div.

➤ **For example:**

:TIM:WIND:SCAL 2

Set the offset of WINDow to 2 s/div.

:TIM:WIND:SCAL?

Query returns 2.000e000.

:TIMebase:INDPendent

➤ **Command format:**

:TIMebase:INDPendent { {1|ON} | {0|OFF} }

:TIMebase:INDPendent?

➤ **Functional description:**

This command is used to turn on/off timebase independent mode.

➤ **Return format:**

Query returns 1 or 0, it represents ON or OFF.

➤ **For example:**

:TIM:INDP ON

Turn on timebase independent mode.

:TIM:INDP?

Query returns 1.

:TIMebase:HOLDoff

➤ **Command format:**

:TIMebase:HOLDoff <time>

:TIMebase:HOLDoff?

➤ **Functional description:**

This command is used to set trigger holdoff time, which can set the range to 100ns~10s.

➤ **Return format:**

Query returns the value of trigger holdoff time in scientific notation, unit is s.

➤ **For example:**

:TIM:HOLD 1s

Set trigger holdoff time to 1s.

:TIM:HOLD?

Query returns 1.000e000.

:TIMebase:SPLit:SCReen

➤ **Command format:**

:TIMebase:SPLit:SCReen { OFF | CHANnel1| CHANnel2| CHANnel3| CHANnel4|ALL }

:TIMebase:SPLit:SCReen?

➤ **Functional description:**

This command is used to set the split screen display in main timebase.

OFF: turn off independent display;

CHANnel1| CHANnel2| CHANnel3| CHANnel4: The waveform of channel 1, 2, 3, or 4 displays independently;

ALL: The waveform of all channel displays independently.

➤ **Return format:**

Query returns {OFF | CHANnel1| CHANnel2| CHANnel3| CHANnel4 | ALL}.

➤ **For example:**

:TIMebase:SPLit:SCREen CHANnel1

The waveform of channel 1 displays independently.

:TIMebase:SPLit:SCREen? Query returns CHANnel1.

FUNCTION Command

This command is used to display the operation result of the waveform of CH1, CH2, CH3, and CH4. The operation is add, subtract, multiply, divide and FFT. Set filter to use the expression to operating.

:FUNCTION:MATH:MODE

➤ **Command format:**

FUNCTION:MATH:MODE {MATH|FFT|FILTER|ADVance}

FUNCTION:MATH:MODE?

➤ **Functional description:**

This command is used to select MATH mode.

➤ **Return format:**

Query returns {MATH|FFT|FILTER|ADVance}.

➤ **For example:**

FUNC:MATH:MODE FFT Set MATH mode to FFT mode.

FUNC:MATH:MODE? Query returns FFT.

:FUNCTION:OPERation

➤ **Command format:**

:FUNCTION:OPERation {ADD | SUBTract | MULTiPLY | DIVide }

:FUNCTION:OPERation?

➤ **Functional description:**

This command is used to set functional operator, which includes the basic and logical operation. That is add, subtract, multiply and divide.

➤ **Return format:**

Query returns {ADD | SUBTract | MULTiPLY | DIVide}.

➤ **For example:**

:FUNCTION:OPERation ADD Use add operator: src1+src2.

:FUNCTION:OPERation? Query returns ADD.

:FUNCTION:SOURce<m>

➤ **Command format:**

:FUNCTION:SOURce<m> {CHANnel1| CHANnel2| CHANnel3| CHANnel4}

:FUNCTION:SOURce<m>?

➤ **Functional description:**

SOURce <m> represents source 1 or source 2. <m> takes value as 1 or 2.

SOURce1 is used for selecting the first source of operator mathematical functions. And which can be a single source of Filter, FFT.

SOURce2 is used to select the second source of operator mathematical functions. Single source of Filter,

FFT are not suitable.

<value> represents CHANnel<n>. <n> takes value as 1/2/3/4 {CH1/ CH2/ CH3/ CH4}.

➤ **Return format:**

Query returns CHANnel1, CHANnel2, CHANnel3 or CHANnel4.

➤ **For example:**

:FUNction:SOUR1 CHAN1	Set channel 1 as the first source.
:FUNction:SOUR1?	Query returns CHANnel1.
:FUNction:SOUR2 CHAN2	Set channel 2 as the second source.
:FUNction:SOUR2?	Query returns CHANnel2.
:FUNction:OPERation ADD	Add channel of source 1 and channel of source 2.

:FUNction:FFT:WINDow

➤ **Command format:**

```
:FUNction:FFT:WINDow {RECTangular|HANNing|HAMMING|BMAN}
:FUNction:FFT:WINDow?
```

➤ **Functional description:**

FFT add window to intercept signal. RECT, HANN, HAMM, BMAN is respectively rectangular window, Hanning window, Hamming window and Blacman window.

➤ **Return format:**

Query returns {RECTangular|HANNing|HAMMING|BMAN}.

➤ **For example:**

:FUNction:SOUR1 CHAN1	Set channel 1 as the source.
:FUNc:FFT:WIND HAMM	Add Hamming window.
:FUNc:FFT:WIND?	Query returns HAMMING.

:FUNction:FFT:DISPlay

➤ **Command format:**

```
:FUNction:FFT:DISPlay {FULL|SPLIt|WATERfall1|WATERfall2|INDEpendent }
:FUNction:FFT:DISPlay?
```

➤ **Functional description:**

This command is used to set FFT display mode.

➤ **Return format:**

Query returns {FULL|SPLIt|WATERfall1|WATERfall2|INDEpendent }. FULL is full display, SPLIt is split screen display.

WATERfall1 is waterfall curve 1, WATERfall2 is waterfall curve 2, INDEpendent represents independently display FFT spectrogram.

➤ **For example:**

:FUNction:FFT:DISPlay FULL	Set FFT to full display.
:FUNction:FFT:DISPlay?	Return FULL.

:FUNction:FFT:WATERfall:SLICe

➤ **Command format:**

```
:FUNction:FFT:WATERfall:SLICe <value>
```

:FUNCTION:FFT:WATERfall:SLICe ?

➤ **Functional description:**

This command is used to select the segment of FFT waterfall curve, which can select the range to 1~200.

➤ **Return format:**

Query returns which frame segment is currently selected.

➤ **For example:**

:FUNCTION:FFT:WATERfall:SLICe 100

Set FFT waterfall curve to select 100 frame segment.

:FUNCTION:FFT:WATERfall:SLICe ? Query returns 100.

:FUNCTION:FFT:POINTs

➤ **Command format:**

:FUNCTION:FFT:POINTs {AUTO|1K|2K|4K|8K|16K|32K|64K|128K|256K|512K|1024K|2048K|4096K}

:FUNCTION:FFT:POINTs?

➤ **Functional description:**

This command is used to set FFT's point.

➤ **Return format:**

Query returns {AUTO|1K|2K|4K|8K|16K|32K|64K|128K|256K|512K|1024K|2048K|4096K}.

➤ **For example:**

:FUNCTION:FFT:POINTs 8K Set FFT's point to 8 K.

:FUNCTION:FFT:POINTs? Return 8 K.

:FUNCTION:FFT:VTYPE

➤ **Command format:**

:FUNCTION:FFT:VTYPE {VRMS|DBRMS}

:FUNCTION:FFT:VTYPE?

➤ **Functional description:**

This command is used to select the unit of FFT vertical direction to dBRMS or VRMS. dBRMS represents power root mean square, VRMS represents voltage root mean square.

➤ **Return format:**

Query returns VRMS, DBRMS.

➤ **For example:**

:FUNCTION:SOUR1 CHAN1 Set channel 1 as the source.

:FUNC:FFT:VTYP VRMS Set the unit of FFT vertical direction to VRMS.

:FUNC:FFT:VTYP? Query returns VRMS.

:FUNCTION:FFT:FREQuency

➤ **Command format:**

:FUNCTION:FFT:FREQuency?

➤ **Functional description:**

This command is used to acquire the center frequency of spectrum waveform after FFT.

➤ **Return format:**

Query returns the center frequency of spectrum waveform, unit is Hz.

- **For example:**
:FUNction:FFT:FREQuency? Query returns 1.000e003.

:FUNction:FFT:FREQuency:START

- **Command format:**
:FUNction:FFT:FREQuency:START <freq>
:FUNction:FFT:FREQuency:START?
- **Functional description:**
This command is used to set the start frequency of FFT.
- **Return format:**
Query returns the start frequency of FFT, unit is Hz.
- **For example:**
:FUNction:FFT:FREQuency:START 1 kHz Set the start frequency to 1 kHz.
:FUNc:FFT:FREQ:START? Query returns 1.000e003.

:FUNction:FFT:FREQuency:END

- **Command format:**
:FUNction:FFT:FREQuency:END <freq>
:FUNction:FFT:FREQuency:END?
- **Functional description:**
This command is used to set the end frequency of FFT.
- **Return format:**
Query returns FFT the end frequency of FFT, unit is Hz.
- **For example:**
:FUNction:FFT:FREQuency:END 1 kHz Set the end frequency to 1 kHz.
:FUNc:FFT:FREQ:END? Query returns 1.000e003.

:FUNction:FFT:FREQuency:CENTer

- **Command format:**
:FUNction:FFT:FREQuency:CENTer <freq>
:FUNction:FFT:FREQuency:CENTer?
- **Functional description:**
This command is used to set the center frequency of FFT.
- **Return format:**
Query returns FFT the center frequency of FFT, unit is Hz.
- **For example:**
:FUNction:FFT:FREQuency:CENTer 1 kHz Set the center frequency to 1 kHz.
:FUNc:FFT:FREQ:CENTer? Query returns 1.000e003.

:FUNction:FFT:FREQuency:BW

- **Command format:**
:FUNction:FFT:FREQuency:BW <freq>

:FUNction:FFT:FREQuency:BW?

➤ **Functional description:**

This command is used to set the frequency bandwidth of FFT.

➤ **Return format:**

Query returns the frequency bandwidth of FFT, unit is Hz.

➤ **For example:**

:FUNction:FFT:FREQuency:BW 1 kHz Set the frequency bandwidth of FFT to 1 kHz.

:FUNC:FFT:FREQ:BW? Query returns 1.000e003.

:FUNction:FFT:DETEction:REALTime

➤ **Command format:**

:FUNction:FFT:DETEction:REALTime {OFF|PPEAK|NPEAK|AVERAge|SAMPLE}

:FUNction:FFT:DETEction:REALTime?

➤ **Functional description:**

This command is used to set the detection mode of real-time spectrum.

OFF: turn off the detection mode;

PPEAK: Take the maximum value within the range of each sampling point;

NPEAK: Take the minimum value within the range of each sampling point;

AVERAge: Take the average value within the range of each sampling point;

SAMPlE: Take the value of first point within the range of each sampling point.

➤ **Return format:**

Query returns the detection mode of real-time spectrum.

➤ **For example:**

:FUNction:FFT:DETEction:REALTime PPEAK

Set the detection mode of real-time spectrum to +peak detection.

:FUNction:FFT:DETEction:REALTime? Query returns PPEAK.

:FUNction:FFT:DETEction:AVERAge

➤ **Command format:**

:FUNction:FFT:DETEction:AVERAge {OFF|PPEAK|NPEAK|AVERAge|SAMPLE}

:FUNction:FFT:DETEction:AVERAge?

➤ **Functional description:**

This command is used to set the detection mode of the average spectrum.

OFF: turn off the average spectrum;

PPEAK: Take the maximum value within the range of each sampling point;

NPEAK: Take the minimum value within the range of each sampling point;

AVERAge: Take the average value within the range of each sampling point;

SAMPlE: Take the value of first point within the range of each sampling point.

➤ **Return format:**

Query returns the detection mode of the average spectrum.

➤ **For example:**

:FUNction:FFT:DETEction:AVERAge PPEAK

Set the detection mode of the average spectrum to +peak detection.

:FUNction:FFT:DETEction:AVERage? Query returns PPEAK.

:FUNction:FFT:DETEction:AVERage:COUNT

➤ **Command format:**

:FUNction:FFT:DETEction:AVERage:COUNT <value>

:FUNction:FFT:DETEction:AVERage:COUNT?

➤ **Functional description:**

This command is used to set the average number of times of average spectrum. The range is 2^n , n takes value from 1~10.

➤ **Return format:**

Query the average number of times of average spectrum.

➤ **For example:**

:FUNction:FFT:DETEction:AVERage:COUNT 64

Set the average number of times of average spectrum to 64.

:FUNction:FFT:DETEction:AVERage:COUNT? Query returns 64.

:FUNction:FFT:DETEction:MAXHold

➤ **Command format:**

:FUNction:FFT:DETEction:MAXHold {OFF|PPEAK|NPEAK|AVERage|SAMPlE}

:FUNction:FFT:DETEction:MAXHold?

➤ **Functional description:**

This command is used to set the detection mode of the maximum hold spectrum.

OFF: Turn off the average spectrum;

PPEAK: Take the maximum value within the range of each sampling point;

NPEAK: Take the minimum value within the range of each sampling point;

AVERage: Take the average value within the range of each sampling point;

SAMPlE: Take the value of first point within the range of each sampling point.

➤ **Return format:**

Query returns the detection mode of the maximum hold spectrum.

➤ **For example:**

:FUNction:FFT:DETEction:MAXHold PPEAK

Set the detection mode of the maximum hold spectrum to +peak detection.

:FUNction:FFT:DETEction:MAXHold?

Query returns PPEAK.

:FUNction:FFT:DETEction:MINHold

➤ **Command format:**

:FUNction:FFT:DETEction:MINHold {OFF|PPEAK|NPEAK|AVERage|SAMPlE}

:FUNction:FFT:DETEction:MINHold?

➤ **Functional description:**

This command is used to set the detection mode of the minimum hold spectrum.

OFF: Turn off the average spectrum.

PPEAK: Take the minimum value within the range of each sampling point;

NPEAK: Take the minimum value within the range of each sampling point;
AVERage: Take the average value within the range of each sampling point;
SAMPlE: Take the value of first point within the range of each sampling point.

➤ **Return format:**

Query returns the detection mode of the minimum hold spectrum.

➤ **For example:**

:FUNction:FFT:DETEction:MINHold PPEAK

Set the detection mode of spectrum to +peak detection.

:FUNction:FFT:DETEction:MINHold? Query returns PPEAK.

:FUNction:FFT:DETEction:RESet

➤ **Command format:**

:FUNction:FFT:DETEction:RESet

➤ **Functional description:**

This command is used to reset the average value, the maximum and minimum hold spectrum.

➤ **For example:**

:FUNction:FFT:DETEction:RESet Reset each spectrum.

:FUNction:FFT:MARK:TYPE

➤ **Command format:**

:FUNction:FFT:MARK:TYPE {AUTO|THReshold|MANUal}

:FUNction:FFT:MARK:TYPE?

➤ **Functional description:**

This command is used to set mark type of the spectrum.

OFF: Turn off the spectrum marker.

AUTO: Auto spectrum marker.

THReshold: Threshold spectrum marker.

MANUal: Manual spectrum marker.

➤ **Return format:**

Query returns the currently selected marker type of spectrum.

➤ **For example:**

:FUNction:FFT:MARK:TYPE AUTO

Set marker type of the spectrum to AUTO.

:FUNction:FFT:MARK:TYPE? Query returns AUTO.

:FUNction:FFT:MARK:SOURce

➤ **Command format:**

:FUNction:FFT:MARK:SOURce {REALtime|AVERage|MAXHold|MINHold}

:FUNction:FFT:MARK:SOURce?

➤ **Functional description:**

This command is used to set mark source of the spectrum marker, this instruction is the common instruction.

REALtime: Mark the real-time spectrum.

AVERage: Mark the average spectrum.

MAXHold: Mark the maximum hold spectrum.

MINHold: Mark the minimum hold spectrum.

➤ **Return format:**

Query returns the currently selected mark source.

➤ **For example:**

:FUNction:FFT:MARK:SOURce AVERage

Set mark source of the spectrum marker to average spectrum.

:FUNction:FFT:MARK:SOURce? Query returns AVERage.

:FUNction:FFT:MARK:POINTs

➤ **Command format:**

:FUNction:FFT:MARK:POINTs <value>

:FUNction:FFT:MARK:POINTs ?

➤ **Functional description:**

Set mark point of of the spectrum marker.

<value>: The value of mark point, which can set the range to 1~50.

➤ **Return format:**

Query returns mark point of the spectrum marker.

➤ **For example:**

:FUNction:FFT:MARK:POINTs 20 Set mark point of of the spectrum marker to 20.

:FUNction:FFT:MARK:POINTs? Query returns 20.

:FUNction:FFT:MARK:EVENT

➤ **Command format:**

:FUNction:FFT:MARK:EVENT {1|ON}|{0|OFF}

:FUNction:FFT:MARK:EVENT?

➤ **Functional description:**

This command is used to turn on/off mark list of the spectrum marker.

➤ **Return format:**

Query the status of mark list, 1 represents ON, 0 represents OFF.

➤ **For example:**

:FUNction:FFT:MARK:EVENT ON Turn on mark list.

:FUNction:FFT:MARK:EVENT? Query returns 1.

:FUNction:FFT:MARK:DATA?

➤ **Command format:**

:FUNction:FFT:MARK:DATA?

➤ **Functional description:**

This command is used to read the mark event list data in FFT of the oscilloscope.

➤ **Return format:**

Query returns the mark event list data in FFT. Returned data is conform with [Appendix 2: IEEE 488.2 binary](#)

data format.➤ **For example:**

:FUNction:FFT:MARK:DATA? Query returns:

#9000000089FFT,

ID,Freq,Amp,

1,1.000E+003,7.800E-001,

2,2.000E+003,7.900E-001,

3,3.000E+003,7.700E-001,

4,4.000E+003,7.300E-001,

5,5.000E+003,7.400E-001,

FFT represents FFT mode, the event table data in CSV format followed behind. The specified format of the event table data is automatically adapted by different devices. The data are separated by commas and will automatically line wrap according to the decoding list.

:FUNction:FFT:MARK:THReshold:LEVel➤ **Command format:**

:FUNction:FFT:MARK:THReshold:LEVel <value>

:FUNction:FFT:MARK:THReshold:LEVel?

➤ **Functional description:**

This command is used to set threshold voltage value of threshold spectrum mark.

<value>: Threshold voltage value, unit is V if vertical direction is Vrms. And the range is 1 mVrms~100 KVrms; unit is dB if vertical direction is dBVrms. And the range is -60 dB~100 dB; if the unit is not matched with the vertical unit, the setting is invalid.

➤ **Return format:**

Query returns the threshold value of spectrum mark in scientific notation, unit is related to :FUNction:FFT:VTYPE.

➤ **For example:**

:FUNction:FFT:MARK:THReshold:LEVel -12.5dB

Set the threshold of spectrum mark to -12.5 dB.

:FUNction:FFT:MARK:THReshold:LEVel?

Query returns -1.250e-001.

:FUNction:FFT:MARK:THReshold:LEVel 0.15V

Set the threshold of spectrum mark to 0.15 V.

:FUNction:FFT:MARK:THReshold:LEVel?

Query returns 1.500e-001.

:FUNction:FFT:MARK:MANUal:PEAK➤ **Command format:**

:FUNction:FFT:MARK:MANUal:PEAK

➤ **Functional description:**

This command is used to move the marker to the maximum peak.

➤ **For example:**

:FUNction:FFT:MARK:MANUal:PEAK

Move the marker to the maximum peak.

:FUNCTION:FILTer:TYPE➤ **Command format:**

:FUNCTION:FILTer:TYPE {LP|HP|BP|BS}

:FUNCTION:FILTer:TYPE?

➤ **Functional description:**

This command is used to set the filter type. LP, HP, BP, BS respectively represents low-pass filter, high-pass filter, band-pass filter and band-limit filter separately.

➤ **Return format:**

Query returns LP, HP, BP, BS.

➤ **For example:**

:FUNCTION:SOUR1 CHAN1

Set channel 1 as the source.

:FUNC:FILT:TYPE BP

Set the filter type to band-pass filter.

:FUNC:FILT:TYPE?

Query returns BP.

:FUNCTION:FILTer:FREQuency:HIGH➤ **Command format:**

:FUNCTION:FILTer:FREQuency:HIGH <freq>

:FUNCTION:FILTer:FREQuency:HIGH?

➤ **Functional description:**

This command is used to set the upper limit cut-off frequency value of filter. It is suitable for high-pass filter, band-pass filter and band-limit filter.

➤ **Return format:**

Query returns 1.000e003, unit is Hz.

➤ **For example:**

:FUNCTION:SOUR1 CHAN1

Set channel 1 as the source.

:FUNC:FILT:FREQ:HIGH 1 kHz

Set the upper limit cut-off frequency value to 1 kHz.

:FUNC:FILT:FREQ:HIGH?

Query returns 1.000e003.

:FUNCTION:FILTer:FREQuency:LOW➤ **Command format:**

:FUNCTION:FILTer:FREQuency:LOW <freq>

:FUNCTION:FILTer:FREQuency:LOW?

➤ **Functional description:**

This command is used to set the low limit cut-off frequency value of filter. It is suitable for high-pass filter, band-pass filter and band-limit filter.

➤ **Return format:**

Query returns 6.000e001, unit is Hz.

➤ **For example:**

:FUNC:SOUR1 CHAN1

Set channel 1 as the source.

:FUNC:FILT:FREQ:LOW 60Hz

Set the low limit cut-off frequency value to 60 Hz.

:FUNC:FILT:FREQ:LOW?

Query returns 6.000e001.

:FUNction:EXPReSSion

➤ **Command format:**

:FUNction:EXPReSSion <expression>

➤ **Functional description:**

Use free combination expression to perform mathematical calculation.

Expression format refer to Advance option in MATH menu of the oscilloscope, <expression> is belong to ASCII character string parameter.

➤ **For example:**

:FUNction:EXPReSSion "CH1*CH2"

It represents multiply channel 1 with channel 2.

MEASure Command

The command is for the basic measurement operation; all parameter measurement can get the test value without open measurement function; by default, it will turn on measurement and acquire the test value automatically. In general, test result is returned in scientific notation.

:MEASure:ALL

➤ **Command format:**

:MEASure:ALL {{1|ON}}|{0|OFF}}

:MEASure:ALL?

➤ **Functional description:**

This command is used to turn on/off all measurement functions.

➤ **Return format:**

Query returns whether all measurement functions is enabled.

➤ **For example:**

:MEASure:ALL ON Turn on all measurement functions.

:MEASure:ALL? Query returns 1.

:MEASure:CLEAr

➤ **Command format:**

:MEASure:CLEAr

➤ **Functional description:**

This command is used to clear all the currently measured parameter values.

➤ **For example:**

:MEAS:CLE Clear all the currently measured parameter values.

:MEASure:SOURce

➤ **Command format:**

:MEASure:SOURce <source>

:MEASure:SOURce?

➤ **Functional description:**

This command is used to select measuring source. <source> is CHANnel<n>, n takes value as 1, 2, 3 or 4.

➤ **Return format:**

Query returns {CHANnel1 | CHANnel2 | CHANnel3 | CHANnel4 | MATH}

➤ **For example:**

:MEAS:SOUR CHAN1

Select channel 1 as measuring source.

:MEAS:SOUR?

Return CHANnel1.

:MEASure:SLAVe:SOURce

➤ **Command format:**

:MEASure:SLAVe:SOURce <source>

:MEASure:SLAVe:SOURce?

➤ **Functional description:**

This command is used to select slave source. <source> is CHANnel<n>, n takes value as 1, 2, 3 or 4.

➤ **Return format:**

Query returns {CHANnel1 | CHANnel2 | CHANnel3 | CHANnel4 | MATH}.

➤ **For example:**

:MEAS:SLAV:SOUR CHAN1

Select channel 1 as measuring source.

:MEAS:SLAV:SOUR?

Return CHANnel1.

:MEASure:STATistic:DISPlay

➤ **Command format:**

:MEASure:STATistic:DISPlay { OFF | EXTRemum | DIFFerence }

:MEASure:STATistic:DISPlay?

➤ **Functional description:**

This command is used to turn on/off difference measurement and extreme value statistics function.

➤ **Return format:**

Query returns { OFF | EXTRemum | DIFFerence }.

➤ **For example:**

:MEASure:STATistic:DISPlay EXTRemum

Open extreme value statistics function.

:MEASure:STATistic:DISPlay?

Query returns EXTRemum.

:MEASure:STATistic:RESet

➤ **Command format:**

:MEASure:STATistic:RESet

➤ **Functional description:**

This command is used to delete the historical statistic data and restart to statistic.

➤ **For example:**

:MEASure:STATistic:RESet

Delete the historical statistic data and restart to statistic.

:MEASure:STATistic:ITEM➤ **Command format:**

```
:MEASure:STATistic:ITEM <item>
```

```
:MEASure:STATistic:ITEM? <type>,<item>
```

➤ **Functional description:**

This command is used to open the statistic function of the assigned arbitrary wave and query the statistic results of arbitrary wave.

<item> represents waveform parameter:

```
{VMAX|VMIN|VPP|VTOP|VBASel|VAMPLitude|VAverage|CYCVAverage|VMIDdle|VRMS|ACRMS|CYCRMS|AREa|CYCAREa|FREQuency|PHASel|PERiod|OVERshoot|PREShoot|RISetime|FALLtime|PWIDth|NWDth|PDUTy|INDUTy|PDELay|NDELay|PULSes|FRR|FRF|FFR|FFF|LRR|LRF|LFR|LFF}.
```

<type> represents statistic type: {MAXimum|MINimum|CURRent|AVERages|DEViation}, it respectively represents the maximum value, the minimum value, the current value, the averaged value and deviation.

➤ **Return format:**

Query returns the statistic results in scientific notation.

➤ **For example:**

```
:MEASure:STATistic:ITEM CYCVAV      Open the statistic function of period averaged.
```

```
:MEASure:STATistic:ITEM? MAX,CYCVAV
```

Query returns the statistical period averaged maximum value of 1.120e000.

:MEASure:WINDow➤ **Command format:**

```
:MEASure:WINDow {SCReen | CURSor}
```

```
:MEASure:WINDow?
```

➤ **Functional description:**

This command is used to set measurement window. SCReen is the whole screen, CURSor is the cursor measurement area.

If the measurement area is the cursor area, use command :CURSor:TYPE to open cursor time measurement, and then use command :CURSor:CURA and :CURSor:CURB to adjust the vertical range of the cursor line.

➤ **Return format:**

Query returns {SCReen | CURSor}.

➤ **For example:**

```
:MEASure:WINDow CURSor
```

Set measurement window as the cursor measurement area.

```
:MEASure:WINDow?          Query returns CURSor.
```

:MEASure:PDUTy?➤ **Command format:**

```
:MEASure:PDUTy? [<source>]
```

➤ **Functional description:**

This command is used to measure positive duty cycle of the specified channel waveform. <source> takes

value as CHANnel1, CHANnel2, CHANnel3 or CHANnel4. Omitting represents the current channel.

➤ **Return format:**

Query returns 5.000e001, unit is %.

:MEASure:NDUTy?

➤ **Command format:**

:MEASure:NDUTy? [<source>]

➤ **Functional description:**

This command is used to measure negative duty cycle of the specified channel waveform. <source> takes value as CHANnel1, CHANnel2, CHANnel3 or CHANnel4. Omitting represents the current channel.

➤ **Return format:**

Query returns 5.000e001, unit is %.

:MEASure:PDELay?

➤ **Command format:**

:MEASure:PDELay? [<source1>, <source2>]

➤ **Functional description:**

This command is used to measure time delay of <source1> and <source2> with respect to rising edge. <source> takes value as CHANnel1, CHANnel2, CHANnel3 or CHANnel4.

➤ **Return format:**

Query returns -1.000e-004, unit is s.

➤ **For example:**

Measuring time delay with respect to rising edge.

:MEASure:PDEL? CHAN1,CHAN2

:MEASure:NDELay?

➤ **Command format:**

:MEASure:NDELay? [<source1>, <source2>]

➤ **Functional description:**

This command is used to measure time delay of <source1> and <source2> with respect to falling edge. <source> takes value as CHANnel1, CHANnel2, CHANnel3 or CHANnel4.

➤ **Return format:**

Query returns -1.000e-004, unit is s.

➤ **For example:**

Measuring time delay with respect to rising edge.

:MEASure:NDEL? CHAN1,CHAN2

:MEASure:PHASe?

➤ **Command format:**

:MEASure:PHASe? [<source1>, <source2>]

➤ **Functional description:**

This command is used to timing measure the amount of time of <source1> which exceeds or lags with

respect to <source2>, expressed in degrees, with 360° as a period. <source> takes value as CHANnel1, CHANnel2, CHANnel3 or CHANnel4.

➤ **Return format:**

Query returns 1.000e001, unit is degree.

➤ **For example:**

Measuring the amount of time of <source1> which exceeds or lags with respect to <source2>.

:MEASure:PHAS? CHAN1,CHAN2

:MEASure:VPP?

➤ **Command format:**

:MEASure:VPP? [<source>]

➤ **Functional description:**

This command is used to measure peak-to-peak value of the specified channel waveform. <source> takes value as CHANnel1, CHANnel2, CHANnel3 or CHANnel4. Omitting represents the current channel.

➤ **Return format:**

Query returns 3.120e000, unit is V.

:MEASure:VMAX?

➤ **Command format:**

:MEASure:VMAX? [<source>]

➤ **Functional description:**

This command is used to measure the maximum value of the specified channel waveform. <source> takes value as CHANnel1, CHANnel2, CHANnel3 or CHANnel4. Omitting represents the current channel.

➤ **Return format:**

Query returns 2.120e000, unit is V.

:MEASure:VMIN?

➤ **Command format:**

:MEASure:VMIN? [<source>]

➤ **Functional description:**

This command is used to measure the minimum value of the specified channel waveform. <source> takes value as CHANnel1, CHANnel2, CHANnel3 or CHANnel4. Omitting represents the current channel.

➤ **Return format:**

Query returns -2.120e000, unit is V.

:MEASure:VAMPLitude?

➤ **Command format:**

:MEASure:VAMPLitude? [<source>]

➤ **Functional description:**

This command is used to measure amplitude value of the specified channel waveform. <source> takes value as CHANnel1, CHANnel2, CHANnel3 or CHANnel4. Omitting represents the current channel.

➤ **Return format:**

Query returns 3.120e000, unit is V.

:MEASure:VTOP?

- **Command format:**
:MEASure:VTOP? [<source>]
- **Functional description:**
This command is used to measure the top value of the specified channel waveform. <source> takes value as CHANnel1, CHANnel2, CHANnel3 or CHANnel4. Omitting represents the current channel.
- **Return format:**
Query returns 3.120e000, unit is V.

:MEASure:VBASe?

- **Command format:**
:MEASure:VBASe? [<source>]
- **Functional description:**
This command is used to measure the bottom value of the specified channel waveform. <source> takes value as CHANnel1, CHANnel2, CHANnel3 or CHANnel4. Omitting represents the current channel.
- **Return format:**
Query returns -3.120e000, unit is V.

:MEASure:VMIDdle?

- **Command format:**
:MEASure:VMIDdle? [<source>]
- **Functional description:**
This command is used to measure the middle value of the specified channel waveform. <source> takes value as CHANnel1, CHANnel2, CHANnel3 or CHANnel4. Omitting represents the current channel.
- **Return format:**
Query returns 0.120e000, unit is V.

:MEASure:VAverage?

- **Command format:**
:MEASure:VAverage? [<interval>], [<source>]
- **Functional description:**
This command is used to measure the average value of the specified channel waveform. <source> is the specified channel and takes value as CHANnel1, CHANnel2, CHANnel3 or CHANnel4. If there is no assigned <source>, then the current channel as the default; <interval> specifies the measuring interval and take value as CYCLE or DISPLAY. CYCLE represents integer cycle, DISPLAY represents full screen. If there is no assigned <interval>, then DISPLAY as the default.
- **Return format:**
Query returns 1.120e000, unit is V.

:MEASure:VRMS?

- **Command format:**
:MEASure:VRMS? [<interval>],[<source>]
- **Functional description:**
This command is used to measure the root mean square value of the specified channel waveform. <source> is the specified channel and take value as CHANnel1, CHANnel2, CHANnel3 or CHANnel4. If there is no assigned <source>, then the current channel as the default; <interval> specifies the measuring interval take value as CYCLE or DISPlay. CYCLE represents integer cycle, DISPlay represents full screen. If there is no assigned <interval>, then DISPlay as the default.
- **Return format:**
Query returns 1.230e000, unit is V.

:MEASure:ACRMs?

- **Command format:**
:MEASure:ACRMs? [<source>]
- **Functional description:**
This command is used to measure the AC root mean square value of the specified channel waveform. <source> is the specified channel and take value as CHANnel1, CHANnel2, CHANnel3 or CHANnel4. If there is no assigned <source>, then the current channel as the default.
- **Return format:**
Query returns 1.230e000, unit is V.

:MEASure:AREa?

- **Command format:**
:MEASure:AREa? [<interval>],[<source>]
- **Functional description:**
This command is used to measure the area of the specified channel waveform. <source> is the specified channel and take value as CHANnel1, CHANnel2, CHANnel3 or CHANnel4. If there is no assigned <source>, then the current channel as the default; <interval> specifies the measuring interval and take value as CYCLE or DISPlay. CYCLE represents integer cycle, DISPlay represents full screen. If there is no assigned <interval>, then DISPlay as the default.
- **Return format:**
Query returns 3.456e002, unit is Vs.

:MEASure:OVERshoot?

- **Command format:**
:MEASure:OVERshoot? [<source>]
- **Functional description:**
This command is used to measure overshoot of the specified channel waveform. <source> take value as CHANnel1, CHANnel2, CHANnel3 or CHANnel4. Omitting represents the current channel.
- **Return format:**
Query returns 1.230e002, unit is %.

:MEASure:PREShoot?

- **Command format:**
:MEASure:PREShoot? [<source>]
- **Functional description:**
This command is used to measure preshoot of the specified channel waveform. <source> take value as CHANnel1, CHANnel2, CHANnel3 or CHANnel4. Omitting represents the current channel.
- **Return format:**
Query returns 1.230e-002, unit is %.

:MEASure:FREQuency?

- **Command format:**
:MEASure:FREQuency? [<source>]
- **Functional description:**
This command is used to measure frequency of the specified channel waveform. <source> take value as CHANnel1, CHANnel2, CHANnel3 or CHANnel4. Omitting represents the current channel.
- **Return format:**
Query returns 2.000e003, unit is Hz.

:MEASure:RISetime?

- **Command format:**
:MEASure:RISetime? [<source>]
- **Functional description:**
This command is used to measure rising time of the specified channel waveform. <source> takes value as CHANnel1, CHANnel2, CHANnel3 or CHANnel4. Omitting represents the current channel.
- **Return format:**
Query returns 5.000e-005, unit is s.

:MEASure:FALLtime?

- **Command format:**
:MEASure:FALLtime? [<source>]
- **Functional description:**
This command is used to measure falling time of the specified channel waveform. <source> takes value as CHANnel1, CHANnel2, CHANnel3 or CHANnel4. Omitting represents the current channel.
- **Return format:**
Query returns 5.000e-005, unit is s.

:MEASure:PERiod?

- **Command format:**
:MEASure:PERiod? [<source>]
- **Functional description:**
This command is used to measure period of the specified channel waveform. <source> takes value as

CHANnel1, CHANnel2, CHANnel3 or CHANnel4. Omitting represents the current channel.

➤ **Return format:**

Query returns 5.000e-003, unit is s.

:MEASure:PWIDth?

➤ **Command format:**

:MEASure:PWIDth? [<source>]

➤ **Functional description:**

This command is used to measure positive pulse width of the specified channel waveform. <source> takes value as CHANnel1, CHANnel2, CHANnel3 or CHANnel4. Omitting represents the current channel.

➤ **Return format:**

Query returns 5.000e-003, unit is s.

:MEASure:NWIDth?

➤ **Command format:**

:MEASure:NWIDth? [<source>]

➤ **Functional description:**

This command is used to measure negative pulse width of the specified channel waveform. <source> takes value as CHANnel1, CHANnel2, CHANnel3 or CHANnel4. Omitting represents the current channel.

➤ **Return format:**

Query returns 5.000e-003, unit is s.

:MEASure:PULSes?

➤ **Command format:**

:MEASure:PULSes? [<source>]

➤ **Functional description:**

This command is used to measure the number of positive pulse of the specified channel. <source> takes value as CHANnel1, CHANnel2, CHANnel3 or CHANnel4. Omitting represents the current channel.

➤ **Return format:**

Query returns 2.000e+000, it represents 2 pulses.

:MEASure:FRR?

➤ **Command format:**

:MEASure:FRR? <source1>, <source2>

➤ **Functional description:**

This command is used to measure the time between <source1> and the first rising edge of <source2>. <source> takes value as CHANnel1, CHANnel2, CHANnel3 or CHANnel4.

➤ **Return format:**

Query returns 5.000e-003, unit is s.

:MEASure:FRF?

- **Command format:**
:MEASure:FRF? <source1>, <source2>
- **Functional description:**
This command is used to measure the time between the first rising edge of <source1> and the first falling edge of <source2>. <source> takes value as CHANnel1, CHANnel2, CHANnel3 or CHANnel4. Omitting represents the current channel.
- **Return format:**
Query returns 5.000e-003, unit is s.

:MEASure:FFR?

- **Command format:**
:MEASure:FFR? <source1>, <source2>
- **Functional description:**
This command is used to measure the time between the first falling edge of <source1> and the first rising edge of <source2>. <source> takes value as CHANnel1, CHANnel2, CHANnel3 or CHANnel4.
- **Return format:**
Query returns 5.000e-003, unit is s.

:MEASure:FFF?

- **Command format:**
:MEASure:FFF? <source1>, <source2>
- **Functional description:**
This command is used to measure the time between <source1> and the first falling edge of <source2>. <source> takes value as CHANnel1, CHANnel2, CHANnel3 or CHANnel4.
- **Return format:**
Query returns 5.000e-003, unit is s.

:MEASure:LRR?

- **Command format:**
:MEASure:LRR? <source1>,<source2>
- **Functional description:**
This command is used to measure the time between the first rising edge of <source1> and the last rising edge of <source2>. <source> takes value as CHANnel1, CHANnel2, CHANnel3 or CHANnel4.
- **Return format:**
Query returns 5.000e-003, unit is s.

:MEASure:LRF?

- **Command format:**
:MEASure:LRF? <source1>,<source2>
- **Functional description:**

This command is used to measure the time between the first rising edge of <source1> and the last falling edge of <source2>. <source> takes value as CHANnel1, CHANnel2, CHANnel3 or CHANnel4.

➤ **Return format:**

Query returns 5.000e-003, unit is s.

:MEASure:LFR?

➤ **Command format:**

:MEASure:LFR? <source1>,<source2>

➤ **Functional description:**

This command is used to measure the time between the first falling edge of <source1> and the last rising edge of <source2>. <source> takes value as CHANnel1, CHANnel2, CHANnel3 or CHANnel4.

➤ **Return format:**

Query returns 5.000e-003, unit is s.

:MEASure:LFF?

➤ **Command format:**

:MEASure:LFF? <source1>,<source2>

➤ **Functional description:**

This command is used to measure the time between the first falling edge of <source1> and the last falling edge of <source2>. <source> takes value as CHANnel1, CHANnel2, CHANnel3 or CHANnel4.

➤ **Return format:**

Query returns 5.000e-003, unit is s.

TRIGger Command

This command is used to control trigger sweep mode and trigger specification. Trigger determines when the oscilloscope to start sampling data and display waveform.

Trigger Control

:TRIGger:MODE

➤ **Command format:**

:TRIGger:MODE <mode>

:TRIGger:MODE?

➤ **Functional description:**

This command is used to set trigger mode and it can automatically suitable for trigger mode of different model.

<mode> contains EDGE (edge trigger), PULSe (pulse width trigger), VIDEo (video trigger), SLOPe (slope trigger), RUNT (runt trigger), WINDow (over-amplitude trigger), DELay (delay trigger), TIMEout (timeout trigger) DURation (duration time trigger),SHOLd (setup hold trigger), NE (Nth edge trigger) and PATtern

(pattern trigger).

➤ **Return format:**

Query returns the trigger mode.

➤ **For example:**

:TRIGger:MODE NE	Set trigger mode to Nth edge trigger.
:TRIGger:MODE?	Query returns NE.

:TRIGger:FORCe

➤ **Command format:**

:TRIGger:FORCe

➤ **Functional description:**

This command is suitable for the oscilloscope if there is no properly trigger condition. Executing this command to force to produce a trigger signal to generate input waveform and display it.

➤ **For example:**

:TRIG:FORC	Force trigger
------------	---------------

:TRIGger:SWEep

➤ **Command format:**

:TRIGger:SWEep {AUTO|NORMal|SINGle}

:TRIGger:SWEep?

➤ **Functional description:**

This command is used to select trigger sweep mode.

AUTO: In no trigger condition, the internal will generate a trigger signal to force trigger.

NORMAL: It will be generated only when the trigger condition is met.

SINGLE: Generating single trigger when the trigger condition is met and then stop.

➤ **Return format:**

Query returns trigger sweep mode {AUTO|NORMal|SINGle}.

➤ **For example:**

:TRIGger:SWEep AUTO	Set channel 1 as AUTO trigger mode.
:TRIGger:SWEep?	Query returns AUTO.

:TRIGger:LEVel:ASETup

➤ **Command format:**

:TRIGger:LEVel:ASETup

➤ **Functional description:**

This command is used to set trigger level at the vertical midpoint of signal amplitude.

➤ **For example:**

:TRIG:LEVel:ASETup	Set trigger level at the center.
--------------------	----------------------------------

:TRIGger:STATus?

- **Command format:**
:TRIGger:STATus?
- **Functional description:**
Query the current trigger status of the oscilloscope.
- **Return format:**
Query returns STOP/ARMED/READY/TRIGED/AUTO/SCAN /RESET / REPLAY/ WAIT.
- **For example:**
:TRIGger:STATus? Query returns AUTO.

:TRIGger:LEVel

- **Command format:**
:TRIGger:LEVel <level>
:TRIGger:LEVel?
- **Functional description:**
This command is used to set trigger level value of normal trigger mode. Nuerical value of<level> must be set after the conversion according to the amplitude volts/div scale and screen information.
- **Return format:**
Query returns the <level> setting value, unit is V.
- **For example:**
:TRIG:LEV 2 Set trigger level of the trigger to 2 V.
:TRIG:LEV? Query returns 2.000e000.

:TRIGger:LEVel:LOW

- **Command format:**
:TRIGger:LEVel:LOW <level>
:TRIGger:LEVel:LOW?
- **Functional description:**
This command is used to set low level value of slop trigger. Nuerical value of <level> must be set after the conversion according to the amplitude volts/div scale and screen information.
- **Return format:**
Query returns the <level> setting value, unit is V.
- **For example:**
:TRIG:LEV:LOW 2 Set trigger level of the trigger to 2 V.
:TRIG:LEV:LOW? Query returns 2.000e000.

:TRIGger:LEVel:HIGh

- **Command format:**
:TRIGger:LEVel:HIGh <level>

:TRIGger:LEVel:HIGH?

➤ **Functional description:**

This command is used to set high level value of slop trigger. Nuerical value of <level> must be set after the conversion according to the amplitude volts/div scale and screen information.

➤ **Return format:**

Query returns the <level> setting value, unit is V.

➤ **For example:**

:TRIG:LEV:HIGH 2	Set trigger level of the trigger to 2 V.
:TRIG:LEV:HIGH?	Query returns 2.000e000.

:TRIGger:SOURce

➤ **Command format:**

```
:TRIGger:SOURce <source>
:TRIGger:SOURce?
```

➤ **Functional description:**

This command is used to set single trigger source, input channel (CHANnel1, CHANnel 2, CHANnel 3, CHANnel 4), external trigger (EXT), AC Line (main electricity). EDGE/ PULSe only support AC Line, EXT and EXT5 source. VIDEo only support EXT and EXT5 source.

<source> represents trigger source and take value as follows,
CHANnel<n>|EXT|EXT5|ACLINE, <n> takes value as 1, 2, 3 or 4.

➤ **Return format:**

Query returns trigger source { CHANnel1| CHANnel2| CHANnel3| CHANnel4|EXT|EXT5|ACLINE}.

➤ **For example:**

:TRIGger:SOUR CHAN1	Set channel 1 as edge trigger.
:TRIGger:SOUR?	Query returns CHANnel1.

:TRIGger:COUPling

➤ **Command format:**

```
:TRIGger:COUPling {DC|AC|LF|HF|NOISE}
:TRIGger:COUPling?
```

➤ **Functional description:**

This command is used to set coupling mode, DC (direct current), AC (alternating current), LF (low frequency reject), HF (high frequency reject), NOISE (noise reject). Only VIDEo is not support.

➤ **Return format:**

Query returns coupling mode {DC|AC|LF|HF|NOISE}.

➤ **For example:**

:TRIGger:COUPling AC	Set edge trigger as AC.
:TRIGger:COUPling?	Query returns AC.

Edge Trigger

:TRIGger:EDGE:SLOPe

➤ **Command format:**

:TRIGger:EDGE:SLOPe {POSitive|NEGative|ALTernation}

:TRIGger:EDGE:SLOPe?

➤ **Functional description:**

This command is used to set edge trigger type, which is POSitive (rising edge), NEGative (falling edge) and ALTernation (rising/falling edge).

➤ **Return format:**

Query returns edge type of trigger source { POSitive | NEGative | ALTernation }.

➤ **For example:**

:TRIGger:EDGE:SLOP POS

Set trigger edge to rising edge.

:TRIGger:EDGE:SLOP?

Query returns POSitive.

Pulse Width Trigger

:TRIGger:PULSe:QUALifier

➤ **Command format:**

:TRIGger:PULSe:QUALifier {GREaterthan | LESSthan | INRange}

:TRIGger:PULSe:QUALifier?

➤ **Functional description:**

This command is used to set the setting condition of pulse time, which is GREaterthan (greater than), LESSthan (less than) and INRange (between).

➤ **Return format:**

Query returns {GREaterthan | LESSthan | INRange}.

➤ **For example:**

:TRIGger:PULSe:QUALifier GRE

Set pulse condition to GREaterthan.

:TRIGger:PULSe:QUALifier?

Query returns GREaterthan.

:TRIGger:PULSe:POLarity

➤ **Command format:**

:TRIGger:PULSe:POLarity {POSitive | NEGative}

:TRIGger:PULSe:POLarity?

➤ **Functional description:**

This command is used to set pulse polarity, which is POSitive and NEGative.

➤ **Return format:**

Query returns { POSitive | NEGative }.

➤ **For example:**

:TRIGger:PULSe:POL POS Set pulse polarity to POSitive.
 :TRIGger:PULSe:POL? Query returns POSitive.

:TRIGger:PULSe:TIME

➤ **Command format:**

:TRIGger:PULSe:TIME <time>
 :TRIGger:PULSe:TIME?

➤ **Functional description:**

This command is used to set time interval of pulse width trigger.

➤ **Return format:**

Query returns the current time interval, unit is s.

➤ **For example:**

:TRIGger:PULSe:TIME 1 Set time interval of pulse width trigger to 1s.
 :TRIGger:PULSe:TIME? Query returns 1.000e000.

:TRIGger:PULSe:TIME:UPPer

➤ **Command format:**

:TRIGger:PULSe:TIME:UPPer <time>
 :TRIGger:PULSe:TIME:UPPer?

➤ **Functional description:**

This command is used to set the upper time limit of pulse trigger.

➤ **Return format:**

Query returns the current upper time limit, unit is s.

➤ **For example:**

:TRIGger:PULSe:TIME:UPPer 1 Set the upper time limit of pulse trigger to 1s.
 :TRIGger:PULSe:TIME:UPPer? Query returns 1.000e000.

:TRIGger:PULSe:TIME:LOWer

➤ **Command format:**

:TRIGger:PULSe:TIME:LOWer <time>
 :TRIGger:PULSe:TIME:LOWer?

➤ **Functional description:**

This command is used to set the low time limit of pulse trigger.

➤ **Return format:**

Query returns the low time limit, unit is s.

➤ **For example:**

:TRIGger:PULSe:TIME:LOWer 1 Set the low time limit of pulse trigger to 1s.
 :TRIGger:PULSe:TIME:LOWer? Query returns 1.000e000.

Video Trigger

:TRIGger:VIDeo:MODE

➤ **Command format:**

:TRIGger:VIDeo:MODE { ODD | EVEN | LINE | ALINes }

:TRIGger:VIDeo:MODE?

➤ **Functional description:**

This command is used to set synchronization mode of video trigger, which includes ODD, EVEN, LINE (specified line) and ALINes (all lines).

➤ **Return format:**

Query returns { ODD | EVEN | LINE | ALIN }.

➤ **For example:**

:TRIGger:VIDeo:MODE ODD Set synchronization mode of video trigger to ODD.

:TRIGger:VIDeo:MODE? Query returns ODD.

:TRIGger:VIDeo:STANdard

➤ **Command format:**

:TRIGger:VIDeo:STANdard { NTSC | PAL | SECAM }

:TRIGger:VIDeo:STANdard?

➤ **Functional description:**

This command is used to set video standard.

➤ **Return format:**

Query returns { NTSC | PAL | SECAM }.

➤ **For example:**

:TRIGger:VIDeo:STANdard NTSC Set video standard to NTSC.

:TRIGger:VIDeo:STANdard? Query returns NTSC.

:TRIGger:VIDeo:LINE

➤ **Command format:**

:TRIGger:VIDeo:LINE <value>

:TRIGger:VIDeo:LINE?

➤ **Functional description:**

This command is used to set the assigned line. <value> represents the assigned line, range is relative to video standard.

➤ **Return format:**

Query returns the current assigned line.

➤ **For example:**

:TRIG:VIDeo:LINE 50 Set the assigned line of video synchronization to 50.

:TRIG:VIDeo:LINE? Query returns 50.

Slope Trigger

:TRIGger:SLOPe:QUALifier

➤ **Command format:**

:TRIGger:SLOPe:QUALifier {GREaterthan|LESSthan|INRange}

:TRIGger:SLOPe:QUALifier?

➤ **Functional description:**

This command is used to set the setting condition of slop time, which includes GREaterthan (greater than), LESSthan (less than) and INRange (between).

➤ **Return format:**

Query returns {GREaterthan|LESSthan|INRange}.

➤ **For example:**

:TRIGger:SLOPe:QUALifier GRE Set slop condition to GREaterthan.

:TRIGger:SLOPe:QUALifier? Query returns GREaterthan.

:TRIGger:SLOPe:SLOPe

➤ **Command format:**

:TRIGger:SLOPe:SLOPe {POSitive|NEGative}

:TRIGger:SLOPe:SLOPe?

➤ **Functional description:**

This command is used to set slop trigger type, which includes POSitive (rising) and NEGative (falling).

➤ **Return format:**

Query returns {POSitive|NEGative}.

➤ **For example:**

:TRIGger:SLOPe:SLOPe POS Set slop trigger as POSitive.

:TRIGger:SLOPe:SLOPe? Query returns POSitive.

:TRIGger:SLOPe:TIME

➤ **Command format:**

:TRIGger:SLOPe:TIME <time>

:TRIGger:SLOPe:TIME?

➤ **Functional description:**

Set the time of slop trigger mode.

➤ **Return format:**

Query returns the current time interval, unit is s.

➤ **For example:**

:TRIGger:SLOPe:TIME 1 Set the time interval of slop trigger mode to 1s.

:TRIGger:SLOPe:TIME? Query returns 1.000e000.

:TRIGger:SLOPe:TIME:UPPer➤ **Command format:**

:TRIGger:SLOPe:TIME:UPPer <time>

:TRIGger:SLOPe:TIME:UPPer?

➤ **Functional description:**

This command is used to set the upper time limit of slope trigger.

➤ **Return format:**

Query returns the upper time limit, unit is s.

➤ **For example:**

:TRIGger:SLOPe:TIME:UPPer 1 Set the upper time limit of slope trigger to 1s.

:TRIGger:SLOPe:TIME:UPPer? Query returns 1.000e000.

:TRIGger:SLOPe:TIME:LOWer➤ **Command format:**

:TRIGger:SLOPe:TIME:LOWer <time>

:TRIGger:SLOPe:TIME:LOWer?

➤ **Functional description:**

This command is used to set the low time limit of slope trigger.

➤ **Return format:**

Query returns the current time interval, unit is s.

➤ **For example:**

:TRIGger:SLOPe:TIME:LOWer 1 Set the low time limit of slope trigger to 1s.

:TRIGger:SLOPe:TIME:LOWer? Query returns 1.000e000.

:TRIGger:SLOPe:THReshold➤ **Command format:**

:TRIGger:SLOPe:THReshold {LOW|HIGH|LH}

:TRIGger:SLOPe:THReshold?

➤ **Functional description:**

This command is used to set threshold mode of slope trigger.

➤ **Return format:**

Query returns {LOW|HIGH|LH}.

➤ **For example:**

:TRIGger:SLOPe:THR HIGH Set slope trigger threshold to HIGH.

:TRIGger:SLOPe:THR? Query returns HIGH.

:TRIGger:SLOPe:RAte:LOWer?➤ **Command format:**

:TRIGger:SLOPe:RAte:LOWer?

- **Functional description:**
Set the lower limit of the current slop trigger.
- **Return format:**
Query returns the low limit of slope trigger in scientific notation.
- **For example:**
:TRIGger:SLOPe:RATE:LOWer? Query returns 3.210E+000.

:TRIGger:SLOPe:RATE:UPPer?

- **Command format:**
:TRIGger:SLOPe:RATE:UPPer?
- **Functional description:**
Query Set the uuper limit of the current slop trigger.
- **Return format:**
Query returns the upper limit of slope trigger in scientific notation.
- **For example:**
:TRIGger:SLOPe:RATE:UPPer? Query returns 3.210E+000.

Runt Trigger

:TRIGger:RUNT:QUALifier

- **Command format:**
:TRIGger:RUNT:QUALifier {GREaterthan | LESSthan | INRange | NONE}
:TRIGger:RUNT:QUALifier?
- **Functional description:**
This command is used to set the setting condition of runt level time, which includes GREaterthan (greater than), LESSthan (less than), INRange (within the range) and NONE (random).
- **Return format:**
Query returns {GREaterthan | LESSthan | INRange | NONE}.
- **For example:**
:TRIGger:RUNT:QUALifier GRE Set trigger condition to GREaterthan.
:TRIGger:RUNT:QUALifier? Query returns GREaterthan.

:TRIGger:RUNT:POLarity

- **Command format:**
:TRIGger:RUNT:POLarity {POSitive | NEGative}
:TRIGger:RUNT:POLarity?
- **Functional description:**
This command is used to set the pulse polarity of runt level, which includes POSitive (positive pulse width) and NEGative (negative pulse width).

- **Return format:**
Query returns {POSitive | NEGative}.
- **For example:**
:TRIGger:RUNT:POL POS Set the pulse polarity to POSitive.
:TRIGger:RUNT:POL? Query returns POSitive.

:TRIGger:RUNT:LEVel

- **Command format:**
:TRIGger:RUNT:LEVel {LOW | HIGH | LH}
:TRIGger:RUNT:LEVel?
- **Functional description:**
This command is used to set trigger level mode of runt level trigger.
- **Return format:**
Query returns {LOW | HIGH | LH}.
- **For example:**
:TRIGger:RUNT:LEV HIGH Set runt level to HIGH.
:TRIGger:RUNT:LEV? Query returns HIGH.

:TRIGger:RUNT:TIME

- **Command format:**
:TRIGger:RUNT:TIME <time>
:TRIGger:RUNT:TIME?
- **Functional description:**
This command is used to set time interval of runt level trigger.
- **Return format:**
Query returns the current time interval, unit is s.
- **For example:**
:TRIGger:RUNT:TIME 1 Set the time interval of runt level trigger to 1s.
:TRIGger:RUNT:TIME? Query returns 1.000e000.

:TRIGger:RUNT:TIME:UPPer

- **Command format:**
:TRIGger:RUNT:TIME:UPPer <time>
:TRIGger:RUNT:TIME:UPPer?
- **Functional description:**
This command is used to set the upper time limit of runt level trigger.
- **Return format:**
Query returns the current upper time limit, unit is s.
- **For example:**
:TRIGger:RUNT:TIME:UPPer 1

Set the upper trigger time limit of runt level trigger to 1s.

:TRIGger:RUNT:TIME:UPPer? Query returns 1.000e000.

:TRIGger:RUNT:TIME:LOWer

➤ **Command format:**

:TRIGger:RUNT:TIME:LOWer <time>

:TRIGger:RUNT:TIME:LOWer?

➤ **Functional description:**

This command is used to set the lower time limit of runt level trigger.

➤ **Return format:**

Query returns the current lower time limit, unit is s.

➤ **For example:**

:TRIGger:RUNT:TIME:LOWer 1 Set the lower time limit of runt level trigger to 1s.

:TRIGger:RUNT:TIME:LOWer? Query returns 1.000e000.

Over-amplitude Trigger

:TRIGger:WINDow:SLOPe

➤ **Command format:**

:TRIGger:WINDow:SLOPe {POSitive|NEGative|ALTernation}

:TRIGger:WINDow:SLOPe?

➤ **Functional description:**

This command is used to set edge type of trigger source, which is POSitive (rising edge), NEGative (falling edge) and ALTernation (rising/falling edge).

➤ **Return format:**

Query returns edge type of trigger souece {POSitive|NEGative|ALTernation}.

➤ **For example:**

:TRIGger:WINDow:SLOP POS Set window trigger to rising edge.

:TRIGger:WINDow:SLOP? Query returns POS.

:TRIGger:WINDow:LEVel

➤ **Command format:**

:TRIGger:WINDow:LEVel {LOW|HIGH|LH}

:TRIGger:WINDow:LEVel?

➤ **Functional description:**

This command is used to set level mode of window trigger.

➤ **Return format:**

Query returns {LOW|HIGH|LH}.

- **For example:**
:TRIGger:WINDow:LEV HIGH Set window trigger to HIGH.
:TRIGger:WINDow:LEV? Query returns HIGH.

:TRIGger:WINDow:TIME

- **Command format:**
:TRIGger:WINDow:TIME <time>
:TRIGger:WINDow:TIME?
- **Functional description:**
This command is used to set time interval of window trigger.
- **Return format:**
Query returns the current time interval, unit is s.
- **For example:**
:TRIGger:WINDow:TIME 1 Set time interval of window trigger to 1s.
:TRIGger:WINDow:TIME? Query returns 1.000e000.

:TRIGger:WINDow:POSition

- **Command format:**
:TRIGger:WINDow:POSition {ENTER|EXIT|TIME}
:TRIGger:WINDow:POSition?
- **Functional description:**
This command is used to set window trigger position.
- **Return format:**
Query returns {ENTER|EXIT|TIME}.
- **For example:**
:TRIGger:WINDow:POS TIME Set window trigger position to TIME.
:TRIGger:WINDow:POS? Query returns TIME.

Delay Trigger

:TRIGger:DELay:ARM:SOURce

- **Command format:**
:TRIGger:DELay:ARM:SOURce {CHANnel1|CHANnel2|CHANnel3|CHANnel4}
:TRIGger:DELay:ARM:SOURce?
- **Functional description:**
This command is used to set focus source of delay trigger.
- **Return format:**
Query returns {CHANnel1|CHANnel2|CHANnel3|CHANnel4}.

- **For example:**

:TRIGger:DELay:ARM:SOUR CHAN1	Set channel 1 as focus source.
:TRIGger:DELay:ARM:SOUR?	Query returns CHANnel1.

:TRIGger:DELay:ARM:SLOPe

- **Command format:**

```
:TRIGger:DELay:ARM:SLOPe {NEGative | POSitive}
:TRIGger:DELay:ARM:SLOPe?
```
- **Functional description:**

This command is used to set edge type of trigger source, which includes POSitive (rising edge) and NEGative (falling edge).
- **Return format:**

Query returns {NEGative | POSitive}.
- **For example:**

:TRIGger:DELay:ARM:SLOPe NEG	Set edge type of trigger source to NEGative.
:TRIGger:DELay:ARM:SLOPe?	Query returns NEGative.

:TRIGger:DELay:TRIGger:SOURce

- **Command format:**

```
:TRIGger:DELay:TRIGger:SOURce {CHANnel1 | CHANnel2 | CHANnel3 | CHANnel4}
:TRIGger:DELay:TRIGger:SOURce?
```
- **Functional description:**

This command is used to set trigger source of delay trigger.
- **Return format:**

Query returns {CHANnel1 | CHANnel2 | CHANnel3 | CHANnel4}.
- **For example:**

:TRIGger:DELay:TRIGger:SOUR CHAN1	Set channel 1 as trigger source.
:TRIGger:DELay:TRIGger:SOUR?	Query returns CHANnel1

:TRIGger:DELay:TRIGger:SLOPe

- **Command format:**

```
:TRIGger:DELay:TRIGger:SLOPe {NEGative | POSitive}
:TRIGger:DELay:TRIGger:SLOPe?
```
- **Functional description:**

This command is used to set edge type of trigger source, which includes POSitive (rising edge) and NEGative (falling edge).
- **Return format:**

Query returns {NEGative | POSitive}.
- **For example:**

:TRIGger:DELay:TRIGger:SLOPe NEG	Set edge type of trigger source to NEGative.
----------------------------------	--

:TRIGger:DElay:TRIGger:SLOPe? Query returns NEGative

:TRIGger:DElay:QUALifier

➤ **Command format:**

:TRIGger:DElay:QUALifier { GREaterthan | LESSthan | INRange | OUTRange }

:TRIGger:DElay:QUALifier?

➤ **Functional description:**

This command is used to set time interval condition of delay trigger, which includes GREaterthan (greater than), LESSthan (less than), INRange (within in the range) and OUTRange (out of the range).

➤ **Return format:**

Query returns { GREaterthan | LESSthan | INRange | OUTRange }.

➤ **For example:**

:TRIGger:DElay:QUALifier GRE Set slope condition to GREaterthan.

:TRIGger:DElay:QUALifier? Query returns GREaterthan.

:TRIGger:DElay:TIME

➤ **Command format:**

:TRIGger:DElay:TIME <time>

:TRIGger:DElay:TIME?

➤ **Functional description:**

This command is used to set the time interval of delay trigger.

➤ **Return format:**

Query returns the current time interval, unit is s.

➤ **For example:**

:TRIGger:DElay:TIME 1 Set the time interval of delay trigger to 1s.

:TRIGger:DElay:TIME? Query returns 1.000e000.

:TRIGger:DElay:TIME:UPPer

➤ **Command format:**

:TRIGger:DElay:TIME:UPPer <time>

:TRIGger:DElay:TIME:UPPer?

➤ **Functional description:**

This command is used to set the upper time limit of delay trigger.

➤ **Return format:**

Query returns the current upper time limit, unit is s.

➤ **For example:**

:TRIGger:DElay:TIME:UPPer 1 Set the upper time limit of trigger delay to 1s.

:TRIGger:DElay:TIME:UPPer? Query returns 1.000e000.

:TRIGger:DElay:TIME:LOWer➤ **Command format:**

```
:TRIGger:DElay:TIME:LOWer <time>
```

```
:TRIGger:DElay:TIME:LOWer?
```

➤ **Functional description:**

This command is used to set the lower time limit of delay trigger.

➤ **Return format:**

Query returns the current lower time limit, unit is s.

➤ **For example:**

```
:TRIGger:DElay:TIME:LOWer 1          Set the lower time limit of delay trigger to 1s.
```

```
:TRIGger:DElay:TIME:LOWer?          Query returns 1.000e000.
```

:TRIGger:DElay:SElect➤ **Command format:**

```
:TRIGger:DElay:SElect <SOURce<n>>
```

```
:TRIGger:DElay:SElect
```

➤ **Functional description:**

This command is used to switch the selected source. SOURce<n> represents source, n takes value as 1 or 2.

SOURce1 represents focus source; SOURce2 represents trigger source.

➤ **Return format:**

Query returns { SOURce1|SOURce2 }.

➤ **For example:**

```
:TRIGger:DElay:SElect SOURce1        Set to select the focus trigger.
```

```
:TRIGger:DElay:SElect?              Query returns SOURce1.
```

Timeout Trigger

:TRIGger:TIMEOUT:TIME➤ **Command format:**

```
:TRIGger:TIMEOUT:TIME <time>
```

```
:TRIGger:TIMEOUT:TIME?
```

➤ **Functional description:**

This command is used to set time interval of timeout trigger.

➤ **Return format:**

Query returns the current time interval, unit is s.

➤ **For example:**

```
:TRIGger:TIMEOUT:TIME 1              Set time interval of timeout trigger to 1s.
```

:TRIGger:TIMEOUT:TIME?

Query returns 1.000e000.

:TRIGger:TIMEOUT:SLOPe

➤ **Command format:**

:TRIGger:TIMEOUT:SLOPe {POSitive|NEGative|ALTernation}

:TRIGger:TIMEOUT:SLOPe?

➤ **Functional description:**

This command is used to set edge type of trigger souece, which includes POSitive (rising edge), NEGative (falling edge) and ALTernation (rising/falling edge).

➤ **Return format:**

Query returns edge type of trigger souece {POSitive|NEGative|ALTernation}.

➤ **For example:**

:TRIGger:TIMEOUT:SLOP POS

Set edge trigger to POSitive.

:TRIGger:TIMEOUT:SLOP?

Query returns POSitive.

Duration Trigger

:TRIGger:DURation:PATtern

➤ **Command format:**

:TRIGger:DURation:PATtern {HIGH|LOW|X}

:TRIGger:DURation:PATtern?

➤ **Functional description:**

This command is used to set pattern of duration trigger, which is HIGH (pattern value is 1), LOW (pattern value is 0) and X(channel is invalid).

➤ **Return format:**

Query returns {HIGH|LOW|X}.

➤ **For example:**

:TRIGger:DURation:PATtern HIGH

Set patter of duration trigger to 1.

:TRIGger:DURation:PATtern?

Query returns HIGH.

:TRIGger:DURation:QUALifier

➤ **Command format:**

:TRIGger:DURation:QUALifier {GREaterthan|LESSthan|INRange}

:TRIGger:DURation:QUALifier?

➤ **Functional description:**

This command is used to set time interval condition, which includes GREaterthan (greater than), LESSthan (less than) and INRange (within the range).

➤ **Return format:**

Query returns {GREaterthan|LESSthan|INRange}.

- **For example:**

:TRIGger:DURation:QUALifier GRE	Set slope condition to GREaterthan.
:TRIGger:DURation:QUALifier?	Query returns GREaterthan.

:TRIGger:DURation:TIME:LOWer

- **Command format:**

:TRIGger:DURation:TIME:LOWer <time>	
:TRIGger:DURation:TIME:LOWer?	
- **Functional description:**

This command is used to set the lower time limit of duration trigger. It can be set when time interval condition is GREaterthan (greater than).
- **Return format:**

Query returns the current lower limit, unit is s.
- **For example:**

:TRIGger:DURation:TIME:LOWer 1	Set the lower time limit of duration trigger to 1s.
:TRIGger:DURation:TIME:LOWer?	Query returns 1.000e000.

:TRIGger:DURation:TIME:UPPer

- **Command format:**

:TRIGger:DURation:TIME:UPPer <time>	
:TRIGger:DURation:TIME:UPPer?	
- **Functional description:**

This command is used to set the upper time limit of duration trigger. It can be set when time interval condition is LESSthan (less than).
- **Return format:**

Query returns the current upper time limit, unit is s.
- **For example:**

:TRIGger:DURation:TIME:UPPer 1	Set the upper time limit of duration trigger to 1s.
:TRIGger:DURation:TIME:UPPer?	Query returns 1.000e000.

Setup Hold Trigger

:TRIGger:SHOLd:DATA:SOURce

- **Command format:**

:TRIGger:SHOLd:DATA:SOURce {CHANnel1 CHANnel2 CHANnel3 CHANnel4}	
:TRIGger:SHOLd:DATA:SOURce?	
- **Functional description:**

This command is used to set data source of setup hold trigger.

➤ **Return format:**

Query returns {CHANnel1 | CHANnel2 | CHANnel3 | CHANnel4}.

➤ **For example:**

:TRIGger:SHOLd:DATA:SOUR CHAN1	Set channel 1 as data source.
:TRIGger:SHOLd:DATA:SOUR?	Query returns CHANnel1.

:TRIGger:SHOLd:CLOCK:SOURce

➤ **Command format:**

:TRIGger:SHOLd:CLOCK:SOURce {CHANnel1 | CHANnel2 | CHANnel3 | CHANnel4}
:TRIGger:SHOLd:CLOCK:SOURce?

➤ **Functional description:**

This command is used to set clock source of setup hold trigger.

➤ **Return format:**

Query returns {CHANnel1 | CHANnel2 | CHANnel3 | CHANnel4}.

➤ **For example:**

:TRIGger:SHOLd:CLOCK:SOUR CHAN1	Set channel 1 as clock source.
:TRIGger:SHOLd:CLOCK:SOUR?	Query returns CHANnel1.

:TRIGger:SHOLd:SLOPe

➤ **Command format:**

:TRIGger:SHOLd:SLOPe {POSitive|NEGative}
:TRIGger:SHOLd:SLOPe?

➤ **Functional description:**

This command is used to set edge type of setup hold trigger, which includes POSitive (rising edge) and NEGative (falling edge).

➤ **Return format:**

Query returns {POSitive|NEGative}.

➤ **For example:**

:TRIGger:SHOLd:SLOPe POS	Set setup hold trigger to POSitive.
:TRIGger:SHOLd:SLOPe?	Query returns POSitive.

:TRIGger:SHOLd:PATTern

➤ **Command format:**

:TRIGger:SHOLd:PATTern { HIGH | LOW }
:TRIGger:SHOLd:PATTern?

➤ **Functional description:**

This command is used to set pattern of setup hold trigger, which includes HIGH (pattern value is 1) and LOW (pattern value is 0).

➤ **Return format:**

Query returns { HIGH | LOW }.

- **For example:**
 - :TRIGger:SHOLd:PATtern HIGH Set pattern of setup hold trigger to 1.
 - :TRIGger:SHOLd:PATtern? Query returns HIGH.

:TRIGger:SHOLd:MODE

- **Command format:**
 - :TRIGger:SHOLd:MODE { SETup|HOLD|SH }
 - :TRIGger:SHOLd:MODE?
- **Functional description:**

This command is used to set time mode of setup hold trigger, which includes SETup (setup time) , HOLD (hold time) and SH (setup hold time).
- **Return format:**

Query returns { SETup|HOLD|SH }.
- **For example:**
 - :TRIGger:SHOLd:MODE HOLD Set time mode of setup hold trigger to HOLD.
 - :TRIGger:SHOLd:MODE? Query returns HOLD.

:TRIGger:SHOLd:TIME

- **Command format:**
 - :TRIGger:SHOLd:TIME <time>
 - :TRIGger:SHOLd:TIME?
- **Functional description:**

This command is used to set time interval of setup hold trigger.
- **Return format:**

Query returns the current time interval, unit is s.
- **For example:**
 - :TRIGger:SHOLd:TIME 1 Set time interval of setup hold trigger to 1s.
 - :TRIGger:SHOLd:TIME? Query returns 1.000e000.

:TRIGger:SHOLd:SELEct

- **Command format:**
 - :TRIGger:SHOLd:SELEct <SOURce<n>>
 - :TRIGger:SHOLd:SELEct
- **Functional description:**

This command is used to switch the selected source. SOURce<n> represents source, n takes value as 1 or 2.
SOURce1 represents data source; SOURce2 represents clock source.
- **Return format:**

Query returns { SOURce1|SOURce2 }.
- **For example:**

:TRIGger:SHOLd:SElect SOURce1	Set the selected focus source.
:TRIGger:SHOLd:SElect?	Query returns SOURce1.

Nth edge Trigger

:TRIGger:NEDGE:SLOPe

➤ **Command format:**

```
:TRIGger:NEDGE:SLOPe {POSitive|NEGative}
:TRIGger:NEDGE:SLOPe?
```

➤ **Functional description:**

This command is used to set edge type of the trigger, which includes POSitive (rising edge) and NEGative (falling edge).

➤ **Return format:**

Query returns edge type of the trigger {POSitive|NEGative }.

➤ **For example:**

:TRIGger:NEDGE:SLOP POS	Set edge trigger to POSitive.
:TRIGger:NEDGE:SLOP?	Query returns POSitive.

:TRIGger:NEDGE:TIME

➤ **Command format:**

```
:TRIGger:NEDGE:TIME <time>
:TRIGger:NEDGE:TIME?
```

➤ **Functional description:**

This command is used to set time interval of Nth edge trigger.

➤ **Return format:**

Query returns the current time interval, unit is s.

➤ **For example:**

:TRIGger:NEDGE:TIME 1	Set time interval of Nth edge trigger to 1s.
:TRIGger:NEDGE:TIME?	Query returns 1.000e000.

:TRIGger:NEDGE:VALue

➤ **Command format:**

```
:TRIGger:NEDGE:VALue <value>
:TRIGger:NEDGE:VALue?
```

➤ **Functional description:**

This command is used to set Nth edge value, <value> is integer value and the range can set to 0~65535.

➤ **Return format:**

Query returns the current Nth edge value.

- **For example:**

:TRIGger:NEDGE:VALue 100	Set Nth edge value to 100.
:TRIGger:NEDGE:VALue?	Query returns 100.

Pattern Trigger

:TRIGger:PATtern:PATtern

- **Command format:**

```
:TRIGger:PATtern:PATtern { HIGH|LOW|X|POSitive|NEGative }
:TRIGger:PATtern:PATtern?
```
- **Functional description:**

This command is used to set pattern trigger, which includes HIGH (pattern value is 1), LOW (pattern value is 0), X (channel is invalid), POSitive (rising edge), NEGative (falling edge).
- **Return format:**

Query returns { HIGH|LOW|X|POSitive|NEGative }.
- **For example:**

:TRIGger:PATtern:PATtern HIGH	Set patter trigger to 1.
:TRIGger:PATtern:PATtern?	Query returns HIGH.

CURSor Command

This command is used to set cursor parameter to measure the waveform data on the screen.

:CURSor:MODE

- **Command format:**

```
:CURSor:MODE { TRACK|INDEpendent }
:CURSor:MODE?
```
- **Functional description:**

This command is used to set cursor mode, which includes TRACK and INDEpendent.
- **Return format:**

Query returns { TRACK|INDEpendent }.
- **For example:**

:CURSor:MODE TRACK	Set cursor mode to TRACK.
:CURSor:MODE?	Query returns TRACK.

:CURSor:TYPE

- **Command format:**

```
:CURSor:TYPE { AMPlitude|TIME|SCReen|CLOSe }
:CURSor:TYPE?
```

➤ **Functional description:**

This command is used to set cursor type of cursor mode, which includes AMPLitude, TIME, CLOSe and SCReen.

➤ **Return format:**

Query returns {AMPLitude | TIME | SCReen| CLOSe }.

➤ **For example:**

:CURSor:TYPE AMP Set cursor type to AMPLitude.
:CURSor:TYPE? Query returns AMPLitude.

:CURSor:SOURce

➤ **Command format:**

:CURSor:SOURce <source>
:CURSor:SOURce?

➤ **Functional description:**

This command is used to set cursor source of manual cursor mode.

<source> takes value as {CHANnel<n>|MATH| REFA| REFB| REFC| REFD}, n takes value as 1, 2, 3 or 4.

➤ **Return format:**

Query returns { CHANnel1| CHANnel2| CHANnel3| CHANnel4| MATH| REFA| REFB| REFC| REFD }.

➤ **For example:**

:CURSor:SOURce CHAN1 Set channel 1 as cursor source.
:CURSor:SOURce? Query returns CHANnel1.

:CURSor:CURAX

➤ **Command format:**

:CURSor:CURAX <value>
:CURSor:CURAX?

➤ **Functional description:**

This command is used to set the horizontal position of cursor line A.

The range of time base YT mode is from left to right [0,699]. The range of time base of XY mode is from left to right [28,227].

➤ **Return format:**

Query returns the horizontal position of cursor line A.

➤ **For example:**

:CURSor:CURAX 50 Set the horizontal position of cursor line A to 50 by manual.
:CURSor:CURAX? Query returns 50.

:CURSor:CURAY

➤ **Command format:**

:CURSor:CURAY <value>
:CURSor:CURAY?

- **Functional description:**
This command is used to set the vertical position of cursor line A. The range is from down to top [28,227].
- **Return format:**
Query returns the vertical position of cursor line A.
- **For example:**

:CURSor:CURAY 50	Set the vertical position of cursor line A to 50 by manual.
:CURSor:CURAY?	Query returns 50.

:CURSor:CURBX

- **Command format:**
:CURSor:CURBX <value>
:CURSor:CURBX?
- **Functional description:**
This command is used to set the horizontal position of cursor line B. The range of time base YT mode is from left to right [0,699]. The range of time base of XY mode is from left to right [28,227].
- **Return format:**
Query returns the horizontal position of cursor line B.
- **For example:**

:CURSor:CURBX 50	Set the horizontal position of cursor line B to 50 by manual.
:CURSor:CURBX?	Query returns 50.

:CURSor:CURBY

- **Command format:**
:CURSor:CURBY <value>
:CURSor:CURBY?
- **Functional description:**
This command is used to set the vertical position of cursor line B. The range is from down to top [28,227].
- **Return format:**
Query returns the vertical position of cursor line B.
- **For example:**

:CURSor:CURBY 50	Set the vertical position of cursor line B to 50 by manual.
:CURSor:CURBY?	Query returns 50.

:CURSor:AXValue?

- **Command format:**
:CURSor:AXValue?
- **Functional description:**
Query X value at cursor A, unit is determined by the amplitude unit of the currently selected channel.
- **Return format:**
Query returns X value at the current cursor A in scientific notation.

- **For example:**
:CURSor:AXV? Query returns 2.000000E+02.

:CURSor:AYValue?

- **Command format:**
:CURSor:AYValue?
- **Functional description:**
Query Y value at cursor A, unit is determined by the amplitude unit of the currently selected channel.
- **Return format:**
Query returns Y value at the current cursor A in scientific notation.
- **For example:**
:CURSor:AYV? Query returns 2.000000E+02.

:CURSor:BXValue?

- **Command format:**
:CURSor:BXValue?
- **Functional description:**
Query X value at cursor B, unit is determined by the amplitude unit of the currently selected channel.
- **Return format:**
Query returns X value at the current cursor B in scientific notation.
- **For example:**
:CURSor:BXV? Query returns 2.000000E+02.

:CURSor:BYValue?

- **Command format:**
:CURSor:BYValue?
- **Functional description:**
Query Y value at cursor B, unit is determined by the amplitude unit of the currently selected channel.
- **Return format:**
Query returns Y value at the current cursor B in scientific notation.
- **For example:**
:CURSor:BYV? Query returns 2.000000E+02.

:CURSor:XDELta?

- **Command format:**
:CURSor:XDELta?
- **Functional description:**
Query the X difference ΔX between cursor A and cursor B in cursor tracking measurement.
- **Return format:**

Query returns the current X difference between cursor A and cursor B in scientific notation.

➤ **For example:**

:CURSor:XDEL?

Query returns 2.000000E+02.

:CURSor:YDELta?

➤ **Command format:**

:CURSor:YDELta?

➤ **Functional description:**

Query the Y difference ΔY between cursor A and cursor B in cursor tracking measurement. The unit is the same as the unit of the currently selected channel.

➤ **Return format:**

Query returns the current Y difference between cursor A and cursor B in scientific notation.

➤ **For example:**

:CURSor:YDEL?

Query returns 2.000000E+02.

:CURSor:XY?

➤ **Command format:**

:CURSor:XY?

➤ **Functional description:**

Query all the measurement parameter of cursor measurement command [:DISPlay:TYPE](#) in XY mode.

➤ **Return format:**

Query returns all the measurement parameter in XY mode. The numerical value with the standard unit and returned in scientific notation.

The return order refers to [Appendix 3: Cursor Measurement in XY mode](#). The order is from up to down in sequence.

➤ **For example:**

:CURSor:XY?

Query returns all cursor measurement parameter in XY12 mode, such as "1.0E+02, 3.0E+01,....."

FILE Command

This command is used to set reference waveform and storage function.

:FILE:LOAD

➤ **Command format:**

:FILE:LOAD <filename>, [<source>], [<disk>]

➤ **Functional description:**

This command is used to load waveform to the reference channel or set the data.

<filename> represents the filename and it must be character string data with double quotation mark, for example "test.bsv".

- The file name of *.dat represents load waveform data of a file into the reference channel, it matched

with the oscilloscope's suffix name.

- The file name of *.set represents load the setting data of a file into the oscilloscope, it matched with the oscilloscope's suffix name.
- The file name of *.bode.csv represents load the bode diagram data of a file into the oscilloscope, it matched with the oscilloscope's suffix name. And it's only effect to U flash disk.

<source > represents reference channel {REFA | REFB | REFC | REFD}, optional parameter. Only valid when loading waveform data.

- REFA represents reference channel A
- REFB represents reference channel B
- REFC represents reference channel C
- REFD represents reference channel D

<disk> represents memory medium { FLASH | UDISK}, optional parameter. Omitting represents internal data of FLASH.

- FLASH represents internal data.
- UDISK represents U flash disk data.

➤ **For example:**

```
FILE:LOAD "test.dat",REFA,UDISK
```

Load test.dat waveform data from U flash disk into reference channel A.

```
FILE:LOAD "system-set-up01.set"
```

Load position 1 configuration data from internal medium into the oscilloscope.

```
FILE:LOAD "001.bode.csv"
```

Load the bode diagram data from U flash disk into the oscilloscope.

Notes: When the oscilloscope can not self-defined the file name and suffix

- The file name of internal storage setting must be "system-set-up01.set"~ "system-set-up255.set", the maximum limit is 255 files.
- The file name of internal storage bsv file must be "wave01.bsv"~" wave255.bsv", the maximum limit is 255 files.

:FILE:SAVE

➤ **Command format:**

```
:FILE:SAVE <filename>,[<source>],[<disk>]
```

➤ **Functional description:**

This command is used to set channel waveform or the setting data into file.

<filename> represents the file name and it must be character string data with double quotation mark, for example "test.bsv".

- The file name of *.dat represents load waveform data of a file into the reference channel, it matched with the oscilloscope's suffix name.
- The file name of *.set represents load the setting data of a file into the oscilloscope, it matched with the oscilloscope's suffix name.
- The file name of *.bode.csv represents load the bode diagram data of a file into the oscilloscope, it matched with the oscilloscope's suffix name. And it's only effect to U flash disk.

<source > represents physical channel {CHANnel1 | CHANnel2 | CHANnel3 | CHANnel4} optional parameter. Only valid when saving waveform data.

- CHANnel1 represents channel 1.

- CHANnel2 represents channel 2.
- CHANnel3 represents channel 3.
- CHANnel4 represents channel 4.

<disk> represents storage medium { FLASH | UDISK }, optional parameter. Omitting represents internal data of FLASH.

- FLASH represents internal data.
- UDISK represents U flash disk data.

➤ **For example:**

FILE:SAVE "test.dat",CHANnel1,UDISK

Save waveform data of channel 1 as test.csv format into U flash disk.

FILE:SAVE "system-set-up01.set"

The configuration data of oscilloscope save as 1 position of internal medium.

FILE:SAVE "wave01.dat",CHANnel1,FLASH

Save waveform data of channel 1 into internal medium.

FILE:SAVE "wave01.dat",CHANnel1

Save waveform data of channel 1 into internal medium.

FILE:SAVE "system-set-up01.set",FLASH

The configuration data of oscilloscope save as internal medium.

FILE:SAVE "system-set-up01.set"

The configuration data of oscilloscope save as 1 position of internal medium.

FILE:SAVE "001.bode.csv",UDISK

Load the bode diagram data from U flash disk into the oscilloscope.

Notes: When the oscilloscope can not self-defined the file name and suffix

- The file name of internal storage setting must be "system-set-up01.set"~ "system-set-up255.set", the maximum limit is 255 files.
- The file name of internal storage bsv file must be "wave01.bsv"~" wave255.bsv", the maximum limit is 255 files.

RECORD Command

This command is used to set recording waveform function of the oscilloscope.

:RECORD:ENABLE

➤ **Command format:**

:RECORD:ENABLE { {1|ON} | {0|OFF} }

:RECORD:ENABLE?

➤ **Functional description:**

This command is used to turn on/off recording waveform function.

➤ **Return format:**

Query returns 1 or 0, it respectively represents ON or OFF.

➤ **For example:**

:RECORD:ENABLE ON

Turn on recording waveform function.

:RECORD:ENABLE?

Query returns 1, it represents recording waveform function is turned on.

:RECO:STARt➤ **Command format:**

:RECO:STARt {{1|ON}}|{0|OFF}}

:RECO:STARt?

➤ **Functional description:**

This command is used to start/stop recording waveform.

➤ **Return format:**

Query returns 1 or 0, it respectively represents ON or OFF.

➤ **For example:**

:RECO:STARt ON Start to recording waveform.

:RECO:STARt?

Query returns 1, it represents the recording waveform is started.

:RECO:FAST➤ **Command format:**

:RECO:FAST {{1|ON}}|{0|OFF}}

:RECO:FAST?

➤ **Functional description:**

This command is used to turn on/off quick recording waveform.

➤ **Return format:**

Query returns 1 or 0, it respectively represents ON or OFF.

➤ **For example:**

:RECO:FAST ON Turn on quick recording waveform.

:RECO:FAST?

Query returns 1, it represents quick recording waveform is started.

:RECO:INTERval➤ **Command format:**

:RECO:INTERval <time>

:RECO:INTERval?

➤ **Functional description:**

This command is used to set time interval of recording waveform.

➤ **Return format:**

Query returns time interval of recording waveform in scientific notation, unit is s.

➤ **For example:**

:RECO:INTERval 200ns Set play delay time of recording waveform to 200ns.

:RECO:INTERval? Query returns 2.000e-004.

:RECO:PLAY➤ **Command format:**

:RECO:PLAY {{1|ON}}|{0|OFF}}

:RECO:PLAY?

➤ **Functional description:**

This command is used to start or stop play recording waveform.

➤ **Return format:**

Query returns 1 or 0, it respectively represents ON or OFF.

➤ **For example:**

:RECORD:PLAY ON

Start to play recording waveform.

:RECORD:PLAY?

Query returns 1, it represents start to play the recording waveform.

:RECORD:PLAY:DELAy

➤ **Command format:**

:RECORD:PLAY:DELAy <time>

:RECORD:PLAY:DELAy?

➤ **Functional description:**

This command is used to set play delay time of recording waveform.

➤ **Return format:**

Query returns play delay time of recording waveform in scientific notation, unit is s.

➤ **For example:**

:RECORD:PLAY:DELAy 20ms

Set play delay time of recording waveform to 20ms.

:RECORD:PLAY:DELAy?

Query returns 2.000e-002.

:RECORD:CURREnt

➤ **Command format:**

:RECORD:CURREnt <value>

:RECORD:CURREnt?

➤ **Functional description:**

This command is used to set or query the current frame of recording waveform.

➤ **Return format:**

Query returns the current frame of recording waveform, it is integer data.

➤ **For example:**

:RECORD:CURREnt 100

Set the current frame of recording waveform to 100.

:RECORD:CURREnt?

Query returns 100.

:RECORD:FRAMES

➤ **Command format:**

:RECORD:FRAMES <value>

:RECORD:FRAMES?

➤ **Functional description:**

This command is used to set or query the frame number of recording waveform.

➤ **Return format:**

Query returns the frame of recording waveform, it is integer data.

➤ **For example:**

:RECORD:FRAMES 400

Set the frame number of recording waveform to 400.

:RECORD:FRAMES?

Query returns 400.

DVM Command

This command is used to set the function of digital voltage meter.

:DVM:ENABLE

➤ **Command format:**

:DVM:ENABLE { {1|ON} | {0|OFF} }

:DVM:ENABLE?

➤ **Functional description:**

This command is used to set or query the function (ON or OFF) of digital voltage meter.

➤ **Return format:**

Query returns 1 or 0, it respectively represents ON or OFF.

➤ **For example:**

:DVM:ENABLE ON

Open the digital voltage meter.

:DVM:ENABLE?

Query returns 1.

:DVM:SOURCE

➤ **Command format:**

:DVM:SOURCE <source>

:DVM:SOURCE?

➤ **Functional description:**

This command is used to set or query the source of digital voltage meter.

<source>: CHANnel<n>, n takes value as 1 or 2.

➤ **Return format:**

Query returns { CHANnel1 | CHANnel2 }.

➤ **For example:**

:DVM:SOURCE CHANnel1

Set the source to CH1.

:DVM:SOURCE?

Query returns CHANnel1.

:DVM:MODE

➤ **Command format:**

:DVM:MODE {ACRMs|DC|DCRMs}

:DVM:MODE?

➤ **Functional description:**

This command is used to set or query the mode of digital voltage meter.

➤ **Return format:**

Query returns {ACRMs|DC|DCRMs}.

➤ **For example:**

:DVM:MODE DC

Set the mode of digital voltage meter to DC.

:DVM:MODE?

Query returns DC.

:DVM:CURRent?**➤ Command format:**

: DVM:CURRent?

➤ Functional description:

This command is used to query the current voltage value of digital voltage meter.

➤ Return format:

Query returns the currently tested voltage value with the standard unit of digital voltage meter in scientific notation. The unit is decided by [:DVM:MODE](#).

➤ For example:

:DVM:CURRent?

The currently tested voltage value is 3.000e-003.

PF Command

This command is used to set Pass/Fail test function.

:PF:ENABle

➤ **Command format:**

:PF:ENABle { {1|ON} | {0|OFF} }

:PF:ENABle?

➤ **Functional description:**

This command is used to set or query Pass/Fail test function (ON or OFF).

➤ **Return format:**

Query returns 1 or 0, it respectively represents ON or OFF.

➤ **For example:**

:PF:ENABle ON

Turn on Pass/Fail test function.

:PF:ENABle?

Query returns 1.

:PF:SOURCe

➤ **Command format:**

:PF:SOURCe <source>

:PF:SOURCe?

➤ **Functional description:**

This command is used to set or query the measuring source of Pass/Fail test.

<source>: CHANnel<n>, n takes value as 1, 2, 3 or 4.

➤ **Return format:**

Query returns {CHANnel1 | CHANnel2 | CHANnel3 | CHANnel4}.

➤ **For example:**

:PF:SOURCe CHANnel1

Set the measuring source as channel 1.

:PF:SOURCe?

Query returns CHANnel1.

:PF:OPERate

➤ **Command format:**

:PF:OPERate {RUN|STOP}

:PF:OPERate?

➤ **Functional description:**

This command is used to run or stop Pass/Fail test.

➤ **Return format:**

Query returns {RUN|STOP}.

➤ **For example:**

:PF:OPERate RUN

Run Pass/Fail test.

:PF:OPERate?

Query returns RUN.

:PF:OUTPut

- **Command format:**
:PF:OUTPut {PASS|FAILED}
:PF:OUTPut?
- **Functional description:**
This command is used to set or query the output of Pass/Fail test.
- **Return format:**
Query returns {PASS|FAILED}.
- **For example:**
:PF:OUTPut PASS Set the output of Pass/Fail test to PASS.
:PF:OUTPut? Query returns PASS.

:PF:STOP:TYPe

- **Command format:**
:PF:STOP:TYPe {PCOUNT|FCOUNT}
:PF:STOP:TYPe?
- **Functional description:**
This command is used to set or query stop type of Pass/Fail test.
PCOUNT represents the number of pass; FCOUNT represents the number of fail
- **Return format:**
Query returns {PCOUNT|FCOUNT}.
- **For example:**
:PF:STOP:TYPe PCOUNT Set stop type of Pass/Fail test to PCOUNT.
:PF:STOP:TYPe? Query returns PCOUNT.

:PF:STOP:QUALifier

- **Command format:**
:PF:STOP:QUALifier {LEQual | GEQual}
:PF:STOP:QUALifier?
- **Functional description:**
This command is used to set or query the stop condition of Pass/Fail test.
GEQual represents greater than or equal to; LEQual represents less than or equal to.
- **Return format:**
Query returns {LEQual | GEQual}.
- **For example:**
:PF:STOP:QUALifier GEQual Set the stop condition of Pass/Fail test to ≥.
:PF:STOP:QUALifier? Query returns GEQual.

:PF:STOP:THReshold

- **Command format:**
:PF:STOP:THReshold <value>
:PF:STOP:THReshold?

➤ **Functional description:**

This command is used to set or query the stop threshold of Pass/fail test.

<value>: stop threshold, range is 1~30000, the specified range will self-adapting according to the oscilloscope.

➤ **Return format:**

Query returns stop threshold, it is integer data.

➤ **For example:**

:PF:STOP:THReshold 100 Set the stop threshold of Pass/fail test to 100.

:PF:STOP:THReshold? Query returns 100.

:PF:TEMPlate:SOURce

➤ **Command format:**

:PF:TEMPlate:SOURce {CHANnel1|CHANnel2|CHANnel3|CHANnel4|REF|USB}

:PF:TEMPlate:SOURce?

➤ **Functional description:**

This command is used to set or query the template source of Pass/fail test.

Physical channel {CHANnel1|CHANnel2|CHANnel3|CHANnel4} can be template source.

If template source set to REF, it can use instruction :PF:TEMPlate:LOAD to load waveform file from REF as the template source.

If template source set to USB, it can use instruction :PF:TEMPlate:LOAD to load waveform file from U flash dish as the template source.

➤ **Return format:**

Query returns {CHANnel1|CHANnel2|CHANnel3|CHANnel4|REF|USB}.

➤ **For example:**

:PF:TEMPlate:SOURce CHANnel1 Set template source as channel 1

:PF:TEMPlate:SOURce? Query returns CHANnel1

:PF:TEMPlate:LOAD

➤ **Command format:**

:PF:TEMPlate:LOAD <filename>

➤ **Functional description:**

This command is used to load the specified waveform file as the template source when the template source is REF or USB.

➤ **For example:**

PF:TEMPlate:LOAD "test.dat" Load test.dat waveform file as the template source

:PF:TEMPlate:X

➤ **Command format:**

:PF:TEMPlate:X <value>

:PF:TEMPlate:X?

➤ **Functional description:**

This command is used to set or query the horizontal tolerance of template setting of Pass/fail test.

<value>: horizontal tolerance, range is 1~100, the specified range will self-adapting according to the

oscilloscope.

➤ **Return format:**

Query returns horizontal tolerance of template setting, it is integer data.

➤ **For example:**

:PF:TEMPLate:X 50

Set horizontal tolerance of template setting to 50.

:PF:TEMPLate:X?

Query returns 50.

:PF:TEMPLate:Y

➤ **Command format:**

:PF:TEMPLate:Y <value>

:PF:TEMPLate:Y?

➤ **Functional description:**

This command is used to set or query the vertical tolerance of template setting of Pass/fail test.

<value>: vertical tolerance, range is 1~100, the specified range will self-adapting according to the oscilloscope.

➤ **Return format:**

Query returns vertical tolerance of template setting, it is integer data.

➤ **For example:**

:PF:TEMPLate:Y 50

Set vertical tolerance of template setting to 50.

:PF:TEMPLate:Y?

Query returns 50.

:PF:RESult?

➤ **Command format:**

:PF:RESult?

➤ **Functional description:**

This command is used to query the statistical result of Pass/Fail test.

Return data format: <pass>, <failed>, <total>, <pass> represents the number of pass; <failed> represents the number of fail; <total> present the total number.

➤ **Return format:**

Query returns the statistical result of Pass/Fail test.

➤ **For example:**

:PF:RESult?

Query returns 35,42,77.

ACQUIRE Command

This command is used to set the sampling mode of the oscilloscope.

:ACQUIRE:TYPE

➤ **Command format:**

:ACQUIRE:TYPE {NORMAL | AVERAGE | PEAKdetect | ENVELOPE | HRESOLUTION }

:ACQUIRE:TYPE?

➤ **Functional description:**

This command is used to set sampling mode of the oscilloscope, which is NORMAl, AVERAge, PEAKdetect, ENVeloPe and HRESolution.

➤ **Return format:**

Query returns {NORMAl | AVERAge | PEAKdetect | ENVeloPe | HRESolution }.

➤ **For example:**

:ACQ:TYPE AVER	Set sampling mode to AVERAge.
:ACQ:TYPE?	Query returns AVERAge.

:ACQuire:AVERages:COUNT

➤ **Command format:**

:ACQuire:AVERages:COUNT <count>
:ACQuire:AVERages:COUNT?

➤ **Functional description:**

This command is used to set the number of average sampling mode, <count> stepped as Nth power of 2, and takes value form 2~8192, 1≤N≤30.

➤ **Return format:**

Query returns the current number of average sampling mode.

➤ **For example:**

:ACQ:AVER:COUN 32	Set the number of average sampling mode to 32.
:ACQ:AVER:COUN?	Query returns 32.

:ACQuire:MEMory:DEPTH

➤ **Command format:**

:ACQuire:MEMory:DEPTH { AUTO | 700 | 7K | 70K | 700K | 7M | 14M | 28M | 56M }
:ACQuire:MEMory:DEPTH?

➤ **Functional description:**

This command is used to set storage depth of sampling mode, it will self-adapting according to the storage depth of different mode.

➤ **Return format:**

Query returns { AUTO | 700 | 7K | 70K | 700K | 7M | 14M | 28M | 56M }.

➤ **For example:**

:ACQ:MEM:DEPT AUTO	Set storage depth to AUTO.
:ACQ:MEM:DEPT?	Query returns AUTO.

DISPlay Command

This command is used to set or query the diplay function or data of the oscilloscope.

:DISPlay:DATA?

➤ **Command format:**

:DISPlay:DATA?

➤ **Functional description:**

This command is used to query the current image data of the oscilloscope.

➤ **Return format:**

Query returns BMP format image data, returned data is conform with [Appendix 2: IEEE 488.2 binary data format](#).

➤ **For example:**

:DISPlay:DATA?

Query returns image data.

:DISPlay:FORMat

➤ **Command format:**

:DISPlay:FORMat { VECTors | DOTs }

:DISPlay:FORMat?

➤ **Functional description:**

This command is used to set display format of sampling point, which is VECTors (vector display), DOTs (direct display).

➤ **Return format:**

Query returns { VECTors | DOTs }.

➤ **For example:**

:DISPlay:FORMat VECT

Set display format of sampling point to VECTors.

:DISPlay:FORMat

Query returns VECTors.

:DISPlay:GRID

➤ **Command format:**

:DISPlay:GRID { FULL | HALFCROSS | NONE }

:DISPlay:GRID?

➤ **Functional description:**

This command is used to set the gridding display mode on the screen.

➤ **Return format:**

Query returns { FULL | HALFCROSS | NONE }.

➤ **For example:**

:DISPlay:GRID CROSS

Set to display cross coordinate line and not display scale division.

:DISPlay:GRID?

Query returns CROSS.

:DISPlay:GRID:BRIGhtness

➤ **Command format:**

:DISPlay:GRID:BRIGhtness <count>

:DISPlay:GRID:BRIGhtness?

➤ **Functional description:**

This command is used to set the gridding brightness, <count> takes value from 1~100, the larger the number, the brighter the grid.

➤ **Return format:**

Query returns the current gridding brightness.

➤ **For example:**

:DISPlay:GRID:BRIGhtness 50

Set the gridding brightness to 50.

:DISPlay:GRID:BRIGhtness? Query returns 50.

:DISPlay:GRAD:TIME

➤ **Command format:**

:DISPlay:GRAD:TIME {MINimum|50ms|100ms|200ms|500ms|1s|2s|5s|10s|20s|INFinite}
:DISPlay:GRAD:TIME?

➤ **Functional description:**

This command is used to set the persistence time.

➤ **Return format:**

Query returns {MINimum|50ms|100ms|200ms|500ms|1s|2s|5s|10s|20s|INFinite}.

➤ **For example:**

:DISPlay:GRAD:TIME 50ms Set the persistence time to 50ms.
:DISPlay:GRAD:TIME? Query returns 50ms.

:DISPlay:COLOR

➤ **Command format:**

:DISPlay:COLOR { {1|ON} | {0|OFF} }
:DISPlay:COLOR?

➤ **Functional description:**

This command is used to turn on/off color temperature display.

➤ **Return format:**

Query returns 1 or 0, it respectively represents ON or OFF.

➤ **For example:**

:DISPlay:COLOR ON Turn on color display.
:DISPlay:COLOR? Query returns 1, it represents color display is turned on.

:DISPlay:COLOR:INVERT

➤ **Command format:**

:DISPlay:COLOR:INVERT { {1|ON} | {0|OFF} }
:DISPlay:COLOR:INVERT?

➤ **Functional description:**

This command is used to turn on/off inverse color.

➤ **Return format:**

Query returns 1 or 0, it represents ON or OFF separately.

➤ **For example:**

:DISPlay:COLOR:INVERT ON Turn on inverse color.
:DISPlay:COLOR:INVERT? Query returns 1, it represents inverse color display is turned on.

:DISPlay:WAVE:BRIGhtness

➤ **Command format:**

:DISPlay:WAVE:BRIGhtness <count>
:DISPlay:WAVE:BRIGhtness?

➤ **Functional description:**

This command is used to set waveform brightness, <count> takes value from 1~100, larger the number, the brighter the waveform.

➤ **Return format:**

Query returns the current waveform brightness.

➤ **For example:**

:DISPlay:WAVE:BRIGHtness 50	Set waveform brightness to 50.
:DISPlay:WAVE:BRIGHtness?	Query returns 50.

:DISPlay:CLEar

➤ **Command format:**

:DISPlay:CLEar

➤ **Functional description:**

This command is used to clear and refresh the waveform on the screen. If there is reference waveform, then clear and refresh the reference waveform.

:DISPlay:TYPE

➤ **Command format:**

:DISPlay:TYPE {XY12|XY13|XY14| XY23|XY24|XY34|YT}

:DISPlay:TYPE?

➤ **Functional description:**

This command is used to set timebase display type to XY12 (X-Y mode: amplitude value of channel 1 display on the horizontal axis, amplitude value of channel 2 display on the vertical axis; type XY13|XY14| XY23|XY24|XY34 as above); YT (YT mode: display the relative relation of vertical voltage and horizontal time).

➤ **Return format:**

Query returns {XY12|XY13|XY14| XY23|XY24|XY34|YT}.

➤ **For example:**

:DISP:TYPE YT	Set timebase format to YT mode.
:DISP:TYPE?	Query returns YT.

WAVeform Command

This command is used to read the waveform data and relative parameter on the screen of the oscilloscope.

:WAVeform:MODE

➤ **Command format:**

:WAVeform:MODE {NORMal|RAW}

:WAVeform:MODE?

➤ **Functional description:**

NORMal: Read the current waveform data, the count of waveform data is fixed count.

RAW: Read the waveform data from internal storage, the count of waveform data is related to storage depth.

Note: This instruction resets the start, cut-off and waveform point. Data in internal storage can be read

only the oscilloscope in stop status. This instruction is invalid in MATH channel.

➤ **Return format:**

Query returns {NORMal | RAW}.

➤ **For example:**

:WAVeform:MODE RAW

Set the read mode of waveform data to RAW.

:WAVeform:MODE?

Query returns RAW.

:WAVeform:FORMat

➤ **Command format:**

:WAVeform:FORMat { WORD | BYTE | ASCII }

:WAVeform:FORMat?

➤ **Functional description:**

The default waveform data format is AD waveform point data

BYTE: Return AD data, a waveform data takes a byte (that is 8 bits) .

WORD: Return AD data, a waveform data takes two bytes (that is 16 bits) , low 8 bits is valid, high 8 bits is 0.

ASCII: Return waveform returns the actual voltage value of each waveform point in scientific notation, and each voltage value is separated by commas. It is conform with [Appendix 2: IEEE 488.2 binary data format](#).

For example #412342.00000E+01,2.20000E+01, 2.30000E+01.....\n.

➤ **Return format:**

Query returns { WORD | BYTE | ASCII }.

➤ **For example:**

:WAVeform:FORMat BYTE

Return format of waveform AD data is single byte mode.

:WAVeform:FORMat?

Query returns BYT.

:WAVeform:STARt

➤ **Command format:**

:WAVeform:STARt <start>

:WAVeform:STARt?

➤ **Functional description:**

This command is used to set or query the start position of waveform data reading, <start> integer data type.

NORMal: 1~1400.

RAW: 1 to the maximum storage depth point.

➤ **Return format:**

Query returns the start position.

➤ **For example:**

:WAVeform:STARt 200

Set the start position of waveform data reading to 200.

:WAVeform:STARt?

Query returns 200.

:WAVeform:STOP

➤ **Command format:**

:WAVeform:STOP <stop>

:WAVeform:STOP?

➤ **Functional description:**

This command is used to set or query the cut-off position of waveform data reading, < stop> is integer data type.

NORMAL: < stop> range is 1~1400.

RAW: < stop> range is 1 to the maximum storage depth point.

➤ **Return format:**

Query returns the cut-off position.

➤ **For example:**

:WAVEform:STOP 400 Set the end point of waveform data reading to 400.

:WAVEform:STOP? Query returns 400.

:WAVEform:SOURce

➤ **Command format:**

:WAVEform:SOURce {CHANnel<n>|MATH [<Dx>]}

:WAVEform:SOURce?

➤ **Functional description:**

This command is used to set the signal source of the currently queried waveform data. If the command does not send, it indicates that query the waveform data of the current channel.

<Dx>: {D0|D1|D2|D3|D4|D5|D6|D7|D8|D9|D10|D11|D12|D13|D14|D15}.

If channel source sets to MATH, it can only read the waveform data in the screen.

If channel source sets to digital, query command [:WAVEform:DATA?](#) returns waveform data with the fixed BYTE format. If read the waveform data in the screen, then return the signal status of the current selected channel, a waveform takes two bytes (16 bits). If read the waveform data from memory, then return the signal status of the current channel source in the channel group, two bytes (16 bits) represents the status of a group of digital channel signal.

➤ **Return format:**

Query returns { CHANnel1 | CHANnel2 | CHANnel3 | CHANnel4 | MATH [<Dx>}.

➤ **For example:**

:WAVEform:SOURce CHAN1

Set the signal source of waveform data to be queried as CH1.

:WAVEform:SOURce? Query returns CHANnel1.

:WAVEform:POINts

➤ **Command format:**

:WAVEform:POINts <points>

:WAVEform:POINts?

➤ **Functional description:**

This command is used to set the waveform point which need to returned, the default value is 0.

➤ **Return format:**

Query returns the waveform point need to be returned.

➤ **For example:**

:WAVEform:POINts 120 Set returned waveform point to 120.

:WAVEform:POINts? Query returns 120.

:WAVeform:DATA?**➤ Command format:**

:WAVeform:DATA?

➤ Functional description:

This command is used to read the waveform data from the specified data source.

➤ Return format:

WAVeform:POINts the specified quantity of waveform data. Waveform data source is related to: WAVeform:SOURce. Data format is related to WAVeform:FORMat. Returned format is conform with _ _ .

Notes: If channel source sets to digital channel, query returns the waveform data with the fixed WORD format. If read the waveform data in the screen, then return the signal status of the current selected channel, a waveform takes two bytes (16 bits). If read the waveform data from memory, then return the signal status of the current channel source in the channel group, two bytes (16 bits) represents the status of a group of digital channel signal.

➤ For example:

The instructions to obtain the waveform data for the specified data source are executed in the following order.

◆ Obtain screen waveform data flow

:WAVeform:SOURce CHAN1

Set singal source of query waveform data to be queried to channel 1.

:WAVeform:MODE NORMal

Set to read waveform data display on the screen.

:WAVeform:FORMat BYTE

Return format of waveform data is AD single byte mode.

:WAVeform:DATA?

Acquire waveform data.

◆ Obtain internal waveform data flow, this flow can only valid in stop status.

:WAVeform:SOURce CHAN1

Set singal source of query waveform data to be queried to channel 1.

:WAVeform:MODE RAW

Set to read interal storage waveform data.

:WAVeform:FORMat BYTE

Return format of waveform data is AD single byte mode.

:WAVeform:POINts 5000

Reading internal waveform point is 5000.

Cycle reading internal waveform data.

{

:WAVeform:DATA?

Acquire a piece of waveform data in internal storage.

:WAVeform:START?

Start position of waveform data reading, -1 represents the last point.

}

Explanation: when reading internal data in batch, the read back data of each time is only the data of an area

in the memory, and the waveform data between two adjacent pieces is continuous. Each piece of data conforms to [Appendix 2: IEEE 488.2 binary data format](#).

:WAVeform:PREamble?

➤ **Command format:**

:WAVeform:PREamble?

➤ **Functional description:**

Query returns the waveform configuration parameter of the current system.

➤ **Return format:**

Query returns separated by comma“,“.

Return data format: Format, Type, Points, Count, Xinc, Xor, Xref, Yinc, Yor, Yref.

Format: BYTE (0), WORD (1), ASCII (2).

Type: NORMAL (0), PEAK (1), AVER (2), ENVELOPE (3), HRESOLUTION (4).

Points: Waveform data point need to be returned.

Count: As average time in average sampling, as 1 in other mode.

Xinc: The time difference between in two point of waveform data source in X direction.

Xor: The relative time of trigger point.

Xref: X reference.

Yinc: Unit of voltage in Y direction.

Yor: Y direction relative to Zero position of YREF.

Yref: Reference value in Y direction, channel zero level ADC value.

➤ **For example:**

:WAVeform:PREamble?

Return 1,0,0,1,8.000e-009,-6.000e-006,0,4.000e-002,0.000e000,100

:WAVeform:XINCrement?

➤ **Command format:**

:WAVeform:XINCrement?

➤ **Functional description:**

This command is used to query time interval between two adjacent points of the currently selected channel source in X direction.

Returned value is related to the current data reading mode.

In NORMal mode, XINCrement=TimeScale/waveform point of time scale in horizontal position (50).

In RAW mode, XINCrement=1/SampleRate

➤ **Return format:**

Query returns number of timebase, unit is s.

➤ **For example:**

:WAV:XINC?

Query returns 3.000e-003.

:WAVeform:XORigin?

➤ **Command format:**

displacement of the vertical reference position.

Returned value is related to the current data reading mode, up is positive and down is negative with the reference as the base:

YORigin = VerticalOffset/YINCrement

➤ **Return format:**

Query returns the vertical displacement, it is integer type.

➤ **For example:**

:WAV:YOR? Query returns 0.

:WAVeform:YREFerence?

➤ **Command format:**

:WAVeform:YREFerence?

➤ **Functional description:**

This command is used to query the vertical reference position of the current selected channel source in Y direction, and ADC value of channel zero level.

Returned value is related to the current data reading mode: YREFerence fixed as 128

➤ **Return format:**

Query returns the reference position, it is integer type.

➤ **For example:**

:WAV:YREF? Query returns 128.

SBUS Command

This command is used to set RS232, SPI, I2C, CAN, CANFD, USB, LIN and FlexRay bus decoding and trigger parameter.

Basic Attribute

:SBUS:DISPlay

➤ **Command format:**

:SBUS:DISPlay { {1|ON} | {0|OFF} }

:SBUS:DISPlay?

➤ **Functional description:**

This command is used to turn on/off bus decoding status of the oscilloscope.

➤ **Return format:**

Query returns 1 or 0, it repectively represents ON or OFF.

➤ **For example:**

:SBUS:DISPlay ON Turn on bus decoding status to display decoding waveform.

:SBUS:DISPlay? Query returns 1

:SBUS:MODE➤ **Command format:**

```
:SBUS:MODE {RS232|I2C|SPI|CAN|CANFD|LIN|FR}
```

```
:SBUS:MODE?
```

➤ **Functional description:**

This command is used to select bus decoding and trigger mode. FR represents FlexRay bus.

➤ **Return format:**

Query returns {RS232|I2C|SPI|CAN|CANFD|LIN|FR}.

➤ **For example:**

```
:SBUS:MODE I2C
```

Select I2C bus decoding mode.

```
:SBUS:MODE?
```

Query returns I2C.

:SBUS:BASE➤ **Command format:**

```
:SBUS:BASE {ASCII|BINary|HEX|DEC}
```

```
:SBUS:BASE?
```

➤ **Functional description:**

This command is used to set bus display format of the oscilloscope.

➤ **Return format:**

Query returns {ASCII|BINary|HEX|DEC}.

➤ **For example:**

```
:SBUS:BASE BIN
```

Set bus decoding to binary display format.

```
:SBUS:BASE?
```

Query returns BINary.

:SBUS:EVENT➤ **Command format:**

```
:SBUS:EVENT {1|ON}|{0|OFF}
```

```
:SBUS:EVENT?
```

➤ **Functional description:**

This command is used to turn on/off bus event of the oscilloscope.

➤ **Return format:**

Query returns 1 or 0, it respectively represents ON or OFF.

➤ **For example:**

```
:SBUS:EVENT ON
```

Turn on bus event.

```
:SBUS:EVENT?
```

Query returns 1.

:SBUS:DATA?➤ **Command format:**

```
:SBUS:DATA?
```

➤ **Functional description:**

This command is used read the data of decoding event table of the oscilloscope.

➤ **Return format:**

Query returns the data of decoding event table, returned data is conform with [Appendix 2: IEEE 488.2 binary data format](#).

➤ **For example:**

:SBUS:DATA? Query returns:

#9000000089RS232,

TIME,DATA,CHECK,

-1us,0,0,

-890.5ns,1,0,

-403.4ns,0,0,

9.8ns,1,0,

531.7ns,0,0,

RS232 represents decoding type (it may be I2C, SPI or CAN), the event table data in CSV format followed behind. The specified format of the event table data is automatically adapted by different devices. The data are separated by commas and will automatically line wrap according to the decoding list, the data value is related to the setting system display.

:SBUS:VERTical:POSition

➤ **Command format:**

:SBUS:VERTical:POSition <value>

:SBUS:VERTical:POSition?

➤ **Functional description:**

This command is used to set trigger vertical position value of the oscilloscope. Parameter is integer, step is 6, range is [-160,160]. The center of screen is zero point, up is positive, down is negative.

➤ **Return format:**

Query returns vertical positon value.

➤ **For example:**

:SBUS:VERTical:POSition 10

Open bus vertical position value is 10.

:SBUS:VERTical:POSition?

Query returns 10.

:SBUS:TRIGger:SWEep

➤ **Command format:**

:SBUS:TRIGger:SWEep {AUTO|NORMal|SINGle}

:SBUS:TRIGger:SWEep?

➤ **Functional description:**

This command is used to select bus trigger sweep mode.

AUTO: In no trigger condition, the internal will produce trigger signal to force trigger.

NORMal: It will be generated only trigger condition is met.

SINGle: It will be generated one time and stop when trigger condition is met.

➤ **Return format:**

Query returns trigger sweep mode {AUTO|NORMal}.

➤ **For example:**

:SBUS:TRIGger:SWEep AUTO

Set bus trigger sweep mode to AUTO.

:SBUS:TRIGger:SWEep?

Query returns AUTO.

RS232

:SBUS:RS232:BAUDrate

➤ **Command format:**

:SBUS:RS232:BAUDrate <baudrate>

:SBUS:RS232:BAUDrate?

➤ **Functional description:**

This command is used to set RS232 decoding baud rate of the oscilloscope. Parameter is integer, range is 120~5000000.

➤ **Return format:**

Query returns baud rate.

➤ **For example:**

:SBUS:RS232:BAUDrate 500

Set RS232 baud rate to 500b/s.

:SBUS:RS232:BAUDrate?

Query returns 500.

:SBUS:RS232:BITorder

➤ **Command format:**

:SBUS:RS232:BITorder {LSBFirst|MSBFirst}

:SBUS:RS232:BITorder?

➤ **Functional description:**

This command is used to set RS232 bus decoding bit order of the oscilloscope, which includes LSBFirst and MSBFirst.

➤ **Return format:**

Query returns {LSBFirst|MSBFirst}.

➤ **For example:**

:SBUS:RS232:BITorder LSBF

Set RS232 bit order to LSB.

:SBUS:RS232:BITorder?

Query returns LSBFirst.

:SBUS:RS232:SOURce

➤ **Command format:**

:SBUS:RS232:SOURce {CHANnel1|CHANnel2|CHANnel3|CHANnel4|<Dx>}

:SBUS:RS232:SOURce?

➤ **Functional description:**

This command is used to set RS232 bus decoding source.

<Dx>: It presents the oscilloscope has LA function and it can set D0-D15 channel as the bus decoding source.

➤ **Return format:**

Query returns {CHANnel1|CHANnel2|CHANnel3|CHANnel4|<Dx>}

➤ **For example:**

:SBUS:RS232:SOURce CHANnel1 Set channel 1 as RS232 bus decoding source.
:SBUS:RS232:SOURce? Query returns CHANnel1.

:SBUS:RS232:POLarity

➤ **Command format:**

:SBUS:RS232:POLarity { POSitive | NEGative }
:SBUS:RS232:POLarity?

➤ **Functional description:**

This command is used to set RS232 bus decoding polarity of the oscilloscope, which includes POSitive and NEGative.

➤ **Return format:**

Query returns { POSitive | NEGative }.

➤ **For example:**

:SBUS:RS232:POLarity POSitive Set RS232 bus decoding polarity to POSitive.
:SBUS:RS232:POLarity? Query returns POSitive.

:SBUS:RS232:PARity

➤ **Command format:**

:SBUS:RS232:PARity {EVEN|ODD|NONE}
:SBUS:RS232:PARity?

➤ **Functional description:**

This command is used to set RS232 bus parity of the oscilloscope.

➤ **Return format:**

Query returns {EVEN|ODD|NONE}.

➤ **For example:**

:SBUS:RS232:PARity ODD Set RS232 bus parity to ODD.
:SBUS:RS232:PARity? Query returns 6.

:SBUS:RS232:DATA:BIT

➤ **Command format:**

:SBUS:RS232:DATA:BIT {5|6|7|8}
:SBUS:RS232:DATA:BIT?

➤ **Functional description:**

This command is used to set RS232 bus data bit of the oscilloscope.

➤ **Return format:**

Query returns {5|6|7|8}.

➤ **For example:**

:SBUS:RS232:DATA:BIT 6	Set RS232 data bit to 6.
:SBUS:RS232:DATA:BIT?	Query returns 6

:SBUS:RS232:STOP:BIT

➤ **Command format:**

:SBUS:RS232:STOP:BIT {1|2}
:SBUS:RS232:STOP:BIT?

➤ **Functional description:**

This command is used to set RS232 bus stop bit of the oscilloscope.

➤ **Return format:**

Query returns {1|2}.

➤ **For example:**

:SBUS:RS232:STOP:BIT 6	Set RS232 stop bit to 6.
:SBUS:RS232:STOP:BIT?	Query returns 6.

:SBUS:RS232:DATA

➤ **Command format:**

:SBUS:RS232:DATA <value>
:SBUS:RS232:DATA?

➤ **Functional description:**

This command is used to set RS232 bus trigger data of the oscilloscope. Binary character data presented by parameter 0 or 1, its range is related to the value set by instruction :SBUS:RS232:DATA:BIT, which is $[0 \sim 2^{\text{databit}} - 1]$.

➤ **Return format:**

Query returns binary data format.

➤ **For example:**

:SBUS:RS232:DATA "01111111"	Set Set RS232 bus data to 0x7F.
:SBUS:RS232:DATA?	Query returns 01111111.

:SBUS:RS232:QUALifier

➤ **Command format:**

:SBUS:RS232:QUALifier {BEGFrame|ERRFrame|ECCErrror|DATA}
:SBUS:RS232:QUALifier?

➤ **Functional description:**

This command is used to set RS232 bus trigger condition of the oscilloscope.

➤ **Return format:**

Query returns {BEGFrame|ERRFrame|ECCErrror|DATA}.

➤ **For example:**

:SBUS:RS232:QUALifier ERRF	Set RS232 bus condition to ERRFrame.
:SBUS:RS232:QUALifier?	Query returns ERRFrame.

I2C

:SBUS:I2C:CLOCK:SOURce

➤ **Command format:**

```
:SBUS:I2C:CLOCK:SOURce {CHANnel1|CHANnel2|CHANnel3|CHANnel4|<Dx>}
:SBUS:I2C:CLOCK:SOURce?
```

➤ **Functional description:**

This command is used to set I2C bus clock source of the oscilloscope.

<Dx>: It presents the oscilloscope has LA function and it can set D0-D15 channel as the bus decoding source.

➤ **Return format:**

Query returns {CHANnel1|CHANnel2|CHANnel3|CHANnel4|<Dx>}.

➤ **For example:**

:SBUS:I2C:CLOCK:SOURce CHANnel1	Set channel 1 as I2C bus clock source.
:SBUS:I2C:CLOCK:SOURce?	Query returns CHANnel1.

:SBUS:I2C:DATA:SOURce

➤ **Command format:**

```
:SBUS:I2C:DATA:SOURce {CHANnel1|CHANnel2|CHANnel3|CHANnel4|<Dx>}
:SBUS:I2C:DATA:SOURce?
```

➤ **Functional description:**

This command is used to set I2C bus data source of the oscilloscope.

<Dx>: It presents the oscilloscope has LA function and it can set D0-D15 channel as the bus decoding source.

➤ **Return format:**

Query returns {CHANnel1|CHANnel2|CHANnel3|CHANnel4|<Dx>}.

➤ **For example:**

:SBUS:I2C:DATA:SOURce CHANnel1	Set channel 1 as I2C bus clock source.
:SBUS:I2C:DATA:SOURce?	Query returns CHANnel1.

:SBUS:I2C:ASIZe

➤ **Command format:**

```
:SBUS:I2C:ASIZe {7|10}
:SBUS:I2C:ASIZe?
```

➤ **Functional description:**

This command is used to set I2C bus address bit wide of the oscilloscope.

➤ **Return format:**

Query returns {7|10}.

➤ **For example:**

:SBUS:I2C:ASIZe 7

Set I2C bus address bit wide to 7.

:SBUS:I2C:ASIZe?

Query returns 7.

:SBUS:I2C:ADIRectioN

➤ **Command format:**

:SBUS:I2C:ADIRectioN { READ | WRITE }

:SBUS:I2C:ADIRectioN?

➤ **Functional description:**

This command is used to set I2C bus address direction of the oscilloscope.

➤ **Return format:**

Query returns { READ | WRITE }.

➤ **For example:**

:SBUS:I2C:ADIRectioN READ

Set I2C bus address direction to READ.

:SBUS:I2C:ADIRectioN?

Query returns READ.

:SBUS:I2C:ADDRess

➤ **Command format:**

:SBUS:I2C:ADDRess <value>

:SBUS:I2C:ADDRess?

➤ **Functional description:**

This command is used to set I2C bus address of the oscilloscope. Binary character string data presented by parameter is 0 , 1 or X. X represents it is unsure. And its rang is related to the value set by instruction :SBUS:I2C:ASIZe, which is $[0 \sim 2^{\text{addressbit}} - 1]$.

➤ **Return format:**

Query returns binary character string address value.

➤ **For example:**

:SBUS:I2C:ADDRess "X00X00X1"

Set I2C bus address to X00X00X1.

:SBUS:I2C:ADDRess?

Query returns X00X00X1.

:SBUS:I2C:DATA:LEN

➤ **Command format:**

:SBUS:I2C:DATA:LEN <length>

:SBUS:I2C:DATA:LEN?

➤ **Functional description:**

This command is used to set I2C bus trigger data length of the oscilloscope. It can take value from 1~5.

➤ **Return format:**

Query returns I2C bus trigger data length of the oscilloscope, it is integer data.

➤ **For example:**

:SBUS:I2C:DATA:LEN 2 Set I2C bus trigger data length to 2 bytes.
 :SBUS:I2C:DATA:LEN? Query returns 2.

:SBUS:I2C:DATA

➤ **Command format:**

:SBUS:I2C:DATA <value>
 :SBUS:I2C:DATA?

➤ **Functional description:**

This command is used to set I2C bus data. Binary character string data presented by parameter is 0, 1 or X. X represents it is unsure. And its rang is related to the value set by instruction setting value *8bits :SBUS:I2C:DATA:LEN, the rang is 0x0~0xFFFFFFFFFFFFFFFF.

➤ **Return format:**

Query returns binary character string data.

➤ **For example:**

:SBUS:I2C:DATA "X00X00X1" Set I2C bus data to X00X00X1.
 :SBUS:I2C:DATA? Query returns X00X00X1.

:SBUS:I2C:QUALifier

➤ **Command format:**

:SBUS:I2C:QUALifier {START|REStart|STOP|LOSS|ADDRess|DATA|ADATA}
 :SBUS:I2C:QUALifier?

➤ **Functional description:**

This command is used to set I2C bus trigger condition of the oscilloscope.

➤ **Return format:**

Query returns {START|REStart|STOP|LOSS|ADDRess|DATA|ADATA}.

➤ **For example:**

:SBUS:I2C:QUALifier STOP Set I2C bus trigger to STOP.
 :SBUS:I2C:QUALifier? Query returns STOP.

SPI

:SBUS:SPI:CS:SOURce

➤ **Command format:**

:SBUS:SPI:CS:SOURce {CHANnel1|CHANnel2|CHANnel3|CHANnel4|<Dx>}
 :SBUS:SPI:CS:SOURce?

➤ **Functional description:**

This command is used to set SPI bus chip selection source of the oscilloscope.

<Dx>: It presents the oscilloscope has LA function and it can set D0-D15 channel as the bus decoding source.

➤ **Return format:**

Query returns {CHANnel1|CHANnel2|CHANnel3|CHANnel4|<Dx>}.

➤ **For example:**

:SBUS:SPI:CS:SOURce CHANnel1 Set channel 1 as SPI bus chip selection source.
:SBUS:SPI:CS:SOURce? Query returns CHANnel1.

:SBUS:SPI:CLOCK:SOURce

➤ **Command format:**

:SBUS:SPI:CLOCK:SOURce {CHANnel1|CHANnel2|CHANnel3|CHANnel4|<Dx>}
:SBUS:SPI:CLOCK:SOURce?

➤ **Functional description:**

This command is used to set SPI bus clock source of the oscilloscope.

<Dx>: It presents the oscilloscope has LA function and it can set D0–D15 channel as the bus decoding source.

➤ **Return format:**

Query returns {CHANnel1|CHANnel2|CHANnel3|CHANnel4|<Dx>}.

➤ **For example:**

:SBUS:SPI:CLOCK:SOURce CHANnel1 Set channel 1 as SPI bus clock source.
:SBUS:SPI:CLOCK:SOURce? Query returns CHANnel1.

:SBUS:SPI:MOSI:SOURce

➤ **Command format:**

:SBUS:SPI:MOSI:SOURce {CHANnel1|CHANnel2|CHANnel3|CHANnel4|<Dx>|OFF}
:SBUS:SPI:MOSI:SOURce?

➤ **Functional description:**

This command is used to set SPI bus master input slaver output source of the oscilloscope.

<Dx>: It presents the oscilloscope has LA function and it can set D0–D15 channel as the bus decoding source.

➤ **Return format:**

Query returns {CHANnel1|CHANnel2|CHANnel3|CHANnel4|<Dx>|OFF}.

➤ **For example:**

:SBUS:SPI:MOSI:SOURce CHANnel1
Set channel 1 as SPI bus master input slaver output source.
:SBUS:SPI:MOSI:SOURce? Query returns CHANnel1.

:SBUS:SPI:BITOrder

➤ **Command format:**

:SBUS:SPI:BITOrder {LSBFirst|MSBFirst}
:SBUS:SPI:BITOrder?

➤ **Functional description:**

This command is used to set SPI bus decoding byte order of the oscilloscope, which includes LSBFirst and MSBFirst.

➤ **Return format:**

Query returns {LSBFirst | MSBFirst}.

➤ **For example:**

:SBUS:SPI:BITOrder LSBF

Set SPI bus decoding byte order to LSB.

:SBUS:SPI:BITOrder?

Query returns LSBFirst.

:SBUS:SPI:CS:POLarity

➤ **Command format:**

:SBUS:SPI:CS:POLarity {NEGative | POSitive}

:SBUS:SPI:CS:POLarity?

➤ **Functional description:**

This command is used to set SPI bus chip selection polarity of the oscilloscope, which includes POSitive and NEGative.

➤ **Return format:**

Query returns {NEGative | POSitive}.

➤ **For example:**

:SBUS:SPI:CS:POLarity POSitive

Set SPI bus chip selection polarity to POSitive.

:SBUS:SPI:CS:POLarity?

Query returns POSitive.

:SBUS:SPI:CLOCK:POLarity

➤ **Command format:**

:SBUS:SPI:CLOCK:POLarity {NEGative | POSitive}

:SBUS:SPI:CLOCK:POLarity?

➤ **Functional description:**

This command is used to set SPI bus clock polarity of the oscilloscope, which includes POSitive and NEGative.

➤ **Return format:**

Query returns {NEGative | POSitive}.

➤ **For example:**

:SBUS:SPI:CLOCK:POLarity POSitive

Set SPI bus clock polarity to POSitive.

:SBUS:SPI:CLOCK:POLarity?

Query returns POSitive.

:SBUS:SPI:MOSI:POLarity

➤ **Command format:**

:SBUS:SPI:MOSI:POLarity {NEGative | POSitive}

:SBUS:SPI:MOSI:POLarity?

➤ **Functional description:**

This command is used to set the polarity of SPI bus master input slaver output source of the oscilloscope, which includes POSitive and NEGative.

➤ **Return format:**

Query returns {NEGative | POSitive}.

➤ **For example:**

:SBUS:SPI:MOSI:POLarity POSitive

Set the polarity of SPI bus master input slaver output source to POSitive.

:SBUS:SPI:MOSI:POLarity? Query returns POSitive.

:SBUS:SPI:WIDTH

➤ **Command format:**

:SBUS:SPI:WIDTH <width>

:SBUS:SPI:WIDTH?

➤ **Functional description:**

This command is used to set SPI bus data bit width of the oscilloscope.

<width> is integer data and the range is 4~32.

➤ **Return format:**

Query returns SPI bus data bit width.

➤ **For example:**

:SBUS:SPI:WIDTH 4 Set SPI bus data bit width to 4.

:SBUS:SPI:WIDTH? Query returns 4.

:SBUS:SPI:FRAMelen

➤ **Command format:**

:SBUS:SPI:FRAMelen <len>

:SBUS:SPI:FRAMelen?

➤ **Functional description:**

This command is used to set SPI bus data frame length of the oscilloscope.

<len> is integer data and the range is 1~32, data width*data frame length cannot exceed 128 bits data.

➤ **Return format:**

Query returns SPI bus data frame length, it is integer type.

➤ **For example:**

:SBUS:SPI:FRAMelen 1 Set SPI bus data frame length to 1.

:SBUS:SPI:FRAMelen? Query returns 1.

:SBUS:SPI:DATA

➤ **Command format:**

:SBUS:SPI:DATA <value>

:SBUS:SPI:DATA?

➤ **Functional description:**

This command is used to set SPI bus data of the oscilloscope. Binary character string data presented by parameter is 0, 1 or X. X represents unsure. Data bit is related to the product of the instruction setting

value of :SBUS:SPI:WIDTH and :SBUS:SPI:FRAMelen and its range is

0x0~0xFFFFFFFFFFFFFFFFFFFFFFFFFFFFFFFF.

➤ **Return format:**

Query returns binary character string data.

➤ **For example:**

:SBUS:SPI:DATA "X00X00X1" Set SPI bus data to X00X00X1.

:SBUS:SPI:DATA? Query returns X00X00X1.

:SBUS:SPI:QUALifier

➤ **Command format:**

:SBUS:SPI:QUALifier {CS|CSDATA|IDLE|IDLEDATA}

:SBUS:SPI:QUALifier?

➤ **Functional description:**

This command is used to set SPI bus condition of the oscilloscope.

➤ **Return format:**

Query returns {CS|CSDATA|IDLE|IDLEDATA}.

➤ **For example:**

:SBUS:SPI:QUALifier CS Set SPI bus condition to CS

:SBUS:SPI:QUALifier? Query returns CS

:SBUS:SPI:TRIGger:TIMEout

➤ **Command format:**

:SBUS:SPI:TRIGger:TIMEout <vlaue>

:SBUS:SPI:TRIGger:TIMEout?

➤ **Functional description:**

This command is used to set SPI bus trigger timeout of the oscilloscope, parameter is integer.

<vlaue> equal to $n * 4ns$ and value not exceed range [100ns,1s). n takes value from [25,25*10⁸].

➤ **Return format:**

Query returns trigger timeout value in scientific notation, unit is s.

➤ **For example:**

:SBUS:SPI:TRIGger:TIMEout 100ns Set SPI bus trigger timeout value to 100ns.

:SBUS:SPI:TRIGger:TIMEout? Query returns 1.000e-007.

CAN

This command is used to set CAN bus decoding and trigger.

:SBUS:CAN:SOURce

➤ **Command format:**

:SBUS:CAN:SOURce {CHANnel1|CHANnel2|CHANnel3|CHANnel4|<Dx>}

:SBUS:CAN:SOURce?

➤ **Functional description:**

This command used to set CAN bus input source of the oscilloscope.

<Dx>: It presents the oscilloscope has LA function and it can set D0-D15 channel as the bus decoding source.

➤ **Return format:**

Query returns {CHANnel1|CHANnel2|CHANnel3|CHANnel4|<Dx>}.

➤ **For example:**

:SBUS:CAN:SOURce CHANnel1 Set channel 1 as CAN bus input source.

:SBUS:CAN:SOURce? Query returns CHANnel1.

:SBUS:CAN:SIGNal:DEFinition

➤ **Command format:**

:SBUS:CAN:SIGNal:DEFinition { CANH | CANL }

:SBUS:CAN:SIGNal:DEFinition?

➤ **Functional description:**

This command used to set CAN bus signal type of the oscilloscope.

➤ **Return format:**

Query returns { CANH | CANL }.

➤ **For example:**

:SBUS:CAN:SIGNal:DEFinition CANH Set channel 1 CAN bus signal to CANH.

:SBUS:CAN:SIGNal:DEFinition? Query returns CANH.

:SBUS:CAN:SIGNal:BAUDrate

➤ **Command format:**

:SBUS:CAN:SIGNal:BAUDrate <baudrate>

:SBUS:CAN:SIGNal:BAUDrate?

➤ **Functional description:**

This command used to set baud rate of CAN bus signal of the oscilloscope, <baudrate> range is 10000~1000000, unit is bps.

➤ **Return format:**

Query returns baud rate of signal.

➤ **For example:**

:SBUS:CAN:SIGNal:BAUDrate 100000

Set the baud rate of CAN bus signal to 100kbps.

:SBUS:CAN:SIGNal:BAUDrate? Query returns 100000.

:SBUS:CAN:QUALifier

➤ **Command format:**

:SBUS:CAN:QUALifier {START|ID|DATA|ACKError|BITFILL|IDDATA|END}

:SBUS:CAN:QUALifier?

➤ **Functional description:**

This command is used to set CAN bus trigger condition of the oscilloscope.

{START|ID|DATA|ACKError|BITFILL|IDDATA|END}, it respectively represents start, identifier, data frame, lost confirming, bit stuffing, identifier & data and end.

➤ **Return format:**

Query returns {START | ID | DATA | ACKError | BITFILL | IDDATA | END}.

➤ **For example:**

:SBUS:CAN:QUALifier ACK Set CAN bus trigger condition to ACKError.
:SBUS:CAN:QUALifier? Query returns ACKError.

:SBUS:CAN:FRAME:TYPE

➤ **Command format:**

:SBUS:CAN:FRAME:TYPE { DATA | REMote | OVERload | ERRor }
:SBUS:CAN:FRAME:TYPE?

➤ **Functional description:**

This command is used to set CAN bus trigger frame type of the oscilloscope.

➤ **Return format:**

Query returns { DATA | REMote | OVERload | ERRor }.

➤ **For example:**

:SBUS:CAN:FRAME:TYPE ERRor Set CAN bus trigger frame type to ERRor.
:SBUS:CAN:FRAME:TYPE? Query returns ERRor.

:SBUS:CAN:ID:MODE

➤ **Command format:**

:SBUS:CAN:ID:MODE {STANdard | EXTended}
:SBUS:CAN:ID:MODE?

➤ **Functional description:**

This command is used to set ID identifier frame format of CAN bus of the oscilloscope.

➤ **Return format:**

Query returns {STANdard | EXTended}.

➤ **For example:**

:SBUS:CAN:ID:MODE STANdard
Set ID identifier frame format of CAN bus to STANdard.
:SBUS:CAN:ID:MODE? Query returns STANdard.

:SBUS:CAN:ID

➤ **Command format:**

:SBUS:CAN:ID <string>
:SBUS:CAN:ID?

➤ **Functional description:**

This command is used to set ID identifier frame data of CAN bus of the oscilloscope. Set the corresponding

ID identifier according to the mode of `:SBUS:CAN:ID:MODE`. Binary character string data presented by parameter is 0, 1 or X. X represents unsure.

Standard frame range is 0x0~07FF, data bit occupies 11bits; Extend frame range is 0x0~0x1FFFFFFF, data bit occupies 29bits.

➤ **Return format:**

Query returns binary character data.

➤ **For example:**

`:SBUS:CAN:ID "X00X00X1"`

Set ID identifier frame data of CAN bus to X00X00X1.

`:SBUS:CAN:ID?` Query returns X00X00X1.

`:SBUS:CAN:ID:DIRection`

➤ **Command format:**

`:SBUS:CAN:ID:DIRection { READ | WRITE | ANY }`

`:SBUS:CAN:ID:DIRection?`

➤ **Functional description:**

This command is used to set ID identifier direction of CAN bus of the oscilloscope.

➤ **Return format:**

Query returns { READ | WRITE | ANY }.

➤ **For example:**

`:SBUS:CAN:ID:DIRection READ` Set ID identifier direction of CAN bus to READ.

`:SBUS:CAN:ID:DIRection?` Query returns READ.

`:SBUS:CAN:DATA:LEN`

➤ **Command format:**

`:SBUS:CAN:DATA:LEN <length>`

`:SBUS:CAN:DATA:LEN?`

➤ **Functional description:**

This command is used to set trigger data length of CAN bus of the oscilloscope. It can take value from 1~8.

➤ **Return format:**

Query returns trigger data length of CAN bus of the oscilloscope, it is integer data.

➤ **For example:**

`:SBUS:CAN:DATA:LEN 2` Set trigger data length of CAN bus to 2 bytes.

`:SBUS:CAN:DATA:LEN?` Query returns 2.

`:SBUS:CAN:DATA`

➤ **Command format:**

`:SBUS:CAN:DATA <string>`

`:SBUS:CAN:DATA?`

➤ **Functional description:**

This command is used to set DATA of CAN bus of the oscilloscope. Binary character string data presented by parameter is 0, 1 or X. X represents unsure. And its rang is related to the value set by instruction setting value *8bits :SBUS:CANFD:DATA:LEN, the rang is 0x0~0xFFFFFFFFFFFFFFF.

➤ **Return format:**

Query returns binary character data.

➤ **For example:**

:SBUS:CAN:DATA "X00X00X1" Set CAN bus data to X00X00X1.

:SBUS:CAN:DATA? Query returns X00X00X1.

CAN-FD

This command is used to set the relevant parameter of CAN-FD bus decoding and trigger.

:SBUS:CANFD:SOURce

➤ **Command format:**

:SBUS:CANFD:SOURce {CHANnel1|CHANnel2|CHANnel3|CHANnel4|<Dx>}

:SBUS:CANFD:SOURce?

➤ **Functional description:**

This command is used to set CAN-FD bus input source of the oscilloscope.

<Dx>: It presents the oscilloscope has LA function and it can set D0-D15 channel as the bus decoding source.

➤ **Return format:**

Query returns {CHANnel1|CHANnel2|CHANnel3|CHANnel4|<Dx>}.

➤ **For example:**

:SBUS:CANFD:SOURce CHANnel1

Set channel 1 as CAN-FD bus input source.

:SBUS:CANFD:SOURce? Query returns CHANnel1.

:SBUS:CANFD:SIGNAL:DEFinition

➤ **Command format:**

:SBUS:CANFD:SIGNAL:DEFinition {CANH|CANL}

:SBUS:CANFD:SIGNAL:DEFinition?

➤ **Functional description:**

This command is used to set CAN-FD bus signal tyoe of the oscilloscope.

➤ **Return format:**

Query returns {CANH|CANL}.

➤ **For example:**

:SBUS:CANFD:SIGNAL:DEFinition CANH

Set channel 1 CAN-FD bus signal type to CANH.

:SBUS:CANFD:SIGNAL:DEFinition? Query returns CANH.

:SBUS:CANFD:BAUDrate➤ **Command format:**

```
:SBUS:CANFD:BAUDrate <baudrate>
```

```
:SBUS:CANFD:BAUDrate?
```

➤ **Functional description:**

This command is used to set CAN-FD bus signal baud rate of the oscilloscope, <baudrate> rang is 10000~1000000, uni is bps.

➤ **Return format:**

Query returns signal baud rate.

➤ **For example:**

```
:SBUS:CANFD:BAUDrate 100000
```

Set CAN-FD bus signal baud rate to 100kbps.

```
:SBUS:CANFD:BAUDrate?
```

Query returns 100000.

:SBUS:CANFD:FD:BAUDrate➤ **Command format:**

```
:SBUS:CANFD:FD:BAUDrate <baudrate>
```

```
:SBUS:CANFD:FD:BAUDrate?
```

➤ **Functional description:**

This command is used to set CAN-FD bus FD signal baud rate of the oscilloscope, <baudrate> rang is 250000~8000000, uni is bps.

➤ **Return format:**

Query returns signal baud rate.

➤ **For example:**

```
:SBUS:CANFD:FD:BAUDrate 250000
```

Set CAN-FD bus FD signal baud rate to 250kbps.

```
:SBUS:CANFD:FD:BAUDrate?
```

Query returns 100000.

:SBUS:CANFD:QUALifier➤ **Command format:**

```
:SBUS:CANFD:QUALifier {START|ID|DATA|ACKerror|BITFILL|IDDATA|END}
```

```
:SBUS:CANFD:QUALifier?
```

➤ **Functional description:**

This command is used to set CAN-FD bus trigger condition.

{START|ID|DATA|ACKerror|BITFILL|IDDATA|END}, it respectively represents start, identifier, data frame, lost confirming, bit stuffing, identifier & data and end.

➤ **Return format:**

Query returns {START | ID | DATA | ACKerror | BITFILL | IDDATA | END}.

➤ **For example:**

```
:SBUS:SPI:QUALifier ACK
```

Set CAN-FD bus trigger condition to ACKerror.

:SBUS:SPI:QUALifier? Query returns ACKError.

:SBUS:CANFD:FRAME:TYPE

➤ **Command format:**

:SBUS:CANFD:FRAME:TYPE { DATA | REMote | OVERload | ERRor }

:SBUS:CANFD:FRAME:TYPE?

➤ **Functional description:**

This command is used to set CAN-FD bus trigger frame type.

➤ **Return format:**

Query returns { DATA | REMote | OVERload | ERRor }.

➤ **For example:**

:SBUS:CANFD:FRAME:TYPE ERRor

Set CAN-FD bus trigger frame type to ERRor.

:SBUS:CANFD:FRAME:TYPE? Query returns ERRor.

:SBUS:CANFD:ID:MODE

➤ **Command format:**

:SBUS:CANFD:ID:MODE { STANdard | EXTended | FD_STDI | FD_EXT }

:SBUS:CANFD:ID:MODE?

➤ **Functional description:**

This command is used to set ID identifier frame format of CAN-FD bus of the oscilloscope.

➤ **Return format:**

Query returns { STANdard | EXTended | FD_STDI | FD_EXT }.

➤ **For example:**

:SBUS:CANFD:ID:MODE STANdard

Set ID identifier frame format of CAN-FD bus to STANdard.

:SBUS:CANFD:ID:MODE? Query returns STANdard.

:SBUS:CANFD:ID

➤ **Command format:**

:SBUS:CANFD:ID <string>

:SBUS:CANFD:ID?

➤ **Functional description:**

This command is used to set ID identifier frame data of CAN-FD bus of the oscilloscope. Set the corresponding ID identifier according to the mode of :SBUS:CAN:ID:MODE. Binary character string data presented by parameter is 0, 1 or X. X represents unsure.

Standard frame range is 0x0~0x7FF, data bit occupies 11bits; Extend frame range is 0x0~0x1FFFFFFF, data bit occupies 29bits; FD standard frame range is 0x0~0x7FF, data bit occupies 11bits; FD extend frame range is 0x0~0x1FFFFFFF, data bit occupies 29bits.

➤ **Return format:**

Query returns binary character data.

➤ **For example:**

:SBUS:CANFD:ID "X00X00X1"

Set ID identifier frame data of CAN -FD bus to X00X00X1.

:SBUS:CANFD:ID?

Query returns X00X00X1.

:SBUS:CANFD:DATA:LEN

➤ **Command format:**

:SBUS:CANFD:DATA:LEN <length>

:SBUS:CANFD:DATA:LEN?

➤ **Functional description:**

This command is used to set trigger data length of CAN-FD bus of the oscilloscope. It can take value from 1~16.

➤ **Return format:**

Query returns trigger data length of CAN-FD bus of the oscilloscope, it is integer data.

➤ **For example:**

:SBUS:CANFD:DATA:LEN 2

Set trigger data length of CAN-FD bus to 2 bytes.

:SBUS:CANFD:DATA:LEN?

Query returns 2.

:SBUS:CANFD:DATA

➤ **Command format:**

:SBUS:CANFD:DATA <string>

:SBUS:CANFD:DATA?

➤ **Functional description:**

This command is used to set DATA of CAN-FD bus of the oscilloscope. Binary character string data presented by parameter is 0, 1 or X. X represents unsure. And its rang is related to the value set by instruction setting value *8bits :SBUS:CANFD:DATA:LEN, the rang is 0x0~0xFFFFFFFFFFFFFFFFFFFFFFFFFFFFFFFF.

➤ **Return format:**

Query returns binary character data.

➤ **For example:**

:SBUS:CANFD:DATA "X00X00X1"

Set CAN-FD bus DATA to X00X00X1

:SBUS:CANFD:DATA?

Query returns X00X00X1

:SBUS:CANFD:DATA:OFFSet:CTL

➤ **Command format:**

:SBUS:CANFD:DATA:OFFSet:CTL {{1|ON}}|{{0|OFF}}

:SBUS:CANFD:DATA:OFFSet:CTL?

➤ **Functional description:**

This command is used to turn on/off CAN-FD bus DATA byte offset of the oscilloscope.

➤ **Return format:**

Query returns 1 or 0, it respectively represents ON or OFF.

➤ **For example:**

:SBUS:CANFD:DATA:OFFSet:CTL ON

Turn on CAN-FD bus DATA byte offset.

:SBUS:CANFD:DATA:OFFSet:CTL? Query returns 1.

:SBUS:CANFD:DATA:OFFSet

➤ **Command format:**

:SBUS:CANFD:DATA:OFFSet <offset>

:SBUS:CANFD:DATA:OFFSet?

➤ **Functional description:**

This command is used to set CAN-FD bus DATA byte offset of the oscilloscope. Byte offset is turned on by default when using this instruction.

<offset>: byte offset, it is integer data type and the range is 0~63.

➤ **Return format:**

Query returns byte offset.

➤ **For example:**

:SBUS:CANFD:DATA:OFFSet 8

Set CAN-FD bus DATA byte offset to 8.

:SBUS:CANFD:DATA:OFFSet? Query returns 8.

LIN

:SBUS:LIN:SOURce

➤ **Command format:**

:SBUS:LIN:SOURce {CHANnel1|CHANnel2|CHANnel3|CHANnel4|<Dx>}

:SBUS:LIN:SOURce?

➤ **Functional description:**

This command is used to set LIN bus decoding source of the oscilloscope.

<Dx>: It presents the oscilloscope has LA function and it can set D0-D15 channel as the bus decoding source.

➤ **Return format:**

Query returns {CHANnel1|CHANnel2|CHANnel3|CHANnel4|<Dx>}

➤ **For example:**

:SBUS:LIN:SOURce CHANnel1

Set channel 1 as the LIN bus decoding source.

:SBUS:LIN:SOURce? Query returns CHANnel1.

:SBUS:LIN:POLarity

- **Command format:**
:SBUS:LIN:POLarity {NORMal|INVert}
:SBUS:LIN:POLarity?
- **Functional description:**
This command is used to set LIN bus polarity of the oscilloscope, which includes NORMal (normal, high =1) and INVert (invert, high=0).
- **Return format:**
Query returns {NORMal|INVert}.
- **For example:**
:SBUS:LIN:POLarity NORMal Set LIN bus polarity to NORMal.
:SBUS:LIN:POLarity? Query returns POSitive.

:SBUS:LIN:VERSion

- **Command format:**
:SBUS:LIN:VERSion {VER1|VER2|ANY}
:SBUS:LIN:VERSion?
- **Functional description:**
This command is used to set LIN bus version of the oscilloscope.
{VER1|VER2|ANY}: V1.x version, V2.x version and random version.
- **Return format:**
Query returns {VER1|VER2|ANY}.
- **For example:**
:SBUS:LIN:VERSion VER1
Set LIN bus version to V1.x version.
:SBUS:LIN:VERSion? Query returns POSitive.

:SBUS:LIN:SIGNal:BAUDrate

- **Command format:**
:SBUS:LIN:SIGNal:BAUDrate <baudrate>
:SBUS:LIN:SIGNal:BAUDrate?
- **Functional description:**
This command is used to set baud rate of LIN bus signal of the oscilloscope. <baudrate> range is 1~100000, unit is bps.
- **Return format:**
Query returns signal baud rate.
- **For example:**
:SBUS:LIN:SIGNal:BAUDrate 100000 Set baud rate of LIN bus signal to 100kbps.
:SBUS:LIN:SIGNal:BAUDrate? Query returns 100000.

:SBUS:LIN:PARity:DISPlay➤ **Command format:**

```
:SBUS:LIN:PARity:DISPlay {{1|ON}}|{{0|OFF}}
```

```
:SBUS:LIN:PARity:DISPlay?
```

➤ **Functional description:**

This command is used to set LIN bus ID parity bit of the oscilloscope, which can set to ON (yes) or OFF (no).

➤ **Return format:**

Query returns 1 or 0, it respectively represents ON of OFF.

➤ **For example:**

```
:SBUS:LIN:PARity:DISPlay ON           LIN bus decoding ID includes parity bit.
```

```
:SBUS:LIN:PARity:DISPlay?           Query returns 1.
```

:SBUS:LIN:DATA:LENGth:DISPlay➤ **Command format:**

```
:SBUS:LIN:DATA:LENGth:DISPlay {{1|ON}}|{{0|OFF}}
```

```
:SBUS:LIN:DATA:LENGth:DISPlay?
```

➤ **Functional description:**

This command is used to set LIN bus ID whether set data length of the oscilloscope, which can set to ON (yes) or OFF (no).

➤ **Return format:**

Query returns 1 or 0, it respectively represents ON of OFF.

➤ **For example:**

```
:SBUS:LIN:DATA:LENGth:DISPlay ON
```

LIN bus decoding sets the data length.

```
:SBUS:LIN:DATA:LENGth:DISPlay?      Query returns 1.
```

:SBUS:LIN:DATA:LENGth➤ **Command format:**

```
:SBUS:LIN:DATA:LENGth <length>
```

```
:SBUS:LIN:DATA:LENGth?
```

➤ **Functional description:**

This command is used to set the length of LIN bus setting data of the oscilloscope, setting data length is open by default when using this instruction.

<length>: data length, it is integer data type, range is 1-8.

➤ **Return format:**

Query returns data length.

➤ **For example:**

```
:SBUS:LIN:DATA:LENGth 6           Set LIN bus decoding setting data length to 6.
```

```
:SBUS:LIN:DATA:LENGth?           Query returns 6.
```

:SBUS:LIN:QUALifier➤ **Command format:**

```
:SBUS:LIN:QUALifier {SYNC|ID|DATA|IDDATA|WAKE|SLEEP|ERROR}
```

```
:SBUS:LIN:QUALifier?
```

➤ **Functional description:**

This command is used to set LIN bus trigger condition of the oscilloscope.

{SYNC|ID|DATA|IDDATA|WAKE|SLEEP|ERROR}: synchronization, identifier, data, ID and data, wake frame, sleep frame, error.

➤ **Return format:**

Query returns {SYNC|ID|DATA|IDDATA|WAKE|SLEEP|ERROR}.

➤ **For example:**

```
:SBUS:LIN:QUALifier SYNC           Set LIN bus trigger condition to SYNC.
```

```
:SBUS:LIN:QUALifier?              Query returns SYNC'
```

:SBUS:LIN:ID➤ **Command format:**

```
:SBUS:LIN:ID <string>
```

```
:SBUS:LIN:ID?
```

➤ **Functional description:**

This command is used to set LIN bus identifier data of the oscilloscope. Binary character data presented by parameter 0, 1 or X. X represents uncertainty. Its range is 0x0~0xff.

➤ **Return format:**

Query returns binary character string data.

➤ **For example:**

```
:SBUS:LIN:ID "X00X00X1"          Set LIN bus identifier data to X00X00X1.
```

```
:SBUS:LIN:ID?                    Query returns X00X00X1.
```

:SBUS:LIN:TRIGger:DATA:LENGth➤ **Command format:**

```
:SBUS:LIN:TRIGger:DATA:LENGth <length>
```

```
:SBUS:LIN:TRIGger:DATA:LENGth?
```

➤ **Functional description:**

This command is used to set LIN bus trigger data length of the oscilloscope. It can take value from 1~8.

➤ **Return format:**

Query returns LIN bus trigger data length of the oscilloscope, it is integer data.

➤ **For example:**

```
:SBUS:LIN:TRIGger:DATA:LENGth 2   Set LIN bus trigger data length to 2 bytes.
```

```
:SBUS:LIN:TRIGger:DATA:LENGth?    Query returns 2.
```

:SBUS:LIN:DATA➤ **Command format:**

:SBUS:LIN:DATA <string>

:SBUS:LIN:DATA?

➤ **Functional description:**

This command is used to set DATA of LIN bus of the oscilloscope. Binary character string data presented by parameter is 0, 1 or X. X represents unsure. And its rang is related to the value set by instruction setting value *8bits :SBUS:LIN:TRIGger:DATA:LENGth, the rang is 0x0-0xFFFFFFFFFFFFFFF.

➤ **Return format:**

Query returns binary character string data.

➤ **For example:**

:SBUS:LIN:DATA "X00X00X1" Set LIN bus DATA to X00X00X1.

:SBUS:LIN:DATA? Query returns X00X00X1.

:SBUS:LIN:ERRor:TYPE➤ **Command format:**

:SBUS:LIN:ERRor:TYPE { SYNC | PARity | SUM }

:SBUS:LIN:ERRor:TYPE?

➤ **Functional description:**

This command is used to set error type of LIN bus trigger condition of the oscilloscope. {SYNC | PARity | SUM}: synchronization, ID parity bit, checksum.

➤ **Return format:**

Query returns { SYNC | PARity | SUM }.

➤ **For example:**

:SBUS:LIN:ERRor:TYPE SYNC Set LIN bus trigger condition to SYNC.

:SBUS:LIN:ERRor:TYPE? Query returns SYNC.

FlexRay

:SBUS:FR:SOURce➤ **Command format:**

:SBUS:FR:SOURce { CHANnel1|CHANnel2|CHANnel3|CHANnel4|<Dx> }

:SBUS:FR:SOURce?

➤ **Functional description:**

This command is used to set FlexRay bus decoding source of the oscilloscope.

<Dx>: It presents the oscilloscope has LA function and it can set D0-D15 channel as the bus decoding source.

➤ **Return format:**

Query returns { CHANnel1|CHANnel2|CHANnel3|CHANnel4|<Dx> }.

➤ **For example:**

:SBUS:FR:SOURce CHANnel1 Set channel 1 as the FlexRay bus decoding source.
 :SBUS:FR:SOURce? Query returns CHANnel1.

:SBUS:FR:POLarity

➤ **Command format:**

:SBUS:FR:POLarity {BP|BM}
 :SBUS:FR:POLarity?

➤ **Functional description:**

This command is used to set FlexRay bus polarity of the oscilloscope, BP (Bdiff or BP).

➤ **Return format:**

Query returns {BP|BM}.

➤ **For example:**

:SBUS:FR:POLarity BP Set FlexRay bus polarity to BP.
 :SBUS:FR:POLarity? Query returns BP.

:SBUS:FR:CHANnel:TYPE

➤ **Command format:**

:SBUS:FR:CHANnel:TYPE {A|B}
 :SBUS:FR:CHANnel:TYPE?

➤ **Functional description:**

This command is used to set FlexRay bus channel type.

➤ **Return format:**

Query returns {A|B}.

➤ **For example:**

:SBUS:FR:CHANnel:TYPE A Set FlexRay channel type to A.
 :SBUS:FR:CHANnel:TYPE? Query returns A.

:SBUS:FR:SIGNal:BAUDrate

➤ **Command format:**

:SBUS:FR:SIGNal:BAUDrate {2.5M|5M|10M}
 :SBUS:FR:SIGNal:BAUDrate?

➤ **Functional description:**

This command is used to set baud rate of FlexRay bus signal of the oscilloscope.

➤ **Return format:**

Query returns signal baud rate.

➤ **For example:**

:SBUS:FR:SIGNal:BAUDrate 2.5M Set baud rate of FlexRay bus signal to 2.5 Mbps.
 :SBUS:FR:SIGNal:BAUDrate? Query returns 2.5 M.

:SBUS:FR:QUALifier➤ **Command format:**

```
:SBUS:FR:QUALifier {START|IND|ID|CYCLES|HEAD|DATA|DDATA|END|ERROR}
```

```
:SBUS:FR:QUALifier?
```

➤ **Functional description:**

This command is used to set FlexRay bus trigger condition of the oscilloscope.

{START|IND|ID|CYCLES|HEAD|DATA|DDATA|END|ERROR}: start frame, indicator bit, cycle number, header filed, data, ID and data, end frame, error.

➤ **Return format:**

Query returns {START|IND|ID|CYCLES|HEAD|DATA|DDATA|END|ERROR}.

➤ **For example:**

```
:SBUS:FR:QUALifier START           Set FlexRay bus trigger condition to start frame.
```

```
:SBUS:FR:QUALifier?               Query returns START.
```

:SBUS:FR:INDicator➤ **Command format:**

```
:SBUS:FR:INDicator {NORMal|STATIC|NULL|SYNC|START}
```

```
:SBUS:FR:INDicator?
```

➤ **Functional description:**

This command is used to set FlexRay bus trigger indicator bit type of the oscilloscope.

{NORMal|STATIC|NULL|SYNC|START}: normal(01XX), static load (11XX), null (00XX), synchronization (XX10), start (XX11).

➤ **Return format:**

Query returns {NORMal|STATIC|NULL|SYNC|START}.

➤ **For example:**

```
:SBUS:FR:INDicator NORMal         Set FlexRay bus trigger indicator bit to normal.
```

```
:SBUS:FR:INDicator?              Query returns NORMal.
```

:SBUS:FR:INDicator:DATA➤ **Command format:**

```
:SBUS:FR:INDicator:DATA <string>
```

```
:SBUS:FR:INDicator:DATA?
```

➤ **Functional description:**

This command is used to set header field indicator bit data in FlexRay bus trigger condition. Binary character data presented by parameter 0, 1 or X. X represents uncertainty. Data bit is 5bits and its range is 0x0~0x1F.

➤ **Return format:**

Query returns character string type of 0x format.

➤ **For example:**

```
:SBUS:FR:INDicator:DATA "000100X1" Set FlexRay bus indicator bit data to 000100X1.
```

:SBUS:FR:INDicator:DATA?

Query returns 000100X1.

:SBUS:FR:PAYLoad:SIZE

➤ **Command format:**

:SBUS:FR:PAYLoad:SIZE <size>

:SBUS:FR:PAYLoad:SIZE?

➤ **Functional description:**

This command is used to set header field static load length in FlexRay bus trigger condition. Binary character data presented by parameter 0, 1 or X. X represents uncertainty. Data bit is 7bits and its range is 0x0~0x7F.

➤ **Return format:**

Query returns binary character string data.

➤ **For example:**

:SBUS:FR:PAYLoad:SIZE "X00X00X1"

Set FlexRay bus static load length to X00X00X1.

:SBUS:FR:PAYLoad:SIZE?

Query returns X00X00X1.

:SBUS:FR:HEADer:CRC

➤ **Command format:**

:SBUS:FR:HEADer:CRC <crc>

:SBUS:FR:HEADer:CRC?

➤ **Functional description:**

This command is used to set header CRC in FlexRay bus trigger condition. Binary character data presented by parameter 0, 1 or X. X represents uncertainty. Data bit is 11bits and its range is 0x0~0x7FF.

➤ **Return format:**

Query returns binary character string data.

➤ **For example:**

:SBUS:FR:HEADer:CRC "X00X00X1"

Set FlexRay bus header CRC to X00X00X1.

:SBUS:FR:HEADer:CRC?

Query returns X00X00X1.

:SBUS:FR:CYCLes

➤ **Command format:**

:SBUS:FR:CYCLes <string>

:SBUS:FR:CYCLes?

➤ **Functional description:**

This command is used to set cycle number in FlexRay bus trigger condition. Binary character data presented by parameter 0, 1 or X. X represents uncertainty. Data bit is 6bits and its range is 0x0~0x3F.

➤ **Return format:**

Query returns binary character string data.

➤ **For example:**

:SBUS:FR:CYCLes "0X00X1" Set FlexRay bus cycle number to 0X00X1.
 :SBUS:FR:CYCLes? Query returns 0X00X1.

:SBUS:FR:ID

➤ **Command format:**

:SBUS:FR:ID <string>
 :SBUS:FR:ID?

➤ **Functional description:**

This command is used to set FlexRay bus identifier data. Binary character data presented by parameter 0, 1 or X. X represents uncertainty. Data bit is 11bits and its range is 0x0~0x7FF.

➤ **Return format:**

Query returns binary character string data.

➤ **For example:**

:SBUS:FR:ID "X00X00X1" Set FlexRay bus identifier data to X00X00X1.
 :SBUS:FR:ID? Query returns X00X00X1.

:SBUS:FR:DATA:LEN

➤ **Command format:**

:SBUS:FR:DATA:LEN <length>
 :SBUS:FR:DATA:LEN?

➤ **Functional description:**

This command is used to set FlexRay bus trigger data length of the oscilloscope. It can take value from 1~16.

➤ **Return format:**

Query returns FlexRay bus trigger data length of the oscilloscope, it is integer data.

➤ **For example:**

:SBUS:FR:DATA:LEN 2 Set FlexRay bus trigger data length to 2 bytes.
 :SBUS:FR:DATA:LEN? Query returns 2.

:SBUS:FR:DATA

➤ **Command format:**

:SBUS:FR:DATA <string>
 :SBUS:FR:DATA?

➤ **Functional description:**

This command is used to set unsure data of FlexRay bus of the oscilloscope. Binary character string data presented by parameter is 0, 1 or X. X represents unsure. And its rang is related to the value set by instruction setting value *8bits:SBUS:FR:DATA:LEN, the rang is 0x0~0xFFFFFFFFFFFFFFFFFFFFFFFFFFFFFFFF.

➤ **Return format:**

Query returns binary character string data.

➤ **For example:**

:SBUS:FR:DATA "X00X00X1" Set FlexRay bus data to X00X00X1.
 :SBUS:FR:DATA? Query returns X00X00X1.

:SBUS:FR:DATA:OFFSet:CTL

- **Command format:**
 :SBUS:FR:DATA:OFFSet:CTL { {1|0N} | {0|0FF} }
 :SBUS:FR:DATA:OFFSet:CTL?
- **Functional description:**
 This command is used to set FlexRay bus DATA byte offset status of the oscilloscope.
- **Return format:**
 Query returns 1 or 0, it respectively represents ON or OFF.
- **For example:**
 :SBUS:FR:DATA:OFFSet:CTL ON
 Turn on FlexRay bus DATA byte offset.
 :SBUS:FR:DATA:OFFSet:CTL? Query returns 1.

:SBUS:FR:DATA:OFFSet

- **Command format:**
 :SBUS:FR:DATA:OFFSet <offset>
 :SBUS:FR:DATA:OFFSet?
- **Functional description:**
 This command is used to set FlexRay bus DATA byte offset of the oscilloscope. Byte offset is turned on by default when using this instruction.
 <offset>: byte offset, it is integer data type and the range is 0~253.
- **Return format:**
 Query returns byte offset.
- **For example:**
 :SBUS:FR:DATA:OFFSet 8
 Set FlexRay bus DATA byte offset to 8.
 :SBUS:FR:DATA:OFFSet? Query returns 8.

:SBUS:FR:END:TYPE

- **Command format:**
 :SBUS:FR:END:TYPE { STATIC | DTS | ALL }
 :SBUS:FR:END:TYPE?
- **Functional description:**
 This command is used to set FlexRay bus trigger condition end frame type of the oscilloscope.
 { STATIC | DTS | ALL }: static, dynamic, full.
- **Return format:**
 Query returns { STATIC | DTS | ALL }.

➤ **For example:**

```
:SBUS:FR:END:TYPE STATIC
```

Set FlexRay bus trigger condition to static end frame.

```
:SBUS:FR:END:TYPE?           Query returns STATIC.
```

:SBUS:FR:ERRor:TYPE

➤ **Command format:**

```
:SBUS:FR:ERRor:TYPE
```

```
{HEADCRC|ENDCRC|NULLSTATIC|NULLDYNAMIC|SYNC|START}
```

```
:SBUS:FR:ERRor:TYPE?
```

➤ **Functional description:**

This command is used to set FlexRay bus trigger condition error type of the oscilloscope.

{HEADCRC|ENDCRC|NULLSTATIC|NULLDYNAMIC|SYNC|START}: header CRC, end frame, null static, null dynamic, synchronization frame, start frame.

➤ **Return format:**

Query returns {HEADCRC|ENDCRC|NULLSTATIC|NULLDYNAMIC|SYNC|START}.

➤ **For example:**

```
:SBUS:FR:ERRor:TYPE SYNC
```

Set FlexRay bus trigger condition error type to synchronization.

```
:SBUS:FR:ERRor:TYPE?           Query returns SYNC.
```

AWG Command

This command is used to set the built-in signal source.

Channel Command

This command is used to set the built-in signal source.

AWG:CHANnel<n>:OUTPut

➤ **Command format:**

```
AWG:CHANnel<n>:OUTPut  {{1|ON}|{0|OFF}}
```

```
AWG:CHANnel<n>:OUTPut?
```

➤ **Functional description:**

This command is used to turn on/off the specified channel output.

<n>: channel number, n takes value as 1 or 2.

➤ **Return format:**

Query returns the output status of the specified channel. 0 represents OFF, 1 represents ON.

➤ **For example:**

```
AWG:CHANnel1:OUTPut ON
```

Turn on channel 1 output.

```
AWG:CHANnel1:OUTPut?
```

Query returns 1.

AWG:CHANnel<n>:LOAD➤ **Command format:**

AWG:CHANnel<n>:LOAD <resistance>

AWG:CHANnel<n>:LOAD?

➤ **Functional description:**

This command is used to set the specified channel output load.

<resistance> represents load resistance value, unit is Ω .

<n>: channel number, n takes value as 1 or 2.

Note: Resistance value take from 1~10000 and 10000 is relative to high resistance.

➤ **Return format:**

Query returns the load resistance value of the specified channel in scientific notation.

➤ **For example:**

AWG:CHANnel1:LOAD 50

Set channel 1 output load is 50 Ω .

AWG:CHANnel1:LOAD?

Query returns 50e+0.

AWG:CHANnel<n>:LIMit:ENABLE➤ **Command format:**

AWG:CHANnel<n>:LIMit:ENABLE {{1|ON}}|{{0|OFF}}

AWG:CHANnel<n>:LIMit:ENABLE?

➤ **Functional description:**

This command is used to turn on/off the amplitude limit of the specified channel.

<n>: channel number, n takes value as 1 or 2.

➤ **Return format:**

Query returns the amplitude limit of the specified channel.

➤ **For example:**

AWG:CHANnel1:LIMit:ENABLE ON

Turn on the amplitude limit of channel 1.

AWG:CHANnel1:LIMit:ENABLE?

Query returns 1.

AWG:CHANnel<n>:LIMit:LOWer➤ **Command format:**

AWG:CHANnel<n>:LIMit:LOWer <voltage>

AWG:CHANnel<n>:LIMit:LOWer?

➤ **Functional description:**

This command is used to set the amplitude lower limit of the specified channel.

<voltage> represents voltage, unit is assigned by the current channel.

<n>: channel number, n takes value as 1 or 2.

➤ **Return format:**

Query returns the amplitude lower limit of the specified channel in scientific notation.

➤ **For example:**

AWG:CHANnel1:LIMit:LOWer 2

Set the amplitude lower limit of channel 1 to 2 V.

AWG:CHANnel1:LIMit:LOWer?

Query returns 2e+0.

AWG:CHANnel<n>:LIMit:UPPer

➤ **Command format:**

AWG:CHANnel<n>:LIMit:UPPer <voltage>

AWG:CHANnel<n>:LIMit:UPPer?

➤ **Functional description:**

This command is used to set the amplitude upper limit of the specified channel.

<voltage> represents voltage, unit is assigned by the current channel.

<n>: channel number, n takes value as 1 or 2.

➤ **Return format:**

Query returns the amplitude upper limit of the specified channel in scientific notation.

➤ **For example:**

AWG:CHANnel1:LIMit:UPPer 2

Set the amplitude upper limit of channel 1 to 2 V.

AWG:CHANnel1:LIMit:UPPer?

Query returns 2e+0.

AWG:CHANnel<n>:AMPLitude:UNIT

➤ **Command format:**

AWG:CHANnel<n>:AMPLitude:UNIT {VPP | VRMS | DBM}

AWG:CHANnel<n>:AMPLitude:UNIT?

➤ **Functional description:**

This command is used to set output amplitude unit of the specified channel.

<n>: channel number, n takes value as 1 or 2.

➤ **Return format:**

Query returns output amplitude unit of the specified channel

➤ **For example:**

AWG:CHANnel1:AMPLitude:UNIT VPP

Set output amplitude unit of channel 1 to VPP.

AWG:CHANnel1:AMPLitude:UNIT?

Query returns VPP.

AWG:CHANnel<n>:MODE

➤ **Command format:**

AWG:CHANnel<n>:MODE {BASE | MODulate}

AWG:CHANnel<n>:MODE?

➤ **Functional description:**

This command is used to set the signal type of the specified channel. BASE represents fundamental wave mode. MODulate represents modulating mode.

<n>: channel number, n takes value as 1 or 2.

➤ **Return format:**

Query returns the signal type of the specified channel.

➤ **For example:**

AWG:CHANnel1:MODE BASE

Set channel 1 signal output in fundamental wave mode.

AWG:CHANnel1:MODE? Query returns BASE.

AWG:CHANnel<n>:BASE:WAVE

➤ **Command format:**

AWG:CHANnel<n>:BASE:WAVE { SINE | SQUARE | PULSE | RAMP | ARB | NOISE | DC }

AWG:CHANnel<n>:BASE:WAVE?

➤ **Functional description:**

This command is used to set the fundamental wave type of the specified channel, which is sinewave, square wave, pulse wave, triangle wave, arbitrary wave, noise wave and DC.

<n>: channel number, n takes value as 1 or 2.

➤ **Return format:**

Query returns the fundamental wave type of the specified channel.

➤ **For example:**

AWG:CHANnel1:BASE:WAVE SINE

Set the fundamental wave type of channel 1 to sine wave.

AWG:CHANnel1:BASE:WAVE? Query returns SINE.

AWG:CHANnel<n>:BASE:FREQuency

➤ **Command format:**

AWG:CHANnel<n>:BASE:FREQuency <freq>

AWG:CHANnel<n>:BASE:FREQuency?

➤ **Functional description:**

This command is used to set output frequency of the specified channel.

<freq> represents frequency value, unit is Hz. (1e-6s ~ the currently maximum allowed frequency)

<n>: channel number, n takes value as 1 or 2.

➤ **Return format:**

Query returns output frequency of the specified channel in scientific notation.

➤ **For example:**

AWG:CHANnel1:BASE:FREQuency 2000

Set output frequency of channel 1 to 2 kHz.

AWG:CHANnel1:BASE:FREQuency? Query returns 2e+3.

AWG:CHANnel<n>:BASE:AMPLitude

➤ **Command format:**

AWG:CHANnel<n>:BASE:AMPLitude <amp>

AWG:CHANnel<n>:BASE:AMPLitude?

➤ **Functional description:**

This command is used to set output amplitude of the specified channel.

<amp> represents voltage, unit is assigned by the current channel. (1mVpp ~ maximum value of output under the current load)

If the current unit is VPP, then the maximum value under the current load = the current load *20/(50+ the current load)

<n>: channel number, n takes value as 1 or 2.

➤ **Return format:**

Query returns output amplitude of the specified channel in scientific notation.

➤ **For example:**

AWG:CHANnel1:BASE:AMPLitude 2	Set output amplitude of channel 1 to 2 V.
AWG:CHANnel1:BASE:AMPLitude?	Query returns 2e+0.

AWG:CHANnel<n>:BASE:PERiod

➤ **Command format:**

AWG:CHANnel<n>:BASE:PERiod <period>

AWG:CHANnel<n>:BASE:PERiod?

➤ **Functional description:**

This command is used to set output period of the specified channel.

<period> represents period, unit is s.

If it is sine wave, the range is the current allowed maximum time ~ 1e3s.

<n>: channel number, n takes value as 1 or 2.

➤ **Return format:**

Query returns the amplitude upper limit of the specified channel in scientific notation.

➤ **For example:**

AWG:CHANnel1:BASE:PERiod 0.002	Set output period of channel 1 to 2ms.
AWG:CHANnel1:BASE:PERiod?	Query returns 2e-3.

AWG:CHANnel<n>:BASE:PHASe

➤ **Command format:**

AWG:CHANnel<n>:BASE:PHASe <phase>

AWG:CHANnel<n>:BASE:PHASe?

➤ **Functional description:**

This command is used to set output phase of the specified channel.

<phase> represents phase, unit is°. The range is -360~360.

<n>: channel number, n takes value as 1 or 2.

➤ **Return format:**

Query returns output phase of the specified channel.

➤ **For example:**

AWG:CHANnel1:BASE:PHASe 20	Set output phase of channel 1 to 20°.
AWG:CHANnel1:BASE:PHASe?	Query returns 20.

AWG:CHANnel<n>:BASE:OFFSet➤ **Command format:**

AWG:CHANnel<n>:BASE:OFFSet <voltage>

AWG:CHANnel<n>:BASE:OFFSet?

➤ **Functional description:**

This command is used to set DC offset of the specified channel.

<voltage> represents voltage, unit is V. The range is $0 \sim \pm$ the maximum DC under the current load.

the maximum DC under the current load = the current load *10/(50+ the current load) - the current AC minimum value /2;

AC minimum value is 2mVpp, take 0 in DC mode.

<n>: channel number, n takes value as 1 or 2.

➤ **Return format:**

Query returns DC offset of the specified channel in scientific notation.

➤ **For example:**

AWG:CHANnel1:BASE:OFFSet 2

Set DC offset of channel 1 to 2 V.

AWG:CHANnel1:BASE:OFFSet?

Query returns 2e+0.

AWG:CHANnel<n>:BASE:HIGh➤ **Command format:**

AWG:CHANnel<n>:BASE:HIGh <voltage>

AWG:CHANnel<n>:BASE:HIGh?

➤ **Functional description:**

This command is used to set output high value of the specified channel signal.

<voltage> represents voltage, unit is assigned by the current channel.

<n>: channel number, n takes value as 1 or 2.

➤ **Return format:**

Query returns output high value of the specified channel signal in scientific notation.

➤ **For example:**

AWG:CHANnel1:BASE:HIGh 2

Set output high value of channel 1 signal to 2 V.

AWG:CHANnel1:BASE:HIGh?

Query returns 2e+0.

AWG:CHANnel<n>:BASE:LOW➤ **Command format:**

AWG:CHANnel<n>:BASE:LOW <voltage>

AWG:CHANnel<n>:BASE:LOW?

➤ **Functional description:**

This command is used to set output low level of the specified channel signal.

<voltage> represents voltage, unit is assigned by the current channel.

<n>: channel number, n takes value as 1 or 2.

➤ **Return format:**

Query returns output low level of the specified channel signal in scientific notation.

➤ **For example:**

AWG:CHANnel1:BASE:LOW 2

Set output low value of channel 1 signal to 2 V.

AWG:CHANnel1:BASE:LOW?

Query returns 2e+0.

AWG:CHANnel<n>:BASE:DUTY

➤ **Command format:**

AWG:CHANnel<n>:BASE:DUTY <duty>

AWG:CHANnel<n>:BASE:DUTY?

➤ **Functional description:**

This command is used to set output duty cycle of the specified channel signal.

<duty> represents duty cycle, unit is %. The range is 0~100.

<n>: channel number, n takes value as 1 or 2.

➤ **Return format:**

Query returns output duty cycle of the specified channel signal.

➤ **For example:**

AWG:CHANnel1:BASE:DUTY 20

Set output duty cycle of channel 1 signal to 20%.

AWG:CHANnel1:BASE:DUTY?

Query returns 20.

AWG:CHANnel<n>:RAMP:SYMMetry

➤ **Command format:**

AWG:CHANnel<n>:RAMP:SYMMetry <symmetry>

AWG:CHANnel<n>:RAMP:SYMMetry?

➤ **Functional description:**

This command is used to set output symmetry degree of the specified channel ramp signal.

< symmetry > represents symmetry degree, unit is %. The range is 0~100.

<n>: channel number, n takes value as 1 or 2.

➤ **Return format:**

Query returns output symmetry degree of the specified ramp signal.

➤ **For example:**

AWG:CHANnel1:RAMP:SYMMetry 20

Set symmetry degree of channel 1 ramp signal to 20%.

AWG:CHANnel1:RAMP:SYMMetry?

Query returns 20.

AWG:CHANnel<n>:PULSe:RISe

➤ **Command format:**

AWG:CHANnel<n>:PULSe:RISe <width>

AWG:CHANnel<n>:PULSe:RISe?

➤ **Functional description:**

This command is used to set output rising edge pulse width of the specified channel signal pulse wave.

<width> represents pulse width, unit is s.

<n>: channel number, n takes value as 1 or 2.

➤ **Return format:**

Query returns output rising edge pulse width of the specified channel signal pulse wave in scientific notation.

➤ **For example:**

AWG:CHANnel1:PULSe:RISe 0.002 Set rising edge pulse width of channel 1 to 2ms.

AWG:CHANnel1:PULSe:RISe? Query returns 2e-3.

AWG:CHANnel<n>:PULSe:FALL

➤ **Command format:**

AWG:CHANnel<n>:PULSe:FALL <width>

AWG:CHANnel<n>:PULSe:FALL?

➤ **Functional description:**

This command is used to set output falling edge pulse width of the specified channel signal pulse wave.

<width> represents pulse width, unit is s.

<n>: channel number, n takes value as 1 or 2.

➤ **Return format:**

Query returns output falling edge pulse width of the specified channel signal pulse wave in scientific notation.

➤ **For example:**

AWG:CHANnel1:PULSe:FALL 0.002

Set falling edge pulse width of channel 1 to 2ms.

AWG:CHANnel1:PULSe:FALL? Query returns 2e-3.

AWG:CHANnel<n>:MODulate

➤ **Command format:**

AWG:CHANnel<n>:MODulate { AM | FM }

AWG:CHANnel<n>:MODulate?

➤ **Functional description:**

This command is used to set modulating type of the specified channel, which is AM (modulating amplitude), FM (modulating frequency)

<n>: channel number, n takes value as 1 or 2.

➤ **Return format:**

Query returns modulating type of the specified channel.

➤ **For example:**

AWG:CHANnel1:MODulate AM Set modulating type of channel 1 to AM.

AWG:CHANnel1:MODulate? Query returns AM.

AWG:CHANnel<n>:MODulate:WAVE➤ **Command format:**

AWG:CHANnel<n>:MODulate:WAVE {SINe|SQUare|UPRamp|DNRamp|ARB|NOISe}

AWG:CHANnel<n>:MODulate:WAVE?

➤ **Functional description:**

This command is used to set modulating carrier wave type of the specified channel signal, which is sine wave, square wave, upper-triangle, down-triangle, arbitrary wave and noise wave.

<n>: channel number, n takes value as 1 or 2.

➤ **Return format:**

Query returns modulating signal carrier wave type of the specified channel signal.

➤ **For example:**

AWG:CHANnel1:MODulate:WAVE SINe

Set modulating carrier wave type of channel 1 signal to sine wave.

AWG:CHANnel1:MODulate:WAVE? Query returns SINe.

AWG:CHANnel<n>:MODulate:FREQuency➤ **Command format:**

AWG:CHANnel<n>:MODulate:FREQuency <freq>

AWG:CHANnel<n>:MODulate:FREQuency?

➤ **Functional description:**

This command is used to set modulating frequency of the specified channel signal.

<freq> represents frequency, unit is Hz.

<n>: channel number, n takes value as 1 or 2.

➤ **Return format:**

Query returns modulating frequency of the specified channel signal in scientific notation.

➤ **For example:**

AWG:CHANnel1:MODulate:FREQuency 2000

Set modulating frequency of channel 1 signal to 2 kHz.

AWG:CHANnel1:MODulate:FREQuency? Query returns 2e+3.

AWG:CHANnel<n>:AM:MODulate:DEPTH➤ **Command format:**

AWG:CHANnel<n>:AM:MODulate:DEPTH <depth>

AWG:CHANnel<n>:AM:MODulate:DEPTH?

➤ **Functional description:**

This command is used to set AM modulating depth of the specified channel.

<depth> represents modulating depth, unit is %. 0% ~ 100%, AM modulating depth is 0% ~ 120%.

<n>: channel number, n takes value as 1 or 2.

➤ **Return format:**

Query returns modulating depth of the specified channel.

- **For example:**

AWG:CHANnel1:AM:MODulate:DEPTh 50

Set modulating depth of channel 1 to 50%.

AWG:CHANnel1:AM:MODulate:DEPTh? Query returns 50.

AWG:CHANnel<n>:FM:FREQuency:DEV

- **Command format:**

AWG:CHANnel<n>:FM:FREQuency:DEV <freq>

AWG:CHANnel<n>:FM:FREQuency:DEV?

- **Functional description:**

This command is used to set frequency deviation of the specified channel FM.

<freq> represents frequency deviation, unit is Hz. 0Hz ~ the current carrier wave frequency.

<n>: channel number, n takes value as 1 or 2.

- **Return format:**

Query returns frequency deviation of the specified channel in scientific notation.

- **For example:**

AWG:CHANnel<n>:FM:FREQuency:DEV 2000

Set frequency deviation of channel 1 to 2 kHz.

AWG:CHANnel<n>:FM:FREQuency:DEV? Query returns 2e+3.

AWG:CHANnel<n>:ARB:SOURce

- **Command format:**

AWG:CHANnel<n>:ARB:SOURce { INTernal|EXTernal }

AWG:CHANnel<n>:ARB:SOURce?

- **Functional description:**

This command is used to set arbitrary wave source of the specified channel, which divided into internal and external.

<n>: channel number, n takes value as 1 or 2.

- **Return format:**

Query returns arbitrary wave source of the specified channel.

- **For example:**

AWG:CHANnel1:ARB:SOURce INTernal

Set arbitrary wave source of channel 1 to internal.

AWG:CHANnel1:ARB:SOURce? Query returns INTernal.

AWG:CHANnel<n>:ARB:INDex

- **Command format:**

AWG:CHANnel<n>:ARB:INDex <index>

AWG:CHANnel<n>:ARB:INDex?

- **Functional description:**

This command is used to set arbitrary wave sequence number stored in the specified channel loading signal source.

<index > represents arbitrary wave sequence number.

<n>: channel number, n takes value as 1 or 2.

➤ **Return format:**

Query returns arbitrary wave sequence number of the specified channel.

➤ **For example:**

AWG:CHANnel1:ARB:IND 2

Set the second arbitrary wave stored in channel 1 loading signal source.

AWG:CHANnel1:ARB:IND? Query returns 2.

AWG:CHANnel<n>:ARB

➤ **Command format:**

AWG:CHANnel<n>:ARB <filename>

AWG:CHANnel<n>:ARB?

➤ **Functional description:**

This command is used to set the arbitrary wave file name saved in the specified channel loading signal source.

<n>: channel number, n takes value as 1 or 2.

<filename> represents the file name, the name must be character string data type with double quotation marks, such as "test.bsv".

➤ **Return format:**

Query returns the arbitrary wave file name of the specified channel.

➤ **For example:**

AWG:CHANnel1:ARB "test.bsv"

Set the second arbitrary wave stored in channel 1 loading signal source.

AWG:CHANnel1:ARB? Query returns test.bsv

AWG:CHANnel<n>:MODulate:ARB:SOURce

➤ **Command format:**

AWG:CHANnel<n>:ARB:SOURce { INTernal|EXTernal }

AWG:CHANnel<n>:ARB:SOURce?

➤ **Functional description:**

This command is used to set modulating arbitrary wave source of the specified channel, which divided into internal and external.

<n>: channel number, n takes value as 1 or 2.

➤ **Return format:**

Query returns the arbitrary wave source of the specified channel.

➤ **For example:**

AWG:CHANnel1:ARB:SOURce INTernal

Set channel 1 arbitrary wave source to internal.

AWG:CHANnel1:ARB:SOURce?

Query returns INTERNAL

AWG:CHANnel<n>:MODulate:ARB:INDex

➤ **Command format:**

AWG:CHANnel<n>:ARB:INDex <index >

AWG:CHANnel<n>:ARB:INDex?

➤ **Functional description:**

This command is used to set modulating arbitrary wave sequency number stored in the specified channel loading signal source.

<index > represents modulating arbitrary wave sequency number.

<n>: channel number, n takes value as 1 or 2.

➤ **Return format:**

Query returns modulating arbitrary wave sequency number of the specified channel.

➤ **For example:**

AWG:CHANnel1:ARB:IND 2

Set the second arbitrary wave stored in channel 1 loading signal source.

AWG:CHANnel1:ARB:IND? Query returns 2.

AWG:CHANnel<n>:MODulate:ARB

➤ **Command format:**

AWG:CHANnel<n>:ARB <filename>

AWG:CHANnel<n>:ARB?

➤ **Functional description:**

This command is used to set modulating arbitrary wave file name saved in the specified channel loading signal source.

<n>: channel number, n takes value as 1 or 2.

<filename> represents the file name, the name must be character string data type with double quotation marks, such as "test.bsv".

➤ **Return format:**

Query returns modulating arbitrary wave file name of the specified channel.

➤ **For example:**

AWG:CHANnel1:ARB "test.bsv"

Set the second arbitrary wave stored in channel 1 loading signal source.

AWG:CHANnel1:ARB? Query returns test.bsv.

AWG:CHANnel<n>:ARB:PLAYmode

➤ **Command format:**

AWG:CHANnel<n>:ARB:PLAYmode {{1|ON}|{0|OFF}}

AWG:CHANnel<n>:ARB:PLAYmode?

➤ **Functional description:**

This command is used to set arbitrary wave play mode switch of the specified channel.

ON represents output with original data; OFF represents it can output by extract point.

<n>: channel number, n takes value as 1 or 2.

➤ **Return format:**

Query returns arbitrary wave play mode switch status of the specified channel. 0 represents OFF, 1 represents ON.

➤ **For example:**

AWG:CHANnel1:ARB:PLAYmode ON

Set channel 1 arbitray wave play with original data.

AWG:CHANnel1:ARB:PLAYmode? Query returns 1.

WARB Command

This command is used to write arbitrary wave file instruction, which including write configuration of fundamental arbitrary wave and modulating arbitrary wave.

AWG:WARB<n>:MODulate

➤ **Command format:**

AWG:WARB<n>:MODulate <arb file>

➤ **Functional description:**

This command is used to write modulating arbitrary wave, the maximum wave data is 8k points. Send this instruction first and then send arbitrary wave file data to signal source.

<arb file> represents arbitrary wave data. This instruction is only support .bsv format data.

➤ **For example:**

AWG:WARB1:MODulate Write channel 1 modulating arbitrary wave file.

AWG:WARB<n>:CARRier

➤ **Command format:**

AWG:WARB<n>:CARRier <arb file>

➤ **Functional description:**

This command is used to write fundamental arbitrary wave, the maximum wave data is 8k points. Send this instruction first and then send arbitrary wave file data to signal source.

<arb file> represents arbitrary wave data. This instruction is only support .bsv format data.

➤ **For example:**

AWG:WARB1:CARRier Write channel 1 fundamental arbitrary wave file.

LA Command

This command is used to operate digital channel.

:LA:STATe➤ **Command format:**

:LA:STATe {{1|ON}}|{0|OFF}}

:LA:STATe?

➤ **Functional description:**

This command is used to turn on/off LA function or query LA function status.

➤ **Return format:**

Query returns 1 or 0, it respectively represents ON or OFF.

➤ **For example:**

:LA:STATe ON Turn on LA function.

:LA:STATe? Query returns 1.

:LA:ACTive➤ **Command format:**

:LA:ACTive {<Dx> | CHANnel1 | CHANnel2 | OFF}

:LA:ACTive?

➤ **Functional description:**

This command is used to set or query the currently active channel or channel group.

<Dx>: {D0|D1|D2|D3|D4|D5|D6|D7|D8|D9|D10|D11|D12|D13|D14|D15}.

➤ **Return format:**

Query returns the currently active channel.

➤ **For example:**

:LA:ACTive D7 Set the currently active channel to D3.

:LA:ACTive? Query returns D3.

:LA:AUTOsort➤ **Command format:**

:LA:AUTOsort {{1|ON}}|{0|OFF}}

:LA:AUTOsort?

➤ **Functional description:**

Set the automatic arrange of the opened channel waveform on the screen.

OFF: Waveform on the screen is D0-D15 from top to bottom;

ON: Waveform on the screen is D15-D0 from top to bottom.

➤ **Return format:**

Query returns 1 or 0.

➤ **For example:**

:LA:AUTOsort ON Waveform on the screen is D15-D0 from top to bottom.

:LA:AUTOsort? Query returns 1.

:LA:DIGital<n>:DISPlay➤ **Command format:**

:LA:DIGital<n>:DISPlay { {1|ON} | {0|OFF} }

:LA:DIGital<n>:DISPlay?

➤ **Functional description:**

This command is used to turn on/off the specified digital channel or query the status of the specified digital channel.

<n>: integer digit 1~16,

it represents {D0|D1|D2|D3|D4|D5|D6|D7|D8|D9|D10|D11|D12|D13|D14|D15}.

It has 16 digital channels.

➤ **Return format:**

Query returns 1 or 0.

➤ **For example:**

:LA:DIGital4:DISPlay ON Turn on D3.

:LA:DIGital4:DISPlay? Query returns 1.

:LA:DIGital<n>:POSition➤ **Command format:**

:LA:DIGital<n>:POSition <position>

:LA:DIGital<n>:POSition?

➤ **Functional description:**

This command is used to set or query the display position of the specified digital channel waveform on the screen. It's only valid when the specified digital channel is opened.

<n>: integer digit 1~16,

it represents {D0|D1|D2|D3|D4|D5|D6|D7|D8|D9|D10|D11|D12|D13|D14|D15}.

<position>: integer

The waveform display mode is small: 0 -31.

The waveform display mode is medium: 0 -15.

The waveform display mode is large: 0 -7.

➤ **Return format:**

Query returns integer among 0-31, 0-15 or 0-7.

➤ **For example:**

:LA:DIGital3:POSition 6 Set the display position of D4 to 6.

:LA:DIGital3:POSition? Query returns 6.

:LA:DIGital<n>:LABel➤ **Command format:**

:LA:DIGital<n>:LABel <label>

:LA:DIGital<n>:LABel?

➤ **Functional description:**

This command is used to set or query the label of the specified digital channel.

<n>: integer digit 1~16,

it represents {D0|D1|D2|D3|D4|D5|D6|D7|D8|D9|D10|D11|D12|D13|D14|D15}.

<label>: ASCII character string, which includes English letter and number or it can includes several symbols.

➤ **Return format:**

Query returns the label of the specified digital channel in ASCII character string format.

➤ **For example:**

:LA:DIGital3:LABel "ACK" Set the label of D4 to ACK.

:LA:DIGital3:LABel? Query returns ACK.

:LA:POD<n>:DISPlay

➤ **Command format:**

:LA:POD<n>:DISPlay { {1|ON} | {0|OFF} }

:LA:POD<n>:DISPlay?

➤ **Functional description:**

This command is used to turn on/off the specified default channel group or query the status of the specified default channel group.

<n>: integer number 1~2, 1 represents (D0-D7) and 2 represents (D8-D15).

➤ **Return format:**

Query returns 1 or 0.

➤ **For example:**

:LA:POD1:DISPlay ON Turn on POD1 (D0 -D7).

:LA:POD1:DISPlay? Query returns 1.

:LA:POD<n>:THReshold

➤ **Command format:**

:LA:POD<n>:THReshold {<threshold>|TTL|ECL|PECL|CLDS|0V|5.0V|3.3V|2.5V|1.8V}

:LA:POD<n>:THReshold?

➤ **Functional description:**

This command is used to set or query the threshold of the specified default channel group. The default unit is V.

<n>: integer number 1~2, 1 represents (D0-D7) and 2 represents (D8-D15).

<threshold>: real model, -20.0V to +20.0V.

➤ **Return format:**

Query returns the threshold of the specified default channel group in scientific notation.

➤ **For example:**

:LA:POD1:THReshold 1.4 Set the threshold of POD1 (D0-D7) to 1.4 V.

:LA:POD1:THReshold? Query returns 1.400000E0.

:LA:SIZE➤ **Command format:**

:LA:SIZE {SMAL|LARGe|MEDIum}

:LA:SIZE?

➤ **Functional description:**

This command is used to set or query the display size of the opened channel waveform on the screen.

➤ **Return format:**

Query returns SMAL, LARGe or MEDIum.

➤ **For example:**

:LA:SIZE SMAL

Set the waveform display size to small.

:LA:SIZE?

Query returns SMAL.

:LA:TCALibrate➤ **Command format:**

:LA:TCALibrate <tcal>

:LA:TCALibrate?

➤ **Functional description:**

This command is used to set or query the delay calibrating time of the digital channel. The default unit is s.

<tcal>: real model, -100ns to 100ns.

Transmission delay of probe cable may cause greater error (zero offset) when use the oscilloscope to operating actual measuring. Zero offset is defined as the offset of the intersection of the waveform and the threshold level line with respect to the trigger position. User can set a delay time to calibrate the zero offset of the corresponding channel.

➤ **Return format:**

Query returns the delay calibrating time in scientific notation.

➤ **For example:**

:LA:TCALibrate 20ns

Set delay calibrating time to 20ns.

:LA:TCALibrate?

Query returns 2.000000E-8.

:LA:DELeTe➤ **Command format:**

:LA:DELeTe {GROup1|GROup2|GROup3|GROup4}

:LA:DELeTe?

➤ **Functional description:**

Cancel any one of group setting of 16 digital channels or cancel any one of group setting of GROup1-GROup4. This command can only cancel the group setting operation for digital channels or custom channel groups that have been grouped.

➤ **Return format:**

Query returns {GROup1|GROup2|GROup3|GROup4}.

- **For example:**

:LA:DELEte GROup1	Cancel the channel setting of GROup1.
:LA:DELEte?	Query returns GROup1.

:LA:GROup<n>:DISPlay

- **Command format:**

```
:LA:GROup<n>:DISPlay {{1|ON}|{0|OFF}}
```

```
:LA:GROup<n>:DISPlay?
```
- **Functional description:**

This command is used to turn on/off the specified digital channel.

<n>: integer number 1~4, it respectively represents GROup1, GROup2, GROup3 and GROup4.
- **Return format:**

Query returns 1 or 0.
- **For example:**

:LA:GROup1:DISPlay ON	Turn on GROup1.
:LA:GROup1:DISPlay?	Query returns 1.

:LA:GROup<n>:APPend

- **Command format:**

```
:LA:GROup<n>:APPend <digital0>[, digital1~digital15]
```
- **Functional description:**

This command is used to add channel for the specified custom group.

<n>: integer number 1~4, it respectively represents GROup1, GROup2, GROup3 and GROup4.

<digital>: it represents {D0|D1|D2|D3|D4|D5|D6|D7|D8|D9|D10|D11|D12|D13|D14|D15}.
- **For example:**

:LA:GROup1:APPend D0,D3	Add channel D0 and D3 for GROup1.
-------------------------	-----------------------------------

LA Bus

This command is used to set LA bus data and parallel decoding. It can only valid if the oscilloscope has this instruction.

:LA:BUS<n>:DISPlay

- **Command format:**

```
:LA:BUS<n>:DISPlay {{1|ON}|{0|OFF}}
```

```
:LA:BUS<n>:DISPlay?
```
- **Functional description:**

This command is used to turn on/off LA bus status.

<n>: integer data {1|2}, it respectively represents bus 1~2.
- **Return format:**

Query returns 1 or 0, it respectively represents ON or OFF.

➤ **For example:**

:LA:BUS1:DISPlay ON

Turn on LA bus 1 decoding status to display decoding waveform.

:LA:BUS1:DISPlay? Query returns 1.

:LA:BUS<n>:BASE

➤ **Command format:**

:LA:BUS<n>:BASE {ASCII|BINary|HEX|DEC|WAV}

:LA:BUS<n>:BASE?

➤ **Functional description:**

This command is used to set LA bus display format of the oscilloscope.

<n>: integer data {1|2}, it respectively represents bus 1~2.

➤ **Return format:**

Query returns {ASCII|BINary|HEX|DEC|WAV}.

➤ **For example:**

:LA:BUS1:BASE BIN

Set LA bus 1 decoding display in binary format.

:LA:BUS1:BASE? Query returns BINary.

:LA:BUS<n>:EVENT

➤ **Command format:**

:LA:BUS<n>:EVENT { {1|ON}| {0|OFF} }

:LA:BUS<n>:EVENT?

➤ **Functional description:**

This command is used to turn on/off LA bus event list.

<n>: integer data {1|2}, it respectively represents bus 1~2.

➤ **Return format:**

Query returns 1 or 0, it respectively represents ON or OFF.

➤ **For example:**

:LA:BUS1:EVENT ON Turn on LA bus 1 event list.

:LA:BUS1:EVENT? Query returns 1.

:LA:BUS<n>:DATA?

➤ **Command format:**

:LA:BUS<n>:DATA?

➤ **Functional description:**

This command is used to read LA decoding event list data of the oscilloscope.

➤ **Return format:**

Query returns LA decoding event list data, returned data is conform with This command is used to

configure the system setting data. <setup_data> is conform to the [Appendix 2: IEEE 488.2 binary data format](#).

➤ **For example:**

:LA:BUS1:DATA? Query returns parallel decoding event list of data bus 1:

#90000000089PAR,

ID,BUS1DATA,

0,0xFF

1,0xFE

2,0xF3

3,0xF5

4,0xF6

PAR present parallel decoding, the event table data in CSV format followed behind. The specified format of the event table data is automatically adapted by different devices. The data are separated by commas and will automatically line wrap according to the decoding list. Data value is relate to the setting system.

:LA:BUS<n>:SLOPe

➤ **Command format:**

:LA:BUS<n>:SLOPe {POSitive|NEGative}

:LA:BUS<n>:SLOPe?

➤ **Functional description:**

This command is used to set edge type of clock channel when the oscilloscope's LA bus sampling the data channel.

<n>: integer data {1|2}, it respectively represents bus 1~2.

➤ **Return format:**

Query returns {POSitive|NEGative}.

➤ **For example:**

:LA:BUS1:SLOPe POSitive Set LA bus 1 clock source edge to rising edge.

:LA:BUS1:SLOPe? Query returns POSitive.

:LA:BUS<n>:CLK

➤ **Command format:**

:LA:BUS<n>:CLK {<Dx> | CHANnel1 | CHANnel2 | OFF}

:LA:BUS<n>:CLK?

➤ **Functional description:**

This command is used to set LA bus clock source of the oscilloscope.

<n>: integer data {1|2}, it respectively represents bus 1~2.

<Dx>: {D0|D1|D2|D3|D4|D5|D6|D7|D8|D9|D10|D11|D12|D13|D14|D15}.

➤ **Return format:**

Query returns {<Dx> | CHANnel1 | CHANnel2 | OFF}.

➤ **For example:**

:LA:BUS1:CLK D0 Set LA bus 1 clock source to D0 channel.

:LA:BUS1:CLK? Query returns D0.

:LA:BUS<n>:POLarity➤ **Command format:**

```
:LA:BUS<n>:POLarity {NEGative|POSitive}
```

```
:LA:BUS<n>:POLarity?
```

➤ **Functional description:**

This command is used to set LA bus bit order of the oscilloscope, that is data polarity.

<n>: integer data {1|2}, it respectively represents bus 1~2.

NEGative represents bit order is from high to low; POSitive represents bit order from low to high.

➤ **Return format:**

Query returns {NEGative|POSitive}.

➤ **For example:**

```
:LA:BUS1:POLarity POSitive      Set LA bus 1 data bit order from low to high.
```

```
:LA:BUS1:POLarity?              Query returns POSitive.
```

:LA:BUS<n>:NREJect➤ **Command format:**

```
:LA:BUS<n>:NREJect { {1|0N} | {0|0FF} }
```

```
:LA:BUS<n>:NREJect?
```

➤ **Functional description:**

This command is used to turn on/off LA bus parallel decoding noise reject function of the oscilloscope.

<n>: integer data {1|2}, it respectively represents bus 1~2.

➤ **Return format:**

Query returns 1 or 0, it respectively represents ON or OFF.

➤ **For example:**

```
:LA:BUS1:NREJect ON
```

Turn on LA bus parallel decoding noise reject function.

```
:LA:BUS1:NREJect?              Query returns 1.
```

:LA:BUS<n>:NRTime➤ **Command format:**

```
:LA:BUS<n>:NRTime <time>
```

```
:LA:BUS<n>:NRTime?
```

➤ **Functional description:**

This command is used to set LA bus parallel decoding noise reject time. The default unit is s.

<n>: integer data {1|2}, it respectively represents bus 1~2.

➤ **Return format:**

Query returns noise reject time, unit is s.

➤ **For example:**

```
:LA:BUS1:NRTime 50us
```

Set set LA bus parallel decoding noise reject time to 50us.

:LA:BUS1:NRTIME? Query returns 5.000e-005.

:LA:BUS<n>:SOURce

➤ **Command format:**

:LA:BUS<n>:SOURce <digital0>[, digital1~ digital15, CHANnel1, CHANnel2]

:LA:BUS<n>:SOURce?

➤ **Functional description:**

This command is used to set the currently selected channel source of LA bus parallel decoding of the oscilloscope.

<n>: integer data {1|2}, it respectively represents bus 1~2.

<digital>: it represents {D0|D1|D2|D3|D4|D5|D6|D7|D8|D9|D10|D11|D12|D13|D14|D15}.

➤ **Return format:**

Query returns the currently selected channel source.

➤ **For example:**

:LA:BUS1:SOURce D0,D3,CHANnel1

LA bus 1 channel source selects D0, D3 and channe 1.

:LA:BUS1:SOURce? Query returns D0,D3,CHANnel1.

BODe Command

This command is used to set bode diagram function. It is only valid if the oscilloscope has this instruction.

:BODe:APPLY

➤ **Command format:**

:BODe:APPLY {{1|ON}|{0|OFF}}

:BODe:APPLY?

➤ **Functional description:**

This command is used to turn on/off bode diagram of the oscilloscope.

➤ **Return format:**

Query returns lock status of full keyboard. 0 represents the full keyboard is not open, 1 represents the full keyboard is opened.

➤ **For example:**

:BODe:APPLY ON Turn on bode diagram.

:BODe:APPLY?

Query returns 1, it represents the full keyboard is opened.

:BODe:EVENT

➤ **Command format:**

:BODe:EVENT {{1|ON}|{0|OFF}}

:BODe:EVENT?

➤ **Functional description:**

This command is used to turn on/off bode diagram event list of the oscilloscope.

➤ **Return format:**

Query returns bode diagram event list status of bode diagram. 0 represents bode diagram event list is not open. 1 represents bode diagram event list is opened.

➤ **For example:**

:BODe:EVENT ON

Turn on bode diagram event list.

:BODe:EVENT?

Query returns 1, it represents bode diagram event list is opened.

:BODe:EVENT:DATA?

➤ **Command format:**

:BODe:DATA?

➤ **Functional description:**

This command is used to query bode diagram event list data.

➤ **Return format:**

Query returns bode diagram event list data, returned data is conform with [Appendix 2: IEEE 488.2 binary data format](#).

➤ **For example:**

:BODe:EVENT:DATA? Query returns bode diagram event list data:

#9000000727BODE,

index,Freq,AMP(Vpp),Gain(dB),Phase(\hat{A}°),

1,3.700000e+03,3.000000e+00,-1.039986e+02,8.887821e+01,

2,8.784684e+03,3.000000e+00,-9.819112e+01,-7.619118e+01,

3,2.085694e+04,3.000000e+00,-9.908194e+01,-6.782645e+01,

:BODe:SWEp:MODE

➤ **Command format:**

:BODe:SWEp:MODE { SINGLE | CONTInue}

:BODe:SWEp:MODE?

➤ **Functional description:**

This command is used to set sweep mode of bode diagram. SINGLE represents sweep in single time; CONTInue represents sweep in continuously.

➤ **Return format:**

Query returns { SINGLE | CONTInue}.

➤ **For example:**

:BODe:SWEp:MODE SINGLE

Set sweep mode of bode diagram to SINGLE.

:BODe:SWEp:MODE?

Query returns SINGLE.

:BODe:SWEp:POINts

➤ **Command format:**

:BODe:SWEp:POINts <points>

:BODe:SWEp:POINts?

➤ **Functional description:**

This command is used to set sweep point of bode diagram. <points> can take value from 1~1000.

- **Return format:**

Query returns sweep point.

- **For example:**

:BODE:SWEEP:POINTS 1000

Set sweep point of bode diagram to 1000.

:BODE:SWEEP:POINTS?

Query returns 1000.

:BODE:SWEEP:FREQUENCY:START

- **Command format:**

:BODE:SWEEP:FREQUENCY:START <freq>

:BODE:SWEEP:FREQUENCY:START?

- **Functional description:**

Set sweep start frequency of bode diagram.

- **Return format:**

Query returns sweep start frequency of bode diagram, unit is Hz.

- **For example:**

:BODE:SWEEP:FREQUENCY:START 1 kHz

Set start frequency to 1 kHz.

:BODE:SWEEP:FREQUENCY:START?

Query returns 1.000e003.

:BODE:SWEEP:FREQUENCY:END

- **Command format:**

:BODE:SWEEP:FREQUENCY:END <freq>

:BODE:SWEEP:FREQUENCY:END?

- **Functional description:**

Set sweep cut-off frequency of bode diagram.

- **Return format:**

Query returns cut-off frequency of bode diagram, unit is Hz.

- **For example:**

:BODE:SWEEP:FREQUENCY:END 1 kHz

Set cut-off frequency to 1 kHz.

:BODE:SWEEP:FREQUENCY:END?

Query returns 1.000e003.

:BODE:AMPLITUDE:MODE

- **Command format:**

:BODE:AMPLITUDE:MODE { FIXEd | VARiable }

:BODE:AMPLITUDE:MODE?

- **Functional description:**

This command is used to set amplitude mode of bode diagram. FIXEd represents the amplitude mode is fixed; VARiable represents the amplitude mode is variable.

- **Return format:**

Query returns { FIXEd | VARiable }.

- **For example:**

:BODE:AMPLITUDE:MODE FIXEd

Set amplitude mode of bode diagram to FIXEd.

:BODE:AMPLITUDE:MODE?

Query returns FIXEd.

:BODe:AMPLitude<n>➤ **Command format:**

:BODe:AMPLitude<n> <amp>

:BODe:AMPLitude<n>?

➤ **Functional description:**

This command is used to set amplitude of bode diagram.

<n> can take value from 1-8; <amp> can take value from 10mV~3V.

➤ **Return format:**

Query returns 1.000e-003, unit is V.

➤ **For example:**

:BODe:AMPLitude1 10mV

set amplitude 1 of bode diagram to 10 mV.

:BODe:AMPLitude1?

Query returns 1.000e-003.

:BODe:SOURce:OFFSet➤ **Command format:**

:BODe:SOURce:OFFSet <offset>

:BODe:SOURce:OFFSet?

➤ **Functional description:**

This command is used to set DC offset of bode diagram source.

<offset> can take value from 0V~1V.

➤ **Return format:**

Query returns DC offset of bode diagram source, unit is V.

➤ **For example:**

:BODe:SOURce:OFFSet 10mV

Set DC offset of bode diagram source to 10 mV.

:BODe:SOURce:OFFSet?

Query returns 1.000e-003.

:BODe:SOURce:LOAD➤ **Command format:**

:BODe:SOURce:LOAD {500HM|HIGH}

:BODe:SOURce:LOAD?

➤ **Functional description:**

This command is used to set impedance of bode diagram source.

500HM represents the impedance is 50Ω; HIGH represents the impedance is high impedance.

➤ **Return format:**

Query returns {500HM|HIGH}.

➤ **For example:**

:BODe:SOURce:LOAD HIGH

Set impedance of bode diagram source to high impedance.

:BODe:SOURce:LOAD?

Query returns HIGH.

:BODe:DUT:INPut➤ **Command format:**

:BODE:DUT:INPut {CHANnel1| CHANnel2| CHANnel3| CHANnel4}

:BODE:DUT:INPut?

➤ **Functional description:**

This command is used to set DUT input channel of bode diagram.

➤ **Return format:**

Query returns {CHANnel1| CHANnel2| CHANnel3| CHANnel4}.

➤ **For example:**

:BODE:DUT:INPut CHANnel1

Set DUT input channel of bode diagram to channel 1.

:BODE:DUT:INPut? Query returns CHANnel1.

:BODE:DUT:OUTPut

➤ **Command format:**

:BODE:DUT:OUTPut {CHANnel1| CHANnel2| CHANnel3| CHANnel4}

:BODE:DUT:OUTPut?

➤ **Functional description:**

This command is used to set DUT output channel of bode diagram.

➤ **Return format:**

Query returns {CHANnel1| CHANnel2| CHANnel3| CHANnel4}.

➤ **For example:**

:BODE:DUT:OUTPut CHANnel1

Set DUT output channel of bode diagram to channel 1.

:BODE:DUT:OUTPut? Query returns CHANnel1.

:BODE:GAIN:DISPlay

➤ **Command format:**

:BODE:GAIN:DISPlay {{1| ON}|{0| OFF}}

:BODE:GAIN:DISPlay?

➤ **Functional description:**

This command is used to turn on/off gain display of bode diagram.

➤ **Return format:**

Query returns gain display status of bode diagram. 0 represents gain display is not open. 1 represents gain display is opened.

➤ **For example:**

:BODE:GAIN:DISPlay ON Turn on gain display of bode diagram.

:BODE:GAIN:DISPlay?

Query returns 1, it represents gain display is opened.

:BODE:GAIN:SCALe

➤ **Command format:**

:BODE:GAIN:SCALe <scale>

:BODE:GAIN:SCALe?

➤ **Functional description:**

This command is used to set gain scale of bode diagram.

<scale> can take value from 1~500dB.

➤ **Return format:**

Query returns gain scale of bode diagram, unit is dB.

➤ **For example:**

:BODe:GAIN:SCALe 10

Set gain scale of bode diagram to 10 dB.

:BODe:GAIN:SCALe?

Query returns 1.000e001.

:BODe:GAIN:OFFSet

➤ **Command format:**

:BODe:GAIN:OFFSet <offset>

:BODe:GAIN:OFFSet?

➤ **Functional description:**

This command is used to set gain offset of bode diagram.

<offset> can take value from -250dB~250dB.

➤ **Return format:**

Query returns gain offset of bode diagram, unit is dB.

➤ **For example:**

:BODe:GAIN:OFFSet 10

Set gain offset of bode diagram to 10 dB.

:BODe:GAIN:OFFSet?

Query returns 1.000e001.

:BODe:PHASe:DISPlay

➤ **Command format:**

:BODe:PHASe:DISPlay {{1|ON}|{0|OFF}}

:BODe:PHASe:DISPlay?

➤ **Functional description:**

This command is used to turn on/off phase display of bode diagram.

➤ **Return format:**

Query returns phase display status of bode diagram. 0 represents phase display is not open. 1 represents phase display is opened.

➤ **For example:**

:BODe:PHASe:DISPlay ON

Turn on phase display of bode diagram.

:BODe:PHASe:DISPlay?

Query returns 1, it represents phase display is opened.

:BODe:PHASe:SCALe

➤ **Command format:**

:BODe:PHASe:SCALe <scale>

:BODe:PHASe:SCALe?

➤ **Functional description:**

This command is used to set phase scale of bode diagram.

<scale> can take value from 1°~180°.

➤ **Return format:**

Query returns phase scale of bode diagram, unit is $^{\circ}$.

➤ **For example:**

:BODE:PHASe:SCALe 10

Set phase scale of bode diagram to 10° .

:BODE:PHASe:SCALe?

Query returns 1.000e001.

:BODE:PHASe:OFFSet

➤ **Command format:**

:BODE:PHASe:OFFSet <offset>

:BODE:PHASe:OFFSet?

➤ **Functional description:**

This command is used to set phase offset of bode diagram.

<offset> can take value from -180° ~ 180° .

➤ **Return format:**

Query returns phase offset of bode diagram, unit is $^{\circ}$.

➤ **For example:**

:BODE:PHASe:OFFSet 10

Set phase offset of bode diagram to 10° .

:BODE:PHASe:OFFSet?

Query returns 1.000e001.

:BODE:DISPlay:AUTO

➤ **Command format:**

:BODE:DISPlay:AUTO

➤ **Functional description:**

This command is used to set automatic display of bode diagram.

➤ **For example:**

:BODE:DISPlay:AUTO

Automatic display bode diagram.

:BODE:FREQuency:STARt

➤ **Command format:**

:BODE:FREQuency:STARt <freq>

:BODE:FREQuency:STARt?

➤ **Functional description:**

This command is used to set start frequency of bode diagram display.

➤ **Return format:**

Query returns sweep start frequency of bode diagram, unit is Hz.

➤ **For example:**

:BODE:FREQuency:STARt 1 kHz

Set start frequency of bode diagram display to 1 kHz.

:BODE:FREQuency:STARt?

Query returns 1.000e003.

:BODE:FREQuency:END

➤ **Command format:**

:BODE:SWEEp:FREQuency:END <freq>

:BODE:SWEep:FREQuency:END?

➤ **Functional description:**

This command is used to set cut-off frequency of bode diagram display.

➤ **Return format:**

Query returns cut-off frequency of bode diagram display, unit is Hz.

➤ **For example:**

:BODE:FREQuency:END 1 kHz

Set cut-off frequency of bode diagram display to 1 kHz.

:BODE:FREQuency:END? Query returns 1.000e003.

:BODE:CURSor

➤ **Command format:**

:BODE:CURSor {{1|ON}|{0|OFF}}

:BODE:CURSor?

➤ **Functional description:**

This command is used to turn on/off cursor function of bode diagram.

➤ **Return format:**

Query returns cursor function status of bode diagram. 0 represents cursor function is not open. 1 represents cursor function is opened.

➤ **For example:**

:BODE:CURSor ON Turn on cursor function of bode diagram.

:BODE:CURSor?

Query returns 1, it represents cursor function is opened.

:BODE:CURSor:MODE

➤ **Command format:**

:BODE:CURSor:MODE {INdependent|TRACking}

:BODE:CURSor:MODE?

➤ **Functional description:**

This command is used to set cursor mode of bode diagram, which is INdependent and TRACking.

➤ **Return format:**

Query returns cursor mode of bode diagram.

➤ **For example:**

:BODE:CURSor:MODE TRACking

Set cursor mode of bode diagram to TRACking.

:BODE:CURSor:MODE? Query returns 1, it represents cursor mode is opened.

Explanation of Programming

This chapter is to describe troubleshooting in process of programming. If you meet any of the following problems, please handle them according to the related instructions.

Programming Preparation

Programming preparation is only applicable for using Visual Studio and LabVIEW development tools to programming under Windows operating system.

Firstly, user need to confirm that whether NI -VISA libray is installed (it can be download from the website

<https://www.ni.com/en-ca/support/downloads/drivers/download.ni-visa.html>).

In this manual, the default installment path is C:\Program Files\IVI Foundation\VISA.

Build communication with PC via USB or LAN interface of the instrument, use USB data line to connect USB DEVICE port on the rear panel of the instrument with USB port of PC, or use LAN data line to connect LAN port on the rear panel of the instrument with LAN port of PC.

VISA Programming Example

There are some example in this section. Throught these examples, user can know how to use VISA, and it can combined with the command of programming manual to realize the control of the instrument. With these examples, user can develop more applications.

VC++ Example

- Environment: Window system, Visual Studio
 - Decription: Access the instrument via USBTMC and TCP/IP, and send "*IDN?" command on NI-VISA to query the device information.
 - Steps:
 1. Open Visual Studio software to create a new VC++ win32 console project.
 2. Set project environment that can adjust NI-VISA libray, which are static library and dynamic library.
- a) Static library:
In NI-VISA installment path to find file visa.h, visatype.h and visa32.lib and copy them to the root path of VC++ project and add it to the project. Add two lines of code into file projectname.cpp as follows.

```
#include "visa.h"  
#pragma comment(lib, "visa32.lib")
```

- b) Dynamic library:
Press "project>>properties", select "c/c++---General" in attribute dialog on the leftside, set the value of "Additional Include Directories" as the installment path of NI-VIS (such as C:\ProgramFiles\IVI Foundation\VISA\WinNT\include), as shown in the following figure.

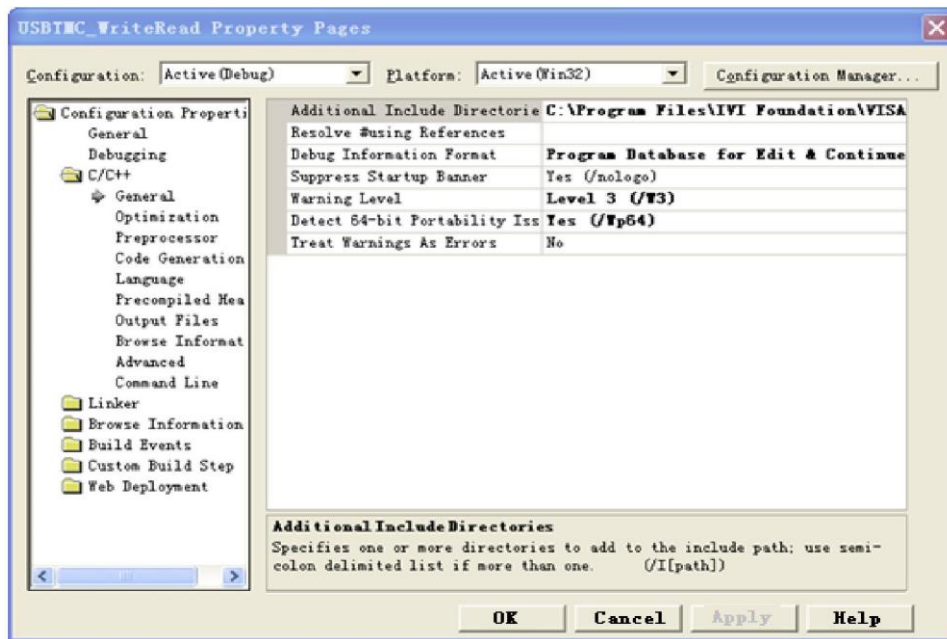

Select "Linker-General" in attribute dialog on the leftside, set the value of "Additional Library Directories" as the installment path of NI-VIS (such as C:\Program Files\IVI Foundation\VISAWinNT\include), as shown in the following figure.

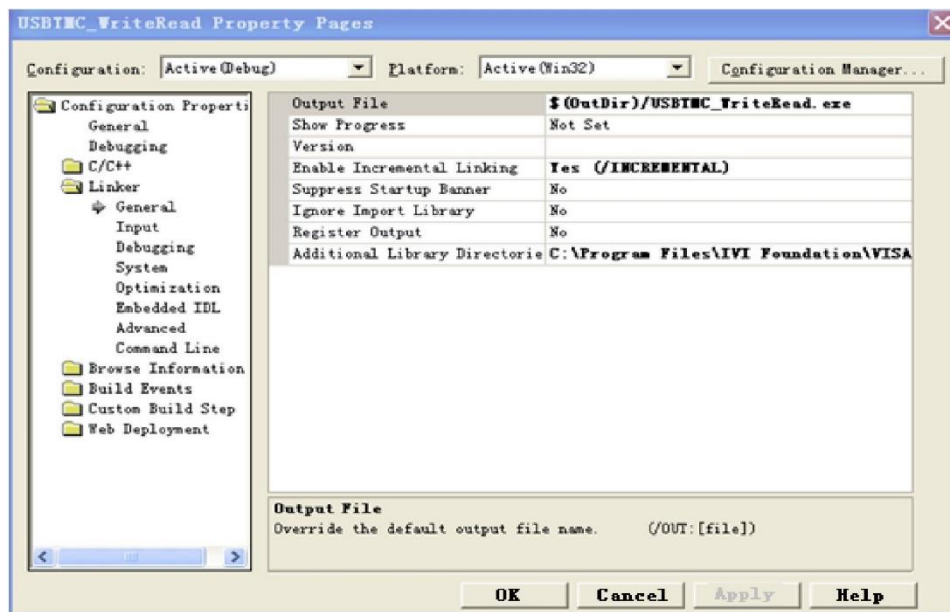

Select "Linker-Command Line" in attribute dialog on the leftside, set the value of "Additional" as visa32.lib, as shown in the following figure.

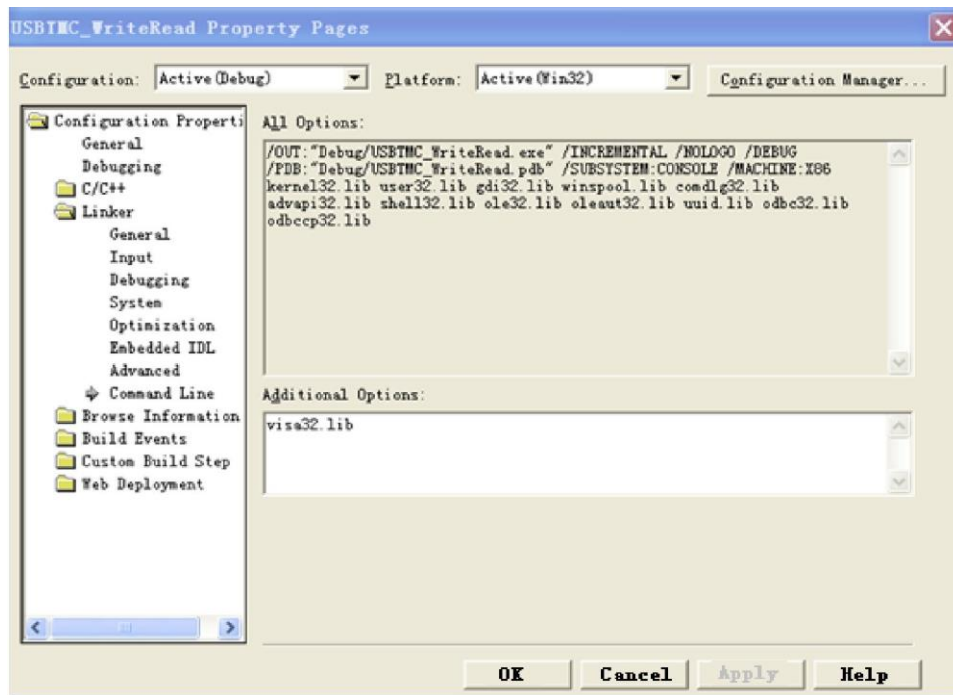

Add file visa.h in projectname.cpp file

```
#include <visa.h>
```

1. Source code:

a) USBTMC Example

```
int usbtmc_test()
{ /** This code demonstrates sending synchronous read & write commands
 * to an USB Test & Measurement Class (USBTMC) instrument using NI-VISA
 * The example writes the "*IDN?\n" string to all the USBTMC
 * devices connected to the system and attempts to read back
 * results using the write and read functions.
 * Open Resource Manager
 * Open VISA Session to an Instrument
 * Write the Identification Query Using viPrintf
 * Try to Read a Response With viScanf
 * Close the VISA Session*/
ViSession defaultRM;
ViSession instr;
ViUInt32 numInstrs;
ViFindList findList;
ViStatus status;
char instrResourceString[VI_FIND_BUFLLEN];
unsigned char buffer[100];
int i;
status = viOpenDefaultRM(&defaultRM);
if (status < VI_SUCCESS)
```

```

{
    printf("Could not open a session to the VISA Resource Manager!\n");
    return status;
}
/*Find all the USB TMC VISA resources in our system and store the number of resources in the system in numInstrs.*/
status = viFindRsrc(defaultRM, "USB?*INSTR", &findList, &numInstrs, instrResourceString);
if (status<VI_SUCCESS)
{
    printf("An error occurred while finding resources. \nPress Enter to continue.");
    fflush(stdin);
    getchar();
    viClose(defaultRM);
    return status;
}
/** Now we will open VISA sessions to all USB TMC instruments.
*   We must use the handle from viOpenDefaultRM and we must
*   also use a string that indicates which instrument to open. This
*   is called the instrument descriptor. The format for this string
*   can be found in the function panel by right clicking on the
*   descriptor parameter. After opening a session to the
*   device, we will get a handle to the instrument which we
*   will use in later VISA functions. The AccessMode and Timeout
*   parameters in this function are reserved for future
*   functionality. These two parameters are given the value VI_NULL. */
for (i = 0; i < int(numInstrs); i++)
{
    if (i > 0)
    {
        viFindNext(findList, instrResourceString);
    }
    status = viOpen(defaultRM, instrResourceString, VI_NULL, VI_NULL, &instr);
    if (status < VI_SUCCESS)
    {
        printf("Cannot open a session to the device %d. \n", i + 1);
        continue;
    }
    /** At this point we now have a session open to the USB TMC instrument.
    *We will now use the viPrintf function to send the device the string "**IDN?\n",
    *asking for the device's identification. */
    char * cmmnd = "**IDN?\n";
    status = viPrintf(instr, cmmnd);
    if (status < VI_SUCCESS)
    {
        printf("Error writing to the device %d. \n", i + 1);
    }
}

```

```

        status = viClose(instr);
        continue;
    }
    /** Now we will attempt to read back a response from the device to
    *the identification query that was sent. We will use the viScanf
    *function to acquire the data.
    *After the data has been read the response is displayed. */
    status = viScanf(instr, "%t", buffer);
    if (status < VI_SUCCESS)
    {
        printf("Error reading a response from the device %d. \n", i + 1);
    }
    else
    {
        printf("\nDevice %d: %s\n", i + 1, buffer);
    }
    status = viClose(instr);
}
/**Now we will close the session to the instrument using viClose. This operation frees all
system resources.*/
status = viClose(defaultRM);
printf("Press Enter to exit.");
fflush(stdin);
getchar();
return 0;
}

int _tmain(int argc, _TCHAR* argv[ ])
{
    usbtmc_test();
    return 0;
}

```

b) TCP/IP Example

```

int tcp_ip_test(char *pIP)
{
    char outputBuffer[VI_FIND_BUFLLEN];
    ViSession defaultRM, instr;
    ViStatus status;
    /** First we will need to open the default resource manager. */
    status = viOpenDefaultRM(&defaultRM);
    if (status < VI_SUCCESS)
    {
        printf("Could not open a session to the VISA Resource Manager!\n");
    }
}

```

```

    }
    /* Now we will open a session via TCP/IP device */
    char head[256] = "TCPIP0::";
    char tail[ ] = "::inst0::INSTR";
    strcat(head, pIP);
    strcat(head, tail);
    status = viOpen(defaultRM, head, VI_LOAD_CONFIG, VI_NULL, &instr);
    if (status < VI_SUCCESS)
    {
        printf("An error occurred opening the session\n");
        viClose(defaultRM);
    }
    status = viPrintf(instr, "**idn?\n");
    status = viScanf(instr, "%t", outputBuffer);
    if (status < VI_SUCCESS)
    {
        printf("viRead failed with error code: %x \n", status);
        viClose(defaultRM);
    }
    else
    {
        printf("\nMessage read from device: %*s\n", 0, outputBuffer);
    }
    status = viClose(instr);
    status = viClose(defaultRM);
    printf("Press Enter to exit.");
    fflush(stdin);
    getchar();
    return 0;
}

int _tmain(int argc, _TCHAR* argv[ ])
{
    printf("Please input IP address:");
    char ip[256];
    fflush(stdin);
    gets(ip);
    tcp_ip_test(ip);
    return 0;
}

```

C# Example

- Environment: Window system, Visual Studio
- Description: Access the instrument via USBTMC and TCP/IP, and send "**IDN?" command on NI-VISA

to query the device information.

➤ Steps:

1. Open Visual Studio software and create a new C# console project.
2. Add C# quote Ivi.Visa.dll and NationalInstruments.Visa.dll of VISA.
3. Source code:
 - a) USBTMC Example

```
class Program
{
    void usbtmc_test()
    {
        using (var rmSession = new ResourceManager())
        {
            var resources = rmSession.Find("USB?*INSTR");
            foreach (string s in resources)
            {
                try
                {
                    var mbSession = (MessageBasedSession)rmSession.Open(s);
                    mbSession.RawIO.Write("**IDN?\n");
                    System.Console.WriteLine(mbSession.RawIO.ReadString());
                }
                catch (Exception ex)
                {
                    System.Console.WriteLine(ex.Message);
                }
            }
        }
    }

    void Main(string[] args)
    {
        usbtmc_test();
    }
}
```

b) TCP/IP Example

```
class Program
{
    void tcp_ip_test(string ip)
    {
        using (var rmSession = new ResourceManager())
        {
            try
```

```

    {
        var resource = string.Format("TCPIP0::{0}::inst0::INSTR", ip);
        var mbSession = (MessageBasedSession)rmSession.Open(resource);
        mbSession.RawIO.Write("**IDN?\n");
        System.Console.WriteLine(mbSession.RawIO.ReadString());
    }
    catch (Exception ex)
    {
        System.Console.WriteLine(ex.Message);
    }
}

void Main(string[] args)
{
    tcp_ip_test("192.168.20.11");
}
}

```

VB Example

- Environment: Window system, Microsoft Visual Basic 6.0.
- Description: Access the instrument via USBTMC and TCP/IP, and send "**IDN?" command on NI-VISA to query the device information.
- Steps:
 1. Open Visual Basic software and create a new standard application program project.
 2. Set the project environment that can adjust NI-VISA library, press Existing tab of Project>>Add Existing Item, in file "include" of NI-VISA installation path to find file visa32.bas and add this file, as shown in the following figure.

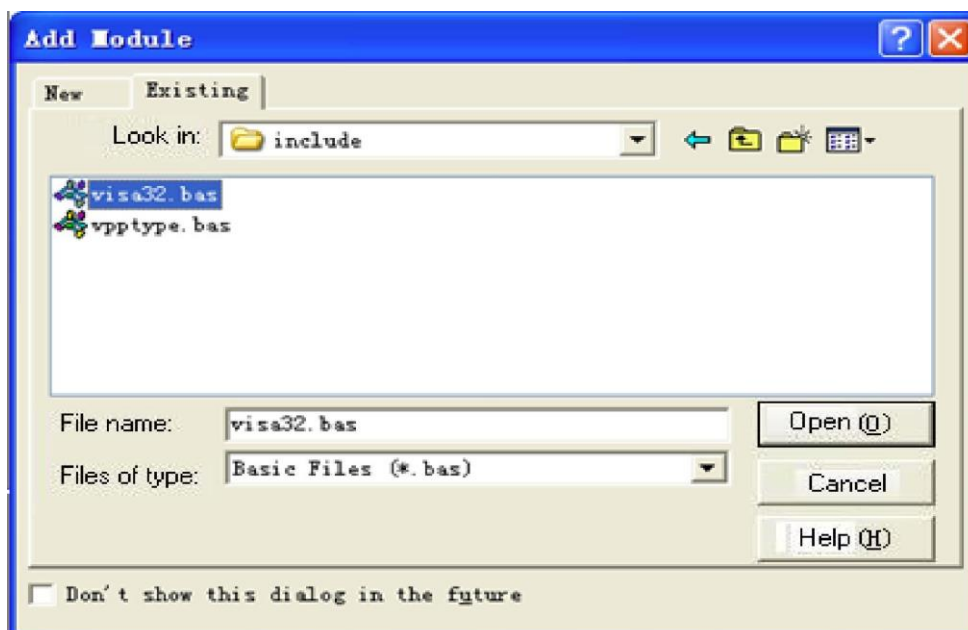

3. Source code:

a) USBTMC Example

```

PrivateFunction usbtmc_test() AsLong
' This code demonstrates sending synchronous read & write commands
' to an USB Test & Measurement Class(USBTMC) instrument using NI-VISA
' The example writes the "*IDN?\n" string to all the USBTMC
' devices connected to the system and attempts to read back
' results using the write and read functions.
' The general flow of the code is
' Open Resource Manager
' Open VISA Session to an Instrument
' Write the Identification Query Using viWrite
' Try to Read a Response With viRead
' Close the VISA Session

Const MAX_CNT = 200
Dim defaultRM AsLong
Dim instrsesn AsLong
Dim numInstrs AsLong
Dim findList AsLong
Dim retCount AsLong
Dim status AsLong
Dim instrResourceString AsString *VI_FIND_BUFLEN
Dim Buffer AsString * MAX_CNT
Dim i AsInteger

' First we must call viOpenDefaultRM to get the manager
' handle. We will store this handle in defaultRM.
status = viOpenDefaultRM(defaultRM)
If(status < VI_SUCCESS) Then
    resultTxt.Text = "Could not open a session to the VISA Resource Manager!"
    usbtmc_test = status
ExitFunction
EndIf

' Find all the USB TMC VISA resources in our system and store the
' number of resources in the system in numInstrs.
status = viFindRsrc(defaultRM, "USB?*INSTR", findList, numInstrs, instrResourceString)
If(status < VI_SUCCESS) Then
    resultTxt.Text = "An error occurred while finding resources."
    viClose(defaultRM)
    usbtmc_test = status
ExitFunction
EndIf

```



```

' Now we will open VISA sessions to all USB TMC instruments.
' We must use the handle from viOpenDefaultRM and we must
' also use a string that indicates which instrument to open. This
' is called the instrument descriptor. The format for this string
' can be found in the function panel by right clicking on the
' descriptor parameter. After opening a session to the
' device, we will get a handle to the instrument which we
' will use in later VISA functions. The AccessMode and Timeout
' parameters in this function are reserved for future
' functionality. These two parameters are given the value VI_NULL.
For i = 0 To numInstrs
If (i > 0) Then
    status = viFindNext(findList, instrResourceString)
EndIf
    status = viOpen(defaultRM, instrResourceString, VI_NULL, VI_NULL, instrsesn)
If (status < VI_SUCCESS) Then
    resultTxt.Text = "Cannot open a session to the device " + CStr(i + 1)
GoTo NextFind
EndIf

' At this point we now have a session open to the USB TMC instrument.
' We will now use the viWrite function to send the device the string "**IDN?",
' asking for the device's identification.
status = viWrite(instrsesn, "**IDN?", 5, retCount)
If (status < VI_SUCCESS) Then
    resultTxt.Text = "Error writing to the device."
    status = viClose(instrsesn)
GoTo NextFind
EndIf

' Now we will attempt to read back a response from the device to
' the identification query that was sent. We will use the viRead
' function to acquire the data.
' After the data has been read the response is displayed.
status = viRead(instrsesn, Buffer, MAX_CNT, retCount)
If (status < VI_SUCCESS) Then
    resultTxt.Text = "Error reading a response from the device." + CStr(i + 1)
Else
    resultTxt.Text = "Read from device: " + CStr(i + 1) + " " + Buffer
EndIf
    status = viClose(instrsesn)
Next i

' Now we will close the session to the instrument using

```

```
' viClose. This operation frees all system resources.
```

```
status = viClose(defaultRM)
```

```
usbTmc_test = 0
```

```
EndFunction
```

b) TCP/IP Example

```
PrivateFunction tcp_ip_test(ByVal ip AsString) AsLong
```

```
Dim outputBuffer AsString * VI_FIND_BUFLEN
```

```
Dim defaultRM AsLong
```

```
Dim instrsesn AsLong
```

```
Dim status AsLong
```

```
Dim count AsLong
```

```
' First we will need to open the default resource manager.
```

```
status = viOpenDefaultRM(defaultRM)
```

```
If (status < VI_SUCCESS) Then
```

```
    resultTxt.Text = "Could not open a session to the VISA Resource Manager!"
```

```
    tcp_ip_test = status
```

```
ExitFunction
```

```
EndIf
```

```
' Now we will open a session via TCP/IP device
```

```
status = viOpen(defaultRM, "TCPIP0::" + ip + "::inst0::INSTR", VI_LOAD_CONFIG, VI_NULL, instrsesn)
```

```
If (status < VI_SUCCESS) Then
```

```
    resultTxt.Text = "An error occurred opening the session"
```

```
    viClose(defaultRM)
```

```
    tcp_ip_test = status
```

```
ExitFunction
```

```
EndIf
```

```
status = viWrite(instrsesn, "*IDN?", 5, count)
```

```
If (status < VI_SUCCESS) Then
```

```
    resultTxt.Text = "Error writing to the device."
```

```
EndIf
```

```
    status = viRead(instrsesn, outputBuffer, VI_FIND_BUFLEN, count)
```

```
If (status < VI_SUCCESS) Then
```

```
    resultTxt.Text = "Error reading a response from the device." + CStr(i + 1)
```

```
Else
```

```
    resultTxt.Text = "read from device:" + outputBuffer
```

```
EndIf
```

```
    status = viClose(instrsesn)
```

```
    status = viClose(defaultRM)
```

```
    tcp_ip_test = 0
```

```
EndFunction
```

LabVIEW Example

- Environment: Window system, LabVIEW
- Description: Access the instrument via USBTMC and TCP/IP, and send "*IDN?" command on NI-VISA to query the device information.
- Steps:
 1. Open LabVIEW software and create a VI file.
 2. Add control, press the front panel interface, select and add VISA resource name, error input, error output and partial identifier on control flow diagram.
 3. Open diagram, press VISA resource name and then select and add function VISA Write, VISA Read, VISA Open and VISA Close on pop-out menu.
 4. VI open a VISA session of USBTMC device and wrote *IDN? command and read back the response value. When all communication is complete, VI will close the VISA session.

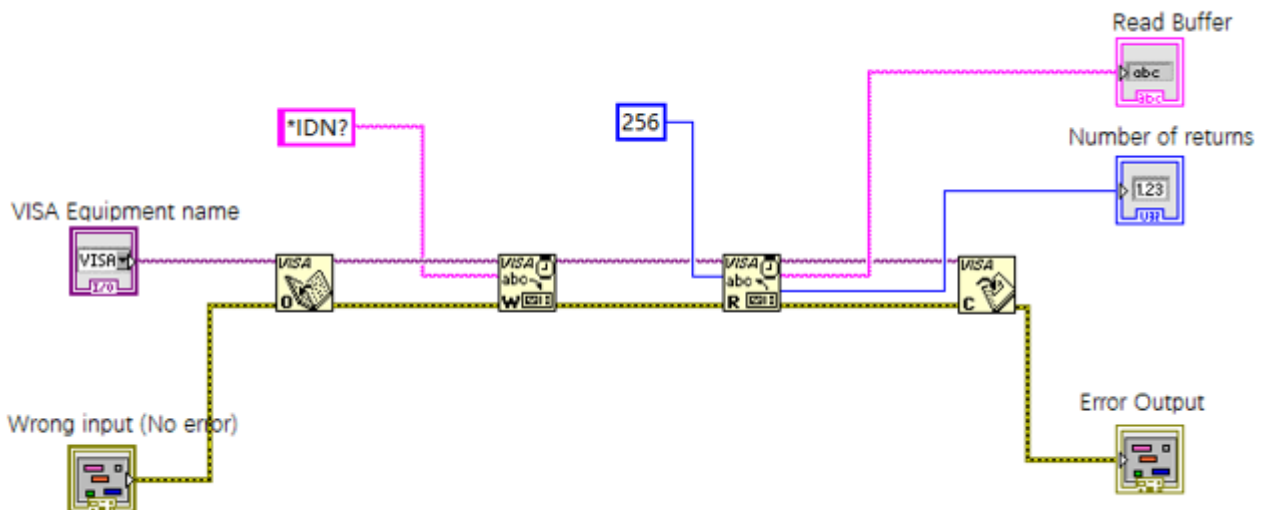

5. Communication with the device via TCP/IP is similar with USBTMC, it need to set VISA write and read function to synchronous I/O, set LabVIEW to asynchronous IO by default. Right click on the node and select "Synchronous I/O Mode>>Synchronous" from shortcut menu to enable synchronous writing or reading of data, as shown in the following figure.

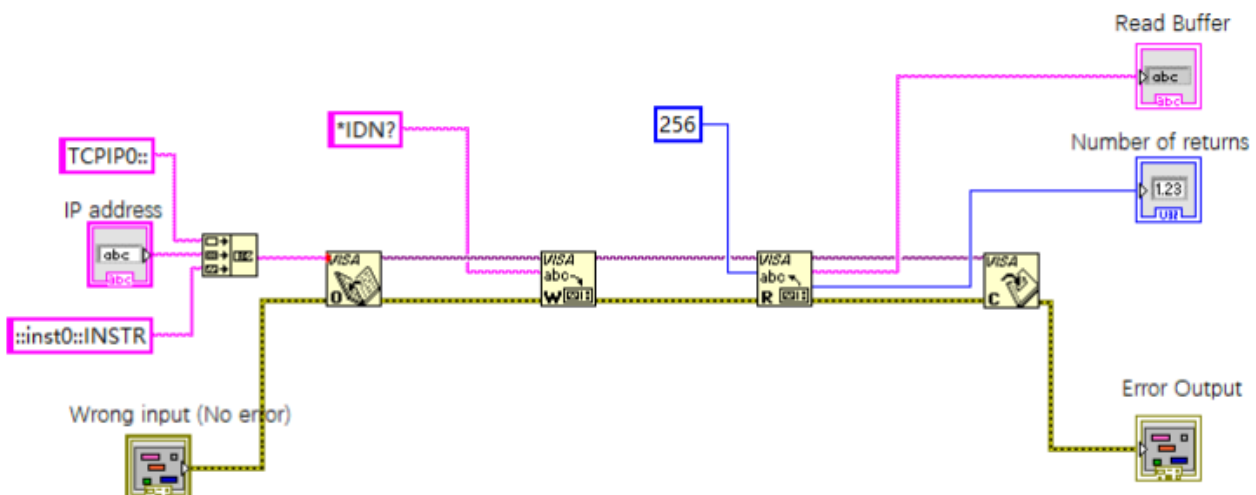

MATLAB Example

- Environment: Window system, MATLAB
- Description: Access the instrument via USBTMC and TCP/IP, and send "*IDN?" command on NI-VISA to query the device information.

➤ Steps:

1. Open MATLAB software, click File>>New>>Script on Matlab interface to create an empty M file.

2. Source code:

a) USBTMC Example

```
function usbtmc_test()
% This code demonstrates sending synchronous read & write commands
% to an USB Test & Measurement Class (USBTMC) instrument using
% NI-VISA
```

```
%Create a VISA-USB object connected to a USB instrument
vu = visa('ni','USB0::0x5345::0x1234::SN20220718::INSTR');
```

```
%Open the VISA object created
fopen(vu);
```

```
%Send the string "*IDN?", asking for the device's identification.
fprintf(vu, '*IDN?');
```

```
%Request the data
```

```
outputbuffer = fscanf(vu);
disp(outputbuffer);
```

```
%Close the VISA object
fclose(vu);
delete(vu);
clear vu;
```

```
end
```

b) TCP/IP Example

```
function tcp_ip_test()
% This code demonstrates sending synchronous read & write commands
% to an TCP/IP instrument using NI-VISA
%Create a VISA-TCPIP object connected to an instrument
```

```
%configured with IP address.
vt = visa('ni',['TCPIP0::','192.168.20.11','::inst0::INSTR']);
```

```
%Open the VISA object created
```

```
fopen(vt);

%Send the string "*IDN?", asking for the device's identification.
fprintf(vt, '*IDN?');

%Request the data
outputbuffer = fscanf(vt);
disp(outputbuffer);

%Close the VISA object
fclose(vt);
delete(vt);
clear vt;

end
```

Python Example

- Environment: Window system, Python3.8, PyVISA 1.11.0
- Description: Access the instrument via USBTMC and TCP/IP, send "*IDN?" command on NI-VISA to query the device information.
- Steps:
 1. Install python first, and then turn on Python script compiling software, create an empty test.py file.
 2. Use pip install PyVISA instruction to install PyVISA, if it cannot install, please refer to this link (<https://pyvisa.readthedocs.io/en/latest/>)

3. Source code:

a) USBTMC Example

```
import pyvisa
rm = pyvisa.ResourceManager()
rm.list_resources()
my_instrument = rm.open_resource('USB0::0x5345::0x1234::SN20220718::INSTR')
print(my_instrument.query('*IDN?'))
```

b) TCP/IP Example

```
import pyvisa
rm = pyvisa.ResourceManager()
rm.list_resources()
my_instrument = rm.open_resource('TCPIP0::192.168.20.11::inst0::INSTR')
print(my_instrument.query('*IDN?'))
```

Programming Application Example

Set bandwidth limit

When observing the low-frequency signal, it is necessary to reduce the high-frequency noise in the signal, then attenuate the high-frequency signal above 20 MHz in the signal. It can use the following command to set bandwidth limit, such as set channel 1,

```
CHANnel1:BWLimit ON      #turn on bandwidth limit of channel 1.
CHANnel1:BWLimit?
#query returns 1, it represents bandwidth limit of channel 1 has turned on.
```

Set offset voltage

Set the channel's offset voltage, it can use the following command to setup, such as offset voltage of channel 1,

```
CHANnel1:OFFSet 1V      #channel 1 move up 1V, then offset voltage is 1V.
CHANnel1:OFFSet?       #query the channel's offset voltage.
```

Set volts/div scale

Set volts/div scale of channel, it can be set as the following command, such as set

volts/div scale of channel 1,

```
CHANnel1:SCALE 500 mV   #set volts/div scale of channel 1 to 500 mV.
CHANnel1:SCALE?        #query volts/div scale value of channel 1.
```

Set timebase scale

Set timebase scale of the oscilloscope, it can be set as the following command,

```
TIMebase:SCALE 0.005    #set timebase scale of the oscilloscope to 5ms.
TIMebase:SCALE?        #query timebase scale of the oscilloscope.
```

Query amplitude value

User can run the following command to query the amplitude measurement results without opening the measurement window, such as query amplitude value of channel 1 waveform,

```
MEASure:VPP? CHANnel1   #query amplitude value of channel 1 waveform.
```

Query rising delay time value

User can run the following command to query rising delay measuring time without opening the measurement window, such as query rising delay value of channel 1 and channel 2,

```
MEASure:PDELay? CHANnel1, CHANnel2
# query rising delay value of channel 1 and channel 2.
```

Appendix 1: Keypad List

Key	Functional Description	LED
CH1	Channel 1 switch	√
CH2	Channel 2 switch	√
CH3	Channel 3 switch	√
CH4	Channel 4 switch	√
AUTO	The control values of the oscilloscope are automatically set to condign display the waveform for observation	
RS	Control the oscilloscope's running status, continuous send this command, the oscilloscope can switch to stop or run	√
TMENU	Trigger menu	
SINGLE	Single trigger	√
TFORe	Force trigger	
HELP	Help system	
HMENU	Horizontal system menu	
DISPly	Display menu	
MATH	Mathematical operation function and menu	√
REF	Reference waveform function and menu	√
F1	Select the first menu item of the current menu	
F2	Select the second menu item of the current menu	
F3	Select the third menu item of the current menu	
F4	Select the fourth menu item of the current menu	
F5	Select the fifth menu item of the current menu	
MENU	Menu display switch	
PSCReen	One-key print or One-key save screen image	
MEASure	Meaurement function	
CURSor	Cursor measurement function and menu	
ACQuire	Sampling menu	
STORage	Storage menu	
UTILity	System auxiliary menu	
CLEar	Clear the screen waveform of the oscilloscope	
DECode	Decoding menu	
DEFault	Restore to the default setting	
FKNob	Multipurpose knob	
FKNLeft	Multipurpose left knob	
FKNRight	Multipurpose right knob	
VPKNob	Vertical position knob	
VPKNLeft	Vertical position left knob	
VPKNRight	Vertical position right knob	

HPKNob	Horizontal position knob	
HPKNLeft	Horizontal position left knob	
HPKNRight	Horizontal position right knob	
TPKNob	Trigger position knob	
TPKNLeft	Trigger position left knob	
TPKNRight	Trigger position right knob	
VBKNob	Voltage benchmark knob	
VBKNLeft	Voltage benchmark left knob	
VBKNRight	Voltage benchmark right knob	
TBKNob	Time benchmark knob	
TBKNLeft	Time benchmark left knob	
TBKNRight	Time benchmark right knob	
NUM0	Numeric key 0	
NUM1	Numeric key 1	
NUM2	Numeric key 2	
NUM3	Numeric key 3	
NUM4	Numeric key 4	
NUM5	Numeric key 5	
NUM6	Numeric key 6	
NUM7	Numeric key 7	
NUM8	Numeric key 8	
NUM9	Numeric key 9	
DOT	Numeric key decimal point	
SYMBOL	Numeric key symbol	
BACKspace	Delete key	
ENTER	Confirm key	
LA	LA module key	√
AWG	Signal source module key	√
AUTO status light	No key, but the light	√
Normal status light	No key, but the light	√
Single status light	No key, but the light	√
MODE	Mode switch key	
RECSet	Recording waveform setting key	
PGDN	Next page key	
RECSTOP	Stop record	√
RECSTART	Start record	√
PLAYPAUSE	Play/pause recording waveform	√
SHKNLeft	Jog dial turn left	
SHKNRight	Jog dial turn right	

Appendix 2: IEEE 488.2 Binary Data Format

DATA is data flow, other is ASCII character, as shown in the following figure<#812345678 + DATA + \n>

Start (1Byte)	Length Bit Wide (1Byte)	Total Data Length (Bit Wide Byte)	DATA (n Byte)	End (1Byte)
#	x	xxxxxxxx	\n

Appendix 3: Cursor Measurement in XY Mode

Order No.	Name
1	Cursor Ax value
2	Cursor Bx value
3	Difference value Bx-Ax
4	Ay value of Channel 1
5	By value of Channel 1
6	Difference valu By-Ay of Channel 1
7	Ay value of Channel 2
8	By value of Channel 2
9	Difference valu By-Ay of Channel 2
10	The radius of Ay polar coordinate of the two channels
11	The radius of By polar coordinate of the two channels
12	The radius of By-Ay polar coordinate of the two channels
13	The angle of Ay polar coordinate of the two channels
14	The angle of By polar coordinate of the two channels
15	The angle of By-Ay polar coordinate of the two channels
16	The product of Ay of channel 2 and Ay of channel 1
17	The product of By of channel 2 and Ay of channel 1
18	The product of By-Ay of channel 2 and Ay of channel 1
19	The ratio of the Ay of channel 2 to the Ay of channel 1
20	The ratio of the By of channel 2 to the By of channel 1
21	The ratio of the By-Ay of channel 2 to the By-Ay of channel 1