

UNI-T®

Instruments.uni-trend.com

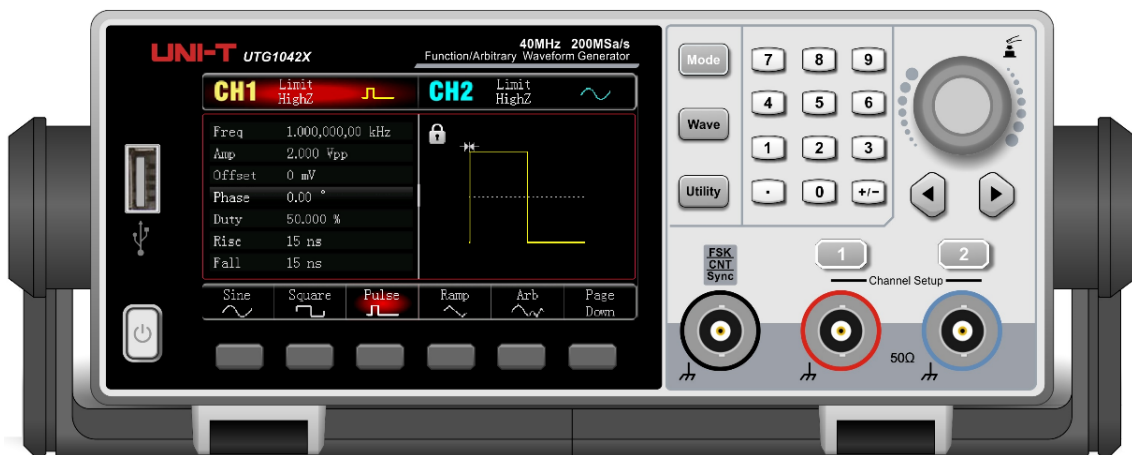

Service Manual

UTG1000X Series Function/Arbitrary Waveform Generator

Preamble

Respected user:

Thank you for purchasing a brand-new Uni-Tech instrument. To use this instrument correctly, please read the entire text of this user manual carefully before using this instrument, especially the part about "Safety Precautions".

If you have read the entire text of this manual, it is recommended that you keep this manual in a safe place, place it with the instrument, or put it in a place where you can refer to it at any time so that you can refer to it in the future.

Copyright Information

UNI-T Uni-T Technology (China) Co., Ltd. All rights reserved.

UNI-T products are protected by patent rights in China or other countries, including patents that have been obtained or are being applied for.

The company reserves the right to change product specifications and prices.

UNI-T reserves all rights. Licensed software products are owned by UNI-T and its subsidiaries or providers, and are protected by national copyright laws and international treaties. Information in this document supersedes that in all previously published sources.

UNI-T is a registered trademark of UNI-TREND TECHNOLOGY (CHINA) CO., LTD].

If the original purchaser sells or transfers the product to a third party within one year from the date of purchase, the warranty period shall be from the date the original purchaser purchases the product from UNI-T or an authorized UNI-T distributor. Accessories and fuses, etc. are not covered by this guarantee within one year from the date of the warranty.

If the product proves to be defective within the applicable warranty period. In that case, UNI-T may, at its sole discretion, either repair the defective product without charge for parts and labor, or replace the defective product with an equivalent product (at UNI-T's discretion), UNI - The components, modules, and replacement products used by T for warranty purposes may be brand new, or have been repaired to have the performance equivalent to new products. All replaced components, modules, and products will become the property of UNI-T.

References below to "Customer" mean the person or entity claiming the rights under this Warranty. In order to obtain the service promised by this guarantee, the "customer" must notify UNI-T of the defect within the applicable warranty period, and make appropriate arrangements for the performance of the service, and the customer shall be responsible for packing and shipping the defective product to UNI-T's designated repair center of UNI-T, and prepay the freight and provide a copy of the original purchaser's proof of purchase. If the product is to be shipped to a location within the country where the UNI-T repair center is located, UNI-T shall pay for the return of the product to the customer. If the product is sent to Returns to any other location it is the customer's responsibility to pay all shipping charges, duties, taxes, and any other charges.

This warranty does not apply to any defect, failure, or damage caused by accident, normal wear and tear of machine parts, use outside or improper use of the product, or improper or insufficient maintenance. UNI-T has no obligation to provide the following services according to the provisions of this guarantee:

a) Repair damage caused by installation, repair or maintenance of the product by non-UNI-T service representatives;

b) repair of damage caused by misuse or connection with incompatible equipment;

c) Repair any damage or malfunction caused by using power supply not provided by UNI-T;

d) Repair of products that have been altered or integrated with other products if such alterations or integration would increase the time or difficulty of product repairs.

This warranty is made by UNI-T for this product and is used to replace any other express or implied warranties. UNI-T and its distributors refuse to make any implied warranties of merchantability or fitness for a particular purpose. In the event of a breach of this warranty, UNI-T is responsible for repairing or replacing defective products as the sole and exclusive remedy provided to the customer, regardless of whether UNI-T and its distributors have been informed in advance of any indirect, special, incidental or consequential damage, UNI-T and its dealers are not responsible for such damage.

1. Overview

Safety Information

This section contains information and warnings that must be observed to keep the instrument operating under appropriate safety conditions. In addition to the safety precautions indicated in this section, you must follow generally accepted safety procedures.













Safety Precautions





Warning	To avoid possible electric shock and personal safety, follow these guidelines:
	During all phases of operation, service, and repair of this instrument, the following general safety precautions must be followed. Unilever will not bear any responsibility for the personal safety and property loss caused by the user's failure to follow the following safety precautions. This equipment is designed for professional users and responsible institutions for measurement purposes.
	Do not use this equipment in any manner not specified by the manufacturer. Unless otherwise specified in the product documentation, this equipment is for indoor use only.

Safety statement

Warning	The WARNING statement indicates a hazard. It alerts the user to a certain procedure, method of operation, or similar situation. Personal injury or death could result if the rules are not performed correctly or followed. Do not proceed to the next step until the conditions of the indicated WARNING notice are fully understood and met.
Caution	The "Caution" symbol indicates a hazard. It alerts the user to a certain procedure, method of operation, or similar situation. Failure to perform or follow the rules correctly may result in damage to the product or loss of important data. Do not proceed to the next step until the indicated CAUTION conditions are fully understood and met.
Notice	The "Notice" statement indicates important information. Prompting the user's attention to a procedure, practice, condition, etc., should be prominently displayed.

Safety Signs

	Danger	Indicates a warning of a possible electric shock hazard that could result in personal injury or death.
	Warning	Indicates a point requiring caution, which may result in personal injury or damage to the instrument.
	Caution	Indicates a potentially hazardous condition that requires following a procedure or condition that may damage the instrument or other equipment; if a "Caution" sign is indicated, all conditions must be met before continuing to operate.
	Notice	Indicates a potential problem, a procedure, or a condition that needs to be followed, which may cause the instrument to function improperly; if the "Caution" mark is marked, all conditions must be met to ensure that the instrument can function normally.
	Alternate current	Instrument AC, please confirm the regional voltage range.
	Direct current	Instrument direct current, please confirm the regional voltage range.
	Grounding	Frame, chassis ground terminal.
	Grounding	Protective earth terminal.
	Grounding	Measure the ground terminal.
	Close	The main power is off.
	Open	The main power is turned on.
	Power supply	Standby power, when the power switch is turned off, the instrument is not completely disconnected from the AC power source.
CAT I		A secondary electrical circuit connected to a wall socket through a transformer or similar device, such as electronic equipment. Electronic equipment with protective measures, any high-voltage and low-voltage circuits, such as copiers inside the office, etc.
CAT II		CATII: The primary electrical circuit of electrical equipment connected to the indoor socket through the power cord, such as mobile tools, home appliances, etc. Household appliances, portable tools (electric drills, etc.), household sockets, and sockets that are more than 10 meters away from Category III lines or 20 meters away from Category IV lines.
CAT III		Primary circuits of large equipment directly connected to the distribution panel and circuit connections between the distribution panel and socket outlets (three-phase distribution circuits including individual commercial lighting circuits). Equipment with fixed positions, such as multi-phase motors, and multi-phase gate boxes; lighting equipment and lines inside large buildings; machine tools and power distribution panels at industrial sites (workshops), etc.

CAT IV		Three-phase public power supply equipment and outdoor power supply line equipment. Equipment designed for "primary connection", such as the power distribution system of the power station; power meters, front-end over-set protection, and any outdoor transmission lines.
	CE Certified	The CE mark is a registered trademark of the European Union.
	UKCA Certified	The UKCA logo is a registered trade mark in the United Kingdom.
	ETL Certified	Meets UL STD 61010-1, 61010-2-030, Meets CSA STD C22.2 No. 61010-1 and 61010-2-030.
	Abandoned	Do not place the device and its accessories in the trash. Items must be disposed of properly in accordance with local regulations.
	Environmental friendly	Environmental protection uses a period mark, this symbol indicates that within the indicated time, hazardous or toxic substances will not leak or be damaged. The product's environmental protection use period is 40 years. During this period, it can be used with confidence. It should enter the recycling system after the specified time.

Safety requirements

Warning	
Prepare before use	Please use the supplied power cord to connect this device to an AC power source; The AC input voltage of the line complies with the rated value of this device; the specific rated value is detailed in this product manual. The line voltage switch of this equipment matches the line voltage; The line voltage of the line fuse of this equipment is correct; Do not use it for measuring main circuits.
View All Terminal Ratings	In order to avoid fire and the impact of excessive current, please check all the ratings and marking instructions on the product, and please refer to the product manual for detailed information on ratings before connecting the product.
Use the power cord correctly	Only use the instrument-specific power cord approved by the local country. Check whether the insulation layer of the wire is damaged or whether the wire is exposed, and check whether the test wire is connected. If the wire is damaged, please replace it before using the instrument.
Instrument ground-ing	To avoid electric shock, the grounding conductor must be connected to the ground. This product is grounded through the grounding wire of the power supply. Before the product is powered on, please be sure to ground the product.
AC power requirements	Please use the specified AC power supply for this device. Please use the power cord approved by the country where you are located and make sure that the insulation layer is not damaged.

Anti-static protection-on	Static electricity will cause damage to the instrument, and the test should be performed in an anti-static area as much as possible. Before connecting the cable to the instrument, briefly ground its inner and outer conductors to discharge static electricity. The protection level of this equipment is 4kV for contact discharge and 8kV for air discharge.
Measurement accessories	Measurement accessories are lower-category measurement accessories that are definitely not suitable for mains measurements and are definitely not suitable for measurements on CAT II, CAT III, or CAT IV circuits. Probe assemblies and accessories within the scope of IEC 61010-031 and current sensors within the scope of IEC 61010-2-032 shall meet its requirements.
Proper use of device input/output ports	The input and output ports are provided by this device, please make sure to use the input/output ports correctly. It is forbidden to load input signals on the output port of this device, and it is forbidden to load signals that do not meet the rated value on the input port of this device. Ensure that the probe or other connection accessories are effectively grounded to avoid equipment damage or abnormal function. Please check the user manual for the ratings of the input/output ports of this device.
Power fuse	Use a power fuse of the specified specification. If it is necessary to replace the fuse, the maintenance personnel authorized by Unilever must replace the fuse that meets the specified specifications of this product.
Disassemble and clean	There is no operator-accessible parts inside. Do not remove the protective cover. Maintenance must be performed by qualified personnel.
working environment	This device is intended for indoor use, in a clean, dry environment, within the ambient temperature range of 10 °C ~ +40 °C。 Do not operate the device in explosive, dusty, or humid atmospheres.
Do not operate in a wet environment	Avoid the risk of short circuits or electric shock inside the instrument, and do not operate the instrument in a humid environment.
Do not operate in flammable and explosive environment	To avoid instrument damage or personal injury, please do not operate the instrument in a flammable and explosive environment.
Caution	
Abnormal situation	If you suspect that the product is malfunctioning, please contact the maintenance personnel authorized by Unilever for testing; Any maintenance, adjustment, or parts replacement must be carried out by the relevant person in charge of Unitech.
Cooling requirements	Do not block the ventilation holes located on the sides and rear of the device; Do not allow any foreign objects to enter the device through ventilation holes, etc.; Ensure adequate ventilation, leaving at least 15 cm of clearance on the sides, front, and rear of the unit.
Pay attention to handling safety	In order to prevent the instrument from slipping during transportation and causing damage to the buttons, knobs, or interfaces on the panel of the instrument, please pay attention to the safety of transportation.

Maintain proper ventilation	Poor ventilation can cause the temperature of the instrument to rise, which can cause damage to the the instrument. Keep well-ventilated when in use, and check the vents and fans regularly.
Please keep it clean and dry	To avoid dust or moisture in the air from affecting the performance of the instrument, please keep the surface of the product clean and dry.
Notice	
Calibration	The recommended calibration cycle is one year. Calibration should only be performed by suitably qualified personnel.

Environmental requirements

This instrument is suitable for the following environments:

- Indoor use
- Pollution degree 2
- When operating: the altitude is lower than 3000 meters; when not operating: the altitude is lower than 15000 meters
- Unless otherwise specified, the operating temperature is 10 to + 40°C; the storage temperature is -20 to + 70°C
- Humidity operates as Below +35°C ≤90% relative humidity, non-operating humidity is +35°C ~ +40°C ≤60% relative humidity

There are vents on the rear panel and side panels of the instrument, please keep the air circulation through the vents of the instrument case. Do not place the analyzer side-by-side with any other instrument that requires side-by-side ventilation. Make sure that the exhaust port of the first instrument is away from the air inlet of the second instrument. If the air heated by the first instrument flows to the second instrument, it may cause the second instrument to operate too hot, or even malfunction. To prevent excessive dust from clogging the vents, clean the instrument case regularly. But the case is not waterproof. When cleaning, please cut off the power first, and wipe the case with a dry cloth or a slightly damp soft cloth.

Connect the power supply

Voltage range	frequency
100-240VAC (fluctuation ±10%)	50/60Hz
100-120VAC (fluctuation ±10%)	400Hz

The specifications of the equipment that can input AC power are:

Please use the power cord provided in the accessories to connect to the power port.

Connecting the Power Cable

This instrument is a Class I safety product. The supplied power cord provides a good case ground. This function/arbitrary waveform generator is equipped with a three-core power cord that meets international

safety standards, can provide good shell grounding performance, and is suitable for the regulations of the country or region where it is located.

Please follow the steps below to install your AC power cord:

- Verify that the power cord is not damaged.
- When installing the instrument, please allow enough space for you to connect the power cord.
- Plug the supplied three-core power cord into a well-grounded power outlet.

Static Protection

Electrostatic discharge can cause damage to components, and electrostatic discharge may cause invisible damage to components during transportation, storage, and use.

The following measures reduce electrostatic discharge damage that may occur during testing equipment:

- Testing should be performed in an anti-static area whenever possible;
- Before connecting the cable to the instrument, its inner and outer conductors should be grounded briefly to discharge static electricity;
- Make sure all instruments are properly grounded to prevent buildup of electrostatic charges.

Check serial numbers and system information

UNI-T is constantly improving its product performance, usability, and reliability. UNI-T service personnel can access the according to the instrument serial number and system information.

The serial number is located on the rear cover serial label, or the analyzer is powered on, press Utility → System → About. System information is useful for updates and post-market upgrades.

2. Foreword

Supported Products

This manual covers servicing the following products:

UTG1022X、UTG1022-PA、UTG1042X;

Check for specific product names in headers, titles, table or graph titles, or text at the top of the page.

Material without any specific product designation applies to all products in the brochure.

Where to find operational information

For information on instrument installation, operation, and networking, refer to the help or user manual that came with the function/arbitrary wave generator.

3. Structure introduction

Front panel components

As shown below:

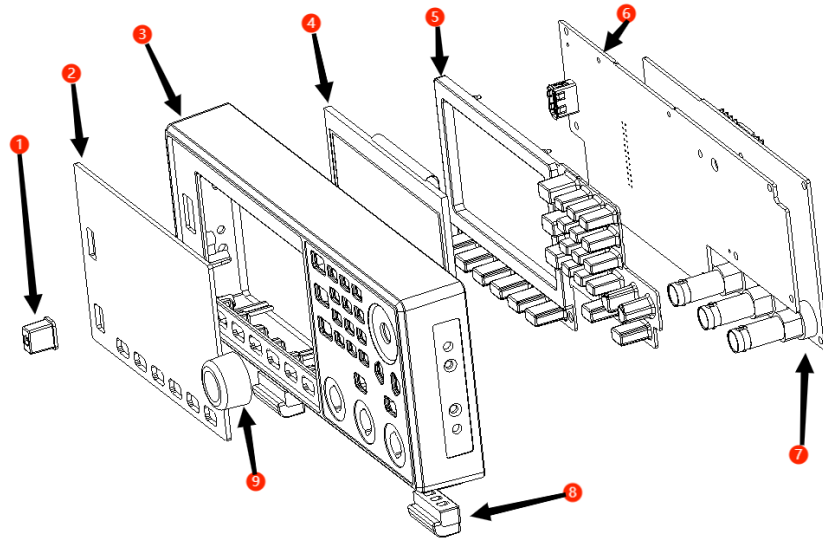

Parts List

Serial number	Parts name	Serial number	Parts name
1	Switch power switch	6	Keypad Plug-in Components
2	lens	7	Motherboard plug-in components
3	Front frame	8	Floor mat
4	4.3 inches true color LCD screen	9	Knob cap
5	Silicone control button set		

Rear panel components

As shown below:

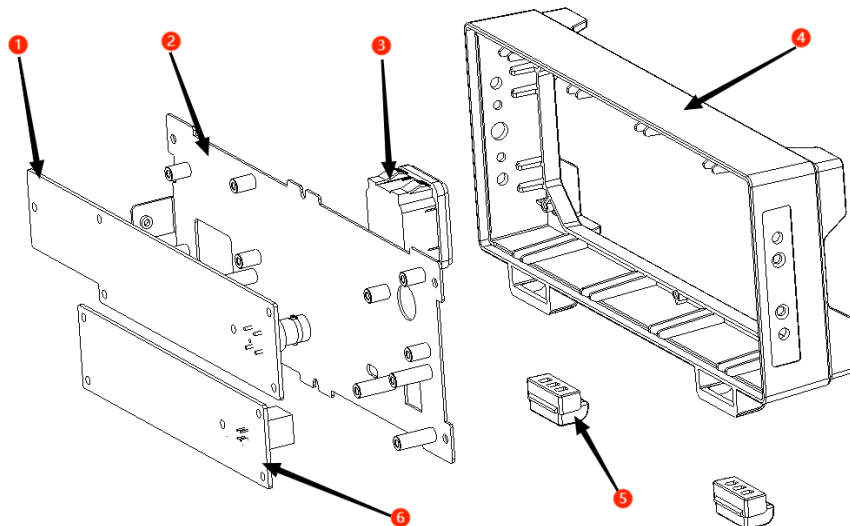

Parts List:

Serial number	Parts name	Serial number	Parts name
1	Power amplifier module plug-in components	4	Back frame
2	Back cover 1.0mm galvanized sheet	5	Floor mat
3	AC two-in-one card power socket three plugs with safety seat	6	Power Board Plug-In Components

Handle and case

As shown below:

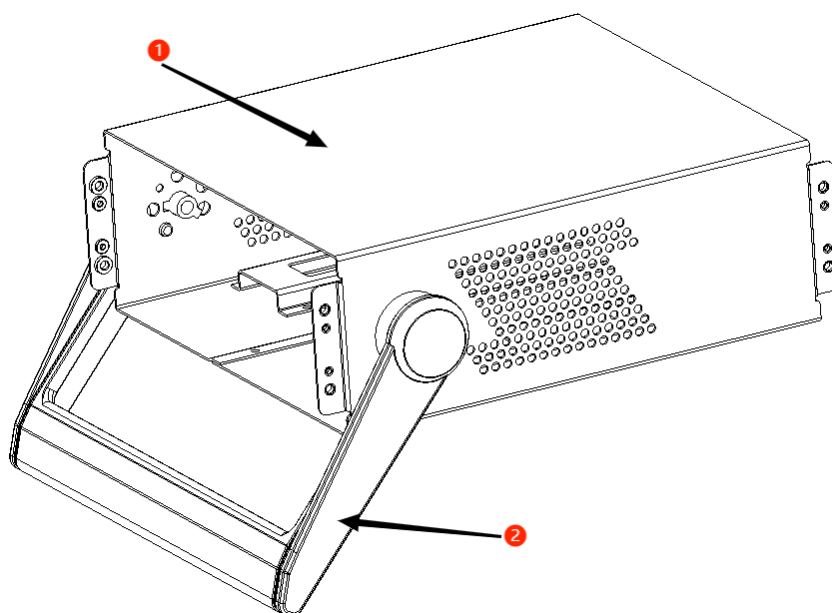

Parts List

Serial number	Parts name
1	Middle frame
2	Handle

4. Maintenance

This section contains information needed to perform periodic and corrective maintenance on the instrument.

Pre-discharge electrostatic discharge

Before servicing this product read the General Safety Summary and Service Safety Summary at the front of the manual, as well as the following ESD information.

⚠ Notice: Electrostatic discharge (ESD) can damage any semiconductor components in this instrument

When performing any service that requires internal access to the instrument, observe the following precautions to avoid affecting internal modules and their components due to electrostatic discharge:

1. Minimize handling of static-sensitive circuit boards and components.
2. Transport and store static-sensitive modules in their static-protective containers or on metal rails. Label any packages that contain electrostatic sensitive boards.
3. When handling these modules, discharge static voltage from your body by wearing a grounded antistatic wrist strap.
4. Servicing static-sensitive modules only at a static-free workstation.
5. Keep away anything that can create or maintain a static charge on workstation surfaces.
6. Handle the board by the edges as much as possible.
7. Do not slide the circuit board on any surface.

Avoid handling circuit boards in areas where floor or work surface coverings can generate static charges.

Inspection and cleaning

Inspection and Cleaning describe how to inspect for dirt and damage. It also describes how to clean the exterior or interior of the instrument. Inspection and cleaning are performed as preventive maintenance. Regular preventive maintenance can prevent instrument failure and increase its reliability.

Preventive maintenance includes visual inspection and cleaning of the instrument, and maintaining general care while operating the instrument.

The frequency with which maintenance is performed depends on the severity of the environment in which the instrument is used. The proper time to perform preventive maintenance is before instrument tuning.

External cleaning

Clean the exterior of the case with a dry, lint-free cloth or a soft-bristled brush. If any dirt remains, use a cloth or cotton swab dampened with a 75% isopropyl alcohol solution. Use a cotton swab to clean up the space around the controls and connectors. Do not use abrasives on any part of the case that could damage the case. Clean the On/Standby switch with a clean towel dampened with deionized water. Do not spray or wet the switch itself.

Notice:

Avoid using chemical cleaners, which may damage the plastics used in this instrument. ⚠ Use only deionized water when cleaning the front panel buttons. Use a 75% isopropyl alcohol solution as a cleaner for cabinet parts. Please consult your Uni-Tech service center or representative before using other types of cleaners.

Check - Appearance. Inspect the exterior of the instrument for damage, wear, and missing parts. Immediately repair defects that could result in personal injury or further use of the instrument.

External Checklist

Item	Examination	Repair operation
Enclosures, Front Panels and Covers	Cracks, scratches, deformation, hardware damage	Repair or replace defective modules
Front panel knob	Missing, damaged, or loose knobs	Repair or replace missing or defective knobs
connect	Cracked housing, cracked insulation, and deformed contacts. dirt in the connector	Repair or replace defective modules. Clean or brush off dirt
Handles and Supporting Feet	correct operation	Repair or replace defective modules
Accessories	Missing items or parts, bent pins, broken or frayed cables, and damaged connectors	Repair or replace damaged or missing items, frayed cables, and defective modules

Display cleaning

Clean the display surface by gently wiping the display with a cleanroom wipe or non-abrasive cleaning cloth.

If the display is very dirty, dampen a cloth with distilled water, a 75% isopropyl alcohol solution, or a standard glass cleaner, and then gently wipe the display surface. Use only enough liquid to dampen the cloth or wipe. Avoid excessive force, which may damage the display surface.

 **Notice:** Incorrect cleaning agents or methods may damage the display.

- Do not use abrasive cleaners or surface cleaners to clean the monitor.
- Do not spray liquid directly on the monitor surface.
- Do not scrub the monitor with excessive force.

 **Notice:** To prevent moisture from getting inside the instrument during exterior cleaning, do not spray any cleaning solutions directly onto the screen or the instrument.

Return the instrument for repair

When repacking the instrument for shipment, use the original packaging. If the packaging is not available or suitable for use, please contact your local Uni-Tech representative to obtain a new packaging.

Seal shipping cartons with industrial staplers or strapping.

If the instrument is shipped to the Uni-Tech service center, please attach the following information:

- Owner's address.
- The contact's name and phone number.
- The type and serial number of the instrument.
- The reason for the return.
- A full description of the services required.

Mark the address of the Unilever service center and the return address on the shipping box in two prominent places.

5. Disassemble

Removal tool

Use the following tools to remove or replace modules in the function/arbitrary waveform generator.

Item	Tools	Description
1	Torque screwdriver	Model see disassembly steps
2	Upholstered	Prevents damage to the screen and knobs when removing the front panel
3	Anti-static environments	To prevent damage to devices caused by static electricity, wear properly grounded anti-static clothing, wrist straps, and foot straps; effective anti-static mats

Remove the handle

The following procedure describes the removal and replacement of the handle.

Steps:

1: After turning to the picture below, pull the handles on both sides outward to remove the handles:



Remove the screws on the left and right sides of the middle frame

The following procedure describes the removal and replacement of the front and rear covers.

Prerequisites:

- To prevent electrostatic damage to components, wear a properly grounded antistatic wrist and foot strap during installation, and use an antistatic mat in a tested antistatic environment.

Steps:

1: Use a T10 Torque screwdriver to remove the screws on the left and right panels of the instrument, a total of 9 screws, as shown in the figure below:



2. Gently remove the front panel, as shown in the figure below.

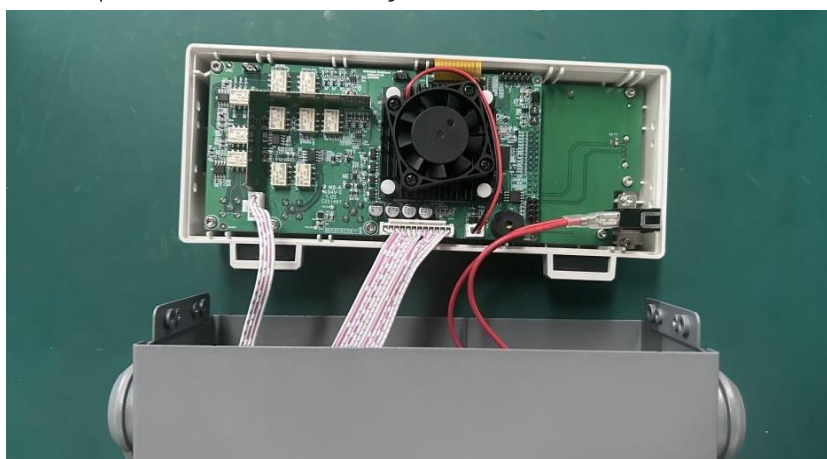

Note: When the front panel is placed downward, it is necessary to avoid the knob cap to avoid damage to the knob.

Removing the Front Panel Assembly

The following procedure describes the removal of the front panel.

Prerequisites:

- To prevent electrostatic damage to components, wear a properly grounded antistatic wrist and foot strap during installation, and use an antistatic mat in a tested antistatic environment.

Steps:

- 1、 Place the cushion flat on the electrostatic table;
- 2、 Place the instrument face down on a cushion to prevent damage to the screen and knobs;
- 3、 Remove the connecting wire harness on the front panel; as shown in the figure below:

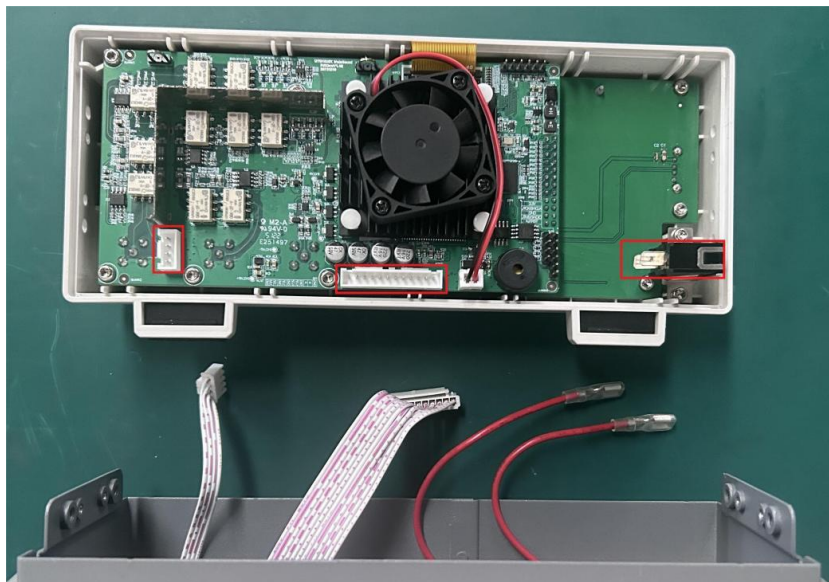

4. Remove the fan, and use a T10 Torque screwdriver to remove the four screws and the power supply cable of the fan. As shown below:

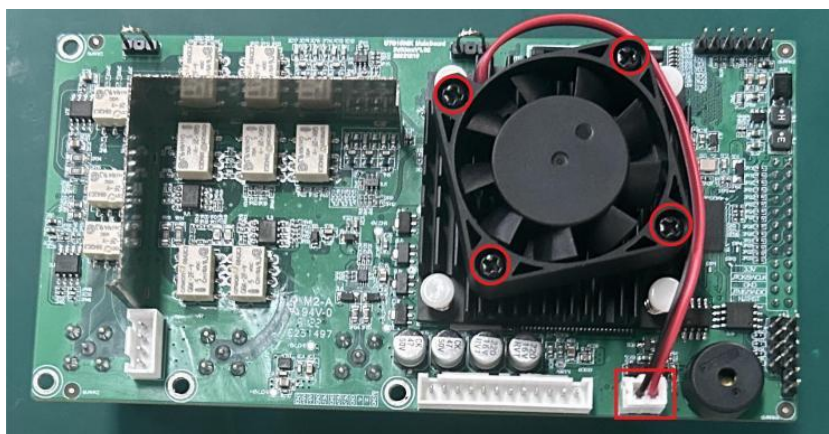

5. Remove the motherboard; use a T10 Torque screwdriver to remove the 5 screws on the front panel and the display cable. As shown below:

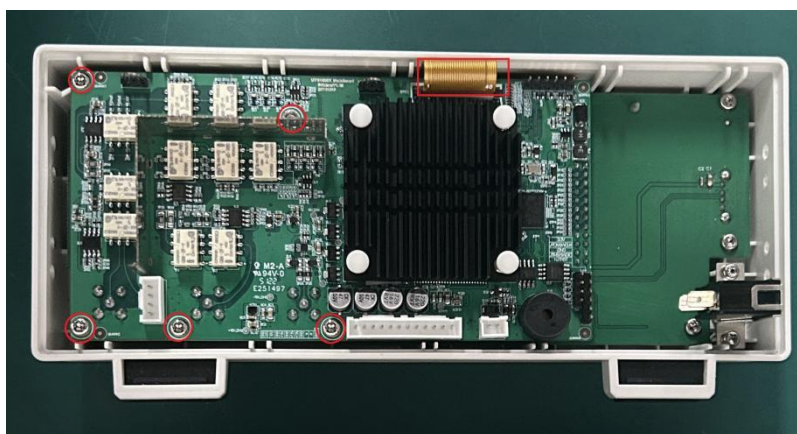

6. Carefully lift up and remove the motherboard.

- 7、 Remove the keyboard; use a T10 Torque screwdriver to remove the two switch key screws, and then remove the 8 fixing screws of the keyboard to remove the keyboard and the screen.

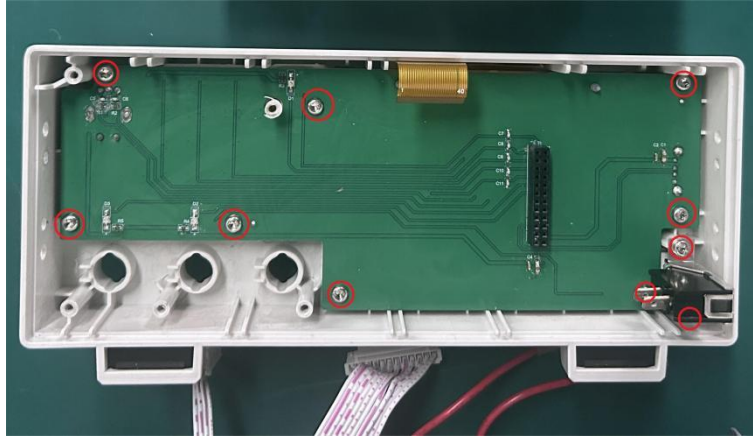

Note: Before removing the keyboard, the knob on the front panel needs to be removed.

- 8、 To reinstall, reverse the above steps.

Removing the rear panel assembly

The following procedure describes the removal and replacement of the rear panel assembly.

Prerequisites:

- To prevent electrostatic damage to components, wear a properly grounded antistatic wrist and foot strap during installation, and use an antistatic mat in a tested antistatic environment.
- Remove the rear cover.

Steps:

1. After step 3 of removing the front panel, gently pull the rear cover to remove it, as shown in the figure below:

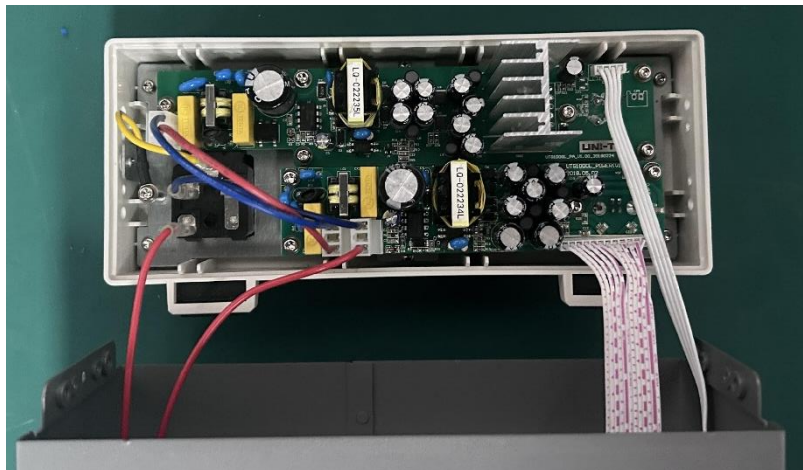

2. Remove the power module; use a T10 Torque screwdriver to remove the 6 screws and the wiring harness, as shown in the figure below:

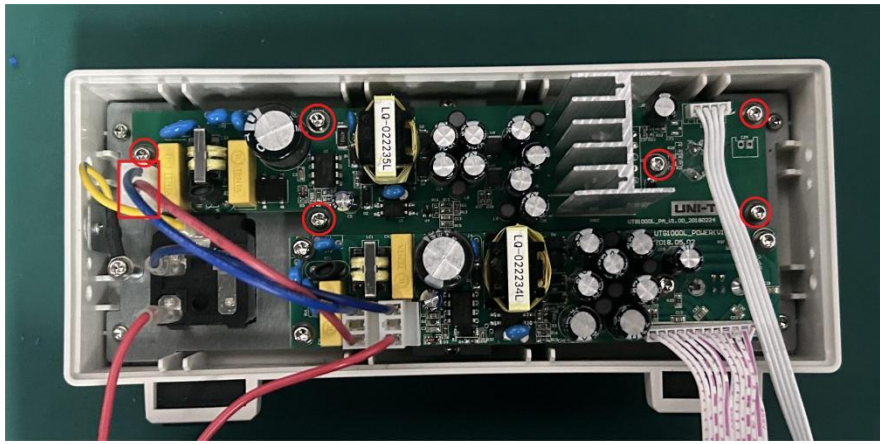

2. Remove the power module; use a T10 Torque screwdriver to remove the 5 screws and the blue wire, as shown in the figure below:

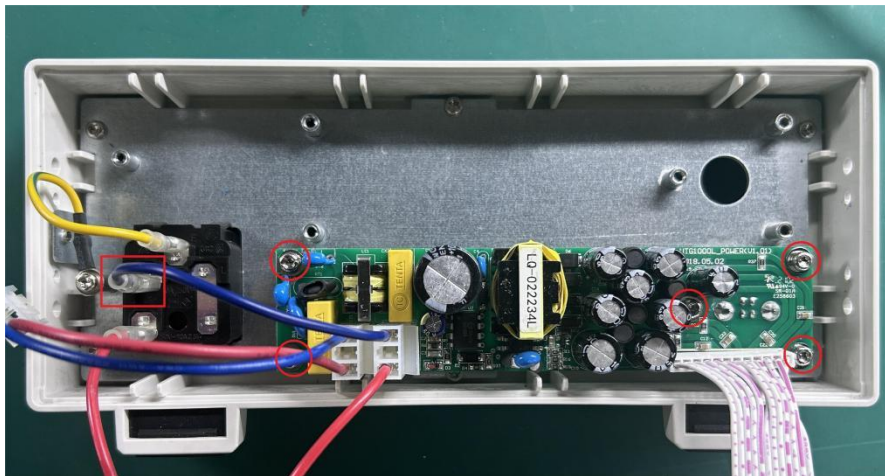

4. Remove the rear panel; use a T10 Torque screwdriver to remove the 6 screws and the grounding wire, as shown in the figure below:

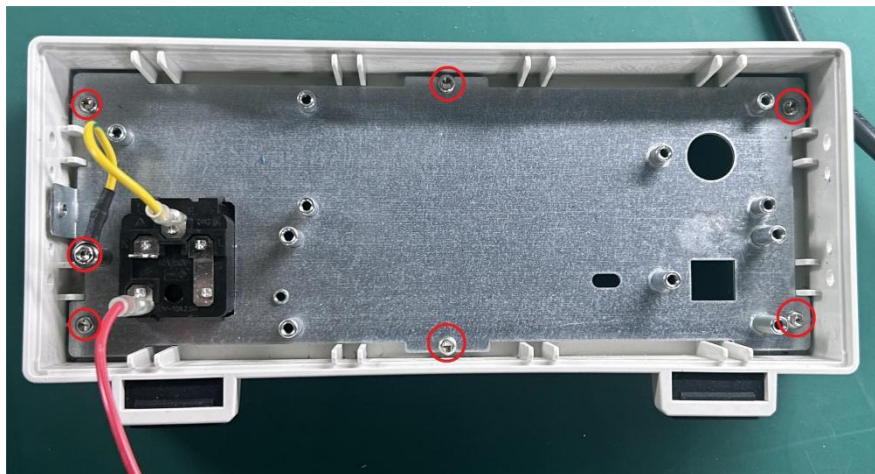

5. To reinstall, reverse the above steps.

Service level

This section contains information and procedures to help you determine if a power failure is an instrument problem. If the power fails, the instrument needs to be sent back to the Uni-Tech service center for repair, because other internal electronic components or modules cannot be replaced by the user.

Frequently Asked Questions

Use the following table to help isolate possible failures. The following table lists problems and possible causes. This list is not exhaustive, but it can help eliminate quick-fix issues, such as a loose power cord. For more detailed troubleshooting, see Troubleshooting Flowchart

Symptoms	Possible reason
The instrument cannot be powered on	<ul style="list-style-type: none"> • Power cord not plugged in • electricity failure • Defective Microcontroller Components
The instrument is powered on, but the fans are not running	<ul style="list-style-type: none"> • Faulty fan power cable • Fan power cable not connected to circuit board • fan failure • electricity failure • One or more defective load regulator points
The display is blank or there are streaks in the display	<ul style="list-style-type: none"> • Display or display circuit failure.

Required equipment

- Digital voltmeter for checking mains voltage.
- Anti-static working environment.

Troubleshooting flowchart

The flowchart below describes how to troubleshoot the instrument in the most general cases. This does not guarantee full recovery from all possible hardware failures.

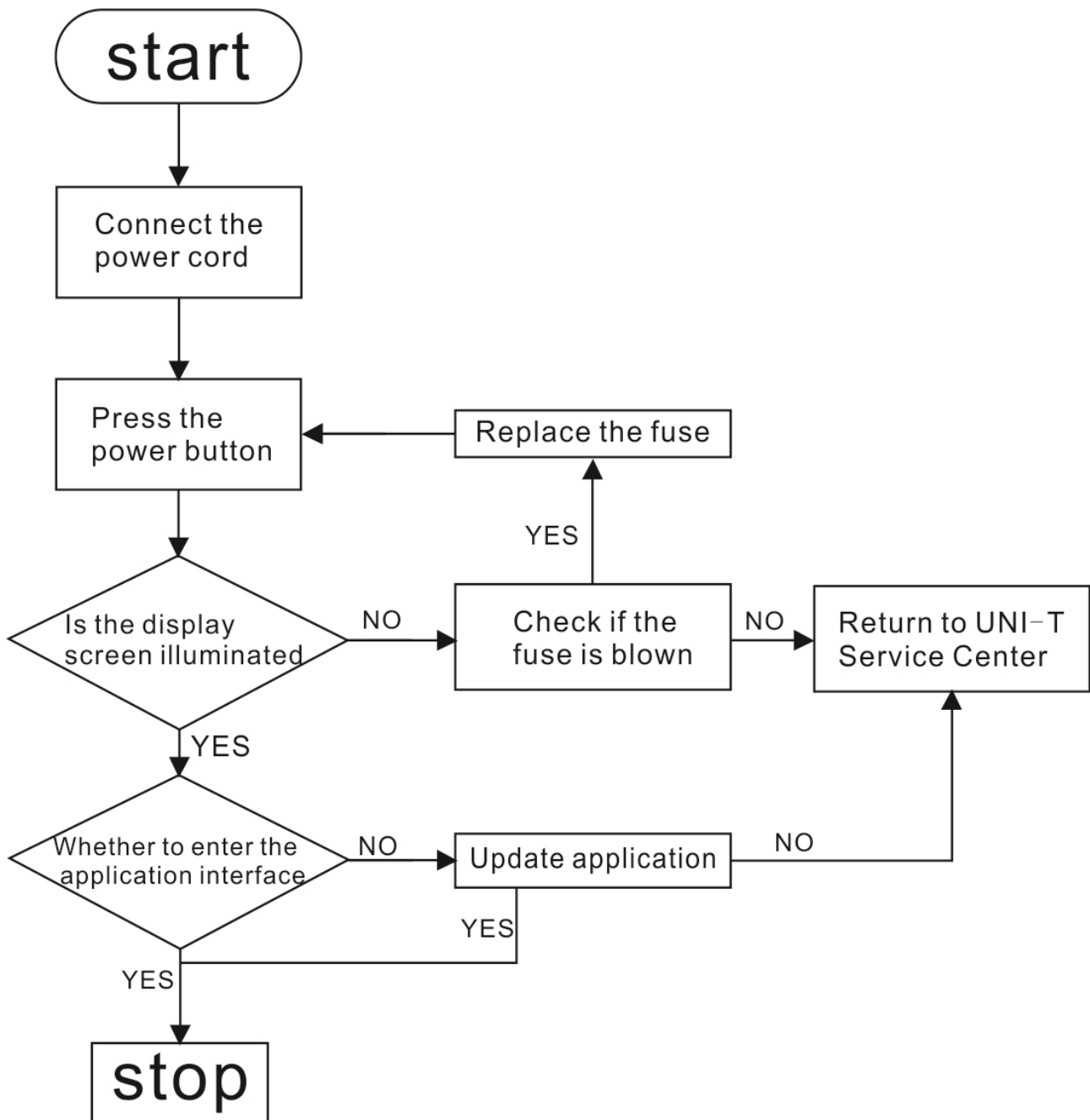

After maintenance

After removing and replacing the power module, if the instrument fails the performance verification test, it must be returned to the Uni-Tech Service Center for adjustment.

6. Appendix

Warranty Summary

UNI-T (Union Technology (China) Co., Ltd.) guarantees that the products it produces and sells will be free from any defects in materials and workmanship within one year from the date of shipment from authorized

distributors. If the product proves to be defective during the warranty period, UNI-T will repair and replace it according to the detailed provisions of the warranty.

To arrange repairs or to obtain a full copy of the warranty, please contact your nearest UNI-T sales and repair office.

Except for the guarantees provided in this summary or other applicable warranty certificates, UNI-T does not provide any other express or implied guarantees, including but not limited to any implied guarantees of product traceability and suitability for special purposes. IN NO EVENT WILL UNI-T BE LIABLE FOR INDIRECT, SPECIAL, OR CONSEQUENTIAL DAMAGES.

Contact us

If you have any inconvenience in the process of using this product, you can directly contact UNI-T Technology (China) Co., Ltd. (UNI-T, Inc.) in mainland China:

From 8:00 am to 5:30 pm Beijing time, Monday to Friday, or contact us by email. Our email address is infosh@uni-trend.com.cn

For product support outside mainland China, please contact the local UNI-T distributor or sales center.

Service Support Many of UNI-T's products have extended warranty and calibration plans available, please contact your local UNI-T distributor or sales center.

For a list of locations of service centers by location, please visit our website.

URL:<http://www.uni-trend.com>