

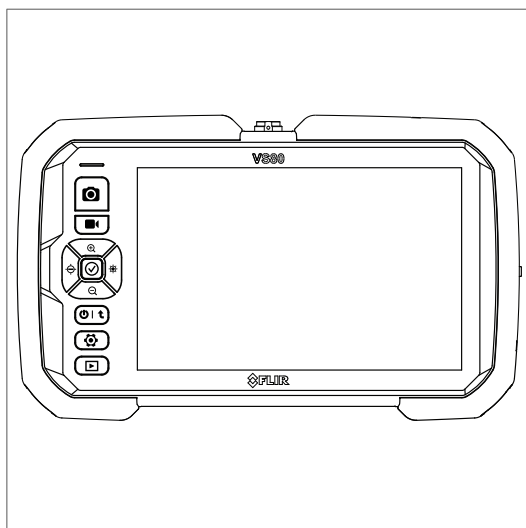

# Quick Start

## VS80 KIT

High Performance Videoscope and  
Camera Probe



# Quick Start (en)

## INTRODUCTION

The VS80 kit consists of the main display unit, a camera probe, and accessories. To obtain the comprehensive user manual, additional quick start translations, firmware updates, and customer support, see the Support section. Please upgrade the firmware before use for optimal performance and camera compatibility.

The numbers in parenthesis, below, refer to the items listed in the Product Description section.

## QUICK STEPS

1. Insert micro SD card in slot located in side compartment (19).
2. Connect the camera probe (16):

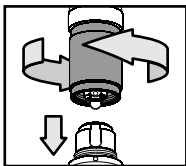

3. Remove the camera's protective lens cap.
4. Long press the power button (9), the FLIR logo will appear.
5. The camera image will then appear (14) with touch-screen icons (12) bordering the image.
6. For the IR camera only, the dot on the probe head indicates the top of the image, as shown:



7. If the battery icon (15) indicates a low charge, connect the supplied AC adapter to the USB port at the top of the display unit (17) and to an AC power source (100 to 240 VAC, 50/60 Hz).
8. The status LED (1) is blue when power is on (charger not connected); green when charging with power off; cyan (light blue) when charging with power on; no light when fully charged (with charger attached).
9. Long press the power button (9) to switch off the VS80.

## PRODUCT DESCRIPTION

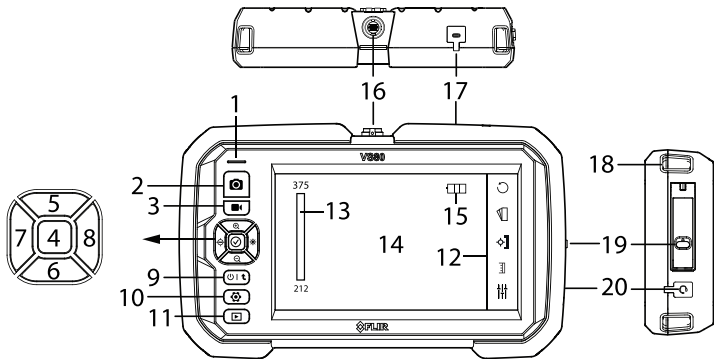

1. Power status LED
2. Image capture button
3. Video recording start/stop button
4. 1. Full screen view button; 2. Disconnect Wi-Fi
5. Zoom in (navigate upward in touch-screen menus)
6. Zoom out (navigate downward in touch-screen menus)
7. Decrease brightness (move left in touch-screen menus)
8. Increase brightness (move right in touch screen menus)
9. Long press to power on/off. Short press to return from a menu
10. Settings menu button
11. Image/video gallery button
12. Touch screen icons
13. Temperature scale (IR only)
14. Camera images and menus
15. Battery status icon
16. Probe connection
17. PC interface/charger USB-C port
18. Neck and hand strap fasteners
19. Compartment for reset button, SD card, HDMI port
20. Microphone connector (3.5 mm)

Tilt stand, tripod mount (back of unit), and sun visor are not pictured.

## SETTINGS MENU

Press the Settings button  to open or close the menu. The menu has two pages, tap the up/down ( $\Delta$   $\nabla$ ) touch-screen arrows to scroll. Tap an item to open it or to enable/disable it.









Menu items are briefly described below. For complete information, please refer to the online user manual.

<b>Wi-Fi</b>	Switch Wi-Fi on/off, set password ( <i>settings</i> icon), and view the SSID.
<b>DISPLAY GRID</b>	Enable/disable the display measurement grid. <b>Digital cameras only</b>
<b>TIMESTAMP</b>	Enable to include date and time with recorded images and video.
<b>EXTERNAL MICROPHONE</b>	Enable microphone to record voice-overs on-to video.
<b>USB CARD READER</b>	Connect to a PC via USB to share images/video and to update firmware (INFO menu).
<b>SD CARD</b>	View memory status, format card, and delete all images/video.
<b>IMAGE</b>	Set display brightness, contrast, and sharpness. <b>Digital cameras only</b>
<b>MEASUREMENT PARAMETERS</b>	Set emissivity, reflected temperature, and temperature units. <b>IR camera only</b>
<b>AUTO POWER OFF</b>	Disable or set to 5, 10, 20, or 30 minutes.
<b>DATE / TIME</b>	Set and format the calendar clock.
<b>LANGUAGE</b>	Select local language.
<b>RECORDING QUALITY (VIDEO)</b>	Set to Normal (1 M bits/s) or High Quality (2 M bits/s). <b>Digital cameras only</b>
<b>PROBE SELECTION</b>	Select the probe that you are using from the list. <b>Digital cameras only</b>

<b>INFO</b>	View firmware version, upgrade firmware, and revert settings to factory default.
<b>ASPECT RATIO</b>	<b>IR camera only.</b> Toggle 4:3 and 16:9 display formats.



### DIGITAL CAMERA TOUCH SCREEN ICONS







Tap an icon to enable/disable it or to open its submenu. Refer to the probe's user manual for more information.

	Switch the exposure compensation filter on/off (brightens dark areas).		Switch dust elimination filter on/off. For use with mirror accessories and dual camera model.
	Switch worklight on/off.		Forward/side view split screen. For use with mirror accessories and dual cameras.
	Switch the mirror image on/off.		Change the direction of the worklight (side/forward) when using mirror accessories or dual camera.
	Opens the image gallery. Select an image to compare with the live image on a split-screen.		Switch the image negative on/off.
	Rotate image clockwise (90°, 180°, 270°).	<b>WB</b>	Set the white balance.



### IR CAMERA TOUCH SCREEN ICONS

Tap an icon to open its submenu. See the probe user manual for more information.

	Rotate image clockwise (90°, 180°, 270°) or view mirror image.
	Select color palette (Iron, Rainbow, Gray) or alarm mode (Above alarm, Below alarm).
	Tap to open the Measurement submenu for Center Spot, Cold Spot, Hot Spot, and No Measurement modes, explained below.

	Center spot: Temperature of spot is displayed on upper left.
 	The coldest (cyan cross-hairs) or hottest (red cross-hairs) spot is targeted in the boxed region of the image. The spot temperature is shown on the upper left side of the display. Tap and drag the box to move it, use the navigation buttons (up [5], down [6], left [7], right [8]) to re-size it, or pinch/stretch the box with two fingers to narrow or widen it.
	No Measurements: Temperature is not measured.
	Temperature Scale. Use Auto (A) in normal operation; Use Manual (M) to limit the temperature range, based on the temperature of the targeted spot.
	Measurement parameters: Set emissivity, reflected temperature, and temperature units.

### ABOVE AND BELOW ALARMS (IR CAMERA)

To set an alarm, tap the palette icon  and select the *Above*  or the *Below*  alarm.

In Above alarm mode, the camera will apply a red color to all parts of the image with a temperature above the alarm set point. In Below alarm mode, the camera will apply a blue color to all parts of the image with a temperature below the alarm set point.

Tap and drag the color bar graph to adjust the set point.

### CUSTOMER SUPPORT

The FLIR support site, address below, is your resource for obtaining firmware upgrade files, latest versions of user manuals, customer service, and other product and accessory information.

<https://support.flir.com>

### Three-Year Limited Warranty

This product is protected by FLIR's 3-Year Limited Warranty. Visit [www.flir.com/testwarranty](http://www.flir.com/testwarranty) to read the 3-Year Limited Warranty document.





# Quick Start

---

**Website**

<http://www.flir.com>

**Customer support**

<http://support.flir.com>

**Copyright**

© 2022, FLIR Systems, Inc. All rights reserved worldwide.

**Disclaimer**

Specifications subject to change without further notice. Models and accessories subject to regional market considerations. License procedures may apply. Products described herein may be subject to US Export Regulations. Please refer to [exportquestions@flir.com](mailto:exportquestions@flir.com) with any questions.

Publ. No.: NAS100100  
Release: AC  
Commit: 83794  
Head: 84876  
Language: en-US  
Modified: 2022-03-08  
Formatted: 2022-05-06