



USER'S GUIDE

6250

Phase Angle Voltmeter

Warranty

This Vitrek instrument is warranted against defects in material and workmanship for a period of two years after the date of purchase. Vitrek agrees to repair or replace any assembly or component (except batteries) found to be defective, under normal use, during the warranty period. Vitrek obligation under this warranty is limited solely to repairing any such instrument, which in Vitrek sole opinion proves to be defective within the scope of the warranty, when returned to the factory or to an authorized service center. Transportation to the factory or service center is to be prepaid by the purchaser. Shipment should not be made without prior authorization by Vitrek.

This warranty does not apply to any products repaired or altered by persons not authorized by Vitrek or not in accordance with instructions provided by Vitrek. If the instrument is defective as a result of misuse, improper repair, or abnormal conditions or operations, repairs will be billed at cost.

Vitrek assumes no responsibility for its product being used in a hazardous or dangerous manner, either alone or in conjunction with other equipment. Special disclaimers apply to this instrument. Vitrek assumes no liability for secondary charges or consequential damages, and, in any event, Vitrek's liability for breach of warranty under any contract or otherwise, shall not exceed the original purchase price of the specific instrument shipped and against which a claim is made.

Any recommendations made by Vitrek or its representatives, for use of its products are based upon tests believed to be reliable, but Vitrek makes no warranties of the results to be obtained. This warranty is in lieu of all other warranties, expressed or implied and no representative or person is authorized to represent or assume for Vitrek any liability in connection with the sale of our products other than set forth herein.

Instrument Serial Number: _____

Document Part Number MO-6250-M Revision B

Copyright

Copyright© 2005 Vitrek. All rights reserved.

All rights reserved. No part of this publication may be reproduced, transmitted, transcribed, stored in a retrieval system, or translated into any language in any form with prior written consent from Vitrek. This product manual is copyrighted and contains proprietary information, which is subject to change without notice. The product displays and manual text may be used or copied only in accordance with the terms of the license agreement.



is a trademark of Vitrek. All other trademarks or registered trademarks are acknowledged as the exclusive property of their respective owners.

In the interest of continued product development, Vitrek reserves the right to make changes in this guide and the product it describes at any time, without notice or obligation.

Vitrek

*Manufacturers of Engineering & Production Test Equipment
12169 Kirkham Road
Poway, CA 92064
(858) 689-2755
E-Mail: info@vitrek.com*

Contents

Warranty	3
Introduction	11
Features	11
Principles of Operation	12
Central Processor	12
Signal Conditioning and DSP Sections	13
Input Scaling	14
Amplitude Measurement Circuitry and DSP	14
Frequency Measurement	15
Range/Mode Control	15
Sample Clock Generation	15
Filter Clock Generation	16
Front Panel Operation	17
Front Panel Operational Features	17
Power Switch	17
The Display	17
Display Select Keys	18
Enter Key	18
The Up and Down Arrow Keys	19
The Left and Right Arrow Keys	19
Numeric Entry Keys	19
Harms Keys	19
Clear Key	20
Units of Measure Keys	20
Store & Recall Keys	20
Setup Key	21
Local Key & Indicator	21
Calibration Key	22

Print Key _____	22
The Nullmeter _____	22
Input Connector Keys & Indicators _____	23
Making Input Connections _____	24
Guard Connections _____	24
Input Cables _____	25
Using the Operational Keys _____	25
Changing Displayed Information or Settings _____	25
Setting Defaults _____	27
Entering New or Changed Information _____	32
Setting/Formatting Time & Date _____	33
Storing & Retrieving Configurations _____	34
Store & Recall Memory Menus _____	34
Storage Area Maintenance _____	35
Repacking of the Storage Areas _____	36
Rear Panel _____	39
Connectors & Controls _____	39
Power Connection _____	39
Configuration Control Switch _____	40
Parallel Printer Interface _____	40
RS232 Connectors _____	40
IEEE488 Connector _____	40
Configuration Setup _____	41
Setup Guidelines _____	41
Input Configuration Menu _____	45
Input Scaling _____	45
Guard _____	45
Measurement Configuration Menu _____	46
Fundamental Frequency _____	46
Fundamental Frequency Range _____	47
Fundamental Source _____	47
Nominal Amplitude Measurement Period _____	48
Filter Frequency _____	48
Maximum Harmonics _____	49
Fundamental÷Bandwidth _____	50
Analysis _____	50
Fundamental Frequency Averaging _____	51
Fundamental Frequency Measurement Period _____	51

Nullmeter Display Menu	51
Nullmeter Parameter Types	52
Parameter Display Menus	52
Parameter (p)	52
Reference Parameter (r)	56
Reference Parameter Type	56
Data Result Units	56
Comparison Limit	58
Filter Time Constant	58
Some Useful Hints	58
Showing Percentages & dB Changes	58
Unstable Displayed Results	59
Display Line Format	59
Nullmeter Scale Menu	60
Scale Factor	61
Type	61
Additional Application Examples	62
Interface Operation	67
RS232 Data Format Selection	67
IEEE488 Interface Setup	67
Configuring the Controller Card	69
Configuring the Controller Software	70
Interrogating the Data	71
Reading Data	71
Sending Data	72
RS232 Interfacing	72
IEEE488 Interfacing	73
Bus Timing	73
Bus Commands	73
Application for the Lower Case Portions of Commands	74
Command Set	74
Interface Commands	75
Available Parameter Strings	78
Retrieving Parameters	79
Source and Bandwidth Strings	83
Sub-Definition Strings	84
Special Parameter Strings	85
ID Data Format	86

UNITS=String Format _____	86
Full-Parameter Definition Format _____	87
High Speed Operation _____	88
Measurement Periods _____	89
Frequency Measurement _____	89
Harmonic Measurement _____	89
Interrogating Results _____	89
Maintenance & Calibration _____	91
Daily Maintenance _____	91
Low Level DC Measurements _____	91
Procedure without Equipment _____	91
Procedure with Equipment _____	92
External Calibration _____	93
Preparation for Calibration _____	94
Required Equipment _____	95
Calibration Procedure _____	95
Performing a Partial Calibration _____	97
Performing a Calibration Check Only _____	97
Appendix A: AIO Option _____	99
AIO Option Features _____	99
AIO Option Commands _____	99
Appendix B: Specifications _____	101
Voltage Input _____	101
Current Input _____	102
Input Filtering _____	102
Phase _____	102
Fundamental Frequency Measurement _____	103
Harmonic Analysis _____	103
Peak Parameters _____	104
Date and Time _____	104
General _____	104

Figures

Figure 1. System Block Diagram	12
Figure 2. Digital Signal Processing Block Diagram	13
Figure 3. Sample Clock	16
Figure 4. The 6250 Voltmeter Front Panel	17
Figure 5. Display Showing Results Data	18
Figure 6. The Nullmeter	22
Figure 7. Input Terminals	23
Figure 8. Display Line Configuration Data	26
Figure 9. Rear Panel Partial View	39
Figure 10. Initial Setup Display	41
Figure 11. Setup Measurements Display	42
Figure 12. Input Configure Display	43
Figure 13. Nullmeter Sample Display	44

Configuration Examples

➤ To change a display line of Results Data:	26
➤ To select an option:	26
➤ To set parameter and setup measurement defaults:	27
➤ To set the nullmeter parameter default:	30
➤ To abort a displayed menu and discard any changes:	30
➤ To change a display line:	30
➤ To adjust a “noisy” measurement (to a given value):	31
➤ To provide a “fast/medium/slow” style of adjustment capability:	31
➤ To add display lines (up to 50 lines possible):	31
➤ To delete a display line:	32
➤ To add dashes in a display line as a separator:	32
➤ To “enter” data and changes using the flashing cursor:	32
➤ To “enter” data and changes—when no cursor is visible:	32
➤ To adjust the time display:	33
➤ To format the time display:	33
➤ To set the date format:	34

- To set the date display: _____ 34
- To store a configuration in an already defined storage area: _____ 35
- To store a new configuration (presently displaying): _____ 35
- To recall a configuration: _____ 35
- To rename an existing storage area: _____ 36
- To delete a storage area: _____ 36
- To manually prompt the repacking of storage areas: _____ 36
- Setting fundamental frequency mode & range for input connectors: _41
- Setting the input mode for each input connector: _____ 43
- To change the (input) scale factor: _____ 44
- Setting the Guard connection for each input connector: _____ 44
- To configure the Nullmeter parameter display: _____ 44
- To complete a configuration setup: _____ 45
- To measure signal content of harmonics, amplitude, phase & sync: _62
- To measure harmonic content & wideband amplitudes in sync: ____ 64
- To perform spectral analysis of the input signal. _____ 64
- To measure wideband amplitudes over a known period of time: ____ 65
- To perform an external calibration: _____ 95
- To perform a calibration check: _____ 97

Introduction

Congratulations on purchasing one of the high technology signal analysis instruments available from Vitrek. The 6250 Phase Angle Voltmeter offers the utmost in accuracy and flexibility.

This instrument contains an automatic switching power supply, thus no changes are required for local AC supply voltage or frequency variations, simply select the power cord extension that connects to your supplied power.

Features

The following lists some of their significant features of the 6250 Phase angle Voltmeter.

- Fully digital signal processor (DSP) based operation, no analog phase-locked loops, phase detectors or other delicate, inaccurate circuitry. This instrument has a 0.0005Hz to 200kHz range of frequencies.
- True 18-bit resolution on each input, which yields exceptional phase, amplitude and harmonic resolution.
- 500kHz sampling frequency on each input simultaneously, which yields excellent high frequency accuracies, even with heavily distorted waveforms, and the widest range of harmonics measurement (up to the 2047th harmonic).
- DSP based fundamental frequency component detection, which yields the widest range of fundamental “reference” input, even when buried in noise and distortion.
- Two 40MHz 24-bit Digital Signal Processors for each pair of inputs, and one 68020 32-bit Central Processor, which yields the highest measurement speeds available.
- Full Range of measurement capabilities, not just amplitude, frequency and phase. THD, inter-harmonic phase, spectrum analysis, cross-correlation are just a few of the additional measurements available at the touch of a button.
- Fully customizable display window. Shows 4 lines at a time and is scrollable to 50.

- High resolution bargraph containing 101 elements and two supporting interface keys.
- Both voltage and current input capabilities on each input, which allows for high accuracy power measurements from a few nanowatts to hundreds of watts.
- The interface package adds control capabilities with the IEEE488 and RS232 connections; printing capacity with the Parallel printer connectors; and analog output ability with 12 analog connections, when AIO option is fitted.

Principles of Operation

For basic details regarding the circuitry and methods used in the 6250 instruments, Figure 1 shows the overall block description of their internal system's circuitry.

Central Processor

The central processor consists of circuitry surrounding a Motorola 32-bit MC68EC020 processor and a MC68882 math co-processor, both of which run at 25mHz. These processors perform all interfacing and inter-digital signal processing and coordination required in the instrument. The software run by this processor is stored in flash memory, allowing the instrument's software to be field upgradeable without requiring removal of the covers or any circuitry.

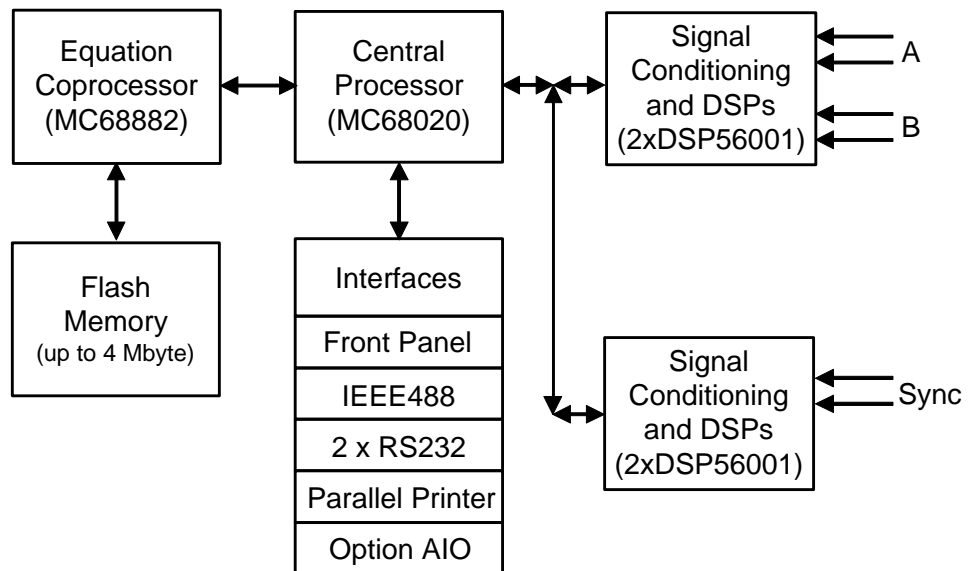

Figure 1. System Block Diagram

The interface of this processor to the interface components: IEEE488, (2) RS232 and Parallel Printer is via the processor's native bus interface. This bus interface uses standard commercial integrated circuits for hardware. All of these interfaces use interrupt driven software to perform their input/output duties, yielding a high-speed interface.

Signal Conditioning and DSP Sections

For each pair of the instrument's inputs, there is a set of circuitry that contains two Motorola DSP56001 24-bit processors interfaced to the central processor. The interface is made via a high speed RS485 data link. Refer to Figures 1 and 2.

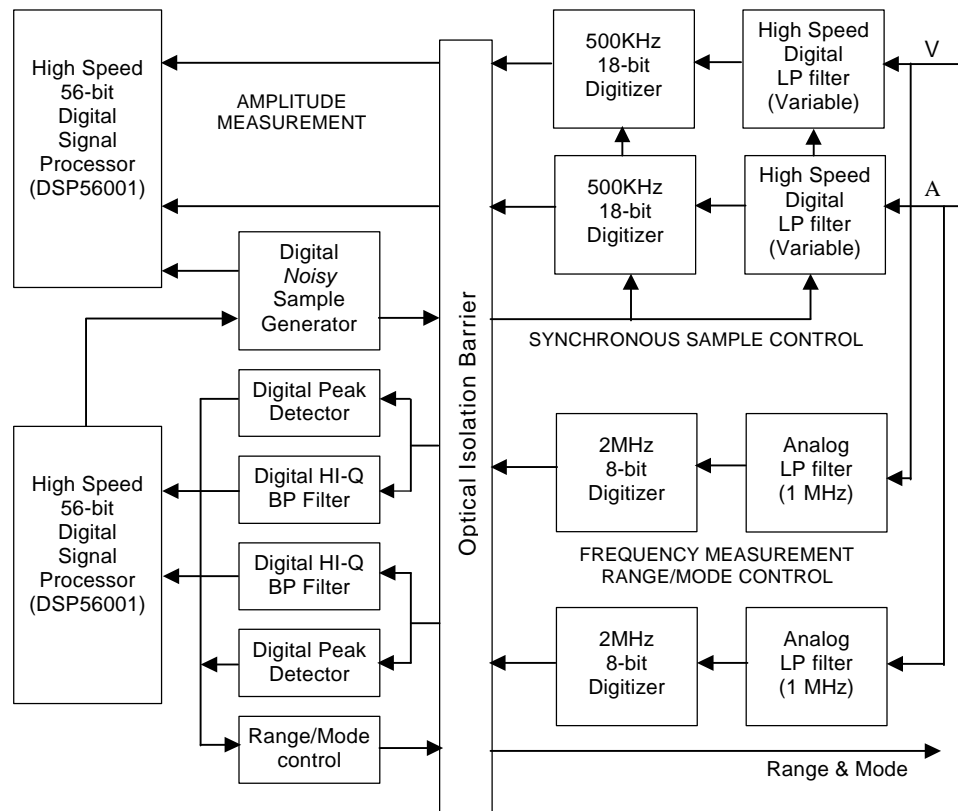

Figure 2. Digital Signal Processing Block Diagram

These sections also provide the primary isolation between the grounded digital circuitry of the instrument and the floating input circuitry via an optical isolation barrier, which passes digital signals only.

Each of these sections is capable of operating independently, or can be “joined” to one or both of the other sections to perform simultaneous sampling, as required, by the central processor.

Input Scaling

Each input has identical systems that perform the required scaling of the input signals to the levels required by the amplitude and supervisory systems. Each input’s scaling is fully differential throughout, and is powered by isolated power supplies having its common driven by the respective **GUARD** terminal. In this manner, excellent common-mode performance is achieved, and the signal quality delivered to the respective amplitude and supervisory sections is maintained, even in a digital “backplane” environment. Each input’s scaling and mode is controlled by parallel digital codes provided by the relevant supervisory DSP. The form of amplification chosen maintains excellent phase shift, even at high frequencies, using many gain stages for amplification. Each gain stage is configured to produce the same nominal phase shift independent of gain setting. Each input system also presents the **GUARD** terminal connection to its amplitude and supervisory DSPs to act as the common for their isolated power supply requirements.

Amplitude Measurement Circuitry and DSP

Each input, after scaling, is filtered by a high speed digital low-pass filter having its corner frequency (filter clock frequency) controlled by one of three filter clocks common to all amplitude systems. After filtering, each input signal is then converted to 18-bit digital form by an 18-bit. analog-to-digital converter system, whose sample clock is taken from one of three sample clocks common to all amplitude systems. Each converter consists of a pair of time interleaved 250kHz converters, allowing for sampling up to 500kHz. Refer to Figure 2, the Digital Signaling Processing Block diagram.

The output of all four converters (two per input) is read by Motorola’s digital converter, DSP56001, at a rate controlled by the same sample clock used by the converters. This processor performs all amplitude and harmonic analysis required by the system, and maintains a database of the results of the latest such measurements for its channel. The central processor gains access to these results via a high speed RS485 data link. This same link is used to pass to the DSP the selections to use for its sample and filter clock signals, and details regarding the measurements to be made. The channel’s circuit board with this harmonic analysis DSP is internally named the "Amplitude DSP".

Frequency Measurement

Each scaled input passes to a second sub-system for additional analysis. This second sub-system is internally named the “Supervisor DSP” board and consists of the following portions:

Filter and High Speed ADC—Each input passes through an analog 1mHz low pass filter, and sampled at 2mHz by a pair of 8-bit analog-to-digital converters.

Supervisory Processor—The outputs of the pair of 8-bit converters is read by a Motorola DSP56001, which performs several asynchronous tasks using this data. This processor is linked to the central processor using the high speed RS485 data link.

Range/Mode Control

Overload and Underload Detection—Each sample is checked for overload status. If an overload is detected then the DSP changes the range presented to the input scaling circuitry (if able) and informs the central processor that a range change has occurred.

If an underload condition remains for longer than a period provided by the central processor (actually set by the minimum fundamental frequency expected) then the DSP changes the range presented to the input scaling circuitry (if able), and informs the central processor that a range change has occurred. This process is continuous, independent between the inputs, and completely independent of any other activities in progress in the instrument. You can also set a fixed range, rather than the above autorange process.

Bandpass Filtering and Frequency Measurement—Input samples are passed through a proprietary system. The system performs a tracking bandpass filter function, maintaining track of the fundamental frequency reading within set range. This tracked frequency reading is then used to measure the frequency of the remaining signal component. This process is continuous and independent between the inputs, and completely independent of any other instrument or supervisory processor activities in progress.

Sample Clock Generation

Under the direction of the central processor, the supervisory DSP controls circuitry contained in an ASIC, which generates a digital clock signal whose average frequency is settable with 20-bit resolution over a 2:1 range of frequencies. This clock signal is available to all amplitude DSP systems on one of three such signal

lines. If desired by the central processor, the supervisory processor can “link” this frequency to that of either of its measured input frequencies. The form of the sample clock is such that the individual sample-to-sample clock period can vary by up to 1%, however, the average over any 256 sample period is always within 1ppm of the set value. This “jittered” sampling ensures that no input signal component can be synchronous to the amplitude system’s sample rate, removing the anomalous effects that occur when this happens.

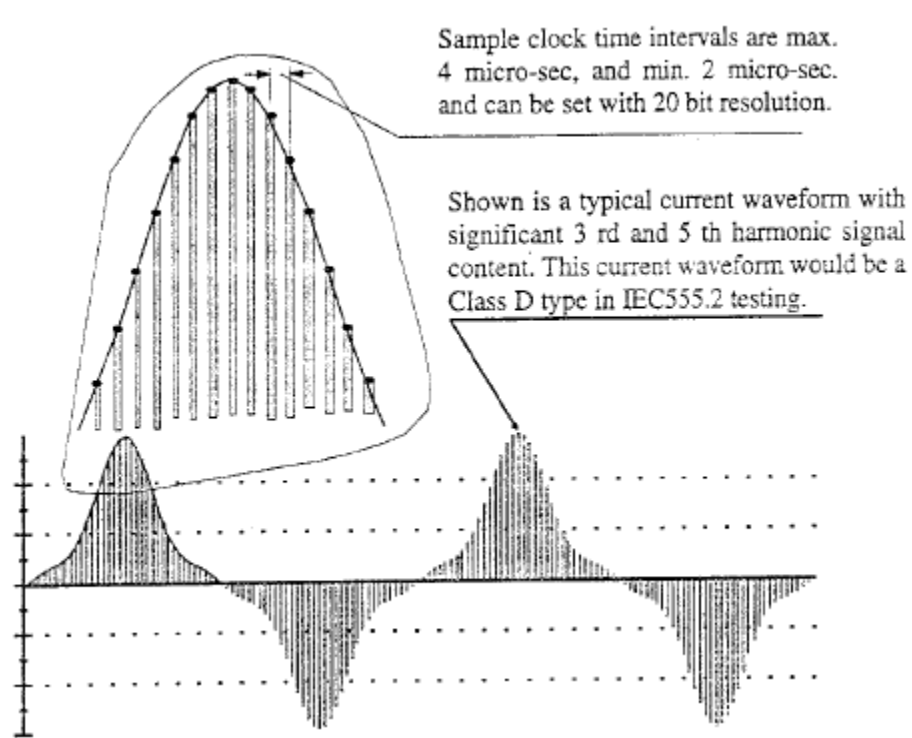

Figure 3. Sample Clock

Filter Clock Generation

Under the direction of the central processor, the supervisory DSP controls circuitry contained in an ASIC which generates a digital clock signal whose frequency is selectable in 1.2:1 steps over 4.5 decades of frequencies. This clock signal is available to all amplitude DSP systems on one of three such signal lines.

Front Panel Operation

This section includes a description of the front panel interface features of the Phase Angle Voltmeter instruments and their basic operation. Refer to Configuration Control for an explanation of the menus.

Front Panel Operational Features

The 6250 Phase Angle Voltmeter instrument has a number of controls and indicators available. See Figure 4.

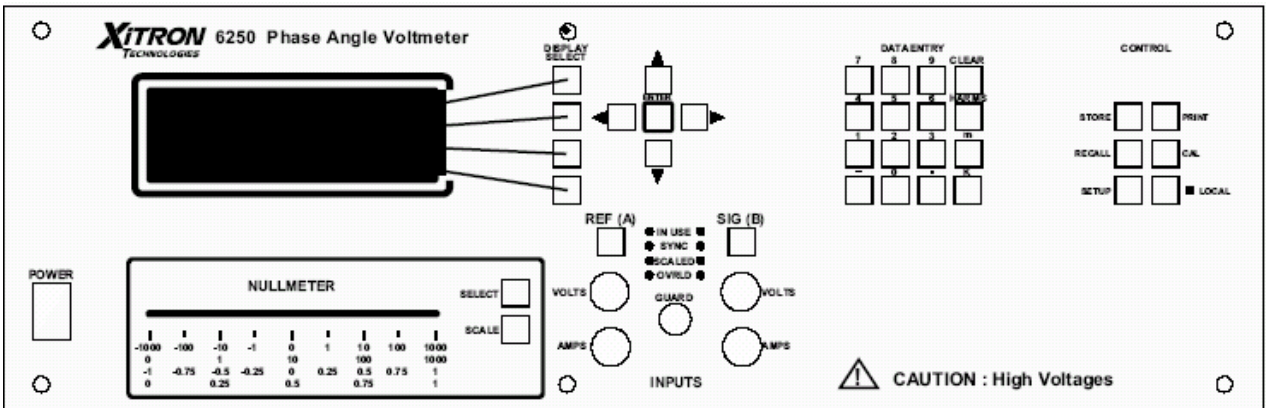

Figure 4. The 6250 Voltmeter Front Panel

Power Switch

Turns the unit ON and OFF.

The Display

The front panel display is a “window” that provides a visual interface to the alphanumeric measurement Results Data and the changeable configuration menus. Refer

to Figure 5. The instrument's display can show (up to) four lines of information at one time and maintains up to fifty lines of displayable measurement results, which are accessible by scrolling. You can add or delete lines, as necessary. The display is the interface focus, as it responds to all front panel key presses, showing the options available for that key. The display responds to all front panel keys.

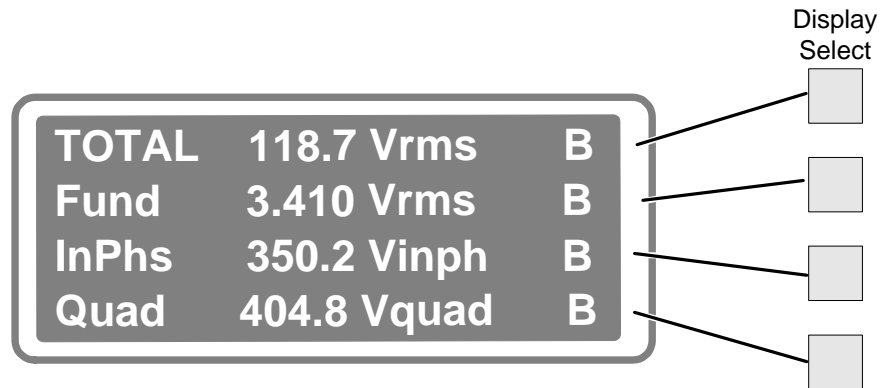
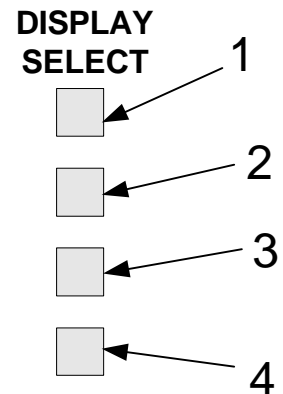

Figure 5. Display Showing Results Data

Display Select Keys

These keys are located to the right of the display. The topmost key is 1, second is 2, third is 3, and fourth is 4:

- Use the Display Select keys to bring up the configuration for each line of Results Data, including blank lines.
- Use to place the cursor in a display line.
- Use in combination with arrow keys, to scroll through options to edit a configuration menu item.
- Use the DISPLAY SELECT 1 key to page through the various parameter screens.



Enter Key

The **ENTER** key is located at the center of the arrow keys and is used to:

- Implement the action per the changes made in either a menu line or a menu.
- Enter updated data into the menu settings. Press it twice to action the configuration.
- Press the ENTER key once to remove the cursor. Press it twice to action the configuration.

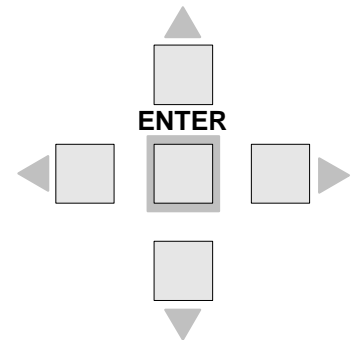

The Up and Down Arrow Keys

The **↑** and **↓** keys (up and down arrows) are used:

- To scroll the display Results Data lines, one line at a time;
- To scroll through menu selectable options at a cursor position;

When no cursor displays, use the **↑** and **↓** keys to scroll through various parameter menu details given in the last three configuration menu lines.

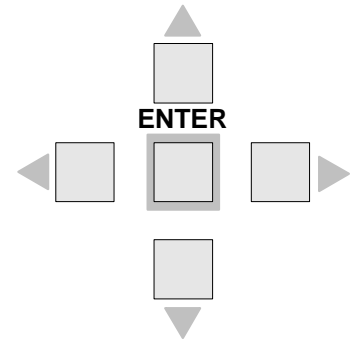

The Left and Right Arrow Keys

The **←** and **→** keys (left and right arrows) are used:

- To move the cursor to a new selectable option within a menu line.

When no cursor displays, use the **←** and **→** keys to scroll through various parameter menu details given in the last three configuration menu lines.

DATA ENTRY

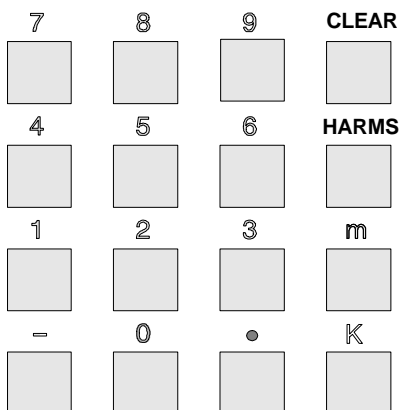

Numeric Entry Keys

These keys are part of the **DATA ENTRY** keypad.

- Use the numbered keys to enter numerical data into the display.
- Use the - (minus sign) to enter negative integers and to change negative integers to positive, as required.
- Use the . (decimal point) to enter decimal values.

Harms Key

This key is part of the **DATA ENTRY** keypad. The **HARMS** key toggles the “bandwidth” selection between AC+DC and a harmonic range.

DATA ENTRY

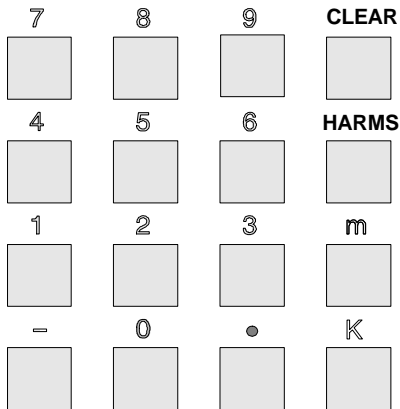

Clear Key

The **CLEAR** key is part of the **DATA ENTRY** keypad.

- Use this key to discard changes made in either a menu or menu line.
- Use this key to abandon any change made, which restarts the selection from the beginning.

Units of Measure Keys

Use the **m** and **K** keys to designate “micro” and “kilo”. Note that these keys become automatically disabled when not applicable for the data being entered.

Store & Recall Keys

The **STORE** and **RECALL** keys are part of the **CONTROL** keypad. These keys are used within the Configuration Setup menus to:

- Store configurations in the internal non-volatile “library” (65535 configurations).
- Recall any of the stored configurations.
- Overwrite and remove a configuration, select or enter the number of an already defined stored configuration.

Refer to *Storing and Retrieving Configurations* on page 34.

CONTROL

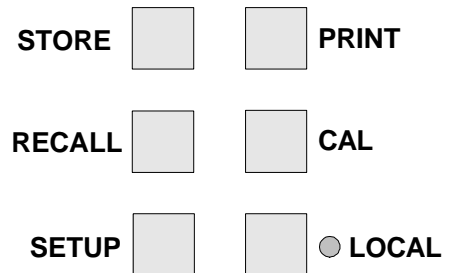

Setup Key

The **SETUP** key brings up a menu list so you can reset the instrument to its default configuration. Note that the Measurement Configuration default is set to measure signals in the 40Hz to 500Hz frequency range.

- Use the **SETUP** key to set Analog inputs and outputs. Note that the AIO option, if fitted, provides additional outputs.
- Use to set the IEEE488, RS232 interfaces and Parallel printer. For more details refer to *Interface Operation* on page 67.
- Use to set the display format of time and date information. Refer to *Setting/ Formatting Time & Date* on page 33, for details.
- Use to set the internal real time clock.
- Use to enable the ↓ key to scroll the display to the lowermost menu lines.
- Use to perform “covers-on” software upgrades. Contact Vitrek for specific details to perform software upgrades.

CONTROL

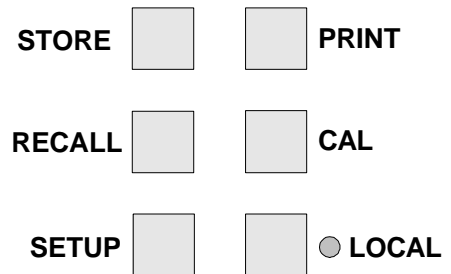

Local Key & Indicator

The **LOCAL** key is part of the **CONTROL** keypad.

- Use to return control to the front panel when using the IEEE488 interface to another controller. For more details refer to *Interface Operation* on page 67.
- The indicator light illuminates when front panel operation is active.

Calibration Key

The **CAL** key, is used to perform the following tasks:

- Display the present status of the instrument:
 - Model
 - Options fitted
 - Software version
 - # of days since last calibration
 - Status of the internal multiprocessor communications and memory checks.
- Test of the internal digital and analog circuitry.
- Perform an Internal, Input, and External Calibration of the instrument.

CONTROL

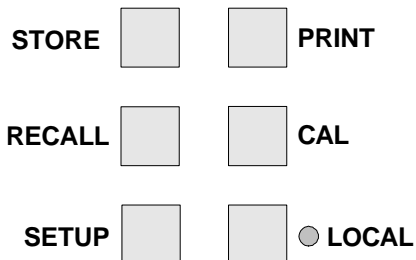

Print Key

- Use the **PRINT** key to print the display menu or data results.

The Nullmeter

The nullmeter is a lighted bargraph. You can customize the graph by pressing its **SELECT** and **SCALE** keys.

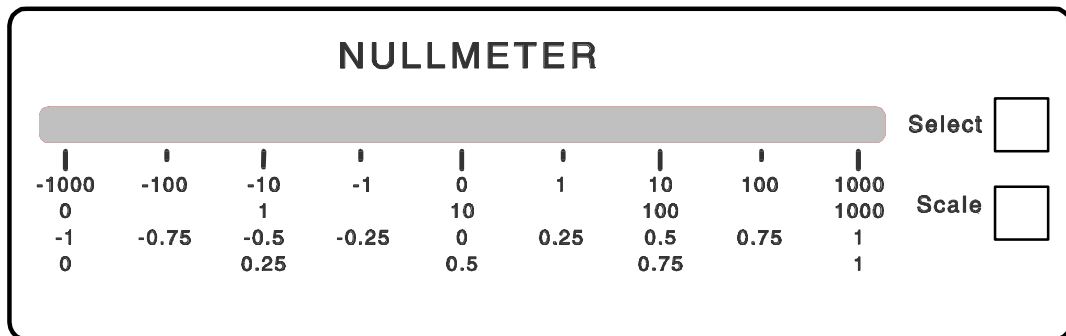

Figure 6. The Nullmeter

The **NULLMETER SELECT** key allows you to select the parameter to be displayed on the nullmeter in the same manner as defining a display line parameter.

Note: If the zero position of the nullmeter is defined as other than zero, then a deviation parameter must be selected to perform the required offset. Refer to the *Nullmeter Display Menu* on page 51, for details on displaying Nullmeter results.

The **NULLMETER SCALE** key allows you to select the:

- Scaling type: dot or bar;
- Linearity: linear or logarithmic;
- Zero position: left, centered, or mirrored around the center.

Note: The center zero position, log-scaled format provides a useful adjustment capability of “coarse/medium/fine”. Refer to *Nullmeter Scale Menu* on page 60.

Input Connector Keys & Indicators

Use either the voltage (**VOLTS**) or the current (**AMPS**) input connection, but not both. The 6250 voltmeter has inputs **A** and **B** as shown in **Figure 7**. If you select an externally driven guard, then connect a convenient source of a low impedance-guarding signal to the **GUARD** terminal.

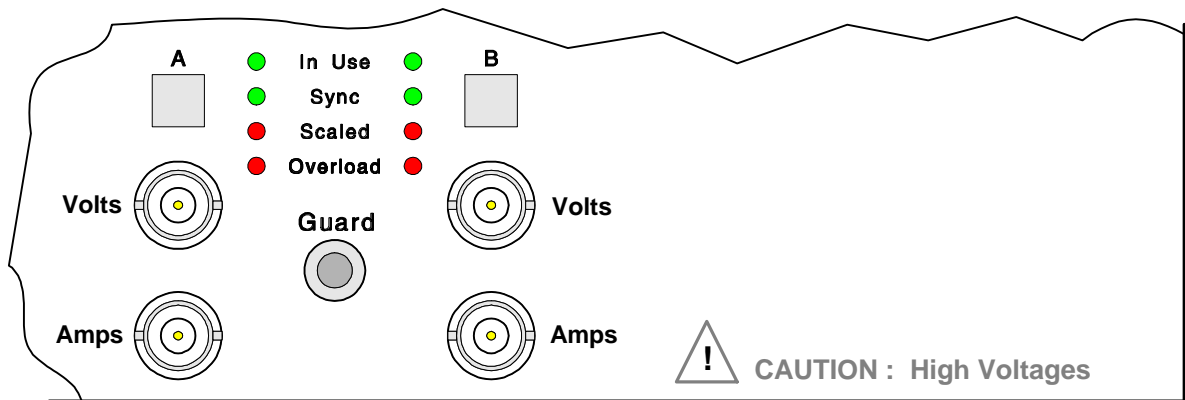

Figure 7. Input Terminals

Warning: Ensure that all voltages are removed before coming in contact with any of the input signal wiring to your voltmeter. This caution particularly applies to the outer cover of the input BNC connectors.

Use the respective input: **A** or **B** key:

- To select the individual input range (or autorange) and mode desired.
- To set a desired amplitude scaling for each individual input.

- To select whether the **GUARD** terminal is to be internally or externally driven. Refer to *Configuration Setup* on page 41.

View the respective connector's indicator lights to determine, which input is being:

- Measured (**IN USE**);
- Used for fundamental frequency determination (**SYNC**);
- Scaled (**SCALED**);
- Overloaded (**OVERLOAD**). The instrument automatically protects itself against serious overload, even when held on the most sensitive input range

Notes:

- 1) The maximum voltage between the **GUARD** terminal and an INPUT LOW is 10V for all voltage ranges of 2.5V and below, and for all current ranges. On the higher voltage ranges, up to 1000V may be present between the terminal and input.
- 2) Noisy and inaccurate readings may result if the **GUARD** terminal is left disconnected when external guard has been selected.

Making Input Connections

When deciding which inputs to use, attempt to follow the same pattern for all applications. Use the following guidelines:

- If measuring amplitudes and/or distortion of a single signal, use input **A**.
- If measuring phase (or phase related amplitudes) between a pair of signals, connect the “reference” signal to input **A** and the “unknown” signal to input **B**.
- If making a power measurement, use input **A** for voltage and **B** for current.

Guard Connections

The input capacitance of each input to ground is very low (a few hundred picofarads) thus the use of an external connection for guard is rarely needed. We recommend using “external guarding” under the following circumstances:

- If low level (less than 1V or 10mA) signals are being measured in the presence of significant common mode voltages or interference.
- If the input connections are extremely long (greater than 10ft).
- When using the current input, current low **MUST** be externally connected to the **GUARD** terminal. And the input pair configured to use External guard.
- When using internally connected Guard, choose the input having the largest signal.

Input Cables

Signal input connections are made to the front panel BNC connectors, using the **V** or **A** connector for each input as desired. Each input is configured, such that the outer shell of the connector is the input LO (negative) connection, and the central pin is the input HI (positive) connection.

- Reconfigure each input while no signals are present.
- Check the configuration of each input prior to making connections, particularly the **GUARD** connections.

Warning: NEVER TOUCH the outer shell of any of the BNC connectors (including unused ones) when signals are applied to the instrument.

Recommendations:

- 1) Use cables that are similar in both construction and length, particularly when making high frequency phase sensitive measurements. The phase shift caused by dissimilar cable lengths is of the order of 0.03° per foot at 100kHz.
- 2) When measuring voltages, reduce potential interference and crosstalk between inputs by using shielded cables (e.g., coaxial cable). If input capacitance is of concern, then use small gage twisted pairs of wire, tightly wound.
- 3) When measuring currents, particularly at the lower levels (10mA and less), use twisted pairs of wires tightly wound of sufficient gage for the current being carried.
- 4) In the presence of severe interference, or where the current signal has significant common mode voltage, keep the input connections as short as possible.
- 5) Make the **GUARD** connections (if any) with any suitable form of connection.

Using the Operational Keys

Whether viewing a display showing parameters, measurement results, or configuration menu items, the method of front panel operation is the same. Refer also to *Configuration Setup* on page 41.

Changing Displayed Information or Settings

To enter changes to a configuration, press a **DISPLAY SELECT** key to place the cursor on the line of data you are modifying. If you press the **ENTER** key once, the cursor disappears, although the displayed menu accommodates the new data. Press a **DISPLAY SELECT** key again to place the cursor in the display. If you press the **ENTER** key twice the new data is applied and the display shows the Results Data.

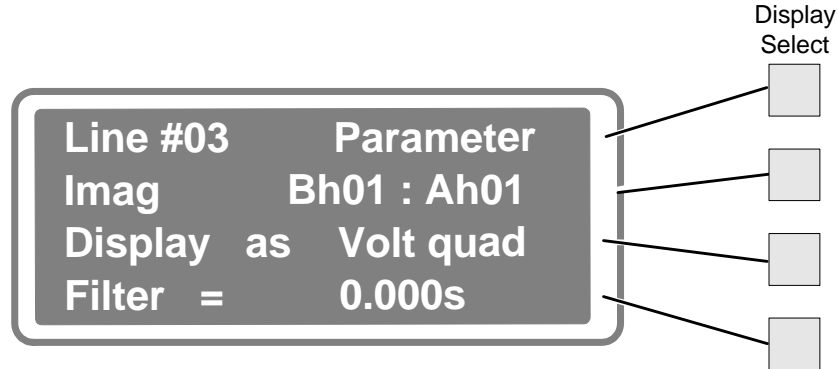

Figure 8. Display Line Configuration Data

- *To change a display line of Results Data:*
 1. While the display shows the Results Data screen, press the **DISPLAY SELECT** key that corresponds to the display line requiring change. A display showing parameter values will come up.
 2. Press a corresponding **DISPLAY SELECT** key a second time. A cursor will flash in the display line to allow you to:
 - Directly change the displayed information at the cursor.
 - Change the displayed selection to the next one available.
 3. Use the **←** and **→** keys to move the cursor to the data or option you wish to change.
 4. Use the **DATA ENTRY** keys to enter a value.
 5. Press the **↑** and **↓** keys to scroll the options, as required.
 6. Press the **ENTER** key twice to apply the change.

- *To select an option:*
 1. From the Results Data display, press a **DISPLAY SELECT** key that correlates with the line of Results Data you wish to modify. Refer to the *Display Select Keys* on page 18.
 2. From the Parameter display, press the **DISPLAY SELECT** key that correlates with the line containing the option you wish to select, until the cursor flashes at the option.
 3. Use the **↑**, **↓**, **←** and **→** keys to select a new option. Press **ENTER** twice.

Setting Defaults

➤ *To set parameter and setup measurement defaults:*

Important Note: This action applies to all configured Results Data display lines. Store any preferred setups before performing this step.

1. Press the **SETUP** key.
2. Press the **DISPLAY SELECT** key correlating to **Set Defaults**. The defaults will automatically apply.
3. Press the **ENTER** key. The Results Data display will show the first four configured lines, which are based on the preset Parameter and Setup Measurement defaults.

The default Parameter screens for Results Data lines #00 through #09 are as follows:

Total default setup:	Results	TOTAL	xxxxxxx Vrms	B
The amplitude of the harmonics from 1 to 30		Line #00 True RMS Display as Filter = 0.000	Bh	Parameter 1 – 30 Volts rms
Fund default setup:	Results	Fund	xxxxxxx Vrms	B
The amplitude of the Fundamental.		Line #01 True RMS Display as Filter = 0.000	Bh	Parameter 1 – 1 Volts rms
InPhs default setup:	Results	InPhs	xxxxxxx Vinph	B
The amplitude of the input in phase with the reference.		Line #02 Real Display as Filter = 0.000	Bh01	Parameter :Ah01 Volts inph
Quad default setup:	Results	Quad	xxxxxxx Vquad	B
The amplitude of the input out-of-phase with the reference.		Line #03 Imag Display as Filter = 0.000	Bh01	Parameter :Ah01 Volt quad

Phase default setup:	Results	Phase	xxxxxxx°	B
The phase difference between signal and reference.		Line #04 Phs	Bh01--Ah01 Display as +/- 180° Filter = 0.000	Parameter
THD-f default setup:	Results	THD-f	xxxxxxx%	B
The THD as referenced to the fundamental		Line #05 THD-Fund	Bh < 30 Display as Volts rms Filter = 0.000	Parameter
Total Ratio default setup:	Results	RATIO	xxxxxxx totl	B
The Total of signal divided by the Total of reference.		Line #06 p = True RMS Bh 1-30 r = True RMS Ah 1-30 Updated Ref. Param. Display as totlR		Param/Ref
Fund Ratio default setup:	Results	RATIO	xxxxxxx fund	B
The Fund of signal divided by the fund of reference.		Line #07 p = True RMS Bh 1-1 r = True RMS Ah 1-1 Updated Ref. Param. Display as fundR		Param/Ref
InPhase Ratio default setup:	Results	RATIO	xxxxxxx inph	B
The in-phase part of the signal (vs reference) divided by the Fund of the reference.		Line #08 p = Real Bh 01:Ah01 r = True RMS Ah 1-1 Updated Ref. Param. Display as inphR		Param/ Ref
Quad Ratio default setup:	Results	RATIO	xxxxxxx quad	B
The out of phase part of the signal (vs. reference) divided by the Fund of the reference.		Line #09 p = Imag Bh 01:Ah01 r = True RMS Ah 1-1 Updated Ref. Param. Display as quadR		Param/Ref

The default Setup Measurements are as follows:

<p>Fundamental Frequency Obtain the fundamental: by measuring, using a fixed entry or using a multiple of a measurement.</p>	<p>Fund: Measured</p>
<p>Fundamental Frequency Range Use the largest amplitude signal within this window as the fundamental.</p>	<p>Fund: 40.0 – 500 Hz</p>
<p>Fundamental Source Choose from which input to take the fundamental.</p>	<p>From: AB</p>
<p>Nom Amplitude Measurement Period This is the minimum measurement period.</p>	<p>Min Period 0.250S</p>
<p>Filter frequency The 3dB filter cutoff.</p>	<p>Filter 50.0kHz</p>
<p>Maximum Harmonics The maximum harmonic from which you measure data.</p>	<p>Max Harmonics: 200</p>
<p>Fundamental Bandwidth The “width” or the “Q” of the harmonic data filter.</p>	<p>Fundamental÷BW: 2</p>
<p>Analysis Options are: Normal or Windowed</p>	<p>FFT Type: Normal</p>
<p>Fundamental Frequency Averaging Options are: none, fast, med or slow</p>	<p>Sync Averaging: med</p>
<p>Fundamental Frequency Measured Period The period over which to take the sync measurement.</p>	<p>Sync Period: 0.250S</p>

➤ *To set the nullmeter parameter default:*

1. Press the Nullmeter's **SELECT** key.
2. Press **ENTER** to show Nullmeter Results Data and the Nullmeter's red light will reflect the reading.

The default Nullmtr: Parameter setup is:	p = Phs Bh01/Ah01 Display as +/- 180 Filter = 0.000S
The default Nullmeter Scaling screen is:	NULLMETER SCALING 0 to 1 = + 180.000 Bar Lin Centered

➤ *To abort a displayed menu and discard any changes:*

- Press the **CLEAR** key to abandon any change made and restart the selection from the beginning. Note that the cursor remains in the item being changed.
—Or—
- Select an all-uppercase “heading line” and press the **DISPLAY SELECT 1** key. Press a new **DISPLAY SELECT** key.

➤ *To change a display line:*

1. Within the Results Data display, press the **DISPLAY SELECT** key next to the line to be changed. Use the **↑** and **↓** keys to scroll up and down to the various lines. Note that the topmost line is #00.
2. The display will show the present measurement details/configuration for that Results Data line. Press the **DISPLAY SELECT 1** key repetitively, to change the Parameter Type for the display data.
 - With this menu line, you may select: a single parameter; a deviation between two parameters, such as a parameter and constant; or various “special” data.
 - The menu line corresponding to **DISPLAY SELECT 2** key, indicates the primary (p) parameter for that Results Data display line and it may give the bandwidth, harmonic, or harmonic range that applies to the primary parameter.

Note: These parameters: gain (ratio), real (in phase), imaginary (quad), and phase have a primary input, a reference input and a harmonic specification. Since the 6250 instrument has no dedicated reference input or harmonic specification, it offers greater flexibility in usage.
 - You may select a reference parameter (r) similarly to the primary parameter from a difference (p-r), a ratio (p/r) or a ratio difference (p/r: 1).

-
- You can choose to display the Results Data measurement in units other than the instrument's default units for that parameter. Note that the instrument automatically applies any conversions necessary.
 - Filter the final measurement result using a single pole filter having any time constant between 10mS and 1000S. Note that the filtering applies to each Results Data line. Note that the same parameter or Results Data can be displayed in a separate display line using either no filtering or completely different filtering.
3. Press the **ENTER** once to set the change. This action removes the cursor, but rather than implementing the change allows you to make another edit.
 4. When the displayed menu has been changed to suit your requirements, press the **ENTER** key, once if no cursor is flashing and twice if one is, to action any changes made. The Results Data will display with readings based on the changes you made.
- *To adjust a "noisy" measurement (to a given value):*
1. Press the **DISPLAY SELECT** key next to the line to be changed. The display will show details of the presently selected parameter for this measurement result.
 2. Press the **DISPLAY SELECT** key corresponding to FILTER =.
 3. Enter a numeric value using the **DATA ENTRY** keys to apply a single pole filter having any time constant between 10mS and 1000S.
 4. Press **ENTER** twice.
- *To provide a "fast/medium/slow" style of adjustment capability:*
1. Press the **DISPLAY SELECT** key next to the line to be changed. The display will show details of the presently selected parameter for the measurement result for this line.
 2. Apply a single pole filter having any time constant between 10mS and 1000S.
 3. Select the same parameter for three or more Results Data display lines and apply decreasing degrees of filtering, the smaller the filter the less the adjustment capacity.
- *To add display lines (up to 50 lines possible):*
1. Scroll the Results Data display until a blank line shows.
 2. Press the **DISPLAY SELECT** key next to the blank line. As a starting condition, the display will show the next line number with the same parameter/configuration menu as the previous line.
 3. Redefine the display line, as required.

➤ *To delete a display line:*

1. Press the **DISPLAY SELECT** key next to the Results Data display line to be deleted. The display will show the line number and the parameter details for the selected line.
2. Press the **DISPLAY SELECT 1** key repetitively, to move the parameter format through several format options. Note that the line number does not change. Continue pressing until the command, **Delete** shows in the display.
3. Press the **ENTER** key. Note that if the deleted line was between other display lines the other lines automatically close up around the deleted line.

➤ *To add dashes in a display line as a separator:*

1. Press the **DISPLAY SELECT** key next to the Results Data display line to have separation dashes below it. The display will show details of the presently selected parameter for the Results Data for this line.
2. Press the **DISPLAY SELECT 1** key repetitively, to move the parameter format through several format options. Note that the line number does not change. Continue pressing until the command, **Blank** shows in the display.

Entering New or Changed Information

➤ *To “enter” data and changes using the flashing cursor:*

1. Move the cursor to the display line’s data or menu item you wish to change. Press the **←** or **→** keys to move the cursor along the line to the previous or next (respectively) data or menu item to be changed.
2. Display the desired option: Press the **↑** or **↓** keys when the cursor is in a multiple-choice type of selection,
—Or—
Use **DATA ENTRY** keys to enter a numeric value.
3. Press the **ENTER** key. Note that the remaining contents of the menu may also change because of a significant change in menu selections.
4. Press the **ENTER** key a second time to view the Results Data for your change.

➤ *To “enter” data and changes—when no cursor is visible:*

- Press the **ENTER** key to “enter” the selections contained in a menu display. The instrument will replace the menu display with the selected measurement Results Data, based on the menu entered.
- Press a **DISPLAY SELECT** key and the cursor will reappear on the corresponding display line, then press the **ENTER** key twice.

Setting/Formatting Time & Date

Use the **Set Time and Date** menu to set and adjust the present time and date maintained by the instrument. Using this menu, you can select a display format for the time and date for use as a “time & date stamp” for printing with your Results Data.

Note: The selected display changes apply when printing, if the option INT is fitted.

➤ *To adjust the time display:*

1. Initiate this menu by pressing the **SETUP** key.
2. Use the **↓** key to scroll to **Set Time and Date** in the display and press the **DISPLAY SELECT** key next to this line.
3. Select the **TIME** display line by pressing the corresponding **DISPLAY SELECT** key.
4. With the cursor flashing at the displayed time, use the **DATA ENTRY** keys to enter two digits each for the hours, minutes and seconds based on 24-hour time. Note that you cannot enter **PM**, however, the instrument translates 24-hour time to 12-hour time, if the **12 Hour** time format is selected.

For example: Enter “05” for the hour of 5am and “17” for the hour of 5pm

5. Press the **ENTER** key to set the internal real time clock to your adjusted hours, minutes and seconds.
6. Press the **Clear** key to abort and start again.

➤ *To format the time display:*

1. From the **Set Time and Date** menu, press the **DISPLAY SELECT** key next to the **Time Format** line.
2. Repeated presses of the corresponding **DISPLAY SELECT** key will toggle between the two choices of: **12 Hour** and **24 Hour**.
 - 12 hour format is displayed as between:
12:00:00am and 12:59:59am—Or—01:00:00am and 11:59:59am
—Or—
12:00:00pm and 12:59:59pm—Or—01:00:00pm and 11:59:59pm.
 - 24 hour format is displayed as between: 00:00:00 and 23:59:59.
3. When the displayed menu has been altered to suit your requirements and even though no cursor character is displayed, press the **ENTER** key to action any changes made.

➤ *To set the date format:*

1. From the **Set Time and Date** menu, press the **DISPLAY SELECT** key next to the **Date Format: display** line.
2. Use the **↓** key to toggle between the three choices of: **dd/mm/yy**, **yy/mm/dd**, and **mm/dd/yy**. Note that the displayed date is based on format.
3. To select a format, press the **ENTER** key, while the format shows in the display.

➤ *To set the date display:*

1. From the **Set Time and Date** menu, press the **DISPLAY SELECT** key next to the **DATE** line.
2. Using the **DATA ENTRY** keys, enter all six digits of the present date. Follow the format as defined in the **Date Format: line**.
3. Press the **ENTER** key to set the internal real time clock to the entered day, month, and year.

Storing & Retrieving Configurations

This section describes, in detail, the Configuration menus that allow you to store and retrieve configurations of the instrument. Maintenance of these storage areas is also covered in this section. These menus are initiated using the **STORE** and **RECALL** keys found in the **CONTROL** keypad.

Store & Recall Memory Menus

The lowermost two lines of the **STORE MEMORY** menu and the **RECALL MEMORY** menu show the presently defined storage areas. The storage area number that has an * (asterisk) character adjacent to it, is the area that was last accessed. You can use **↑** or **↓** keys to scroll the storage lines up and down. (Shown with an asterisk)

Power Up Conditions—

When power is applied, the instrument automatically recalls and uses the contents of the storage area you last accessed, before removal of power.

Storage Areas—

Each “stored” configuration is internally kept in an area of memory, identified by a set of numbers and a character string, which you have defined. The numeric portion can be up to 5 digits and the alpha characters up to 12. These storage areas are non-volatile that is they are maintained even when the instrument is not powered up for 10 years.

- *To store a configuration in an already defined storage area:*
 1. Press the **STORE** key.
 2. Use the **↑** or **↓** keys to scroll through the numerically ordered list of defined storage areas,
—Or—
Use the numeric keys to type the number of the desired storage area and press the **ENTER** key.
 3. When the desired storage area number displays, press the corresponding **DISPLAY SELECT** key. You will get the message: **Settings Recalled from Memory** and the instrument will go to the Results Data display reflecting the recalled settings.

- *To store a new configuration (presently displaying):*
 1. Press the **STORE** key.
 2. Press the **↑** or **↓** keys to scroll the cursor to the lower most lines.
 3. Choose a number to represent the new storage area, use up to 5 digits,
—And—
Review the already defined storage areas, to ensure your new storage area number does not already exist. Use the **↑** or **↓** keys to scroll.
 4. Use the numeric **DATA ENTRY** keys, to type the number of the new storage area.
 5. Press the **ENTER** key.

- *To recall a configuration:*
 1. Press the **RECALL** key.
 2. Use the **↑** or **↓** keys to scroll through the numerically ordered list of defined storage areas.
 3. When the desired storage area number displays, press the corresponding **DISPLAY SELECT** key.
—Or—
Use the numeric keys to type the number of the desired storage area, then press the **ENTER** key to bring up the stored configuration on your instrument.

Storage Area Maintenance

Maintenance includes renaming and deleting previously created storage areas for organizational purposes. An existing storage area may be renamed or deleted. Note that a presently active storage area (that last accessed) cannot be modified. If you wish to rename or delete an area, then first store the present configuration, or recall another storage area.

- *To rename an existing storage area:*
 1. Press either the **STORE** or **RECALL** key.
 2. Press the **DISPLAY SELECT** key next to the Edit Directory menu line.
 3. Scroll using the **↑** or **↓** keys to display the Storage number you wish to rename.
 4. Press the **DISPLAY SELECT 2** key, which corresponds to the Name: menu line.
 5. Enter the new name using the numeric keys in the **DATA ENTRY**. Use the **CLEAR** key to correct a mistake.
 6. When the required numeric characters have been entered, press the **ENTER** key. Your previous storage area number and your new one will show in the display.
 7. Press **ENTER** a second time to display your Results Data.

- *To delete a storage area:*
 1. Press either the **STORE** or **RECALL** key.
 2. Press the **DISPLAY SELECT** key next to the Edit Directory menu line. Review the contents of these display lines to find the correct storage area you will delete.
 3. Use the **↑** or **↓** keys to show the storage area number, then press the corresponding **DISPLAY SELECT** key.
 4. Press the **DISPLAY SELECT 3** key, which corresponds to the Delete menu line. A message saying Deleted Memory will show and your display return to Results Data. Note that if you have chosen a storage number that reflects your active settings, the number will not delete.

Repacking of the Storage Areas

The media used for these storage areas is known as “Flash Memory”. This non-volatile memory is both readable and writable, but only previously erased areas of memory may be written to. The internal system of the instrument ensures that this memory is correctly written to, while maintaining its efficient usage.

This storing process will slowly fill the memory with each written storage area until the memory becomes full. When full, the system automatically retrieves all storage areas into internal volatile memory, erases the entire non-volatile memory, and then rewrites all the storage areas back into non-volatile memory. You would need to manually prompt the execution of this procedure, only when you perform a software upgrade, or if a storage area has become corrupted.

- *To manually prompt the repacking of storage areas:*

Caution: Power must not be removed while this procedure is being performed, complete data loss (including calibration data) may result if this occurs.

1. Press the **SETUP** key.
2. Scroll to NV Data Control menu line.
3. Press the corresponding **DISPLAY SELECT** key to edit.
4. Press the **DISPLAY SELECT** key corresponding to Pack Data in Memory menu line. You will get a message saying Erasing Flash Memory.

Rear Panel

Connectors & Controls

The rear panel contains the power cord connection; Configuration Control switch and four connectors: Analog output, Digital I/O, Parallel printer, IEEE-488, and two RS232. Refer to Figure 9.

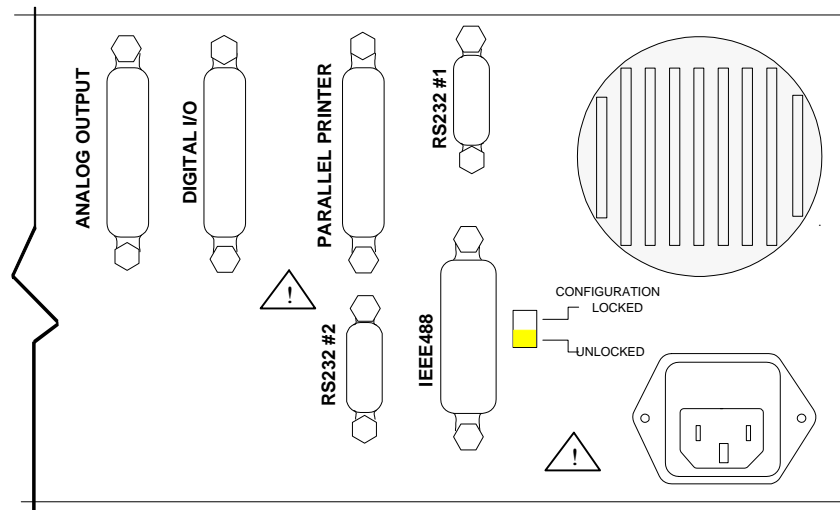

Figure 9. Rear Panel Partial View

Power Connection

The 6250 instrument is designed to operate with a three-conductor power cord. The third conductor is securely connected to ground to ensure the external chassis of the instrument remains at ground potential.

Warning: Operation with a two-conductor power cord, or without a secure ground connection may render the Phase Angle Voltmeter instrument unsafe for use.

Configuration Control Switch

The Configuration Control switch allows you to disable reconfiguration of the instrument by unauthorized users. This switch is located in the upper right-hand corner of the rear panel. When in the **LOCKED** (upper) position the instrument's configuration is locked against changes, other than any caused by recalling predefined memory locations.

The following changes are made to the menus when in the Configuration Control switch is in the **LOCKED** position:

- Display lines cannot be altered.
- The **SETUP** and **STORE** keys are disabled.
- The Nullmeter's **SELECT** and **SCALE** keys are disabled.
- The CALIBRATION menu is reduced to **System Status** and **Internal Calibration** selections.
- The phase **A**, **Band** **GUARD** input keys are disabled.

Parallel Printer Interface

Use standard Centronics parallel cable compatible with IBM-PCs. This interface option supports serial stand-alone types or PCL and compatible printers only.

RS232 Connectors

Use this connection for control or for printer output. Baud rates can be set from 1,200 to 38,400 baud. Flow control via RTS/CTS handshake. See *Interface Operation* on page 67, for information on using this feature.

IEEE488 Connector

This connection enables full talk/listen capabilities. See *Interface Operation* on page 67, for information on using this feature.

Configuration Setup

The various menu selections available allow you to define the data configuration appropriate for testing your products. The menus that facilitate setup include: Setup Measurements, Input Configure, the Parameter displays and if you wish to use the Nullmeter, the Nullmeter displays. For basic use of the keys and the display interface, refer to *Using the Operational Keys* on page 25.

Important Note: Before using your instrument, be aware of the rear panel mounted “Configuration Disable” switch. This slide switch must be in the **UNLOCKED**, specifically in the down position, to enable any reconfiguration activities.

Setup Guidelines

As a standard setup, configure each input independently for input mode, fundamental frequency, ranging, and scale factor. Setup the input pair’s **GUARD** terminal for internal or external connection. Refer to the following “setting” instructions as guidelines for standard setups. Initial steps to configuring inputs include:

- Removal of all connections to the BNC and **GUARD** terminals; and
- Resetting the configuration using the **Set Defaults** menu, unless the present configuration has been set for your needs. Please refer to *Setting Defaults* on page 27.

➤ *Setting fundamental frequency mode & range for input connectors:*

1. Press the **SETUP** key while viewing Results Data to bring up the **SETUP CONFIGURATION** menu. See Figure 10.
2. Press the **DISPLAY SELECT** key corresponding to Setup Measurements.

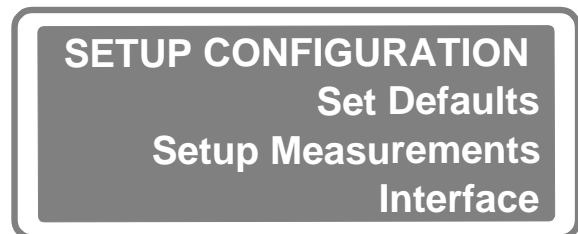

Figure 10. Initial Setup Display

3. The first four display lines of the SETUP MEASUREMENTS menu show the fundamental frequency measurement type, range, and input source menu. See Figure 11.
4. On the second line, select the type of Fundamental Frequency. See *Fundamental Frequency* on page 46.
5. When fundamental frequency is not Fixed, you have the option of setting its range.

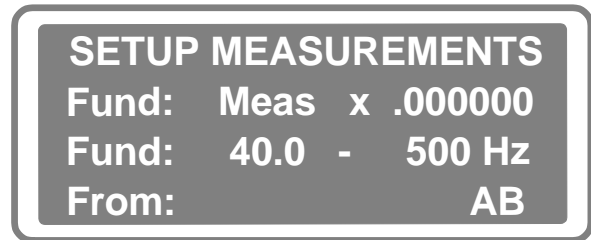

Figure 11. Setup Measurements Display

The default range and menu line reads: Fund: 40.0 – 500 Hz. For details, see *Fundamental Frequency Range* on page 47.

6. The fourth line reads From: and shows the input connector signal source, or to which inputs your fundamental frequency applies. You can change this selection by pressing one or more of the **INPUTS** keys: **A**, **B**, or **AB**. Those located above the BNC connectors. Note that if the display reads an input, such as A, and you press A, the display will read none.

You may get two different message displays here:

Action at Input Source menu line	Message Display
If you attempt to use the DISPLAY SELECT keys to change inputs:	Use INPUT Keys To Select/Deselect Use Fundamental
If you press ENTER when none shows in the display:	Sorry Must Select An input To Use Fundamental

7. When complete with the Setup Measurement display, press **ENTER** twice to action the changes.

Note: To access all the display lines of the SETUP MEASUREMENTS menu, scroll down using the **↑** and **↓** keys when no cursor is flashing. To remove the cursor, press **ENTER** once. This menu’s additional display lines include: minimum period, filter, maximum harmonics, fundamental bandwidth, FFT type, and synchronize averaging and period. Refer to *Measurement Configuration Menu* on page 46, for details.

➤ *Setting the input mode for each input connector:*

These settings select which signal, voltage or current, is going to be measured on which input. Additional settings in the display affect the range for voltage and current, **Scaling** and the **Guard** connection being internal or external. Note that when making these input settings you must call up the INPUT CONFIGURE display uniquely for each input connector used. See Figure 12.

1. Press the **A**, **B**, **AB**, or **S** (-3 only) key located at the **INPUT** connectors while viewing the Results Data. The display now shows the INPUT A CONFIGURE menu corresponding to the **A** input key, or the one you pressed.

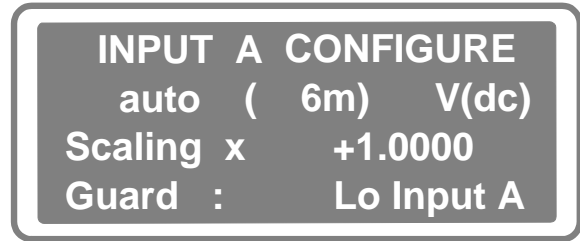

Figure 12. Input Configure Display

2. Correlate the display's input mode (power measurement) with the actual input. Note that the display shows the input configured for voltage measurements, using DC coupling. Update the display by pressing the **DISPLAY SELECT 2** key twice and using the **↑** or **↓** keys to alter the option. The input mode choices are: V (dc); V (ac); V (50) and A (dc).

Note: Use the respective **VOLTS** BNC connector for all voltage input **V**. Use **AMPS** input connector for the current input **A**.

Important Note: Take care, when measuring low frequency signals, particularly phase measurements. After applying a signal containing a significant DC level, the input may take an extended period (time) to settle as the input time constant is $300\text{mS} \pm 2\%$.

3. The default for voltage/current input range is **auto**. To set a fixed range value, scroll through the given selections. Choose a range of $6V_{\text{rms}}$, or higher, which effectively creates an input impedance of $600\text{k}\Omega$. The selectable options are: 2.5; 6; 20; 65; 200; 700; 6m; 20m; 70m; 200m; and 750m. Note that the range currently being used shows in brackets to the right when the selected input mode and the in-use input mode are the same.
4. Press **ENTER** once to move onto the next display line, press **ENTER** twice to action changes for the separate input connections.

➤ *To change the (input) scale factor:*

1. While viewing the INPUT CONFIGURE display for the respective input you are configuring, press the **DISPLAY SELECT 3** key.
2. Enter the desired scale factor using the **DATA ENTRY** keypad. For details, see *Input Scaling* on page 45.
3. Press **ENTER** once to move onto the next display line, press **ENTER** twice to action changes for the separate input connections.

➤ *Setting the Guard connection for each input connector:*

1. While viewing the INPUT CONFIGURE display for the respective input you are configuring, press the **DISPLAY SELECT 4** key.
2. Repetitively press the **DISPLAY SELECT 4** key to toggle the options for external and internal connections. Choose External, or one of the internal connections: Lo Input A or Lo Input B.
3. When complete with your input connector selections, press **ENTER** to action the changes.

➤ *To configure the Nullmeter parameter display:*

The Nullmeter does not light until valid measurements for Results Data are configured. For details on the options, refer to *Nullmeter Display Menu* on page 51.

1. Press the **NULLMETER SELECT** key. One of five Nullmeter parameter displays will come up. See Figure 13.
2. Continue pressing the **DISPLAY SELECT 1** key to view the four possible parameter displays for the Nullmeter. Refer to *Nullmeter Parameter Types* on page 52.

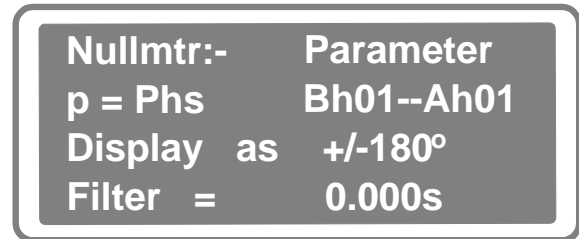

Figure 13. Nullmeter Sample Display

3. Press the **NULLMETER SCALE** key. Refer back to *The Nullmeter* on page 22.

If you do not choose to use the Nullmeter, then configure a Parameter (p) display to match your measurement requirements.

➤ *To complete a configuration setup:*

1. Connect the signal(s) to the respective BNC and **GUARD** terminals.
2. Apply signals.
3. Make any adjustments required to **SETUP MEASUREMENT** configuration.
4. Make adjustments, as needed to the parameter displays or the Nullmeter parameter displays.
5. When complete with this setup store the configuration using the Control keypad's **STORE** key. See *Storing & Retrieving Configurations* on page 34.

Input Configuration Menu

Each selectable option of the Input Configuration menu is described in the following subsections. When the displayed menu has been altered to suit your requirements, press the **ENTER** key twice to action any changes made.

Input Scaling

This indicates the present amplitude scale factor (if any) applied to measurements of this input. If the default scale factor of +1.0 shows in the display, then no input scaling is performed. You may enter any desired scale factor (including negative factors) for application to each input. Negative scale factors are correctly applied, such as, the corresponding positive scale factor is applied, in concert with a 180° phase shift.

Guard

This indicates the presently selected **GUARD** terminal connection.

- **External**—Indicates that the **GUARD** terminal is to be externally driven.
- **Lo Input A, B or S (-3)**—Indicates that the **GUARD** terminal is internally connected to the respective input's BNC outer shell.

Caution: If you are measuring current, or if the voltage range is less than 6vrms, ensure that less than 10Vpk exists between each BNC outer shell of the pair of inputs and outer shell and the guard terminal.

Notes:

- 1) When making external connections only connect to the **GUARD** terminals.
- 2) When using the current input, current low **MUST** be externally connected to the **GUARD** terminal and the input pair configured to use external guard.

Measurement Configuration Menu

The Setup Measurements line of the **SETUP** key menu allows you to fully configure your instrument's measuring characteristics according to each particular situation.

The discussions below deal with each menu line in the same order as shown in the display menu. For this display, scroll using the **↓** key, to access the lower lines. When the displayed menu matches your requirements, press the **ENTER** key once or twice, as required, to action any changes made.

Fundamental Frequency

The Fund: menu line allows you to select from three types of fundamental frequency measurements, which you can use to synchronize your instrument's amplitude measurements.

The fundamental frequency types are:

Measured—

The default is MEASURED. A selected input measured frequency is indicated for the instrument's fundamental frequency.

Measured (multiplied by a factor)—

The option Meas x .000000 allows you to select an input measured frequency multiplied by a defined factor, as its fundamental frequency. Enter a value with this selection. You can also use this menu item to measure sub-harmonic content of a signal, for example, at 1/2 the fundamental frequency.

Fixed—

The FIXED type directly sets the fundamental frequency to be any frequency you have entered within the range of 0.0005HZ to 100kHz:

Select the FIXED type when:

- There is no signal present, which has sufficient amplitude at the fundamental frequency.
- The fundamental frequency is not stable.
- The input signal is first applied and the input fundamental frequency is well known (within a few percent), rather than allowing the instrument time to establish the fundamental frequency.
- The fundamental frequency is very low (e.g., 0.0005Hz), forcing the instrument to wait at least 4 cycles of the input waveform before starting harmonic analysis.

- You want to perform a spectral analysis of the input signal(s), rather than harmonic analysis.

Note: When performing a spectral analysis, set the fundamental frequency to the desired frequency step between available spectral points, set the RBW ratio to 1, and set the maximum harmonic to the number of spectral points, desired.

Fundamental Frequency Range

When the fundamental is not fixed, the Fundamental Frequency Range menu is active. The menu line Fund: 40.0 – 500 Hz allows you to set a frequency range for a measured fundamental frequency.

- The default frequency range shows on the display as 40Hz to 500Hz. You may set any range of frequencies within the 0.0005Hz to 100kHz range, with a limit of a 128:1 range.
- When in-phase precision is required, or where harmonic distortion is present, it is beneficial to reduce this to a 2:1 range around the nominal fundamental frequency. An example of this is 40 to 80Hz.
- When specifying a fundamental frequency range, consider that the instrument will take the lowest frequency component having a signal of greater than 5% of range, as its fundamental. If there is signal having a sub-fundamental frequency component of any significance, then the exclusion of that frequency from the selected range will substantially eliminate its effect on the measurement.
- If your instrument requires signal measurements having fundamental frequencies beyond the 40Hz to 500Hz range, or other requirements to accommodate abnormal measurement situations;
—Then—
Use the **SETUP** key to enter a configuration reflecting your instrument's needs. Note that previous configurations may be stored and recalled using the **STORE** and **RECALL** keys.

Fundamental Source

When the fundamental frequency is not fixed, the **From:** menu line becomes active. The Fundamental Source menu sets an input, or a set of inputs. The fundamental is based on the measured frequency of the input(s) set by this menu line.

The source applies when:

- An input is added to or removed from the list by pressing the respective **INPUT** key.
- The default is set to AUTO-SELECT between all inputs.

- When selecting this input, or set of inputs, consider which input has the least noise content, the least amplitude variability, and the least cycle-to-cycle phase noise.
An example of a signal that should NOT be allowed to act as the fundamental frequency source is a RVD or LVD transformer's output, which has its frequency shifted during the time it is moved.
- If more than one input is selected, the instrument will continuously monitor all selected inputs, selecting the one having the most stable frequency measurement. The front panel **SYNC** lights indicate, which input is actually being used at any given moment.

Nominal Amplitude Measurement Period

The Nominal Amplitude Measurement Period menu, shows on the display as Min Period: It is always active and allows you to define the period of time amplitude measurements are made. For all, but the shortest of periods, this effectively sets the results update rate of the instrument. Note that the default measurement period is 250S.

The update rate of the display is limited to 250mS and the Nullmeter is limited to 100ms. Selecting a measurement period, less than these figures is ineffective when using front panel operation.

The length of time that is required to measure a harmonic characteristic takes precedence over the selected amplitude measurement period. This means that if you enable a 50HZ harmonic measurement signal expect at least a 1mS measurement period. The minimum required for analysis is 20mS, 1 cycle.

Limitations on the actual measurement period are:

- The minimum measurement period attainable under all circumstances is 0.01S.
- The minimum period is further set by $\text{RBW Ratio} \times \text{Fundamental Period}$, unless the **Maximum Harmonics** line is set to zero (thus turning off harmonic analysis).
- The maximum period is 100000S.
- The maximum period is further set by $(\text{Fundamental Period} \times 8192) / (\text{RBW Ratio} \times \text{Maximum Harmonics})$ if harmonic analysis is enabled.

Filter Frequency

The Filter Frequency menu line is always active. This menu line reads as **Filter:** with a default frequency of 50kHz. It allows you to select a low-pass filter, used to limit the input signal to the entered value before amplitude measurements. Note that

this filter has no direct affect on frequency measurement. You may select from 0.0005Hz through 2mHz for this filter's 3dB frequency.

The limitations on the actual corner frequency are regarding the following:

- There is no actual filter for entered frequencies above 250kHz. In this case the actual bandwidth is in excess of 2mHz.
- The actual minimum filter frequency is 4.88Hz.
- The physically available filter frequencies are in the ratio of 1.2:1 steps within the 4.88Hz to 200kHz range.
- Be aware that if the ratio of the filter frequency is less than 50 times the fundamental frequency,
—Then—
The instrument's amplitude accuracy is affected and the number of available harmonics is reduced in accordance with the ratio.

Maximum Harmonics

This sets the Maximum Harmonic number that will be available for Results Data. The display reads: Max Harmonics: The default is 200. Setting a higher number in a parameter selection than the set harmonic number will yield zero results. For optimum harmonic results, note that:

- The frequency of the maximum available harmonic is nominally 200kHz.
- Set the MAXIMUM HARMONIC fairly high for low-frequency fundamental frequencies, such as, 200 at 50Hz, to reduce higher fundamental frequencies, such as, 10 at 20kHz.
- Setting an abnormally low maximum harmonic at low fundamental frequencies may affect the stability of the phase measurement, as may setting an unusually high harmonic at high fundamental frequencies.
- The maximum available number of harmonics is the lower of 4096 / RBW Ratio, or 2047.
- Setting a maximum harmonic of zero, inhibits all harmonic analysis. In this case only AC+DC, AC only, and DC only, parameters will yield measured results, all harmonic related results will be zero. If these are the only required parameters, then some increase in performance may be found by disabling harmonic analysis in this manner.

Fundamental Bandwidth

The Fundamental÷BW is also known as RBW ratio. The RBW ratio default is 2:1. This menu line sets the minimum number of fundamental frequency cycles the analysis is performed. In cases where a signal is known to have excellent frequency stability, and you desire superior inter-harmonic noise rejection, setting this ratio to a high value, such as, 20:1 is of benefit. Conversely, for signals having poor frequency stability this figure can be reduced to as low as 1. We recommend a ratio between 2:1 and 10:1. Note that the lower frequency limit for the second harmonic is the same as the upper frequency limit on the fundamental amplitude measurement.

Fundamental÷Bandwidth characteristics are:

- The bandwidth for any harmonic is given by Fundamental Frequency / RBW ratio.
- The maximum RBW available is 4096 / Maximum Harmonic.
- Setting the RBW ratio to a high value may result in instability of measurement results, particularly at higher harmonics.

Note: If a value of 100 is set for RBW, then the frequency stability of the fundamental must be <0.1% for a stable measurement of the 10th harmonic.

Analysis

The Discrete Fourier Transform analysis type menu line reads as FFT Type: This option can be set as **Normal** or **Windowed**. The analysis can be performed with either function selected. This analysis option reduces both the effect of being nonsynchronous with the incoming frequency and the effects of non-harmonic signal content. The benefit of the **Windowed** function is offset by the fact that phase accuracy is adversely affected and that 4:1 more cycles are required for the measurement to achieve the same bandwidth. **Normal** is the default and is recommended, however, superior amplitude performance can be achieved using the **Windowed** selection. The actual window function used in the 6250 products is a modified Blackman-Harris function.

Fundamental Frequency Averaging

An accurate, noise free, measurement of the fundamental frequency is the basis for any high-resolution phase measurement. Thus some averaging, or filtering of the fundamental frequency measurement results, is desirable. However, averaging and filtering slows the instrument's response to changes in frequency.

- The default is **med**.
- For operation at frequencies above 10Hz, the use of the **fast** or **med** selections are recommended.
- If the fundamental frequency is exceptionally noisy, or the ultimate in phase accuracy is required, then use the **slow** selection.
- For operation at low frequencies, such as 0.0005Hz, the **none** selection is desirable. Otherwise the instrument may take more than one day to adequately acquire the fundamental frequency.

Fundamental Frequency Measurement Period

The FUNDAMENTAL FREQUENCY MEASUREMENT PERIOD menu line sets the base measurement period for the fundamental frequency measurement. Setting this measurement to a longer period than the default of 250mS, reduces frequency measurement noise at the expense of a longer settling time.

- A better reduction in frequency measurement noise can be achieved by using longer fundamental frequency averaging.
- Settings in the range of 0.25 to 1 are recommended for normal frequencies, with longer periods being desirable for low frequency operation.
- The actual minimum measurement period is 4 cycles of the lowest fundamental frequency.
- The maximum measurement period is 512 cycles of the highest fundamental frequency.

Nullmeter Display Menu

Bring the Nullmeter menu up by pressing the **NULLMETER SELECT** key. To view the four different Nullmeter parameter displays, press the **DISPLAY SELECT 1** key.

Nullmeter Parameter Types

The first line of the menu display shows the Nullmeter types. You can change the types by repeated presses of the **DISPLAY SELECT 1** key. The Nullmeter's results show in the display.

Parameter—

This indicates that the result will be directly obtained from the measurement parameter defined in the second (p) line of the menu.

Param-Ref—

This indicates that the result will be the difference between the parameter defined in the second (p) line of the menu, minus the result of the third (r) line of the menu. The reference (r) parameter may be continuously updated, or a previously measured value of this parameter (as defined by the fourth line of the menu).

Param/Ref—

This indicates that the result will be the difference between the parameter defined in the second (p) line of the menu, divided by the result of the third (r) line of the menu. The reference (r) parameter may be continuously updated, or a previously measured value of this parameter (as defined by the fourth line of the menu).

Param/Ref-1—

This indicates that the result will be the parameter defined in the second (p) line of the menu, divided by the result of the third (r) line of the menu, minus 1 (i.e., $[p/r]-1$). The reference (r) parameter may be continuously updated, or a previously measured value of this parameter (as defined by the fourth line of the menu).

Parameter Display Menus

Bring the parameter displays up by pressing any **DISPLAY SELECT** key. Press **DISPLAY SELECT 1** key repetitively to view the various parameter displays. Refer to the following paragraphs for descriptions/definitions.

Parameter (p)

Edit the line that contains Parameter (p) by first pressing the corresponding **DISPLAY SELECT** key. The format of this line is dependent on its contents. Each portion of the line may be edited by using the **↑** and **↓** keys, the **INPUT** keys, or the **DATA ENTRY** keys (as applicable). The **ENTER** key should be pressed when all the sections of this line are to your requirements.

The leftmost selection on this line is the parameter type. The available selections are (in the order selected by the **↑** key) as follows:

True RMS—

Represents the TRUE RMS amplitude of the selected input. The “bandwidth” of the result may be set as DC only, AC only, AC+DC, or a range of harmonics. Note that setting the same start and end harmonic yields the amplitude of the given harmonic.

Rectify—

Rectify in the menu means the average rectified amplitude (or mean modulus) of the selected input.

Form Factor—

FF in the menu means form factor of the selected input, such as, the ratio of the average rectified and true RMS amplitudes.

Crest Factor—

CF in the menu means the crest factor of the selected input, such as, the ratio of the peak and true RMS amplitudes.

Highest Peak—

High Pk In the menu means the highest detected peak amplitude of the selected input, such as the most positive.

Lowest Peak—

Low Pk in the menu means the lowest detected peak amplitude of the selected input, such as the most negative.

Peak—

Peak represents the highest detected peak amplitude of the selected input, such as either the most positive or the most negative.

Pk-Pk—

This is the difference between the highest and lowest detected peak amplitudes of the selected input.

THD-Fund—

This is the total harmonic distortion of the selected input, relative to the fundamental component—You may select the maximum harmonic to be included.

THD-Harm—

This is the total harmonic distortion of the selected input, relative to the total harmonic content—You may select the maximum harmonic to be included.

THD-Sig—

This is the total harmonic distortion of the selected input, relative to the total RMS signal content—You may select the maximum harmonic to be included.

Frequency—

This is the fundamental frequency of the selected input, or the fundamental frequency selected as sync. for amplitude measurements.

Watts—

This is the real power measured by the pair of inputs—Assuming one input is measuring voltage and other is measuring current—The “bandwidth” of the result may be set as **DC** only, **AC** only, **AC+DC**, or a range of harmonics (setting the same start and end harmonic yields the power at the given harmonic).

VAR—

This is the imaginary power measured by the pair of inputs. Assuming one input is measuring voltage and other is measuring current—The “bandwidth” of the result may be set as **AC** only, **AC+DC**, or a range of harmonics (setting the same start and end harmonic yields the VARs at the given harmonic).

VA—

This is the “apparent” power measured by the pair of inputs. Assuming one input is measuring voltage and other is measuring current. The “bandwidth” of the result may be set as **DC** only, **AC** only, **AC+DC**, or a range of harmonics (setting the same start and end harmonic yields the VA at the given harmonic).

PF—

This is the power factor (i.e., Watts/VA) measured by the pair of inputs. Assuming one input is measuring voltage and other is measuring current. The “bandwidth” of the result may be set as **AC** only, **AC+DC**, or a range of harmonics (setting the same start and end harmonic yields the power factor at the given harmonic)—Note that this is the correlation coefficient of the two signals over the bandwidth defined.

DPF—

This is the displacement power factor (i.e., Watts/VA of the fundamental) measured by the pair of inputs. Assuming one input is measuring voltage and other is measuring current. Note that this is the Power Factor or Correlation of the fundamental components only.

Eff.Ph_s—

This is the “Effective Phase” [i.e., $\cos^{-1}(\text{Watts/VA})$] measured by the pair of inputs. Assuming one input is measuring voltage and other is measuring current. The “bandwidth” of the result may be set as **AC** only, **AC+DC**, or a range of harmonics (setting the same start and end harmonic yields the Effective Phase at the given harmonic).

Pk VA—

This is the highest detected real-time cross product of the waveforms of the selected pair of inputs. Assuming one input is measuring voltage and other is measuring current.

Load Z—

This is the computed load impedance as measured by the pair of inputs. Assuming one input is measuring voltage and other is measuring current. The “bandwidth” of the result may be set as **DC** only, **AC** only, **AC+DC**, or a range of harmonics (setting the same start and end harmonic yields the Load Impedance at the given harmonic).

Load R—

This is the computed load resistance (i.e., in phase component of impedance) as measured by the pair of inputs. Assuming one input is measuring voltage and other is measuring current. The “bandwidth” of the result may be set as **DC** only, **AC** only, **AC+DC**, or a range of harmonics (setting the same start and end harmonic yields the Load Resistance at the given harmonic).

Load X—

This is the computed load reactance (i.e., quadrature component of impedance) as measured by the pair of inputs. Assuming one input is measuring voltage and other is measuring current. The “bandwidth” of the result may be set as **DC** only, **AC** only, **AC+DC**, or a range of harmonics (setting the same start and end harmonic yields the Load Reactance at the given harmonic).

Spectrum—

This is the RMS amplitude of the selected input at the selected spectrum point of the spectrum analysis—Use **Spect Hz** to determine the frequency of the selected spectrum point.

Spect Hz—

This is the frequency of the selected spectrum point of the spectrum analysis.

Gain—

This is the ratio between the total amplitudes of the selected input/harmonic pair.

Gre—

This is the ratio between the amplitudes of the in phase component of the selected input/harmonic pair.

Gim—

This is the ratio between the amplitudes of the quadrature component of the selected input/harmonic pair.

Real—

This is the in phase component of the selected input/harmonic pair.

Imag—

This is the quadrature component of the selected input/harmonic pair.

Phs—

This is the phase between the selected input/harmonic pair.

Constant—

This sets the value to what you have entered.

Reference Parameter (r)

Edit this line by pressing the corresponding **DISPLAY SELECT** key. The method of selecting the parameter etc., is the same as for the parameter (p) line described above.

Reference Parameter Type

This line is changed by pressing the corresponding **DISPLAY SELECT** key, using the **↑** key to change the selection, then pressing the **ENTER** key. The line is only present when the reference parameter line is present and is not set to a constant. The available selections are:

Updated Ref. Param.—

This selects continuous update for the reference parameter.

Fixed Ref. Param.—

This selects no continuous updating for the reference parameter, but that a previously set value of this parameter will be used.

Fix Ref. Param. Now—

This selects that the reference parameter will be fixed at the currently measured value. The selection changes to Fixed Ref. Param. after pressing the **ENTER** key.

Data Result Units

This line allows you to set the units for the result of the parameter measurement or deviation. You may select any unit, which is compatible with the parameter or deviation. The unit chosen is automatically set to the default when the primary parameter is being edited. The instrument automatically provides any conversion required.

Note that the unit is NOT automatically updated when the selected input(s) has its mode changed between voltage and current (or *vice versa*), if this is performed, select the display line (or nullmeter select) and manually change the unit. The selection may be changed by pressing the corresponding **DISPLAY SELECT** key, then using the **↑** and **↓** keys to change the selection, pressing the **ENTER** key when the desired unit is displayed.

The available units are:

Application	Units of Measure / Notes
Amps	“A” with optional ac, avg, dc, rms, pk, pkpk, imag or real
Volts	“V” with optional ac, avg, dc, rms, pk, pkpk, imag or real
dBV or dB μ V	decibel ratio to 1V or 1 μ V respectively.
Watts	“W” with optional ac or dc
dBW or dBm	decibel ratio to 1W or 1mW respectively
VA	with optional dc, ac or pk
VAR	with optional ac
Horse power	“HP”
%	percentage
dB	decibel
$\pm 180^\circ$ or 0-360 $^\circ$	Half or full circle
Grad	± 200 or 0-400
Radians	$\pm \pi$ or 0-2 π
π radians	± 1 or 0-2
Hertz	“Hz”
Cycles per second	“cps”
Revolutions per min.	“rpm”
Seconds	“sec”, inverse Hz
Hours	“Hr”
Resistance	“ Ω ”, with optional dc, ac, imag or real
Conductance	“S”, with optional dc, ac, imag or real

Comparison Limit

If you have selected a limit comparison to be performed, then this line becomes visible. The constant value set in this line sets the amount by which the primary parameter may deviate from the reference parameter before the displayed status changes from **PASS** to either **HIGH** ($p > r + \text{limit}$) or **LOW** ($p < r - \text{limit}$). The limit may be changed by pressing the corresponding **DISPLAY SELECT** key, using the numeric keys to enter the desired limit, pressing the **ENTER** key when the desired limit has been entered.

Filter Time Constant

The parameter or deviation result may be filtered (averaged) with a single order filter have any user specified time constant in the range 0.01S to 10000S. Setting this value to zero, disables the filter. Change the filter time constant by pressing the corresponding **DISPLAY SELECT** key; using the numeric keys to enter the desired filter time constant; and then pressing the **ENTER** key when the desired filter time constant has been entered.

The following notes apply:

- The filter only affects the selected display line, or the nullmeter (as applicable).
- The filter is automatically “bypassed” and reset when the result changes by more than approximately 1000 least significant displayed digits. This gives fast settling with the maximum amount of filtering.
- The filter is automatically reset when the display line (or nullmeter) is selected.
- The filter is applied after computing any deviation, thus it is the deviation which is filtered, NOT the parameter and the reference individually.
- The filter is applied prior to units conversion, thus operates correctly on “non-linear” units (e.g., dB).

Some Useful Hints

Showing Percentages & dB Changes

1. Set a display line to the PARAM/REF-1 type [the (X/REF)-1 key is useful for this].
2. Set both P and R to the same parameter.
3. Apply the input(s), in the reference (0% or 0dB) conditions.
4. Select to FIX REF. PARAM. NOW.
5. Select the desired display units (usually either PERCENT or DB RATIO).

6. Enter the display line. The display will now continuously display the percentage or dB change of the selected measurement result from that at the reference conditions.

If you wish to reset the reference level, simply reselect the display line, and reselect to FIX REF. PARAM. NOW.

Unstable Displayed Results

Select for the result to be filtered by selecting the display line and setting the **Filter:** menu selection to a non-zero time constant. A value of 1 or 2 seconds is usually suitable for frequencies above 10Hz. Set a value proportionately longer for lower frequencies.

Display Line Format

All displayed parameter or deviation data follow the same general format. Each display line is sectioned into four portions, from left to right:

Measurement Type—

This is indicated in the first five characters of the display line, and indicates either the method used to measure the parameter displayed (e.g., Harmonic), or the type of deviation used.

Numeric Result—

This is indicated in the following 8 characters of the display line, and indicates the numeric value of the parameter, or the result of the deviation. Where applicable, this also indicates the polarity. The value of the least significant digit used by the display is automatically maintained by the instrument such that immeasurable resolution will not be shown, even after units conversions or passing through user defined equations.

Result Unit—

This is indicated in the following 5 characters of the display line, and not only indicates the unit you have chosen, but may also indicate further details regarding the method used for measurement (e.g., Vrms). Power Factor Lead or Lag information is also shown in this section of the display line when applicable.

Input Measured—

This is indicated in the rightmost character of the display, and indicates the input used for the displayed result. When the displayed result is from a primary and a reference input (e.g., phase B:A), then the primary input's letter is displayed. When the displayed result is a deviation, then the primary input of the primary parameter is displayed.

Under certain conditions, no numerical result can be presented for the selected parameter or deviation, in these conditions the central portions of the display are replaced by an informational message.

The following terms may display in a message:

Invalid—

This is displayed if the parameter or deviation defined for the display line had invalid syntax. This generally can only be displayed when the display line's contents was defined via an interface, the display line definition menu maintains correct format for this definition.

Invalid chnl—

This is displayed if the parameter of deviation contains a reference to an input, which is not fitted in this instrument. This generally can only be displayed when the display line's contents was defined via an interface, the display line definition menu maintains correct format for this definition.

Low input—

This is displayed when a requested parameter cannot presently be correctly measured. The usual reason is when the input level is too low (below approximately 0.5% of range if filtered, 5% if unfiltered). Other reasons are: when you have the parameter-required harmonic analysis disabled and either harmonic analysis disabled; and when the requested harmonic was higher than what is available; and when no fundamental component was found in the frequency range defined.

Overflow—

This is displayed when a deviation or equation computation resulted in a numerical overflow (e.g., divide by zero).

Nullmeter Scale Menu

Independently of the parameter selected, the Nullmeter may be scaled in various ways. The selection of Nullmeter Scaling is initiated by pressing the Nullmeter's **SCALE** key.

Scale Factor

The **Scale Factor** menu line allows you to set the value for the Nullmeter's parameter, which you can select using the Nullmeter's **SELECT** key, and corresponds to the distance between the 0 and 1 values of the Nullmeter. This displayed value may be altered by the following procedure:

1. Press the **DISPLAY SELECT 2** key.
2. Using the **DATA ENTRY** keys, enter the desired scale factor. Note that negative numbers may be used, as required.
3. Press the **ENTER** key.

Type

The **TYPE** menu line allows you to select the type of nullmeter that will be used. The type is selected by a combination of three settings, which are displayed in this menu line. From left to right, these are:

Dot or Bar type:

- **SmlDot**
This selection indicates that a single dot is used as the marker.
- **MedDot**
This selection indicates that three dots is used as the marker. The inner dot is fully illuminated; the outer dots are dim.
- **LrgDot**
This selection indicates that five dots is used as the marker. The inner dot is fully illuminated; the outer dots are successively dimmer.
- **Bar**
This selection indicates that the **Nullmeter** will be a bargraph, with all positions illuminated from 0 to the marker position.

Linearity:

- **Lin**
This selection indicates that the **Nullmeter** will use linear scaling. Note that this gives the **Nullmeter** a 0 to 1 dynamic range, i.e. the range set by the **Scale** selection.
- **Log**
This selection indicates that the **Nullmeter** will use logarithmic scaling. Note that this gives the **Nullmeter** a 0 to 1000 dynamic range, i.e. 0 to 1000 times the **Scale** selection, with results less than 0.1 being shown as 0.

Note: Setting the **Scale** selection to your specified adjustment limit enables the adjustment of your input(s) with fine resolution at null, but without losing visibility of adjustment when far away from null.

Zero Position and Polarity Sensitivity:

- **Left**
This selection indicates that only positive results are displayed, and that the 0 position is at the extreme left end.
- **Centered**
This selection indicates that either polarity results are displayed, with the 0 position in the center. Positive results are displayed to the right, negative results are displayed to the left.
- **Mirrored**
This selection is similar to **Centered**, but is mirrored around the central 0 position. Note that this yields increased visibility for null detection, at the cost of not knowing polarity.

These settings may be altered by:

1. Pressing the **DISPLAY SELECT 3** key.
2. Using the **↑** or **↓** keys to change the selection containing the cursor character.
3. Using the **←** or **→** keys to move the cursor character between the three selections.
4. Pressing the **ENTER** key when all three selections are made.

Additional Application Examples

Select the **Set Defaults** menu item under the **SETUP** key prior to configuring measurements for a specific application, to ensure the configuration is starting from a known condition.

The following example procedure applies:

- If you need to measure harmonic content, amplitude, or phase while tracking the fundamental frequency
 - If you need to measure wideband amplitudes synchronously with the input signal—a requirement when below 1kHz.
- *To measure signal content of harmonics, amplitude, phase & sync:*
1. Set the **FUND: RANGE** menu selection to the desired range of fundamental frequencies. You may set any range of frequencies within the 0.0005Hz to 100kHz range, with a limit of a 128:1 range.

-
- More stable harmonic measurements will result if you set the frequency range to a ratio as low as possible, such as, 2:1. For example, set range from 40 to 80Hz for 60Hz measurements.
 - Under situations where the signal contains significant non-harmonic content, such as, asynchronous PWM or noise, or significant low order harmonic content,
—Then—
Set the frequency for this range to as low as possible. Note that this lowest position is just above the expected highest fundamental frequency.
2. Set the **From:** menu selection to obtain the fundamental frequency only from one of the inputs being used. Choose the input having the largest signal with the least extraneous signal content.
 3. Set the **Min Period:** menu selection to the desired update interval. The recommended setting is the longer time: 250mS or 4 periods of the minimum fundamental.
 4. Set the **Filter:** menu selection to eliminate any undesired high frequency signal content.
 - If the upper limit of the frequency range is above 1kHz, increase this setting.
 - If harmonic measurements of squarewaves or signals with significant non-harmonic content are to be performed,
—Then—
Set this as low as possible. The recommended setting is the lower of 50 times the fundamental, or 100kHz.
 5. Set the **Max Harmonics:** menu selection.
 - Set 0 if no harmonic analysis is required.
 - Set to 200, if measurements of phase or of high-order harmonic amplitude are required.
 - Set to 50 if measurements of amplitude harmonics, only, are required.
 - If you are performing phase measurements using squarewaves,
—Then—
The recommended setting is as high as possible—up to the maximum 2047.
 6. The default **Fundamental+BW:** selection (2) does not require changing, if the signal contains significant random noise, or you are measuring squarewaves.
 7. Change the default **Fundamental+BW:** selection (2), if an increase is needed for stable measurements.
 8. Change the **FFT Type:** setting to **Windowed**, if you are making only amplitude harmonic measurements, or phase measurements of squarewaves.

9. If the fundamental frequency is less than 20Hz, set the **Sync Averaging:** selection to none.

Note that the default **Sync Period:** selection (0.25S) does not require changing, as the instrument will automatically extend this period at low frequencies.

➤ *To measure harmonic content & wideband amplitudes in sync:*

Note: Applies where the input signal is below 1kHz and the fundamental frequency is either immeasurable or predictably within 2%.

1. Set the **Fund:** menu selection to **Fund: Fixed**, and set the frequency to the required fundamental frequency.
2. Set the **Min Period:** menu selection to the fastest desired update interval, whichever is the longer: 250mS or 4 periods of the fundamental.
3. If the fundamental frequency is above 500Hz, or the default 50kHz filter cutoff frequency is undesirable,
—Then—
Change the **Filter:** menu selection to **LOW-PASS FILTER CUTOFF FREQUENCY**.
4. In the **Max Harmonics:** menu selection set the harmonic to 50, or if no harmonic analysis is required, set it to 0.
5. The default **Fundamental÷BW:** selection (2) does not require changing.

➤ *To perform spectral analysis of the input signal.*

Note: For optimum results use an FFT type setting of Windowed.

1. Set the **Fund:** menu selection to **Fund: Fixed**, and set the frequency to the required frequency resolution for the spectral analysis.
2. Set the **Min Period:** menu selection to the fastest desired update interval. We recommend the longer time between 250mS or 4 periods of the frequency entered in step 3 of measuring signal content regarding setting minimum period.
3. Set the **Filter:** menu selection to the highest frequency desired to be included in the spectral analysis.
4. Set the **Max Harmonics:** menu selection to the number of spectral analysis points required. Note that the highest frequency within the spectral analysis is the frequency entered in step 1. above, times the maximum harmonics.
5. Set the **Fundamental÷BW:** selection to 1.

➤ *To measure wideband amplitudes over a known period of time:*

Example: when amplitudes are asynchronous to the input signal

1. Set the **Fund:** menu selection to **Fund:Fixed**, and set a frequency of 10kHz. This sets the resolution of the measurement to 100 μ s.
2. Set the **Min Period:** menu selection to the desired measurement interval. Note that any period between 1mS and 100000S may be entered.
3. If the default 50kHz filter cutoff frequency is undesirable,
—Then—
Change the low-pass filter cutoff frequency. Refer to the **Filter:** menu.
4. Set the **Max Harmonics:** menu selection to 0.

The instrument will downrange at 10mS intervals if autorange is enabled. We recommend you use a fixed input range if the signal contains more than 5% content (including amplitude modulation) at frequencies below 100Hz.

Interface Operation

The 6250 instrument has optional IEEE488 and RS232 interfaces, which may be configured to allow the instrument to be both controlled and interrogated by a computer.

Both interfaces operate in a similar manner, using the same command set. There are two operational differences between these interfaces:

- The ability of the IEEE488 interface to switch between remote and local command states, which the RS232 interface does not offer; and
- The ability of the controller to continuously read the same data from the IEEE488 interface, where as the controller must prompt the instrument to transmit the desired data from the RS232 interface each time.

Throughout this section it is assumed that you are conversant with manual operation of the instrument, and with the methods of operating the controller for the particular interface being used.

RS232 Data Format Selection

Ensure that the computer connected to the RS232 port is set to the same baud rate as the instrument's serial port, 8 bit data with no parity, 1 stop bit and 1 start bit. For normal operation, select the highest (38400 baud) rate.

Note that some IBM PC compatible computers do not operate correctly at the highest baud speed, particularly when operating in a multi-tasking environment. To reduce data transfer error rates you can decrease the selected baud rate, especially when your operating environment has severe interference; when you are using long cable lengths; or when you are unsure whether the computer is capable of this highest rate.

IEEE488 Interface Setup

Throughout this section of the manual, the use of a National Instruments AT-GPIB® IEEE488 controller board in an IBM AT (or compatible) is assumed. If you are using a different controller or a controller card from another vendor, then the exact

methods used will differ from those shown. If you are using a computer with a built-in interface (such as the Hewlett-Packard series 300 and similar computers) then no configuration is usually required.

Configure each interface via the 6250 instrument's front panel using the **SETUP** key in the **CONTROL** keypad and selecting the **Interface** option line. Interfaces for controlling the instrument must be selected as being "Control" type interfaces.

Other than enabling the interface to act as a control interface, setting the desired address and connecting the IEEE488 cable, you need not perform any specific configurations on the instrument. Note that as with all IEEE488 instruments and devices, ensure that the selected address does not conflict with any other devices in the system. When using the instrument with the National Instruments controller card (and with many other cards for the IBM AT) do not select an instrument address of zero, as this will conflict with the address of the card.

Table 1. Settings for the Instrument.

<i>Primary Address</i>	<i>2.1</i>	<i>Set EOI with EOS on Write</i>	<i>no.5</i>
<i>Secondary Address</i>	<i>NONE.1</i>	<i>Type of Compare on EOS</i>	<i>7-bit.4</i>
<i>Timeout Setting</i>	<i>T1s.2</i>	<i>Set EOI w/last byte of Write</i>	<i>yes.5</i>
<i>EOS Byte</i>	<i>0AH.3</i>	<i>Repeat Addressing</i>	<i>no.6</i>
<i>Terminate read on EOS</i>	<i>yes.4</i>		

Caution: To prevent unreliable operation of both the bus and the computer device names should not also exist as file, directory, or sub-directory names within the computer system as documented in the National Instruments manual. Additionally, when operating in a network environment, use names that are cryptic to reduce the probability of this kind of duplication occurring.

Notes:

1) Verify that the address matches what is configured in the instrument. This instrument does not use secondary addressing.

2) The only command that may hold the bus handshake for longer than 20mS is the device clear command. If this command is not used then even shorter timeout periods can be used to detect a failure. The device clear command may hold the bus handshake for up to one second. When using the command pass-through feature of

the MIB (i.e. controlling another instrument via the MIB) then longer timeout periods may be required.

3) This instrument always sends a carriage return (0DH) and a line feed (0AH) with EOI asserted at the end of each data transfer.

4) Terminating a data read with the defined EOS byte ensures that data transfers are correctly terminated. This ensures that you do not have to specify the exact number of characters for each transfer. Data transfers from this instrument is all 7-bit ASCII data with no parity.

5) This instrument will terminate a data receive operation with either a line feed character (0AH), or any character with EOI asserted, or with a device trigger. Selecting the EOI w/last byte of “Write” option ensures the shortest possible data transfer.

6) This instrument does not “unaddress” at the completion of a transfer. Thus, assuming no other device has been subsequently addressed, there is generally no requirement to re-address the instrument. However, if the instrument is locally reset to the local state then it must be re-addressed to reenter the remote state.

Configuring the Controller Card

Follow the manufacturer’s recommended installation procedure when installing the card in the computer. Note that when installing an IBM PC (i.e., 8-bit) card into an IBM AT type machine (i.e. 16-bit or higher), take particular note of the hardware interrupt and DMA input selected for the card.

Most manufacturers of these cards set these parameters to those compatible with the IBM PC, unfortunately these usually conflict with other cards normally found in the IBM AT class computers. Be aware that the first parallel port in an IBM AT class computer uses interrupt IRQ7.

When a conflict occurs between interrupts and DMA inputs, the problems may not appear for some time, or may only cause intermittent operation. The recommended action when any doubt occurs is to first deselect the DMA input, and secondly—if the problem persists—deselect the IRQ. Although this will perform slightly slower than the published specifications for the card, this will ensure that no conflicts occur.

Note: Some 8-bit cards will not reliably operate in high-speed computers (such as 80386 based machines). Consult the manufacturer of the card regarding this issue.

When operating using hardware interrupts and DMA inputs, and the computer is operating under the control of multi-tasking software, such as “Microsoft Windows”,

then there are many other issues that require attention. In these circumstances, consult with the vendor of the controller card for specific configuration details.

Configuring the Controller Software

With the National Instruments AT-GPIB controller card, and with many other cards, there is a configured “device driver” installed in the computer. Configure this driver correctly to ensure reliable operation with the instrument.

This section describes the settings that have been tested with the National Instrument AT-GPIB driver revision 1.5 accessed with the “ibconf” program supplied with the controller card, other drivers and revisions may be similar to those shown in Table 1. Note that these settings may be varied dependent on other instrumentation using the IEEE488 bus.

The selections show in Table 2 are only for data transfers regarding the controller card itself. Thus other settings may be used, but have not been fully tested by Vitrek.

Table 2. Controller Card Configuration (GPIB0)

<i>Primary Address</i>	<i>0.¹</i>	<i>Assert REN when SC</i>	<i>no.^{1,2}</i>
<i>Secondary Address</i>	<i>NONE.¹</i>	<i>Enable Auto Serial Polling</i>	<i>yes.³</i>
<i>Timeout Setting</i>	<i>T10s.¹</i>	<i>Timing</i>	<i>500nS.⁴</i>
<i>EOS</i>	<i>00H.¹</i>	<i>Enable 488.2 Protocols</i>	<i>yes.⁵</i>
<i>Terminate on EOS</i>	<i>no.¹</i>	<i>CIC protocol</i>	<i>no.²</i>
<i>Set EOI with EOS on Write</i>	<i>no.¹</i>	<i>Interrupt Setting</i>	<i>11.⁶</i>
<i>Type of Compare on EOS</i>	<i>7-bit.¹</i>	<i>Base I/O Address</i>	<i>02C0H.⁶</i>
<i>Set EOI w/last byte of Write</i>	<i>yes.</i>	<i>DMA Input</i>	<i>5.6</i>
<i>System Controller</i>	<i>yes.²</i>		

Notes:

1) These selections assume the use of a single controller. In configurations where a second controller exists these may be altered, other settings have not been fully tested by Vitrek.

- 2) This instrument does not currently use the SRQ and Serial Poll capabilities of the IEEE488 bus. This setting will be dependent on other instruments, thus does not affect your 6250 instrument.
- 3) Timings of longer than this are also valid. The 350nS selection has been tested on shorter cable lengths by Vitrek. and may be used. However, in normal operation there is little overall performance gain by using it with this instrument. If other, high speed, devices exist in the system then this shorter time may be selected.
- 4) This instrument does not use the IEEE488.2 specifications, thus this setting has no affect on this instrument if you have otherwise ensured that no IEEE488.2 type transfers take place with this instrument. If all other devices also do not use the IEEE488.2 type transfers, then this setting should be set to “NO” to ensure compatibility.
- 5) Although these settings have no affect on this instrument, ensure that no hardware conflicts exist with other installed devices in the computer. The settings shown above are highly recommended, as the probability of conflict is lowest with these settings.

Interrogating the Data

With either interface you may interrogate the various data held by the instrument.

Reading Data

Interrogation is achieved by sending a “DATA READ” command string that defines the data is to be interrogated, and then by reading that data from the instrument. Up to 1000 characters may be read from the instrument as a result of sending a DATA READ command. Refer to *Command Set* on page 74.

In the RS232 interface, this data is automatically transmitted from the instrument to the controller, the instrument will then wait for a further DATA READ command before sending further data.

In the IEEE488 interface, the controller may immediately attempt to read the requested data, the controller will then be held for a short delay (typically less than 1mS) until the requested data is available, then the requested data will be read by the controller. This data may be read by the interface any number of times; the data transmitted will always be the latest available data—unless the instrument is in the HOLD state.

In either interface, the instrument typically responds by sending a single *space* character, followed by a numeric string (with a preceding polarity symbol), followed by the respective *engineering format* exponent data in the form “*e+3*”, and terminated by the *carriage return* and *line feed* characters. Note that with the IEEE488 interface this last character is sent with the EOI line asserted.

Certain data do not follow this format, these are described in the following paragraphs. See the *READ=* command description. You may also request more than one item of data to be transmitted. In these cases the individual items sent from the instrument are separated by the comma (,) character.

Sending Data

Both the RS232 and IEEE488 interfaces operate similarly when sending data to the instrument, the only difference being, the requirement to place the instrument in the REMOTE state with the IEEE488 interface. ASCII characters transmitted to the interface are stored in a "buffer" until either a "line feed" character is received, or a character with the EOI line asserted, or a “Group Execute Trigger” command is received. The received characters then are decoded and actioned.

Up to 1000 characters may be stored in the “receive buffer”, which may contain more than one complete command string type if desired. If you send conflicting commands within the same command string, then the last effective command will be used.

Separate individual commands within the same strings using the (,) comma or (;) semi-colon characters. For commands that require several items of data, separate these data by the (/) forward slash or (:) colon characters. Note that only the colon character may be used for the *READ=* command.

The 6250 instrument operates on the received ASCII characters, the command used to send these characters via the designated interface is dependent on the computer system and peripheral used.

RS232 Interfacing

The RS232 interface is configured to use the RS232 hardware "handshake" lines RTS and CTS to handshake data. The usage of these hardware "handshake" lines ensures that data will not be lost due to different speeds in the instrument and the computer. Sometimes the particular computer used is not able to use these handshake lines properly.

As an example, some computer systems continue to transmit a few characters after being “held off” from transmitting. Place delays between sending individual command strings in these cases to prevent “data overrun.”

IEEE488 Interfacing

There are several differences between the IEEE488 and RS232 interface operation, these are all due to the extended capabilities of the hardware interface of the IEEE488 standard.

Bus Timing

Almost all of the timing requirements of the bus interface are handled by the hardware handshake system used by the IEEE488 interface. During decode of a command all further received data are "held-off" by this hardware handshake until the decode has been completed. Typically, data transfer rates of up to 50,000 characters per second are attainable.

Bus Commands

As previously mentioned, the IEEE488 interface can perform tasks that the RS232 does not, such as, using separate *remote* and *local* states. In either state, the instrument may have its present status read by the interface.

Local state—

Following the initial application of power, the instrument will only respond to commands from the instrument’s front panel while in the local state.

You can release the instrument back to the local state (from remote) by a command, or by pressing the **LOCAL** key on the front panel. The light next to the **LOCAL** key indicates when the instrument is in the local state.

Remote state—

This state is entered via the IEEE488 interface bus. Normally this is achieved automatically when the instrument is correctly addressed to “listen” to a command string. After placing the instrument in the remote state, via the interface command, the instrument will only respond to commands received via the interface.

Device Clear—

The IEEE488 defined DEVICE CLEAR functions (both selective and global) force the instrument to perform a power-on reset function.

Interface Clear—

The IEEE488 standard defines this command, which causes the interface portion of the instrument to be reset to the power on conditions, aborting any bus activity in progress.

Should a handshake sequence improperly complete during a transfer of data to, or from, the IEEE488 interface, the instrument will automatically perform a POWER-ON RESET sequence. This facility prevents the interface from becoming “locked out” if the interface cable is removed or becomes faulty during a data transfer.

Note: Following a POWER-ON RESET, or a DEVICE CLEAR via the IEEE488 interface, all analog outputs are returned to their respective front panel configured parameters, inputs, zero offsets and spans.

Application for the Lower Case Portions of Commands

The upper-case portion is the command operator, the lower case portions represent the optional parameter(s) for the command.

- **parameter—**
Specifies placement (position) for the required parameter’s descriptor. Refer to the end of this section for a complete list of the available parameter descriptors and formats.
- **n—**
An integer number having the specified range. In cases where more than one digit is possible, you may optionally place the leading zero characters. This data may not have a preceding polarity sign character.
- **numeric—**
A floating point number having the specified units. This data may have an optional preceding polarity character. The decimal point is optional, and may be in any desired position. “e” format numbers are also accepted.
- **string—**
One of the specified possible character strings for the specific command, can be up to 12 characters in length.

Command Set

The various features of the instrument may be controlled by the controller sending certain command “strings” to the instrument.

The features include:

- Distribution of “space” and non-printing characters between commands throughout the command string.

- The ability to use either lower or upper case characters.
- Capability of sending more than one command before sending the termination character.
- Three ways of terminating commands: by the reception of a *line feed*; by the reception of a character with the EOI line asserted; or by the reception of the “Group Execute Trigger” command.

Interface Commands

The following commands are available with both the RS232 and the IEEE488 interfaces. They allow you to:

- Control another instrument or power supply via this analog level.
- Override an analog output used to drive a plotter or alarm output.

CLRDISPLAY—

This command clears all display lines.

CLRUPTIME—

This command clears the timer which may be used to identify the exact time at which each input’s parametric data was last established (see the ‘*READ=*’ command’s ‘*UPTIME[i]*’ parameter).

DISP[n]=parameter—

This command specifies that the selected display line (*n*), a possible 0 through 49, will display the specified parameter. If the optional (*n*) portion is not specified, or specifies a line beyond the last defined line, then the first undefined line is affected. The = character is optional. See the list at the end of this section for the available parameter descriptors.

FFT=maxharm/bandwidth/type—

This command configures the FFT based harmonic analysis as defined by MAXHARM/BANDWIDTH/TYPE. Refer also to the commands *FUND* and *HARMS*.

MAXHARM—

This integer defines the highest harmonic number which is to be made available, this overrides any requests for higher harmonics by individual parameter requests. Setting this to 0 disables FFT based harmonic analysis for this group.

BANDWIDTH—

This integer defines the ratio between the fundamental frequency and the bandwidth over which each harmonic is measured. Setting this to 0 disables FFT *based harmonic analysis for this group*.

TYPE—

This string may be either NORMAL or WINDOWED.

FILT=n or **FILT=numeric**—This command sets the input as using a digital filter. The = character is optional. The available formats are as follows:

- **FILT=0**—No filtering.
- **FILT=numeric**—Sets the low pass filter corner frequency to the passed numeric value, in Hz. A minimum value of 6Hz is allowed, a value in excess of 200kHz yields a 5mHz filter.

FMEAS=min/max/period/filter—

This command sets the measurement of frequency as being performed over the frequency range from *min* to *max* numeric value frequencies, in Hz, over the *period* numeric value, in seconds. This frequency measurement command uses the optional result filtering of **0**=none, **1**=fast, **2**=medium, **3**=slow.

If the specified input is enabled as a synchronization source to establish the fundamental frequency of one or more input groups,
—Then—

The frequency measurement command sets all input measurements to these values and sets the minimum expected frequency to the value specified by *min*. Note that for down ranging purposes, refer also the *RANGETIME* command.

FUND=string—This command sets the input as having its fundamental frequency defined by string. Valid string contents are as follows:

- **chlist/inlist/multiplier**—the fundamental frequency is established from the input(s) listed in the string **chlist** (e.g. *ABC*), using the input(s) listed in the string **inlist** (e.g. *VI*), using an optional *multiplier* numeric quantity. The inputs specified must all be members of the group to which the [i] input belongs, or be a single nonmember input.
- **Numeric**—the fundamental frequency is set to the fixed value set by the *numeric* value (in Hz).

HARM=string—

This command sets the measuring harmonic signal content as defined by *string*. See also the *FFT* and *FUND* commands.

Valid string contents:

- **OFF**—no harmonic analysis is performed within the group. The FFT command has no affect with this setting.
- **SINGLE**—a single harmonic analysis is performed within the group during each amplitude measurement period.

- **NORM**—harmonic analysis is performed within the group, with multiple analysis being averaged during the measurement period, as necessary, to encompass the entire period.

HOLD—

This commands the instrument to enter the **HOLD** state. All database parameters are maintained at the values present at the time this command is received. These parameters may be subsequently released by the **RUN** command.

MEAS=numeric—

This command specifies the measurement period (in seconds). The numeric portion may be between 0.001 and 10000.0 inclusive, values outside this range will be set to the closest allowable value.

RANGETIME=numeric—

This command sets the minimum downrange timing. Set by entering a numeric value, in seconds. This value is only used if the downrange time is more than 1/2 of the fundamental frequency's minimum period (as defined in your instrument).

READ=parameter—

This command determines which parameter(s) the instrument will transmit next to the controller. For the RS232 interface the requested data will be transmitted automatically following decode of this command, whereas the IEEE488 will simply store this request until the instrument is next interrogated by the controller (i.e. addressed as a talker).

Several parameters (up to a maximum of 30) may be specified to be read simultaneously, if desired, with a maximum response string length of 1000 characters. Here, each *parameter* should be separated by the ":" (colon) character. If **READ** is commanded, then each data item read will be separated by the "," (comma) character in the received data string.

RECALL=n—

This commands the instrument to reset the configuration to that contained in the specified storage location. The number **n** should be between 0 and 65535. Note that this also sets, which saved configuration will be retrieved following a reset of the instrument.

RESYNC—

These commands allow you to resynchronize parameter readings to accommodate changes in the input waveforms. This command has no affect if the instrument is presently in the **HOLD** state. The overall affect of implementing the **RESYNC** command is that any measurement in progress is aborted and a new measurement is initiated immediately following any settling delay that is imposed by input filtering requirements.

Note: Attempts to read data from the instrument during the RESYNC will be *unavailable* until the next measurement is completed.

RUN—

This command releases a previously received **HOLD** command. If the instrument is not presently in the **HOLD** state then this command has no effect.

SAVE=n/string—

This commands the instrument to save the present configuration in the specified storage location. The number **n** can be set between 0 and 65535. Note that this also sets which saved configuration will be retrieved following a reset of the instrument. The command may optionally contain a name *string*, which is used to name the specified storage location.

@—

This character command is used in the RS232 interface to cause the results of a previously defined set of parameter data requests (i.e. **READ=parameter** command) to be resent with the latest available data.

Available Parameter Strings

The **DISP** and **READ** commands accept the string components as defining the data to be interrogated, where:

parameter[source and bandwidth]{sub-definition string} and special-parameter

parameter—

is a string defining the parameter

source and bandwidth—

Is a series of strings or numeric data defining the source and bandwidth for the parameter, this string is surrounded by “{ and }” (square brackets).

sub-definition string—

Is an optional string, enclosed by “{ and }” (curly braces), containing optional additional operations to be performed on the parameter result. If no further processing is required, then the surrounding brackets/braces need not be present.

special-parameter—

Is a special parameter definition string defining the special (textual) data to be retrieved.

Retrieving Parameters

A parameter string contains one of the following strings, which defines the “base” parameter to be retrieved. For example, the defined string “source and bandwidth” retrieves the parameter’s source and bandwidth:

The available formats are as follows:

AMPL—

The RMS amplitude (i.e. Volts or Current). This parameter requires a single input source and either a string bandwidth or a pair of integers defining the harmonic range for the data. The default units for these results is V_{rms} or A_{rms} as applicable.

AMPLFR—

The RMS amplitude (i.e. Volts or Current). This parameter requires a single input source and a pair of numeric frequencies defining the center frequency and half-bandwidth for the data (in Hz). (Note that this data is not available from the front panel). The default units for these results is V_{rms} or A_{rms} as applicable.

AVG—

The average rectified amplitude (i.e. Volts or Current). This parameter requires a single input source. The default units for these results is V or A as applicable.

CORREL—

Power Factor or Correlation (i.e. W/VA). This parameter requires a input or group of inputs, and either a string bandwidth or a pair of integers defining the harmonic range for the data. The default units for this result is none.

CF—

Crest Factor (i.e. Peak/RMS Volts or Current). This parameter requires a single input source and a string bandwidth. The default units for this result is none.

DPF—

Dissipation or Displacement Power Factor (i.e. W/VA at the fundamental frequency only). This parameter requires a input or group of inputs. The default units for this result is none.

EPA—

The inverse cosine of Power Factor. This parameter requires an input or group of inputs, and either a string bandwidth or a pair of integers defining the harmonic range for the data. The default units for this result is radians.

FF—

Form Factor (i.e. RMS/Average Rectified Voltage or Current). This parameter requires a single input source. The default unit for this result is “none”.

FREQ—

Frequency. This parameter requires either a single input source, or a single input source and an optional single integer harmonic number. The default unit for this result is Hz.

GAIN—

The Gain or ratio between any two signals. This parameter requires a single input source and single integer harmonic (dividend), and a single reference source and single integer harmonic (divisor). The default unit for this result is none (i.e. a pure ratio).

GAINI—

The imaginary portion of *GAIN* (see above, $GAIN = GAINR + j.GAINI$). Both inputs should belong to inputs within the same group for the result to be meaningful. The default unit for this result is none (i.e. a pure ratio).

GAINR—

The real portion of *GAIN* (see above, $GAIN = GAINR + j.GAINI$). Both inputs should belong to inputs within the same group for the result to be meaningful. The default unit for this result is none (i.e. a pure ratio).

HIGH—

The highest positive excursion of a signal (Volts or Current). This parameter requires a single input source. The default unit for these results is Vpk or Apk as applicable.

HZ—

Frequency (alternative for *FREQ* above).

IMAG—

The quadrature portion of a signal (Volts or Current). This parameter requires a single input source and single integer harmonic, and a single reference source and single integer harmonic. Both inputs should belong to the same group for the result to be meaningful. The default unit for these results is *Vrms* or *Arms* as applicable.

IMP—

The load impedance (i.e. Volts/Current). This parameter requires a input and either a string bandwidth or a pair of integers defining the harmonic range for the data. The default unit for this result is ohms.

INPHS—

The In-Phase portion of a signal (Volts or Current). This parameter requires a single input source and single integer harmonic, and a single reference source and single integer harmonic. Both inputs should belong to the same group for the result to be meaningful. The default unit for these results is *Vrms* or *Arms* as applicable.

LOW—

The highest negative excursion of a signal (Volts or Current). This parameter requires a single input source. The default unit for these results is Vpk or Apk as applicable.

PEAK—

The largest absolute value of *HIGH* or *LOW* (see above).

PF—

An alternate for *CORREL* (see above).

PHASE—

The Phase between two signals. This parameter requires a single input source and single integer harmonic, and a single reference source and single integer harmonic. Both inputs should belong to the same group for the result to be meaningful. The default unit for this result is radians.

PHS—

An alternate for *PHASE* (see above).

PKPK—

The difference between *HIGH* and *LOW* (see above).

PKVA—

The highest recorded absolute value of instantaneous VA. This parameter requires a single input source. The default unit for this result is VApk.

PK—

An alternate for *PEAK* (see above).

PWR—

True Power. This parameter requires an input or group of inputs and either a string bandwidth or a pair of integers defining the harmonic range for the data. The default units for this result is W.

QUAD—

An alternate for *IMAG* (see above).

R—

The load resistance (i.e. in-phase Volts/Current, $IMP = R + j.X$). This parameter requires a input and either a string bandwidth or a pair of integers defining the harmonic range for the data. The default unit for this result is ohms.

RATIO—

An alternate for *GAIN* (see above).

RATIOI—

An alternate for *GAINI* (see above).

RATIOR—

An alternate for *GAINR* (see above).

REAL—

An alternate for *INPHS* (see above).

REA—

The load reactance (i.e. quadrature Volts/Current, $IMP = R + j.REA$). This parameter requires a input and either a string bandwidth or a pair of integers defining the harmonic range for the data. The default unit for this result is ohms.

RECTIFY—

An alternate for *AVG* (see above).

RES—

An alternate for *R* (see above).

RMS—

An alternate for *AMPL* (see above).

SPAMPL—

The signal amplitude measured at the specified spectrum point for the specified single input. The default unit for these results is *Vrms* or *Arms* as applicable.

SPFREQ—

The frequency associated with the specified spectrum point for the specified single input. The default unit for this result is Hz.

THDF—

The Total Harmonic Distortion of the selected signal (Volts or Current), relative to its fundamental component. This parameter requires a single input source and a single integer defining the highest harmonic to include in the summation. The default unit for this result is none (i.e. a pure ratio).

THDH—

The Total Harmonic Distortion of the selected signal (Volts or Current), relative to its total harmonic content. This parameter requires a single input source and a single integer defining the highest harmonic to include in the summations. The default unit for this result is none (i.e. a pure ratio).

THDT—

The Total Harmonic Distortion of the selected signal (Volts or Current), relative to its total RMS content. This parameter requires a single input source and a single integer defining the highest harmonic to include in the summation. The default unit for this result is none (i.e. a pure ratio).

VAR—

Reactive or Imaginary Power. This parameter requires a input or group of inputs and either a string bandwidth or a pair of integers defining the harmonic range for the data. The default unit for this result is VAR.

VA—

Apparent Power. This parameter requires a input or group of inputs and either a string bandwidth or a pair of integers defining the harmonic range for the data. The default unit for this result is VA.

WATTS—

An alternate for *PWR* (see above).

X—

An alternate for *REA* (see above).

Z—

An alternate for *IMP* (see above).

Source and Bandwidth Strings

The *source and bandwidth* strings contain one or more of the following strings separated by commas:

A—Input A.

B—Input B.

S—Input SYNC

AB—Input pair A and B.

I, IN or INPUT—The total of all inputs defined as measuring input parameters.

O, OUT or OUTPUT—The total of all inputs defined as measuring output parameters.

DC—The DC component only of a parameter.

AC—The AC component only of a parameter.

ACDC or **DCAC**—The DC and AC components (i.e. the total) of a parameter.

AC+DC or **DC+AC**—The DC and AC components (i.e. the total) of a parameter.

Integer—A harmonic in the range 0 through 2047.

Sub-Definition Strings

“Sub-definition strings” are separated by semi-colons. See the following strings:

FILTER=numeric—

Sets that this parameter result is to be filtered with the set numeric time constant (in seconds).

UNITS=string—

Sets that the resultant units for the parameter are to be those specified by *string*. See a later section for available units strings.

NOMINAL=parameter[source and bandwidth]—

Sets that the nominal or reference value of this parameter is the value of the set parameter with its associated source and bandwidth.

NOMINAL=numeric—

Sets that the nominal or reference value of this parameter is the value of the *numeric*.

NOMINAL@parameter[source and bandwidth]—

Sets that the nominal or reference value of this parameter is the value of the set parameter with its associated source and bandwidth, this value being established at the time that this string is decoded.

DELTA—

Sets that the difference between the parameter and the reference or nominal value is to be obtained. A *nominal* string must be present. Use only one of *DELTA*, *RATIO*, *DELTAR* or *LIMIT* formats for a single parameter.

RATIO—

Sets that the ratio between the parameter and the reference or nominal value is to be obtained. A *nominal* string must be present. However, use only one of *DELTA*, *RATIO*, *DELTAR* or *LIMIT* formats for a single parameter.

DELTAR—

Sets that the ratio between the difference between the parameter and the reference or nominal value, and the nominal value, is to be obtained. A *nominal* string must be present. However, use only one of *DELTA*, *RATIO*, *DELTAR* or *LIMIT* formats for a single parameter.

LIMIT=numeric—

Sets the maximum allowable deviation from the reference or nominal value. The string HIGH, PASS or LOW is returned instead of the value of the parameter. Use only one of *DELTA*, *RATIO*, *DELTAR* or *LIMIT* formats for a single parameter.

Special Parameter Strings

The special-parameter strings are available as follows:

BLANK (DISP[n]= only)—

Defines a blank ("--") display line.

DELETE (DISP[n]= only)—

Defines that the display line is to be deleted, the 'gap' caused by this is 'closed' up by shifting all lower display lines upwards.

DATE—

Defines that the date will be returned, in the format set by the SYSTEM menu entry.

TIMEDATE—

Defines that the time and date will be returned in the formats set by the SYSTEM menu entry, separated by a single space character.

TIME—

Defines that the time will be returned in the format set by the SYSTEM menu entry.

ACCTIME—

Defines that the number of seconds within the nearest millisecond that the running accumulation will be returned.

UPTIME[i]—

Defines that the number of seconds within the nearest millisecond, at which the selected input's measurement data was last updated will be returned. This data may be reset to zero at any time using the **CLRUPTIME** command, which clears all inputs' timers simultaneously.

ID (READ= only)—

Defines that a string defining the instrument and software revisions are to be returned. See ID Data Format.

ID Data Format

READ=ID—

Returns data having the following sub-strings, separated by comma characters. 6250:

- nn.nn* main software revision.
- nn.nn* inputs A & B supervisor DSP software revision (00.00 if not fitted).
- nn.nn* inputs A & B amplitude DSP software revision (00.00 if not fitted).
- nn.nn* analog I/O co-processor software revision (00.00 if not fitted).
- 00.00* a special string allocated to any customer special software versions. This enables customer specific instrument to be recognized.

UNITS=String Format

Ensure **UNITS=string** within a **sub-definition string** contains one of the following units definition strings available in the instrument. Not all parameters are compatible with all units strings, wherever possible the instrument will attempt to convert the base parameter to the desired final units. Setting a unit does NOT change the bandwidth of the parameter, nor change the parameter itself. The strings shown below are case-sensitive.

- a blank string is no units
- %**—Percentage (ratio)
- Aac**—AC Amperes
- A**—Amperes
- Aavg**—Average, or Mean Rectified Amperes
- Adc**—DC Amperes
- Aimag**—Imaginary Amperes
- Apk**—Peak Amperes
- Apkpk**—Peak to Peak Amperes
- Areal**—Real Amperes
- Arms**—RMS Amperes
- cps**—Cycles-Per-Second
- dB**—decibel (ratio)
- dBmW**—Power decibels rel. to 1mW level
- dBuV**—Voltage decibels rel. to 1μV level
- dBV**—Voltage decibels rel. to a 1V level
- dBW**—Power decibels rel. to a 1W level
- deg360**—degrees (0-360° range)

deg—degrees ($\pm 180^\circ$ range)
grad—grads
HP—Horse Power
Hr—Hours
Hz—Hertz
ohm—Ohms
pirad—pi-radians (1 is equiv. to 180°)
rad—radians
rpm—Revolutions-Per-Minute
s—seconds
S—Siemens
V—Volts
VAac—AC Volt-Amperes
Vac—AC Volts
VAdc—DC Volt-Amperes
VApk—Peak Volt-Amperes
VARac—AC Reactive Power
VAR—Reactive Power
Vavg—Average & Mean Rectified Volts
VA—Volt-Amperes
Vdc—DC Volts
Vimag—Imaginary Volts
Vpk—Peak Volts
Vpkpk—Peak to Peak Volts
Vreal—Real Volts
Vrms—RMS Volts
W—Watts
Wac—AC Watts
Wdc—DC Watts

Full-Parameter Definition Format

This section shows some examples of full-format parameter definitions. These may be used to define individual items to be interrogated via the interface (i.e. in a **READ=** command) or to define a display line (i.e. in a **DISP[n]=** command). In the case of the **READ=** command, multiple items may be defined for interrogation at the same time (up to 30 items) by separating each parameter definition by the: (colon) character.

AMPL[A]—

Defines AC+DC RMS amplitude on input A.

AMPL[A,DC]—

Defines DC only RMS amplitude on input A.

AMPL[B,1,1]—

Defines fundamental only (harmonic #1) amplitude on input B.

AMPL[F,2,1000]—

Defines RMS amplitude on input F measured over the range of 2nd harmonic thru' the 1000th harmonic.

AMPLFR[B,20e3,5e3]—

Defines RMS amplitude on input B measured over a range centered on 20kHz with a ± 5 kHz bandwidth (i.e., 15-25kHz).

RATIO[A,1,B,1]—

Defines the ratio between the fundamental amplitude of input A and the fundamental amplitude of input B.

THDF[B,49]{UNITS=%}—

Defines THD (relative to fundamental) on input B, measured up to and including the 49th harmonic, expressed in percentage units.

AMPL[A,AC]{NOMINAL=AMPL[B,AC];LIMIT=5.0;FILTER=2.00}—

Defines a pass/fail check of the AC amplitude of input A, compared continuously against the AC amplitude of input B, allowing up to 5V difference before failing, and using a 2 second single order filter.

RATIO[B,3,B,1]{NOMINAL=0.0;LIMIT=0.2}—

Defines a check of the ratio between 3rd harmonic and fundamental amplitude of input B, with a maximum limit of 20%.

High Speed Operation

The 6250 instrument has the capacity to operate at over 100 readings per second when correctly configured. This section covers some useful information concerning achieving the highest possible speed from this instrument.

Measurement Periods

The highest possible reading rates are obtained when only those inputs, which are required to be high speed are configured with short measurement periods. Inputs that are not required can be turned off, or set to an amplitude measurement period in excess of 0.25 seconds. See the MEAS command for details.

Frequency Measurement

Inputs which are not configured for use for fundamental frequency determination should have their frequency measurement turned off. There is a significant speed improvement when the fundamental frequency range covers a range of less than 2:1. If harmonic measurements are not needed, or the fundamental frequency is well known (to within 1%, e.g. line voltage), then the use of a fixed frequency fundamental will achieve significant results. See the FMEAS and FUND commands for details.

Harmonic Measurement

Only enable a harmonic measurement in groups of inputs for which it is required. The maximum range of harmonics should be limited and the fundamental: bandwidth ratio kept to the default values, if possible. If high frequencies are to be measured, then a significant improvement in speed can be realized by only allowing a single analysis per measurement period. See the HARM command for further details.

Interrogating Results

Read as many parameters at the same time as possible. This saves time in reducing the transmission of new READ= commands, and their decode in the instrument.

The amount displayed on the front panel should be reduced to as little as possible (less than four lines if possible) and any display line filters should be eliminated as these are continuously updated whether displayed or not.

Maintenance & Calibration

This chapter discusses the procedures you can use to ensure your instrument remains optimally functional. They include routine maintenance and calibration.

Daily Maintenance

For optimum DC offset performance, perform an Input Calibration sequence at daily intervals, or following 5°C + temperature changes. Perform an Internal Calibration for optimum phase performance.

The following daily procedure is highly recommended to ensure that the highest quality of measured results is obtained.

Low Level DC Measurements

In all cases, if the operation of the instrument is suspect, the operating temperature of the instrument has significantly changed, or the instrument has not been in use for longer than 30 days, then perform this procedure.

Procedure without Equipment

This procedure requires no external equipment and no external connections. Note that external connections present need not be removed during the procedure.

1. Ensure that the instrument has been operating for at least 30 minutes.
2. Press the **Cal** key.
3. Press the **DISPLAY SELECT 1** key (next to the System Status display line).
 - a) Take careful note of the scrolled display messages.
 - b) If any input(s) are shown as **inactive** or **faulty** then the instrument requires repair, corrective action is required.

- c) If any of the **DSP COMM RETRIES** percentages are in excess of 10% then this indicates that either the environment is exceptionally noisy, or that the instrument contains a fault which is currently being overcome due to internal redundancy. Note that small percentages of less than 0.1% are normal and should not be cause for concern.
 - d) Take note of the numbers displayed during the **LAST INT INP EXT CAL** status display. If any of the **INP** or **EXT** column displays numbers in excess of the recommended calibration interval in use by your facility, then the instrument is overdue for calibration against certified standards. Note that Vitrek recommends 1 year, or 365 days
If any of these numbers show “?” or “req”, it indicates the instrument has “lost” some of its calibration data, and calibration against certified standards is definitely required.
4. When the **System Status** messages have completed (typically 10 seconds), press the **Cal** key.
 5. Press the **DISPLAY SELECT 2** key (next to the **Internal Calibration** display line).
 - a) The instrument will automatically perform an internal test and calibration of its analog and digital circuitry. If any error messages come up during this procedure, then this indicates that an internal fault has been discovered, and corrective action is required.
 - b) When the **Internal Calibration** procedure has been successfully completed (30 to 60 seconds typically), press the **ENTER** key. This returns the instrument to normal operation.
 6. This concludes the recommended daily maintenance procedure.

Procedure with Equipment

This procedure requires the use of either shorting plugs or 50 Ω terminators on all voltage inputs of the 6250 instrument. All external input wiring should be removed during this procedure.

1. Operate the instrument for at least 30 minutes before performing. Verify time.
2. Press the **Cal** key.
3. Press the **DISPLAY SELECT 1** key (next to the **System Status** display line). Take careful note of the scrolled display messages.
 - a) If any input(s) are shown as **inactive** or **faulty** then the instrument requires repair, corrective action is required.

- b) If any of the **DSP COMM RETRIES** percentages are in excess of 10% then this either indicates the environment is exceptionally noisy,
—Or—
Indicates the instrument contains a fault that is currently being overcome due to internal redundancy. Note that small percentages of less than 0.1% are normal and are not cause for concern.

- c) Note the numbers displayed during the **LAST INT INP EXT CAL** status display.

If any of the **EXT** column displays numbers in excess of the recommended calibration interval in use by your facility, then your 6250 instrument is overdue for calibration against certified standards. Note that Vitrek recommends 1 year, or 365 days.

If any of these numbers show ? or req, then this indicates that the instrument has “lost” some of its calibration data, and calibration against certified standards is definitely required.

4. When the **System Status** messages have completed (10 seconds typically), press the **CAL** key.
5. Ensure that shorting plugs or 50 Ω terminators are fitted on all voltage inputs and check that all other external input wiring has been removed.
6. Press the **DISPLAY SELECT 3** key (next to the **Input Calibration** display line).
 - a) The instrument automatically:
Performs an internal test and calibration of its analog and digital circuitry,
Checks and calibrates any DC offsets present in its input circuitry.
 - b) If any error messages are displayed during this procedure, then this indicates that an internal fault has been discovered, and corrective action is required.
7. When the **Input Calibration** procedure has been successfully completed (45 to 90 seconds), press the **ENTER** key. This returns the instrument to normal operation.
8. This concludes the recommended daily maintenance procedures.

External Calibration

Externally calibrate the 6250 instrument against certified standards at yearly intervals. Note that this procedure calibrates the Voltmeter for certifiable amplitude accuracy only. The frequency response characteristics, phase accuracy and other performance aspects of the 6250 Voltmeter are intrinsic to its design, and are not adjustable. However, these aspects can be checked as a maintenance routine following calibration to verify correct operation.

Preparation for Calibration

Prior to performing the external calibration procedure, perform the following actions:

1. Continuously power the 6250 instrument in the calibration environment for at least 1 hour prior to attempting calibration.
2. Ensure that all input connectors and cable connectors are clean and free of corrosion.
3. Ensure that the instrument has been set for the correct date and time.
 - a) Press the **SETUP** key.
 - b) Press the **DISPLAY SELECT** key next to the **Set Time and Date** line. It may be necessary to press the **↓** key once or twice to display this line
 - c) If the displayed date and time does not require changing, then press the **CLEAR** key at this time, and disregard the remainder of this sub-procedure.
 - d) Set the displayed time format to 24hr format (press the **DISPLAY SELECT 1** key to change the format).
 - e) If the displayed time requires changing. Press the **DISPLAY SELECT 3** key, enter the correct time using the numeric keys (in 24hr format, hh:mm:ss) and then press the **ENTER** key.
 - f) If the displayed date requires changing. Press the **DISPLAY SELECT 4** key, enter the correct date using the numeric keys (in the format displayed in the second line of the display) and then press the **ENTER** key.
 - g) Return the displayed time format to that previously selected.
 - h) Press the **ENTER** key.
4. Perform an Input Calibration of the instrument with all voltage inputs either shorted or with 50 Ω terminations fitted. If any input fails this procedure then make all corrective actions prior to performing an external calibration.
 - a) Press the **CAL** key.
 - b) Ensure that all voltage inputs are either shorted or have 50 Ω terminators fitted.
 - c) Press the **DISPLAY SELECT 3** key (next to the Input Calibration line of the display).
 - d) The instrument automatically performs the procedure and will display an error message should any input fail. If any input does fail this procedure then perform corrective action prior to performing an external calibration.
 - e) When the procedure is completed, as indicated in the display of the 6250 instrument, press any of the **DISPLAY SELECT** keys.

Required Equipment

Vitretek recommends the use of a Fluke 5700A+5725A with wide band option as the calibration standard for external calibration of the 6250 instrument. This equipment should have its wideband output (50 Ω) previously calibrated at the desired frequency and output levels into a known 50 Ω load, if its stated accuracy is insufficient.

Other equipment may be used with the following output levels required at the desired frequency of calibration. For the required accuracy at each level, see the specifications section of this manual.

700V, 200V, 65V, 20V, 6V, 2.5V, 750mV, 200mV, 70mV, 20mV and 6mV

2.5V, 750mV, 200mV, 70mV, 20mV and 6mV at 50 Ω

750mA, 250mA, 75mA, 25mA, 7.5mA, 2mA and 600 μ A

Calibration Procedure

The steps to this external calibration procedure are prompted by the instrument. Before initiating an external calibration procedure, decide upon a frequency at which the instrument is to be calibrated. Choose the frequency most commonly used in the range 10Hz to 1kHz. Frequencies up to 10kHz may be used with some resultant degradation in the low frequency performance of the instrument. Note that Vitretek calibrates the 6250 instrument at a frequency of 400Hz, unless otherwise instructed.

Warning: *HIGH VOLTAGES MAY BE PRESENT.* When moving the input connection to a different input connector, ensure that the output voltage has been fully removed before touching the outer shell of the BNC connector.

➤ *To perform an external calibration:*

1. Press the **CAL** key.
2. Press the **DISPLAY SELECT 4** key (next to the display line showing External Calibration).
3. Repeat steps 4 through 9 for each input level prompted in the uppermost display line. Take careful note of the following points:
 - Most output levels are repeated for different groups of inputs.
 - Ensure that the correct input connector is used for each step, all voltage calibration steps use the respective V BNC connector, while all current calibration steps use the respective A BNC connector.

- You may need to reset the calibration source's output frequency to maintain the desired frequency in each step.
 - Although multiple inputs are allowed, calibrate only one input at a time. NEVER connect any inputs in parallel for other than normal voltage calibration points.
 - Particularly when performing the 50 Ω voltage input steps, ensure that the BNC input connector is properly seated, is clean and is clear of corrosion, at both the instrument and the source ends of the cable.
 - The GUARD terminals of the instrument are automatically set for external connection during this procedure; these should be tied to the GUARD or other suitable terminal on the source during the entire procedure.
 - This procedure includes calibrations with high accuracy at low voltage levels. Ensure that there are no significant noise sources nearby with frequencies close to the calibration frequency.
 - During the procedure, the input range of the instrument is held at that required for the calibration level. When changing input connections, or stepping the instrument to the next calibration step, the Overload light may illuminate momentarily, this should be disregarded. If Overload remains illuminated during the calibration step, then investigate a cause. The instrument's internal protection systems are enabled at all times, thus no damage to the instrument will result unless the specified overload abilities of the instrument are exceeded.
4. Repeat steps 5 through 8 for each input listed in the display.
 5. Ensuring that the calibration source is in Standby, or otherwise has its output disabled, attach the calibration source's output terminals to the input of input terminals when **Input Applied?** shows in the display.
 6. Set the calibration source's output level to that displayed in the uppermost line of the display and allow time for the source to settle to within the required accuracy.
 7. For the input being calibrated, press the **DISPLAY SELECT** key next to the line for that input. The 6250 instrument will now display the actually measured input level and the percentage deviation of the instrument at that level.
 8. After allowing the displayed values to settle, a few seconds, press the **DISPLAY SELECT** key next to the line for that input. That display line will then change to **Completed**. If the calibration results with an out of tolerance condition within the instrument, then an error message will be issued and that input will not be available for external calibration for the remainder of the procedure.

9. Press the **DISPLAY SELECT 1** key to step to the next calibration step. When the uppermost display line indicates **Ext. Cal. Completed**, this external calibration procedure is completed.
10. When the procedure is complete, then the uppermost display line indicates **Ext. Cal. Completed**. You may select to store the calibration data collected by pressing any of the **DISPLAY SELECT** keys or the **ENTER** key. If any input failed calibration, then its calibration data will not be updated by this action. To abort the calibration without storing any data collected, then press the **CLEAR** key at any time during the procedure.

Performing a Partial Calibration

In certain conditions, it may be desired to only partially perform a calibration procedure. This is achieved by following the same procedure outlined above, but skipping any input or output level by either not pressing the respective input's **DISPLAY SELECT** key or by pressing the **DISPLAY SELECT 1** key immediately during each step.

Performing a Calibration Check Only

The standard external calibration procedure shown above may also be used for a calibration check only.

- *To perform a calibration check:*
 1. Note the percentage deviations displayed.
 2. When all steps have been completed press the **CLEAR** key, to discard the calibration data collected.

Appendix A: AIO Option

The AIO Option is an Analog Output, providing 12 analog interface outputs driven from a single, multiplexed, 16-bit digital-to-analog converter. This sub-system is controlled by a single Motorola DSP56001 24-bit processor, which is interfaced to the central processor via an internal high speed RS485 data link. Refer to Figure 8, Rear Panel Partial View.

The Analog Output and the Digital I/O connectors supports the AIO option when fitted. You can request this option to be fitted with your Phase Angle Voltmeter.

AIO Option Features

This option's key features include:

- Each analog output is individually settable for $\pm 5V$ or $\pm 5mA$ output span with 0.05% basic accuracy.
- Each analog output may be set to output any parameter or parametric deviation, with user defined offset, span, and filtering.

AIO Option Commands

Analog Command	Analog Command Action
ANALOG[n]=DEFAULT	To return the analog output (n) to the parameter's zero offset and span as specified via the front panel control, using command string.
ANALOG[n]=parameter	To set the output level to one determined from the value of the passed parameter.
ANALOG[n]=range/zero/span	To configure the analog output (n) to the indicated range of 5V, 10V, or 5mA, and the numeric value for the parameter's zero offset and span.

ANALOG[n]=numeric	To force the analog output (n), a possible 0 to 11, to the specified output level, 1.0 to + 1.0, which yields an output level between fullscale and + fullscale.
--------------------------	--

Upper-case portions = command operator / lower case portions = optional parameter(s).

Appendix B: Specifications

Unless otherwise indicated, all accuracy specifications given in this chapter are valid throughout the specified operating temperature range, for a period of 1 year, following a 30 minute warm-up period, and are relative to routinely performed Calibration Standards. Throughout this section, F = frequency, F_C = Filter corner frequency, or 500kHz (whichever is lower). Accuracy specifications are valid for frequencies $< F_C / 2.5$.

Voltage Input

Ranges:	700V, 200V, 65V, 20V, 6V, 2.5V, 750mV, 200mV, 70mV, 20mV and 6mV RMS, autoranging or fixed [2.5V maximum when V(50) mode selected].
Frequency Range:	0.0005Hz to 200kHz.
Amplitude Accuracy:	DC: 0.05% of input + 0.1% of range + 50 μ V. AC: (0.05 + 2F/FC)% of input + 0.03% of range + 20 μ V Option HA (AC): (0.035 + 2F/FC)% of input + 0.015% of range + 20 μ V Unfiltered (AC): Add 0.05% of range + 300 μ V.
Minimum Input:	Filtered: 1% of range + 60 μ V. Unfiltered: 10% of range + 600 μ V.
Max. Measurable Peak:	>1.5 times range [i.e., Crest Factors up to 150 (filtered) or 15 (unfiltered)].
Protection:	2000V peak (10V peak when V(50) mode selected).
Input Impedance:	600K Ω 5pF from each voltage terminal to guard terminal. 50 Ω \pm 0.05% between input terminals when V(50) mode selected. Voltage Lo (BNC outer shell) connected to Guard via 100 Ω when Internal Guard selected.
Isolation:	1000M Ω 200pF to chassis ground, 2000V peak max., <2500V/ μ S.
DC Withstand:	400V DC maximum when V(ac) mode selected.

Input Time Constant: 300mS \pm 2% when V(ac) mode selected.

Overall CMRR: >160dB at F<100Hz: 20dB/decade.

CMRR (Input:Guard): >80dB at F<1kHz: 20dB/decade.

Current Input

Ranges: 750mA, 250mA, 75mA, 25mA, 7.5mA, 2mA, 0.6mA Arms, autoranging or fixed.

Frequency Range: 0.0005Hz to 200kHz.

Amplitude Accuracy: DC: 0.05% of input + 0.1% of range + 5 μ A.
AC: (0.05 + 2F/F_C)% of input + 0.03% of range + 2 μ A.
Option HA (AC): (0.035 + 2F/F_C)% of input + 0.015% of range + 2 μ A.
Unfiltered (AC): Add 0.05% of range + 30 μ A.

Minimum Input: Filtered: 1% of range + 6 μ A.
Unfiltered: 10% of range + 60 μ A.

Max. Measurable Peak: >1.5 times range.

Protection: Protected up to 5A peak (2.5Arms) on any range.

Burden: <3.5 Ω (below 75mA range), <0.2 Ω (75mA range and above).

Isolation: 1000M Ω ||200pF to chassis ground, 2000V peak max., <2500V/ μ S.

CMRR: 75mA range and higher: <1 μ A/Volt @ F \leq 100Hz, +20dB/decade
Below 75mA range: <50nA/Volt @ F \leq 100Hz, +20dB/decade

Input Filtering

Low Pass Filters: None or any 3dB corner frequency between 4.88Hz and 240kHz.

Attenuation: >40dB at twice FC.

Phase

Frequency Range: 0.0005Hz to 150kHz.

A:B, C:D or E:S: Standard: (0.04 + 3F/ F_C) times harmonic number.
Option HA: (0.02 + 2F/ F_C) times harmonic number.

Any other input pair: Standard: (0.1 + 3F/ F_C + 3F/ 500kHz) times harmonic number.
Option HA: (0.05 + 2F/ F_C + 2F/ 500kHz) times harmonic number.

Mode Effect:	Add $(0.04 + 5F/F_C)^\circ$ for voltage: current phase.
Ranging Effect:	Add $(0.02 + 3F/F_C)^\circ$ per range difference between inputs.

Fundamental Frequency Measurement

Accuracy:	$0.01\% + (0.03\% \text{ divided by measurement period in seconds}).$
Min. Fundamental:	5% of range.
Frequency Range:	0.0005Hz to 200kHz.
Technique:	Period measurement of filtered signal using a “tracking” bandpass filter having a bandwidth of 0.8 to 1.2 times the measured fundamental frequency.
Harmonic Rejection:	Detects fundamental component having an amplitude down to 30% of total signal.
Measurement Filter:	Optional “moving average” filtering may be applied.
Response Time:	<1.5 measurement periods.

Harmonic Analysis

Normal Analysis:	User definable window period between 1 and 512 fundamental cycle periods, using rectangular window with no overlap and with no gaps for fundamental frequencies <100Hz. Automatically sized (256 to 4096 point) Fast Fourier Transform with average sampling frequency maintained within 10ppm of relevant ratio from the fundamental frequency.
Windowed Analysis:	User definable window period between 8 and 512 fundamental cycle periods, using a modified Blackman-Harris window with no overlap and with no gaps for fundamental frequencies <100Hz. Automatically sized (256 to 4096 point) Fast Fourier Transform with sampling frequency maintained within 10ppm of relevant ratio from the fundamental frequency.
Frequency Range:	0.0005Hz to 150kHz, up to 2047th harmonic.
Abs. Single Harmonic:	$(0.05 + 2F/F_C) \%$ of reading + 0.01% of range + $(2F/F_C) \%$ of total signal. F is the frequency of the harmonic.
Abs. Harmonic Range:	$(0.05 + 2F/F_C) \%$ of reading + (0.01% of range + $(2F/F_C) \%$ of total signal) $\cdot \sqrt{\text{number harmonics}}$. F is the frequency of the fundamental.
THD Accuracy:	$(0.01 + 2F/F_C) \%$. $(\text{range} / \text{total signal level}) \cdot \sqrt{\text{number harmonics}}$. F is the frequency of the fundamental.

Peak Parameters

Min. Impulse Width:	Repetitive:	500nS, >100 impulses / measurement.
	Single:	4 μ S
Accuracy:	As relevant input accuracy specifications at the frequency of the impulse (use 1/impulse period if unknown). Valid for impulse frequency < F _C .	

Date and Time

Accuracy:	0.005%
-----------	--------

General

Power:	105 to 130V or 210 to 260V (auto-selected) RMS AC 50/60Hz @ 125VA.
Size:	17" wide by 7" high by 14" deep.
Weight:	20lbs. in use, 30lbs. (13.5kg) shipping.
Operating Range:	0°C to 50°C, less than 85% RH @ 40°C (non-condensing).
Storage Range:	-30°C to +65°C, less than 95% RH @ 40°C (non-condensing).