

# IntelliDoX™

## Docking Module

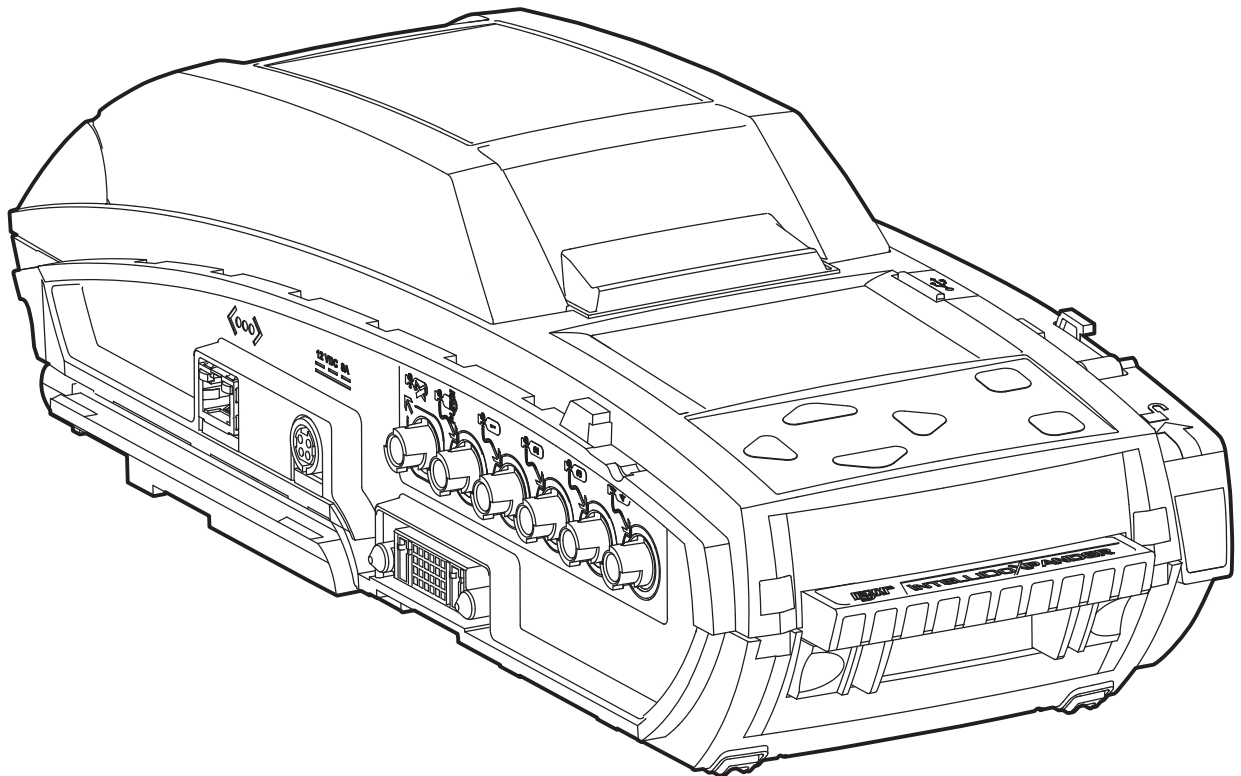

# User Manual

50104991-168 EN-C5

## Table of Contents

---

Table of Contents .....	1
<b>About this Publication .....</b>	<b>3</b>
<b>Important Safety Information: Read First .....</b>	<b>4</b>
<b>Getting Started .....</b>	<b>5</b>
About the IntelliDoX Docking Module .....	6
What's in the Box .....	7
IntelliDoX at a Glance .....	8
Inlet Keys .....	9
LCD Screen .....	11
Keypad .....	12
<b>Assemble Modules .....</b>	<b>13</b>
Work Plan: Assemble Individual Modules .....	14
Work Plan: Assemble Gangs of up to Five Connected Modules .....	15
Assemble the Stand .....	16
Connect Modules .....	17
Mount on a Wall .....	18
Mount on Parallel DIN Rails .....	22
<b>Prepare Modules for Use .....</b>	<b>25</b>
Attach the End Plate .....	26
Connect the Exhaust Tubing .....	27
Connect the Inlet filter .....	28
Insert the Inlet Plugs .....	29
Connect the Power .....	30
Connect the Module to a Network .....	31
Connect a Calibration Gas Cylinder .....	35
<b>Dock Station Settings Menu .....</b>	<b>37</b>
Display the Adjust Dock Station Settings Menu .....	38
Adjust the LCD Brightness .....	39
Adjust Date and Time Settings .....	40
Configure Gas Inlets .....	41
Display the Select Language Menu .....	43
Display the About Summary Screen .....	44
<b>Detector Operations .....</b>	<b>45</b>
Insert a Detector .....	46
Detector Operations Menu .....	47
Bump Test .....	48
FastBump .....	50
Calibration .....	52
Transfer Datalogs from a Detector .....	55
Display the Adjust Dock Station Settings Menu .....	56
Charge a Detector .....	57
<b>Configure Settings via Fleet Manager II Software .....</b>	<b>58</b>
Protect Module Operations with a Passcode .....	59
Configure Module and Detector Settings .....	60
Adjust Time and Date Settings via Fleet Manager II Software .....	64
<b>Hibernation .....</b>	<b>67</b>
Configure Hibernation .....	68
<b>Transfer Data Files .....</b>	<b>73</b>
Transfer Data Files from the Module .....	74

<b>Update Firmware .....</b>	<b>76</b>
Update Module Firmware.....	77
Update Detector Firmware.....	80
<b>Replace Detector Cradle and Calibration Insert .....</b>	<b>83</b>
Replace the Detector Cradle.....	85
Replace the Calibration Insert.....	87
<b>Maintenance .....</b>	<b>89</b>
Clean and Maintain the Module .....	90
Calibration Equipment and Gases .....	91
<b>Technical Specification and Warranty .....</b>	<b>92</b>
Technical Specification .....	93
Limited Warranty and Limitation Liability.....	95
<b>Troubleshooting.....</b>	<b>96</b>
Compliance Tests .....	97
Detectors .....	99
Modules .....	100
Network Connections.....	103
Calibration of PID Sensor .....	104
<b>Safety Suite Device Configurator Software .....</b>	<b>105</b>
Connect an IntelliDoX to the Safety Suite Device Configurator .....	106
Adjust the Time and Date .....	107
Set the Time Zone .....	108
Transfer data files .....	109
Download data from a file .....	110
Update the Firmware .....	111
<b>Glossary.....</b>	<b>114</b>
<b>Contact us .....</b>	<b>117</b>

## About this Publication

**IntelliDoX® Docking Module Operator Manual**  
**50104991-168 || OM-EN-FMSU-C1**  
**© 2015-2018 Honeywell. All rights reserved.**

The IntelliDoX Docking Module is designed to support multiple detectors manufactured by Honeywell. As a result, certain procedures, features and options described in this manual may not be supported by most of the compatible detector models. To understand which procedures, features and options are supported, refer to the appropriate detector operator manual.

Ensure that you are familiar with the use of personal gas detection devices and accessories, and take appropriate action in the event of an alarm condition.

While this information is presented in good faith and believed to be accurate, Honeywell disclaims the implied warranties of merchantability and fitness for a particular purpose and makes no express warranties except as may be expressly stated in its written agreement with and for its customers. In no event is Honeywell liable to anyone for any indirect, special or consequential damages. The information and specifications in this document are subject to change without notice.

### Trademarks

Brand or product names are trademarks of their respective owners. The following brand or product names are trademarks of Honeywell:

- Fleet Manager II
- IntelliDoX

### Signal Words

This manual uses the following signal words, as defined by ANSI Z535.4-1998:

#### **⚠ DANGER**

Hazardous situation which, if not avoided, will result in death or serious injury. This symbol identifies the most extreme hazardous situations.

#### **⚠ WARNING**

Hazardous situation which, if not avoided, could result in death or serious injury.

#### **⚠ CAUTION**

Hazardous situation which, if not avoided, may result in moderate or minor injury.

#### **NOTICE**

Situations which, if not avoided, may result in property damage.

## Important Safety Information: Read First

To ensure personal safety, read all Safety Information and Warnings before using this equipment.

Use this equipment only as specified by the manufacturer. Failure to do so may impair protection provided by the equipment.

The safety and security of any system or network incorporating this equipment and its accessory components is the responsibility of the assembler of the system.

Follow all required National Electric Codes (NEC) and safety standards.

This IntelliDoX module is intended for use as a stand-alone docking module, or as a component in a connected gang of up to five IntelliDoX modules.

### **⚠WARNING**

If the equipment is damaged or parts are missing, contact Honeywell immediately.

Substitution of components may impair the safety of the equipment.

Do not attempt to disassemble, adjust, or service the equipment unless instructions are provided to perform a procedure, or a component is listed as a user-replaceable component in the user manual. Use only Honeywell replacement components.

To eliminate the risk of electrical shock, disconnect the equipment when cleaning or performing maintenance.

This equipment uses potentially harmful gas for calibrations. The equipment must be attached to a venting system or be used in a well-ventilated area.

To prevent gas leaks, the end plate must be attached and locked with the latch arm lock before connecting power supply and/or connecting gas cylinders. The end plate must remain securely latched at all times during operation.

Perform calibrations and bump tests only in a normal atmosphere (20.9% v/v O<sub>2</sub>) that is free of hazardous gas.

The maximum recommended calibration tubing length is 10 meters (33 feet). Use of tubing that is longer than the recommended length may result in inaccurate or failed compliance tests or calibrations.

The maximum recommended exhaust tubing length is 15 meters (49.5 feet).

Ensure that the inlet filter is clean.

The use of calibration gas cylinders other than those specified by Honeywell may result in unsafe calibration or possible non-recoverable failure of the equipment, and will invalidate the warranty.

Do not use calibration gas cylinders past their expiration date.

Ensure that all calibration gas cylinders are in good condition.

Ensure that all calibration gas cylinders contain enough gas.

Ensure the exhaust line is not connected to a negative pressure system.

A demand flow regulator must be used with all calibration gas cylinder connections. The module inlet should not be pressurized.

Failed tests can result if inlets are not set up correctly.

Do not expose the equipment to electrical shock or severe and/or continuous mechanical shock.

Do not immerse the equipment in liquids.

### **⚠CAUTION**

Products may contain materials that are regulated for transportation under domestic and international dangerous goods regulations. Return product in compliance with appropriate dangerous goods regulations. Contact freight carrier for further instructions.

### **NOTICE**

To prevent the corruption or loss of data and/or software and/or firmware, do not deactivate the equipment while performing datalog transfers, bump tests, calibrations or other operations.

## Getting Started

This section contains information and illustrations related to the module and its components. It also includes an overview of the module settings menu and general instructions for inserting a detector and using the detector operations menu on the module.

## About the IntelliDoX Docking Module

---

The IntelliDoX Docking Module ('the module') is an automatic test and calibration station for use with portable gas detectors manufactured by Honeywell. The module automatically performs essential procedures including sensor identification, bump tests, calibrations, alarm tests and data transfers. It also retains a cumulative record of detector datalogs and event logs that are transferred to and stored in onboard memory.

Modules may be used as individual, stand-alone docking stations. They may also be connected to form gangs of up to 5 modules that function independently. Connected modules share power, network and gas connections.

Modules may be connected to a network via an Ethernet cable for enhanced access to and control of administrative and maintenance tasks. Modules are compatible with Fleet Manager II software, version 4.0 or higher.

### Normal Operating Conditions

The module is designed to be safe in the following conditions:

Indoor use only;

Normal atmosphere (20.9% v/v O<sub>2</sub>) that is free of hazardous gas;

Temperature range of +50°F to +95°F (+10°C to +35°C) ; and

Relative humidity of 10% to 90% non-condensing.

If the intended operating environment does not match these criteria, Honeywell recommends that you consult a qualified professional specialist prior to installing and using any modules.

This equipment uses potentially harmful gas for calibrations. The module must be attached to a venting system or be used in a well-ventilated area.

### Parts and Accessories

Replaceable parts are sold separately. To receive a complete list of replaceable parts approved for use with this product, contact Honeywell or an authorized distributor, or visit the product website at [www.honeywellanalytics.com](http://www.honeywellanalytics.com)

Gas detectors, calibration and purge gas cylinders, and other accessories are sold separately. To receive a complete list of calibration gases and accessories approved for use with this product, contact Honeywell or an authorized distributor, or visit the product website at [www.honeywellanalytics.com](http://www.honeywellanalytics.com).

### Warranty Registration

[www.honeywellanalytics.com/support/product-registration](http://www.honeywellanalytics.com/support/product-registration)

## What's in the Box

---

### IntelliDoX Docking Module

Each IntelliDoX Docking Module package contains:

1. One module with a factory-installed nest for a compatible portable gas detector, a single-inlet key, and an attached end plate;

**NOTE:** If the end plate is not attached to the IntelliDoX docking module or is missing, contact Honeywell or an authorized distributor immediately.

One printed Quick Reference Guide;

One CD containing the module Operator Manual and Quick Reference Guide in PDF format; and

One CD containing Fleet Manager II software, v4.0 or higher.

The power supply and power cord, Ethernet cable, tubing, inlet filters and plugs, quick connect fittings, and miscellaneous other fittings are packaged separately as the IntelliDoX Enabler Kit. One Enabler Kit is required for each individual module or gang of up to 5 connected modules.

If the module is damaged or if parts are missing, contact Honeywell or an authorized distributor immediately.

### IntelliDoX Enabler Kit

You need one IntelliDoX Enabler Kit for each stand-alone IntelliDoX module or gang of up to 5 connected modules. Each Enabler Kit contains:

1. One power supply and AC power cord appropriate to shipping destination;
- One ethernet cable;
- Gas tubing, 1/8 inch I.D., 4.6 meters (15 feet);
- Quick connect fittings;
- Inlet filters and plugs;
- Connectors with attached 3/16 inch I.D. tubing for use with demand flow regulators;
- Miscellaneous connectors;
- One CD containing the IntelliDoX operator manual and the quick reference guide in PDF format; and
- One CD containing Fleet Manager II software, v4.0 or higher.

If Enabler Kit parts are damaged or missing, or if additional Enabler Kits are required, contact Honeywell or an authorized distributor immediately.

### Fleet Manager II Software

Fleet Manager II is proprietary instrument management software developed by Honeywell. You can use Fleet Manager II to:

- Configure and manage compatible docking modules and detectors;
- Update firmware for compatible docking modules and detectors;
- Configure and manage compliance tests;
- Import, manage and analyze datalogs, event logs and compliance test results; and
- Automate certain procedures and processes for compatible docking modules and detectors.

To learn more about instrument management via Fleet Manager II software, refer to the Fleet Manager II Operator Manual or visit the product website at [www.honeywellanalytics.com](http://www.honeywellanalytics.com).



# IntelliDoX at a Glance

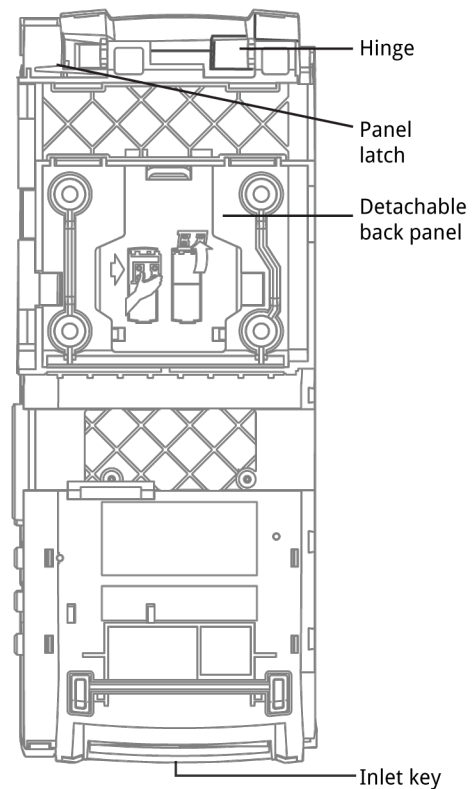
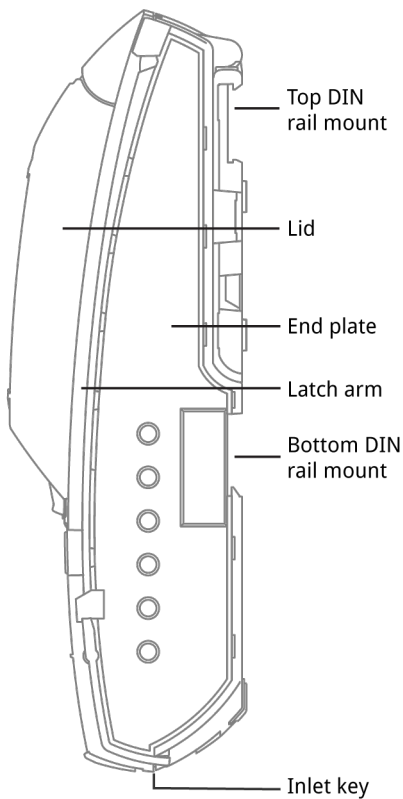
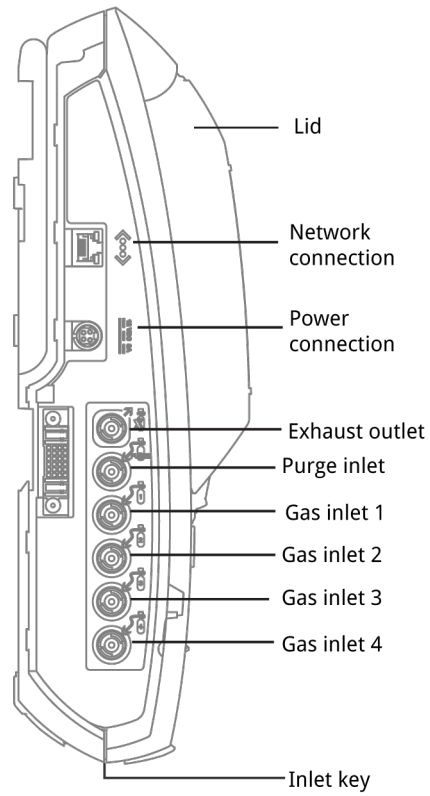
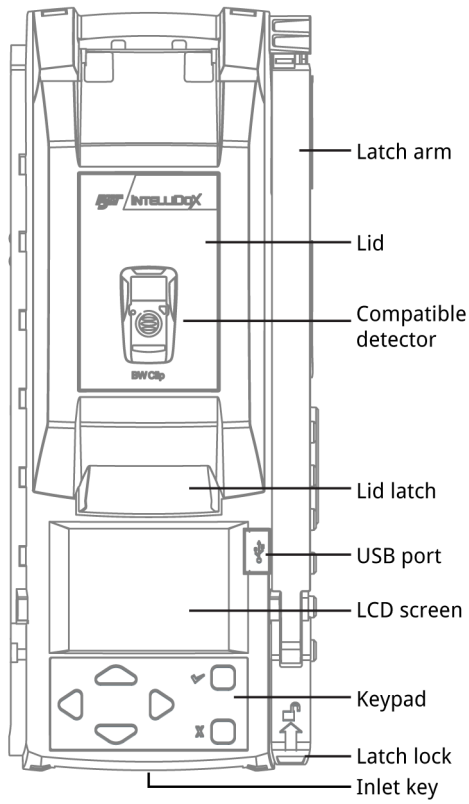

## Inlet Keys

By default, IntelliDoX is configured to connect one calibration gas cylinder to gas inlet 1. In this configuration, gas inlets 2, 3, and 4 are inactive. To connect more than one calibration gas cylinder to IntelliDoX, you must insert a multi-inlet key to activate gas inlets 1, 2, 3, and 4.

### Single-inlet Key

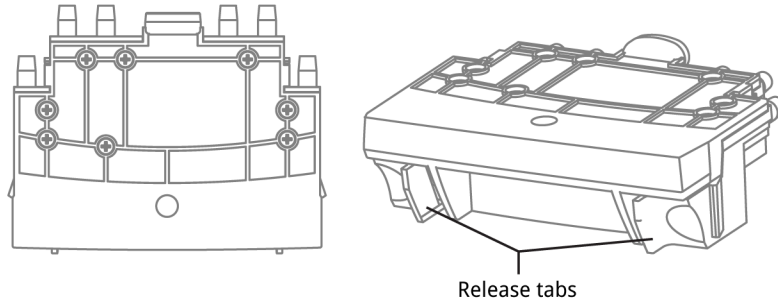

Insert the single-inlet key when only one gas inlet is required to support compliance test operations performed on the module.

When the single-inlet key is inserted into a module, gas inlet 1 is active and gas inlets 2, 3 and 4 are inactive.

### Gas Cylinder with a Single-Inlet Key

When you connect a gas cylinder to IntelliDoX with a single-inlet key, you will see one connected gas type on the LCD screen:



Single-inlet key: IntelliDoX activates gas inlet 1 and

## Multi-inlet Key

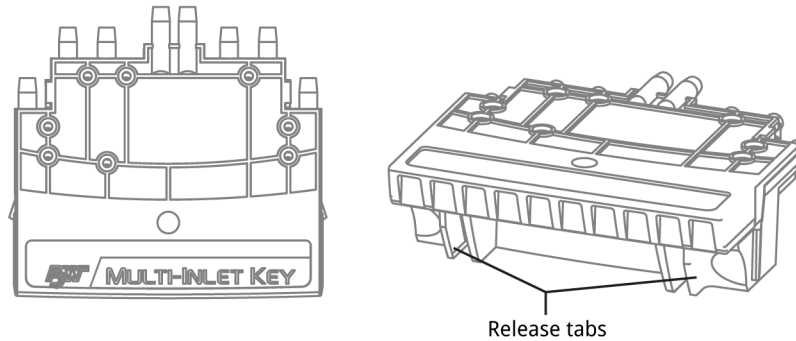

Insert the multi-inlet key when more than one gas inlet is required to support compliance test operations performed on the module.

When a multi-inlet key is inserted into a module, gas inlets 1, 2, 3 and 4 are active.

## Connected Gas Cylinders with a Multi-Inlet Key

When you connect multiple gas cylinders to IntelliDoX with a multi-inlet key, you will see multiple connected gas types on the LCD screen:



Multi-inlet key: IntelliDoX activates gas inlets 1, 2, 3,



Multi-inlet key: IntelliDoX activates gas inlets 1, 2,

## Change an Inlet Key

To remove the inlet key, pinch the release tabs together, and then pull the inlet key out.

To insert the inlet key, align the inlet key with the opening and push firmly.

**NOTICE** Always disconnect the power cord from the IntelliDoX before you change an inlet key.

1. Disconnect the power cord from the IntelliDoX.  
On the inserted inlet key, press the release tabs and pull to remove the inlet key.  
Insert the new inlet key into the IntelliDoX.  
Connect the power cord to the IntelliDoX.

## LCD Screen

**Bay number**  
Indicates the position of the module in a connected gang.

**Gas inlet settings**  
Gas details for available inlets are displayed.



**Status**  
Module date and time are displayed. If the module is connected to a network, the network symbol is displayed.

**Insert instructions**  
for compatible detectors.

**Messages**

## Screen Color







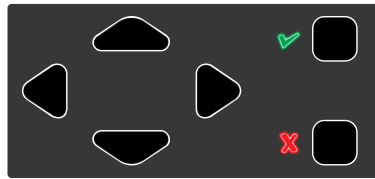

## Keypad

---



### Keypad Buttons

	Scroll right
	Scroll left
	Scroll up
	Scroll down
	Press and hold until the module settings menu is displayed. Press and release to select a menu item or save changes.
	Press and hold until an operation is cancelled. Press and release to close a menu item or return to a previous screen or cancel changes.

## Assemble Modules

This section contains work plans and instructions for assembling and installing individual modules and gangs of up to five modules.

## Work Plan: Assemble Individual Modules

---

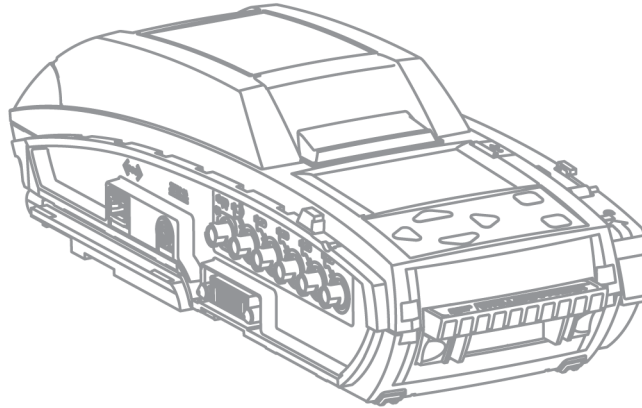

Follow these steps to assemble and prepare an individual module for first-time use:

1. Place the module and component parts on a clean, dry work surface. Verify that the appropriate inlet key is inserted. Replace the inlet key if necessary. For more information, see **Inlet Keys** on page 9.

Assemble the stand, or mount the module on a wall or DIN rail. For more information see:

- a. **Assemble the Stand** on page 16
- b. **Mount on a Wall** on page 18.
- c. **Mount on Parallel DIN Rails** on page 22.

Prepare the module for use. For more information, see **Prepare Modules for Use** on page 25.

- a. Attach the end plate. For more information, see **Attach the End Plate** on page 26.
- b. Connect an inlet filter to the purge inlet. For more information, see **Connect the Inlet filter** on page 28.
- c. Insert an inlet plug into each unused inlet. For more information, see **Insert the Inlet Plugs** on page 29.
- d. Connect the exhaust tubing. For more information, see **Connect the Exhaust Tubing** on page 27.
- e. Connect the power. For more information, see **Connect the Power** on page 30.
- f. Connect to a network. See **Connect the Module to a Network** on page 31.

Connect the calibration gas cylinder or cylinders, and then configure the gas inlets. For more information, see **Configure Gas Inlets** on page 41.

## Work Plan: Assemble Gangs of up to Five Connected Modules

---

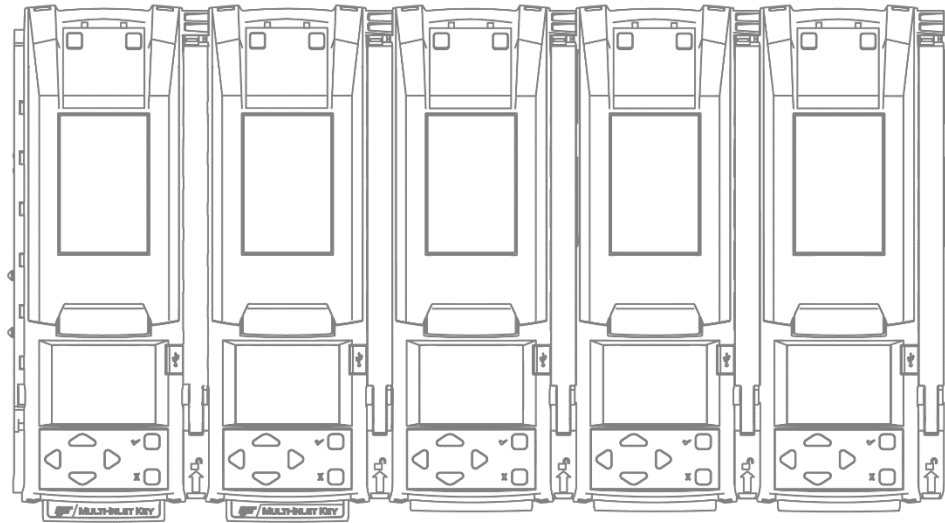

Up to five modules may be connected to form a gang. Connected modules share the power supply, exhaust tubing, inlet filter, connected test gas cylinders and network connection. Follow these steps to assemble and prepare gangs of up to five connected modules for first use:

1. Place the modules and component parts on a clean, dry work surface.

Verify that the appropriate inlet keys are inserted. Replace the inlet keys if necessary. For more information, see **Inlet Keys** on page 9.

Assemble the stand or mount the module on a wall or DIN rail if necessary. For more information, see:

- **Assemble the Stand** on page 16.
- **Mount on a Wall** on page 18.
- **Mount on Parallel DIN Rails** on page 22.

Connect up to 5 modules. For more information, see:

- **Connecting Modules** on page 17.
- **Mounting Connected Modules on a Wall** on page 20.

Prepare the connected modules for use. For more information, see **Prepare Modules for Use** on page 25.

- a. Attach the end plate to the last module in the gang. See **Attach the End Plate** on page 26.
- b. Connect an inlet filter to the purge inlet on the first module in the gang. For more information, see **Connect the Inlet filter** on page 28.
- c. Insert an inlet plug into each unused inlet on the first module in the gang. For more information, see **Insert the Inlet Plugs** on page 29.
- d. Connect the exhaust tubing to the first module in the gang. For more information, see **Connect the Exhaust Tubing** on page 27.
- e. Connect the power to the first module in the gang.
- f. Connect to a network. See **Connect the Module to a Network** on page 31.

Connect the calibration gas cylinder or cylinders, and then configure the gas inlets. For more information, see **Connect a Calibration Gas Cylinder** on page 35 and **Configure Gas Inlets** on page 41.



## Assemble the Stand

---

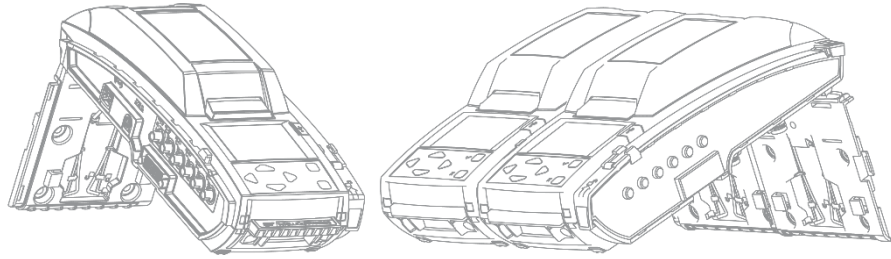

The back panel of the module can be used as a stand to support an individual module or gang of up to five connected modules at an angle that is suitable for normal use.

### **⚠WARNING**

Do not use the stand if parts are missing or damaged. Do not attempt to repair or replace any parts of the stand. If the plate is damaged or missing, contact Honeywell or an authorized distributor.

The equipment must be used only in a normal atmosphere (20.9% v/v O<sub>2</sub>) that is free of hazardous gas. Do not use the equipment in a hazardous area. Failure to adhere to this caution can lead to fire and/or explosion.

Do not install near heat sources or on vibrating surfaces.

The equipment is intended for indoor use only.

## Assembling the Stand

1. Disconnect the power cord, network cable, tubing and inlet filter assemblies.

Detach the back panel.

- a. Hold the module with the back panel facing toward you.
- b. Find the panel latch at the top left side of the module, near the panel hinge.
- c. Press down firmly on the panel latch, and then continue to press down while you slide the panel to the right until the hinge pins are detached.

Pinch the arms of the metal brace together to release the ends. If the metal brace is damaged or missing, contact Honeywell or an authorized distributor.

Attach the back panel at the hinged joint. Align the hinges on the module with the hinge pins on the back panel. Firmly push the back panel to the left to lock the hinge pins into place.

Pinch the arms of the metal brace together and insert into the brace receptacle on the back of the module.

Prepare the module for use.

- a. Attach the end plate. Verify that the latch arm is lowered and locked.
- b. Connect the inlet filters, tubing, network connection and power cord.

## Connect Modules

---

Up to 5 modules may be connected to form a gang. Connected modules share a power supply, network connection, exhaust tubing, inlet filter assemblies, and connected calibration gas cylinders.

### Connecting Modules

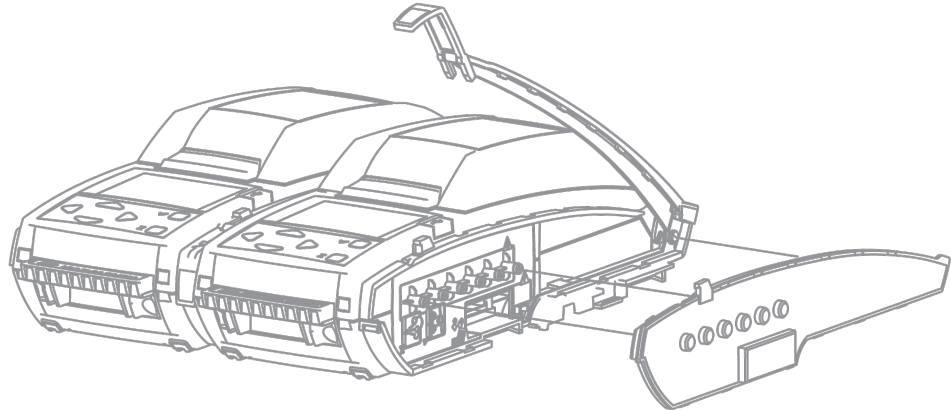

1. Assemble the stand for each module you plan to connect. For more information, see **Assemble the Stand** on page 16.

Connect two modules.

- a. Unlock and raise the latch arm on the first module. If an end plate is attached, remove it.
  - b. Align the connection port, outlets and stand on the first module with the connection port, inlets and stand on the second module.
  - c. Push the modules firmly together to connect. Verify that the stands are connected, and then lower and lock the latch arm on the first module.
2. Unlock and raise the latch arm on the last connected module, and then connect another module. Repeat as necessary to connect up to a maximum of five modules in one gang.
  3. Prepare connected modules for use.
    - a. Verify that connected modules are firmly attached and latch arms are lowered and locked.
    - b. Attach the end plate to the last module in the gang. Verify that the latch arm is lowered and locked.
    - c. Connect the inlet filters, tubing, network connection and power cord.
    - d. Verify that each module in the gang is activated and a consecutive bay number is displayed on the LCD. See **LCD Screen** on page 11.

### Disconnecting Modules

1. Disconnect the power.
  - a. Unlock and raise the latch arm between two modules.
  - b. Holding one unit in each hand, gently pull the modules apart.
  - c. Repeat as necessary until all modules in the gang are disconnected.

## Mount on a Wall

---

You can use the back panel to mount the module securely to a wall. Because wall materials vary, mounting hardware is not provided. Honeywell strongly recommends that wall-mounting is performed by a qualified installation contractor. Sufficient expertise is required to:

1. Determine the strength of the wall supporting the module; and  
Select mounting hardware appropriate to the weight and normal use of the module.

### Before you Begin

1. Select a suitable installation location. Each module or gang of connected modules requires:
  - Access to an appropriate power source.
  - Access to a network connection, if using.
  - Access to calibration gas sources.
  - Adequate clearance for the power cord, cables and tubing.
  - Adequate clearance for normal use, maintenance and cleaning.

Have ready appropriate mounting hardware. Each module requires sufficient hardware for 4 anchor points.

Have ready tools and accessories required to install the mounting hardware.

### **⚠WARNING**

Incomplete or improper mounting may result in property damage and/or personal injury.

Do not install near heat sources or on vibrating surfaces.

The wall and the mounting hardware must be strong enough to support the equipment during normal use.

The equipment must be used only in a normal atmosphere (20.9% v/v O<sub>2</sub>) that is free of hazardous gas. Do not use the equipment in a hazardous area. Failure to adhere to this caution can lead to fire and/or explosion.

The equipment is intended for indoor use only.

This equipment uses potentially harmful gas for calibrations. The equipment must be attached to a venting system or be used in a well-ventilated area.

## Mounting Individual Modules on a Wall

1. Prepare the modules for mounting.
    - a. Disconnect modules that are connected into gangs.
    - b. Disconnect the power cord, network cable, tubing and inlet filter assemblies.
    - c. Remove the end plate.
  2. Detach the back panel.
    - a. Hold the module with the back panel facing toward you.
    - b. Find the panel latch at the top left side of the module, near the panel hinge.
    - c. Press down firmly on the panel latch, and then continue to press down while you slide the panel to the right until the hinge pins are detached.
  3. Mark the position of the anchor points on the wall, and then drill the holes.
    - a. Hold the panel against the wall in the desired position.
    - b. Use a pencil or non-permanent marker to mark the center of the 4 anchor points, and then set the back panel aside.
    - c. Drill through the center of each anchor point mark.
  4. Secure the panel to the wall with the metal brace facing out. Use appropriate hardware for each of the 4 anchor points. Do not overtighten.
- Attach the module to the mounted back panel.
- a. Align the hinges and hook receptacles on the module with the hinge pins and hooks on the mounted panel.
  - b. When the module lies flat against the mounted panel, push it firmly to the left to lock it onto the panel.
5. Prepare the module for use. For more information, see **Prepare Modules for Use** on page 25.
    - a. Attach the end plate. Verify that the latch arm is lowered and locked.
    - b. Connect the inlet filters, tubing, network connection and power cord.

## Removing an Individual Module from a Mounted Back Panel

1. Disconnect the power cord, network cable, tubing and inlet filter assemblies.
2. Find the panel latch at the top right side of the module, near the panel hinge.
3. Press down firmly on the panel latch, and then continue to press down while you push the module to the right until the hinge pins and hooks are detached. Remove the module.

## Mounting Connected Modules on a Wall

1. Prepare the modules for mounting.
  - c. Disconnect modules that are connected into gangs.
  - d. Disconnect the power cord, network cable, tubing and inlet filter assemblies.
  - e. Remove the end plate.
2. Detach the back panel from the modules.
  - a. Hold the module with the back panel facing toward you.
  - b. Find the panel latch at the top left side of the module, near the panel hinge
  - c. Press down firmly on the panel latch, and then continue to press down while you slide the panel to the right until the hinge pins are detached.
3. Mark the position of the anchor points, and drill holes for the first panel.
  - a. Hold the panel against the wall in the desired position.
  - b. Use a pencil or non-permanent marker to mark the center of the 4 anchor points, and then set the back panel aside.
4. Drill through the center of each anchor point mark.

Secure the first panel to the wall with the metal brace facing out. Use appropriate hardware for each of the 4 anchor points. Do not overtighten.

Clip the second panel to the first panel, and then secure it to the wall. Use appropriate hardware for each of the 4 anchor points. Do not overtighten. Repeat as necessary to mount up to 5 connected panels.
5. Attach a module to the first panel.
  - a. Align the hinges on the module with the hinge pins on the mounted panel. Align the hooks on the mounted panel with the hook receptacles on the module.
  - b. When the module lies flat against the mounted panel, firmly push to the left to lock onto the panel. If this is difficult, loosen the mounting hardware slightly and try again.
6. Attach a module to the second panel and connect it to the first module.
  - a. Unlock and raise the latch arm on the first module.
  - b. Align the hinges on the next module with the hinge pins on the next mounted panel. Align the hooks on the next mounted panel with the hook receptacles on the next module. Align the connections on the modules.
  - c. When the next module lies flat against the next mounted panel, firmly push to the left to lock it onto the panel and ensure a full connection with the first module.
  - d. Lower and lock the latch arm. Repeat as necessary to attach and connect up to 5 modules.
7. Prepare connected modules for use.
  - f. Verify that connected modules are firmly attached and latch arms are lowered and locked.
  - g. Attach the end plate to the last module in the gang. Verify that the latch arm is lowered and locked.
  - h. Connect the inlet filters, tubing, network connection and power cord.
  - i. Verify that each module in the gang is activated and a consecutive bay number is displayed on the LCD. See **LCD Screen** on page 11.

## Removing Connected Modules from Mounted Back Panels

1. Disconnect the power cord, network cable, tubing and inlet filter assemblies.
2. Unlock and lift the latch arm between the two modules at the end of the gang.
3. Find the panel latch at the top right side of the module at the end of the gang.
4. Press down firmly on the panel latch, and then continue to press down while you push the module to the right until the hinge pins and hooks are detached. For best results, Honeywell recommends that you hold the remainder of the gang firmly in position while pushing to help protect the remaining modules in the gang from excessive movement or falls.
5. Repeat steps 2, 3 and 4 until only one module remains.
6. Repeat steps 3 and 4 to remove the final module.

## Mount on Parallel DIN Rails

---

The module is designed for installation on two parallel top hat DIN rails that are 35 millimeters by 7.5 millimeters, as per EN Standard 50022. Honeywell strongly recommends that mounting is performed by a qualified installation contractor. Sufficient expertise is required to:

1. Determine the strength of the wall supporting the module; and
2. Select DIN rails and mounting hardware appropriate to the weight and normal use of the total number of mounted modules.

### What is a DIN Rail?

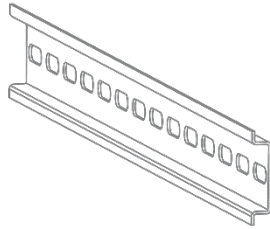

A DIN rail is a metal strip that is used to mount industrial equipment. DIN rail can be cut to suit specific applications. Multiple rows of DIN rail can be used. The module is designed for installation on two parallel top hat DIN rails that are 35 millimeters by 7.5 millimeters, as per EN Standard 50022.

### Before You Begin

1. Select a suitable installation location. Each module or gang of connected modules requires:
  - Access to an appropriate power source.
  - Access to a network connection, if using.
  - Access to calibration gas sources.
  - Adequate clearance for the power cord, cables and tubing.
  - Adequate clearance for normal use, maintenance and cleaning.

Install two parallel top hat DIN rails that are 35 millimeters by 7.5 millimeters. Use DIN rails that are appropriate for the combined weight and normal use of the total number of mounted modules. Space the DIN rails 15.2 centimeters (6 inches) apart on center. Honeywell strongly recommends using a DIN rail end plate when mounting in a vehicle, or when lateral motion is possible, or when attaching the first module in a ganged system. If a DIN rail end plate is not available, use the anchor holes in the back panel to secure the module to the wall.

### **⚠WARNING**

Incomplete or improper mounting may result in property damage and/or personal injury.

Do not install near heat sources or on vibrating surfaces.

The wall and the mounting hardware must be strong enough to support the equipment during normal use.

The equipment must be used only in a normal atmosphere (20.9% v/v O<sub>2</sub>) that is free of hazardous gas. Do not use the equipment in a hazardous area. Failure to adhere to this caution can lead to fire and/or explosion.

The equipment is intended for indoor use only.

## Mounting Modules on Parallel DIN Rails

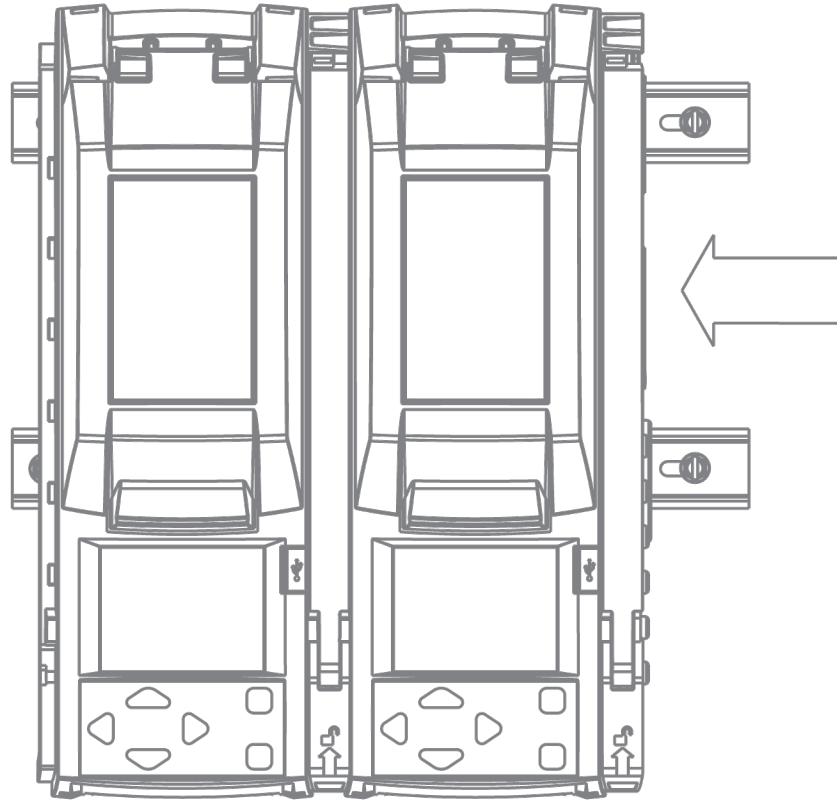

1. Prepare the modules for mounting.
  - a. Disconnect modules that are connected into gangs.
  - b. Disconnect the power cord, network cable, tubing and inlet filter assemblies.
  - c. Remove the end plate.
2. Attach a module to the DIN rails. Repeat as necessary until all modules attached.
  - a. Hold the module upright with the back panel toward the DIN rails. Place the top DIN mount over the top of the upper DIN rail and then lower the module toward the lower DIN rail until it snaps into place.
  - b. Verify that the module is firmly attached to both the upper DIN rail and the lower DIN rail.
3. Connect the attached modules into gangs of up to 5, if using. Repeat as necessary until all gangs are connected.
  - a. Snap the first module into position on the DIN rail, and then unlock and raise the latch arm.
  - b. Snap the second module onto the DIN rail, and then slide it into position beside the first module. Push the modules firmly together and then lower and lock the latch arm.
  - c. Repeat as necessary until the gang is complete.
4. Prepare the module for use. For more information, see **Prepare Modules for Use** on page 25.
  - a. Attach the end plate. Verify that the latch arm is lowered and locked.
  - b. Connect the inlet filters, tubing, network connection and power cord.



## Removing an Individual Module from Parallel DIN Rails

1. Disconnect the power cord, network cable, tubing and inlet filter assemblies.

Remove the end plate.

Find the DIN mount lock on the lower right side of the module.

Hold the DIN mount lock down, and then tilt the module away from the lower DIN rail until the lower DIN mount is released. Release the DIN mount lock and remove the module from the upper DIN rail.

## Removing Connected Modules from Parallel DIN Rails

1. Disconnect the power cord, network cable, tubing and inlet filter assemblies.

Remove the end plate.

Lift the latch arm between connected modules at the end of the gang.

Find the DIN mount lock on the lower right side of the last module. Hold the DIN mount lock down, and then slide the module along the DIN rails until it is separated from the gang.

Hold the DIN mount lock down, and then tilt the module away from the lower DIN rail until the lower DIN mount is released. Release the DIN mount lock and remove the module from the upper DIN rail.

Repeat steps 3, 4 and 5 until only one module remains.

Repeat steps 3 and 4 to remove the final module.

## Prepare Modules for Use

This section contains instructions and information related to preparing modules for use. The following topics are included.

## Attach the End Plate

---

The end plate must be attached and locked with the latch arm before connecting power supply or connecting gas cylinders. The end plate must remain securely latched at all times during operation. If the end plate is detached during operation, disconnect power and replace the end plate immediately. Abnormal performance may occur when the end plate is detached or removed.

### **⚠CAUTION**

Failure to comply may result in incorrect or failed compliance tests or calibrations.

### Attaching the End Plate

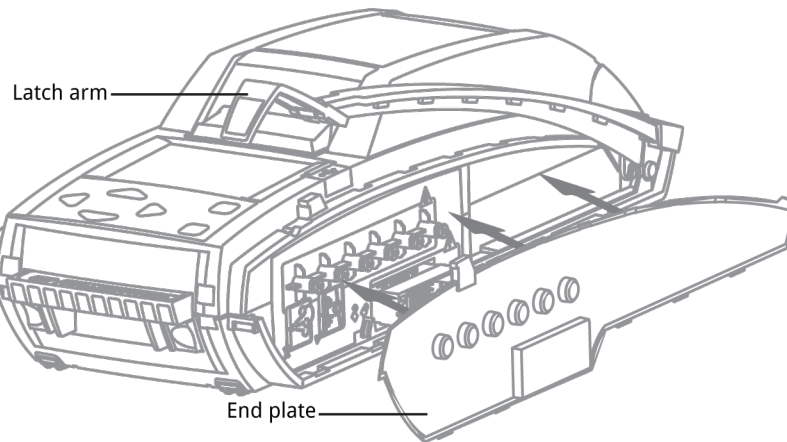

1. Unlock and raise the latch arm.
2. Attach the end plate. Verify that the end plate is firmly attached and set flush with the edge of the module.
3. Lower and lock the latch arm.

### Removing the End Plate

1. Unlock and raise the latch arm.  
Remove the end plate.

## Connect the Exhaust Tubing

---

Each IntelliDoX Enabler Kit includes tubing that may be cut to a length that is appropriate for the exhaust inlet.

### **⚠WARNING**

The maximum recommended exhaust tubing length is 15 meters (49.5 feet).

Ensure the exhaust line is not connected to a negative pressure system.

### Connecting the Exhaust Tubing

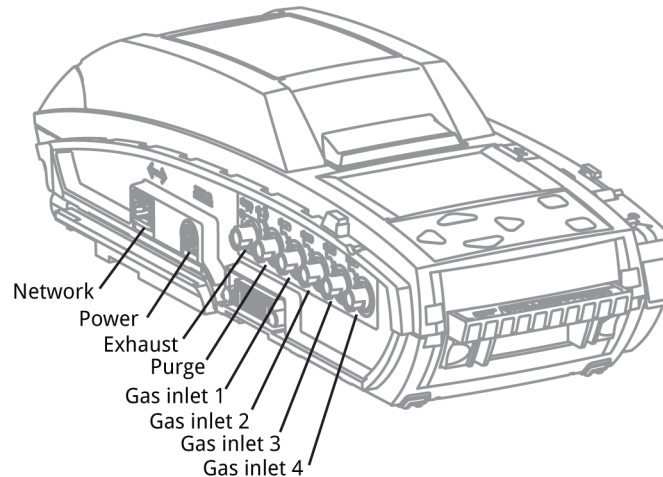

1. Inspect the tubing to ensure that it is free of obstructions and defects. Cut tubing to a length that is appropriate for exhaust, and then attach a male quick connect fitting to one end. Connect the exhaust tubing to the exhaust outlet using the quick connect fitting. Verify that the exhaust tubing is not connected to a negative pressure system, or obstructed in any way.

## Connect the Inlet filter

---

Each IntelliDoX Enabler Kit contains inlet filters. Unless otherwise specified, the purge inlet is configured to use ambient air in a fresh air environment with a normal atmosphere of 20.9% v/v O<sub>2</sub> that is free of hazardous gas. Verify that an inlet filter is attached to the purge inlet and each unused gas inlet before using the module.

Once connected, the inlet filters help to protect the module from dust ingress. For best results, replace the inlet filters periodically, or whenever the inlet filter is damaged or dirty. You may connect an extension tubing to the inlet filter to draw ambient air from an adjacent fresh air environment.

If an inlet filter is damaged, dirty, or missing, replace it immediately. For replacement parts, contact Honeywell or an authorized distributor.

### **⚠CAUTION**

Failure to comply may result in damaged equipment.

### Connecting the Inlet Filter

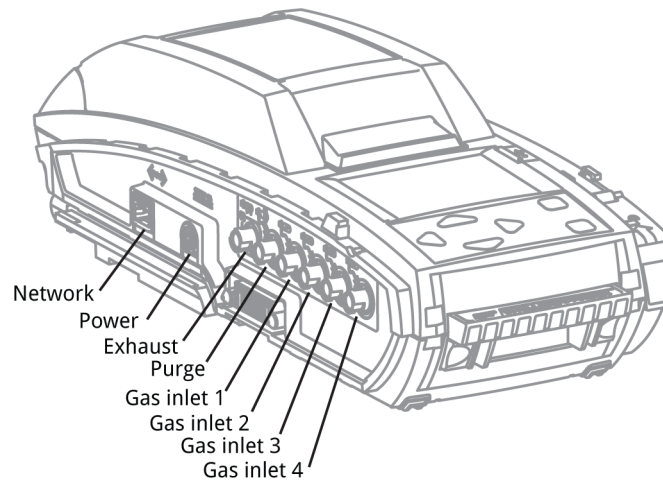

1. Verify that each inlet filter is free of obstructions and defects.

Connect an inlet filter to the purge inlet.

If necessary, connect an extension tubing to each inlet filter to draw ambient air from an adjacent fresh air environment.

## Insert the Inlet Plugs

---

Each IntelliDoX Enabler Kit contains inlet plugs. Verify that an inlet plug is inserted into each unused gas inlet before using the module. Once inserted, the inlet plugs help to protect the module from dust ingress.

If an inlet plug is damaged or missing, replace it immediately. If plugs are not available, you may use inlet filters instead. For replacement parts, contact Honeywell or an authorized distributor.

### **⚠CAUTION**

Failure to comply may result in damaged equipment.

## Connect the Power

---

Each IntelliDoX Enabler Kit contains one power supply and AC power cord. Use only the power supply provided in the Enabler Kit to connect the module to an appropriate electrical power outlet. When the power is connected, the module activates and a self-test is performed.

### Connecting the Power

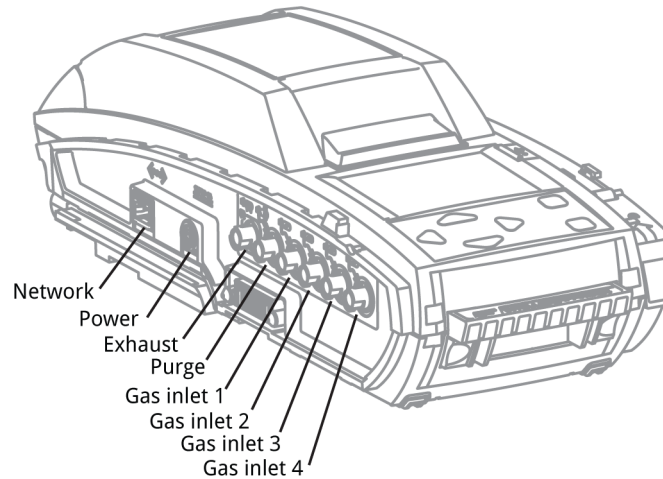

1. Verify that the power supply and power cord provided in the Enabler Kit are compatible with the local power source. If the power supply is not compatible, do not attempt to connect the module to a power source. Contact Honeywell or an authorized distributor immediately.

Connect the AC power cord to the power supply.

Connect the power supply into the power connection on the module. Press firmly until you hear a click. The click confirms that the plug is locked.

Plug the AC power cord into a suitable wall outlet.

When the power is connected, the LCD activates and a self-test is performed.

### Disconnecting the Power

To deactivate a module or gang of modules, disconnect the power supply. The module or gang of modules deactivates immediately and without warning.

1. Retract the plastic cover on the plug to unlock it. While the cover is retracted, pull the plug out of the module.

#### **⚠WARNING**

To prevent the corruption or loss of data and/or software and/or firmware, do not deactivate the equipment while performing datalog transfers, bump tests, calibrations or other operations.

## Connect the Module to a Network

Individual modules and gangs of up to 5 connected modules may be connected to a computer network via an Ethernet cable. Gangs of up to 5 modules share one network connection. Each individual or connected module requires a unique and separate IP address.

You can manage network settings through an internet browser window or via FleetManager II software. When modules are connected to a network, you may use Fleet Manager II software to update firmware, reconfigure modules and detectors, manage datalog transfers, and automate certain administrative functions.

To improve performance, Honeywell recommends that you assign a static IP address to each networked module.

To improve security, Honeywell recommends that you change the password for each networked module.

### Before you Begin

1. Verify that you have access to one active network port for each module or gang of up to 5 connected modules. Network ports are usually managed by a network administrator. For more information, contact your network administrator or Help Desk. Have ready one static IP address for each individual or connected module. Static IP addresses are usually provided by a network administrator. For more information, contact your network administrator or Help Desk. Have ready one Ethernet cable for each module or gang of up to 5 connected modules. Verify that the power supply is connected and the module is activated. Verify that you have access to a networked computer that is part of the same network as the module.

### Network Passcode

To prevent product tampering on IntelliDoX there is now a Network Passcode menu.

To be granted access to this menu, the user needs to first enter the Module Passcode. This UI password requirement is designed to stop unauthorized access to view or change the Network Passcode.

The default password is "000000". Once in the menu, the user will be prompted to set a 6 digit numeric password.

An example of the menu and the change passcode screen are shown below:

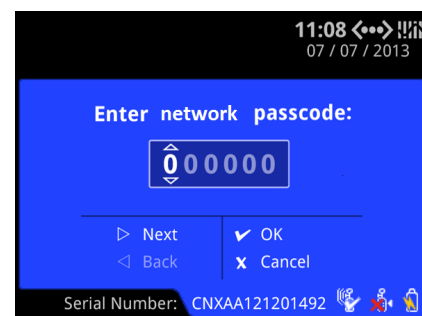
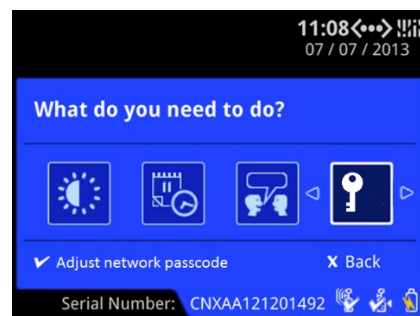



## Connecting the Module to a Network

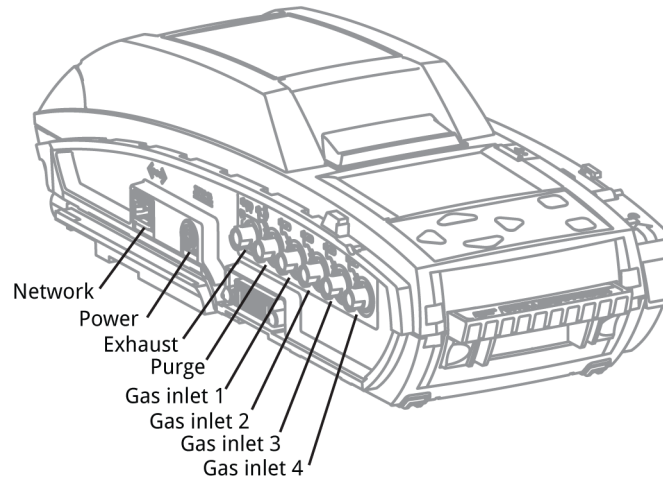

Insert one end of the Ethernet cable into the Ethernet port on the module. Insert the free end of the Ethernet cable into the network outlet. When the module is connected to the network, the network symbol is displayed at the top right corner of the LCD.

If the network symbol is not displayed within several seconds, then follow these steps:

1. Verify that the module is activated.

Verify that one end of the Ethernet cable is fully inserted into the Ethernet port on the module, and then verify that the free end is fully inserted into an active network outlet.

Press and hold until the **Adjust docking station settings** menu is displayed. Press or to scroll to **About**, and then press to display the **About** screen. If the IP address displays only zeroes, then the connection is not active.

If problems persist, contact your network administrator or Help Desk.

## Connecting IntelliDoX to Fleet Manager

Fleet Manager's versions older than FMSUMF\_08\_000 will not require a passcode to access connect to IntelliDoX.

For newer Fleet Manager versions, Fleet Manager will require entering the Network Passcode in order to add IntelliDoX. This will be a one time only process. Fleet Manager will need to send the IntelliDoX the network passcode to verify the connection.

**New IntelliDoX** ✕

IP Address:  Retrieve

Location:

Serial Number:

**Network Passcode:**

Type:  ▼

IP Mode:  ▼

Mac Address:

Firmware Version:

## Managing Network Settings through an Internet Browser

You can change network settings and the administrative password for networked modules through an internet browser. To improve performance, Honeywell recommends that you assign a static IP address to each networked module. To improve security, Honeywell recommends that you change the password for each networked module.

### Default User Name and Password for Internet Browser Access

The user name and password are case sensitive. Honeywell recommends that you change the password for each networked module.

- The default user name is **admin**.
- The default password is **admin**.

### Changing Network Settings and Password through an Internet Browser Window

1. When the module is successfully connected to a network, display the **About** summary screen, and then record the IP address for the module. To display the **About** summary screen, follow these steps:
  - a. Press and hold **✓** until the **Adjust docking station settings** menu is displayed.
  - b. Press **◀** or **▶** to scroll to **About**, and then press **✓** to display the **About** screen.

From a networked computer, open an internet browser window. In the address bar of the internet browser window, type **http://** followed by the IP address of the module. The **IntelliDoX Login** webpage is displayed in the browser window.

**BW INTELLIDOX**

Enter your user name and password to modify network parameters.

User Name :

Password :

**Current Network Parameters :**

Type of Network Configuration :

IP Address :

Subnet Mask :

Gateway :

**IntelliDoX Information :**

Hostname :

Serial Number :

Firmware Version :

Main Board Hardware Version :

Gas Module Hardware Version :

Interface Board Hardware Version :

Sensor Board Hardware Version :

Type the user name and password in the text boxes provided, and then click **Login**. The **Enter Your Network Parameters** webpage is displayed in the browser window.

Change the **Select Network Type** to **Static IP**, and then type a unique IP address. Unique IP addresses are usually provided by a network administrator or Help Desk. For more information, contact your network administrator or Help Desk.

To change the password, type the old password. Type a new password, and then type the new password again. Click **Save** to save your settings and return to the **IntelliDoX Login** webpage, or click **Cancel Changes** to abandon the changes and return to the **IntelliDoX Login** webpage.

Close the browser window, or type a different IP address in the browser address bar to change network settings for another module.

## Managing Network Settings through Fleet Manager II Software

When you log in to Fleet Manager II software as an administrative user, you can change network settings and the administrative password for networked modules. For more information, refer to the Fleet Manager II operator manual.

## Connect a Calibration Gas Cylinder

---

The IntelliDoX Enabler Kit includes tubing and quick connect fittings that are appropriate for use with calibration gas cylinders that are approved for use with this product. For best results, Honeywell recommends that the tubing is between 39 inches (1 meter) and 33 feet (10 meters) in length for calibration gas cylinders.

### Before You Begin

1. Read and understand the warnings and cautions in this section.  
Verify that you are in a normal atmosphere (20.9% v/v O<sub>2</sub>) that is free of hazardous gas.  
Verify that the end plate is attached and the latch arm is lowered and locked.  
Verify that the exhaust tubing is connected, and that it is free of defects and obstructions.

#### **⚠WARNING**

The maximum recommended calibration tubing length is 10 meters (33 feet). Use of tubing that is longer than the recommended length may result in inaccurate or failed compliance tests or calibrations.

A demand flow regulator must be used with all calibration gas cylinder connections. The module inlet should not be pressurized.

The use of calibration gas cylinders other than those specified by Honeywell may result in unsafe calibration or possible non-recoverable failure of the equipment, and will invalidate the warranty.

Do not use calibration gas cylinders past their expiration date.

Ensure that all calibration gas cylinders are in good condition.

Ensure that all calibration gas cylinders contain enough gas.

This equipment uses potentially harmful gas for calibrations. The equipment must be attached to a venting system or be used in a well-ventilated area.

## Connecting a Calibration Gas Cylinder

1. Connect a demand flow regulator to the calibration gas cylinder, and then attached the supplied connector with attached 3/16 inch (9.5 millimeter) I.D. tubing to the demand flow regulator.

Cut 1/8 inch (3.2 millimeter) I.D. tubing to an appropriate length. Honeywell recommends that the tubing is between 39 inches (1 meter) and 33 feet (10 meters) in length.

Attach one end of the 1/8 inch (3.2 millimeter) I.D. tubing to the demand flow regulator.

Insert a quick connect fitting into the free end of the tubing, and then connect it to Inlet 1 on the module.

If a multi-inlet key is inserted in an individual module or one or more connected modules in a gang, then repeat steps 1, 2, 3 and 4 as necessary until up to 4 cylinders are attached.

Configure the gas inlets before using the module. See **Configure Gas Inlets** on page 41.

## Dock Station Settings Menu

This section contains information and instructions for using the **Dock Station Settings** menu.

## Display the Adjust Dock Station Settings Menu

---

Display the **Adjust dock station settings menu** when you want to:

1. Adjust the brightness of the LCD screen;
2. Change date and time settings for the module;
3. Configure gas inlet settings for attached calibration gas cylinders; and
4. Display network and other information about the module.

### Displaying the Adjust Dock Station Settings Menu

1. Press and hold **✓** on the keypad until the **Adjust dock station settings menu** is displayed.

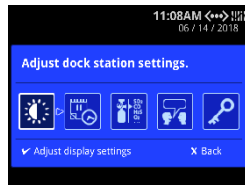

2. Press **◀** or **▶** on the keypad to select a settings option, and then press **✓** to display the option menu.

## Adjust the LCD Brightness

When you adjust and save the settings for one module in a gang, the settings for all of the modules in the gang are also changed.

### Adjusting LCD Brightness

1. Press and hold **✓** on the keypad until the **Adjust dock station settings menu** is displayed on the LCD.

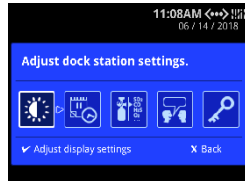

Press **◀** or **▶** on the keypad to select **Adjust dock station settings menu**, and then press **✓** to display the **Adjust dock station settings menu**.

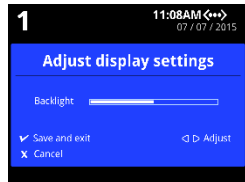

Press **◀** or **▶** to adjust the brightness of the LCD screen.

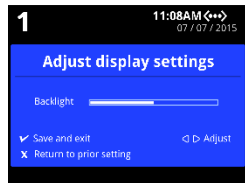

Press **✓** to save settings and return to the **Adjust dock station settings menu**, or press **X** to return to prior settings.



## Adjust Date and Time Settings

---

Follow these instructions when you want to adjust the module time and date settings manually via the **Adjust dock station settings** menu. When you adjust and save the settings for one module in a gang, the settings for all of the modules in the gang are also changed.

### Adjusting Time and Date via the Module Settings Menu

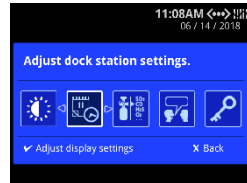

1. Press and hold **✓** on the keypad until **Adjust dock station settings** is displayed on the LCD.

Press **◀** or **▶** to select **Adjust time and date** and then press **✓**. If the procedure is passcode-protected, then enter the passcode and press **✓** to continue.

The **Adjust time and date** menu is displayed and date settings are ready to edit. Edit the date settings, or press **X** to skip to the time settings.

- a. To set the date, press **◀** or **▶** to select day, month or year, and then press **▲** or **▼** to change the value.
- b. To change the date format, press **◀** or **▶** until the date labels are selected, and then press **▲** or **▼** to change the date display to year-month-day, day-month-year, or month-day-year.

Press **✓** to save the date settings and continue, or press **X** to cancel the date changes and go to time settings. The time settings screen is displayed.

Edit the time settings, or press **X** to skip the date settings and return to the **Adjust dock station settings** menu.

- a. To set the time, press **◀** or **▶** to select a hours or minutes, and then press **▲** or **▼** to change the value.
- b. To change the time format, press **◀** or **▶** until the time format is selected, and then press **▲** or **▼** to change the clock format to 12-hour or 24-hour.

Press **✓** to save the changes and return to the **Adjust dock station settings** menu, or press **X** to cancel the time settings and return to the **Adjust dock station settings** menu.

## Configure Gas Inlets

For each attached calibration gas cylinder, you must configure the gas blend, and then configure each gas type and concentration contained in the gas blend. You may also record the lot number of the calibration gas cylinder.

If a single-inlet key is inserted in an individual module or all connected modules in a gang, then you can attach one calibration gas cylinder. If a multi-inlet key is inserted in an individual module or one or more connected modules in a gang, then you can attach up to four calibration gas cylinders. For more information, see **Inlet Keys** on page 9.

If the module is part of a gang of up to 5 connected modules, then changes to the gas inlet settings affect all of the modules in the gang. If the gang contains both single-inlet and multi-inlet key modules, then changes to Inlet 1 affect all modules and changes to Inlets 2, 3 and 4 affect the multi-inlet key modules only.

### Configuring Gas Inlets

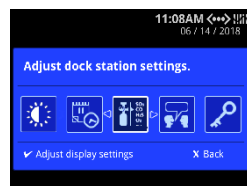

1. Press and hold **✓** on the keypad until **Adjust dock station settings** is displayed on the LCD.

Press **◀** or **▶** to select **Configure gas inlets** and then press **✓**. If the procedure is passcode-protected, then enter the passcode and press **✓** to continue.

2. The **Inlet overview** for Inlet 1 is displayed. If a multi-inlet key is inserted in an individual module or one or more connected modules in a gang, then four inlet tabs are displayed. Press **▲** or **▼** to select and configure a different inlet.

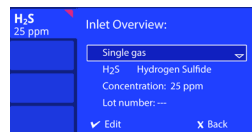

Configure the gas blend for the selected inlet.

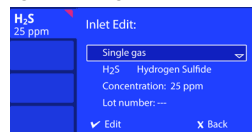

- j. Press **✓** to display the **Inlet edit** menu. **Gas blend** is highlighted.
- k. Press **✓** to select **Gas blend**, and then press **▲** or **▼** to select a single-gas blend or a multi-gas blend of 2 or more gas types. If the inlet is not connected to a gas cylinder, select **No inlet**.
- l. Press **✓** to save the changes and return to the **Inlet edit** menu, or press **✓** to abandon the changes and return to the **Inlet edit** menu.

Configure the gas type for the blend.

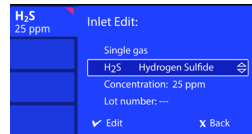

- m. To configure a gas type in a multi-gas blend, select **Gas blend** from the **Inlet edit** menu, and then press **◀** or **▶** to select one of the gases available in the blend.
- n. Select gas type from the **Inlet edit** menu, and then press **▲** or **▼** to find and select the type of gas. Verify that the gas type selected matches the type of gas contained in the calibration cylinder.
- o. Press **✓** to save the changes and return to the **Inlet edit** menu, or press **X** to abandon the changes and return to the **Inlet edit** menu.

Configure the gas concentration .

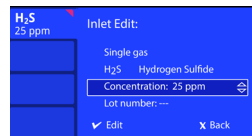

- p. Verify that the gas concentration displayed on the screen matches the gas concentration contained in the calibration gas cylinder. If the concentration does not match, select **Concentration:** from the **Inlet edit** menu, and then press **✓** to edit.
- q. Press **▲** or **▼** to configure the gas concentration.
- r. Press **✓** to save the changes and return to the **Inlet edit** menu, or press **X** to abandon the changes and return to the **Inlet edit** menu.

Record the lot number of the calibration gas cylinder.

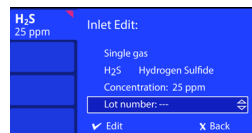

- s. Select the lot number setting from the **Inlet edit** menu.
- t. Press **✓** to edit the lot number, and then press **▲** or **▼** to find and select alphabetic, numeric and special characters. Press **◀** or **▶** to move to the next character space. Up to 14 characters may be entered.
- u. Press **✓** to save the changes and return to the **Inlet edit** menu, or press **X** to abandon the changes and return to the **Inlet edit** menu.

Repeat steps 3, 4, 5, and 7 until all of the gas inlets are configured.

Press **X** to close the **Inlet edit** menu and return to the **Inlet overview**. Press **X** again to return to **Adjust dock station settings**.

## Display the Select Language Menu

---

Use the **Select Language** menu to change the docking station's display language. You can select **English**, **French**, **German**, **Spanish**, or **Portuguese**.

1. Press and hold **✓** on the keypad until **Adjust dock station settings** is displayed on the LCD.

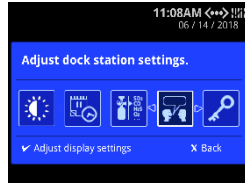

Press **◀** or **▶** on the keypad to select **Select Language**, and then press **✓** to display the **Select Language** menu.

Press **△** or **▽** to select a language.

Press **✓** to save settings and return to the **Adjust Dock Station Settings** menu, or press **X** to return to the prior settings.

## Display the About Summary Screen

---

The **About** information screen displays summary information about the module that may be helpful when you install or configure modules, such as:

1. Module serial number;
2. Versions of firmware and hardware installed on the module;
3. IP address, and
4. MAC address.

### Displaying the About Summary Screen

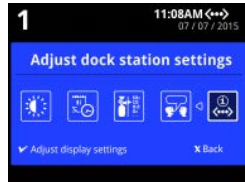

1. Press and hold **✓** on the keypad until **Adjust dock station settings** is displayed on the LCD.
2. Press **X** to return to the **Adjust dock station settings** menu.

## Detector Operations

This section contains information and instructions for inserting a detector and performing certain operations.

## Insert a Detector

---

1. Verify that the detector is compatible with the module. The detector model must match the model displayed on the module lid.

Activate the detector if necessary. If you plan to perform compliance tests, then activate the detector and verify it is in normal operating mode prior to insertion. If you plan to configure a compliant detector prior to activation or charge a rechargeable battery, then activation may not be required. For more information, refer to the appropriate detector operator manual.

Press the lid release button and lift the module lid. Insert the detector and then close the lid. **Detector identification** is displayed.

When the detector is recognized, procedures specified to occur automatically on insertion are performed. If the detector contains a rechargeable battery, battery charging begins. Progress screens may be displayed while certain procedures are performed.

After the detector is recognized and automated procedures are completed, the detector operations menu and **What do you need to do?** are displayed.

Press ◀ or ▶ on the keypad to select a menu item. Follow on-screen instructions to perform the selected procedure.

After the procedures are completed, you may leave the detector in the module for charging. If the detector is activated, the module will deactivate it after 10 minutes of inactivity and continue charging the battery. When charging is complete, remove the detector from the module.

## Detector Operations Menu

---

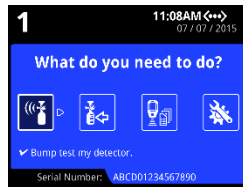

After the detector is recognized and automated procedures are completed, the detector operations menu and **What do you need to do?** are displayed.

Press ◀ or ▶ on the module keypad to select a menu item, and then follow on-screen instructions to perform the selected procedure.



## Bump Test

For optimal performance, Honeywell recommends bump testing detectors before each use. For more information, refer to the appropriate detector operator manual.

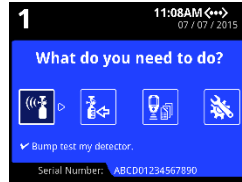

A bump test is a procedure that confirms a detector's ability to respond to target gases by exposing the detector to a known gas concentration. The module supports two types of bump test:

1. FastBump, an accelerated test that performs the bump procedure and event log transfer only; and
2. Standard Bump Test, a test that performs the bump procedure and other procedures specified to occur automatically on insertion, such as datalog transfers or firmware updates.

### Before You Begin

1. Read and understand bump test information in the appropriate detector operator manual.

Read and understand **Bump Test Guidelines** in this section.

Verify that the detector is activated.

Verify that the detector is not in a low-battery state.

Bump test only in a normal environment that is 20.9% v/v O<sub>2</sub> and free of hazardous gas.

Do not operate the docking module in a hazardous area. Failure to adhere to this guideline can result in possible personal injury and/or property damage.

### Bump Test Guidelines

1. Perform compliance tests only in a normal environment that is 20.9% v/v O<sub>2</sub> and free of hazardous gas. Do not operate the module in a hazardous area. Failure to adhere to this guideline can result in possible personal injury and/or property damage.

The use of gas cylinders other than those specified by Honeywell may result in unsafe bump tests or possible non-recoverable failure of the equipment, and will invalidate the warranty.

Do not use gas cylinders past their expiration date.

A demand flow regulator must be used with all gas cylinder connections. The module inlet should not be pressurized.

Do not bump test the detector immediately after charging is complete.

Bump test the detector if ambient gas readings vary during startup.

Allow the sensor to stabilize before starting the bump test.

- v. Used sensor: wait 60 seconds
- w. New sensor: wait 5 minutes

When bump testing the same detector multiple times, wait 10 minutes between bump tests to allow the sensors to stabilize.

## Special Considerations for IntelliDoX Ultra and BW Solo

Chlorine (CL2) is available for bump test only, span calibration is unavailable for CL2 with IntelliDoX Ultra.

- For bump tests at 40% of threshold pre-conditioning is not required for CL2/NH3
- For bump tests above 40% of threshold, it may be necessary to perform the bump test twice which will allow for pre-conditioning of the IntelliDoX system for CL2/NH3

Pre-conditioning the system means flowing the target calibration gas prior to a bump or calibration to insulate the tubing. This allows gas to flow more directly to the sensor face.

When Pre-Conditioning of the system is required please follow the procedure described below:

In an IntelliDoX the only means of flowing the gas is with a bump test or calibration. To bump test Ultra for CL2/NH3 in an IntelliDoX place unit in the dock

1. Select bump test using the IntelliDoX menu
  - Bump test once to pre-condition the system – This test will result in a fail
  - Bump test second time to test device – This test will result in a pass

## Special Considerations for the MaxXT II Detector

**Note:** Insert the MaxXT II detector in the nest after the detector has started up for bump test.

## FastBump



When IntelliDoX is set to FastBump, you see  at the top right of the LCD screen.

FastBump is an accelerated compliance test that confirms a detector's ability to respond to target gases by exposing the detector to a known gas concentration. When a compatible detector is inserted into the configured module, FastBump and event log transfers begin automatically after the detector is recognized. Other procedures specified to occur automatically on insertion are suppressed.

### What do I Need to Use FastBump?

FastBump can only be performed with a compatible detector via a module that is configured for FastBump. To determine if a FastBump is available, refer to the appropriate detector operator manual.

You must use Fleet Manager II software to configure the module to automatically FastBump a compatible detector on insertion. For more information, refer to the Fleet Manager II operator manual and the appropriate detector operator manual.

### FastBump a Detector

1. Insert a compatible detector into the module. The LCD changes to gray and **Detector identification** is displayed.

After the detector is recognized, the LCD changes to yellow and progress messages are displayed. FastBump and event log transfer begin automatically.

Testing alarms		Testing sensors	
Alarm response:	Sensor response:	Alarm response:	Sensor response:
■ Acoustic	□ CO	■ Acoustic	■ CO
■ Visual		■ Visual	

When the bump test is successful, the LCD changes to green and **Bump test passed** is displayed.

Bump test passed	
Alarm response:	Sensor response:
✓ Acoustic	✓ CO
✓ Visual	

If the bump test fails, the LCD changes to red and the **Bump test failed** message is displayed. **X** indicates failed alarm and/or sensor test.

Bump test failed	
Alarm response:	Sensor response:
✓ Acoustic	X CO
✓ Visual	

To understand how to respond appropriately to failed tests, refer to the appropriate detector operator manual.

## Standard Bump Testing

During a standard bump test, the bump procedure and other procedures configured to occur automatically on insertion are performed.

You must use Fleet Manager II software to configure the module to automatically bump test a compatible detector on insertion. When a compatible detector is inserted into the configured module, the bump test starts automatically after the detector is recognized. Progress screens are displayed while the tests are performed.

You may use Fleet Manager II software to configure the module to automatically calibrate a compatible detector after a failed bump test. When a compatible detector is inserted into the configured module and the bump test fails, then calibration starts automatically. Progress screens are displayed while the tests are performed.

1. Insert a compatible detector into the module. The LCD changes to gray and **Detector identification** is displayed.

When the module is configured to perform a standard bump test and other procedures on insertion, the LCD changes to yellow and **Testing Alarms** is displayed after the detector is recognized. Go to step 6.

When the module is NOT configured to perform bump test or other procedures on insertion, **What do you need to do?** is displayed after the detector is recognized. Go to step 4.

Press **←** or **→** to select **Bump test my detector**. If the procedure is passcode-protected, then enter the passcode and press **✓** to continue. Press **✓** to continue.

The LCD changes to yellow and the standard bump test begins. Progress screens are displayed while the test procedures are performed.



When the bump test is successful, the LCD changes to green and **Bump test passed** is displayed. If the module is configured to automatically download datalogs, then the detector datalogs are transferred to the module after the test is complete.

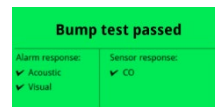

Press **✓** to return to the **What do you need to do?** menu.

If the bump test fails, the LCD changes to red and the **Bump test failed** message is displayed. **X** indicates failed alarm and/or sensor test.

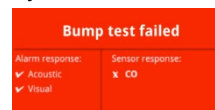

If the module is configured to automatically calibrate the detector when a bump test fails, then the calibration procedure begins. To understand how to respond appropriately to failed tests, refer to the detector operator manual.

## Calibration

---

### NOTICE

Remove detector before reconfiguring inlets for different calibration gas or concentration.



Calibration is a two-step procedure that determines the measurement scale for the detector's response to gas. In the first step, a baseline reading is taken in a clean, uncontaminated environment. In the second step, the sensors are exposed to known concentrations of gas. The detector uses the baseline and known gas concentrations to determine the measurement scale.

Over time and through use, sensor performance may drift from the manufacturer's baseline. For optimal performance, Honeywell may recommend calibration for certain detector models. To confirm that calibration is recommended, refer to the appropriate detector operator manual.

### Before You Begin

1. Verify that calibration is recommended for the detector. Refer to the appropriate detector operator manual.

Read and understand **Calibration Guidelines**.

Verify that the detector is activated.

Verify that the detector is not in a low-battery state.

### Calibration Guidelines

1. Perform compliance tests only in a normal environment that is 20.9% v/v O<sub>2</sub> and free of hazardous gas. Do not operate the module in a hazardous area. Failure to adhere to this guideline can result in possible personal injury and/or property damage.

The use of calibration gas cylinders other than those specified by Honeywell may result in unsafe calibration or possible non-recoverable failure of the equipment, and will invalidate the warranty.

Do not use gas cylinders past their expiration date.

A demand flow regulator must be used with all gas cylinder connections. The module inlet should not be pressurized.

Do not calibrate the detector immediately after charging is complete.

Calibrate the sensor if ambient gas readings vary during startup.

Calibrate a new sensor before use. Allow the sensor to stabilize before starting calibration.

- x. Used sensor: wait 60 seconds
- y. New sensor: wait 5 minutes

When calibrating the same detector multiple times, wait 10 minutes between calibrations to allow the sensor to stabilize.

If a certified calibration is required, contact Honeywell or an authorized distributor.

## Special Considerations for IntelliDoX Ultra

**Note:** IntelliDoX Ultra requires Fleet Manager v4.5.x or greater.

Pre-Conditioning of the system is required for calibration of Ultra for NH3. Like a bump test, it is necessary to flow the gas prior to a successful calibration:

1. Place unit in the dock
2. Select calibration using the IntelliDoX menu
  - Calibrate once to pre-condition the system – This calibration will result in a fail
  - Calibrate the second time to test device – This calibration will result in a pass

For best performance with reactive gases such as CL2 and NH3 it is recommended to use short lengths of Teflon lined tubing for the connection between the gas cylinder and the IntelliDoX.

## Special Considerations for the MaxXT II Detector

**Note:** Insert the MaxXT II detector in the nest after the detector has started up for calibration.

### Calibration of PID sensor

PID sensors have two calibration options: 3-point and 2-point. This manual section will detail the necessary steps to perform both calibration types.

#### 3-point calibration for PID sensor:

1. In the Fleet manager tool enable 3-point calibration option for PID under BW Ultra configuration tab and save this configuration on Ultra detector.
2. Install multi inlet key in the IntelliDoX and configure 2 inlets for Isobutylene gas in which one inlet is for span low gas concentration and another is for span high gas concentration.
3. Place the detector into the IntelliDoX nest and close the lid.
4. After detector recognition IntelliDoX will provide 3 options bump test, calibration and transfer data-log from my detector.
5. Click on calibration option and apply Isobutylene gas.
6. After successful calibration IntelliDoX will display “calibration passed” with green color background screen with  ICON and on the Ultra detector cal date and cal status is updated as pass.

NOTE: If only one inlet is configured a missing gas screen will be shown by the IntelliDoX at unit insertion.

#### 2-point calibration for PID sensor:

1. In the Fleet manager tool disable 3-point calibration option for PID under BW Ultra configuration tab and save this configuration on Ultra detector.
2. In the IntelliDoX configure one inlet for Isobutylene gas and place Ultra detector into the IntelliDoX nest and close the lid.
3. After detector recognition IntelliDoX will provide 3 options bump test, calibration and transfer data-log from my detector.
4. Click on calibration option and apply Isobutylene gas.
5. After successful calibration IntelliDoX will display “calibration passed” with green color background screen with  ICON and on the Ultra detector cal date and cal status is updated as pass.

After performing a bump test or calibration, remove the detector from the IntelliDoX docking module to allow any residual gas to clear.

Leaving the detector in the docking module may cause it to fail the calibration. If a detector is bump tested and then a calibration is performed without removing it from the docking module, residual gas may cause the calibration to fail.

## Calibrating a Detector

You may use Fleet Manager II software to configure a detector to automatically perform calibration on insertion if the sensor calibration is overdue. When a compatible detector is inserted into the module and the calibration is overdue, then calibration starts automatically once the detector is recognized. Progress screens are displayed while the tests are performed.

1. Insert a compatible detector into the module. The LCD changes to gray and **Detector identification** is displayed.

When the module is configured to perform a calibration on overdue sensors and other procedures on insertion and the calibration is overdue, the LCD changes to yellow and **Testing Alarms** is displayed after the detector is recognized. Go to step 6.

When the module is configured to perform calibration and other procedures on insertion and the calibration is NOT overdue, the other procedures are performed after the detector is recognized. After the procedures are completed, **What do you need to do?** is displayed on the LCD. Go to step 5.

When the module is NOT configured to perform calibration or other procedures on insertion, detector operations menu and **What do you need to do?** are displayed after the detector is recognized. Go to step 5.

Press **◀** or **▶** to scroll to **Calibrate my detector**, and then press **✓**. The LCD changes to yellow and the calibration begins. Calibration begins. Progress screens are displayed while the tests are performed.



If the module is configured via Fleet Manager II software to automatically download datalogs, the detector datalogs are transferred to the module after the calibration is complete.

When the calibration is successful, the LCD changes to green and **Calibration passed** is displayed. Press **✓** to return to the detector operations menu.

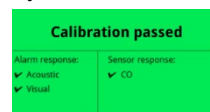

If the calibration fails, the LCD changes to red and **Calibration failed** is displayed. **X** indicates failed alarm and/or sensor test.



To understand how to respond appropriately to failed tests, refer to the appropriate detector operator manual.

## Transfer Datalogs from a Detector

---

There are two ways to transfer datalogs from a detector to the module:

1. Manually, via the module operations menu, or  
Automatically, by configuring detector settings via Fleet Manager II software.

### Transferring Datalogs via the Detector Operations Menu

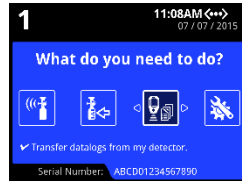

1. Insert a compatible detector into the module. **Detector identification** is displayed on the LCD. After the detector is recognized, procedures specified to occur automatically on insertion are performed.

When the module is configured to transfer datalogs on insertion, the datalogs are transferred after other procedures specified to occur automatically on insertion are completed. Go to step 5.

When the module is NOT configured to transfer datalogs on insertion, **What do you need to do?** is displayed after the detector is recognized. Go to step 4.

Press **◀** or **▶** to select **Transfer datalogs from my detector**, and then press **✓**. If the procedure is passcode-protected, then enter the passcode and press **✓** to continue. The LCD changes to yellow. A progress bar and the **Datalog file transfer** message are displayed.

When the transfer is complete, the LCD changes to green and **Datalog transfer complete** is displayed. Press **✓** to continue.

Open the lid and remove the detector, or perform other procedures.

### Transferring Datalogs Automatically by Configuring Settings via Fleet Manager II Software

For more information about creating and transferring configuration settings files via Fleet Manager II software, refer to **Configure Module and Detector Settings** on page 60. For more information about configuring settings via Fleet Manager II software, refer to the Fleet Manager II operator manual.



## Display the Adjust Dock Station Settings Menu

---

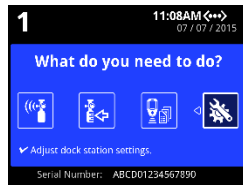

1. Insert a compatible detector into the module. **Detector identification** is displayed on the LCD. After the detector is recognized, procedures specified to occur automatically on insertion are performed.

After the detector is recognized and all procedures specified to occur automatically on insertion are completed, the detector operations menu and **What do you need to do?** Are displayed.

Press ◀ or ▶ to select **Adjust dock station settings**, and then press ✓.

The **Adjust Dock Station Settings** menu is displayed.

## Charge a Detector

---

You may use the module to charge compatible detectors that are fitted with rechargeable batteries. For more information on battery maintenance, refer to the appropriate detector operator manual.

### **⚠WARNING**

Charge only in a normal environment that is 20.9% v/v O<sub>2</sub> and free of hazardous gas. Do not operate the docking module in a hazardous area. Failure to adhere to this guideline can result in possible personal injury and/or property damage.

### Charging a Detector

Battery charging is disabled during bump test and calibration procedures.  
Do not store the detector in the module.

1. Insert a compatible detector into the module. **Detector identification** is displayed on the LCD.
2. When the detector is recognized, procedures specified to occur automatically on insertion are performed. If the detector contains a rechargeable battery, battery charging begins.
3. After the procedures are completed, you may leave the detector in the module for charging. If the detector is activated, the module will deactivate it after 10 minutes of inactivity and continue charging the battery.
4. When charging is complete, remove the detector from the module.

## Configure Settings via Fleet Manager II Software

Certain features, options and settings related to module or detector operations can be configured via Fleet Manager II software. This section contains general instructions for creating and transferring configuration files to modules and detectors via Fleet Manager II software.

## Protect Module Operations with a Passcode

You can configure a passcode to control access to certain module operations. When an operation is protected by a password, a lock symbol is displayed with the menu icon. Protected operations that are not performed automatically on insert may be performed only after the correct passcode is entered on the module. You must use Fleet Manager II software to configure and manage the passcode.

### Configuring a Module Passcode

1. Start Fleet Manager II software, and then log in as an administrator.

Select **Configure Devices via IntelliDoX** on the **Devices** menu. The **IntelliDoX Configuration Selection** dialog box is displayed.

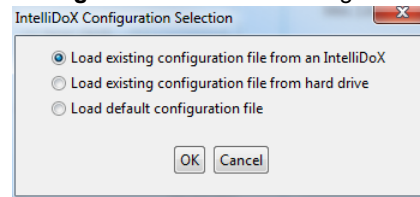

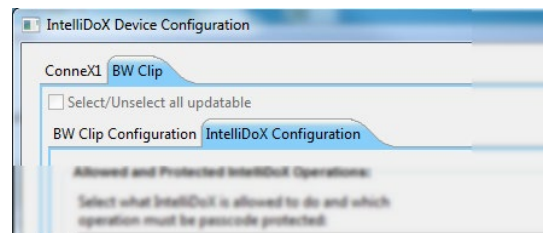

Select a configuration file and click **OK**. The **IntelliDoX Device Configuration** dialog box is displayed.

Select the tab for a compatible detector, and then select the **IntelliDoX Configuration** tab for the compatible detector.



In the **IntelliDoX Operations** section, select the operations you want to protect with a passcode.

Allowed and Protected IntelliDoX Operations:	Allowed	Passcode Protected
Select what IntelliDoX is allowed to do and which operation must be passcode protected:		
Access IntelliDoX menu selections	<input type="checkbox"/>	<input checked="" type="checkbox"/>
Perform detector bump tests	<input checked="" type="checkbox"/>	<input checked="" type="checkbox"/>
Exchange files with USB memory devices	<input checked="" type="checkbox"/>	<input checked="" type="checkbox"/>

In the **IntelliDoX Passcode** section, click  or  to select a 4-digit number.



Click **Save to IntelliDoX** to transfer the passcode configuration settings to one or more modules. For more information, see **Transferring the Configuration File to a Module via Fleet Manager II** on page 62.

## Configure Module and Detector Settings

Certain features, options and settings for the module and/or compatible detectors can be configured through Fleet Manager II software. You must use Fleet Manager II software to create a configuration file that is compatible with the module. After the configuration file is created, transfer it to one or more modules to implement the new configuration settings. For more information, refer to the Fleet Manager II operator manual and the appropriate detector operator manual.

### Workflow: Configuring Settings

1. Create the configuration file.  
Transfer the configuration file to one or more modules via Fleet Manager II software or via USB flash drive.  
Transfer configuration settings to a detector.

### Creating a Configuration File via Fleet Manager II

1. Start Fleet Manager II software, and then log in as an administrator.
2. Select **Configure Devices via IntelliDoX** on the **Devices** menu. The **IntelliDoX Configuration Selection** dialog box is displayed.

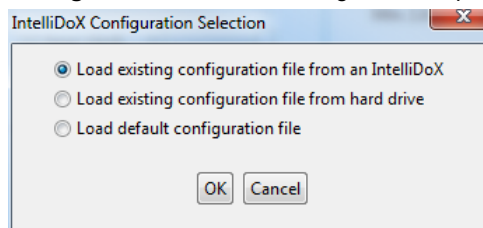

3. Select a configuration file and click **OK**. The **IntelliDoX Device Configuration** dialog box is displayed.
4. Select the tab for a compatible detector, and then select the detector configuration tab. Modify the available detector features, options and settings as required. For more information, refer to the Fleet Manager II operator manual and the appropriate detector operator manual.
5. Select the **IntelliDoX Configuration** tab. Modify the available features, options and settings as required. For more information, refer to the Fleet Manager II operator manual and the appropriate detector operator manual.

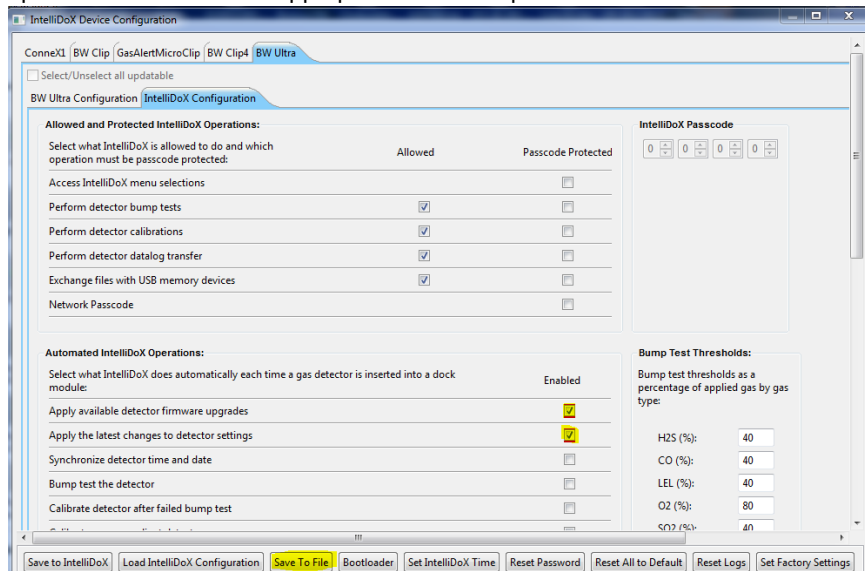

6. Transfer the configuration settings to one or more modules via Fleet Manager II or USB flash drive. For more information, refer to:
  - a. **Transferring the Configuration File to a Module via Fleet Manager II.**
  - b. **Transferring the Configuration File to a Module via USB Flash Drive**
7. Save the configuration file to PC or network folder, if necessary.

## Transferring the Configuration File to a Module via Fleet Manager II

1. Create the configuration file. See **Configure Module and Detector Settings** on page
2. Click **Save to IntelliDoX**. The **IntelliDoX Selection** dialog box is displayed. Select one or more modules, and then click **OK** to transfer the configuration file to the selected modules.

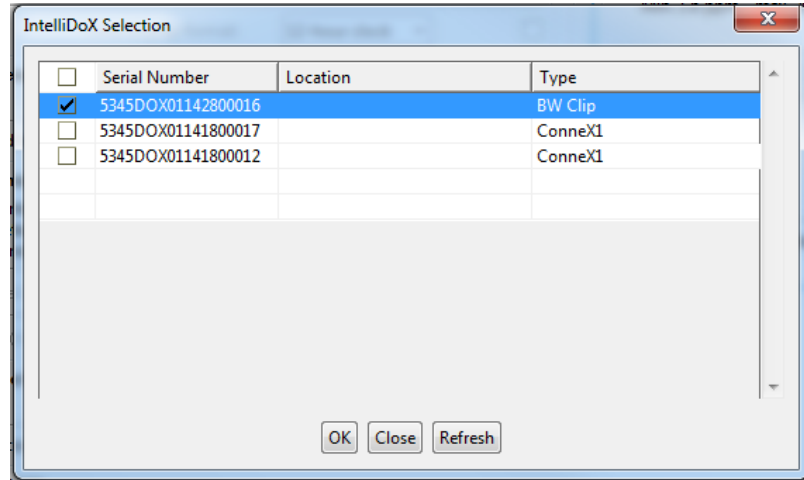

3. After the file is transferred, the **Operation completed** message box is displayed. Click **OK** to return to the **IntelliDoX Device Configuration** dialog box.
6. Verify that the configuration settings are updated on the selected modules.
  - a. Start Fleet Manager II software, and then log in as an administrator.
  - b. Select **Configure Devices via IntelliDoX** on the **Devices** menu. The **IntelliDoX Configuration Selection** dialog box is displayed.

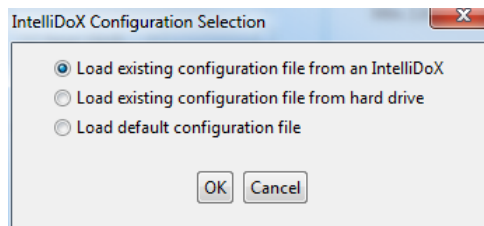

- c. Select **Load existing configuration file from an IntelliDoX**. The **IntelliDoX Selection** dialog box is displayed.
- d. Select a module and then click **OK**. The **Retrieving from IntelliDoX** progress screen is displayed.

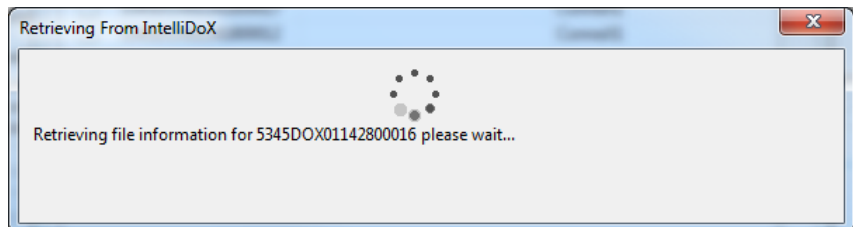

- e. After the settings are retrieved, the **IntelliDoX Device Configuration** dialog box is displayed. The serial number of the selected module is appended to the dialog box title bar.

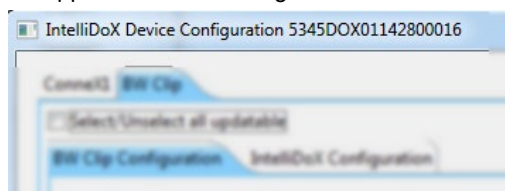

- f. Verify that the configuration settings are updated.
- g. Repeat steps 3 through 6 until configuration settings are verified for all modules.

## Transferring the Configuration File to a Module via USB Flash Drive

For connected modules, transfer the configuration file to each appropriate module in the gang.

1. Insert a USB flash drive into a USB port on your PC. Use Windows Explorer or My Computer to open the USB flash drive, and then create a new folder named **System**. Create the configuration file. See **Creating a Configuration File via Fleet Manager II or Safety Suite Software**. Click **Save to File**. The **Save Settings to File** dialog box is displayed. Save the configuration file to the **System** folder on the USB flash drive. Do not change the file name or extension. Eject the USB flash drive from the PC. Insert the USB flash drive into the USB port on the module. The **USB File Copy Utility** menu is displayed. Press  $\nabla$  or  $\triangle$  to select **Copy to dock** and then press  $\checkmark$  to continue. The LCD changes to yellow. A progress bar and alternating **Do not remove stick** and **USB transfer in progress** messages are displayed while the file is transferred. After the transfer is successfully completed, the LCD changes to blue and the **USB File Copy Utility** menu is displayed. Press  $\nabla$  or  $\triangle$  to select **Exit** and then press  $\checkmark$  to continue. The LCD changes to green. Remove the USB flash drive from the port when prompted.

## Transferring Configuration Settings to a Detector

1. Insert a compatible detector into the module. **Detector identification** is displayed on the LCD. If the detector is configured to update settings on insertion, then the detector settings are updated automatically after the detector is recognized. After the configuration update is completed, other procedures specified to occur on insert are performed. After all procedures are performed, remove the detector from the module and verify that the configuration settings are updated. For more information, refer to the appropriate detector operator manual.



## Adjust Time and Date Settings via Fleet Manager II Software

Follow the instructions in this section when you want to adjust the module time and date settings automatically via Fleet Manager II software. For connected modules, you must adjust time and date settings for each module in the gang.

You must use Fleet Manager II when you want to:

- Configure a module or detector to adjust for Daylight Savings Time;
- Synchronize a module time and date to a PC; and
- Configure compatible detectors to synchronize time and date settings to the module when inserted.

For more information, refer to the Fleet Manager II operator manual.

### Setting the Module Time

1. Start Fleet Manager II software, and then log in as an administrator. Select **Configure Devices via IntelliDoX** on the **Devices** menu. The **IntelliDoX Configuration Selection** dialog box is displayed.

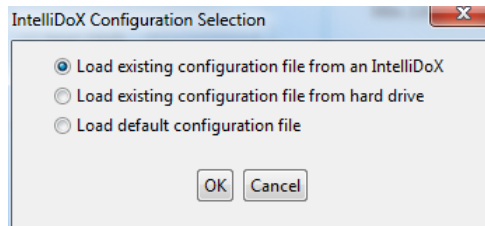

Select a configuration file and click **OK**. The **IntelliDoX Device Configuration** dialog box is displayed.

Select the tab for a compatible detector, and then select the **IntelliDoX Configuration** tab.

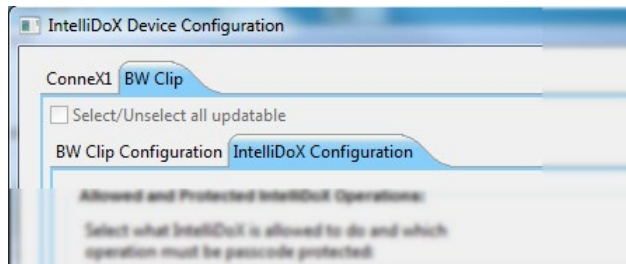

Click on the **Time zone** selector. Select your time zone from drop down menu.

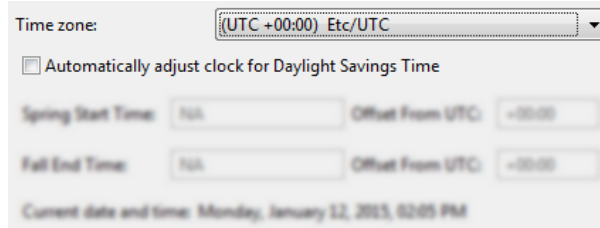

Verify that the **Current date and time** displayed under **Timezone settings** is correct. The date is synchronized with the PC on which Fleet Manager II software is installed. If the date is incorrect, change the date on the PC. If the time is incorrect, click on the **Time zone** selector to select a different time zone.

When the correct date and time are displayed, click **Set IntelliDoX Time**. The **IntelliDoX Time Confirmation** dialog box is displayed.

Click **Save to IntelliDoX**. The **IntelliDoX Selection** dialog box is displayed. Select one or more IntelliDoX modules, and then click **OK**.

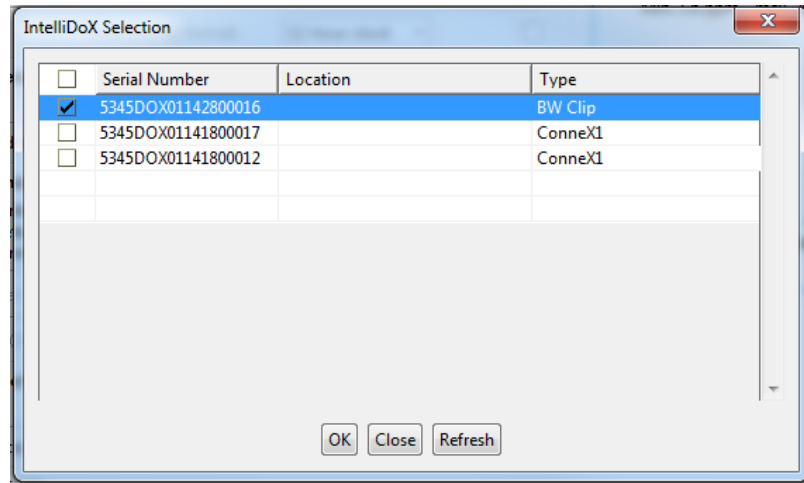

The **Saving To IntelliDoX** progress screen is displayed.

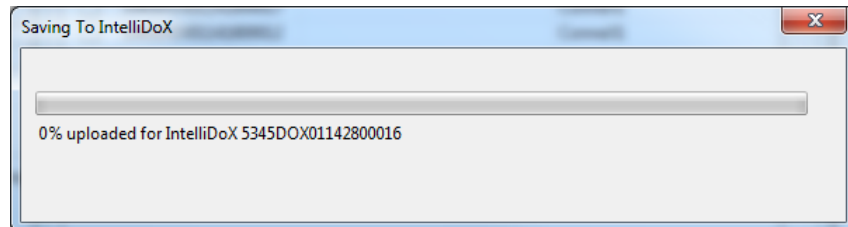

When the operation is complete, the **IntelliDoX Device Configuration** dialog box is displayed.

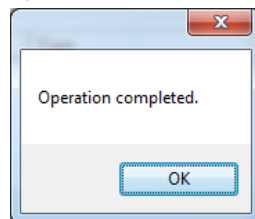

Verify that the new data and time settings are displayed on the selected modules.

## Adjusting the Clock for Daylight Savings Time

After the module time is set via Fleet Manager II software, you may use Fleet Manager II to configure module and detector clocks to automatically adjust for daylight savings time.

1. Set the module time. See **Setting the Module Time** on page 64.

Select the tab for a compatible detector and then select the **IntelliDoX Configuration** tab for the compatible detector.

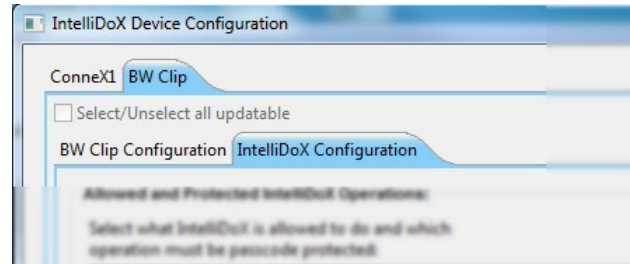

Under **Timezone Settings**, select **Automatically adjust clock for Daylight Savings Time**.

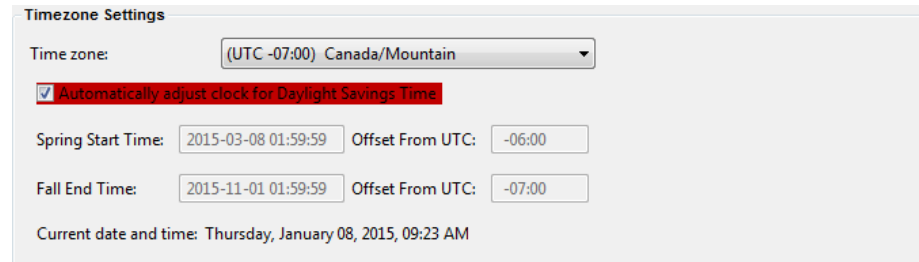

Click the **Time zone** selector and then select a time zone from the drop down menu. The next start and end dates for daylight savings time are displayed for the specified time zone.

Review and revise other configuration settings if necessary, and then save the configuration file and transfer it to one or more modules. For more information, see **Configure Module and Detector Settings** on page 60.

## Hibernation

Hibernation is a factory-installed feature that is available for certain detectors manufactured by Honeywell. When hibernation is activated, all detector safety functions are disabled and the detector operating life countdown is suspended. Hibernation may extend the service life of the detector, limited by the specified maximum operating life of the detector. It does not extend the specified maximum operating life of the detector.

For more information, refer to the Fleet Manager II operator manual and the appropriate detector operator manual.

## Configure Hibernation

---



You must use Fleet Manager II software to create a configuration file to activate hibernation on insertion. After the configuration file is created, you can use Fleet Manager II software or a USB flash drive to transfer the file to one or more modules. When a module is configured to activate hibernation on insertion, the LCD changes to gray and the hibernation symbol is displayed. All other module functions are disabled.

### **⚠WARNING**

Detectors in hibernation mode do not respond to gas. Do not use detectors in hibernation mode as personal protective equipment (PPE).

### **Work Plan: Configuring Hibernation**

1. Create a hibernation configuration file.

Transfer the hibernation configuration file to one or more modules via Fleet Manager II software, USB flash drive or Safety Suite Software.

Activate detector hibernation.

## Creating a Hibernation Configuration File via Fleet Manager II

1. Start Fleet Manager II software, and then log in as an administrator. Select **Configure Devices via IntelliDoX** on the **Devices** menu. The **IntelliDoX Configuration Selection** dialog box is displayed.

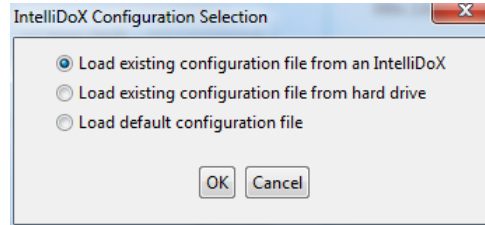

Select a configuration file and click **OK**. The **IntelliDoX Device Configuration** dialog box is displayed.

Select the tab for a compatible detector that supports hibernation, and then select the **IntelliDoX Configuration** tab.

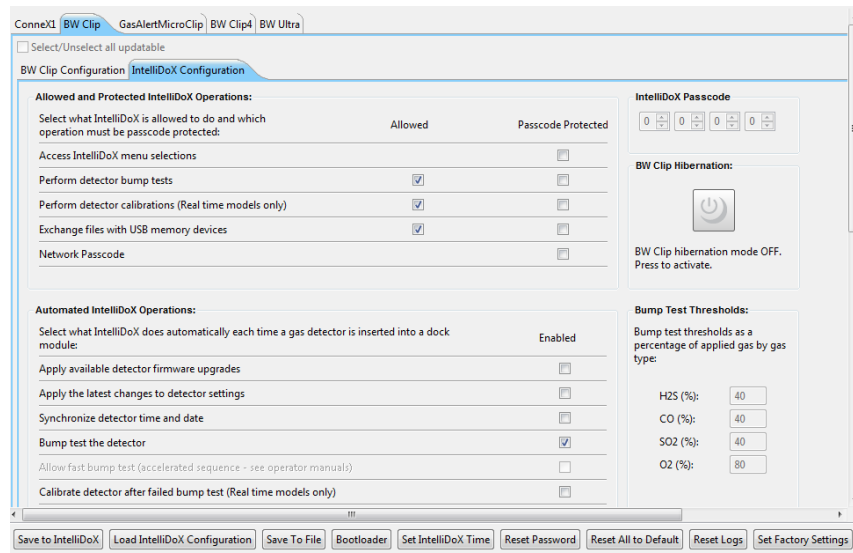

Click the **Hibernation** icon to activate hibernation.

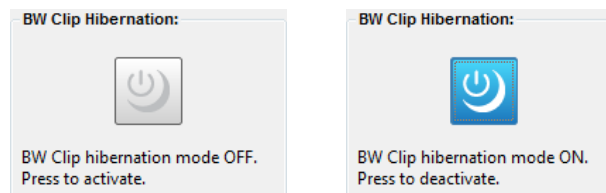

The hibernation activation dialog box is displayed. Click **OK** to save the setting, or click **Cancel** to discard the changes.

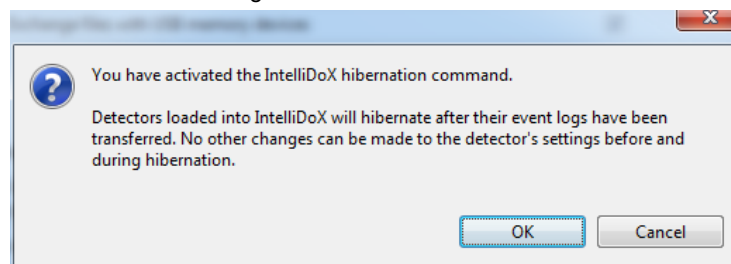

- 7.- Click **Safe to File**. Save the configuration file to PC. Do not change the default file name.

## Creating a Hibernation Configuration File via Safety Suite Software

1. From the main window, click **IntelliDox Configuration**.
2. From the IntelliDox Configuration panel, select the **Hibernation** checkbox.

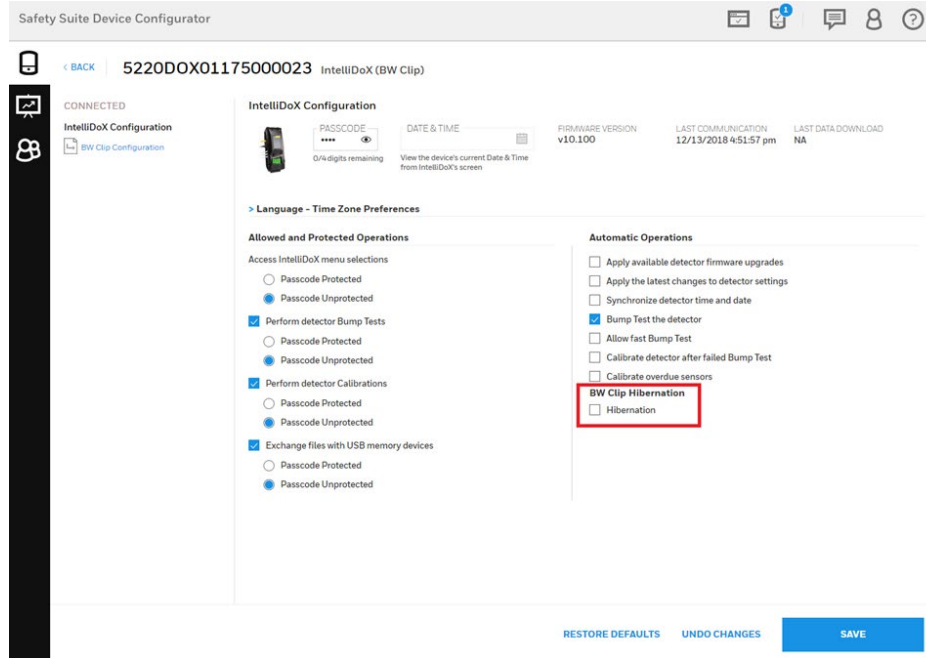







3. Click **Save**.

## Transferring a Hibernation Configuration File to a Module via Fleet Manager II Software

1. Create the hibernation configuration file. See **Hibernation** on page 67.  
Click **Save to IntelliDoX**. The **IntelliDoX Selection** dialog box is displayed.  
Select one or more modules, and then click **OK** to transfer the hibernation configuration file to the selected modules.  
After the file is transferred, the **Operation completed** message box is displayed. Click **OK** to return to the **IntelliDoX Device Configuration** dialog box.  
Verify that the selected modules are configured for hibernation.
  - h. The LCD is gray.
  - i. The hibernation symbol is displayed.

## Transferring a Hibernation Configuration File to a Module via USB Flash Drive

For connected modules, transfer the file to each appropriate module in the gang.

1. Insert a USB flash drive into a USB port on your PC. Use Windows Explorer or My Computer to open the USB flash drive, and then create a new folder named **System**.
2. Create the hibernation configuration file. See **Hibernation** on page 67.
3. Click **Save to File**. The **Save Settings to File** dialog box is displayed.
4. Save the hibernation configuration file to the **System** folder on the USB flash drive. Do not change the file name or extension. Eject the USB flash drive from the PC.
5. Insert the USB flash drive into the USB port on the module. The **USB File Copy Utility** menu is displayed. Press  or  to select **Copy to dock** and then press  to continue.
6. The LCD changes to yellow. A progress bar and alternating **Do not remove stick** and **USB transfer in progress** messages are displayed while the file is transferred.
7. After the transfer is successfully completed, the LCD changes to blue and the **USB File Copy Utility** menu is displayed. Press  or  to select **Exit** and then press  to continue.
8. The LCD changes to green. Remove the USB flash drive from the port when prompted.
9. Verify that the selected modules are configured for hibernation.
  - a. The LCD is gray.
  - b. The hibernation symbol is displayed.



## Activating Detector Hibernation

1. Verify that the module is configured for hibernation.
  - a. The LCD is gray.
  - b. The hibernation symbol is displayed.

Insert a compatible detector into the module. **Detector identification** is displayed on the LCD.

After the detector is recognized, event logs are transferred to the module.

After the event log transfer is complete, hibernation is activated on the detector.

Remove the detector from the module and store for future use.

To learn more about hibernation, suitable conditions for detector storage, and detector reactivation, refer to the appropriate detector operator manual.

## Transfer Data Files

This section contains information and instructions related to transferring data files from detectors to modules and from modules to a PC via Fleet Manager II software or USB flash drive.

## Transfer Data Files from the Module

---

Each module retains detailed, time-stamped data related to compliance test results and module configuration events. The data are continuously updated, and stored in on-board memory. When the on-board memory has reached capacity, the newest data replaces the oldest data.

Each module also stores event logs and datalogs that are transferred from inserted detectors. When the on-board memory has reached capacity, the newest logs replace the oldest logs.

You can use Fleet Manager II software to transfer and manage data files, or you can transfer the data files to a PC via USB flash drive. Data file transfers may take several minutes to complete when multiple and/or large data files are transferred. For best results, Honeywell recommends that you transfer data files periodically.

For more information, refer to the Fleet Manager II operator manual and the appropriate detector operator manual.

### Transferring Data Files via Fleet Manager II Software

You can use Fleet Manager II software to transfer data from modules that are activated and connected to a network. Data files transferred via Fleet Manager II software are added to the Fleet Manager II database. After the data files are transferred, you can use Fleet Manager II to manage data and prepare custom reports.

1. Start Fleet Manager II software, and then log in as an administrator.

Select **Import** from the **Devices** menu. The **Import Device Data** window is displayed.

Select **IntelliDoX Import**. The **Getting list of IntelliDoXs** message box may be displayed while Fleet Manager II prepares a list of available modules.

Select one or more modules. Select the file types to import, and then set a date range for the records. Click **Import**. A downloading progress bar for each selected module is displayed.





When all the progress bars are 100% complete, the **Successfully downloaded logs** dialog box is displayed. Click **OK** to return to Fleet Manager II.

## Scheduling Automatic Data File Transfers via Fleet Manager II Software

You can use Fleet Manager II software to schedule automatic data file transfers from modules that are activated and connected to a network. Fleet Manager II software must be operating on a PC that is connected to a computer network when the scheduled transfer is initiated. Fleet Manager II automatically transfers data from specified modules that are activated and connected to the network when the transfer is initiated.

1. Start Fleet Manager II software, and then log in as an administrator.  
Select **Import** from the **Devices** menu. The **Import Device Data** window is displayed.  
Select **IntelliDoX Import**. The **Getting list of IntelliDoXs** message box may be displayed while Fleet Manager II prepared a list of available modules.  
Click **View/Edit Schedule**. The **Gathering the connection status of Scheduled IntelliDoX** message box is displayed while Fleet Manager II gathers information from modules that are active and connected to the network.  
After the module information is gathered, the **Scheduled Import** dialog box is displayed.  
Select one or more modules from the **Available IntelliDoX** list, and then click **Add to Schedule**. The selected modules are added to the **Scheduled IntelliDoX** list.  
Set the date, time and occurrence options under **Next Scheduled For**.  
Select the log file types to import under **Select Logs**.  
Select **Next Scheduled For** options, and then select the logs to import.  
Click **Save** to save the schedule settings. Fleet Manager II processes the scheduled transfer at the specified date and time until the scheduled import is modified or deleted.  
For more information, refer to the Fleet Manager II operator manual.

## Transferring Data Files Manually via USB Flash Drive

1. For connected modules, you must transfer the data files from each module in the gang.  
Insert the USB flash drive into the USB port on the module. The **USB File Copy Utility** menu is displayed.  
Press  or  to select **Copy from dock**, and then press . The LCD changes to yellow. A progress bar is displayed with alternating **USB transfer in Progress** and **Do not remove stick** messages while the files are transferred.  
After the transfer is successfully completed, the LCD changes to blue and the **USB File Copy Utility** menu is displayed.  
Press  or  to select **Exit**. The LCD changes to green and **USB transfer complete** and **Please remove stick** are displayed. Remove the USB flash drive from the port.  
Insert the USB flash drive into a USB port on a computer that contains Fleet Manager II software.  
Start Fleet Manager II software and then select **Import** from the **Devices** menu. The **Import Device Data** window is displayed.  
Select **Directly From a File**. Click **Choose File** to select one file for import from the USB flash drive, or click **Choose Directory** to select all files in a named folder on the USB flash drive. Click **Import**. A downloading progress bar is displayed.  
When the progress bar reaches 100% complete, the **Successfully Imported Files** message box is displayed. Click **OK** to return to Fleet Manager.  
Repeat steps 7 and 8 until all data files are imported.

## Update Firmware

Honeywell is committed to continuously improving product features and performance. As a result, firmware updates may become available for certain products. Honeywell recommends that you visit the appropriate product site at [www.honeywellanalytics.com](http://www.honeywellanalytics.com) to find and download the latest firmware version for your products.

## Update Module Firmware







---

Honeywell is committed to continuously improving product features and performance. As a result, firmware updates may become available for the modules. Honeywell recommends that you visit the appropriate product site at [www.honeywellanalytics.com](http://www.honeywellanalytics.com) to find and download the latest firmware version for your modules.

### Updating Module Firmware via USB Flash Drive

Follow these instructions to update firmware for an individual module or a gang of up to five connected modules. The update is processed only when the module or gang of modules is idle.

For connected modules, you must transfer the firmware update to each module in the gang.

1. Download and save the firmware update file to a PC or network drive. Do not rename the file.
2. Transfer the update to a USB flash drive.
  - a. Insert a USB flash drive into a USB port on your PC. Use Windows Explorer or My Computer to open the USB flash drive, and then create a new folder named **System**.
  - b. Copy the firmware update to the **System** folder on the USB flash drive. Do not change the file name or extension.
  - c. Eject the USB flash from the PC.
3. Transfer the file from the USB flash drive to a module.
  - a. Insert the USB flash drive into the USB port on the module. The **USB File Copy Utility** menu is displayed.
  - b. Press  or  to select **Copy to dock** and then press  to continue.
  - c. The LCD changes to yellow. A progress bar and alternating **Do not remove stick** and **USB transfer in progress** messages are displayed while the file is transferred.
  - d. After the transfer is successfully completed, the LCD changes to blue and the **USB File Copy Utility** menu is displayed. Press  or  to select **Exit**. Press  to continue.
  - e. The LCD changes to green. Remove the USB flash drive from the port when prompted.
4. The firmware update begins automatically when the module is idle. If the module is part of a gang of connected modules, then installation begins after all of the modules in the gang are idle.
5. The LCD changes to yellow. **Installing new dock firmware. Please wait ...** is displayed.

Do not deactivate the module during installation.

6. After the update is installed, updated modules restart automatically. **IntelliDoX reboot pending. Please wait...** is displayed. After a few minutes, IntelliDoX rebooting is displayed. The reboot takes about 5 seconds. The screen deactivates briefly while the module restarts.
7. After the installation is complete, the LCD changes to green and **Firmware update complete** is displayed.
8. Verify the version of the installed firmware.

- a. Press and hold **✓** on the keypad until **Adjust dock station settings** is displayed on the LCD.
  - b. Press **◀** or **▶** to select **About**, and then press **✓**. The **About this docking module** summary screen is displayed.
  - c. Read the firmware version information.
  - d. Press **X** to return to the **Adjust dock station settings** menu.
9. For connected modules, repeat steps 3 through 7 until all modules in the gang are updated.

## Updating Module Firmware via Fleet Manager II

When a module or gang of modules is connected to a network, you may transfer the firmware update file to multiple selected modules via Fleet Manager II software. The update is processed only when the module or gang of modules is idle. You can verify the version of the installed firmware as well as other module details via the **IntelliDoXs** on the **Administration** menu in Fleet Manager II.

For more information, refer to the Fleet Manager II operator manual.

1. Download and save the firmware update file to a PC or network drive. Do not rename the file.
2. Start Fleet Manager II software, and then log in as an administrator.
3. Select **Configure Devices via IntelliDoX** on the **Devices** menu. The **IntelliDoX Configuration Selection** dialog box is displayed.

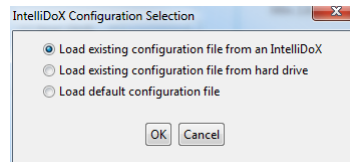

4. Select a configuration file and click **OK**. The **IntelliDoX Device Configuration** dialog box is displayed.
5. Click **Bootloader** at the bottom of the IntelliDoX Device Configuration dialog box. The **IntelliDoX Selection** dialog box is displayed. Click **Choose File**. The **Choose Firmware File To Upload** dialog box is displayed. Select the downloaded file, and then click **Open**. The **IntelliDoX Selection** dialog box is displayed.

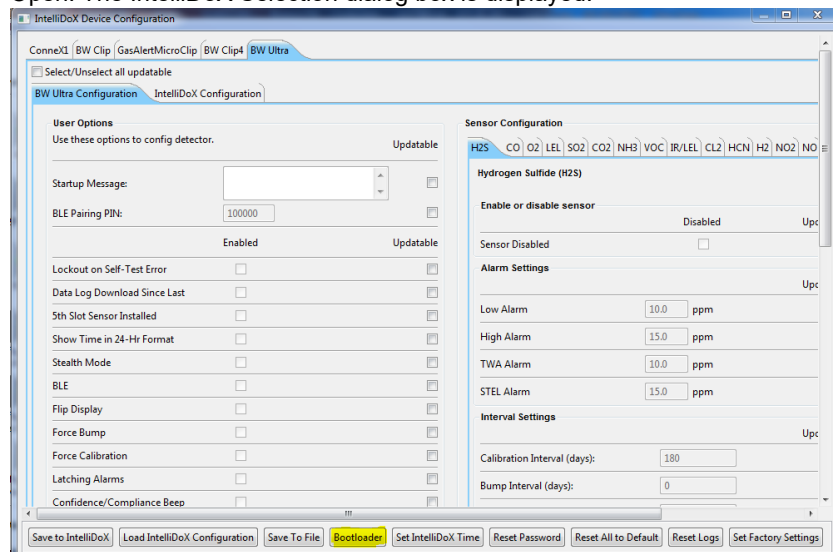

6. Select one or more IntelliDoX modules, and then click **OK**. A progress screen is displayed while the firmware update file is automatically transferred to the selected modules. When the transfer is complete, click **OK** to close the dialog box.

7. The firmware update begins automatically when the module is idle. The LCD changes to yellow. **Installing new dock firmware. Please wait ...** is displayed. Do not deactivate the module during installation.
8. If the module is part of a gang of connected modules, then installation begins after all of the modules in the gang are idle.
9. After the update is installed, updated modules restart automatically. **IntelliDoX reboot pending. Please wait...** is displayed. After a few minutes, **IntelliDoX rebooting....** The reboot takes about 5 seconds. The screen deactivates briefly before the module restarts.
10. After the installation is complete, the LCD changes to green and **Firmware update complete** is displayed.
11. Verify the version of the installed firmware.
  - a. Select **IntelliDoXs** on the **Administration** menu in Fleet Manager II software.
  - b. The **Manage IntelliDoXs** table is displayed. Review the module information.



## Update Detector Firmware

---

Honeywell is committed to continuously improving product features and performance. As a result, firmware updates for detectors may become periodically available. Honeywell recommends that you visit the appropriate product site at [www.honeywellanalytics.com](http://www.honeywellanalytics.com) to find and download the latest firmware version for your modules.







### Work Plan: Updating Detector Firmware

1. Download and save the firmware update file to a PC or network drive. Do not rename the file.
2. Transfer the firmware update to a module or gang of modules. See **Transferring Detector Firmware via USB Flash Drive** or **Transferring Detector Firmware via Fleet Manager II**.
3. Update the detector. See **Update Detector Firmware**.
4. Verify the firmware version. For more information, refer to the appropriate detector operator manual.

### Transferring Detector Firmware via USB Flash Drive

Follow these instructions to transfer detector firmware via USB flash drive to individual modules, or to modules that are connected in a gang.

For connected modules, transfer the file to each appropriate module in the gang.

1. Download and save the firmware update file to a PC or network drive. Do not rename the file.
2. Insert a USB flash drive into a USB port on your PC. Use Windows Explorer or My Computer to open the USB flash drive, and then create a new folder named **System**.
3. Copy the firmware update to the **System** folder on the USB flash drive. Do not change the file name or extension. Eject the USB flash drive from the PC.
4. Verify that the detector firmware is appropriate for the module, and then transfer the file.
  - a. Insert the USB flash drive into the USB port on the module. The **USB File Copy Utility** menu is displayed.
  - b. Press  or  to select **Copy to dock** and then press  to continue.
  - c. The LCD changes to yellow. A progress bar and alternating **Do not remove stick** and **USB transfer in progress** messages are displayed while the file is transferred.
  - d. After the transfer is successfully completed, the LCD changes to blue and the **USB File Copy Utility** menu is displayed. Press  or  to select **Exit**. Press  to continue.
  - e. The LCD changes to green. Remove the USB flash drive from the port when prompted.

## Transferring Detector Firmware via Fleet Manager II

When a module or gang of modules is connected to a network, you may transfer the detector firmware update file to multiple selected modules via Fleet Manager II software. For more information, refer to the Fleet Manager II operator manual.

1. Download and save the firmware update file to a PC or network drive. Do not rename the file.
2. Start Fleet Manager II software, and then log in as an administrator. Select **Configure Devices via IntelliDoX** on the **Devices** menu. The **IntelliDoX Configuration Selection** dialog box is displayed.
3. Select a configuration file and click **OK**. The **IntelliDoX Device Configuration** dialog box is displayed.
4. Click **Bootloader**. The **IntelliDoX Selection** dialog box is displayed.
5. Click **Choose File**. The **Choose Firmware File To Upload** dialog box is displayed. Select the downloaded file, and then click **Open**. The **IntelliDoX Selection** dialog box is displayed.
6. Select one or more IntelliDoX modules, and then click **OK**. A progress screen is displayed while the firmware update file is automatically transferred to the selected modules.
7. When the transfer is complete, click **OK** to close the dialog box.

## Updating the Detector Firmware

Modules must be configured via Fleet Manager II software to enable firmware updates on insertion for compatible detectors. For more information, see **Configure Module and Detector Settings** on page 37.

1. Insert a compatible detector into the module. **Detector identification** is displayed on the LCD.
2. If the module is configured to perform a firmware update and other procedures on insertion and a firmware update is available, then the detector event logs are automatically transferred to the module and the firmware update begins.
3. The LCD changes to yellow. A progress bar and the **Detector firmware upgrade** message are displayed.
4. After the upgrade is completed, the detector reboots. Alternating **Detector rebooting** and **Do not open lid** messages are displayed.
5. When the reboot is successful, the LCD changes to green and the **Firmware upgrade complete** message is displayed. Other procedures specified to occur automatically on insertion are performed.
6. After all operations are completed, verify the firmware update.
  - a. Open the lid and remove the detector.
  - b. Verify the firmware version. For more information, refer to the appropriate detector operator manual.

## Updating the Detector Firmware via Safety Suite

When a new Firmware version is available, the user will get an **UPDATE** button under the FIRMWARE VERSION section in the IntelliDoX Configuration panel.

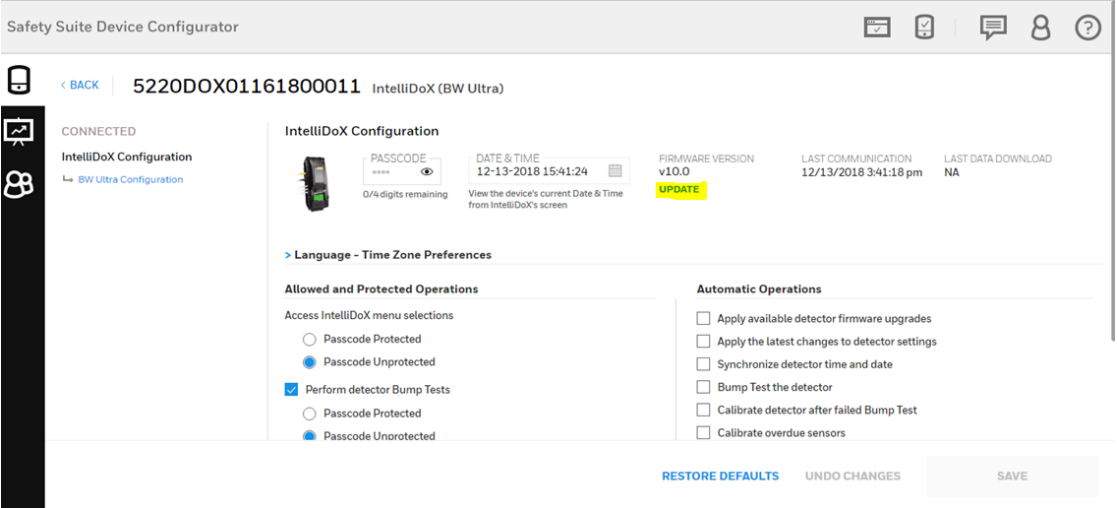

The screenshot displays the 'Safety Suite Device Configurator' interface. At the top, it shows the device ID '5220DOX01161800011' and the device name 'IntelliDoX (BW Ultra)'. The status is 'CONNECTED'. The main configuration area is titled 'IntelliDoX Configuration' and includes several sections:

- IntelliDoX Configuration:** Contains fields for 'PASSCODE' (with a toggle for visibility), 'DATE & TIME' (12-13-2018 15:41:24), 'FIRMWARE VERSION' (v10.0), 'LAST COMMUNICATION' (12/13/2018 3:41:18 pm), and 'LAST DATA DOWNLOAD' (NA). A yellow 'UPDATE' button is located next to the Firmware Version field.
- Language - Time Zone Preferences:** A section with a right-pointing arrow.
- Allowed and Protected Operations:** Includes 'Access IntelliDoX menu selections' with radio buttons for 'Passcode Protected' and 'Passcode Unprotected' (selected). Below this are checkboxes for 'Perform detector Bump Tests' (checked), 'Passcode Protected', and 'Passcode Unprotected'.
- Automatic Operations:** Includes checkboxes for 'Apply available detector firmware upgrades', 'Apply the latest changes to detector settings', 'Synchronize detector time and date', 'Bump Test the detector', 'Calibrate detector after failed Bump Test', and 'Calibrate overdue sensors'.

At the bottom of the configuration panel, there are three buttons: 'RESTORE DEFAULTS', 'UNDO CHANGES', and 'SAVE'.

Click **UPDATE**; Safety Suite will automatically select the file stored in the database and proceed with the firmware upgrade.

After the firmware upgrades, the page will get refreshed, and a new version number will be displayed.

## Replace Detector Cradle and Calibration Insert

This section contains information and instructions related to replacing an IntelliDoX detector cradle and calibration insert.

## Upgrade the IntelliDoX to Fit Compatible Detectors

The IntelliDoX system is designed for users to upgrade their detector docking solution to meet their changing needs. The IntelliDoX allows users to upgrade from one detector to another with the replacement of the detector cradle and calibration insert.

### What You Need to Replace the Detector Cradle and Calibration Insert

- A Philips screwdriver to remove the screws on the IntelliDoX

**IMPORTANT:** You must transfer data files from the IntelliDoX before you replace the cradle and calibration insert.

Here's what you'll do to replace the cradle and calibration insert:

1. Transfer data from the IntelliDoX (see Transfer Data Files on page 73).  
Update the firmware on the IntelliDoX to a compatible version, if required (see Update Firmware on page 76).  
Replace the cradle on the IntelliDoX.  
Replace the calibration insert on the IntelliDoX.

## Replace the Detector Cradle

---

To replace the cradle, remove the cradle from the IntelliDoX (unscrew the screws and unplug the connector), and then install the replacement cradle.

1. Disconnect the power cord, network cable, tubing, and inlet filter assemblies from the IntelliDoX.

Use a screwdriver to unscrew the two screws from the cradle.

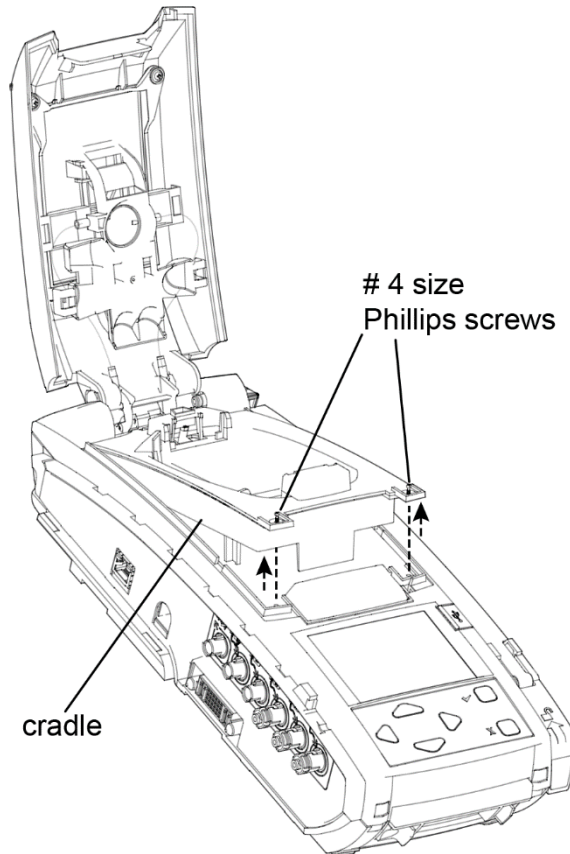

Lift the cradle, hold the connector at the end of the cable, and pull to unplug the cable from the circuit board.

**⚠ CAUTION** Do not pull on the cable to unplug the cable. You can cause damage to the cable. Hold the end connector.

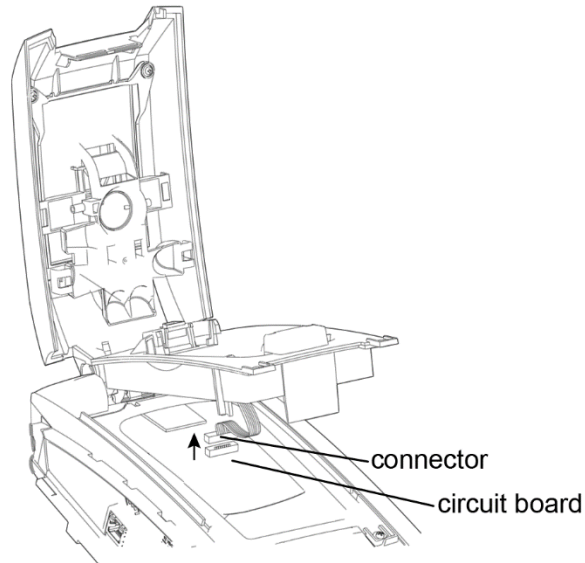

Remove the cradle from the IntelliDoX.

Get the replacement cradle.

Plug the replacement cradle's connector cable into the circuit board.

Slide the replacement cradle's tabs under the IntelliDoX top assembly to place the cradle into the IntelliDoX.

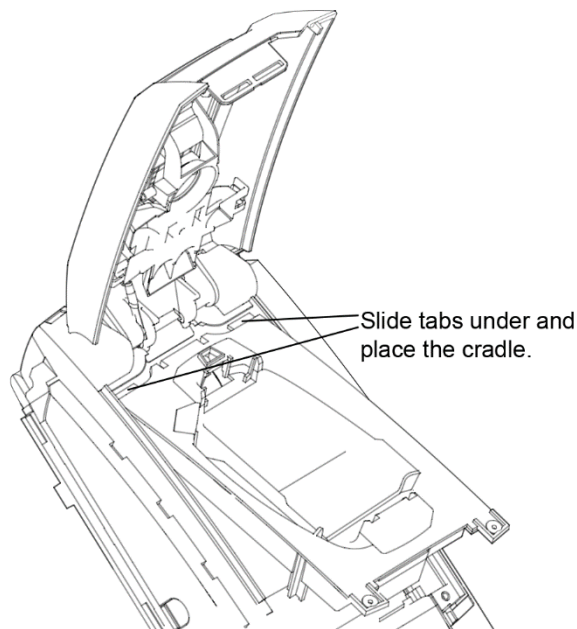

Use a screwdriver to fasten the two screws on the replacement cradle.

## Replace the Calibration Insert

---

To replace the calibration insert, remove the calibration insert from the IntelliDoX (unscrew the screws and detach the gas tubes), and then install the replacement calibration insert.

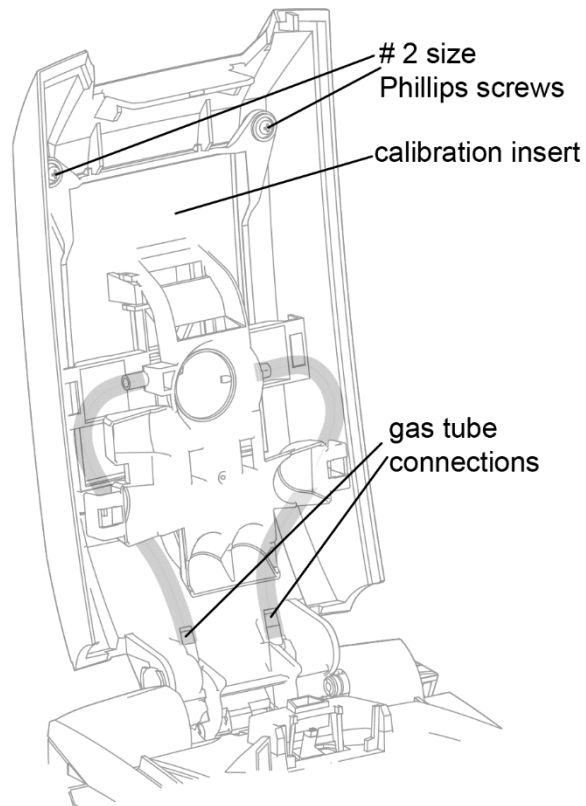

1. Disconnect the power cord, network cable, tubing, and inlet filter assemblies from the IntelliDoX.

Use a screwdriver to unscrew the two screws from the calibration insert.

Detach the two gas tubes from the IntelliDoX.

Remove the calibration insert.

Get the replacement calibration insert.



Slide the calibration insert tabs under the IntelliDoX lid assembly to place the replacement calibration insert into the IntelliDoX.

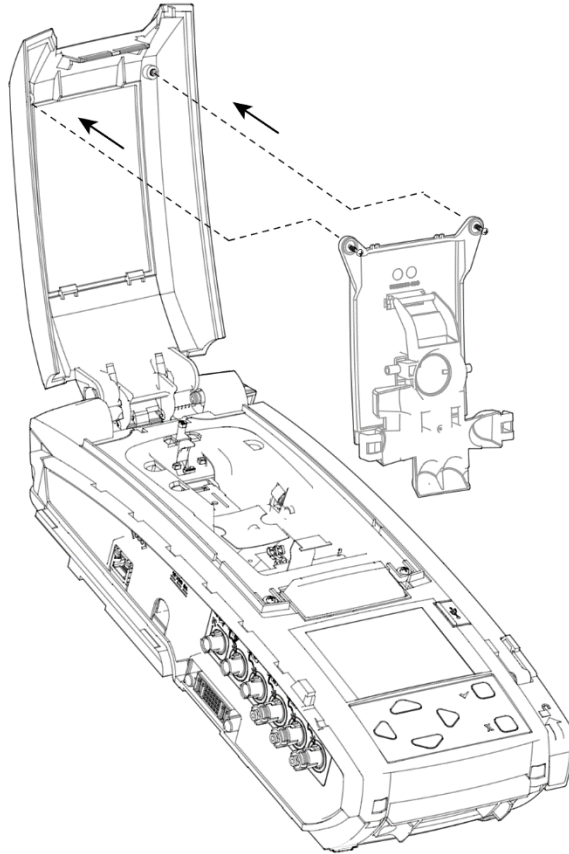

Use a screwdriver to fasten the two screws on the replacement calibration insert. Connect the gas tubes to the IntelliDoX.

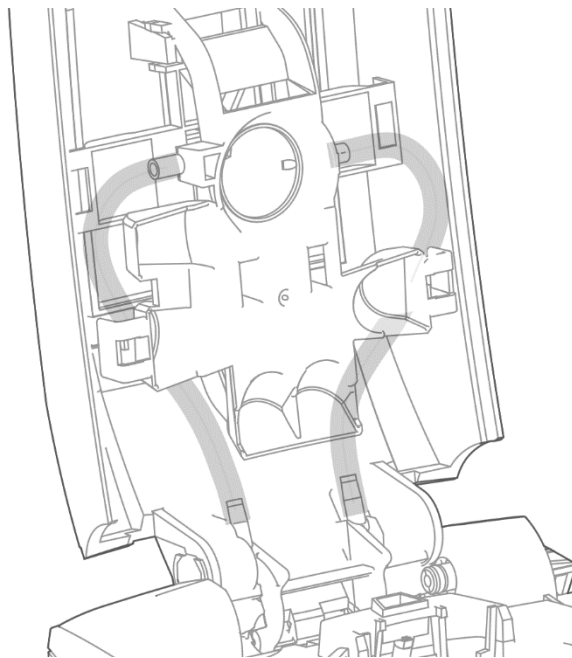

# Maintenance

This section contains general information related to cleaning and maintenance, replacement parts and accessories, and calibration equipment and accessories.

## Clean and Maintain the Module

---

### Before You Begin

1. Disconnect power before performing maintenance or cleaning.

To avoid personal injury or damage to the module, use only replacement parts and/or accessories obtained from Honeywell or an authorized distributor.

No user-serviceable parts are inside the module.

If the module is damaged, contact Honeywell or an authorized distributor.

#### **⚠WARNING**

If the equipment is damaged or parts are missing, contact Honeywell immediately.

Substitution of components may impair the safety of the equipment.

Do not attempt to disassemble, adjust, or service the equipment unless instructions are provided to perform a procedure, or a component is listed as a user-replaceable component in the user manual. Use only Honeywell replacement components.

Do not expose the equipment to electrical shock or severe and/or continuous mechanical shock.

Do not immerse the equipment in liquids.

### Basic maintenance

To maintain the module in good operating condition, perform the following basic maintenance as required:

1. Maintain a log of all maintenance that is performed.

Clean the exterior with a soft, damp cloth.

- Do not immerse in liquids.
- Do not use solvents, soaps or polishes.

Confirm that the inlet filter is free of dirt. Replace if required.

Once service is complete, reconnect the power supply. When power is connected, the LCD activates and self-test is performed.

### Replacement Parts and Accessories

Replaceable parts are sold separately. To receive a complete list of replaceable parts approved for use with this product, contact Honeywell or an authorized distributor, or visit the product website at [www.honeywellanalytics.com](http://www.honeywellanalytics.com)

Gas detectors, calibration and purge gas cylinders, and other accessories are sold separately. To receive a complete list of calibration gases and accessories approved for use with this product, contact Honeywell or an authorized distributor, or visit the product website at [www.honeywellanalytics.com](http://www.honeywellanalytics.com).

## Calibration Equipment and Gases

---

### **⚠WARNING**

The use of calibration gas cylinders other than those specified by Honeywell may result in unsafe calibration or possible non-recoverable failure of the equipment, and will invalidate the warranty.

A demand flow regulator must be used with all calibration gas cylinder connections. The module inlet should not be pressurized.

To receive a complete list of calibration gases and accessories approved for use with this product, contact Honeywell or an authorized distributor, or visit the Order Information section of the product website at [www.honeywellanalytics.com](http://www.honeywellanalytics.com).

Sticky gases (CL<sup>2</sup>, NH<sup>3</sup> and NO<sup>2</sup>) calibration and bump tests of are only allowed on **first bay**. The user cannot perform calibration and bump tests from bay-2 to bay-5. And for that configured inlet, IDOX will display as .

# Technical Specification and Warranty

This section includes the technical specification and warranty for the module.

## Technical Specification

---

### Dimensions

14.2 x 5.4 x 4.3 in (361 x 137 x 109 mm)

### Weight

4.2 lb (1.9 kg)

### Base system ingress protection

IP20

### Enclosure

Impact resistant polycarbonate and acrylonitrile butadiene styrene (PC+ABS)

### Operating temperature

+50°F to +95°F (+10°C to +35°C)

### Humidity

10% to 90% non-condensing

### Altitude

Maximum 6 561 feet (2 000 meters)

### Storage temperature

+14°F to +140°F (-10°C to +60°C)

### Power supply

12 V 8.33A ITE power supply

### Type of equipment

Process Control Equipment

### Equipment class

Cord-connected, Class III

### Pollution degree

2

### Installation category

I

### Mode of operation

Continuous

### Real-time clock

Provides date and time stamp

### Data storage

2 gigabytes of on-board memory

### External interface

Ethernet

### Pump flow rate

350 mL per minute

### Calibration gas cylinder inputs

1 or 4 gas inlets

1 ambient air (purge) inlet

### Automatic tests

Functional bump test; calibration; data transfer; audible alarm; visual alarm

### Configuration recognition

Automatic instrument and sensor

### Alarm/calibration parameters

User-defined

### Calibration gas connections

Built-in

### Gas connection

3.2 mm (1/8 in) sub-miniature connect (SMC) coupling

### Solenoid

Built-in

### LCD Background

Gray: Idle

Blue: Prompt for user action

Yellow: Activity in progress

Green: Activity completed

Red: Warning

### Keypad

▶ Scroll right

◀ Scroll left

△ Scroll up

▽ Scroll down

✓ Press and hold until the module settings menu is displayed. Press and release to select a menu item or save changes.

X Press and hold until an operation is cancelled. Press and release to close a menu item or return to a previous screen or cancel changes.

### Communications method

Two-way infrared between docking module and detector

### Ports

1 USB port

1 Ethernet port, for connection to a computer network

### Sensors

Audio and optical

### Warranty

2 years beginning at date of shipment to the buyer



This symbol indicates that the product must not be disposed of as general industrial or domestic waste. This product should be disposed of through suitable WEEE disposal facilities. For more information about disposal of this product, contact your local authority, distributor or the manufacturer.

**FCC**

**NOTE:** This equipment has been tested and found to comply with the limits for a Class A digital device, pursuant to part 15 of the FCC Rules. These limits are designed to provide reasonable protection against harmful interference when the equipment is operated in a commercial environment. This equipment generates, uses, and can radiate radio frequency energy and, if not installed and used in accordance with the instruction manual, may cause harmful interference to radio communications. Operation of this equipment in a residential area is likely to cause harmful interference in which case the user will be required to correct the interference at his own expense.

**FCC CAUTION:** Any changes or modifications not expressly approved by the party responsible for compliance could void the user's authority to operate the equipment.

**FCC / Industrie Canada Compliance**

Cet appareil est conforme aux normes FCC Partie 15 et normes RSS exemptes de licence d'Industrie Canada. Son utilisation est soumise aux deux conditions suivantes :

(1) cet appareil n'engendre pas d'interférences, et

(2) cet appareil doit tolérer tout type d'interférences, notamment les interférences pouvant provoquer une utilisation non désirée de l'appareil.

## Limited Warranty and Limitation Liability

---

Honeywell LP (BW) warrants the product to be free from defects in material and workmanship under normal use and service for a period of two years, beginning on the date of shipment to the buyer. This warranty extends only to the sale of new and unused products to the original buyer. BW's warranty obligation is limited, at BW's option, to refund of the purchase price, repair or replacement of a defective product that is returned to a BW authorized service center within the warranty period. In no event shall BW's liability here under exceed the purchase price actually paid by the buyer for the Product.

This warranty does not include:

- fuses, disposable batteries or the routine replacement of parts due to the normal wear and tear of the product arising from use;
- any damage or defects attributable to repair of the product by any person other than an authorized dealer, or the installation of unapproved parts on the product; or
- any product which in BW's opinion, has been misused, altered, neglected or damaged, by accident or abnormal conditions of operation, handling or use.

The obligations set forth in this warranty are conditional on:

- proper storage, installation, calibration, use, maintenance and compliance with the product manual instructions and any other applicable recommendations of BW;
- the buyer promptly notifying BW of any defect and, if required, promptly making the product available for correction. No goods shall be returned to BW until receipt by the buyer of shipping instructions from BW; and
- the right of BW to require that the buyer provide proof of purchase such as the original invoice, bill of sale or packing slip to establish that the product is within the warranty period.

THE BUYER AGREES THAT THIS WARRANTY IS THE BUYER'S SOLE AND EXCLUSIVE REMEDY AND IS IN LIEU OF ALL OTHER WARRANTIES, EXPRESS OR IMPLIED, INCLUDING BUT NOT LIMITED TO ANY IMPLIED WARRANTY OF MERCHANTABILITY OR FITNESS FOR A PARTICULAR PURPOSE. BW SHALL NOT BE LIABLE FOR ANY SPECIAL, INDIRECT, INCIDENTAL OR CONSEQUENTIAL DAMAGES OR LOSSES, INCLUDING LOSS OF DATA, WHETHER ARISING FROM BREACH OF WARRANTY OR BASED ON CONTRACT, TORT OR RELIANCE OR ANY OTHER THEORY.

Since some countries or states do not allow limitation of the term of an implied warranty, or exclusion or limitation of incidental or consequential damages, the limitations and exclusions of this warranty may not apply to every buyer. If any provision of this warranty is held invalid or unenforceable by a court of competent jurisdiction, such holding will not affect the validity or enforceability of any other provision.

### Warranty Registration

[www.honeywellanalytics.com/support/product-registration](http://www.honeywellanalytics.com/support/product-registration)



# Troubleshooting

This section includes the troubleshooting instructions for the product.

## Compliance Tests

---

### The sensor test fails during bump test or calibration.

The calibration gas cylinder is not connected to an inlet.

*Connect an appropriate calibration gas cylinder to the inlet.*

The calibration gas cylinder is empty.

*Replace the empty calibration gas cylinder.*

The end plate is not attached.

*Attach an end plate to the last module in a gang (or to an individual module).*

See **Attach the End Plate**.

*If the end plate is damaged or missing, contact an authorized distributor.*

The inlet key is not properly connected.

*To connect the inlet key, see **Inlet Keys**.*

The calibration gas cylinder tubing is too long.

*Disconnect the tubing, cut it to a shorter length, and reconnect. See **Connect a Calibration Gas Cylinder**.*

The calibration gas cylinder tubing is damaged.

*Inspect the tubing and replace with new tubing, if necessary.*

The modules are not properly connected.

*Lift the latch arm between modules and push the modules firmly together.*

See **Work Plan: Assemble Gangs of up to Five Connected Modules**.

The gas type and/or concentration settings on the module are not configured to match the calibration gas cylinder.

*To configure gas inlets:*

1. *From the menu, select Settings.*
2. *Select an inlet, and verify that the gas type and concentration settings match the connected calibration gas cylinder. See **Configure Gas Inlets**.*

### The audible alarm test fails during bump test or calibration.

The detector's audible alarm hole is blocked.

*To clean the audible alarm hole:*

1. *Remove the detector from the module.*
2. *Clean the audible alarm hole with a soft, damp cloth or an appropriate cleaner that is specified in the detector operator manual.*

### The visual alarm test fails during bump test or calibration.

The detector's alarm LED windows are dirty.

*To clean the indicators:*

1. *Remove the detector from the module.*
2. *Clean the alarm LED windows with a soft, damp cloth or an appropriate cleaner that is specified in the detector operator manual.*

The module is under too much light.

*Move the module away from a direct light source.*

**Detectors fail to zero.**

Background gas is present.

*Connect the purge inlet to a clean air supply.*

A calibration gas cylinder is connected to the purge inlet.

*Disconnect the calibration gas cylinder from the purge inlet, and connect the cylinder to a gas inlet. See **Connect a Calibration Gas Cylinder**.*

## Detectors

---

### The detector firmware is not updated after a new firmware update file is transferred via USB flash drive.

The file name is incorrect.

*The firmware update file name is not the same as the downloaded file name. Rename the file name to match the name of the downloaded firmware update file, or download a new firmware update file. See **Update Firmware**.*

The file is not in the System folder on the USB flash drive.

*Create a folder called System on the USB flash drive. Move the file to the System folder. See **Updating Module Firmware via USB Flash Drive**.*

Update Detector Firmware is not enabled via Fleet Manager II software.

*Use software to enable detector firmware updates. Transfer the modified configuration file to the appropriate modules.*

The firmware on the detector is the same version as the firmware update.

*Verify that the firmware file on the USB flash drive is the most recent firmware version. See **Update Firmware**.*

### The detector time is incorrect, or is not the same as the module time.

Use software to enable the Synchronize detector time and date option.

*See **Adjust Time and Date Settings via Fleet Manager II Software** and in the Automated Operations section, select Synchronize detector time and date.*

The module time was not set via Fleet Manager II.

*Use software to set the module time. See **Adjust Time and Date Settings via Fleet Manager II Software**.*

The time zone is incorrect.

*Use software to select the time zone. See **Adjust Time and Date Settings via Fleet Manager II Software**.*

### Daylight Savings Time did not work

The module Daylight Savings Time was not set.

*Use software to automatically adjust clock for Daylight Savings Time. See **Adjust Time and Date Settings via Fleet Manager II Software**.*

The time zone is incorrect.

*Use software to select the time zone. See **Adjust Time and Date Settings via Fleet Manager II Software**.*

The module time was not set via Fleet Manager II.

*Use software to set the module time. See **Adjust Time and Date Settings via Fleet Manager II Software**.*

## Modules

---

### Modules do not assemble into a gang.

The O-rings on the inlet connections are dry.

*Apply the supplied lubricant to the O-rings. See **Work Plan: Assemble Gangs of up to Five Connected Modules**. To order additional lubricant, contact an authorized distributor.*

### Modules do not attach to mounting DIN rails.

The DIN rail mounting screws are too tight.

*Loosen the mounting screws slightly, and then mount the modules. See **Mount on Parallel DIN Rails**.*

### Modules in a gang do not activate when the power is connected.

The modules are not firmly connected.

*Verify that connected modules are firmly connected and latch arms are lowered and locked. See **Work Plan: Assemble Gangs of up to Five Connected Modules**.*

The module connector is damaged.

*Inspect the module connector pins. If the pins are damaged, contact an authorized distributor.*

### You smell gas in the vicinity of the module.

A demand flow regulator is not correctly connected to the calibration gas cylinder.

*Check the connection between the regulator and the gas cylinder.*

The exhaust tubing is not attached or is blocked.

*Verify that the exhaust tubing is firmly attached and free of defects or obstructions. See **Connect the Exhaust Tubing**.*

The exhaust tubing is not venting to an appropriate area.

*Verify that the exhaust tubing is not connected to a negative pressure system. Verify that the free end of the tubing is positioned to vent to an appropriate area.*

### The LCD changes to red and a pump alarm error message is displayed.

The calibration gas cylinder is empty.

*Replace the calibration gas cylinder with a filled calibration gas cylinder.*

The tubing that connects the module to the calibration gas cylinder is too long.

*To shorten the tubing:*

- 1. Disconnect the tubing.*
- 2. Cut it to a shorter length.*
- 3. Move the calibration gas cylinder closer to the module, and attach the tubing.*

The tubing that connects the module to the calibration gas cylinder is blocked.

*Verify that the tubing is free of defects and obstructions. Replace if necessary.*

The diameter of the tubing that connects the calibration gas cylinder to the module is too small.

*Replace the tubing with tubing that has a larger diameter.*

## The LCD changes to red and a hardware error message is displayed.

*The inlet key was removed while the module was activated. To insert the inlet key:*

1. *Disconnect the module power supply.*
2. *Insert the inlet key.*
3. *Connect the power supply.*

*If the error persists, contact Honeywell Analytics.*

## The module does not recognize a USB flash drive.

The USB port is disabled in software.

*In software, verify the module is configured to support USB file transfers. Modify the configuration file in if necessary, and then transfer the updated file to one or more modules. See **Transferring the Configuration File to a Module via USB Flash Drive**.*

The USB flash drive is damaged.

*In software, verify the module is configured to support USB file transfers. Use a different USB flash drive to transfer the file. See **Transferring the Configuration File to a Module via USB Flash Drive**. If problems persist, contact Honeywell Analytics.*

## The module configuration is not updated when a new configuration file is transferred via USB flash drive.

The file name is incorrect.

*Change the configuration file name to ICF\_00\_000.cof.*

The file is not in the System folder on the USB flash drive.

*Create a folder called System on the USB flash drive. Move the configuration update file to the System folder.*

## The module displays the message Firmware not supported.

You plugged a cradle in the module that is not compatible with the module firmware version.

*Remove the incompatible cradle, and replace it with a cradle that is compatible with the module firmware version. Follow these steps:*

1. *Disconnect the power cord from the AC outlet.*
2. *Remove the cradle that caused the message.*
3. *Install a compatible cradle to the (most likely the cradle you were using before the error message). See **Replace Detector Cradle and Calibration Insert**.*
4. *Connect the power cord to the AC outlet.*

The firmware version is not compatible with the cradle you want to use.

*Put the old cradle in, update the module firmware to a compatible version for the cradle you want to use, and install the new cradle. Follow these steps:*

1. *Disconnect the power cord from the AC outlet.*
2. *Remove the cradle that caused the message.*
3. *Plug in a compatible cradle to the circuit board (most likely the cradle you were using before the error message).*
4. *Update the module firmware to a compatible version for the cradle you want to use. See **Update Firmware**.*

5. *Install the new cradle. See **Replace Detector Cradle and Calibration Insert**.*
6. *Connect the power cord to the AC outlet.*

### **The module firmware is not updated when a new firmware update file is transferred from USB flash drive.**

The file name is incorrect.

*The firmware update file name is not the same as the downloaded file name. Rename the file name to match the name of the downloaded firmware update file, or download a new firmware update file. See **Update Firmware**.*

The file is not in the System folder on the USB flash drive.

*Create a folder called System on the USB flash drive. Move the firmware update file to the System folder.*

The firmware on the module is the same version as the firmware update.

*Verify that the firmware file on the USB flash drive is the most recent firmware version. See **Update Firmware**.*

### **The module firmware is not updated on modules that are connected in a gang.**

Modules in the gang are busy.

*Remove detectors from all modules in the gang. The firmware update is not installed when modules in the gang are busy (for example, when a detector is in a module).*

## Network Connections

---

### The Login web page does not display.

Your computer is not connected to the network.

*Connect your computer or mobile device to the network. See **Managing Network Settings through an Internet Browser**.*

The module is not connected to the network.

*Verify that the module is connected to an active network outlet. When one module is connected to a network, the green LED on the module network port is lit and the network symbol is displayed on the LCD. When a gang of modules is connected to a network, the green LED on the module network port on the first module is lit. The network symbol is displayed on the LCD of each module in the gang. See **Connect the Module to a Network**.*

The module is connected to a network outlet that is not activated.

*Contact your network administrator.*

Your web browser does not support JavaScript

*Honeywell recommends that you use Internet Explorer to access the module web page.*

JavaScript is disabled in Internet Explorer.

*To enable JavaScript in Internet Explorer:*

1. *Start Internet Explorer*
2. *On the Menu bar, click Tools > Internet options to display the Internet Options dialog box.*
3. *Select the Security tab.*
4. *Click Custom level to open the Security Settings dialog box.*
5. *Scroll to Scripting, and under Active Scripting, select Enable or Prompt.*



## Calibration of PID Sensor

---

### 3-point calibration disabled and user has configured one inlet for PID:

Configured inlet is treated as Span Low gas concentration and calibration is performed

### 3-point calibration disabled and user has configured more than one inlet for PID:

IDOX will calculate optimum inlet and is treated as Span Low gas concentration and calibration is performed

### 3-point calibration enabled and user has configured one inlet for PID:

Configured inlet is treated as Span Low gas concentration and 2- point calibration is performed.

If Span Low calibration is pass, Calibration test results on IDOX display is shown with green color with ? ICON, which indicates Span high calibration is not performed. On the Ultra device cal date and cal status is not updated.

If Span Low calibration is failed, Calibration test results on IDOX display is shown with red color with ✘ ICON. and on the Ultra device cal status is updated as fail.

### 3-point calibration enabled and user has configured two or more inlets for PID:

IDOX will calculate optimum inlet for both Span Low gas concentration and span high gas concentration and calibration is performed.

If Span Low calibration is failed, Calibration test results on IDOX display is shown with red color with ✘ ICON. And Span High calibration is also aborted automatically. and on the Ultra device cal status is updated as fail.

If Span Low calibration is pass, IDOX will proceed for Span High calibration.

If Span high calibration is failed, Calibration test results on IDOX display is shown with red color with ✘ ICON. and on the Ultra device cal status is updated as fail.

If Span high calibration is pass, Calibration test results on IDOX display is shown with green color with ✔ ICON, and on the Ultra device cal date and cal status is updated as pass.

Connect the CO gas tank to the second IntelliDoX inlet and connect the VOC (isobutylene) gas tank at 300ppm to the first IntelliDoX inlet.

Initiate calibration and apply CO and VOC (isobutylene) gases.

# Safety Suite Device Configurator Software



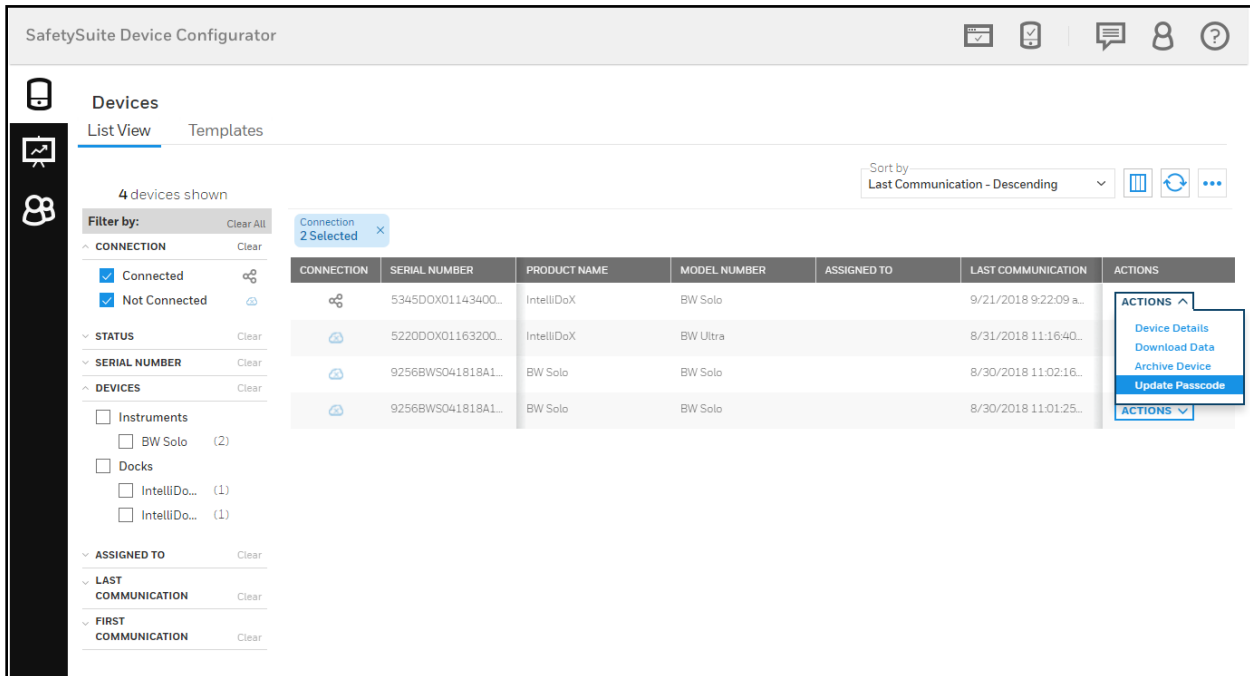

## Connect an IntelliDoX to the Safety Suite Device Configurator

The Safety Suite DC requires entering the Network Passcode to add an IntelliDoX. This process is a onetime only. Safety Suite DC will need to send the IntelliDoX the network passcode to verify the connection.

1. Click on the User profile icon  and select **Settings**.
2. In the **Add IntelliDox for manual detection** field, enter the IP address of the IntelliDox, and then click **SAVE**. Wait until Progress bar is refreshed.
3. Click the **Devices** Tab, and then verify that the IntelliDox is added in the list of devices.
4. From the **ACTIONS** column, expand **ACTIONS** and select **Update Passcode**.



The screenshot displays the 'SafetySuite Device Configurator' interface. On the left, there is a sidebar with navigation icons and a 'Devices' section. The main area shows a list of 4 devices. The 'Filter by' section is set to 'CONNECTION' with 'Connected' and 'Not Connected' options. The table below shows the device details:

CONNECTION	SERIAL NUMBER	PRODUCT NAME	MODEL NUMBER	ASSIGNED TO	LAST COMMUNICATION	ACTIONS
	5345DOX01143400...	IntelliDoX	BW Solo		9/21/2018 9:22:09 a...	<b>ACTIONS</b> ^ Device Details Download Data Archive Device Update Passcode <b>ACTIONS</b> v
	5220DOX01163200...	IntelliDoX	BW Ultra		8/31/2018 11:16:40...	
	9256BWS041818A1...	BW Solo	BW Solo		8/30/2018 11:02:16...	
	9256BWS041818A1...	BW Solo	BW Solo		8/30/2018 11:01:25...	

5. Enter a 6-digit network Passcode, and then click **Save**. The Network passcode status is displayed. The IntelliDox is added, and the Safety Suite DC can access data.

## Adjust the Time and Date

---

Adjust the module's time and date settings automatically via the Safety Suite Device Configurator. For connected modules, you must adjust time and date settings for each module in the group.

**NOTE:** You must use Safety Suite Device Configurator when you want to:

- Configure a module or detector to adjust for Daylight Savings Time
- Synchronize a module time and date to a PC
- Configure compatible detectors to synchronize time and date settings to the module after inserting the device.

4. From the main window, click **IntelliDox Configuration**.
5. From the IntelliDox Configuration panel, click **DATE & TIME**, and then select **SYNCHRONIZE WITH SERVER**. A *Date and time sync successfully* message is displayed.



## Set the Time Zone

---

1. Open the Safety Suit Device Configurator software, and then log in with your **username** and **password**.
2. Click the **Devices** tab, and verify the IntelliDoX you want to communicate with is added and visible.
3. From the **ACTIONS** column, expand **ACTIONS** and select **Device Details**. The IntelliDoX Configuration panel is displayed.
4. Click **Language – Timezone Preferences** and select the appropriate time zone for your IntelliDoX. You can also check the **Automatically adjust clock for Daylight Savings Time** check box if needed.

## Transfer data files

---

You can use the Safety Suit Device Configurator software to transfer data from modules that are activated and connected to a network. Data files transferred via Safety Suit Device Configurator are added to the Safety Suit Device Configurator database. After the data files are transferred, you can use the Safety Suit Device Configurator to manage data and prepare custom reports.

1. Open the Safety Suit Device Configurator software, and then log with your **username** and **password**.
2. Click the **Devices** tab.
3. From the **ACTIONS** column, expand **ACTIONS** and select **Download Data** to download device's datalog and event logs.  
You can also download the device's datalog and event by selecting **Device Details > Download Data**.
4. Select **Download Test Data** to download the Test Records from IntelliDoX. A *Downloading data* message is displayed.

## Download data from a file

---

1. Open the Safety Suit Device Configurator software, and then log with your **username** and **password**.
2. From the top navigation bar, click on the three dots button  and select **Download IntelliDox data**.
3. Select the folder from where to download the data, and then click **Download**.

## Update the Firmware

---

When a new Firmware version is available, the user will get an **UPDATE** button under the FIRM VERSION section in the IntelliDox Configuration panel.



## Configure the IntelliDox and the device

1. From the **ACTIONS** column, expand **ACTIONS** and select **Device Details** to download device's datalog and event logs. The Safety Suite Device Configurator will retrieve the configuration from the IntelliDox.
2. In the IntelliDox Operations Configuration panel select the following:
  - a) Select **Passcode Protected**
  - b) Enter the 4-digit passcode in the **PASSCODE** box.
  - c) Select the required Automatic operations.
  - d) Click **SAVE** to save the configuration to IntelliDox.

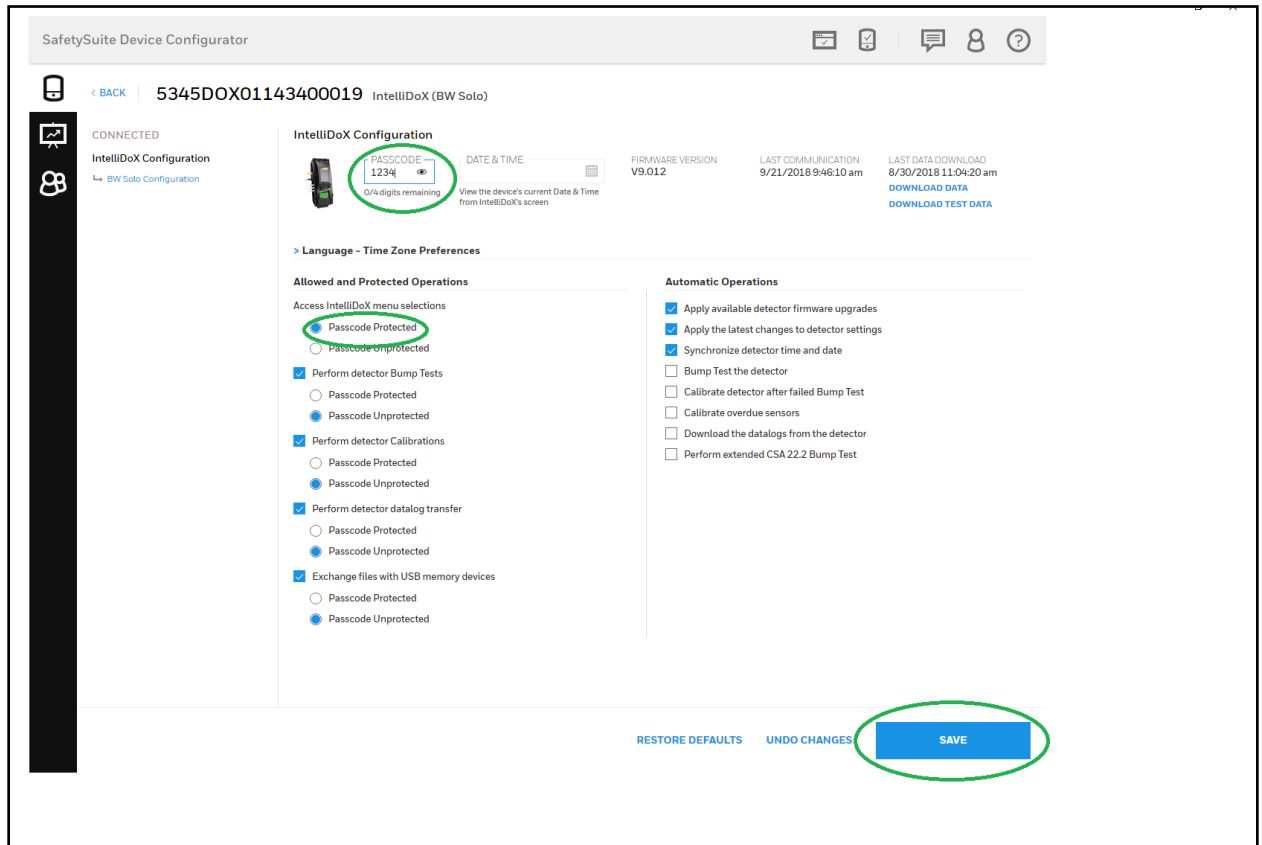

3. Go to the Device Configuration page and update the required **Details Section** information.
4. Go to the **Sensors** section. Click on the  icon for the sensor you want to change, and then set the sensor configuration. Finally, click **SAVE**.

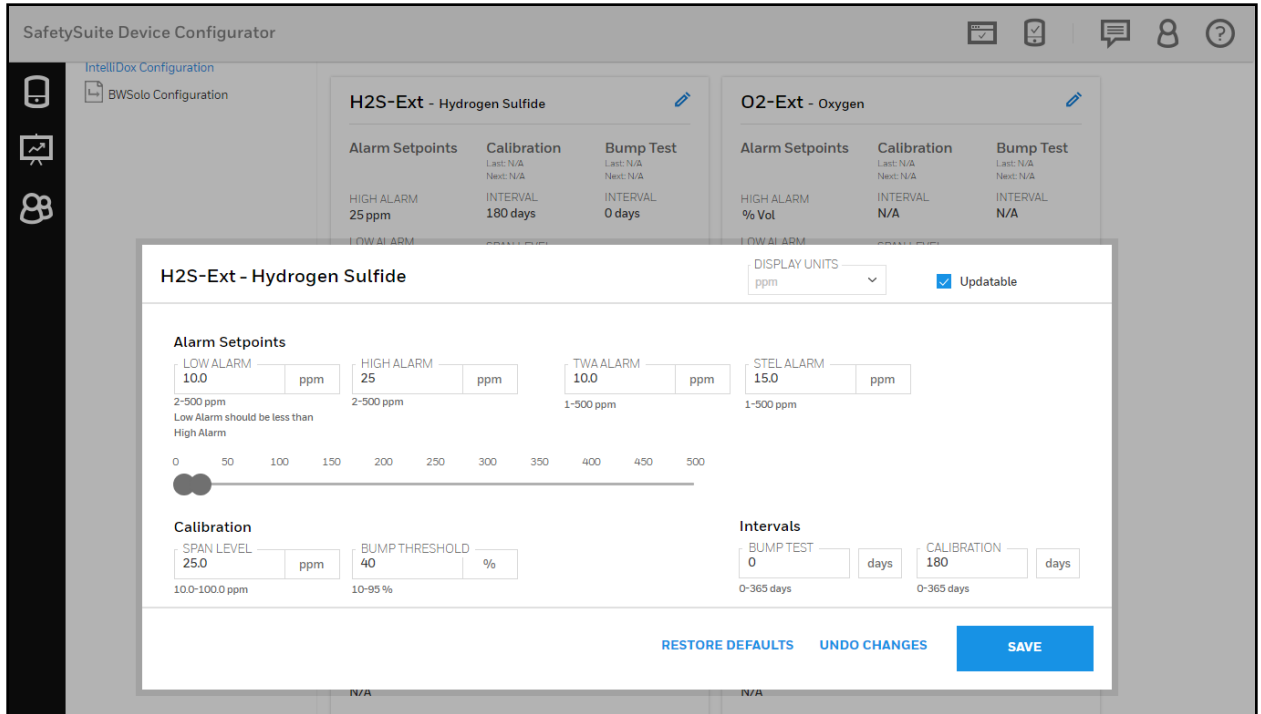

5. Go to the **Settings** section. And adjust the device configuration. Click **SAVE**. The Safety Suite Device Configurator will display whether the configuration is successfully saved or not.

# Glossary

The following term and abbreviations are used in this document.

## A

---

### AC

Alternating current. An electric current that is usually accessed by plugging a power cord into a wall outlet.

## B

---

### Bump test

A compliance test that confirms the detector's ability to respond to target gases by exposing the detector to a known gas concentration. Other procedures that are specified to occur automatically when the detector is inserted into a docking module may be performed in conjunction with the bump test.

## C

---

### Calibration

A two-step compliance test that determines the measurement scale for the detector's response to gas. In the first step, a baseline reading is taken in a clean, uncontaminated environment. In the second step, the sensors are exposed to known concentrations of gas. The detector uses the baseline and known gas concentrations to determine the measurement scale.

### CD

Compact disc. A computer-readable disc.

### Compliance test

A compliance test is a procedure designed to confirm that a product or process meets a defined set of standards.

## D

---

### Datalog

A datalog is a file that contains detailed, date-stamped records related to detector operations and configuration settings. The datalog is continuously updated. Records that span the operating life of the detector are retained. For more information, refer to the appropriate detector operator manual.

### DC

Direct current. DC is an electric current that is provided by power sources such as batteries and solar cells.

### DHCP

Dynamic Host Configuration Protocol. DHCP is a network protocol for assigning an unused IP address to a device that connects to a network.

### DIN rail

A DIN rail is a metal strip that is used to mount industrial equipment and devices.

### Dynamic IP address

A temporary IP address that is automatically assigned to a device when it connects to a network, and then automatically released when it disconnects.

## E

---

### Event log

An event log is a file that contains detailed, time-stamped records data related to gas events, compliance tests, and auto zero operations. The event log is updated when an event occurs. A specified number records for the most recent events is retained. For more information, refer to the appropriate detector operator manual.

## F

---

### FastBump

FastBump is an accelerated compliance test that confirms a detector's ability to respond to target gases by exposing the detector to a known gas concentration. FastBump may only be performed with a compatible detector via a module that is configured for FastBump. When a compatible detector is inserted into the configured module, FastBump and event log transfer start automatically once the detector is recognized. Other procedures specified to occur automatically on insertion are suppressed.

### Firmware

Permanent software or coded instructions that are programmed into read-only memory on a device. Firmware provides the operating instructions for a device, and may be updated periodically to enhance device performance.

### Fleet Manager II

A proprietary, Windows-based software developed by Honeywell to configure and manage docking modules, calibration, bump tests, and datalogs. Fleet Manager II is available for download from [www.honeywellanalytics.com](http://www.honeywellanalytics.com)

## G

---

### Gang

A group of two (2) to five (5) connected IntelliDoX modules. Modules that are connected share power, network and gas connections.

**H**

---

**Hibernation**

Hibernation is a factory-installed feature that is available for certain detectors manufactured by Honeywell. When Hibernation is activated, all detector safety functions are disabled and the operating life countdown is suspended. Hibernation may be activated when the detector is not required for operational service for periods from 7 days up to one year. Hibernation may extend the service life of the detector, limited by the specified maximum operating life of the detector. It does not extend the specified maximum operating life of the detector.

**I**

---

**I.D.**

I.D. is a measurement that represents the inner diameter of a tubing or pipe.

**Instrument Management System**

An instrument management system (IMS) is a network of IntelliDoX automated test and calibration stations, Fleet Manager II instrument management software, compatible detectors, and other integration equipment.

**IntelliDoX Docking Module**

An IntelliDoX docking module (module) is an automatic bump test and calibration docking station for use with portable gas detectors manufactured by Honeywell.

**IP**

Internet Protocol. A protocol that is used to send data from one device to another on the Internet. Each device connected to an IP network must have at least one unique IP address to distinguish it from other connected devices.

**IP address**

A unique value that is assigned to a device when it connects to a network that uses the Internet Protocol for communication. Each device connected to an IP network must have at least one unique IP address to distinguish it from other connected devices.

**IR**

Infrared. IR is an invisible radiant energy that can be used for short-range wireless communications between enabled devices.

**L**

---

**LCD**

Liquid crystal display. LCD is a technology that is commonly used for display screens on mobile digital devices.

**M**

---

**MAC**

Media Access Control. MAC is a data communication protocol that supports communication between nodes on the same or other networks.

**MAC address**

A unique code assigned to any device that has built-in networking capability. The MAC address is assigned at the factory, by the device manufacturer.

**Multi-inlet key**

A removable insert that is compatible with the IntelliDoX Docking Module. When the multi-inlet key is inserted, up to four gas inlets may be configured for use in the module.

**N**

---

**Normal atmosphere**

A normal atmosphere is a fresh air environment with 20.9% v/v oxygen (O<sub>2</sub>) that is free of hazardous gas

**O**

---

**Operating Life**

The period of operational use required to attain the specified operating limit. Operating life includes normal operating time, alarm time, and all types of idle time.

**P**

---

**PDF**

Portable Document Format. PDF is a file format developed by Adobe as a means to distribute compact, platform-independent documents. To view PDF files, download and install Adobe Reader from [www.adobe.com](http://www.adobe.com)

**PPE**

Personal protective equipment

**PPM**

Parts per million, a measure of concentration.

**R**

---

**Reboot**

Restart the operating system for the module

**S**

---

**Safety Suite Device Configurator**

Enables quick and precise management and maintenance of your Honeywell portable gas detector fleet.

**Service Life**

The expected lifetime of a product, as specified by the manufacturer.

**Single-inlet key**

A removable insert that is compatible with the IntelliDoX Docking Module. When the single-inlet key is inserted, one gas inlet may be configured for use in the module.

**Stand-alone**

Individual. A stand-alone module is not connected to any other module.

**Static IP address**

A permanent IP address that is assigned to a device by a network administrator. It is the permanent address for the device, and may be used to identify the device on a network. It is not automatically released when the device disconnects from the network.

**Station**

An area or zone dedicated to a specific activity. A compliance testing station may contain several IntelliDoX modules and gangs of connected modules.

**U**

---

**USB flash drive**

A data storage device that is compatible with USB ports. USB flash drives are removable and portable, and may be used to transfer data between devices that contain USB ports.

**USB port**

Universal Serial Bus. A USB port is a standard connection interface for computers and personal electronics.

**V**

---

**v/v**

Volume percent concentration.

## Contact us

### Canada

BW Technologies LP  
Suite 110, 4411 – 6th Street SE  
Calgary, Alberta, Canada  
T2G 4E8  
Tel: +1.888.749.8878  
+1.800.538.0363 Option 2 > Option 1

### USA

Honeywell Analytics Inc - Formerly BW Technologies  
405 Barclay Blvd  
Lincolnshire IL 60069-3609  
Tel: +1.888.749.8878  
+1.800.538.0363 Option 2 > Option 1

### Europe

Honeywell  
Javastrasse 2  
8604 Hegnau  
Switzerland  
Toll-free: 00800-333-222-44

### Internet

[TX0J\\_InsideSales@honeywell.com](mailto:TX0J_InsideSales@honeywell.com)  
[www.honeywellanalytics.com](http://www.honeywellanalytics.com)

### Other Countries

Honeywell  
Toll-free: 1-403-248-9226

### Warranty Registration

[www.honeywellanalytics.com/support/product-registration](http://www.honeywellanalytics.com/support/product-registration)

© Honeywell, 2019  
All rights reserved

**Honeywell**