



# i-CON TRACE®

IoT soldering station

**Operating instructions: 3BA00252-01**

Ersa GmbH  
Leonhard-Karl-Str. 24  
97877 Wertheim  
www.ersa.de  
Rev. 1  
Printing date: 30/11/2021

Phone +49 9342/800-136  
Fax +49 9342/800-132  
Mobile +49 171 241 846 8  
service-ersa@kurtzrsa.de



# Table of contents

<b>1</b>	<b>For your safety .....</b>	<b>5</b>
1.1	ESD sensitive components .....	9
1.2	FCC USA info.....	9
<b>2</b>	<b>Introduction .....</b>	<b>10</b>
2.1	Intended use .....	10
2.2	Copyright and liability .....	10
2.3	Warranty.....	10
<b>3</b>	<b>Technical data .....</b>	<b>12</b>
3.1	Electrical connection .....	12
3.2	General data.....	12
3.3	Properties.....	12
3.4	Server PC minimum requirements.....	13
3.5	Web browser minimum requirements .....	13
3.6	WLAN topology .....	13
<b>4</b>	<b>Transport, installation, storage, disposal .....</b>	<b>14</b>
4.1	Scope of delivery.....	14
4.2	Handling and storage info .....	14
4.3	Disposal.....	15
<b>5</b>	<b>Commissioning .....</b>	<b>16</b>
5.1	Prerequisites for commissioning.....	16
5.2	Network connection: Work steps and methods .....	17
5.3	The network ports.....	18
5.4	control elements and connectors .....	19
5.5	Preparing the soldering station to be switched on for the first time.....	20
5.6	Switching on the soldering station for the first time .....	22
5.7	Switching OFF:.....	23
5.8	Establishing a WLAN connection between the soldering station and a network .....	24
5.9	Establishing a LAN connection between the soldering station and a network.....	27
<b>6</b>	<b>Function description.....</b>	<b>30</b>
6.1	Information on the LED indicators .....	30
6.2	Changing soldering tips.....	31
<b>7</b>	<b>Service and maintenance.....</b>	<b>37</b>
7.1	Error messages and error codes .....	37
7.2	Error treatment.....	38
7.3	Cleaning and Maintenance .....	42

7.4	Defaults .....	44
<b>8</b>	<b>Spare/wear parts and accessories .....</b>	<b>45</b>

# 1. For your safety

## Safety Notes

Ersa products are developed, manufactured and tested in compliance with essential safety requirements.

### Residual risks nevertheless remain!

You should therefore read these instructions before you start to operate the tool for the first time. The instructions will help you operate the soldering tool safely as well as becoming acquainted with all functions and properly using them.

The enclosed information leaflet "Safety Notes" is also part of the safety instructions to be adhered to.

National and international safety, health and occupational safety regulations must be complied with.

### DANGER

#### Danger due to improper operation



- a) Comply with the operating instructions!
- b) Every person involved in the commissioning, operation and/or maintenance of the soldering tool must have read and understood the "Safety Notes" and chapter "For your safety", as well as the chapters in these operating instructions relating to the above tasks!
- c) For the operation of the soldering tool, the local safety and accident prevention regulations must also be adhered to!
- d) Always keep these instructions near the soldering tool, in a place accessible to all users at all times!

### CAUTION

#### Risk of accidents! Do not damage the components of the soldering tools!



- a) Check all components before each use!
- b) Do not operate the soldering station if it is damaged!
- c) Repairs may only be carried out by a specialist or the manufacturer!
- d) Use only original Ersa consumables and spare parts.
- e) Do not perform any retrofitting!  
Otherwise, the warranty will become null and void.
- f) Never operate the soldering iron without the soldering tip, overheating hazard!

 **WARNING****Fire hazard due to hot soldering tool!**

- a) Before switching on the soldering station, all easily combustible objects, liquids and gases must be removed from the working area!
- b) Always place the soldering tool in the supporting stand when not in use!
- c) Disconnect the soldering station from the mains after use!

 **CAUTION****Risk of burns! The soldering iron gets hot immediately after it is switched on!**

Never touch the hot soldering tip or the hot heating element directly!

 **WARNING****Danger of electric shock when soldering!**

- a) Carry out soldering work only on de-energised parts!
- b) Do not expose the soldering station and soldering iron to large mechanical loads!
- c) Do not immerse the soldering tool in liquids to cool it off!

 **WARNING****Possible danger of fire or property damage!**

Danger of heat accumulation if ventilation slots are covered!

- a) Never cover the ventilation slots of the soldering station!

 **CAUTION****Wear protective equipment!**

During soldering, hot solder or corrosive flux material can splatter from the solder joint. Avoid getting solder or flux material in the eyes or on the skin by wearing protective equipment!

- a) Adhere to the company's internal regulations for protective clothing!
- b) Adhere to the safety data sheets for the solder and flux material used!

 **WARNING****Dangerous electrical voltage!**

Death or very serious injuries due to electric shock!

- 
- a) In the event of faults in the electrical power supply, switch off the soldering station immediately!
  - b) Work on electrical parts may only be carried out by a qualified electrician or by persons instructed in electrical engineering under the direction and supervision of a qualified electrician in accordance with the electrotechnical regulations!
  - c) Never open the device!
  - d) Only use original fuses with the prescribed current rating!
  - e) Only use voltage-insulated tools!
  - f) Protect the connecting cable:  
Do not use the connecting cable to pull the mains plug or to carry the device!  
Keep connecting cables clear of heat, oil or sharp edges. Replace a damaged connecting cable immediately, as this may lead to fires, short circuits and electric shock!

 **CAUTION****Eating and drinking forbidden!**

- 
- ✓ Solders and solder materials are toxic. To prevent them from entering the organism, observe the following:
    - a) Do not eat, drink or smoke in rooms where soldering is taking place!
    - b) Always wash your hands thoroughly after working with solder and flux materials!
    - c) Adhere to the safety data sheets for the solder and flux materials used!

 **CAUTION****Toxic fumes when soldering!**

During soldering, emissions are produced from the solder materials and the assemblies. These emissions are harmful to health. Do not inhale the fumes!

- 
- a) Ensure sufficient ventilation or use a solder fume extraction system!
  - b) Adhere to the safety data sheets for the solder and flux materials used!

 **WARNING****Danger of fire and electric shock!**

Humidity and moisture conduct electricity. This may lead to fires and electric shock.

- a) Protect the device from moisture and humidity!
- b) Do not switch on wet or humid soldering tools!

 **WARNING****Danger of fire due to unattended soldering station!**

- a) Keep any unauthorised people at a safe distance from the soldering station to avoid accidents and burns!
- b) Never leave the soldering station unattended when it is on!
- c) The soldering tool must be placed in the storage position on the support stand provided for this purpose.
- d) After switching off the soldering station, the soldering tool requires time to cool off!

 **CAUTION****Avoid any risk of injury!**

- a) Check the work tool for damage before switching it on!
- b) Operate and store the work tool only under the ambient conditions specified in the data sheet!
- c) Service and clean the work tool as provided for in the operating instructions!
- d) Keep the workplace tidy!

 **CAUTION****Risk of accidents! Danger due to use by unauthorised persons!**

- a) Ensure that unauthorised persons, especially children, do not have access to the soldering station!



## 1.1 ESD sensitive components

### NOTE

#### Working with sensitive components

Some components can be damaged by electrostatic discharges. Observe the warnings on the packaging or ask the manufacturers or suppliers. To protect these components use an ESD safe workplace (ESD = electrostatic discharge)



This environment can be created with parts that comply with the IEC61340-5-1 standard.

The conductive ESD work base is connected via an ESD earthing plug (with built-in 1 MOhm safety resistor) to a protective earth contact (PE) of the same socket strip to which the protective earth conductor (PE) of the i-CON TRACE<sup>®</sup> is connected (see Fig. 1).

Both ESD earth lines connected to the ESD work base must have integrated 1 MOhm safety resistors.

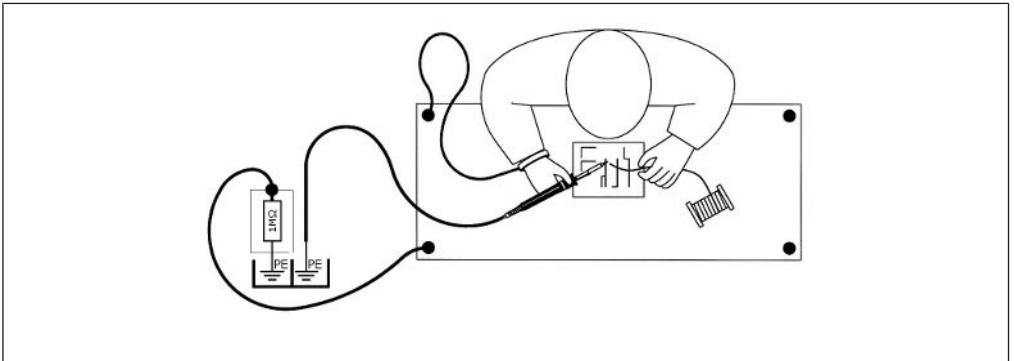

Fig. 1: Proper connection: Soldering iron with protection class 1 (protective earth conductor) and ESD earth plug in the same multiple socket outlet

## 1.2 FCC USA info

This device has been tested and found to comply with the limit values for Class A digital devices, pursuant to Part 15 of the FCC rules.

These limit values aim to provide reasonable protection against harmful interference when the device is operated in a commercial environment. This device generates, uses and can even radiate radio frequency energy. If it is not installed and used in accordance with the operating instructions, it can cause radio traffic interference. Operating this device in a residential area can cause interference. In this case, the user shall remedy the interference at their own expense.

## 2. Introduction

### 2.1 Intended use

The soldering tool i-CON TRACE® was designed state-of-the-art and according to approved technical safety regulations. However, residual risks may originate from the soldering tool, especially if it is operated improperly by untrained personnel or used for purposes other than those it is intended for.

The soldering station i-CON TRACE® is intended for industrial use in closed rooms. The tool is designed exclusively for soft soldering. Any other further use shall be regarded as improper. The manufacturer/supplier is not liable for any damage resulting therefrom. Intended use shall also include adhering to these operating instructions as well as to the safety provisions contained therein and enclosed with the product.

### 2.2 Copyright and liability

These Operating Instructions have been drawn up with utmost care by Ersä. However, no warranty can be given covering content, completeness and quality of specifications in this manual. The table of contents is updated and adapted to current conditions.

All the data contained in these operating instructions, as well as the information on products and procedures have been ascertained using the latest technical tools to our best knowledge. This information is not binding nor does it relieve the user from their own responsibility to check the device before use.

We shall not be held liable for any infringement of third party rights for applications and procedures without prior express, written confirmation. We reserve the right to make technical changes in order to further improve the product.

Liability for direct, consequential and indirect damage resulting from the purchase of this product is ruled out, to the extent permitted by law. All rights reserved.

We recommend keeping the packaging material for later use. Only with this packaging material can the soldering tool be safely packed, stored, handled or shipped. These operating instructions must neither be reproduced nor modified, transferred or translated into other languages, not even in extracts, without the written approval of Ersä GmbH. This also applies to the relevant software instructions for the “Ersä TRACE Cockpit” web app.

### 2.3 Warranty

Heating elements and soldering or desoldering tips are treated as wear parts and are, therefore, not subject to the warranty. Any return of goods due to material or production faults must be accompanied by a written description of the fault that has occurred, together with a proof of purchase, the receipt of which must be acknowledged.

The warranty period complies with the applicable General Sale, Delivery and Pay-

ment Terms of Ersä GmbH. In the event of improper use and tampering with the device, any warranty and liability claims of the purchaser against the manufacturer shall become void.

### 3. Technical data

#### 3.1 Electrical connection

<b>Designation</b>	
<b>Line voltage (VAC)</b>	<b>220-240</b>
Line frequency (Hz)	50-60
Fuse, slow blowing (A)	0.8
<b>Line voltage (VAC)</b>	<b>110-120</b>
Line frequency (Hz)	50-60
Fuse, slow blowing (A)	1.6
Secondary voltage (VAC)	24

#### 3.2 General data

<b>Station</b>	
Width (mm)	156
Depth (mm)	175
Height (mm)	102
Weight (kg)	approx. 3.1

<b>Supporting stand</b>	
Width (mm)	146
Depth (mm)	135
Height (mm)	94
Weight (kg)	approx. 0.75

#### 3.3 Properties

<b>Designation</b>	
Maximum short-term heating output (W)	150
Mean heating output (W)	80
Temperature range, stepless (°C / °F)	50-450 / 122-842
Regular oscillations in idle state (°C / °F)	<±2 / <±36
Ohmic resistance between soldering tip and earth (Ohm)	<2
Soldering tip to earth stray current (mV eff)	<2

Designation	
Permissible ambient temperature (°C / °F)	0-40 / 32-104
Control technology	SENSOTRONIC (PID behaviour)
Function display	LED
Supply line, PVC, with device pronged socket (m)	2
Protection class	I
According to MIL-SPEC/ESA standard	✓
VDE, EMC tested	✓
Anti-static surface, especially suitable for use in ESD area.	✓
Conformity	CE, CMIIT, EAC
Plug-in soldering tool	i-TOOL TRACE
Optionally available	Ethernet network card for LAN connection

### 3.4 Server PC minimum requirements

Designation	
Processor (GHz)	2,4; Dual Core
Random access memory RAM (GB)	4
Available data storage (GB)	16
Operating systems	Windows 10 (20H2); Windows Server 2016

### 3.5 Web browser minimum requirements

Designation	
Screen resolution at least	1920 x 1080
Firefox	v78.0
Google Chrome	v87.0
Microsoft Edge	v93.0

### 3.6 WLAN topology

Designation	
Frequency range (GHz)	2.4

## 4. Transport, installation, storage, disposal

### 4.1 Scope of delivery



#### NOTE

##### Is delivery not complete or are there any damaged parts?

Check the delivery for completeness. If any items are missing or damaged, contact the supplier!

Designation
Electric soldering station i-CON TRACE® 220-240 V; 0.44 A; 24 V, anti-static or 110-120 V; 0.88 A; 24 V; anti-static
Soldering iron i-TOOL TRACE, 24 V, anti-static
Soldering tip 142CDLF1.6
Heating element for i-TOOL TRACE
Supporting stands for i-TOOL TRACE, anti-static
Dry cleaner
Connecting cable
Brief instructions
Safety Notes

Call up the overview of the i-CON TRACE® soldering tip series 142 via the Internet quick link [142.ersa.de](http://142.ersa.de).

### 4.2 Handling and storage info

#### NOTE

##### Risk of material damage!



- a) Protect the soldering station from the effects of the weather (moisture, damp, sea air, fog) during storage!
- b) During storage in high humidity areas for an extended period of time, the soldering station must be hermetically packed and provided with a dehumidifying agent!
- c) Storage and shipping in the original packaging!

We recommend keeping the packaging material for later use. Only with this packaging material can the soldering tool be safely packed, stored, handled or shipped.

## 4.3 Disposal

### NOTE

#### Disposal of electrical equipment

Waste Disposal in accordance with Directive 2002/96/EC of the European Parliament and of the Council of 27 January 2003 on waste electrical and electronic equipment:



Products marked with the symbol of a crossed out wheeled bin must not be disposed of with unsorted municipal waste. Local authorities have set up special collection points for their disposal. Please check with your city or district council authorities the options available for the separate collection of used equipment. This way, you can make your contribution to the reuse or other forms of use of waste to protect the environment and human health.

### CAUTION

#### Disposal



- ✓ Solder waste is hazardous and must not be disposed of with normal household waste!
- a) Ensure safe and environmentally friendly disposal of the soldering tool!
- b) Provide safe and environmentally friendly disposal of operating/auxiliary materials and replacement parts!
- c) Comply with the municipal waste disposal regulations!

## 5. Commissioning

### 5.1 Prerequisites for commissioning

- a) First find out how to safely operate the soldering station in chapter [For your safety](#) [▶ 5].
- b) Check the contents in the package for completeness. Read more about this in chapter [Scope of delivery](#) [▶ 14]. Should any of the listed components be damaged or incomplete, immediately contact the supplier.

#### Prerequisites of the power and network connection

If more than one soldering station is operated at a workplace, equalisation currents may occur. To avoid this, the mains plugs of all soldering stations must be plugged into the same multiple socket outlet, or directly into adjacent sockets.

If several soldering stations are connected through an Ethernet LAN cable, they must be connected to the same switch to avoid equalisation currents.

#### Two options are available to operate the soldering station through the network with a web browser enabled device

- Operating the soldering station via WLAN.  
In this case, the soldering station must be integrated into an existing WiFi network using a smartphone or tablet with an Android or iOS operating system. The “Ersa TRACE” app must be installed on the mobile device.  
If the soldering station is connected to the WLAN network, it must be operated via WLAN with the “Ersa TRACE Cockpit” web app on a web browser enabled device.
- Operating the soldering station via a LAN cable in the Ethernet network.  
To do so, the optional Ethernet network card must be inserted into the soldering station (see chapter [Spare/wear parts and accessories](#) [▶ 45]).  
If the soldering station is connected to the network through the LAN cable, it must be operated with the “Ersa TRACE Cockpit” web app on a web browser enabled device with LAN connection. A mobile device with the “Ersa TRACE” app to establish the network connection is not required.



## 5.2 Network connection: Work steps and methods

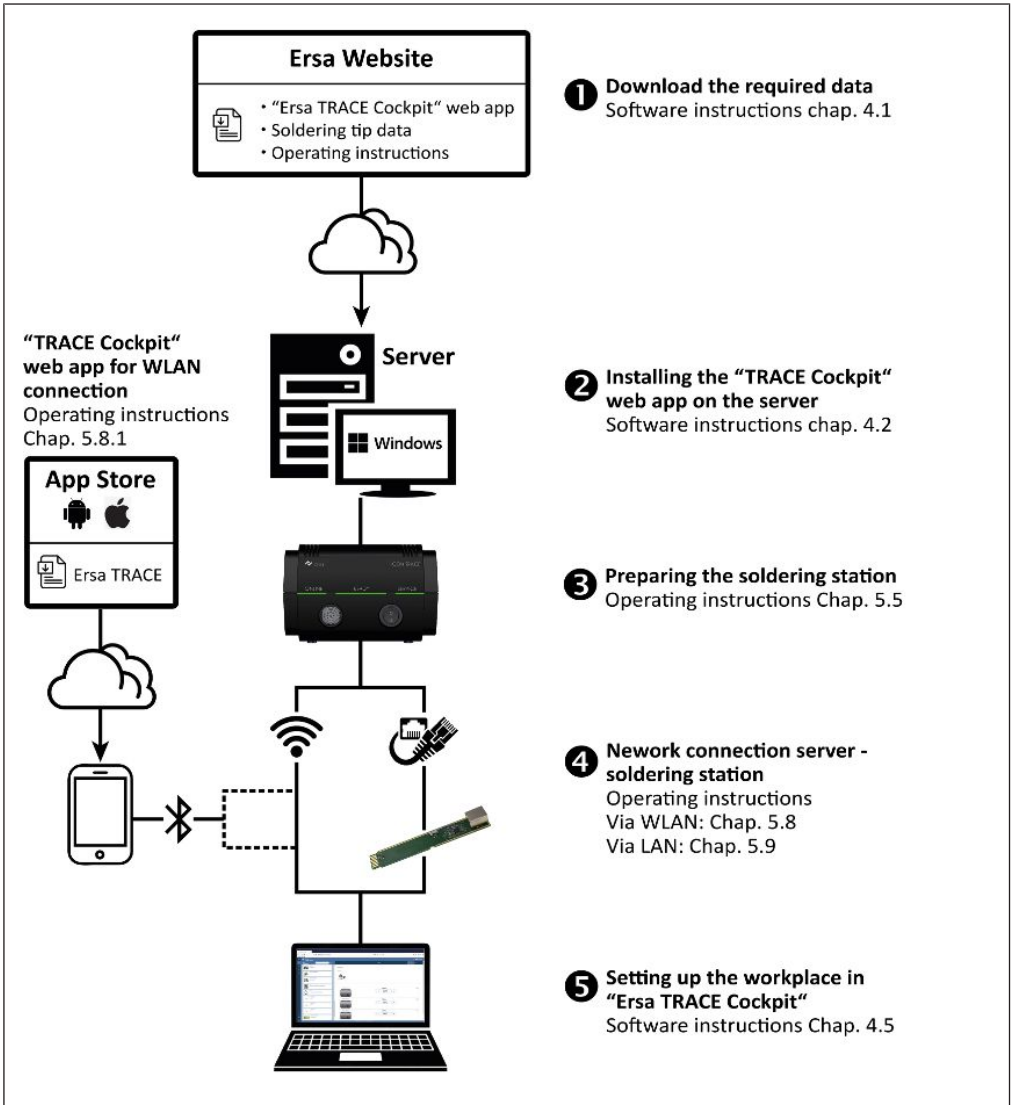

Fig. 2: Network connection: Work steps and methods

### 5.3 The network ports

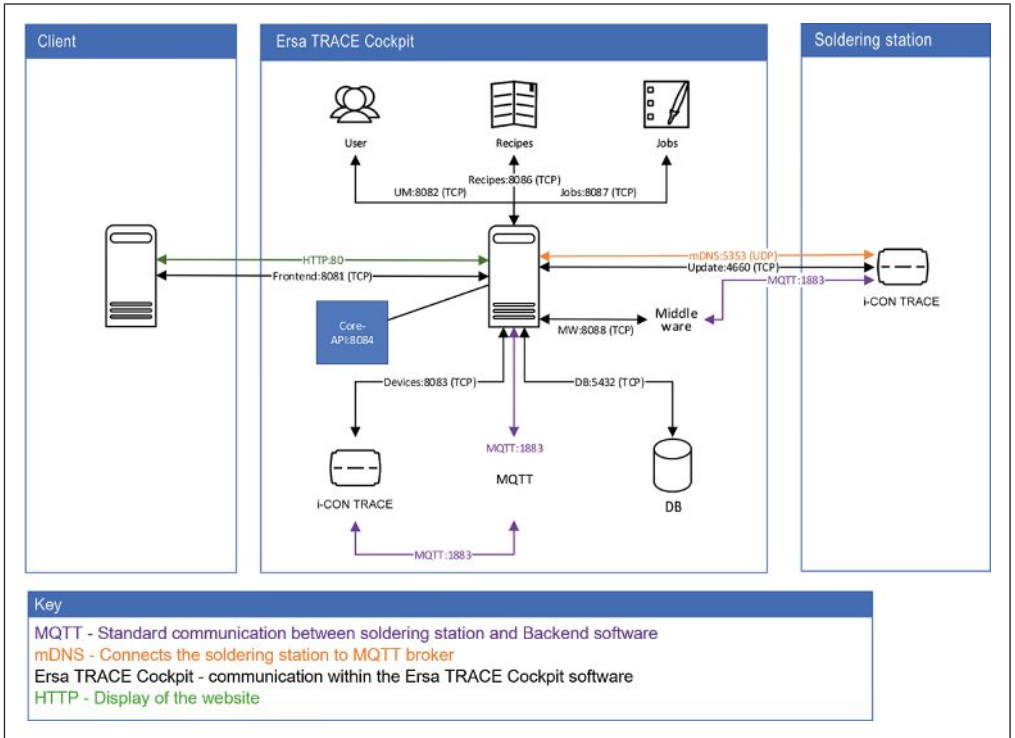

Fig. 3: The ports to be released

## 5.4 control elements and connectors

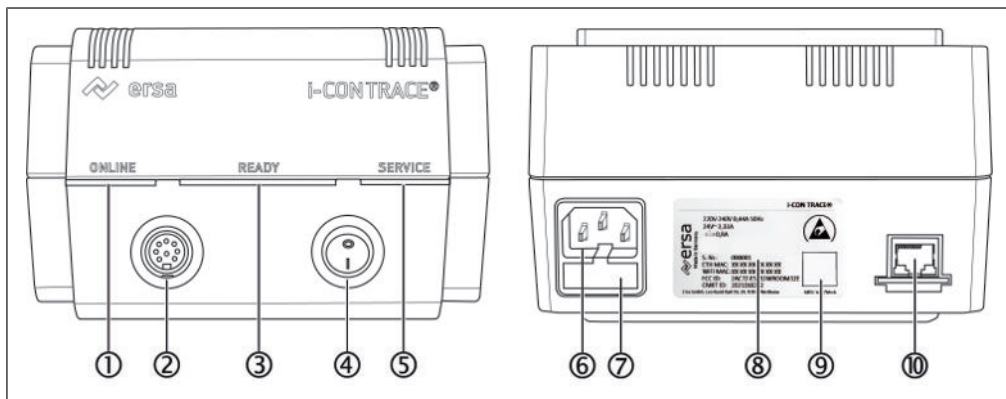

Fig. 4: Front and back view

1	ONLINE LED	6	Network cable connection
2	Soldering iron socket	7	Fuse compartment
3	READY LED	8	Type plate
4	On/Off switch	9	QR code of this soldering station
5	SERVICE LED	10	Optional Ethernet network card

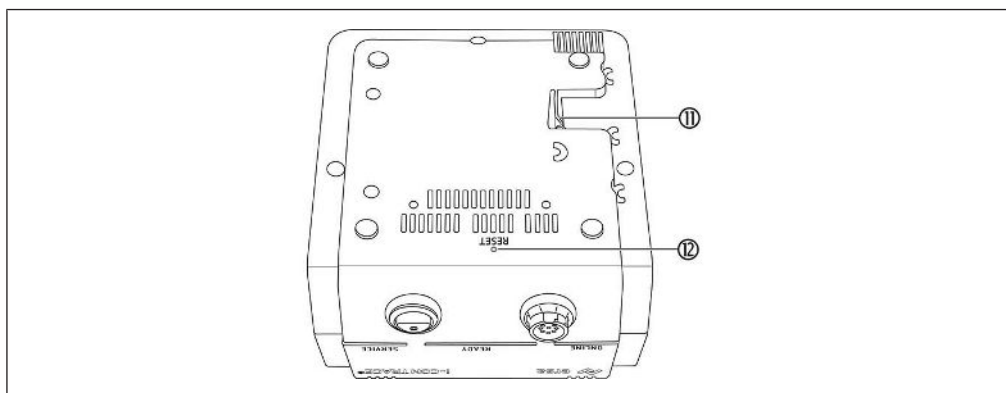

Fig. 5: Bottom side

11	Release lever	12	Reset key
----	---------------	----	-----------

## 5.5 Preparing the soldering station to be switched on for the first time

Info: Store the soldering iron only in the central appropriate support, not in the side storage funnels of the soldering tips! (See Fig. 7)

- a) The Safety Notes listed in the chapter [For your safety](#) [► 5] must be observed.
- b) Make sure that the line voltage complies with the value specified on the type plate.
- c) Place the soldering station and the supporting stand on a heat-resistant, conductive ESD work base with the earthing plug connected, as described in chapter [ESD sensitive components](#) [► 9]. Also boards must be stored only on the ESD work surface.  
It must be impossible for the devices to tip over.



### **⚠ WARNING**

#### **Danger of fire due to highly flammable substances!**

- a) Before switching on the soldering station, all easily combustible objects, liquids and gases must be removed from the working area!

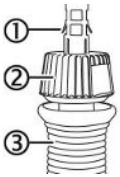

Fig. 6: Soldering tip proper mounting

- a) Ensure that the On/Off switch is turned off.
- b) To check the soldering tip for tight seating:  
Keep a correct distance between the knurled sleeve [2] and the soldering iron [3], as shown in Fig. 6.  
The bayonet mount of the knurled sleeve is completely locked.  
The display panels [1] do not touch the knurled sleeve [2].
- c) Place the soldering iron in the supporting stand (see Fig. 7). There must be no strain on the connecting cable of the soldering iron.

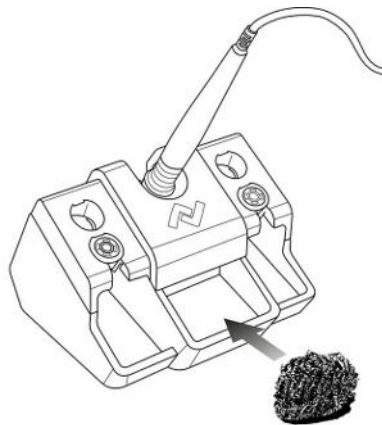

Fig. 7: Properly positioning the soldering iron and dry cleaner

d) Insert the dry cleaner; Fig. 7 shows the recommended position.

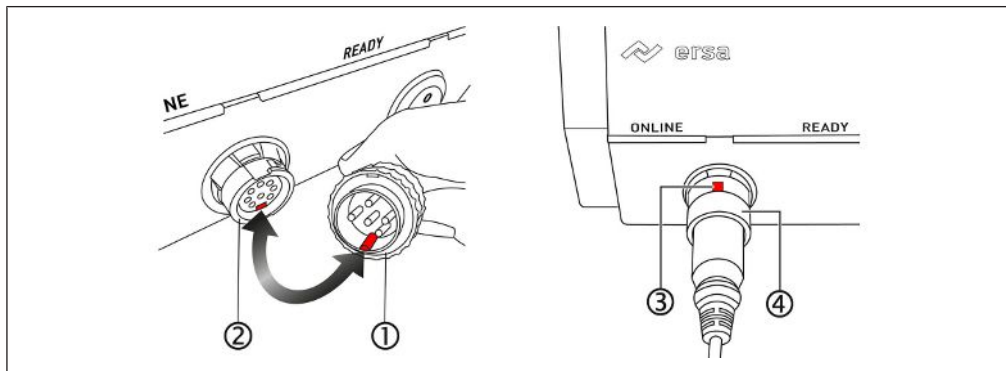

Fig. 8: Plugging in the soldering iron

- e) Fig. 8 left: Insert the plug of the soldering iron [1] into the soldering iron socket at the soldering station [2]. When doing so, align the plug anti-rotation device with the lower recess in the socket, see arrow.
- f) Fig. 8 right: Align the recess of the union nut on the soldering iron plug [3] upwards. Then press the union nut [4] onto the plug and lock it by turning it 90 degree clockwise.
- g) Connect the mains cable to the relevant connector on the soldering station and the mains socket.



### **WARNING**

#### **Danger of fire due to covered ventilation slots!**

- a) Do not place the supporting stand on the soldering station! Never cover the ventilation slots to avoid overheating!

## 5.6 Switching on the soldering station for the first time



**⚠ CAUTION**

**Risk of burns! The soldering iron gets hot immediately after it is switched on!**

Never touch the hot soldering tip or the hot heating element directly!



**⚠ CAUTION**

**Risk of burns!** The soldering station with soldering iron is factory preset to 360 °C (680 °F)!

Even without a network connection or installing any software, the soldering iron can be heated by turning on the On/Off switch on the soldering station.

- ✓ The software-related preparatory steps for operating the soldering station have been carried out as described in the software instructions for the “Ersa TRACE Cockpit” web app.
- ✓ The preparatory steps for commissioning were carried out. Read more about this in chapters Before commissioning.
- ✓ The soldering iron has now been placed in the support stand.
  - a) Use the On/Off switch to turn on the soldering station.
    - ⇒ The soldering station is in heating-up mode.
    - ⇒ When switched on for the first time, the LEDs will show the following colours:

ONLINE	Red: no network connection  Blue: The soldering station is waiting for the Bluetooth connection to be established through the “Ersa TRACE” app for integration into the WLAN network  Yellow: Network OK, no connection to the “Ersa TRACE Cockpit” web app  Green: Network connection established
READY	Red: Soldering tip temperature outside the set temperature range  Green: the default temperature setting of 360 °C (680 °F) has been reached
SERVICE	Green: all functions running properly  Yellow: no tool connected  Red: incorrect tool connected or error message in the “Ersa TRACE Cockpit” web app

## 5.7 Switching OFF:



### CAUTION

**Attention Risk of burns!**

After switching off, the soldering tip remains hot for a long time!

- a) Switch off the soldering station through the on/off switch [1] on the front of the device.

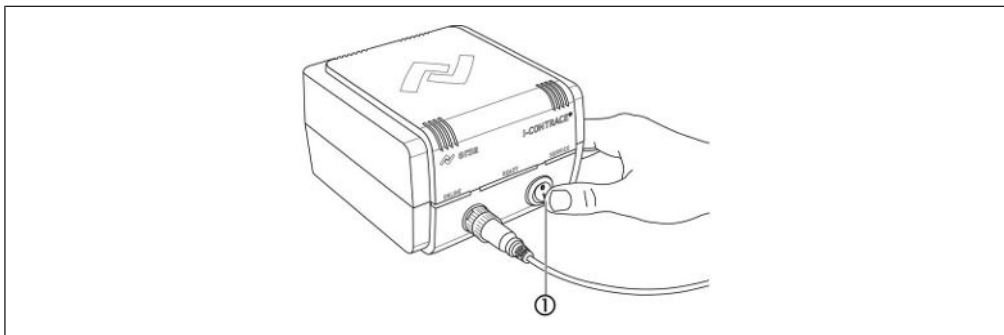

Fig. 9: Switching off the soldering station

- ⇒ All LEDs go out.
- ⇒ The network connection is interrupted and the “Ersa TRACE Cockpit” app shows “OFFLINE” for the switched off soldering station.

## 5.8 Establishing a WLAN connection between the soldering station and a network

This chapter describes the integration and operation of the soldering station with a WLAN network.

- The PC that is used as a server must be compatible with the network.
- The “Ersa TRACE” app is used to integrate an i-CON TRACE soldering station into the WLAN.

Info: Alternatively, the soldering station can also be integrated into a LAN network. Read more about this in Chapter [Establishing a LAN connection between the soldering station and a network \[▶ 27\]](#). How to operate the “Ersa TRACE Cockpit” web app is described in the separate software instruction manual.

### 5.8.1 Connecting the soldering station to the WLAN through the “Ersa TRACE” app

If the MAC address is required to register the soldering station in the network, you can find it on the type plate.

- ✓ The preparatory steps for commissioning were carried out. Read more about this in Chapter [Before commissioning](#).
  - ✓ Location sharing is enabled on the mobile device.  
No location data is collected. The data protection guidelines of Kurtz Holding GmbH & Co Beteiligungs KG apply.
  - ✓ Only 2.4 GHz WLAN is supported.
- a) Download the “Ersa TRACE” app to your smartphone or tablet from Google Play Store or Apple App Store and install the app. Below are the QR codes for direct access to App Stores:



Fig. 10: Links to download “Ersa TRACE”

- b) Switch on Bluetooth on the mobile device and start the “Ersa TRACE” app.
- ✓ You are within the range of coverage of the soldering station’s Bluetooth connection.
  - ✓ The soldering iron has now been placed in the support stand.
- a) Switch on the soldering station.
- ⇒ The soldering station’s ONLINE LED lights up blue.





### ⚠ CAUTION

**Risk of burns! The soldering iron gets hot immediately after it is switched on!**  
Never touch the hot soldering tip or the hot heating element directly!



### ⚠ CAUTION

**Risk of burns! The soldering station with soldering iron is factory preset to 360 °C (680 °F)!**  
Even without a network connection or installing any software, the soldering iron can be heated by turning on the On/Off switch on the soldering station.

## When the mobile device camera can be used

- a) In step 1, select the [START SCAN] button (see Fig. 11, screenshot on the left) and scan the QR code on the soldering station's name plate.

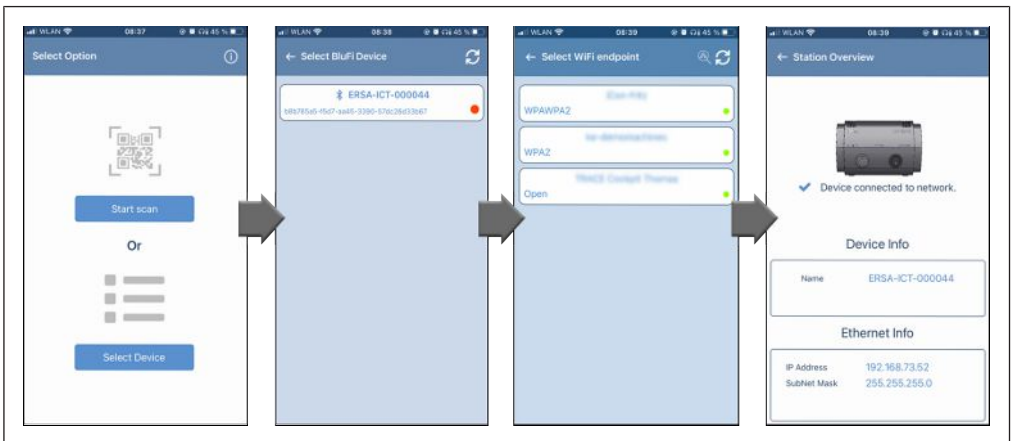

Fig. 11: Bluetooth connection: Scan the QR code of the soldering station or select the Bluetooth network

- b) Follow the app automatic operation.  
⇒ The soldering station has been integrated into the WLAN.  
⇒ Die ONLINE LED lights up green.

## When the mobile device camera cannot be used

- a) In step 1, select the [SELECT DEVICE] button (see Fig. 11, screenshot on the left).  
b) Follow the app automatic operation.  
⇒ The soldering station has been integrated into the WLAN.  
⇒ Die ONLINE LED lights up green.

The soldering station will now automatically connect to the server every time it is switched on.

The steps for establishing a WLAN connection to the soldering station must be carried out again after resetting the soldering station.

## 5.9 Establishing a LAN connection between the soldering station and a network

This chapter describes the integration and operation of the soldering station in a LAN network.

- The PC that is used as a server must have an Ethernet LAN connection.
- The optional Ethernet network card (see chapter [Spare/wear parts and accessories](#) [▶ 45]) must be inserted into the soldering station.

If the Ethernet MAC address is required for the connection between the soldering station and your LAN, you can find it on the type plate.

Info: Alternatively, the soldering station can also be integrated into a LAN network. Read more about this in Chapter [Establishing a WLAN connection between the soldering station and a network](#) [▶ 24]. How to operate the “Ersa TRACE Cockpit” web app is described in the separate software instruction manual.

### 5.9.1 Entering the optional Ethernet network card into the soldering station

- ✓ Switch off the soldering station.
- a) In order to avoid damage to the Ethernet network card during handling, ESD protective measures must be taken:
  - ⇒ When touching the Ethernet network card, you must be statically discharged (e.g. put on an ESD wrist strap or touch an earthed object shortly beforehand).
  - ⇒ Touch the Ethernet network card only by its edge or at the network bushing.
  - ⇒ Place the Ethernet network card only on a conductive surface.
- b) Carefully remove the optional Ethernet network card from the packaging.
- c) Carefully insert the Ethernet network card all the way into the opening at the back of the soldering station (see Fig. 12).

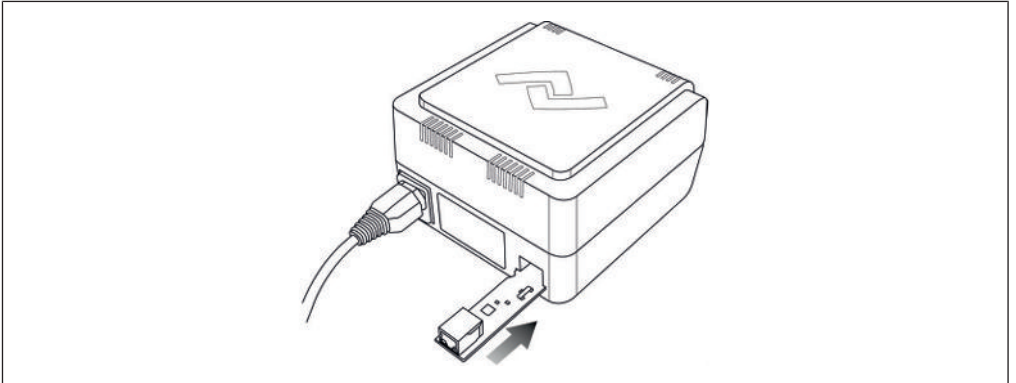

Fig. 12: Inserting the optional Ethernet network card

- d) Press the Reset key to reset the soldering station. Read more about this in Chapter [Resetting the soldering station with the reset key \[▶ 40\]](#).
- e) Connect the LAN cable to the Ethernet network card and connect it to the LAN.
- f) Make sure that the connection cables are never under strain!

### 5.9.1.1

#### ***Pulling out the optional Ethernet network card***

If the Ethernet network card is to be pulled out again, proceed as follows:

- ✓ Switch off the soldering station.
- a) To prevent the Ethernet network card from being damaged during handling, ESD protective measures must be taken, as described in Chapter [Entering the optional Ethernet network card into the soldering station \[▶ 27\]](#).
- b) Pull out the network cable and the soldering iron cable.
- c) Carefully turn the soldering station over so that the bottom side is facing upwards. When doing so, pay attention to the connected LAN cable.
- d) Press and hold the release lever [1] (see Fig. 13).

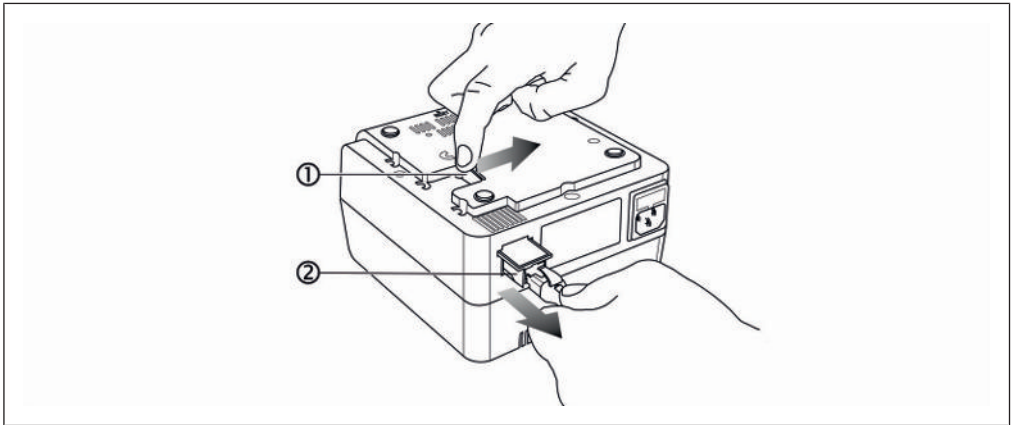

Fig. 13: Pulling out the Ethernet network card

- e) Carefully pull out the network card [2] by the LAN cable.
- f) The next time the soldering station is switched on, press the Reset button to reset it. Read more about this in Chapter [Resetting the soldering station with the reset key](#) [▶ 40].

## 6. Function description

### 6.1 Information on the LED indicators

#### ONLINE LED signals

Blue	The soldering station is waiting for the Bluetooth connection to be established through the "Ersa TRACE" app for integration into the WLAN network
Yellow	Network alright, no connection to the "Ersa TRACE Cockpit" web app
Green	Network connection established
Red	No network connection / connection error

#### READY LED signals

Green	Soldering is possible
Red	Soldering tip temperature outside the set temperature range
Yellow	Standby mode, temperature is lowered
Pulsing yellow	Sleep mode, heating element is switched off
Pulsing blue	The heating element is switched off by tapping the soldering iron twice, e.g. to replace the soldering tip

#### SERVICE LED signals

Green	All functions running properly
Yellow	No tool connected
Red	Incorrect tool connected or error message in the "Ersa TRACE Cockpit" web app

#### Other LED signals

All 3 LEDs yellow	The Reset button was pressed. The soldering station is set to the factory settings
All 3 LEDs pulsing yellow	Firmware update in progress

## 6.2 Changing soldering tips

The new 142 soldering tip series was developed for the soldering station i-CON TRACE®. The “Ersa TRACE Cockpit” web app can use the QR code on each soldering tip to recognise the soldering tip and manage the work carried out with it.

### 6.2.1 Changing a soldering tip in the supporting stand

Info: Place the soldering iron only with the soldering tip mounted and only in the central soldering iron stand, not in the four changeable funnels on the side of the supporting stand! The changeable funnels may only be used for storing the soldering tips.

To change the soldering tip, the supporting stand can be used as described below.



#### CAUTION

**Attention Risk of burns!**

After switching off, the soldering tip remains hot for a long time!



#### CAUTION

**Risk of burns! The soldering iron gets hot immediately after it is switched on!**

Never touch the hot soldering tip or the hot heating element directly!

To prevent any material damage due to overheating, switch off the heating element or the soldering station before each soldering tip replacement! Never operate the soldering iron without the soldering tip!

#### Heating element immediate switch-off

- a) Double tap the soldering iron to turn off the heating element. While tapping, tilt the soldering iron slightly upwards (see Fig. 14).

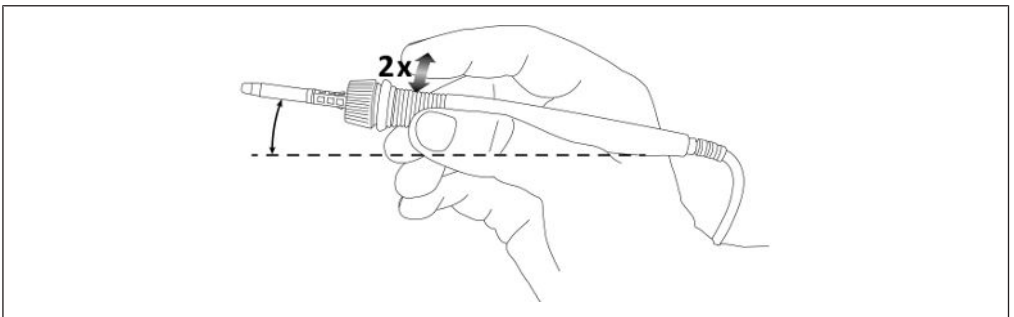

Fig. 14: Double tap the soldering iron

⇒ The READY LED is pulsing blue, which means that the heating element is off.

b) Alternatively, use the On/Off switch to turn off the soldering station.

### Storing a soldering tip

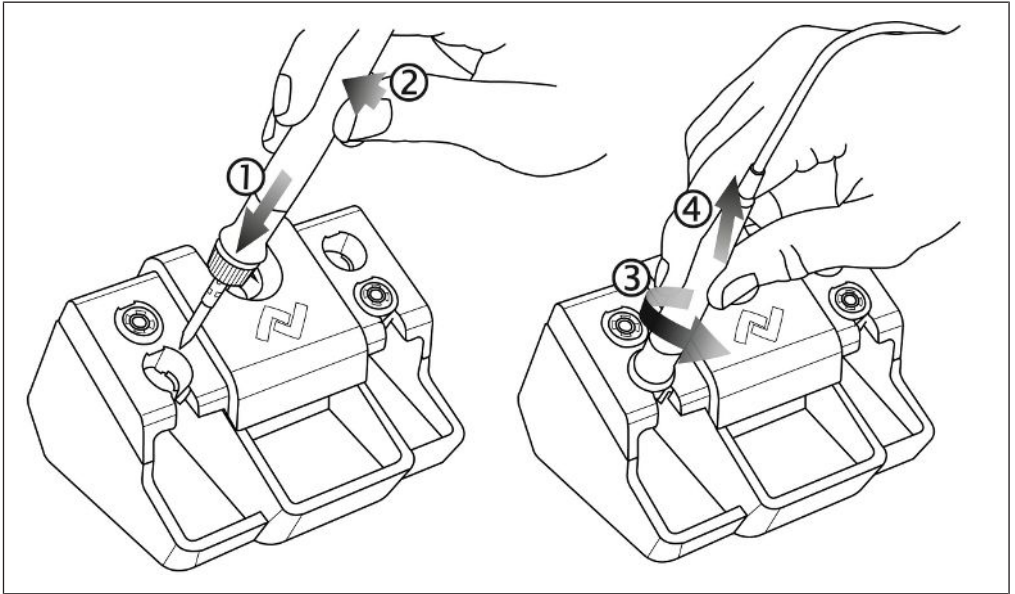

Fig. 15: A soldering tip can be stored in four steps

- a) Figure 15 on the left: Insert the soldering iron all the way into the changeable funnel [1], then tilt the soldering iron slightly away from you [2].
- b) Figure 15 on the right: Turn the soldering iron anti-clockwise as far as it will go [3], then tilt the soldering iron slightly away from you and pull it out of the soldering tip [4].



### Picking up a soldering tip

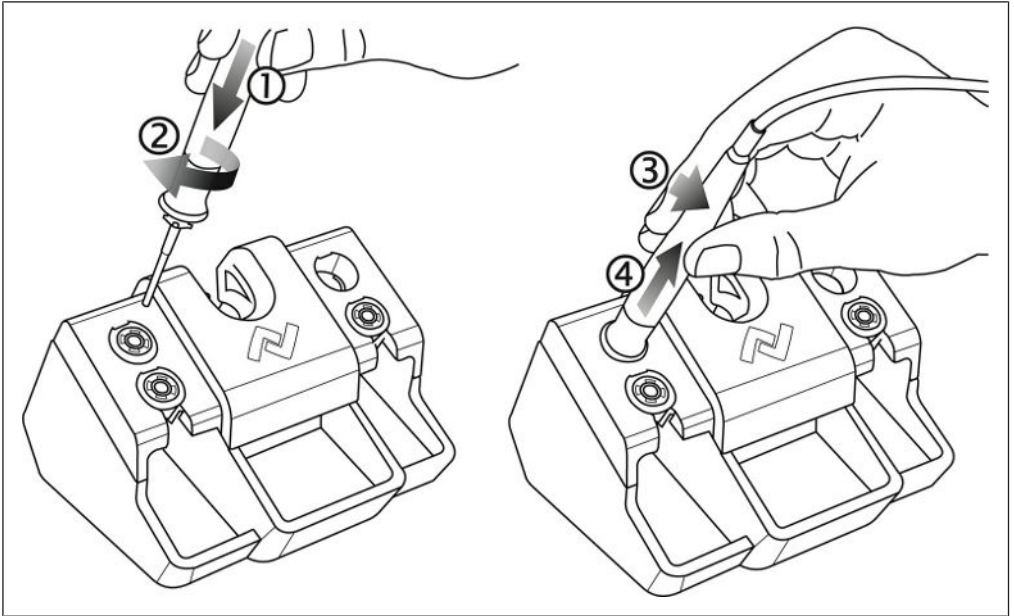

Fig. 16: A soldering tip can be picked up in four steps

- a) Figure 16 on the left: Insert the heating element all the way into the soldering tip [1], then turn the soldering iron clockwise as far as it will go [2].
- b) Figure 16 on the right: Turn the soldering iron slightly towards you [3] and pull it out [4].
- c) To check the soldering tip for tight seating:
  - Keep a correct distance between the knurled sleeve [2] and the soldering iron [3], as shown in Fig. 17.
  - The bayonet mount of the knurled sleeve is completely locked.
  - The display panels [1] do not touch the knurled sleeve [2].
- d) After changing the soldering tip, tap the slightly upwardly inclined soldering iron twice to switch the heating element or the soldering station back on again.

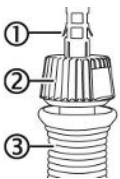

Fig. 17: Soldering tip proper mounting

⇒ The READY LED is no longer pulsing blue.

## 6.2.2 Manually replacing a soldering tip



### ⚠ CAUTION

**Risk of burns! The soldering iron gets hot immediately after it is switched on!**  
Never touch the hot soldering tip or the hot heating element directly!



### ⚠ CAUTION

**Attention Risk of burns!**

After switching off, the soldering tip remains hot for a long time!  
Always touch only the knurled plastic part! ([2] in Figure 17)

To prevent any material damage due to overheating, switch off the heating element or the soldering station before each soldering tip replacement! Never operate the soldering iron without the soldering tip!

### Heating element immediate switch-off

- a) Double tap the soldering iron to turn off the heating element. While tapping, tilt the soldering iron slightly upwards (see Fig. 18).

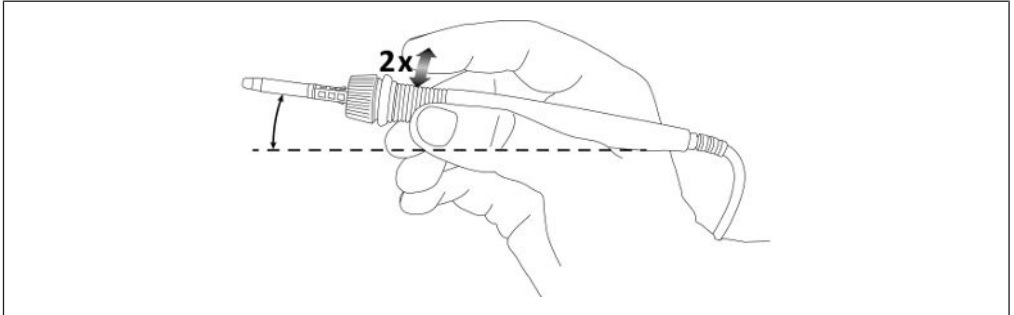

Fig. 18: Double tap the soldering iron

⇒ The READY LED is pulsing blue, which means that the heating element is off.

- b) Alternatively, use the On/Off switch to turn off the soldering station.

## Replacing a soldering tip



### CAUTION

**Risk of burns!** Allow the soldering iron to cool off until reaching a safe temperature!

Touching the knurled plastic component of the soldering tip is always at your own risk. If necessary allow the soldering tip to cool down completely before changing it.

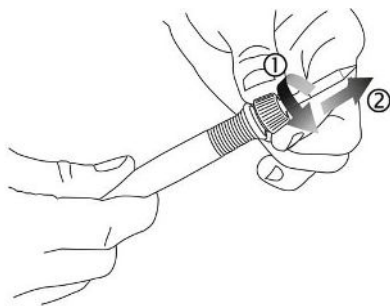

Fig. 19: Unlock [1] and pull out [2] the soldering tip

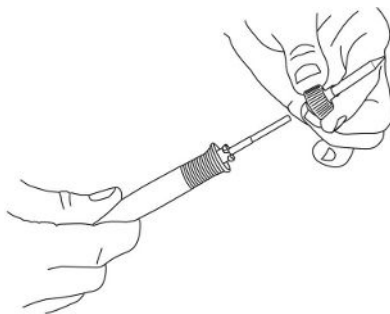

Fig. 20: Remove the soldering tip

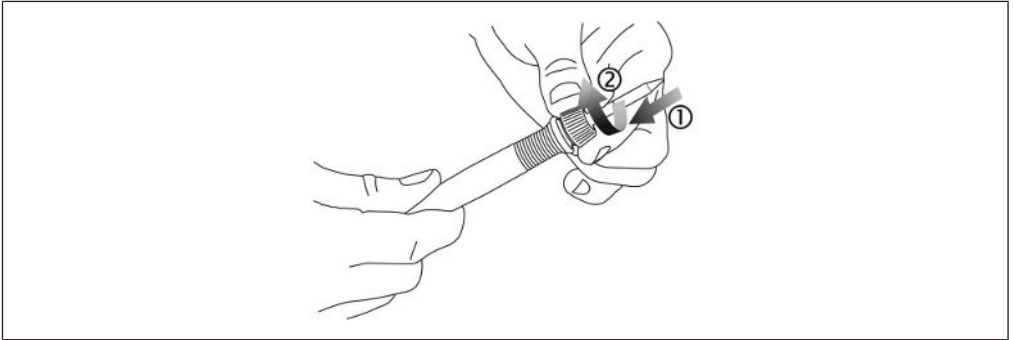

Fig. 21: Fit the soldering tip [1], overcome the spring force and lock the bayonet mount [2]

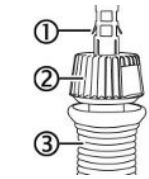

Fig. 22: Soldering tip proper mounting

- a) To check the soldering tip for tight seating:  
 Keep a correct distance between the knurled sleeve [2] and the soldering iron [3], as shown in Fig. 22.  
 The bayonet mount of the knurled sleeve is completely locked.  
 The display panels [1] do not touch the knurled sleeve [2].
  - b) After changing the soldering tip, tap the slightly upwardly inclined soldering iron twice to switch the heating element and/or the soldering station back on again.
- ⇒ The READY LED is no longer pulsing blue.

## 7. Service and maintenance

### 7.1 Error messages and error codes

The “Ersa TRACE Cockpit” web app shows errors such as an error code with an info message. The SERVICE LED on the soldering station shows the error status. Read more about this in Chapter LED signals [SERVICE]. After the error has been eliminated and acknowledged, the connected soldering tool will be heated again.

#### List of error codes

Error message	Cause	Remedy
[Soldering station calibration]	Station is no longer calibrated	Have factory calibration performed
[Ambient temperature sensor]	Temperature sensor measure value not OK	Have soldering tool and soldering station inspected
[No HE contact] / [TS defective]	Heating element not correctly installed / Error in temperature sensor	Install the heating element correctly, have the soldering tool checked
[HE defective]	Heating element defective	Check the heating element, check the soldering station
[Data loss!]	Parameter/configuration data corrupted	Switch off the soldering station. Reset as described in Chap. <a href="#">Resetting the soldering station with the reset key [ 40]</a> .
[HE short circuit]	Heating element short-circuited	Replace the heating element
[Soldering tool calibration]	Soldering tool is no longer calibrated	Have factory calibration performed
[Mains frequency]	Mains frequency outside the frequency range ( $\pm 10\%$ )	Check mains frequency
[Overload protection]	Soldering station overloaded	Let the soldering station cool down

## 7.2 Error treatment

In case of faulty operation of the soldering station, check the following items:

- a) Soldering iron does not get hot.  
Is the soldering iron connected correctly to the soldering station?
- b) Soldering station remains off after switch-on / no line voltage?  
Correctly connect the mains cable to the soldering station and socket. For this purpose, follow the electrical specifications on the type plate.
- c) Soldering station remains off after switching on.  
Is the fuse defective?

When using the soldering station in the LAN network, the connection can be interrupted by strong electromagnetic fields, e.g. during storms or technical equipment in close proximity. Switch the soldering station off and on again to re-establish the connection.

### 7.2.1 Replacing the fuse

- a) Switch off the soldering station and disconnect the mains plug from it.



#### CAUTION

##### **Danger of electric shock!**

Before changing the fuse, disconnect the soldering station from the mains by pulling out the mains plug!

- a) Carefully pry open the fuse compartment under the mains connection, e.g. with a flat-blade screwdriver (see Fig. 23).

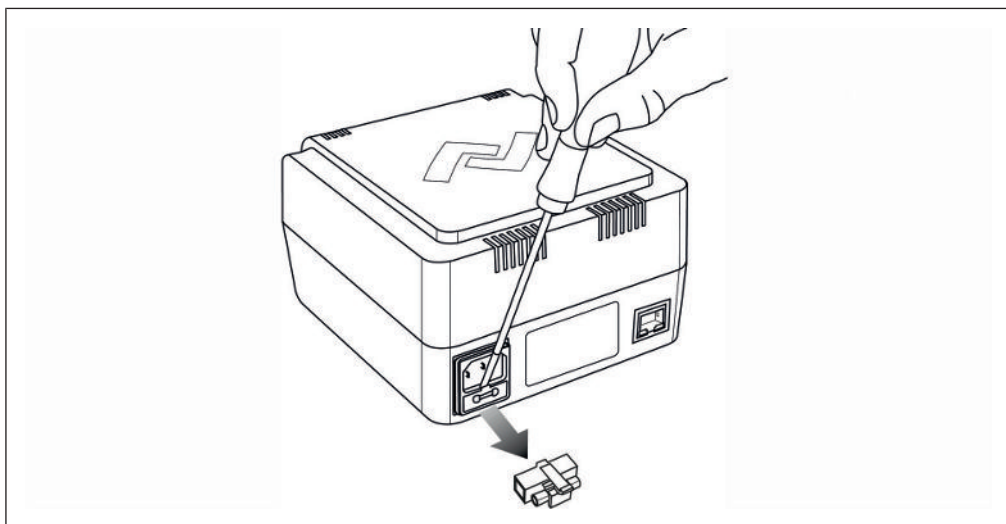

Fig. 23: Replacing the fuse

- b) Remove the fuse holder and replace the “0.8 A slow blowing” fuse for the 230 V variant, or the “1.6 A slow blowing” one for the 115 V variant in the holder.
- c) Re-install the fuse holder and close the compartment.

Note that a defective fuse may also indicate a deeper cause of error. If replacing the fuse does not eliminate the error and no solution can be found in the [Error treatment](#) [[▶ 38](#)] chapter, contact Ersas Service by e-mail at: [Service.tools@kurtz-ersa.de](mailto:Service.tools@kurtz-ersa.de).

## 7.2.2 Changing the heating element

### CAUTION

**Risk of burns!** Only change the heating element when both the soldering tip and the heating element are cold!

Before changing the heating element, switch off the soldering station and allow the soldering tip and the heating element to cool down!

- a) Remove the soldering tip.
- b) Pull the heating element out by hand.

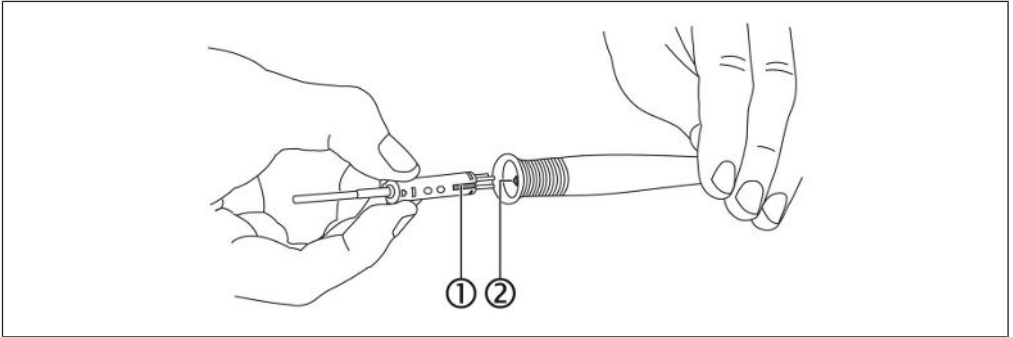

Fig. 24: Replace the heating element

- ✓ Slide in the spare heating element.
- a) Align the groove of the heating element [1] with the marking in the soldering iron [2].
- b) Align the heating element exactly parallel to the soldering iron.
- c) Gently push the heating element in carefully and slowly until it stops. If the heating element cannot slide in easily, do not press with greater force, but re-position it!
- d) Re-install the soldering tip.

### 7.2.3

#### Resetting the soldering station with the reset key

If connection problems occur between the “Ersa TRACE Cockpit” web app and the soldering station that cannot be remedied, resetting the soldering station to the factory settings is recommended.

The default settings are described in chapter [Defaults](#) [▶ 44].

#### Resetting the soldering station

- ✓ Switch off the soldering station.
- ✓ Remove the soldering iron cable
- ✓ Connect the mains plug.
- a) If any, disconnect the optional LAN cable.
- b) Carefully turn the soldering station over so that the bottom side is facing upwards. When doing so, beware of the connected mains cable.
- c) Hold down the reset button [12] (see Fig. 25) on the underside with a suitable object (e.g. paper clip). Do not use a pointed object.



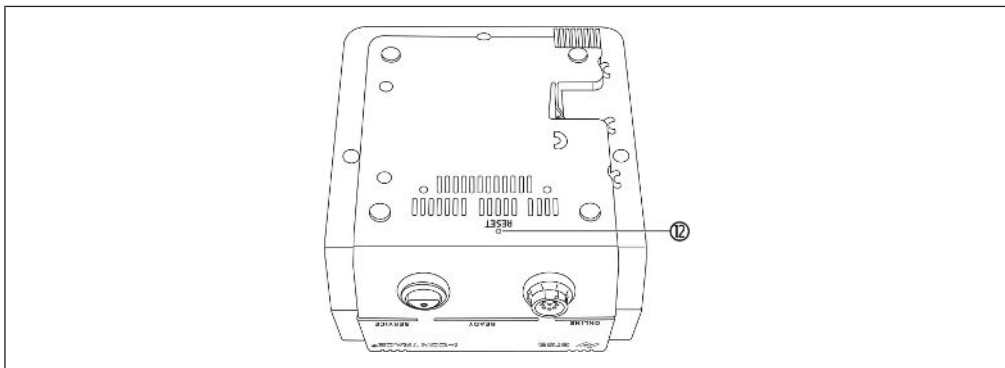

Fig. 25: Reset button [12] on the underside of the device

- d) With the reset button pressed in, switch on the soldering station.
- e) When all 3 LEDs light up yellow, release the reset button.
  - ⇒ The soldering station has been reset to factory settings.
- f) Switch off the soldering station.
- g) Reconnect the disconnected cable.
- h) When using WLAN to connect to the network:
 

After a reset, the soldering station must be reintegrated into the WLAN. To do so, use the Bluetooth function of the “Ersa TRACE” app on a mobile device. Read more about this in Chapter [Establishing a WLAN connection between the soldering station and a network](#) [▶ 24].

## 7.2.4

### Possible defects

The following errors indicating possible defects of the soldering station may occur.

- The soldering station shows permanently only the room temperature.  
The heating element or the supply line to the soldering iron is defective.  
The room temperature is also displayed when the soldering station has been idle for a few minutes (Ready LED pulsing yellow).

Info: If the soldering station is sent in for repair, all accessory tools must be shipped with it.

## 7.3 Cleaning and Maintenance

Info: There are no user-serviceable parts inside the soldering station.



### ⚠ CAUTION

**Danger of electric shock!**

Before cleaning, de-energise the soldering station by pulling out the mains plug!



### ⚠ CAUTION

**Attention Risk of burns!**

After switching off, the soldering tip remains hot for a long time!

### Cleaning

- Occasionally clean the device with a soft, damp cloth. Do not use abrasive sponges, scouring agents, solvents such as alcohol or gasoline, steam or high-pressure cleaners.
- Wipe dust deposits from the ventilation openings dry.
- The supporting stand can be opened so that it can be cleaned inside.

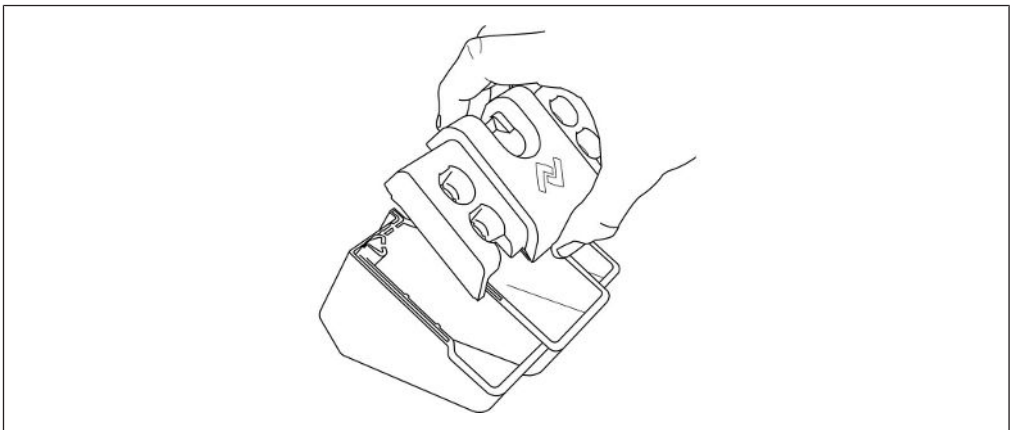

Fig. 26: Opening the supporting stand

### Maintenance work

- Always leave a small amount of solder on the soldering tip after soldering, in order to extend its service life. An untinned soldering tip becomes passive within a short time.

- b) If necessary, wipe the soldering tip with a damp sponge or by dipping the tip several times into the dry cleaning agent shortly before the soldering process.
- c) To achieve good electric and heat conductivity, the tip should be occasionally removed and the heating element cleaned with a brass brush.
- d) Use only original accessories and spare parts from Ersa.
- e) Make sure that the ventilation openings of the station do not lose their effectiveness due to dust buildups.
- f) There are no parts to be serviced inside the device.

## 7.4 Defaults

The following table shows the factory settings. After a reset with the reset key (see chap. [Resetting the soldering station with the reset key \[▶ 40\]](#)), the current settings are deleted and the factory settings restored.

Parameter	Value
Target temperature (°C / °F)	360 / 680
Temperature range above (Δ°C / Δ°F)	20 / 68
Temperature range below (Δ°C / Δ°F)	20 / 68
Energy level	Medium
Standby time (min)	2
Standby temperature (°C / °F)	210 / 410
Shutdown time (min)	10
Calibration temperature (Δ°C / Δ°F)	0 / 0

## 8. Spare/wear parts and accessories

Electronic soldering station i-CON TRACE <sup>®</sup> , 220-240 V / 110-120 V, antistatic, complete with i-TOOL TRACE soldering iron, soldering tip 0142CDLF16 and supporting stand
Electric soldering station i-CON TRACE <sup>®</sup> , 220-240 V / 110-120 V, anti-static
Soldering iron i-TOOL TRACE, 24 V, 150 W, antistatic, with soldering tip 0142CDLF16
Supporting stands for i-TOOL TRACE, anti-static
Heating element for i-TOOL TRACE
Dry cleaning agent
Ethernet LAN network card
Cleaning sponge for supporting stands
Brass cleaning brush
Soldering tip of Series 142

You can open the list of all soldering tips included in the 142 series with the Internet quick link [142.ersa.com](https://www.142.ersa.com).

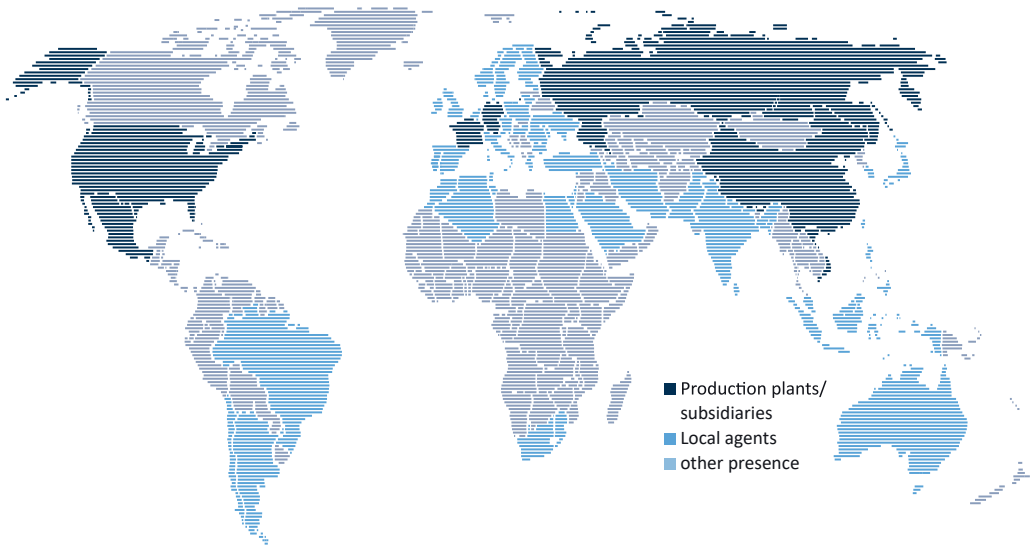

## Electronics Production Equipment

# GLOBALLY PRESENT

### America

Kurtz Ersä, Inc.  
[usa@kurtzersa.com](mailto:usa@kurtzersa.com)  
[www.ersa.com](http://www.ersa.com)

### Mexico

Kurtz Ersä, S.A. de C.V.  
[info-kmx@kurtzersa.com](mailto:info-kmx@kurtzersa.com)  
[www.ersa.com](http://www.ersa.com)

### France

Ersä France  
[ke-france@kurtzersa.com](mailto:ke-france@kurtzersa.com)  
[www.kurtzersa.com](http://www.kurtzersa.com)

### Asia

Kurtz Ersä Asia Ltd.  
[asia@kurtzersa.com](mailto:asia@kurtzersa.com)  
[www.ersa.com](http://www.ersa.com)

### China

Ersä Shanghai  
[info-esh@kurtzersa.com](mailto:info-esh@kurtzersa.com)  
[www.ersa.com](http://www.ersa.com)

### Vietnam

Kurtz Ersä Vietnam  
 Company Limited  
[info-kev@kurtzersa.com](mailto:info-kev@kurtzersa.com)  
[www.ersa.com](http://www.ersa.com)