

Electrical measurements on adjustable speed drives

Ten measurements that tell you a lot

Application Note

Introduction

Most experienced motor technicians are well prepared to deal with traditional three-phase motor failures that result from the effects of water, dust, grease, failed bearings, misaligned motor shafts, or just plain old age. However, modern electronically controlled motors, more commonly referred to as adjustable speed drives, present a unique set of problems that can vex the most seasoned pro. This application note describes the electrical measurements you need to make during the installation and commissioning of a drive, as well as when diagnosing bad components and other conditions that may lead to premature motor failure in adjustable speed drives (ASDs).

Troubleshooting philosophy

There are many different ways to go about troubleshooting an electrical circuit, and a good troubleshooter will always find the problem—eventually. The trick is to track down the problem as quickly as possible, keeping downtime to a minimum. The most efficient procedure for troubleshooting is to begin looking at the motor, and then systematically work back towards the electrical source, looking for the most obvious problems first. A lot of time and money can be wasted replacing perfectly good parts when the problem is nothing more than a loose connection.

Next, take care to make accurate measurements. Nobody makes inaccurate measurements on purpose of course, but it is easier to do than you may think, especially when working in a high energy, noisy environment like that of an ASD.

- If possible, do not use grounded test instruments. They can introduce noise into a measurement where none existed before.
- Avoid touching instruments and probes while taking the reading, as electrical noise can get coupled through your hands which may also affect the reading.
- Because of the high noise environment, when making current measurements use either a clamp meter designed for this environment or, if using a scope, use a current clamp that puts out 10 mV/amp or 100 mV/amp. They provide a better signal to noise ratio than 1 mV/amp clamps when making current measurements less than 20 amps.

- If using a digital multimeter with a clamp accessory always use a current transformer milliamp output clamp as this connects to the low impedance current input jacks of the DMM and is much less susceptible to the noise in the environment.

Finally, it is a good idea to document electrical measurements at key test points in the circuit when the system is functioning properly. If a good drawing does not exist, make one. A simple one-line or block diagram will do nicely. Write down voltage and temperature measurements at key test points. This will save a great deal of time and head-scratching later.

Making safe measurements

Before making any electrical measurements, be sure you understand how to make them safely. No test instrument is completely safe if used improperly, and you should be aware that many test instruments on the market are not appropriate for testing adjustable speed drives.

Safety ratings for electrical test equipment

The International Electrotechnical Commission (IEC) is the primary independent organization that defines safety standards for test equipment manufacturers. The IEC 61010 second edition standard for test equipment safety states two basic parameters, a voltage rating and a measurement category rating. The **voltage rating** is the **maximum continuous working voltage the instrument is capable of measuring**.

When the voltage rating is coupled with a category rating, it can be confusing. The **category ratings** depict the measurement environment expected for a given category. The measurement environment for adjustable speed drives is not always simple and may vary from installation to installation. Most all three-phase ASD installations would be considered a CAT III measurement environment. Single phase ASD installations would be a CAT II environment. If you are working in both environments, play it safe and use only CAT III rated test instruments. What may not be readily obvious from looking at the following table is the difference between a 1000 V CAT II rated meter and a 600 V CAT III rated meter. At first glance, you might think the 1000 V CAT II meter is the better choice because it has a higher working

voltage than the 600 V CAT III meter and it can handle the same level of high voltage transient, which is true. However, the 600 V CAT III meter can safely handle **six times** the power as the 1000 V CAT II meter, should a transient cause a fault within the meter.

Also, avoid meters that claim to be “**designed to meet**” EN61010 specifications or that do not carry the test certification of an independent testing lab such as UL, CSA, VDE, TÜV or MSHA, as they do not always meet the specifications for which they claim to be designed. Always look for independent certification of test instruments for ASD measurements. Refer to the ABC’s of DMM Safety from Fluke for additional information on category ratings and making safe measurements.

Overvoltage Category	Examples
CAT IV	<ul style="list-style-type: none"> Refers to the “origin of installation”, i.e. where low-voltage connection is made to utility power. Electricity meters, primary overcurrent protection equipment. Outside the building and service entrance, service drop from the pole to building, run between the meter and panel. Overhead line to detached building, underground line to well pump.
CAT III	<ul style="list-style-type: none"> Equipment in fixed installations, such as switchgear and three phase motors. Bus and feeder in industrial plants. Feeders and short branch circuits, distribution panel devices. Lighting systems in larger buildings. Appliance outlets with short connections to service entrance.
CAT II	<ul style="list-style-type: none"> Appliance, portable tools, and other household and similar loads. Receptacle outlets and long branch circuits. Outlets at more than 10 meters (30 feet) from CAT III source. Outlets at more that 20 meters (60 feet) from CAT IV source.
CAT I	<ul style="list-style-type: none"> Protected electronic equipment. Equipment connected to source circuits in which measures are taken to limit transient voltages to an appropriately low level. Any high-voltage, low-energy source derived from a high-winding resistance transformer, such as the high-voltage section of a copier.

Table 1. Measurement environment examples

Overvoltage Category	Working Voltage (dc or ac-rms to ground)	Peak Impulse Transient (20 repetitions)	Test Source (Ohm = V/A)
CAT I	600V	2500V	30 ohm source
CAT I	1000V	4000V	30 ohm source
CAT II	600V	4000V	12 ohm source
CAT II	1000V	6000V	12 ohm source
CAT III	600V	6000V	2 ohm source
CAT III	1000V	8000V	2 ohm source

Table 2. Transient test values for overvoltage installation categories

Motors — Measurement 1

Low voltage

Low voltage

This troubleshooting step should always be done before you attempt any other measurement. Periodic tightening of connections is often required to maintain a low resistance connection between conductors. Visually inspect all connection points for looseness, corrosion, or conductive paths to ground. Even if the visual inspection looks okay, you should use at least one, or some combination of the following methods for checking the connections.

Voltage drops

Check for voltage drops across the various connections. Compare with the other two phases. Any significant variation between phases, or more than two or three percent (depending on motor current and supply voltage) at each connection, should be suspect.

Temperature measurements

The Fluke 60 Series Infrared Thermometers are a fast and easy way to check for bad connections. Any significant increase in temperature at the connection terminal will indicate a bad connection or contact resistance due to infrared heat loss. If the temperature of the terminal was not previously recorded onto your system diagram, compare with the other two phases.

Voltage measurements

As the voltage applied to the motor terminals by the ASD is non-sinusoidal, the voltage readings displayed by an analog meter, an average responding digital multimeter (DMM) and a true-rms DMM will all be different.

Analog meters

Many troubleshooters prefer using an analog meter because the coil in the meter movement responds in the same way as the motor to the low frequency component of the waveform and not the high frequency switching component. The analog meter should correspond closely to the voltage displayed on the ASD housing if one exists.

Analog meters read the average voltage of the modulation frequency of the PWM drive. While it's true the analog meter displays a voltage reading close to what the PWM drive is displaying and the motor is responding, safety is a big concern with the analog meters as they generally don't have any EN61010 safety rating.

Digital multimeters

Many DMMs will respond to the high frequency component of the motor drive waveform and will therefore give a higher reading. A true-rms DMM will give an accurate reading of the heating effect of the non-sinusoidal voltage applied to the motor, but will not agree with the motor controller's output voltage reading. However, it should be noted that even though the motor is not responding to the higher frequencies in terms of torque or work being done, high frequency currents might be flowing outside of the windings due to various capacitances in other parts of the motor. The issue is bandwidth. The Fluke 33x Clamp Meters, 787 and 789 ProcessMeters™ 43B Power Quality Analyzer and 190 Series ScopeMeter® Test Tools will all provide voltage readings similar to that of the analog meter and ASD display.

Motors — Measurement 2

Voltage and current unbalance

Voltage unbalance

Next measure the phase-to-phase voltage between the three motor terminals for voltage unbalance. Voltage unbalances of **as little as two percent** can cause excessive heating due to unbalanced currents in the stator windings and loss of motor torque. However, some motor installations are more forgiving towards unbalances so be sure to check out the entire motor system for other causes should an unbalance exist. As the relative difference between phase voltages is what is being measured, not absolute voltages, a DMM will give more accurate readings with better resolution than an analog meter. Use the following procedure to calculate voltage unbalance.

Current unbalance

Motor current should be measured to ensure that the continuous load rating on the motor's nameplate is not exceeded and that all three-phase currents are balanced. If the measured load current exceeds the nameplate rating, or the current is unbalanced, the life of the motor will be reduced by the resulting high operating temperature. If the voltage unbalance is within acceptable limits, then any excessive current unbalance detected could indicate shorted motor windings or one or the phases shorted to ground. Generally, current unbalance for three-phase motors **should not exceed 10 percent**.

$$\% \text{ (V or I) unbalance} = \frac{\text{Maximum deviation from the average voltages}}{\text{Average voltage}} \times 100$$

For example, voltages of 449, 470 and 462 give an average of 460. The maximum deviation from the average voltage is 11, and percent unbalance would be:

$$\frac{11}{460} \times 100 = 2.39 \%$$

Possible causes of voltage unbalance are: one of the phase drive circuits is only partially conducting, or there is a voltage drop between the ASD's output and the motor terminal on one of the phases due to a poor connection.

There are other concerns about the motor terminal voltages with regard to distortion, but they must be measured and viewed using an oscilloscope and will be discussed later in this application note.

As the current measurement will be made in a high energy, electrically noisy environment, be sure the proper current clamp is used as well as good measuring technique as discussed earlier in this application note. To calculate current imbalance, use the same formula as stated for voltage but substitute current in amps. For example, currents of 30, 35 and 30 amps would give an average current of 31.7 amps. The maximum deviation from the average current would be 3.3 amps with a current unbalance of 10.4 %.

PWM Drives — Measurement 3

Overvoltage reflections at the motor terminals

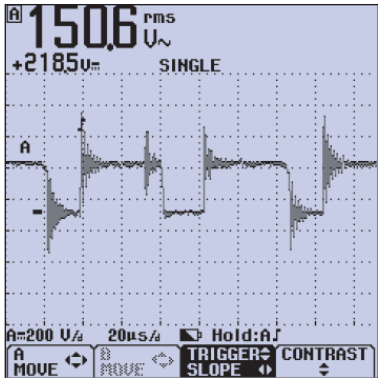

Figure 3A. Reflected voltages (ringing).

The trend with PWM drives has been to make the rise time of the pulses as fast as possible to reduce switching losses and increase the efficiency of the drive. However, fast rise times coupled with long cable lengths produce an impedance mismatch between the cable and the motor causing reflected waves, or “ringing” as shown in Figure 3A.

If the rise times are slow enough, or the cable short enough, the reflected waves will not occur. The main problem with this condition is that ordinary motor winding insulation can break down quickly. Additionally, higher than normal shaft voltages can develop causing premature failure of bearings and excessive common mode noise (leakage currents) can interfere with low voltage control signals and cause GFI circuits to trip.

The relationship between cable length, rise time and the resultant increase in peak voltage is illustrated in Figure 3B. The peak voltage at the motor terminals will increase above the dc bus voltage of the ASD as cable length increases and the rise time of the ASD output pulse gets faster.

Overvoltage reflections — troubleshooting

As mentioned earlier, fast rise times on the ASD output pulses and long cable runs between the ASD and the motor will cause overvoltage reflections approaching double the dc bus voltage and even higher. An oscilloscope is required to discover the full extent of this problem, as seen in figure 3C.

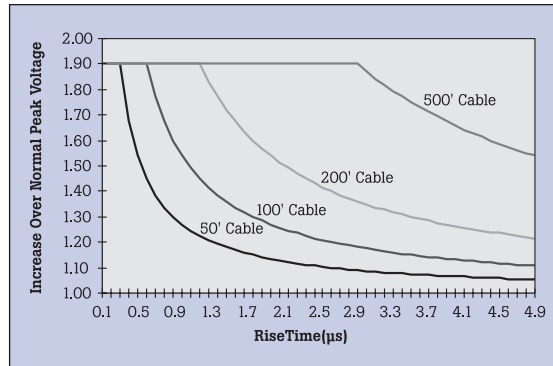

Figure 3B. Impact of rise time and cable length on magnitude of reflected voltages.

Figure 3C shows the ASD L-L voltage measurement at the motor terminals with six feet of cable, while Figure 3D shows the ASD L-L voltage with 100 feet of cable. Notice the difference in peak voltage measurements—about 210 volts. Also notice that there is only 5 V rms difference between the two waveforms (small digits on the display). This means your voltmeter will not find this problem.

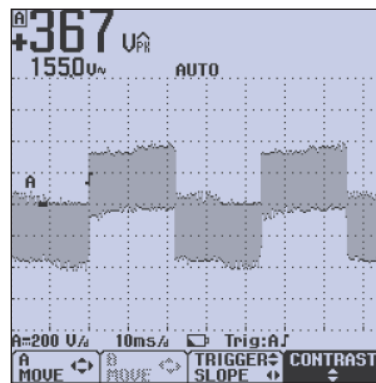

Figure 3C. Normal PWM waveform.

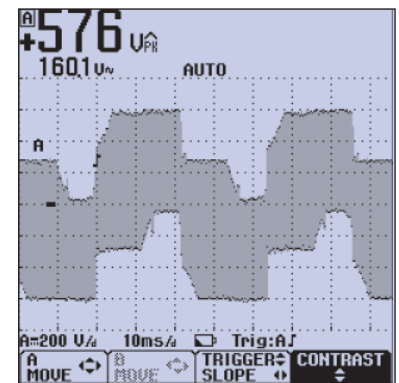

Figure 3D. PWM waveform with reflected voltages.

Very few scopes will trigger as nicely and easily as the Fluke 123 ScopeMeter® Test Tool did for the measurements in Figures 3C and 3D.

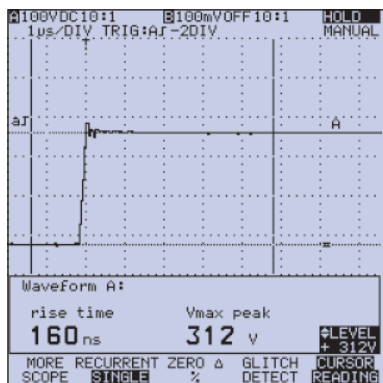

Figure 3E. Leading edge of normal PWM pulse.

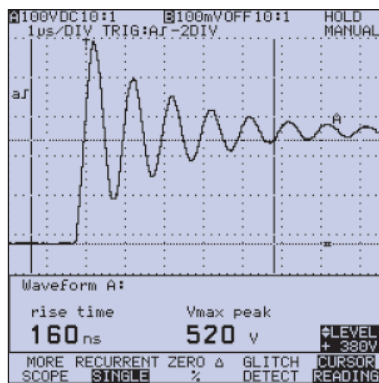

Figure 3F. Leading edge of PWM pulse with reflected voltage (ringing).

For other scopes use the following procedure to measure the extent of the overvoltages.

The signals in figures 3E and 3F were captured by triggering on a single pulse using single shot mode with cursors enabled to make the peak voltage measurement along with rise time. While this measurement requires more button pressing and scope “know how,” the automated rise time measurement may be worth the trouble. Manually resetting the single shot trigger periodically will give you a sampling of various peak voltages for the different pulses. Also, slowly raising the trigger voltage will give you an idea of the maximum peak when the scope stops triggering.

Assuming you have identified a true overvoltage, or ringing problem, then something must be done about it. The simplest solution is to shorten the cable. The peak overvoltages will continue to increase to almost double the dc bus voltage as the cable lengthens or rise time gets faster. The peak voltages can even exceed voltage doubling if the reflected voltage occurs on top of standing waves due to the distributed inductance and coupling capacitance of the cable.

The real danger of this overvoltage condition is the damage it can do to the motor windings over a period of time, which may not show up as a problem when the PWM drive is first installed. Many PWM drives are installed without taking into consideration the overvoltage effects of long cabling between the PWM output and the motor. And while improved efficiency of the newest and latest PWM drives are achieved by making the rise times faster on the output pulses, this can make the overvoltage problem even worse, and the need for shorter cabling even greater.

If your motor has already failed and has to be rebuilt, better insulated wire such as Thermaleze Q^s, or TZ Q^s (by Phelps-Dodge), should be used to rewind the motor. The main advantage is that it provides significantly more protection against overvoltages without adding insulation thickness and the same stator can be used without modification. If the motor has been damaged beyond repair then a motor designed to meet NEMA MG-31 specifications (sustained $V_{Peak} \leq 1600$ V and rise time 0.1 μ s) should be used as a replacement motor for PWM applications where sustained overvoltages may be occurring.

If the cabling in your PWM application cannot be shortened then use one of these three solutions to fix the problem.

1. An external “add-on” low pass filter can be installed between the PWM output terminals and the cable to the motor to slow the rise time.
2. Install an R-C impedance matching filter at the motor terminals to minimize the overvoltages, or ringing effect.
3. In some applications, such as submersible pumps or drilling machines, it isn’t possible to access the motor terminals and other methods of minimizing overvoltages are required. One method is to apply series reactors between the PWM output terminals and the cable to the motor. While this is a fairly simple solution, the reactors may be fairly large, bulky and expensive for large horsepower applications.

A qualified engineer should design all the solutions suggested above for your specific application.

Safety note

Reflective voltage phenomenon can mean peak voltages 2-3 times the dc bus voltage. For 480 V line voltage, this means a dc bus voltage of 648 V and possible peak overvoltages of 1300 V-2000 V and possibly higher given +10 % line voltage variance. Therefore it is recommended that the measurement at the motor terminals be made with the highest rated probe available and for the shortest time possible where reflected voltages are likely to be present.

Filter remedy 1: Typical effect of a low pass filter at the inverter output as measured at the motor terminals.

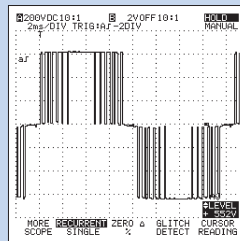

Filter remedy 2: Typical effect of the series reactor measured at the motor terminals.

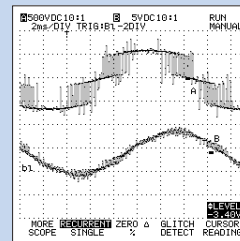

Filter remedy 3: Typical effect of an R-C impedance matching filter measured at the motor terminals.

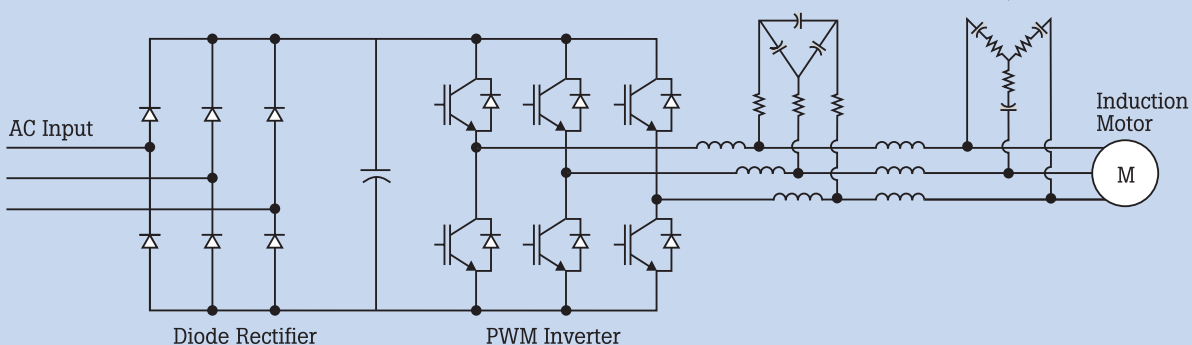
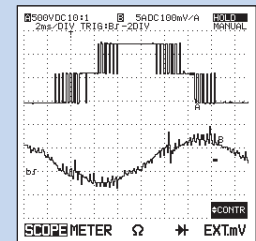

Inverter Output Filter Remedy 1	Series Reactor Remedy 2	Motor Terminal Filter Remedy 3
Series connected to the PWM output terminals.	Series connected to the PWM output terminals.	Parallel connected at the motor terminals.
Designed to slow rise time (dv/dt) below a critical value.	Acts as a current limiter and also slows rise time.	Designed to match the characteristic cable impedance.
Dependent on cable length.	Dependent on size of system.	Not cable length dependent.
Losses dependent on motor kVA.	Losses dependent on motor kVA.	Losses are more or less fixed.
Size/cost dependent on motor kVA.	Size/cost dependent on motor kVA.	Size/cost more or less fixed.

PWM Drives — Measurement 4

Motor shaft voltages

Bearing currents

When motor shaft voltages exceed the insulating capability of the bearing grease, flashover currents to the outer bearing will occur, thereby causing pitting and grooving to the bearing races. The first signs of this problem will be noise and overheating as the bearings begin to lose their original shape and metal fragments mix with the grease and increase bearing friction. This can lead to bearing destruction within a few months of ASD operation—an expensive problem both in terms of motor repair and downtime.

There is a normal, unavoidable shaft voltage created from the stator winding to the rotor shaft due to small dissymmetries of the magnetic field in the air gap. This is inherent in the design of the motor. Most induction motors are designed to have a maximum shaft voltage to frame ground of < 1 Vrms.

Another source of motor shaft voltages are from internal electrostatic coupled sources including: belt driven couplings, ionized air passing over rotor fan blades, or high velocity air passing over rotor fan blades such as in steam turbines.

Under 60 Hz sine wave operation, the bearing breakdown voltage is approximately 0.4 to 0.7 volts. However, with the fast edges of the transient voltages found with PWM drives, the breakdown of the insulating capacity of the grease actually occurs at a higher voltage—about 8 to 15 volts. This higher breakdown voltage creates higher bearing flashover currents, which causes increased damage to the bearings in a shorter amount of time.

Research in this area has shown that shaft voltages below 0.3 volts are safe and would not be high enough for destructive bearing currents to occur. However, voltages from 0.5 to 1.0 volts may cause harmful bearing currents (> 3 A) and shaft voltages (> 2 V) may destroy the bearing.

Care must be taken when making this measurement. While the common is connected to the motor frame ground, connect the probe tip to a piece of twisted strand wire or a carbon brush which in turn makes contact with the motor shaft. As the shaft voltages are caused by fast rise times of the PWM drive pulses, the voltages will appear as narrow peaks. This measurement is best made with an oscilloscope, not a DMM. Even if the DMM has peak detect, there is enough variation between peaks to render the reading unreliable. Another measurement tip is to make the shaft-to-frame ground voltage measurement after the motor has warmed to its normal operating temperature, as shaft voltages may not even be present when the motor is cold.

The simplest solution to this problem is to reduce the carrier (pulse) frequency to less than 10 kHz, or ideally around 4 kHz if possible. If the carrier frequency is already in this range than alternative solutions can be employed such as shaft grounding devices or filtering between the ASD and the motor.

PWM Drives — Measurement 5

Leakage currents (common mode noise)

Leakage currents

Leakage currents (common mode noise) capacitively coupled between the stator winding and frame ground will increase with PWM drives as the capacitive reactance of the winding insulation is reduced with the high frequency output of the drive. Another leakage current path may exist in the capacitance created when the motor cables are placed in a grounded metal conduit. Therefore, faster rise times and higher switching frequencies will only make the problem worse.

It should also be noted the potential increase in leakage currents should warrant close attention to established and safe grounding practices for the motor frame. The increase in leakage currents can also cause nuisance tripping of ground fault protection relays, override 4 to 20 mA control signals, and interfere with PLC communications lines.

Measure common mode noise by placing the current clamp around all three motor conductors. The resultant signal will be the leakage current.

A common mode choke can be used to reduce leakage currents (see Figure 5A). Also, special EMI suppression cables can be used between the drive output and the motor terminals. The copper conductors of the cable are covered with ferrite granules, which absorb the RF energy and convert it to heat. Isolation transformers on the ac inputs will also reduce common mode noise.

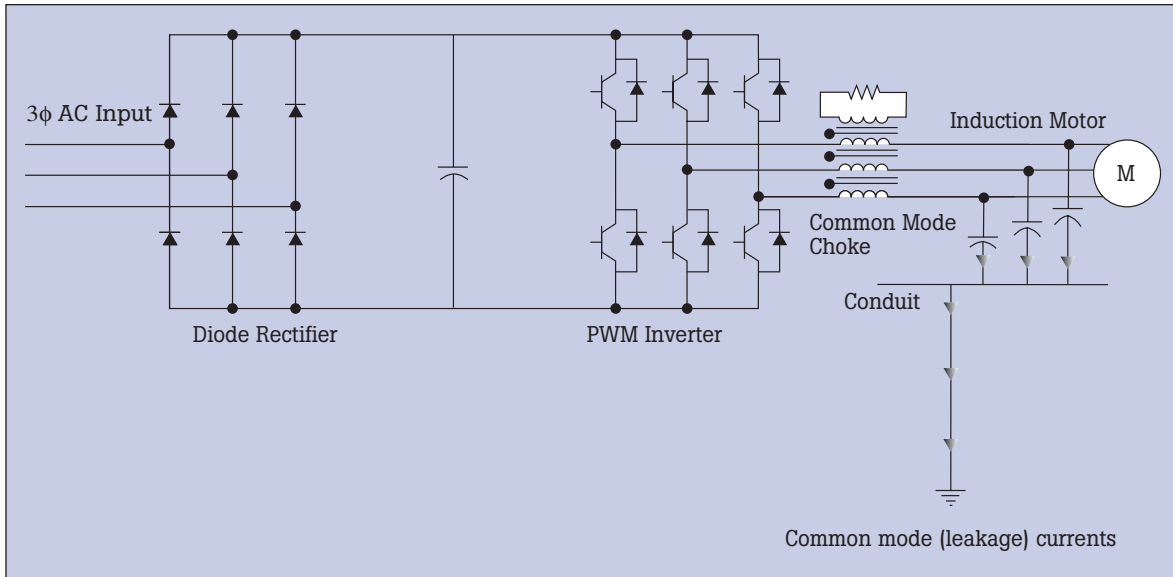

Figure 5A. Common mode choke with dampening resistor to reduce leakage currents.

PWM Drives — Measurement 6 Testing the IGBT output waveshape

PWM inverters

Many fractional horsepower PWM drives are integrated to the point where the input diode block and IGBTs are “potted” into a single throw-away module that is bolted to the heat sink. The cost of these units rarely justifies the time to repair them and sometimes replacement parts are not available. However, larger horsepower drives starting in the 5 to 25 horsepower range, have components that are accessible and the cost of such drives makes repair an economically viable alternative to replacement.

If it has been determined that the drive inverter is the source of an improper voltage

being applied to the motor, then use the following procedure to isolate which IGBT(s) is failing in the output section.

1. Check positive conducting IGBTs by connecting the scope common lead to the dc+ bus and measuring each of the three phases at the inverter’s motor output terminals. Check for nice, clean-edged square waves without any visible noise inside the pulses, and that all three phases have the same appearance.
2. Check negative conducting IGBTs by connecting the common lead to the dc- bus and performing the same measurements as in step one above on each of the three phases at the inverter’s motor output terminals.

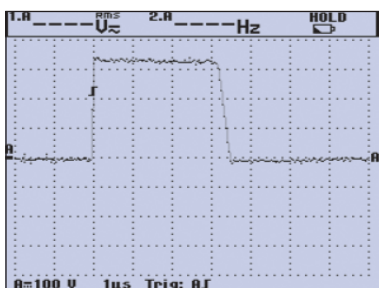

Figure 6A. Square waves.

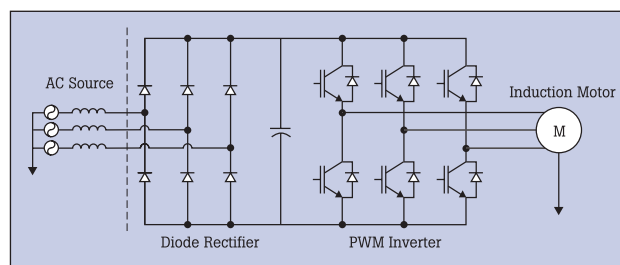

Figure 6B. Check all three phases at the inverter’s motor output terminals.

PWM Drives — Measurement 7 *Testing the IGBT outputs for leakage*

Check for “leaky” IGBTs by measuring the voltage from earth ground to the inverter’s motor output terminals with the drive powered on, but the speed set to zero (motor stopped). Some drives may have a normal earth ground to motor

terminal voltage of about 60 volts, with a reading of over 200 volts indicating a leaky IGBT. Perform this measurement on a known good drive to determine what is normal for that drive.

PWM Drives — Measurement 8 *ASD “trip” problems — overloading*

If it is determined that the cause of overloading is too much motor current, be sure that the motor load is not causing the problem. Check for excessive current unbalance indicating possible shorted phase windings. Verify ASD trip points

are set correctly to the manufacturer’s specifications. Finally verify that the dc bus voltage is being regulated properly. Leaky capacitors may cause excessive ripple and too little inrush current.

PWM Drives — Measurement 9 *ASD “trip” problems — overvoltage*

The dc bus

DC voltage too high

Transients (less than .5 cycle) and swells (.5 to 30 cycles) on the ac line inputs and motor regeneration are the two most common causes of “nuisance” tripping of the overvoltage fault circuit on ASD inverters. Transients and swells can be caused by events happening outside the building like lightning or utilities switching KVAR capacitors or transformer taps, as well as other loads inside the building being switched on (capacitive) or off (inductive). To test for these situations, use an oscilloscope or power line monitor with at least 10 $\mu\text{sec}/\text{div}$. resolution, and time-stamping capability.

The Fluke 43B Power Quality Analyzer is your best choice for these measurements. The Fluke ScopeMeter® 123 or 190 Series Test Tools are also good choices for this measurement. Both tools have plenty of single shot resolution and, most importantly, can timestamp the event so it can be correlated to whatever source—lightning, utility or electrical equipment—is causing the problem. Additionally, these tools are EN61010 600 V CAT III safety rated, an important consideration when purposely measuring high magnitude impulses in a high-energy environment.

If the drive is installed in a part of the country that is prone to lightning activity, be sure the building has proper surge protection that is functioning properly. Additionally, the building’s grounding system must be properly installed and functioning to help dissipate lightning strikes safely to earth, rather than through some path in the building’s power distribution system. Steps can and should be taken to minimize their effects on your electrical and electronic equipment, since a building that is susceptible to transients, sags and swells, is usually a building that is deficient in proper wiring and grounding.

If a transient voltage is expected, then the 43B is an excellent choice to measure and, more importantly, time stamp the transient so it can time correlated to whatever event caused the ASD fault.

If a transient causes the tripping, then an isolation transformer or series line reactor can be placed in series with the front end of the ASD. An alternate solution would be to place a surge protection device (SPD) at the motor control

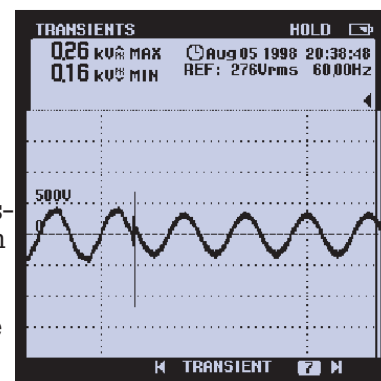

Figure 9A. Overvoltage transient capture.

center, or the primary side of the distribution transformer feeding the ASD. However, if the source of the transient is coming from another load on the same secondary feed as the ASD, then a separate isolation transformer or series line reactor may be needed directly in front of the ASD. Better yet, put the ASD on its own feed.

Voltage swells > 30 cycles can be monitored using the ScopeMeter TrendPlot™ mode or using some other type of line monitor. One way to mitigate the swell is to install a temporary dropout relay for as many cycles as the swell, but that can still be tolerated by the drive. The viability of this solution will be determined by the amount of “ride-through” the ASD’s input circuit can handle before the dc bus voltage drops to an under-voltage condition. Another possible solution is to use a voltage regulation device like an uninterruptible power supply (UPS), but it should be noted that most UPSs are designed to handle voltage sags and momentary interruptions and may not handle voltage swell conditions unless specifically designed to do so. Carefully check the UPS manufacturer specifications.

Overvoltages or long-term voltage drift can be caused by very large loads being turned off within the building or a slow response of the utility’s voltage regulation system to large reductions in demand on the power grid. This condition is easily discovered using the ScopeMeter TrendPlot™ feature. The best way to deal with this problem is to employ local voltage regulation with a device like a UPS that is designed to handle overvoltage as well as sags and dropouts.

Another common source for overvoltage on the dc bus is motor regeneration. This occurs when the motor load is “coasting” and begins to spin the motor shaft rather than getting spun by the motor, which causes the motor to change into a voltage generator and returns energy to the dc bus. Excessive regeneration can be measured by checking for a change in the direction of the dc current back into the dc bus while simultaneously checking the dc bus voltage for an increase above the trip point. When making measurements on the ASD’s dc bus, choose a CAT III 1000 V instrument. Typically a DMM such as the Fluke 170 Series or the 87V is useful because of their 1000 volt rating and min/max recording capability. If regeneration is causing the overvoltage tripping, something called “dynamic braking” can be employed which limits how fast the regenerative current is allowed to feed back into the dc bus capacitors.

If the dynamic braking has already been employed and is not functioning properly, then it can be tested according to the manufacturer’s specifications. If the brake is the resistor type, it can be visually inspected for signs of overheating; discoloration, cracking, or even smell for that distinctive aroma of an overheated component. The resistance value can also be measured against the manufacturer’s specifications. If the dynamic brake uses the transistor type, the silicon junctions can be tested using a diode test as described earlier. Also, the braking current can be measured and the current waveform compared with that of a known good system.

PWM Drives — Measurement 10

ASD “trip” problems — undervoltage

DC voltage too low

There are several possibilities for “nuisance” tripping of the low voltage fault circuit on ASD inverters. Voltage sags (.5 to 30 cycles) and under voltages (> 30 cycles) on the line input to the drive are common conditions associated with this problem. Sags are quite often caused by another load within the building’s distribution system being turned on, or perhaps from a neighboring building starting a large electrical load.

Make the measurement with an instrument that can time stamp the sag or where the undervoltage causes the ASD low voltage fault to trip. You may want to start making this measurement at the service entrance. This way you can quickly isolate whether the sag is being caused from within the building, or outside. Be sure to

monitor the voltage and current simultaneously. That way you can tell whether the problem is downstream from the service entrance where the surge in current is coincident with the voltage sag. An upstream (outside the building) problem would show the voltage sag without a corresponding surge in current. If the problem is within the building, there will be a current surge coincident with the voltage sag. Continue making the measurement at different load centers until you have isolated the load with the corresponding voltage sag and current surge.

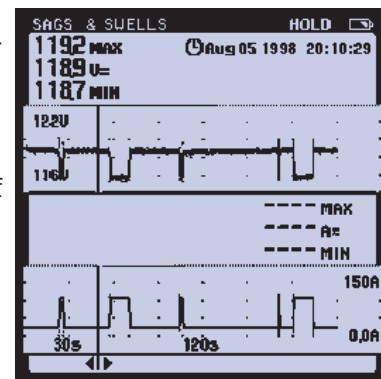

Figure 10A. Voltage sag.

Another possibility is a motor that is drawing enough current to cause the dc bus voltage to drop below the under-voltage fault setting, but not enough to trip the current overload. You will need to check the motor current for overloading (compare with motor nameplate) as well as verify whether the program settings of the drive are correct for the motor nameplate ratings, including the application for which the motor and drive were intended.

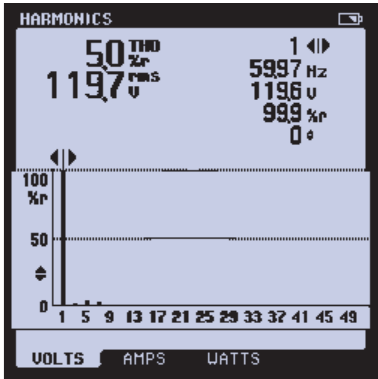

Figure 10B. DC bus voltage drop below under-voltage fault setting.

Look at the line input voltage waveform to the ASD. The wave-shape should be a nicely shaped sine wave. Severe “flat-topping” of the waveform can prevent the dc bus capacitors from fully charging to the peak value, which lowers the dc bus voltage as well as the amount of current available to the ASD output circuit.

The top waveform in Figure 10C is taken from a three-phase circuit. The current peaks of the bottom waveform occur when the voltage waveform is at or near its peak.

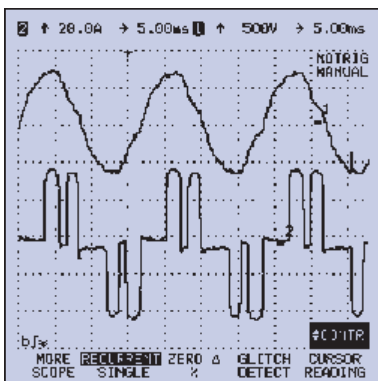

Figure 10C. Ideal line input voltage waveform.

However, if the current peaks become larger than the source can supply (i.e. source impedance is too high for the load), you get flat toping like the waveform shown here.

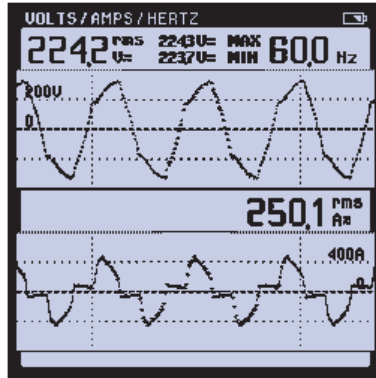

Figure 10C. Flat-topped waveforms.

Summary

In summary, while ASDs are more complex than standard electrical motors, a systematic approach to measurement and problem solving and the right test tools can help significantly simplify their installation, maintenance and troubleshooting. While the 10 measurements described here by no means cover everything you can know about ASDs, they will provide you the information you need for the majority of situations.

Fluke. Keeping your world up and running.®