

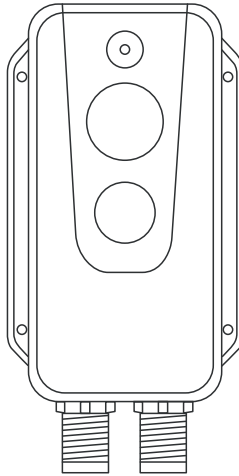

APEX 200 USER MANUAL

PLEASE READ THIS MANUAL BEFORE SWITCHING THE UNIT ON.
IMPORTANT SAFETY INFORMATION INSIDE.



ICI cameras fall under US Federal Law and Export Control.

Revision History

05.2022-001	Document created
08.2022-001	Updated Quick Start Instructions
12.2022-001	Updated specifications

Contents

1. Disclaimers	5
1-1 Terms and Conditions	5
1-2 U.S. Government Regulations	5
1-3 Copyright	5
1-4 Quality Assurance	5
1-5 Customer Help	5
2. User Notice	6
2-1 Calibration	6
2-2 Accuracy	6
2-3 Cybersecurity	6
2-4 Disposal of Electronic Waste	6
2-5 Intended Use	7
2-6 Manual Update	7
2-7 Scope of Application	7
2-8 Authoritative Versions	7
2-9 Training	8
3. Safety Information	9
4. Technical Specifications	11
5. Package Includes	13
6. Structure	14
6-1 Appearance and Definitions of Interface	14
6-2 Pin Configuration for Interfaces	15
6-2-1 Ethernet Pin Configuration (8-pin)	15
6-2-2 Ethernet Pin Configuration (12-pin)	15
7. Quick Start Instructions	16
7-1 Option 1: Rear Housing Installation	16
7-2 Option 2: Front Housing Installation	19
8. Operation Instructions	22
8-1 Power On/Off the Device	22
8-2 Manual IP Address Configuration	23
8-3 Alarms	23
8-3-1 Alarm Input	23
8-3-2 Alarm Output	23
9. APEX 200 Web Client	24
9-1 Recommended System Requirements	24
9-2 Recommended Browser	24
10. Protocols	25
10-1 Modbus TCP (M12 8-pin)	25
10-2 MQTT	25
11. Cleaning and Maintenance	33
11-1 Cleaning the Germanium Lens	33

11-2	Disinfecting the Camera Surface.....	33
11-3	Device Calibration.....	33
11-4	Storage	33
12.	Troubleshooting	34
12-1	Thermal imager does not power on.....	34
12-2	Thermal imager shuts off unexpectedly	34
12-3	No thermal image	34
12-4	Unclear or dark visible images	34
12-5	Image is stuck.....	34
12-6	Cannot log into software	34
12-7	Temperature readings are incorrect.....	35
13.	About ICI	36

1. Disclaimers

1-1 Terms and Conditions

Warranty Terms and Condition of Sale are made available online at:

<https://infraredcameras.com/support/terms-and-conditions-of-sale/>

1-2 U.S. Government Regulations

This product may be subject to U.S. Export Regulations. Please send any inquiries to support@infraredcameras.com

1-3 Copyright

© 2021, Infrared Cameras, Inc. All rights reserved worldwide. No parts of the software including source code may be reproduced, transmitted, transcribed or translated into any language or computer language in any form or by any means, electronic, magnetic, optical, manual or otherwise, without the prior written permission of Infrared Cameras, Inc.

The documentation must not, in whole or part, be copied, photocopied, reproduced, translated or transmitted to any electronic medium or machine readable form without prior consent, in writing, from Infrared Cameras, Inc. Names and marks appearing on the products herein are either registered trademarks or trademarks of Infrared Cameras, Inc. and/or its subsidiaries. All other trademarks, trade names or company names referenced herein are used for identification only and are the property of their respective owners.

1-4 Quality Assurance

Infrared Cameras, Inc. is committed to a policy of continuous development; therefore we reserve the right to make changes and improvements on any of the products without prior notice.

1-5 Customer Help

For customer help, visit:

<https://infraredcameras.com/support/>

E-mail:

support@infraredcameras.com

2. User Notice

2-1 Calibration

Annual calibration to the thermal camera is recommended. Contact customer service to schedule maintenance.

2-2 Accuracy

For very accurate results, we recommend that you wait a minimum of 5 minutes after you have started the camera before measuring a temperature.

2-3 Cybersecurity

After the products are connected to the Internet, they may face risks including but not limited to network attacks, hacker attacks, virus infections, etc. The company will not be responsible for the abnormal operation of the products and any loss or liability caused therefrom shall be at your own risk.

2-4 Disposal of Electronic Waste

Electrical and electronic equipment (EEE) contains materials, components and substances that may be hazardous and present a risk to human health and the environment when waste electrical and electronic equipment (WEEE) is not handled correctly.

Equipment marked with the below crossed-out wheeled bin is electrical and electronic equipment. The crossed-out wheeled bin symbol indicates that waste electrical and electronic equipment should not be discarded together with unseparated household waste, but must be collected separately.

All local authorities have established collection schemes under which residents can dispose of equipment at a recycling center or other collection points, or WEEE will be collected directly from households. More detailed information is available from the administration of the relevant local authority. Always dispose of waste in accordance with local, state, and federal regulations.



2-5 Intended Use

APEX 200 cameras are used for surface temperature assessment of energy emitted from the first 1/1000th of an inch of a subject.

Environment of use: industrial and petrochemical buildings, electrical plants, security rooms, science labs, animal reserves as well as environmental conservatories, and aerial integrations, among others.

You agree that this product is for civilian use only, and shall not use applications that may infringe the rights of third parties, medical and safety devices or other applications where product failure may lead to life-threatening or personal injury, as well as weapons of mass destruction, chemical and biological weapons, nuclear explosions, unsafe use of nuclear energy, dangerous or humanitarian purposes. Any loss or liability caused therefrom shall be at the your own risk.

2-6 Manual Update

The user manual will be updated from time to time. To access the latest manuals, translations of manuals, and notifications, go to:

<https://infraredcameras.com/product-resources/>

The manufacturer reserves the right to alter the specifications of the product without prior notification. The manufacturer allows himself the right to modify without any preliminary opinion the technical specifications of the product.

2-7 Scope of Application

Infrared Cameras, Inc. issues generic manuals that cover several cameras within a model line.

This means that this manual may contain descriptions and explanations that do not apply to your particular camera model. This manual may contain technical inaccuracies or typographical errors.

2-8 Authoritative Versions

The authoritative version of this publication is English. In the event of divergences due to translation errors, the English text has precedence.

Any late changes are first implemented in English. Other languages may or may not be available.

2-9 Training

To read about infrared training, visit:

<https://infraredtraininginstitute.com/>

3. Safety Information

- Operation is subject to the following two conditions: (1) This device may not cause harmful interference, and (2) this device must accept any interference received, including interference that may cause undesired operation.
- To prevent eye damage and personal injury, do not look into the laser. Do not point the laser directly at people or animals or indirectly off reflective surfaces.
- Do not disassemble or modify the thermal device.
- Do not point the imager (with or without the lens cover) at intensive energy sources, e.g. devices that emit laser radiation, or the sun. This can affect the accuracy of the camera, and cause damage to the detector.
- Do not use the imager in temperatures higher than 50 °C (122 °F) or lower than -10 °C (14 °F). High/low temperatures can cause damage to the device.
- Always charge the battery in the special temperature range. The temperature range to charge the battery is 0 °C to 40 °C (32 °F to 104 °F). Charging the battery at temperatures outside this range can cause the battery to become hot or to explode. It can also decrease the performance or the life cycle of the battery.
- Do not continue to charge the battery if it does not become charged in the specified charging time. If you continue to charge the battery, it can become hot and cause an explosion or ignition. Injury to persons can occur.
- Do not attach the batteries directly to a car's cigarette lighter socket. Using the incorrect equipment can cause the battery to become hot or cause an explosion.
- Only use the correct equipment to discharge the battery. Using the incorrect equipment can decrease the performance or the life cycle of the battery. Using the incorrect equipment can cause the battery to become hot or cause an explosion.
- Do not connect the positive terminal and the negative terminal of the battery to each other with a metal object (such as wire). Damage to the batteries can occur.
- The battery contains safety and protection devices which, if they become damaged, can cause the battery to become hot, or cause an explosion or an ignition.
- Do not put holes in the battery with objects. Damage to the battery may occur.
- Do not hit the battery with a hammer or apply strong impacts or electric shocks to it. Damage to the battery may occur.
- Do not put the battery in or near a fire, stove or other high-temperature locations. Damage or ignition of the battery may occur.
- Do not put the battery in direct sunlight or other high-temperature locations. Damage or ignition of the battery may occur.

- Do not solder directly onto the battery. Damage to the battery may occur.
- Do not get water or salt water on the battery or device or permit the device or battery to get wet. Damage to the battery may occur.
- Remove any water or moisture on the battery before you install it. Damage to the battery may occur.
- If there is a leak from the battery and the fluid gets into the eyes, do not rub the eyes. Flush well with water and immediately get medical care.
- Always dispose of battery in accordance with local, state and federal regulations.
- Do not use the battery if, when used, charged, or placed in storage, there is an unusual smell from the battery, the battery feels hot, changes color, changes shape, or is in an unusual condition. Speak with a sales office if one or more of these problems occurs.
- Clean the case with a damp cloth and a weak soap solution. Do not use abrasives, isopropyl alcohol, or solvents to clean the case or lens/screen.
- Be careful when cleaning the infrared lens. Do not clean the infrared lens too vigorously. This can damage the anti-reflective coating.
- Avoid condensation. Taking the imager from cold to hot will cause condensation in thermal imager. To protect the imager, power on the device and wait until it becomes warm enough for the condensation to evaporate.
- Keep device out of reach of children.
- Storage: If you do not use the imager for a long period of time, put the device in a cool and dry environment. Store the device in an ambient temperature of -40 °C to 70 °C (-40 °F to 158 °F).

THE ENCAPSULATION RATING IS ONLY APPLICABLE WHEN ALL OPENINGS ON THE CAMERA ARE SEALED WITH THEIR CORRECT COVERS, HATCHES, OR CAPS. THIS INCLUDES ANY CONNECTORS. ENCAPSULATION RATING DOES NOT EXTEND TO AFTER MARKET ATTACHMENTS, WORK PERFORMED BY A THIRD PARTY, OR CUSTOM INSTALLATIONS.

4. Technical Specifications

Pixel Resolution	256 x 192
Accuracy	± 2°C (± 3.6 °F) or ± 2%
Temperature Range	-20 °C to 550 °C (-4 °F to 1022 °F)
Operation Range	-10 °C to 50 °C (14 °F to 122 °F)
Storage Range	-40 °C to 70°C (-40 °F to 158 °F)
Detector Array	UFPA (VOx)
Pixel Pitch	12 µm
Focal Length	3.7 mm
FOV	56° x 42°
Focus	Fixed
Spectral Band	8 µm to 14 µm
Thermal Sensitivity (NETD)	< (40 mK) 0.04 °C at 30 °C (86°F)
Frame Rate	30 Hz
Humidity	95% non-condensing
Pixel Operability	> 99 %
Shock/Vibration	25 G/2 G
Dimensions (without lens)	109 mm x 55.9 mm x 29.5 mm (L x W x D ± 0.5 mm) (4.29" x 2.20" x 1.16" (L x W x H ± 0.02"))
Power	DC 12V to 24V, ≤ 2W, PoE support
Weight	170 g (6 oz)
Interface	<ul style="list-style-type: none"> 8 pin M12 A type connector: including 10M / 100M adaptive RJ-45 Ethernet port, and POE power supply 12 pin M12 A type connector: including DC power supply, alarm input and output
Protocols	<ul style="list-style-type: none"> Network: TCP, UDP, RTSP, HTTP, SMTP Interface: ONVIF, GB28181, Modbus TCP, MQTT
Streaming	<ul style="list-style-type: none"> Infrared: up to 4x, max 1024 x 768 Visible: 1920 x 1080
Video Format	MP4
Image Format	IR JPG (with data) + visible JPG
Image Polarity	18 options
Image Modes	IR, fusion (ICI Dual Vision), visible, picture-in-picture, enhanced
Memory	32 GB, internal
Digital Camera	2 MP, FOV: 72° x 61°

SPECIFICATIONS SUBJECT TO CHANGE WITHOUT NOTICE

IP Rating	IP67
Light	LED
Automatic alarms	
Alarm snapshot	
FTP file sharing and SMTP email support	
Internal non-uniformity correction (NUC)	
Remote reset and device reset button	

Specifications subject to change without further notice. Models and accessories subject to regional market considerations. License procedures may apply. Products described herein may be subject to US Export Regulations. Please refer to support@infraredcameras.com with any questions.

5. Package Includes

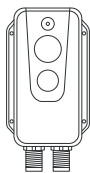

APEX 200

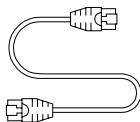

Ethernet Cable

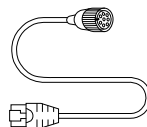

POE Ethernet Cable

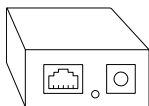

PoE Injector

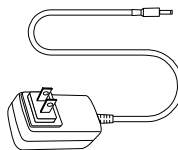

Power Adapter



M2 Screws x8

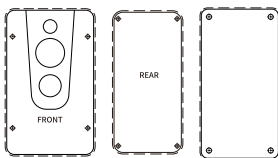

Alignment Guides



ST2.2 Screws x8

ENSURE ALL SYSTEM EQUIPMENT AND COMPONENT ITEMS ARE PRESENT BEFORE BEGINNING INSTALLATION

6. Structure

6-1 Appearance and Definitions of Interface

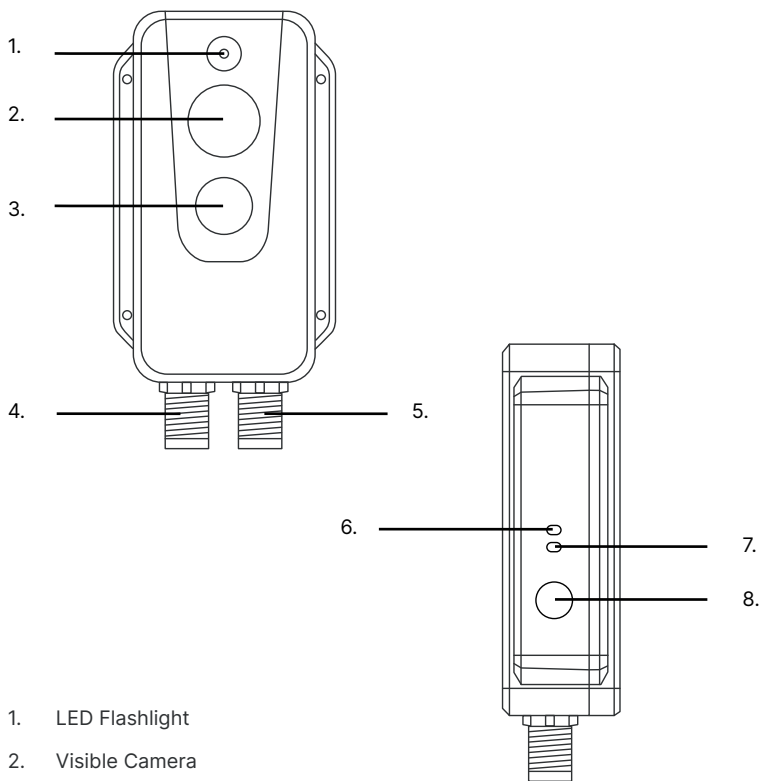

1. LED Flashlight
2. Visible Camera
3. Germanium Lens
4. 8-Pin M12 Connector (Ethernet and PoE cable interface)
5. 12-Pin M12 Connector (DC Power supply and alarm input/output)
6. Power Indicator
7. Network Indicator
8. Reset Button

6-2 Pin Configuration for Interfaces

6-2-1 Ethernet Pin Configuration (8-pin)

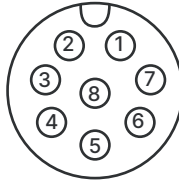

Pin	Configuration	Pin	Configuration
1	TX+	5	PD+
2	TX-	6	PD+
3	RX+	7	PD-
4	RX-	8	PD-

6-2-2 Ethernet Pin Configuration (12-pin)

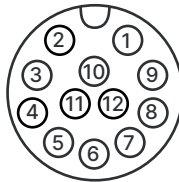

Pin	Configuration	Pin	Configuration
1	Power +	7	ALARM_POWER2
2	Power +	8	ALARM_OUT2
3	Power Ground	9	ALARM_IN+
4	Power Ground	10	ALARM_IN-
5	ALARM_POWER1	11	NC
6	ALARM_OUT1	12	NC

7. Quick Start Instructions

7-1 Option 1: Rear Housing Installation

USE THE ALIGNMENT GUIDES TO DRILL HOLES FOR SETTING DEVICE SCREWS.

DO NOT USE TOO LONG SCREWS WHEN INSTALLING THE FRONT/REAR MOUNTING BRACKET. USING SCREWS THAT ARE TOO LONG MAY DAMAGE THE THERMAL CAMERA.

THE MAXIMUM HOLE DEPTH OF THE FRONT SHELL IS 10 MM (0.4 IN), AND THE MAXIMUM HOLE DEPTH OF THE REAR SHELL IS 4 MM (0.16 IN).

A.

Place the rear facing alignment guide on the mounting position and drill four $\Phi 2.5$ mounting holes according to the markers on the alignment guide.

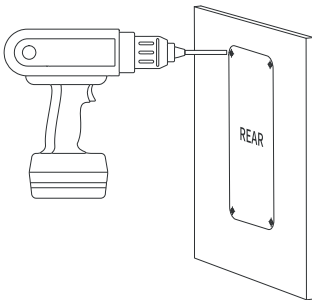

B.

Mount the device with four M2 screws.

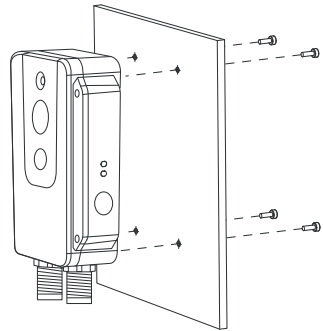

THE THERMAL DEVICE WILL ACCUMULATE HEAT DURING OPERATION. ICI RECOMMENDS MOUNTING THE THERMAL DEVICE TO METALLIC OBJECTS AT ITS REAR HOUSING WHICH CAN REDUCE DEVICE HEATING AS WELL AS DECREASE THE TEMPERATURE DRIFT OF THE DETECTOR.

C.

Align the 8-pin connector of the POE Ethernet cable to the 8-pin receptor on the device; then, plug in the cable.

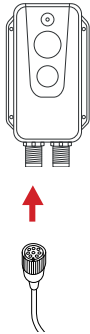

D.

Rotate the securing nut to the right to lock cable in place. Rotate the securing nut to the left to unlock the cable.

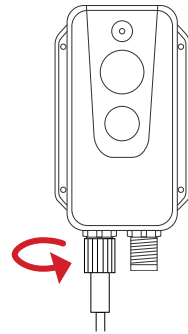

ALIGN THE PINS BEFORE TRYING TO CONNECT THE POE ETHERNET CABLE. DO NOT FORCE THE POE ETHERNET CABLE ONTO THE DEVICE. FORCING THE CABLE ONTO THE DEVICE MAY RESULT IN DAMAGE TO THE PINS.

ALTERNATIVELY, POWER CAN BE PROVIDED THROUGH THE 12-PIN CONNECTOR VIA A 12-PIN CABLE (NOT PROVIDED).

E.

Plug the Ethernet end of the POE Ethernet cable into the back of the PoE injector.

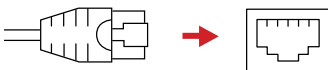

F.

Plug the jack end of the power adapter into the front of the PoE injector.

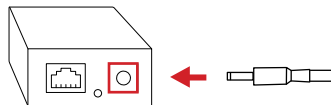

G.

Plug the power adapter into a 110/120V electrical outlet.

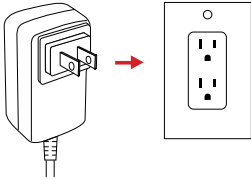

H.

Plug one end of the Ethernet cable into the front of the PoE injector.

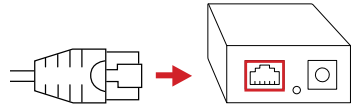

I.

Plug the other end of the Ethernet cable into the back of the network router.

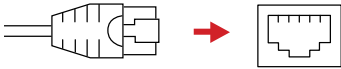

J.

Power on device.



THE THERMAL IMAGER NEEDS SUFFICIENT WARM-UP TIME FOR THE MOST ACCURATE TEMPERATURE MEASUREMENTS AND BEST IMAGE QUALITY. THIS TIME CAN OFTEN VARY BY ENVIRONMENTAL CONDITIONS. IT IS BEST TO WAIT A MINIMUM OF 10 MINUTES FOR THE DEVICE TO COMPLETELY WARM-UP.

K.

Connect to the device through an Internet browser.

7-2 Option 2: Front Housing Installation

USE THE ALIGNMENT GUIDES TO DRILL HOLES FOR SETTING DEVICE SCREWS.

DO NOT USE TOO LONG SCREWS WHEN INSTALLING THE FRONT/REAR MOUNTING BRACKET. USING SCREWS THAT ARE TOO LONG MAY DAMAGE THE THERMAL CAMERA.

THE MAXIMUM HOLE DEPTH OF THE FRONT SHELL IS 10 MM (0.4 IN), AND THE MAXIMUM HOLE DEPTH OF THE REAR SHELL IS 4 MM (0.16 IN).

A.

Place the front facing alignment guide on the mounting position and drill four $\Phi 2.5$ mounting holes according to the markers on the alignment guide.

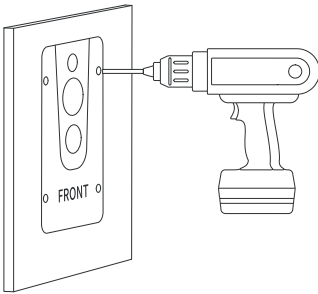

B.

Mount the device with four ST2.2 self-tapping screws.

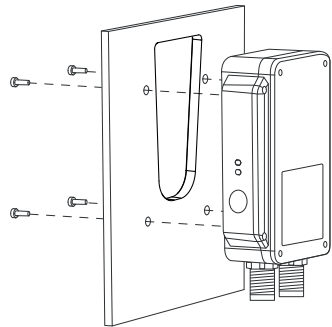

THE THERMAL DEVICE WILL ACCUMULATE HEAT DURING OPERATION. ICI RECOMMENDS MOUNTING THE THERMAL DEVICE TO METALLIC OBJECTS AT ITS REAR HOUSING WHICH CAN REDUCE DEVICE HEATING AS WELL AS DECREASE THE TEMPERATURE DRIFT OF THE DETECTOR.

C.

Align the 8-pin connector of the POE Ethernet cable to the 8-pin receptor on the device; then, plug in the cable.

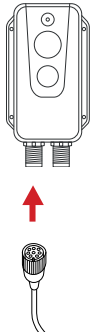

D.

Rotate the securing nut to the right to lock cable in place. Rotate the securing nut to the left to unlock the cable.

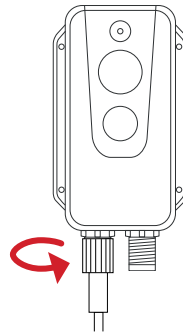

ALIGN THE PINS BEFORE TRYING TO CONNECT THE POE ETHERNET CABLE. DO NOT FORCE THE POE ETHERNET CABLE ONTO THE DEVICE. FORCING THE CABLE ONTO THE DEVICE MAY RESULT IN DAMAGE TO THE PINS.

ALTERNATIVELY, POWER CAN BE PROVIDED THROUGH THE 12-PIN CONNECTOR VIA A 12-PIN CABLE (NOT PROVIDED).

E.

Plug the Ethernet end of the POE Ethernet cable into the back of the PoE injector.

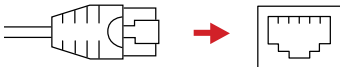

F.

Plug the jack end of the power adapter into the front of the PoE injector.

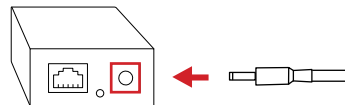

G.

Plug the power adapter into a 110/120V electrical outlet.

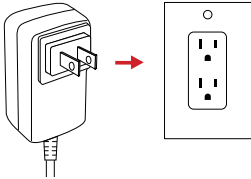

H.

Plug one end of the Ethernet cable into the front of the PoE injector.

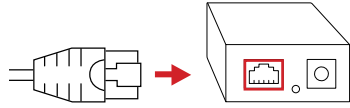

I.

Plug the other end of the Ethernet cable into the back of the network router.

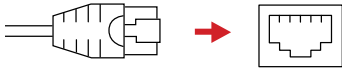

J.

Power on device.



THE THERMAL IMAGER NEEDS SUFFICIENT WARM-UP TIME FOR THE MOST ACCURATE TEMPERATURE MEASUREMENTS AND BEST IMAGE QUALITY. THIS TIME CAN OFTEN VARY BY ENVIRONMENTAL CONDITIONS. IT IS BEST TO WAIT A MINIMUM OF 10 MINUTES FOR THE DEVICE TO COMPLETELY WARM-UP.

K.

Connect to the device through an Internet browser.

8. Operation Instructions

8-1 Power On/Off the Device

After installing the thermal camera in the preferred position, use the cable to connect the thermal camera and the computer as normal. There are two power supply methods for the APEX 200:

1. Do one of the following:
 - Connect the device to the PoE port of the power supply through the 8-pin adapter cable, or
 - Connect to a DC power supply through the 12-pin adapter cable.
2. Connect the APEX 200 to the network.
3. Power on the device, and wait for 2 minutes. The power indicator light is steady blue when fully powered. The network indicator light flashes green when the network connection is normal.
4. Modify the computer network segment (see Section 8-2 Manual IP Address Configuration).

Temperature measurement and analysis is most accurate after 30 minutes. Monitoring is available through the computer software (see Chapter 0-0 Software)

THE THERMAL IMAGER NEEDS SUFFICIENT TIME TO WARM-UP FOR THE MOST ACCURATE TEMPERATURE MEASUREMENTS AND BEST IMAGE QUALITY. THIS TIME CAN OFTEN VARY BY ENVIRONMENTAL CONDITIONS. IT IS BEST TO WAIT A MINIMUM OF 10 MINUTES FOR THE DEVICE TO COMPLETELY WARM-UP.

AFTER POWERING OFF, WAIT TEN SECONDS BEFORE ATTEMPTING TO POWER THE DEVICE ON AGAIN.

8-2 Manual IP Address Configuration

Configure the network to be the same as the thermal camera as follows:

1. Connect the device to a network. Follow company security policies when connecting to networks.
2. Click Windows icon.
3. Click Settings.
4. Click on Network and Internet.
5. Click Ethernet.
6. Click Change Adapter Options.
7. Double-click Ethernet.
8. Click Properties.
9. Double-click on Internet Protocol Version 4 (TCP/IPV4) Properties.
10. Modify the IP address of the computer to match the same network as the device, e.g. 192.168.1.100. The default IP address of the device is 192.168.1.20.
11. The Subnet Mask should read 255.255.255.0. If it does not, click in the input box and fill in the correct number.
12. Click OK.
13. Power on the device.
14. Determine if the connection is normal. The host network connection is normal if the power indicator is a constant blue and the network indicator is flashing green.

8-3 Alarms

8-3-1 Alarm Input

The device supports 1 active alarm input (photoelectric isolation), and the input voltage range is 3V ~ 5.5V.

8-3-2 Alarm Output

The device supports 2 alarm outputs (switch value and photoelectric isolation), 3V ~ 25V DC, maximum 85 m.

9. APEX 200 Web Client

ICI's APEX 200 Web Client is a comprehensive application software. It enables users to monitor equipment, collect temperature data, set alarms, and perform thermal analysis from a single monitoring station.

The APEX 200 Web Client arrives installed on the device. It is accessible after connecting to the device through an Internet browser. An Internet connection is required.

Users must follow their company security policies when connecting to networks.

9-1 Recommended System Requirements

- Operating system: Window XP or above
- Microsoft Visual C++ 2010 or above
- DirectX 11 or above
- Processor: i5 or above
- RAM: 4 GB or above
- Hard Disk: 256 GB or higher with memory disk 2 G or above
- Resolution: 1920 × 1080

9-2 Recommended Browser

The Google Chrome is recommended for the web client to run smoothly. Other web browsers may or may not function properly.

GOOGLE CHROME BROWSER IS RECOMMENDED.

10. Protocols

10-1 Modbus TCP (M12 8-pin)

This device supports Modbus TCP protocol for transmitting temperature measurement information. A M12 8-pin to RJ45 cable is required when using this protocol.

IP	Camera IP (default: 192.168.1.20)		
Port	1502		
Register Address	R/W	Length (word)	Data
0x0001	R	2	Version No., e.g. 0x0102 0x0304 = V1.2.3.4
0x0003	R	1	
0x0004	R	1	
0x0005	R	1	
0x0006	R	1	
0x0007	R	2	The highest temperature of the entire frame, The actual temperature = (register value-2732) / 10.0
0x0009	R	2	The average temperature of the entire frame
0x000B	R	2	The lowest temperature of the entire frame
0x000D+N*4	R	1	Region attributes: Bit0: region validness Bit1~2: region type, box=0, line=1, point=2 Bit3: whether temperature alarm is on Bit4: whether to trigger an alarm
0x000E+N*4	R	1	The highest temperature in the region
0x000F+N*4	R	1	The average temperature in the region
0x0010+N*4	R	1	The lowest temperature in the region
*N: 0~15			

10-2 MQTT

The device supports the MQTT protocol, as defined below:

1. The server sends the subject.
2. Set the configuration MQTT parameters through the software, and enable the MQTT function. The configuration will be valid after saving and restarting. The camera will automatically connect to the MQTT server after restarting.
3. Data format is shown on next pages:

Image data:

```
{
  "timestamp": "2021.4.9.15:52", #time stamp
  "ip": "192.168.1.21", #camera IP
  "type": 0, #data type: 0-image 1-temperature 2-temperature measurement
  "resolution": "1280*720", #visible light resolution
  "resolution": "1024*768", #thermal resolution
  "formate": ".jpg", #image format
  "image": "....." # visible light image data base64 encode
  "ir_image": "....." # thermal image data base64 encode
}
```

Temperature data:

```
{
  "timestamp": "2021.4.9.15:52", # time stamp
  "ip": "192.168.1.21", #camera IP
  "type": 1, # data type: 0-image 1-temperature 2-temperature measurement
  "unit": "C", #Unit: °C
  "data": "....." # temperature data base64 encode
}
```

Temperature measurement data: temperature measurement function needs to be enabled in Web

interface.

```
{
  "timestamp": "2021.4.9.15:52", # time stamp
  "ip": "192.168.1.21", # camera IP
  "type": 2, # data type: 0-image 1-temperature 2-temperature measurement
  "subnetmask": "255.255.255.0", #subnet mask
  "gateway": "192.168.1.1", #gateway
  "mac": "86:5D:55:0B:A9:74", #MAC address
  "uptime":33, #boot time
  "version": "V0.2.7", #software version
  "airTemp": 25, #air temperature(°C)
  "airtransmissivit": 1, #air transmittance
}
```

```
"distance": 3, #distance(m)
"emissivity": 0.95, # emissivity
"reflectemp": 25, # reflection temperature(°C)
"maxtemp": 45.6, #maximum temperature of frame(°C)
"mintemp": 44.9, # minimum temperature of frame(°C)
"avgtemp": 45.3, #average temperature of frame(°C)
"list": [{ # 16 data in the temperature measurement area, enable=1 is valid
  "index": 0, # temperature index
  "enable":1, #enable temperature measuring or not
  "type": 0, #type: 0- rectangle 1-line 2-point
  "x0": 67, #start: x value
  "y0": 61, #start: y value
  "x1": 125, #end: x value
  "y1": 98, #end: y value
  "maxTemp": 45.5, # maximum temperature of the region(°C)
  "minTemp": 45, # minimum temperature of the region(°C)
  "avgTemp": 45.3# average temperature of the region(°C)
}, {
  "index": 1,
  "enable":0,
  "type": 0,
  "x0": 0,
  "y0": 0,
  "x1": 0,
  "y1": 0,
  "maxTemp": 0,
  "minTemp": 0,
  "avgTemp": 0
}, {
  "index": 2,
  "enable":0,
  "type": 0,
```

```
"x0": 0,  
"y0": 0,  
"x1": 0,  
"y1": 0,  
"maxTemp": 0,  
"minTemp": 0,  
"avgTemp": 0  
}, {  
"index": 3,  
"enable":0,  
"type": 0,  
"x0": 0,  
"y0": 0,  
"x1": 0,  
"y1": 0,  
"maxTemp": 0,  
"minTemp": 0,  
"avgTemp": 0  
}, {  
"index": 4,  
"enable":0,  
"type": 0,  
"x0": 0,  
"y0": 0,  
"x1": 0,  
"y1": 0,  
"maxTemp": 0,  
"minTemp": 0,  
"avgTemp": 0  
}, {  
"index": 5,  
"enable":0,
```

```
"type": 0,  
"x0": 0,  
"y0": 0,  
"x1": 0,  
"y1": 0,  
"maxTemp": 0,  
"minTemp": 0,  
"avgTemp": 0  
}, {  
"index": 6,  
"enable": 0,  
"type": 0,  
"x0": 0,  
"y0": 0,  
"x1": 0,  
"y1": 0,  
"maxTemp": 0,  
"minTemp": 0,  
"avgTemp": 0  
}, {  
"index": 7,  
"enable": 0,  
"type": 0,  
"x0": 0,  
"y0": 0,  
"x1": 0,  
"y1": 0,  
"maxTemp": 0,  
"minTemp": 0,  
"avgTemp": 0  
}, {  
"index": 8,
```

```
"enable":0,  
"type": 0,  
"x0": 0,  
"y0": 0,  
"x1": 0,  
"y1": 0,  
"maxTemp": 0,  
"minTemp": 0,  
"avgTemp": 0  
}, {  
"index": 9,  
"enable":0,  
"type": 0,  
"x0": 0,  
"y0": 0,  
"x1": 0,  
"y1": 0,  
"maxTemp": 0,  
"minTemp": 0,  
"avgTemp": 0  
}, {  
"index": 10,  
"enable":0,  
"type": 0,  
"x0": 0,  
"y0": 0,  
"x1": 0,  
"y1": 0,  
"maxTemp": 0,  
"minTemp": 0,  
"avgTemp": 0  
}, {
```

```
"index": 11,  
"enable":0,  
"type": 0,  
"x0": 0,  
"y0": 0,  
"x1": 0,  
"y1": 0,  
"maxTemp": 0,  
"minTemp": 0,  
"avgTemp": 0  
}, {  
"index": 12,  
"enable":0,  
"type": 0,  
"x0": 0,  
"y0": 0,  
"x1": 0,  
"y1": 0,  
"maxTemp": 0,  
"minTemp": 0,  
"avgTemp": 0  
}, {  
"index": 13,  
"enable":0,  
"type": 0,  
"x0": 0,  
"y0": 0,  
"x1": 0,  
"y1": 0,  
"maxTemp": 0,  
"minTemp": 0,  
"avgTemp": 0
```

```
}, {  
  "index": 14,  
  "enable": 0,  
  "type": 0,  
  "x0": 0,  
  "y0": 0,  
  "x1": 0,  
  "y1": 0,  
  "maxTemp": 0,  
  "minTemp": 0,  
  "avgTemp": 0  
}, {  
  "index": 15,  
  "enable": 0,  
  "type": 0,  
  "x0": 0,  
  "y0": 0,  
  "x1": 0,  
  "y1": 0,  
  "maxTemp": 0,  
  "minTemp": 0,  
  "avgTemp": 0  
}]  
}
```

11. Cleaning and Maintenance

11-1 Cleaning the Germanium Lens

Do not use corrosive chemicals on the optical glass components. The germanium window surface is coated with anti-reflection coating. Dust, grease, and fingerprints will produce harmful substances and lead to a decline in performance, or cause scratches. If dirt is found, please use the following methods:

1. Use a blown balloon or a soft brush to clean the lens surface to avoid dust particles scratching the anti-reflection film on lens surface during the wiping process.
2. Use a soft cotton or microfiber cloth or lens wiping paper and dip in distilled water. Gently wipe the lens surface from the middle to the edge, paying attention to not crack the lens, or use too much liquid. If the lens is still not clean, replace the cloth and repeat the wiping process.

11-2 Disinfecting the Camera Surface

Do not use corrosive cleaning solutions on the optical glass components. It is recommended to disinfect the camera surface regularly with a non-corrosive sanitizing product. Follow the directions provided by the manufacturer of the cleaning solution. Adhere to the sanitation protocols and cleaning schedule set forth by the employer.

11-3 Device Calibration

It is recommended to have the device(s) re-calibrated annually. Contact customer service to schedule maintenance.

11-4 Storage

When the equipment is not in use, the device should be placed in a dust-free and moisture-free environment with a stable temperature and humidity.

DO NOT USE CORROSIVE CLEANING SOLUTIONS ON THE OPTICAL GLASS COMPONENTS. DISINFECT THE CAMERA SURFACE REGULARLY WITH A NON-CORROSIVE SANITIZING PRODUCT.

CALIBRATE YOUR DEVICES ANNUALLY. CONTACT CUSTOMER SERVICE TO SCHEDULE MAINTENANCE.

12. Troubleshooting

If the user encounters any problems while using the imager, refer to the following options. If the problem persists, disconnect the power and contact the customer support department.

12-1 Thermal imager does not power on

- Ensure cables are connected properly
- Check whether the power supply voltage is between 12V to 24V

12-2 Thermal imager shuts off unexpectedly

- Ensure cables are connected properly

12-3 No thermal image

- Ensure cables are connected properly
- If lens is foggy, use professional equipment to clean the lens

12-4 Unclear or dark visible images

- If lens is foggy, use professional equipment to clean the lens

12-5 Image is stuck

- Ensure cables are connected properly
- Restart the software

12-6 Cannot log into software

- Manually configure the computer address.
- Restart the software
- Contact customer support

12-7 Temperature readings are incorrect

- Turn off the device; then, turn it back on
- To ensure the accuracy of temperature measurement, you are recommended to wait for 5 to 10 minutes after turning on the thermal imager and before temperature measurement.
- Ensure the correct temperature range is selected:
 - The default temperature range is -40 °C to 150 °C (-40 °F to 302 °F)
 - When measuring high temperature objects ensure the temperature range is set to the 100 °C to 800 °C (212 °F to 1472 °F) range
- Device is at proper height
- Ensure device is in focus
- Adjust emissivity
- Adjust for ambient temperature
- Wait for or perform a manual NUC operation
- Send the device in for recalibration
- Restart the software

13. About ICI

ICI manufactures complete systems and software. We can provide complete engineering, software, and OEM solutions. Our Fortune 500 clients rely on us for infrared equipment and thermography training (which we offer through the Infrared Training Institute).

In addition to providing custom germanium, silica, and sapphire optics, we also build windows for enclosures, as well as custom pan and tilt units. We can even provide customizable explosion-proof systems.

Our knowledge and experience stems from years of using infrared imaging and temperature measurement instruments to provide solutions to: managers, engineers, scientists, inspectors and operators in space, power companies, medical, pulp and paper, food industry, research and development, and various process industries. You can see our products and services used in industrial, commercial, and government applications worldwide. Additionally, our ICI 7320 was awarded "Product of the Month" by NASA*. Originally named Texas Infrared (still DBA), Infrared Cameras, Inc. has been in business since March, 1995.

Thank you for your dedicated and continued support.

Infrared Cameras, Inc.
2105 W. Cardinal Dr.
Beaumont, TX 77705

Phone: (409) 861-0788
Toll Free: (866) 861-0788
International: (409) 861-0788

Customer Support: support@infraredcameras.com
Website: www.infraredcameras.com

You may reach a customer care representative by phone or email during regular business hours: Monday – Friday 8:00AM - 5:00PM CST.

*Volume 33 No. 2, February 2009 edition of NASA Tech Briefs