

pricelist

effective January 6, 2025

GSA Contract GS-28F-0030U
SIN #33721

FLUX

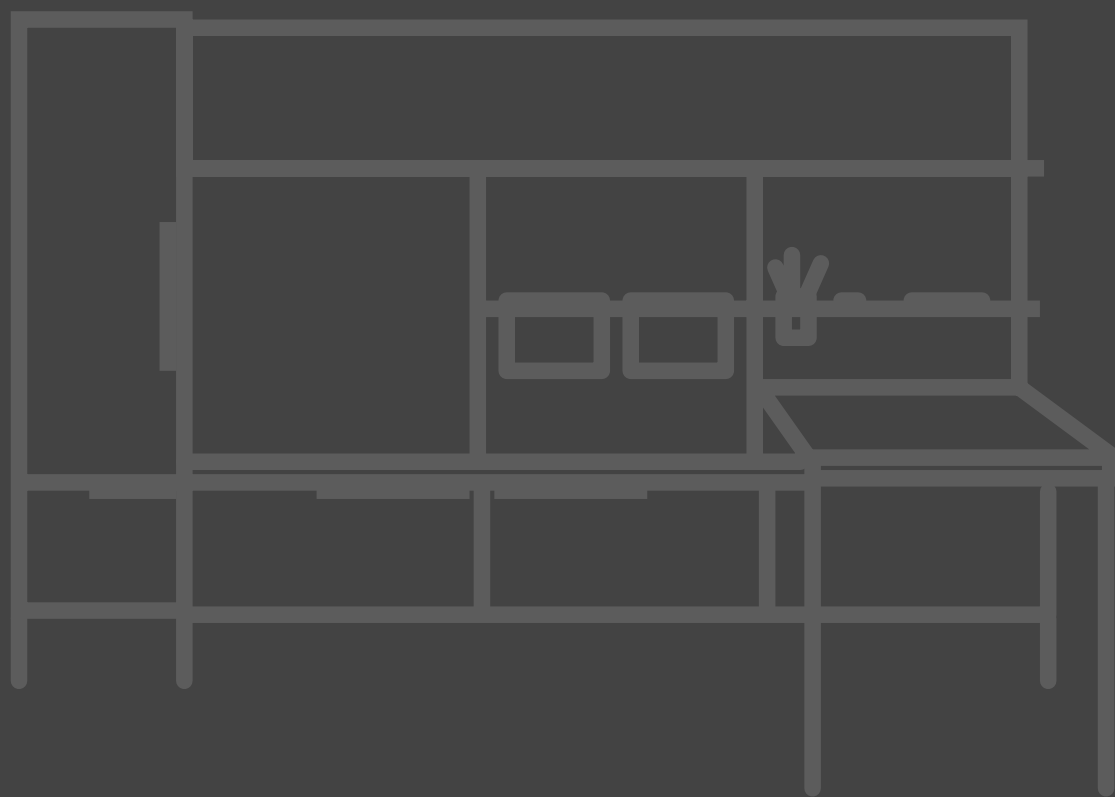

JSI Price Lists

Tables + Casegoods

- [Bourne Tables](#)
- [Brogan](#)
- [Copilot](#)
- [Finale](#)
- [Lincoln](#)
- [Native](#)
- [Nosh](#)
- [Privacy Program](#)
- [Prost](#)
- [Reef](#)
- [Romy](#)
- [Traditional](#)
- [Trail](#)
- [Walden](#)
- [Wellington](#)
- [Accessories](#)

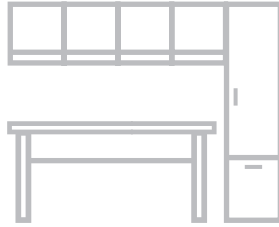

Lok

- [Training Tables](#)
- [Teamwork Tables](#)
- [Conference Tables](#)
- [Occasional Tables](#)



Flux

- [Private Office](#)

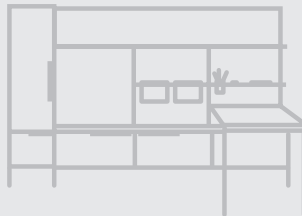

Healthcare

- Seating
 - [Kindera](#)
 - [Satisse](#)
 - [Somna](#)
- Casework
 - [Forge](#)



Vision

- [Casegoods](#)
- [Tables](#)



Seating

- | | |
|-----------------------------------|--------------------------|
| Addison | Knox |
| Americana | Kyla |
| Ansen | Mackey |
| Arwyn | Madison |
| Avini | Millie |
| BeSpace | Moto |
| Boston | Newton |
| Bourne Seating | Oxley |
| Bryn | Pillow |
| Caav | Poet |
| Class Act | Protocol |
| Collective Motion | Proxy |
| Connect | Ramona |
| Cosgrove | Ria |
| Encore | Sosa |
| Finn | Teekan |
| Finn Nu | Totem |
| Garvey R5 | Trinity |
| Gatsby | Wink |
| Harbor | Ziva |
| Henley | |
| Hoopz | |
| Indie | |
| Jude | |



Environmental Mission

Our vision and goal is a sustaining supplier, manufacturer and customer for the long term protection and preservation of our environment for future generations.

MISSION

To achieve this vision, we are dedicated to ensuring the health and wellbeing of all of our partners, reducing negative impact on the environment, and maintaining price structure by increasing efficiencies and reducing consumption.

JSI, and it's parent company, is an internal manufacturer and has been an environmentally conscious organization for more than 80 years.

We are proud to use wood as our primary sustainable material resource and all corporate policies and procedures support the efforts to "recover, recycle, reuse, repurpose, reduce, refuse, and re-engineer". In doing this, we are committed to the conservation of the environment and its natural resources as well as encouraging our suppliers and customers to do the same. A goal of a "Sustainable Partnership", supplier, manufacturer and customer, is essential for the long term protection preservation and sustainability of our environment for future generations.

LOCATION

Our manufacturing facilities are located in the center of Southern Indiana. With our diverse product offering and manufacturing capabilities, we provide a single source for all of your project needs allowing you to conserve our fossil fuels and reduce greenhouse gases.

PACKAGING

We place emphasis on the minimal use of disposable packaging while still providing adequate protection to the finished product. Our corrugated packaging is recyclable, reusable, and up to 100% recycled content. We reuse or recycle more than 175 tons of corrugated material annually.

REGULATORY

All of our manufacturing facilities are in compliance with applicable OSHA regulations and meet or exceed all applicable DEM and EPA regulations for air emissions, storm water and hazardous waste disposal.

MANUFACTURING FACILITIES

Our manufacturing facilities are geared toward eco-efficiency and are encouraged to continually improve and conserve. Solid wood not used in the direct manufacturing process is recovered for the operation of our dry kilns, thus reducing greenhouse gases, the use of fossil fuels, and the burden of waste placed on landfills. Composite panels not used in the direct manufacturing process are ground and sold for use as animal bedding and boiler fuel. In addition to other energy savings techniques, our manufacturing facilities use high efficient lighting, make use of power factor capacitors, and encourage all to conserve and reduce energy consumption and water usage. Condensation pumps are used to aid in water conservation as well as extending boiler life.

MANUFACTURING PROCESSES

Our finish processes utilize efficient spray guns and proper spray techniques to reduce wasted material. Excess finish material, solvents, and waste are recycled. Many of the assembly processes use water based glues that contain no hazardous ingredients.

TEXTILES

Many of our fabric options utilize up to 100% recycled content. Our leather alternative program includes selections that contain no toxic materials, plasticizers, heavy metals, or formaldehyde and have a 100% biodegradable back cloth. Some of the available panel fabric used, if discarded is a biological nutrient for the soil. Most of the components (foam, batting, and polycord) used in upholstered products are recyclable. Excess fabrics and leathers not utilized in the upholstery process go to recyclers and local charities for additional use.

WOOD

Wood is the most diverse, most process friendly, and most widely utilized natural resource in mankind's history. No other natural resource can match the environmental advantages of wood, including being renewable, recyclable, natural, carbon negative, and biodegradable. Utilizing the sun's energy, trees grow and remove carbon dioxide from the air while giving off oxygen to benefit the entire planet. Approximately 49% of wood's dry weight is carbon and harvesting mature trees in a sustainable forest, which has slowed in the absorption of carbon dioxide, allows the photosynthetic cycle to continue at full optimization and allow for the carbon to remain sequestered. We are proud to use wood as our primary "sustainable" renewable resource.

WOOD OPTIONS

Many environmentally friendly solid wood and engineered wood options are available for quote, including: Lyptus®, Plyboo®, reclaimed woods, agricultural and post-consumer waste fiber products, etc.

INDOOR AIR QUALITY

Our goal is to reduce the impact our products will have on the indoor air quality. We practice the latest technologies and utilize a third party to assure we meet this goal. GreenGuard, one of the leaders in IAQ certification, continues to certify our product offering with UL2818-GreenGuard Indoor Air Quality certification.

PARTNERSHIPS

BIFMA
Business and Institutional Furniture Manufacturer Association
 USGBC
United States Green Building Council
 IIDA
International Interior Design Association
 FSC
Forest Stewardship Council - Forestland
 UL GreenGuard
Indiana Department of Natural/Resources - Division of Forestry - Classified Forest, Wildlands Program

Lifetime Warranty

JSI warrants to the original purchaser that each piece of furniture will be free from defects in workmanship, given normal use and care for as long as the original customer owns and uses the product. Normal use is defined as the equivalent of a single shift, 40-hour work week.

JSI will, at its option, repair or replace with comparable product within the terms of the warranty.

Exceptions to Warranty:

12 Years (from date of purchase)

- Wood Seating
- Seating Controls
- Pneumatic Cylinders
- Laminate Surfaces
- Veneer Surfaces
- Solid Surface Components
- Somna, Kindera, Satisse and Forge in multi-shift environment except components as specifically identified below

10 Years (from date of purchase)

- Recliner Mechanisms and Associated Levelers (regardless of shift usage)

5 Years (from date of purchase)

- Casters (including recliner central locking)
- Glides (including MagLinx™)
- Electric Height Adjustable Bases
- Task Lights
- Mesh/Knit Materials
- Electrical Components
- Foam
- Recliner Heat Components

This Warranty Does Not Cover:

- Natural variations in color, grain or texture of wood and other covering materials over which JSI has no control
- Normal wear, color fastness, shrinkage, puddling, wrinkling and stretching of upholsteries including fabric, vinyl, leather and other textiles. This warranty does not cover any defects that may arise in the use of COM or COL upholstery materials. Textile manufacturer's warranty will apply.
- Damages resulting from transportation, improper assembly, installation, handling, accident, user modification attachments, misuse, or neglect of product care.
- Damage resulting from extreme climate conditions
- Finish damages resulting from normal wear and tear, improper maintenance, water damage, exposure to sunlight, extreme high or low humidity or temperature, or other acts of nature.
- Damage created by loading file drawers with anything other than hanging folders.
- Use of any unauthorized non-JSI components for use in the place of JSI components, including but not limited to worksurfaces, bases, brackets, or other essential components.

Replacement components are warranted for a duration of 2 years or for the remaining duration of the initial warranty, whichever extends further.

Textile supplier's warranty will apply. Given the diverse range of cleaning agents used by various facilities, it is advisable to conduct testing on each textile choice using the facility's designated cleaning techniques prior to placing an order.

JSI makes no expressed or implied warranties to any product and, in particular, makes no warranty of merchantability of fitness for any particular purpose. JSI will not be liable for any consequential or incidental damages under this warranty.

Unique Characteristic of Natural Woods and Veneers

JSI uses high quality wood and veneer harvested from sustainably managed forests. Every tree has unique and defining characteristics, like fingerprints. These characteristics can be defined by differences in color, grain configuration, and textures. These characteristics will be more noticeable if the product has a clear or lighter finish.

JSI uses select beech, cherry, maple, oak and walnut cut wood products to produce the desired look of our furniture products.

Maple and Cherry species have a higher degree of uneven distribution of grain, small color streaks, and pin knots.

At JSI, we take care of selecting woods and veneers that are used in our products. With this in mind, we hope you appreciate the beauty of each tree's fingerprints. Products will not be replaced due to these natural characteristics.

Veneers can be sliced in a variety of ways to create unique patterns. JSI uses several different patterns, as shown below.

Flat (Plain) Cut as shown



Quarter Sliced as shown

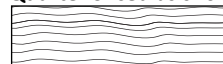

Double Cut as shown



Rift Cut as shown



Double Cut

The Double Cut veneer is a processed product that has at least two cuttings to create the final veneers. These cuts of veneer strands are dyed and layered into a block to create variation of patterns from a very tight grain pattern to an exotic figure grain pattern.

JSI offers two collection of veneer, our Essentials and Artisan Collections.

Essentials

The Essentials Collection allows users to specify beautiful veneers, without sacrificing budget, providing grain patterns and hues for maximum material flexibility and style range.

Artisan

The Artisan Collection provides a curated selection of finishes expressing an elevated style and contemporary nature.

Laminates (Veneer Series)

An alternative HPL (Higher Pressure Laminate) laminate work surface can be specified on most of our casegood product lines. The specification pages will also list the available coordinating finishes.

Laminate Series

JSI laminate series offer a full laminated product with imprinted grain to hide finger prints and provide durability. The worksurface tops are HPL (High Pressure Laminate) or TFL (Thermal Fused Laminate). TFL is used on the product's chassis.

An overview of finishes and laminates appear on page IV, detailing which species each veneer finish is applied to.

Series Material Offering

Select finishes, species and materiality are available on a per series offering, with JSI curating the correct palette offering for the series intent. Please refer to each series feature highlights within the product pages to identify the material, species, grain patterns and finishes available for that specific series.

JSI Core Materials

For projects requiring similar finishes across multiple series, JSI recommends using our Core Materials program. Finishes in this group are offered throughout the vast majority* of JSI products in the three main material categories Essentials and Artisan Veneer, Laminate and Solid Maple, in a spectrum of light to dark.

*note: not applicable to all series, for example BeSpace only offers clear veneer finish.

Finish - Top Coat

To reduce hazardous formaldehyde emissions, we use our proprietary specially designed top coat, DuraTex™. It significantly reduces hazardous formaldehyde emissions and helps improve indoor air quality.

Finish - Color/Stains

A wide range of stains are available to bring out the beautiful characteristics of each wood species. We coordinate finish color between our veneer stains and solid lumber stains; however, not all may be a perfect match. The stains are continually reviewed for accuracy of color, as well as a constant monitoring of the latest color trends in the furniture market.

Finish - Matching

Due to the natural characteristics of wood, environmental effects, and material upgrades, JSI cannot guarantee exact finish matches on existing furniture previously ordered.

If an exact match is required to accompany existing furniture, it must be specified at the time of order placement, so specific internal procedures can be followed to ensure a proper and acceptable finish match. We reserve the right to change our finish formula at any time to improve safety, quality, and appearance. Unless a finish match for existing furniture is requested at the time of ordering, we accept no liability for finish that may not match the existing furniture from prior orders.

Solid lumber may inherently have mineral streaks, pits, and various other natural occurrences. Care is taken in selecting the solid lumber to coordinate with the requested finish on our veneer products. This internal selection process is subject to availability of solid lumber parts.

Finish Sheen

All casegood veneer finishes are standard in 35-sheen, with the exception of Raven, which is only offered in 15-sheen. All other finishes are available in 15-sheen, with a 5% upcharge, per model.

Custom/Special Finishes

JSI, upon request, will accommodate special finishes. A written request is required to proceed with custom finish orders. A sample reference is required for first-time matches and must be included with the written request.

There is a charge of **\$400 list per order** for any non-standard wood finish.

Orders will be entered noting the special finish. A sample match will be provided to the customer. Written approval is needed before the finish process can be started. Delays in approval may have an impact on lead times.

Every effort will be made to create the requested match; however, an acceptable match may not be possible because of natural variations of wood. These natural variations can also cause minor differences in the final finish product.

Use standard pricing and option pricing for each line item with a special finish, unless additional modifications have been specified. For items available in both Essential and Artisan veneers, apply the Essentials pricing.

Samples

Samples of standard wood finishes, paints colors, metal colors, and standard laminate are available upon request. The fastest way for requests to be filled is by using our website. See below for options to request samples.

Website – jsifurniture.com (click the resource tab)
 JSI Sales representatives
 Phone – 800.457.4511 – Customer Service
 Email – customerservice@jaspergroup.us.com

Veneer Finish and Laminate Overview

Designator	Finish	Veneer Collection	Veneer Species	Laminate	Core Program
BAR	Barrel	Artisan	White Oak- Double Cut	n/a	N
BRK	Brickdust	Essentials	Cherry	HPL & TFL	Y
BUF	Buff	Artisan	White Oak- Double Cut	n/a	N
CSK	Cask	Essentials	Walnut	HPL & TFL	Y
CND	Cinder	Artisan	White Oak- Double Cut	n/a	N
CLY	Clay	Essentials	Cherry	HPL & TFL	Y
EGR	Egret	Artisan	White Oak- Double Cut	HPL & TFL	N
FAW	Fawn	Essentials	Linear - Double Cut	HPL & TFL	Y
FLX	Flax	Essentials	Maple	n/a	N
FLN	Flint	Essentials	Linear - Double Cut	HPL & TFL	Y
LOF	Loft	Essentials	Linear - Double Cut	HPL & TFL	Y
MES	Mesa	Essentials	Cherry	HPL & TFL	Y
MIN	Mineral	Essentials	White Oak- Double Cut	HPL & TFL	Y
MCH	Mocha	Essentials	Walnut	HPL & TFL	Y
OBK	Outback	Essentials	Cherry	HPL & TFL	Y
PIL	Pilsner	Essentials	Maple	HPL & TFL	Y
RAV	Raven	Artisan	Black Oak	n/a	N
RYE	Rye	Artisan	White Oak- Double Cut	n/a	N
SAB	Sable	Artisan	White Oak- Double Cut	n/a	N
SAD	Saddle	Artisan	White Oak- Double Cut	n/a	N
SIE	Sienna	Essentials	Walnut	n/a	N
TRF	Truffle	Essentials	Walnut	n/a	N
UMB	Umber	Essentials	Walnut	HPL & TFL	Y
VAL	Valley	Essentials	Linear - Double Cut	HPL & TFL	Y



Pricing

Prices found in this document or on our website are list prices in U.S. dollars for standard product delivery to one destination. Prices do not include storage, installation, or taxes. Possession of this price list does not constitute an offer to sell. Orders can only be received from approved authorized JSI dealers.

Prices and product information in this document, as well as our website, are subject to change without notice. Reference website for most up to date product offering and pricing.

In our ongoing efforts to minimize ancillary charges. JSI does not include these fees in any calculations for dealer participation fees or commissions in any form. Ancillary charges include but are not limited to special finish charges, special laminate charges and handling fees. When calculating your dealer participation fee or commission earned, please include product lines only and exclude any ancillary charges. Should you have any questions, please call our office for clarification.

Orders

Detailed specification pages are available in the price list at the beginning of each series.

Additional information may be obtained by consulting the Customer Service Department or our website.

Indicate shipping address if different from billing address.

Send Orders To:

US Mail – JSI
225 Clay Street
Jasper, IN 47546
Fax – 812-482-1548
Email – orders@jaspergroup.us.com

JSI reserves the right to make changes in dimensions, styles, or specifications if we believe these changes will improve the safety, quality, or appearance of the product.

Acceptance of orders will be subject to credit approval, barring any acts of governments, or any other causes beyond our control (e.g. strikes, fire, embargo of materials, etc).

Product Modifications

While we offer a wide range of products to accommodate many possible solutions, we also recognize the needs for our products to be modified from our standard offering.

In the series introduction section of each product, we address modification options for that series.

To see if the desired modification is possible, please contact our Customer Service Department for a quote. Note that order quantities and material availability can affect the quote. Additional information may be requested to fully quote modifications.

Order Acknowledgments

All orders will be acknowledged promptly upon entry of a clean order. The acknowledgment will show how the order was entered, ship date and any other information pertinent to the order. It is the purchaser's responsibility to verify all the information on the acknowledgment carefully and notify us immediately, in writing, of any discrepancies.

Every reasonable effort is made to ship as acknowledged; however, the acknowledged ship date is approximate. Company will generally ship within five (5) working days of the acknowledged ship date. If a firm ship date is necessary, customer must inform company at time of order and company will make all reasonable efforts to meet each customer's request. Acknowledged shipping dates are contingent upon the force majeure conditions contained in these terms and conditions.

Cancellations and Changes

All orders are considered firm and are not subject to cancellation or change without approval from JSI. All approved changes are subject to additional charges and revised lead times

Quickship

JSI offers select Vision models, with select options, in our Quickship program. These items ship within 10 business days after receipt of a clean, credit approved purchase order. Items should be placed on order separate from standard lead time models.

Product for up to 10 offices or 10 tables can be included on a single Quickship order. Available capacity is filled by orders as they are received. If normal 10 day Quickship is not available because capacity has been filled, you will be immediately notified by JSI customer service. Changes and cancellations to Quickship orders are not allowed under any circumstances, nor are modifications to the pre-determined Quickship offering. Limit one order per project.

Delivery

Our freight policy consists of prepaid freight to the 48 contiguous states; all other shipments are prepaid to port of exit ONLY. JSI reserves the right to select the appropriate carrier and shipment routes, most shipments are on freight carriers that are dedicated furniture specialists. Standard deliveries require a DOCK that can accommodate 75 foot trucks. Ownership and inspection of product is the responsibility of the buyer upon pickup by the freight carrier. Pricing in this book is for standard delivery only. Standard delivery does not include non-dock delivery, inside delivery, residential delivery or installation of product. Fees and changes for non-standard deliveries are listed below.

Shipping Destination

Changes to ship to locations may not occur within seven days prior to the ship date, however, in atypical situations a **\$260 change fee** will be applied to accommodate additional carrier fees.

Standard Delivery Time

Between 8 AM and 3 PM Monday through Friday. Special delivery requests can be subject to additional fees to accommodate requests.

No Touch Freight

Our freight is considered "no touch". Therefore, customers are to be prepared to unload freight from inside the truck prior to arrival. In the instance that a driver must unload the shipment, driver assists fees will apply (see fees below).

On-Site Deliveries

Shipments to the installation site, and time deliveries are available on full truckloads or slightly less, at no additional charge. Shipments or timed deliveries for smaller shipments may not be available, or if available may require an additional charge.

Detention Fees

- Carriers are given two-hour maximum time allotment to unload for one-stop truckloads.
 - Carriers are given one hour maximum time allotment to unload for multi-stop truckloads
- *Detention fees apply after allotted unloading time and will be at buyer's expense.

Fees

Orders of less than \$1,000 net \$97 net per order
 (If order is UPS shippable, the handling fee is waived and customer is invoiced for exact shipping charges.)
 Weekday deliveries outside of standard delivery times . . . \$322 net
 Weekend deliveries (Saturday or Sunday). \$645 net
 Liftgate Deliveries \$536 net minimum 7% of net price
 Driver Assist \$97 net
 Jobsite Non-Dock Delivery \$162 net per truck
 Inside Delivery (first floor inside only)- no installation or carton removal \$269 net minimum 7% of net price
NO RESIDENTIAL DELIVERIES

Warehouse/Storage Fees

Additional storage time with a provided two-week approved notice is calculated at 3% per month of the product amount or per day.

Please be Advised

- Reconsignment fees are the responsibility of the buyer.
- Any charges arising from failure to meet shipment, re-routing while in transit or carrier storage charges are the responsibility of the buyer.
- Contact Customer Service to inquire about skidding of products, special crating of products and product installation. These requests must be approved by JSI and made at the time of order.
- Carriers have the right to refuse delivery to a specified location if it conflicts with their liability policy.

Freight Damage

JSI products are packed in cartons and meet or exceed existing codes for furniture and seating products. All shipments are delivered to the carrier in good condition and our liability ceases thereafter. If delivery arrives short or damaged, contact Customer Service immediately to file a claim. In the event of concealed damage, notify Customer Service and request immediate inspection. Failure to file a claim within 15 days after receipt of merchandise constitutes acceptance and a waiver of any such claims. Please inspect merchandise immediately upon receipt, otherwise there is no recourse. Keep all cartons and packing material, discarding these materials may negate your claim.

Storage of product in areas of uncontrolled humidity and temperature may cause damage to the product and void the JSI warranty.

Repairs

JSI will not issue credit allowance for any type of repairs without prior written consent.

Sales order, product model numbers, and reason for repair will be expected in order to process the repair request. A digital photo will help to expedite the request. JSI reserves the right to recommend solutions for repair.

Replacement Parts

Obtain information and pricing on replacement parts by contacting Customer Service. Please have the model number available when requesting replacement parts. Additional information may be required to ensure proper replacement parts.

Returns

JSI products are made to order and may not be returned for credit. No merchandise may be returned to JSI without a signed Return Good Authorization (RGA) form issued by our Customer Service Department. RGA's will be considered for the following reasons:

1. Manufacturing defect (validated by JSI representative).
2. JSI order processing error.
3. Shipping error.
4. Mis-marked cartons.
5. Duplicate shipments.

Liability for defective merchandise shall be limited to replacement or repair.

If you have questions as to whether your reason for return qualifies for consideration, please contact Customer Service. At the discretion of JSI, returns on stocked items may be considered with the following stipulations:

1. 60% restocking fee.
2. All return freight charges must be prepaid by dealer.
3. Product was never removed from the original carton.
4. Product must be returned within 30 days of RGA issue date.
5. Credit will not be issued if product returned is damaged.
6. Under no circumstances can we accept COD (Cash on Delivery) returns. Any such shipment will be refused.

Please note most models on Quickship are produced on demand and cannot be returned. Modified, special or custom-built product is not eligible for return.

Fire Retardancy

All JSI upholstered components comply with California Bureau of Home Furnishings and Thermal Insulation-Technical Bulletin 117-2013 issued by State of California Department of Consumer Affairs. This standard requires upholstered furniture to be safer from the hazards associated with smolder ignition in all four (4) categories of materials, as applicable.

Compliance with more stringent codes may require special manufacturing considerations and upcharges.

California Technical Bulletin 133 (CAL 133)

JSI uses a barrier material between the foam cushioning and the upholstery cover in order to comply with CAL 133. The standard upcharge on products specified to comply with CAL 133 is **\$85 list per yard** of textile.

JSI has performed a series of full scale fire tests on samples-representing worst case scenarios of upholstered units- to comply with the requirements of the state of California Technical Bulletin 133 (CAL 133). Products in compliance are labeled in accordance of the standards.

Some product designs and fabric cannot be combined to comply with CAL 133. Because of this, we reserve the right to reject any request for an upholstery cover, including COM, textile may not contain olefin or product style that we feel may compromise the integrity or safety of a product specified to comply with CAL 133.

Contact Customer Service for a quote if you require laboratory certification that a specific product and upholstery combination WILL PASS CAL 133. The quotation will include testing, video, and transportation charges plus the list cost of the sample.

Our standard lead time will apply to products that do not require certification. Allow an additional six weeks over the standard lead time for products that need actual laboratory certification.

The end user, specifier and/or dealer have the responsibility to make sure all products specified will meet the flammability and safety codes of the jurisdiction where the products will be located and used.



Flame Spread

All JSI may be required to comply with the requirements of Flame Spread based on ASTM standards/NFPA Life Safety Codes and general public knowledge are as follows:

- Solid Wood- Class C
- Topcoats- Class A
- Carded Fabric- Class A
- Composite Panels- Class C
- Laminate- Class B

Plastics- According to the NFPA, the lack of stability of plastics under high temperature conditions and inherit combustibility have eliminated the use of plastics for applications requiring a flame spread rating.

Also be advised that improvements may be attained in certain instances with the addition of chemicals which may add additional costs, chemical exposure and/or compromise the integrity of the product.

Textile Carded Programs

JSI is proud to partner with Maharam, Momentum, Spradling, Stinson, Ultrafabrics, Camira and Cortina Leather. Please refer to our website for our standard patterns, along with the current grade.

<https://www.jsifurniture.com/finishes-and-materials/textiles>

Textile Grade-In Programs

For the convenience of our specifiers, we offer an extensive graded in program. Please reference our website for the most up to date information on our graded in program.

<https://www.jsifurniture.com/resources/textile-partner-info/overview/>

For additional specifications on the pattern or to order memo samples, please contact the textile suppliers directly:

- Arc Com www.arc-com.com
- Camira www.camirafabrics.com
- DesignTex www.designtex.com
- Maharam www.maharam.com
- Mayer www.mayerfabrics.com
- Momentum www.themomgroup.com
- Spradling www.spradlinggroup.com
- Stinson www.cfstinson.com
- Ultrafabrics www.ultrafabricsllc.com
- Cortina Leather www.cortinaleathers.com

Any textile not graded in or pre-approved for COM/COL will require application test approval prior to order entry and shipment of fabric or leather to JSI. For current JSI grades and application status by series visit www.jsifurniture.com Resources > Graded-In + COM; [Graded-In + COM](#).

Indicate on purchase order if JSI is to order the fabric.

Grades and availability of fabric are subject to change without notice. Changes could include but are not limited to price increase, discontinued patterns, discontinued colors, etc. See www.jsifurniture.com for up to date information.

Many textiles have repeats and the additional yardage required has been factored in for textiles ordered through the JSI Carded and Grade-In Programs. We reserve the right not to match textiles with a horizontal or vertical repeat greater than 17". Additional charges may apply for textile being applied with special instructions.

Some fabric thickness or stiffness may cause issue with proper upholstering of tackable wall panels or upholstery privacy screens. Please contact customer service with concerns on the fabric thickness for these items.

COM/COL Address

JSI
Attn: COM/COL Department
Receiving B
Dock 71
201 East Martin St.
Orleans, IN 47452

Tag: Dealer Name / Purchase Order #

General COM Fabric/COL Hide Policy

Refer to the COM/COL Price Columns for list prices.

All yardage requirements listed in the price list are based upon 54" plain non-directional material. Additional yardage may be required based on fabric repeat and matching.

All square footage requirements for COL are based on an average hide size of 50 square feet.

Contact Customer Service for any of the following conditions:

- + approval of COM/COL to be used (see policy on the next page)
- + fabric repeats greater than 3"
- + fabric less than 54" wide
- + leather hides smaller than 50 square feet
- + special application requirements request

When requesting information from Customer Service on COM/COL please supply the following information:

- + model number and quantity of the product the COM/COL will be applied
- + COM/COL textile supplier's name
- + name of pattern and color of the textile
- + any special application request

Visit www.jsifurniture.com Resources > Graded-In + COM to see if the textile has already been approved. If there is no record for this particular textile then a Memo Sample will be required.

JSI takes no responsibility when additional materials must be ordered.

COM Fabric Repeat Guide

Roll Width	Plain Fabric	1" - 5" Repeat	6" - 10" Repeat	11" - 15" Repeat	16" - 20" Repeat	21" - 30" Repeat	31" - 40" Repeat	41" - 50" Repeat
54"	0%	10%	15%	20%	25%	30%	40%	50%
53" to 51"	15%	20%	25%	30%	35%	40%	50%	60%
50" to 48"	30%	35%	40%	45%	50%	55%	70%	90%
47" to 36"	60%	65%	70%	75%	80%	85%	100%	120%

The percentage represents the additional fabric yardage that needs to be added to the COM yardage. Contact Customer Service for repeats greater than 50".

All COM/COL must meet applicable codes and regulations, including TB117-2013. By selecting COM/COL, customer certifies that the material meets such codes. JSI assumes no responsibility for the applicable codes and regulation regarding flammability rating and safety rating of any COM/COL.

JSI cannot be held responsible for receipt of defective fabrics, as we apply all COM as first quality goods.

We can take no responsibility for tailoring, wear-ability or application of COM/COL textiles. Any warranty claims for the COM/COL Textile materials will fall to the original vendor of the textile, not JSI.

COM Fabric/COL Hide Process for JSI Seating

General COM Fabric and COL Hide Policy also apply.

JSI will approve or disapprove COM/COL on all products. An approval of a textile from JSI makes no claim that performance, durability or tailoring of COM/COL will result in satisfactory upholstery. Every effort will be made to meet customer's expectation, but fabrics/leathers have unforeseen inherent characteristics that may limit JSI's ability to deliver a well tailored product.

Approval COM Textile/COL Hide Process for Seating

Follow the Steps Below:

1. Send a Memo Sample of the COM/COL (recommended memo be at least 4" x 4")
 JSI
 Attn: COM/COL Approval Department
 201 East Martin Street
 Receiving B, Dock 71
 Orleans, IN 47452
2. Call our Customer Service Department at 812-482-3204 to request an electronic version of approval form.

Guide Order Form for COM and COL

Please send sample to:
 JSI
 Attn: COM/COL Approval Depart.
 201 East Martin St.
 Receiving B, Dock 71
 Orleans, IN 47452

① **Order Information:**

Quote #: _____ **Purchase Order #:** _____

Customer Service: _____

Dealer Name/Project Name: _____

Contact: _____

Address: _____

Phone: _____ **Email:** _____

Model Number(s) Receiving COM / COL: _____

Please forward a copy of this form to your JSI CSR for record keeping

② **Select off the bolt application: (Check one of the boxes)**

Up the roll (standard on most seating) Railroaded

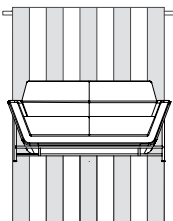
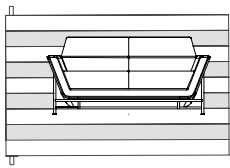
③ **Additional information:** _____

④

Attach sample here.

JSI will review and test as needed all requests. You will be notified as soon as results are documented by our review personnel. JSI reserves the right to reject any COM/COL on our products. We will provide COM/COL explanation of any unapproved textile whenever possible.

Custom Options

Wood Laser Engraved Back

Many of our seating models are available with a custom wood laser engraved back. University seals, logos, unique designs, or any type of graphic can be designed into the seating back for a custom creation. Copyright approval may be required. Consult JSI Customer Service for pricing and artwork specifications. Artwork must be submitted as a JPG or PDF file.



Wood Laser Engraved Back General Pricing

* must order plain back when choosing these options

For Artwork 4" x 4" or Less	\$61 list per chair
For Artwork Less than 6" x 6"	\$107 list per chair
For Artwork Larger than 6" x 6"	Call For Pricing

For orders fewer than 50 pieces, add \$165 list per design, per order. This pricing reflects etching (leaving the wood dark). If additional painted colors are added to artwork please call customer service for pricing.

A \$145 list set-up fee applies.

Care and Maintenance

Care and Maintenance

Care of Upholstery Surfaces

Cleanability will vary based on the fabric type. For best results, a professional service is recommended. Dirt and crumbs may be gently brushed or vacuumed off. Spills should be wiped up immediately with a cloth. Vinyl textiles can be cleaned with warm soapy water and then wiped down with a warm damp cloth. For more details on any JSI carded fabric and vinyl, please visit our website at jsifurniture.com or consult the back of the appropriate swatch card for cleaning codes and any specific instructions. For COM materials, consult with the individual textile manufacturer for cleaning codes and any specific instructions pertaining to your particular fabric.

Maintenance of Mechanical Parts

Clean any lint or debris from the moving parts of the base mechanisms. Mechanisms have been designed and tested to not require lubrication under normal conditions; however, lubricant can be used if needed.

Care of Wood Edges and Veneer Surfaces

Clean all surfaces frequently with water dampened soft cloth, moving the cloth with the grain direction. Immediately remove any liquids that come in contact with wood surfaces with a blotting action to absorb liquid. Buff dry. Lift objects to move them, never pull them across the finished surface. For an additional safeguard, use a protective surface pad. This will ensure a lasting finish by protecting your furniture from possible damage caused by pens, cups and sharp objects. Avoid exposure of furniture to extremes of heat and cold, or to wide humidity variances. Avoid exposure of furniture to strong sunlight. Avoid exposure of furniture to harsh solvents such as nail polish remover, acetates, etc., as it will cause finish deterioration. If using a protective glass top, place spacer pads under the glass top to allow the wood to breathe.

Care of Metal Finishes

Wash your powder-coated item at least one every six months. Use soft rags only - No abrasives. For stubborn stains and grease marks, use soap and water mixture. Combine 1 gallon of water and 1 cup of the neutral detergent in the bucket. Mix it up by swirling one of the rags around in it. Wipe down the powder coat with a rag that has been dampened with the cleaning solution. Do not scrub, but use gentle, repetitive pressure to remove any built-up grime. Rinse the powder coat off with a rag dampened with clear, clean water. Do not spray it down, but rather wipe it off with the rag. You may need to do this several times to get all the soap off. Wipe the powder coat down with a clean dry rag. This will prevent streaking and spotting.

Care of Frosted Glass

Use a clean, dry lint free cloth to wipe the surface. Follow with warm water and a clean rag; no soap or chemicals. Wipe dry with a clean, dry lint free cloth. Cleaning the frosted side is not recommended, if desired to clean use the above method but do not spray the water on the frosted side, use a clean rag. Please allow 48 hours for the frosted side to dry and not to show cloudiness.

Tempered Glass Information

JSI is aware of occasional occurrences of spontaneous glass breakage in various furniture products. Tempered glass makes it stronger and if it breaks, will cause it to break into many small pieces of “cubes” rather than sharp and potentially dangerous shards.

Glass breakage in furniture may occur for a variety of reasons. Tempered glass is particularly prone to breakage from damage (scratches, nicks, etc.) that may occur during shipping, handling, installation, use or maintenance. Exposure to rapid changes in temperature or concentrated temperature zones may also cause breakage.

Tempered glass may also break due to a specific type of imperfection or “inclusion” that occurs within the glass when manufactured. When this condition exists glass breakage may occur without any obvious cause. This is often referred to as “spontaneous” breakage but is a very isolated occurrence in the glass industry.

Care of Dry Erase Boards

Erase after every use to eliminate ghosting. Clean weekly with a Dry Erase Cleaner. Avoid the use of orange and red Dry Erase Markers. Follow manufacturers cleaning instructions for the eraser. If ghosting or staining remains use a small amount of rubbing alcohol on a clean, soft towel to remove.

Care of Solid Surface

Although liquids cannot penetrate Solid Surface, it is best to wipe up spills as they occur. Generally, a damp microfiber cloth used with a standard household kitchen spray should remove most stains.

For most residues, all you need to clean your Solid Surface countertops is a warm soapy water, ammonia-based household cleaner or a dedicated countertop cleaner. Do avoid window cleaners; however, as they can leave a waxy build-up that dulls the surface. Always clean using a circular motion.

Film will build up on countertops if water is left to dry on the surface. This film will dull the countertop surface, making the finish appear blotchy and uneven. To prevent film build-up, it is very important to wipe the countertop completely dry immediately after spills and cleaning.

Some color of Solid Surface may require more frequent cleaning to maintain a uniform finish. Darker colors tend to require more attention than lighter colors. Over time, even with proper care, your countertop will acquire a sheen. Dark colors may show light scratches more readily.

Specification Tools

JSI products are manufactured to order and provide a multitude of options to address your individual customer needs. As you process your order do not forget to include all the necessary information to allow the order entry process to be completed. Please see the order checklist at the beginning of every series.

JSI Customer Service edits every order for complete information. If details are not included with the purchase order, Customer Service will contact you to answer these questions. If information is not completed in a timely manner it will delay the entry process and could affect your product delivery date. To avoid delay in order entry and potential delay in delivery of your order, please double check the line items to ensure all selections have been completed.

To ensure completion of details on your purchase order, electronic catalogs and specification tools have been developed to aid in the process. These electronic tools include:

20-20 GIZA Studio and 20-20 CAP Studio software offers state-of-the-art design, specification, photo-realistic rendering and three-dimensional visualization capabilities for configurable products in the commercial interior design markets. 20-20 GIZA Studio and 20-20 CAP Studio are available for all JSI Casework and Seating products, in 2D and 3D graphics and the Specifier Catalog. Updates are made monthly reflecting any changes that occurred. To be sure the most up to date information is provided on orders, users of this software program are responsible to update their catalogs.

CET Designer, by Configura is an all-in-one software solution for space planning and configuration of products. The intuitive workflow guides you through entire process from idea to reality- supporting every step of the sales process

GSAdvantage is a Federal Government electronic catalog site offered to assist GSA customers in specifying and pricing JSI product. Listed at this site are all contract items and prices under GSA Contract # GS-28F-0030U.

Our JSI website jsifurniture.com provides many tools to assist in the design and order selection. Included in the site are downloadable images, typicals, product symbols, brochures, contact information, price lists, sales representative locations, warranty and environmental information.

GSA Terms and Conditions



Contract Holder

Contract # GS-28F-0030U

Maximum Order
\$250,000 net

Geographic Coverage
48 contiguous states and Washington D.C.

Point of Production
Jasper, Dubois County, Indiana
Orleans, Orange County, Indiana

Discount
Discount 61.6%* off list.

*Discount for Walden and Wellington is 61.71% off list.

Discount Quantity
Walden and Wellington only
\$300,000 to \$350,000 Net = 0.5%
\$350,001 to \$400,000 Net = 1%
\$400,001 to \$450,000 Net = 1.5%

Prompt Payment Terms
1% 15 - net 30 days from date of invoice.

Government purchase cards are accepted at or below the micro-purchase threshold

Government purchase cards are accepted above the micro-purchase threshold

Foreign Terms
Not applicable.

Time of Delivery
30-75 days after receipt of order, 90 days maximum.

Expedited Delivery
Contact Customer Service 800-457-4511

Overnight and 2-day Delivery
Not applicable.

Urgent Requirements
Contact Customer Service 800-457-4511

F.O.B. Points
F.O.B. destination, freight prepaid and allowed to 48 contiguous states and Washington D.C. excludes special delivery requirements.

In addition to the standard terms and conditions, the following terms and conditions apply to GSA contract.

Contract Number
GS-28F-0030U

Contract Period
June 24, 2013 - June 24, 2028

Statement of Intended Use
The furniture covered by special item number 33721 Office Furniture shall comply with the requirements defined in purchase description 3QSAB 09-608. All furniture offered under this SIN shall be GSA Chassis Grade 1, 2, 3 or NA, GSA Drawer Grade 1, 2, 3, 4 or NA, Design A B or C, as defined in 3QSAB 09-608.

Description of Special Item Number SIN #33721

Cooperative Purchasing
No

Set Aside
No

FSC/PSC Code
7125

NAICS 337211 Wood Office Furniture Manufacturing 1000 employees

Includes all furniture placed in an office, such as chairs, desks, etc. In addition, ancillary services are included, however services performed shall not be the primary purpose of the work ordered.

Lowest Price Model

SIN #	Model Number	Net Price
33721	VS-LBRKT-20	\$28.03



GSA Terms and Conditions

Ordering Address

Jasper Seating Company, Inc. d/b/a JSI
Attn: Participating Dealer
225 Clay Street
Jasper, IN 47546
Fax: 812-482-1548
Phone: 800-457-4511
Email: orders@jaspergroup.us.com

Order Procedures:

Per contract

Payment Address

JSI
225 Clay Street
Jasper, IN 47546

Warranty Provision

Limited Lifetime

Export Package Charges

Quoted on project-by-project basis.

Terms of Government Commercial Credit Card Acceptance

Accepted.

Rental, Maintenance, and Repair

Not applicable.

Terms and Conditions of installation

12% of net purchase order for installation services up to \$250,000.00 of net purchase price.

Terms and conditions of repair parts, etc.

See warranty.

List of service and distribution points

Contact Customer Service 800-457-4511.

List of participating dealers

Contact Customer Service 800-457-4511.

Preventive Maintenance

N/A

Environmental Attributes

GreenGuard Certified and recycled wood waste and fabric remnants

Section 508 Compliance

N/A

DUNS

00-636-7767

CCR and SAMS Registration

Jasper Seating Company, Inc. is registered
Cage Code #31881
Federal ID #35-0420370
UEI #DDJ2GKQM7M84

Product Modifications

We willingly accept customers' modifications to standard products. See product modification information by series at the start of each series under the "Product Modification" sections. If there is a modification you desire that is not listed in this section, please call Customer Service for a modification quote/price

Acceptance, Modification, Assignment

By placing this order for furniture, material or other products (sometimes collectively referred to as "goods"), customer agrees to these terms and conditions which shall prevail over inconsistent provisions in any other form or document of customer. No change or modification shall be applicable unless set forth in writing and signed by company. Neither this order nor any interest therein shall be assigned by customer except with the prior written consent of company.

Payment

Customer agrees to pay to company the amount indicated on the invoice, 1% 15 days, net 30 days from date of invoice (U.S. funds only), for goods ordered. Interest will be charged after 30 days from the date of invoice at the rate of one and a half percent (1.5%) per month. International sales will require additional payment arrangements. No goods shall be sold on consignment or conditional sales basis. Payment for the goods delivered hereunder shall constitute acceptance thereof.

Attorneys' Fees

Customer shall be responsible for all expenses and cost in connection with the enforcement by company of these terms and conditions and the cost of collection (including the fees of any collection agencies to whom the customer's account may be referred), plus reasonable attorneys' fees (which attorneys' fees shall not be less than 25% of the amount due, unless a lower amount is specified by applicable law).

Remedies

The remedies herein reserved shall be cumulative, and additional to any other or further remedies provided in law or equity. No waiver of a breach of any provision of these terms and conditions shall constitute waiver of any other breach or of such provision.

Insolvency

Company may forthwith cancel this order in the event of the happening of any of the following or any other comparable event: insolvency of the customer, the filing of a voluntary petition in bankruptcy, the filing of any involuntary petition to have customer declared bankrupt provided it is not vacated within thirty (30) days from the date of filing, the appointment of a receiver or trustee for customer provided such appointment is not vacated within thirty (30) days from the date of such appointment, or the execution by customer of an assignment for the benefit of creditors.

GSA Terms and Conditions

Limitation of Liability

The Company shall not under any circumstances be liable to the customer, owner of the goods or any third party for special, indirect, incidental, or consequential damages, including, without limitation, loss of profits or revenues, loss or damage to other property or equipment, cost of capital or of purchased or replacement goods, or expense, delay, or inconvenience caused by or arising from the purchase, sale, use, repair or inability to use the goods or by any performance or non-performance under, or breach of, these terms and conditions. The Company's sole liability for any defective goods shall be its repair or its replacement pursuant to the express warranties set forth above, or if amended, as applicable at the time of manufacture or repair of the goods. Some states do not allow the exclusion or limitation of incidental or consequential damages, so the above limitations or exclusion may not apply to all customers. Any action resulting from any breach on the part of company as to the goods or services delivered here under must be commenced within one year after the cause of action has occurred.

Returns and Allowances

Reasonable touch-up and deluxing is the dealer's responsibility. The Company will not make allowances for trip or delivery charges, but will only make allowance for actual work performed to correct manufacturing defects. Allowances maybe authorized only by a company officer. It is the responsibility of the field sales representative to inspect any defective merchandise and make suggestions and recommendations as to the proper disposition. Field personnel cannot obligate or bind the company by definite agreement, without final authorization by a company officer. Company will not accept automatic charge backs which do not have prior authorization. All defects must be called to the company's attention upon arrival at the customer's "ship to" destination. To initiate any type of claim or request for parts, it is imperative to have the model number or fabric number, which may be located on the tag attached to the frame of the unit. Authorization for return to the company via a return goods authorization. Company will not issue credit allowances for any repairs without company's prior consent. Under no circumstances shall the company accept COD (cash on delivery) returns, and any such shipment will be refused.

Security Agreement

The Company may require and customer shall grant a security interest in goods sold pursuant to any credit the company may extend to the customer.

Governing Law

All disputes between the parties, whether or not arising out of these terms and conditions, will be governed by the laws of the state of Indiana. Customer agrees to submit to the jurisdiction of and agrees all lawsuits relating to any disputes between the customer and the company will be brought only in a state court located in Dubois County, Indiana or the United States District Court for the Southern District of Indiana. The customer hereby waives the right to a trial by jury in any action, proceeding, claim, or counterclaim whether in contract or tort, at law or in equity, arising out of or relating in any way to these terms and conditions and all other disputes between the parties.

Mitigation

If the company repossesses the goods prior to payment by the customer of all amounts due hereunder, the company may sell the goods, as is, where is, free and clear of all rights of the customer at either public or private sales, and apply the net proceeds (after deducting expenses of repossession and sale) to the obligation of customer hereunder. The customer may dispose of the goods in any commercially reasonable place and manner and the customer waives any notice of time, place and manner of sale.

Integration

This order for goods, including these terms and conditions, along with any credit application, invoice, statement, dealer contract, acknowledgment, bill of lading (and any exhibits, addenda or amendments thereto) of which this order may be a part, constitutes the sole and complete agreement between the company and the customer with respect to the purchase of the goods.

Dimensions/Specifications/Finishes

All dimensions are approximate and may vary due to the upholstery technique of each craftsman. If exact dimensions are required, it is necessary for the customer to state such specifications with the order. Detailed specifications sheets are available for each series of goods, and customer should consult the company's customer service department for these specification sheets. Company reserves the right to make changes in dimensions, style, or specifications if company believes these changes will improve the goods' quality or appearance. Company reserves the right to substitute hardwoods due to availability at production. Due to the natural characteristics of wood, environmental effects, and material upgrades, the company cannot guarantee exact finish matches on existing goods previously ordered from company. If an exact match to customer's existing goods is required, it must be specified so that the proper procedures can be followed to ensure an acceptable finish. Company will accept no liability for the finish if this procedure isn't followed. Company reserves the right to make changes in a finish formula if company believes the change will improve the quality or appearance of company's goods.

Company's Performance of Its Obligation

The production and delivery of the goods to the extent delayed or hindered or prevented from the performance by reason of natural disasters, acts of god, strikes, lockouts, labor troubles, inability to procure materials, casualties, failure of power, restrictive governmental laws or regulations, riots, insurrections, acts of terrorism, war or other reason of a like nature not the fault of the company shall excuse for the period of the delay the company's performance and the period for the performance shall be extended for a period equivalent to the period of such delay.

Casegoods Price List | Flux Series

General Information

Environmental Mission	II	Custom Options	VIII
Warranty.	III	Care and Maintenance.	IX
Laminate and Veneer Characteristics	III	Specification Tools	X
Samples.	IV	GSA Terms and Conditions	XI
Order Procedures	IV		
Quickship Program.	IV		
Delivery	IV		
Freight Damage	V		
Repairs and Returns	V		
Fire Retardancy / CAL 133	V		
Textile Information / COM and COL Policy.	VI		

Flux - Private Office

Product Information

Overview	2-3
--------------------	-----

General Options

Material Offerings	5
Desk Pedestal Configurations	6
File Drawer Configurations	7
Top Edge Details.	8
Pull Options/Details	9
Casters	11
Modesty Panels	12

Applied Materials

Laminate Grain Directions	13
Veneer Grain Directions	14-15
Color Scheme	16

Product Details

Pedestal Desks	17
Peninsula Desks w/Secondary Creds.	18-20
Run-off Desks	21
Adjustable Height Desks & Tables	22-23
Credenza Options	24
Credenza Compartment Dimensions	26-27
Overhead Cabinet & Wall Panel Stack-ups	28
Wall Panel Installation	29

Product Details (cont.)

Overhead Cabinet Stack-ups	30-32
Overhead Cabinet Door Options	33
Tasklight Size Chart	33
Monitor Cabinets	34-35
Vertical Storage	36-38
Modular Components	39

Technology

Power and Data Wiring Examples.	40-41
Grommets and Power Units	42
Grommet and Power Unit Locations	43-49
Wire Manager Size Chart	50-51

Pricing Pages

Tables	52
Pedestal Desks	56
Peninsula Desks	88
Run-off Desks	112
Returns & Bridges	122
Primary Height Credenzas	128
Modular Credenzas/Pedestals	150
Kneespace Credenzas	154
Peninsula Credenzas.	164

Pricing Pages (cont.)

Primary Height Credenzas	168
Secondary Height Credenzas.	190
Cushions	214
Adjustable Height Units	216
Modular Units	254
Primary Height Overhead Cabinets	272
Primary Height Panels/Markerboards.	294
Secondary Height Overhead Cabinets	298
Secondary Height Panels/Markerboards.	308
Wall Mount Overhead Cabinets.	312
Wall Mount Cubbies	332
Wall Mount Panels/Tackboards.	338
Workwall Panels	354
Storage Towers.	364
Monitor Cabinets	370
Bookcases.	378
Lateral Filing.	380
Wardrobes/Vertical Cabinets	382
Wardrobes/Vertical Cabinets with Legs	416
Pantries	444
Lockers	448

Accessories

Keyboard Accessories	456
Monitor Arms	457
Tasklights	457
Drawers	458
Power and Data	458
Wire Management	460
Portable Slide on Screen.	461

Flux Overview

Tables [Page 50-53](#)

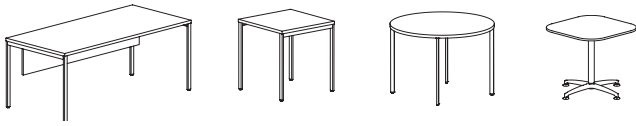

Pedestal Desks [Page 54-85](#)

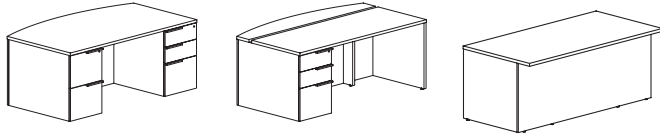

Peninsula Desks [Page 86-109](#)



Run-off Desks [Page 110-119](#)

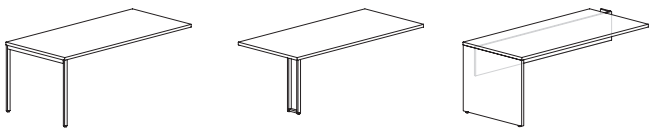

Returns & Bridges [Page 120-125](#)

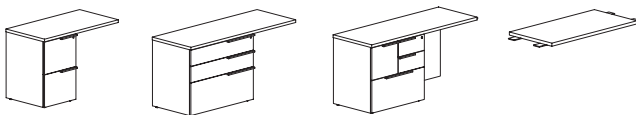

Primary Height Credenzas (to floor) [Page 126-147](#)

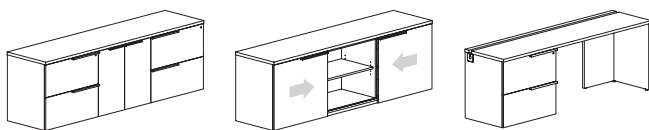

Modular Credenzas/Pedestals [Page 148-151](#)

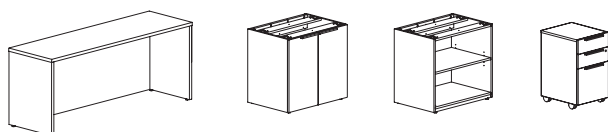

Kneespace Credenzas (on legs) [Page 152-161](#)

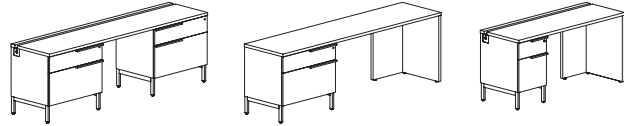

Peninsula Credenzas [Page 162-165](#)

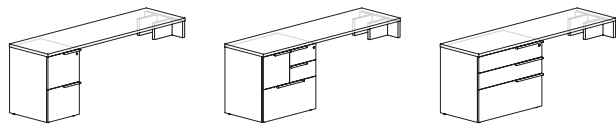

Primary Height Credenzas (on legs) [Page 166-187](#)

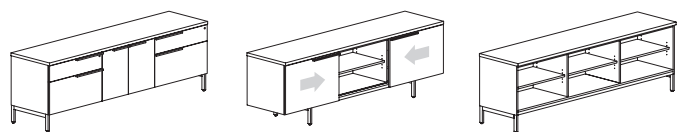

Secondary Height Credenzas [Page 188-211](#)

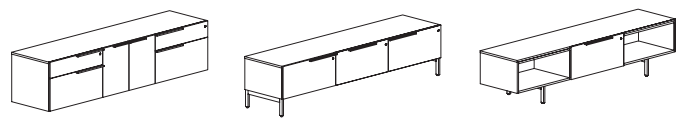

Cushions [Page 212-213](#)

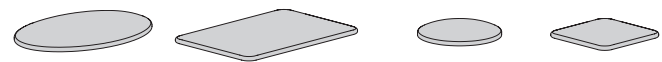

Adjustable Height Units [Page 214-251](#)

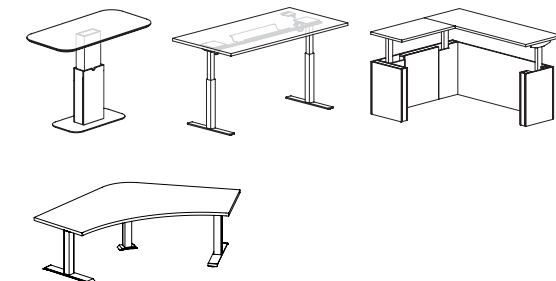

Flux Overview

Modular Units [Page 252-269](#)

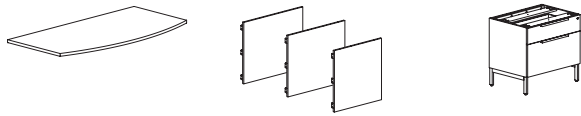

Overhead Cabinets/Panels (Primary Ht.) [Page 270-295](#)

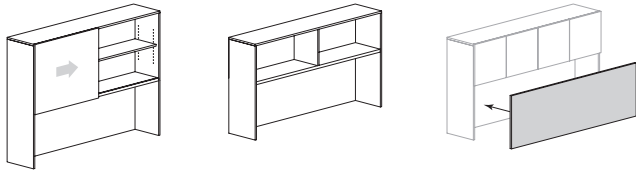

Overhead Cabinets/Panels (Secondary Ht.) [Page 296-309](#)

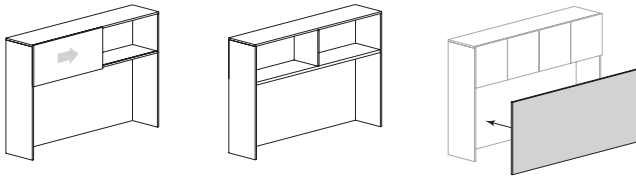

Wall Mount Overhead Cabinets [Page 310-329](#)

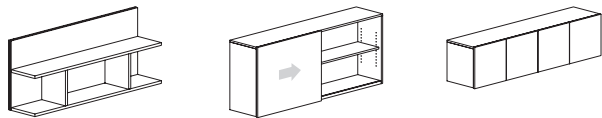

Wall Mount Cubbies [Page 330-335](#)

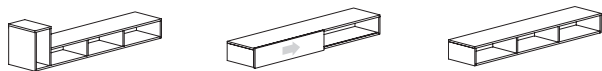

Wall Mount Panels/Accessories [Page 336-361](#)



Storage Towers [Page 362-367](#)

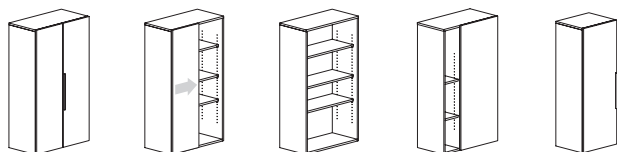

Monitor Cabinets [Page 368-375](#)

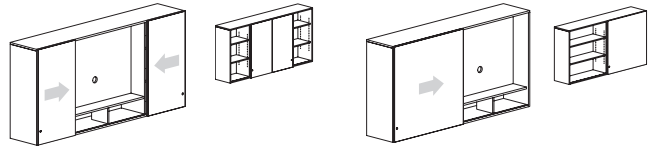

Bookcases/Vertical Filing [Page 376-379](#)

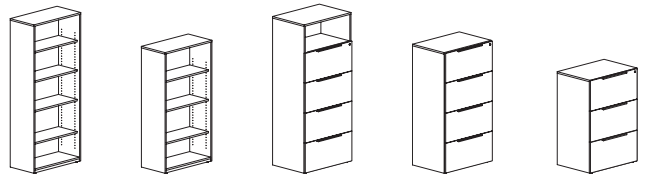

Wardrobes/Vertical Cabinets (to floor) [Page 380-413](#)

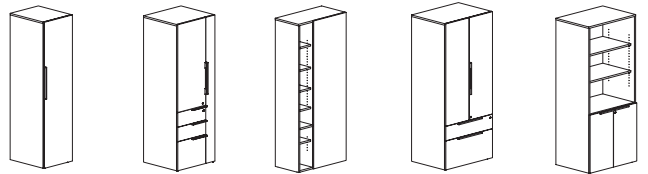

Wardrobes/Vertical Cabinets (on legs) [Page 414-441](#)



Pantries [Page 442-444](#)

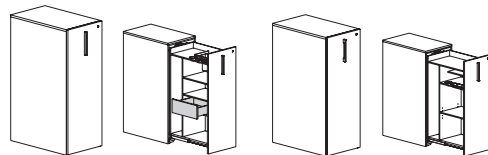

Lockers [Page 446-453](#)

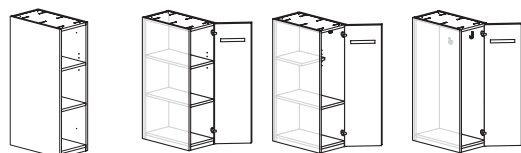

Accessories [Page 454-459](#)

Flux General Options

Laminate Products

Flux Laminate features TFL (thermally fused laminate) chassis, lockers and components. Main worksurfaces* are available in a HPL (high pressure laminate).

Eased edges of the worksurface are impact resistant (PVC) on HPL tops. The laminate is offered in wood grain patterns and solid colors. The wood grain laminate features an embossed grain to hide finger prints and light scratches. The solid laminate is smooth to the touch with a semi-matte finish. All Flux Laminate products are indoor-air certified by GreenGuard.

Laminate Worksurface Construction

Worksurfaces have a 3-ply balanced construction. Tops are 1 3/16" thick with coordinating PVC edges. Primary worksurfaces feature 3mm PVC edges on the approach and user sides. Main worksurfaces are offered in HPL. Desk, bridge, return, and primary height credenza worksurfaces are profiled with a 3mm PVC edge on the user side only. Remaining edges are banded with 1mm PVC which creates a seamless appearance when units are mated end-to-end or back-to-back.

HPL Features on Main Worksurfaces*

- fusion of multiple layers create a higher impact resistant surface
- tops are 3-ply balanced construction
- matched to the TFL wood grain and solid patterns

Case Construction

Panels for chassis consist of a 3/4" thick substrate with TFL surfaces and PVC bands on exposed edges. Pedestal and cabinets are constructed with dowels reinforced with screw and interior plates for increased stability. Leveling glides are set into metal housing corner plate to allow for maximum leveling.

*Main Worksurfaces include tops on desks, primary height credenzas, returns, bridges and transaction tops. Refer to pricing pages to confirm availability.

Veneer Products

Exterior wood surfaces are made from the finest selected veneers to achieve clarity and consistency in the Flux Veneer product line. To attain a pleasing, symmetrical pattern, all cherry, maple, black oak and walnut veneers in Flux Veneer are book-matched. All exterior solid lumber is matched to coordinate with the veneer.

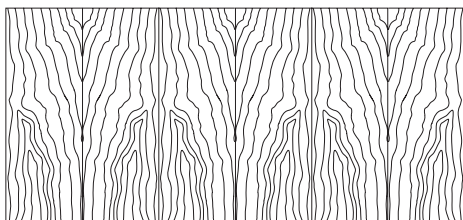

Veneer Book-Matched Example

Alternating pieces of veneer are flipped over so they face each other like the pages within a book.

Flux Veneer is available in flat cut cherry, maple, black oak and walnut veneer. A wide range of wood stains have been formulated to enhance the beauty of the veneer.

Double Cut veneer is another choice on Flux Veneer product. This veneer is a processed product that has at least two cuttings to create the final veneers. These cuts of veneer strands are dyed and layered into a block to create a wide variety of patterns, from a very tight grain pattern to an exotic figure grain pattern. Linear grain patterns can be run vertical or horizontal. Please specify the grain direction.

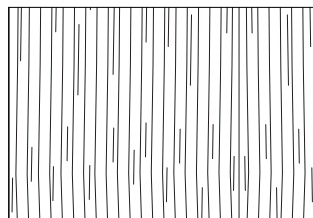

Double Cut Veneer - Tight Grain

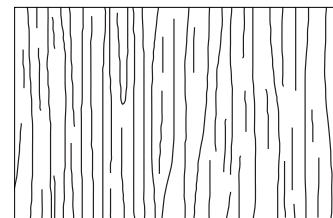

Double Cut Veneer - Natural Grain

Veneer Worksurface Construction

Tops are 3-ply balanced construction, 1 3/16" thick with matching 1.5mm wood edges. Surfaces are available in wood veneer or high pressure laminate. No additional charge for using our coordinating high pressure laminate with a veneer grain pattern with finish wood edges.

Protective Top Coat

DuraTex™ offers exceptional hardness along with abrasion and impact resistance. It has been formulated to eliminate hazardous and harmful gases that are normally associated with wood finish.

DuraTex™ Features

- Safety - Significantly reduces hazardous formaldehyde emissions which help improve the quality of the indoor air we breathe.
- Quality - Developed to be tough and durable with special attention to appearance. The DuraTex™ finish preserves the natural beauty of wood.
- Durability - Designed to meet a wide range of demanding performance and environmental standards to withstand even the highest wear and tear.

Finish Sheen

All veneer finishes are standard in 35-sheen, with the exception of Raven. Raven is only offered in 15-sheen. All other finishes can have their sheen modified with a 15% upcharge added to the list price of each item.

Custom/Special Finishes

JSI, upon request, will accommodate special finishes. A written request is required to proceed with custom finish orders. A sample reference is required for first-time matches and must be included with the written request.

There is a one-time charge of **\$400 list per order** for any non-standard wood finish.

Orders will be entered noting the special finish. A sample match will be provided to the customer. Written approval is needed before the finish process can be started. Delays in approval may have an impact on lead times.

Every effort will be made to create the requested match; however, an acceptable match may not be possible because of natural variations of wood. These natural variations can also cause minor differences in the final finish product.

Use standard pricing and option pricing for each line item with a special finish, unless additional modifications have been specified. For items available in both Essential and Artisan veneers, apply the Essentials pricing.

Flux General Options

Flux Standard Laminate Offering

The chart below lists the laminates available on Flux.

Laminate Options

TFL - HPL Wood Grain Pattern Laminates

BEL Belair	MIN Mineral
BRK Brickdust	MCH Mocha
CSK Cask	OBK Outback
CLY Clay	PIL Pilsner
EGR Egret	PIN Pinnacle Walnut
FAW Fawn	UMB Umber
FLN Flint	VAL Valley
FLO Florence Walnut	WLH Walnut Heights
LOF Loft	WEA Weathered Ash
MES Mesa	

TFL - HPL Solid Laminates

ALB Alabaster	SHD Shadow
BLK Black	SLG Slate Grey
BBL Bridal Blanco	ZEN Zen Grey
DWH Designer White	

Flux Color Scheme – Accent Colors

Metal Accents

ABZ Aged Bronze	PEW Pewter
ASL Arctic Silver	SBZ Soft Bronze
GLD Gold	SNK Soft Nickel
MBK Matte Black	

Items below are available in any of the seven color schemes listed above:



drawer pulls



grommets



side grommets

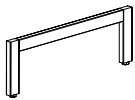

static legs, end frames, and post frames



metal wire managers

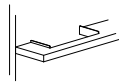

hanging folder brackets

* Note: Height adjustable legs are not offered in all seven color schemes

Black Accents

MLK	Matte Black
-----	-------------

Items below are standard as matte black:



oval grommets

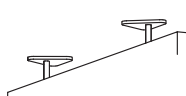

hanging modesty brackets

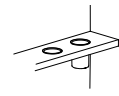

desk accessories

Flux Standard Veneer Finish Offering

The charts below list the veneer stains and paints available on Flux.

Finish/Stain Colors

ESS Essentials Veneer Collection

BRK Brickdust	MIN Mineral
CSK Cask	MCH Mocha
CLY Clay	OBK Outback
FAW Fawn	PIL Pilsner
FLX Flax	SIE Sienna
FLN Flint	TRF Truffle
LOF Loft	UMB Umber
MES Mesa	VAL Valley

ART Artisan Veneer Collection

BAR Barrel	RAV Raven
BUF Buff	RYE Rye
CND Cinder	SAB Sable
EGR Egret	SAD Saddle

PNT Paint Color

BKD Backdrop	NWH Nonchalant White
BFX Black Fox	SVP Silverplate
BWH Bright White	SKS Skyline Steel
CHT Chatroom	STM Storm
GAL Gale Force	TRC Tricorn Black
GRV Greek Villa	UKH Universal Khaki

Contact Customer Service for any additional veneer species. Samples available upon request.

Veneer Chassis with Laminate Tops

Worksurface only, no additional upcharge if Flux's coordinating wood grain laminate is specified. Contact Customer Service for any other laminate request. Listed below are finishes with coordinating wood grain HPL laminates.

ESS Essentials Veneer

BRK Brickdust	MIN Mineral
CSK Cask	MCH Mocha
CLY Clay	OBK Outback
FAW Fawn	PIL Pilsner
FLN Flint	UMB Umber
LOF Loft	VAL Valley
MES Mesa	

ART Artisan Veneer

EGR	Egret
-----	-------

Flux General Options

Desk Pedestal Configuration

The following are standard configurations for Flux pedestal desks.

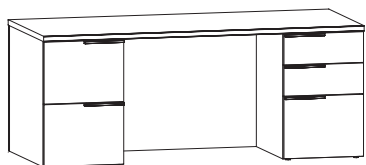

Double Pedestal Desk

Left side: file/file
Right side: box/box/file

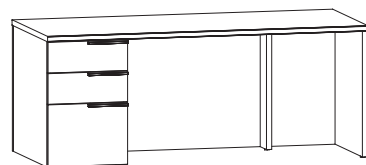

Single Pedestal Desk

box/box/file

The 18"w and 15- 5/8"w pedestal configuration can be switched from box/box/file to file/file or from file/file to box/box/file. This configuration change applies to desks, open corner credenzas and kneespace credenzas at primary height without legs. This must be specified on the order, with an upcharge of **\$206** list per pedestal.

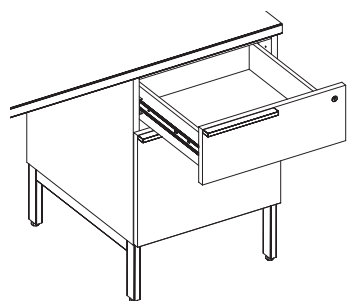

Drawer Information

Flux is standard with a unidirectional V-fold drawer box interior. The box is a durable, miter-fold drawer structure which is glued and doweled. The ½"-thick drawer sides are wrapped in a high-grade maple vinyl, with an attached front. The drawer front is attached to the four sided box.

Wood Drawer Boxes

Optional four corner dovetailed wood drawers are available. Specify and add 10% per unit.

Drawer Suspension

High quality black drawer suspension carries a lifetime warranty. File and box drawers have 100% full extension with over travel. Slides feature steel ball bearings for longer wear and positive, cushioned in/out stops.

Filing Hardware

All file drawers are constructed with a custom design for hanging folders. See filing diagram on next page.

Locking

All desks, credenzas, returns and mobile pedestals feature pedestal front locking to provide maximum security and flexibility in configuration. Units are shipped randomly keyed as standard. Key-alike units are available upon request for no additional charges. Removable cores for in-field re-keying are standard.

Lock face color is controlled by the metal color of the unit.

Aged Bronze, Gold, Pewter, Matte Black and Soft Bronze = Black Lock Face
Soft Nickel and Arctic Silver = Silver Lock Face

Interior compartment

Interior compartment sizes and specification matrix on pages 24-25 and 35.

Special Construction

Flux has an extensive product offering to create many types of configurations. Contact Customer Service if you are having trouble with finding the right units to complete the desired configuration. Requests for special construction need to be approved by JSI engineering.

Flux General Options

Filing Drawer Details

Desk and credenza pedestal filing drawers come with hardware to accommodate letter or legal files. File orientation options vary by pedestal size, as shown below. Legal and letter files may be arranged side-to-side in any pedestal, or front-to-back in larger pedestals. Select only one orientation for each filing drawer. Reference the following plan views for available options.

File Orientation Variations (top view)

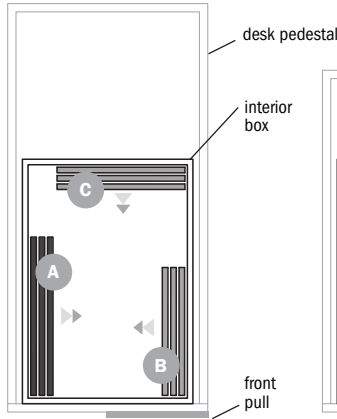

Overall Desk - 84" w through 72" w
 Desk Pedestal - 36" d x 18" w
 Interior Box - 22" d x 15 7/16" w

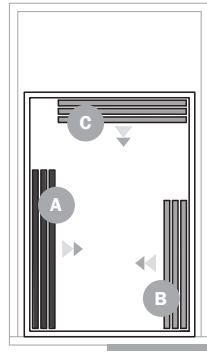

Overall Desk - 84" w through 72" w
 Desk Pedestal - 30" d x 18" w
 Interior Box - 22" d x 15 7/16" w

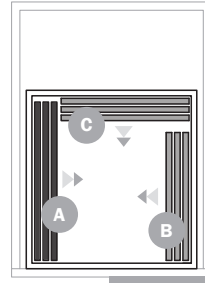

Overall Desk - 84" w through 72" w
 Desk Pedestal - 24" d x 18" w
 Interior Box - 16" d x 15 7/16" w

- A** Legal - Side-to-Side
- B** Letter - Side-to-Side
- C** Letter - Front-to-Back
- D** Legal - Front-to-Back

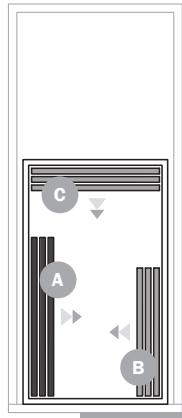

Overall Desk - 66" w through 60" w
 Desk Pedestal - 36" d x 15 7/16" w
 Interior Box - 22" d x 13" w

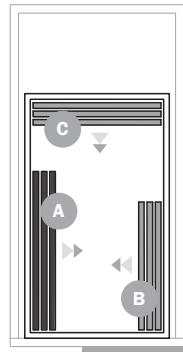

Overall Desk - 66" w through 60" w
 Desk Pedestal - 30" d x 15 7/16" w
 Interior Box - 22" d x 13" w

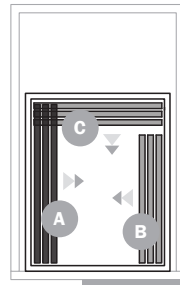

Overall Desk - 66" w through 60" w
 Desk Pedestal - 24" d x 15 7/16" w
 Interior Box - 16" d x 13" w

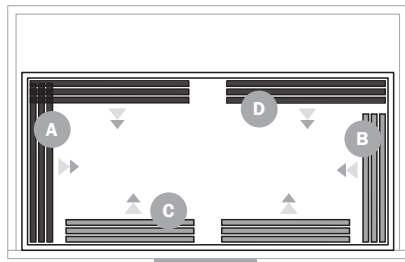

Overall Credenza - 72" w or 36" w
 Credenza Pedestal - 22" d x 36" w
 Interior Box - 16" d x 33 7/16" w

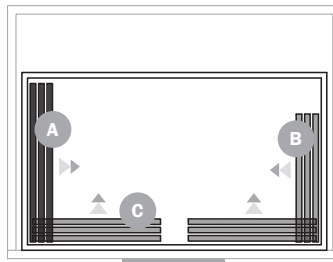

Overall Credenza - 96" w, 90" w, 84" w, 78" w,
 66" w, 60" w, 54" w, 48" w, 42" w or 30" w
 Credenza Pedestal - 22" d x 30" w
 Interior Box - 16" d x 27 7/16" w

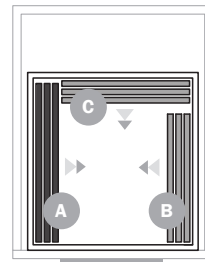

Overall Credenza - 96" w, 90" w,
 84" w, 78" w or 72" w
 Credenza Pedestal - 22" d x 18" w
 Interior Box - 16" d x 15 7/16" w

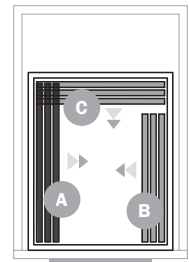

Overall Credenza - 66" w, 60" w,
 54" w, 48" w or 42" w
 Credenza Pedestal - 22" d x 15 7/16" w
 Interior Box - 16" d x 13" w

Flux General Options

Top Edge Profiles

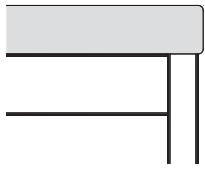

Eased Edge
Standard on worksurface tops

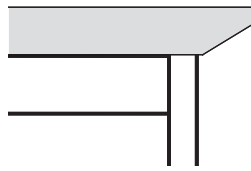

Reverse Bevel Edge
Optional on selected worksurfaces (see below)

Reverse Bevel Edge Location

Peninsula and Run-off Desks

The reverse bevel edge appears on three sides of the worksurface top, as shown to the right, and increases the depth of the top by 2½".

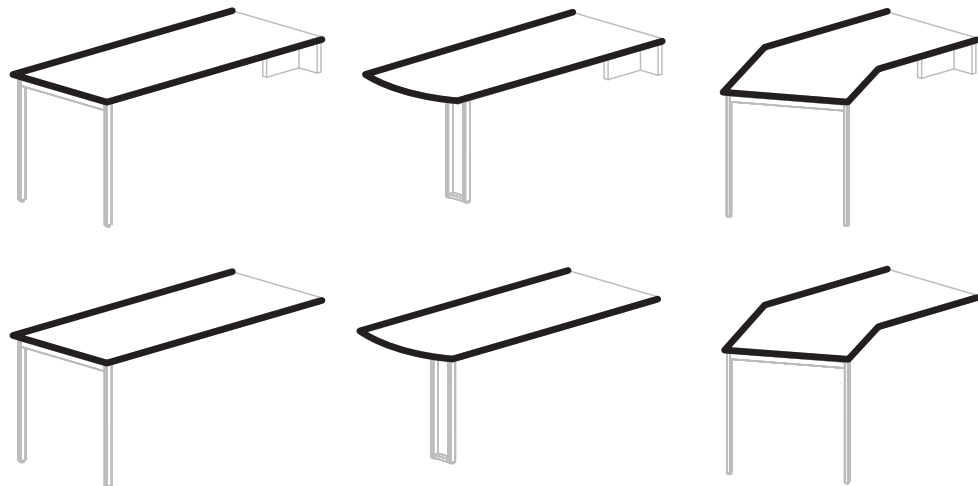

Adjustable Height Desks

The reverse bevel edge location varies according to its worksurface. When it appears on two sides, the depth of the worksurface increases by 2½". When the bevel appears on one side only, it increases the depth by 1¼". Dimension changes only happen when there is no overhang.

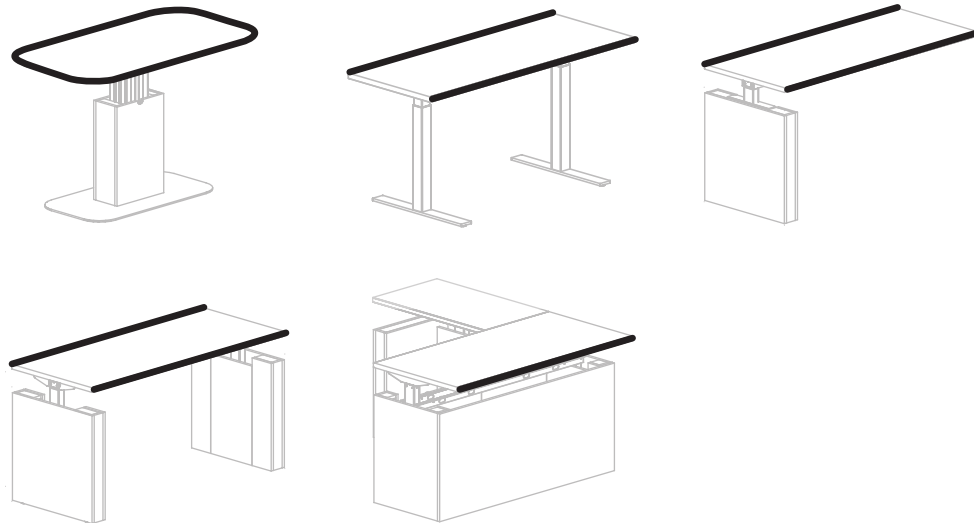

Tables

The reverse bevel edge location varies, as shown to the right, and increases the depth of the top by 2½" on the rectangle table.

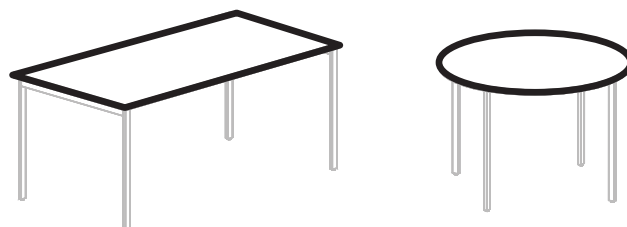

Flux General Options

Pulls and Pull Orientation

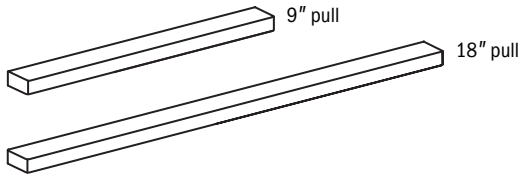

Ledge Pull

- Available in Aged Bronze, Arctic Silver, Gold, Matte Black, Soft Bronze, Soft Nickel or Pewter
- Ledge pull is considered part of the aesthetic of Flux and has unique orientation on the product. See chart below for these locations.
- Ledge pull length is determined by drawer/door width as follows:

9" pull	drawers/doors 18" wide or less
18" pull	drawers/doors wider than 18"



Prism Pull

- Available in Aged Bronze, Arctic Silver, Gold, Matte Black, Soft Bronze, Soft Nickel or Pewter
- Prism pull is mounted in the center of drawers on all drawer and lower doors widths. Upper pulls on worksurface towers or wardrobes are mounted on the right door only.

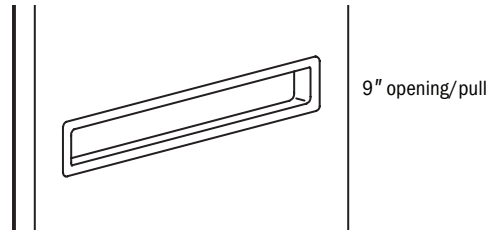

Mail Slot Pull (Lockers Only)

- In addition to Ledge and Prism pulls, mail slot is available on lockers only
- Available in Arctic Silver, Soft Nickel, Matte Black or Pewter

Lower Drawer/Door Ledge Pull Location



Tower/Wardrobe Ledge Pull Location

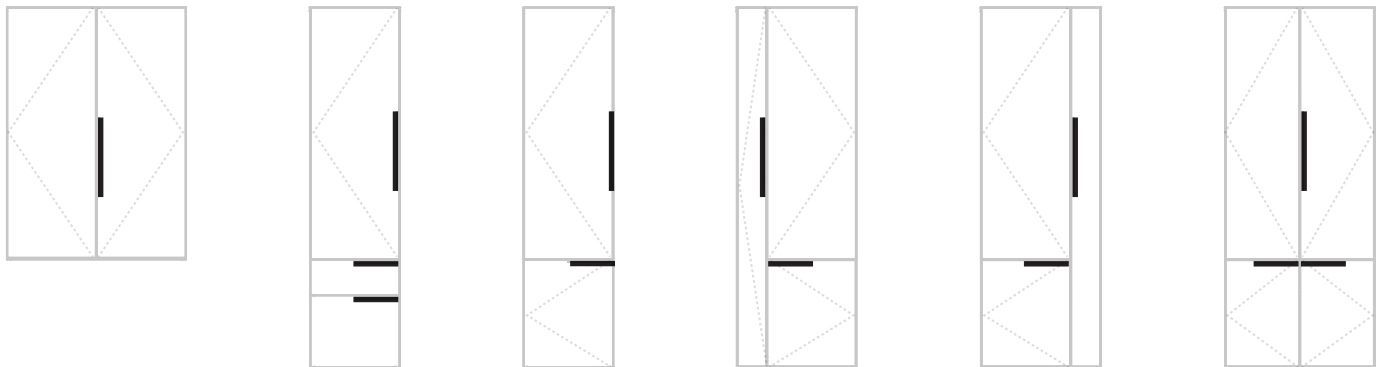

Flux General Options

Locker Pull and Lock Options

PRODUCT INFORMATION

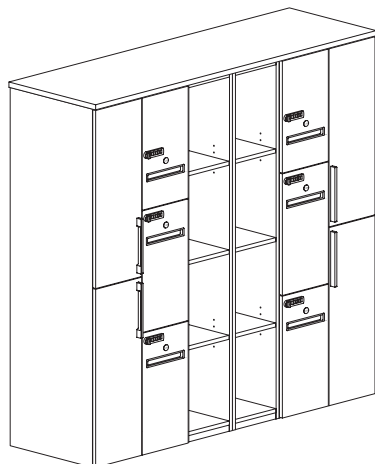

Lockers are available with a variety of pull and lock combinations.

Pulls

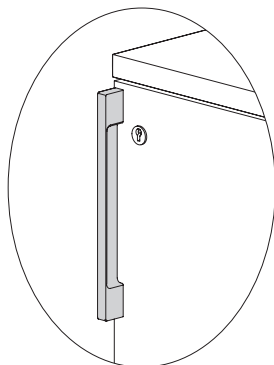

Ledge

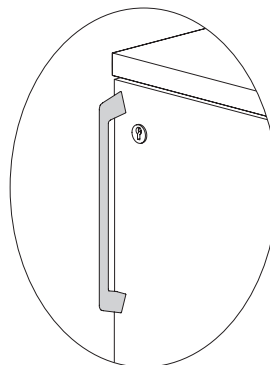

Prism

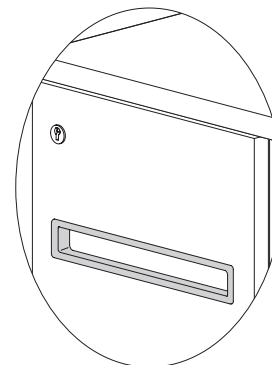

Mail Slot

Locks

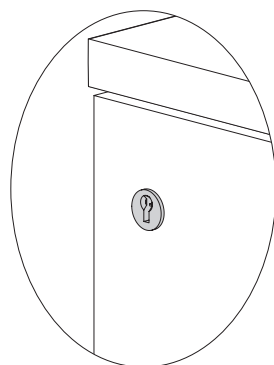

Standard

Standard lock and key. Black or silver finish. Ordered separately and field installed. Specify finish and number range. See page 455.
\$109 upcharge per lock.

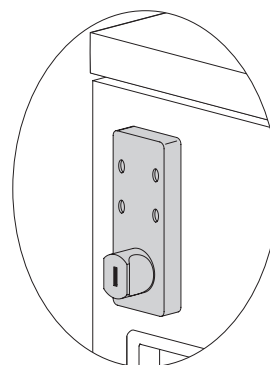

Keyless Radial

Temporary 4-digit code gets programmed by each user interaction. Built-in finger grip does not require additional pull. Prism and Ledge pulls not available. Satin Nickel finish. Master Key available, see page 455.
\$388 upcharge per lock.

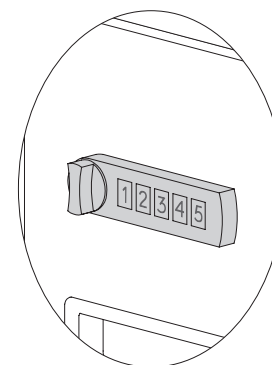

Digital Keypad

Temporary 4-digit code gets programmed by each user interaction (Locker Mode). May be reset to "Station Mode" for repeated use with a single code. Black or Silver finish. Master Key Fob available, see page 455.
\$437 upcharge per lock.

Locker Number Plates

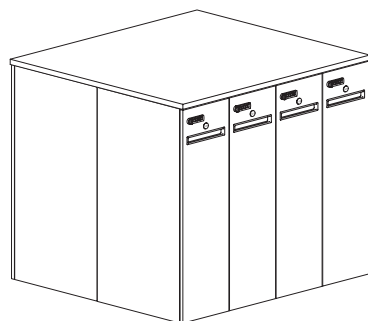

Locker number plates are available for identification. Adhesive backed for field installation. Ordered separately. Specify finish and number range, see page 455.

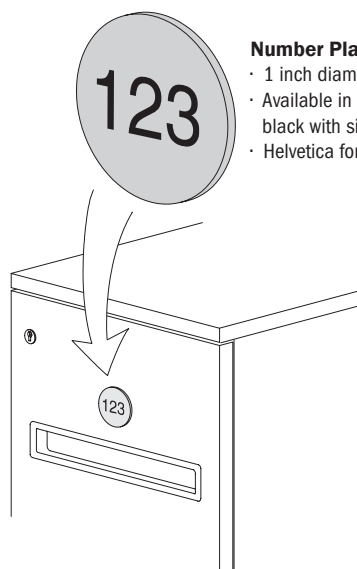

Number Plate

- 1 inch diameter aluminum
- Available in silver with black numbers or black with silver numbers
- Helvetica font, 1-3 characters

Flux General Options

Caster Option

Flux offers a dual wheel caster option with freestanding and four-star base tables, in place of standard feet.

Casters are gray when paired with Arctic Silver or Soft Nickel metal legs, or black with Aged Bronze, Gold, Matte Black, Soft Bronze or Pewter metal legs

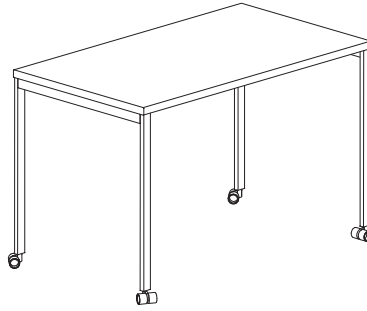
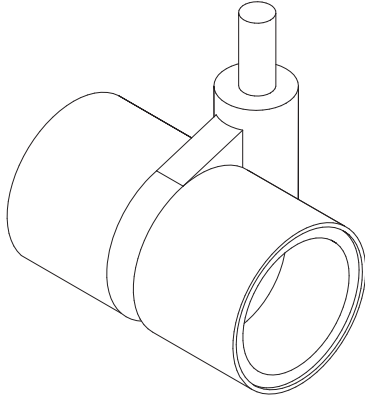

Freestanding tables with legs

Available with 2 locking and 2 non-locking casters



4-star base tables

Available with 4 locking casters

Flux General Options

Modesty Panel Options

Flux offers optional modesty panels for table desks, adjustable height desks, returns, bridges and credenzas. Reference the diagrams below for the modesty panel location on each unit.

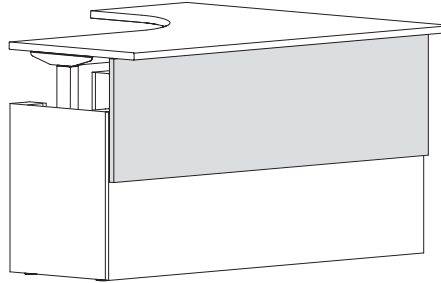
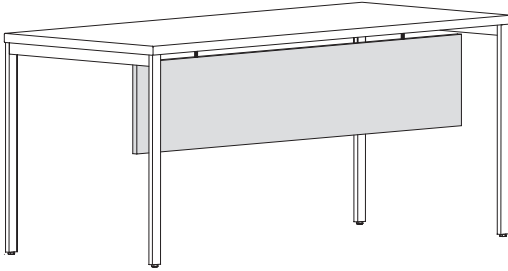
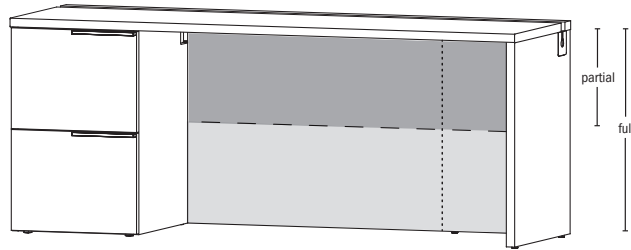
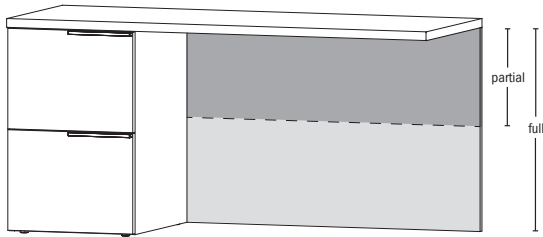

Table Desks

12" suspended modesty panels are available on table desks, peninsula desks, and run-off desks.

Adjustable Height Desks

Modesty panels are available on adjustable height desk shells. The modesty panel mounts in front of the desk and moves with the top.



Returns and Bridges

Partial or full modesty panels are available on return and bridge units.

Credenzas

Partial, full or removable modesty panels are available on credenzas.

Flux Applied Materials

Laminate Grain Direction

Laminate grain runs vertical as standard on all vertical surfaces except back panels, wall panels, kneespace access panels, and desk fronts **wider than 60"**, **which run horizontal**. Worksurfaces run long grain except for bridges, returns, and peninsula and run-off tops **60" and shorter, which run short grain**. Below are typical examples of laminate grain direction.

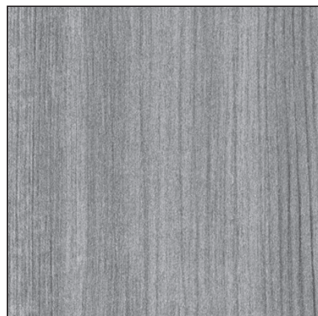
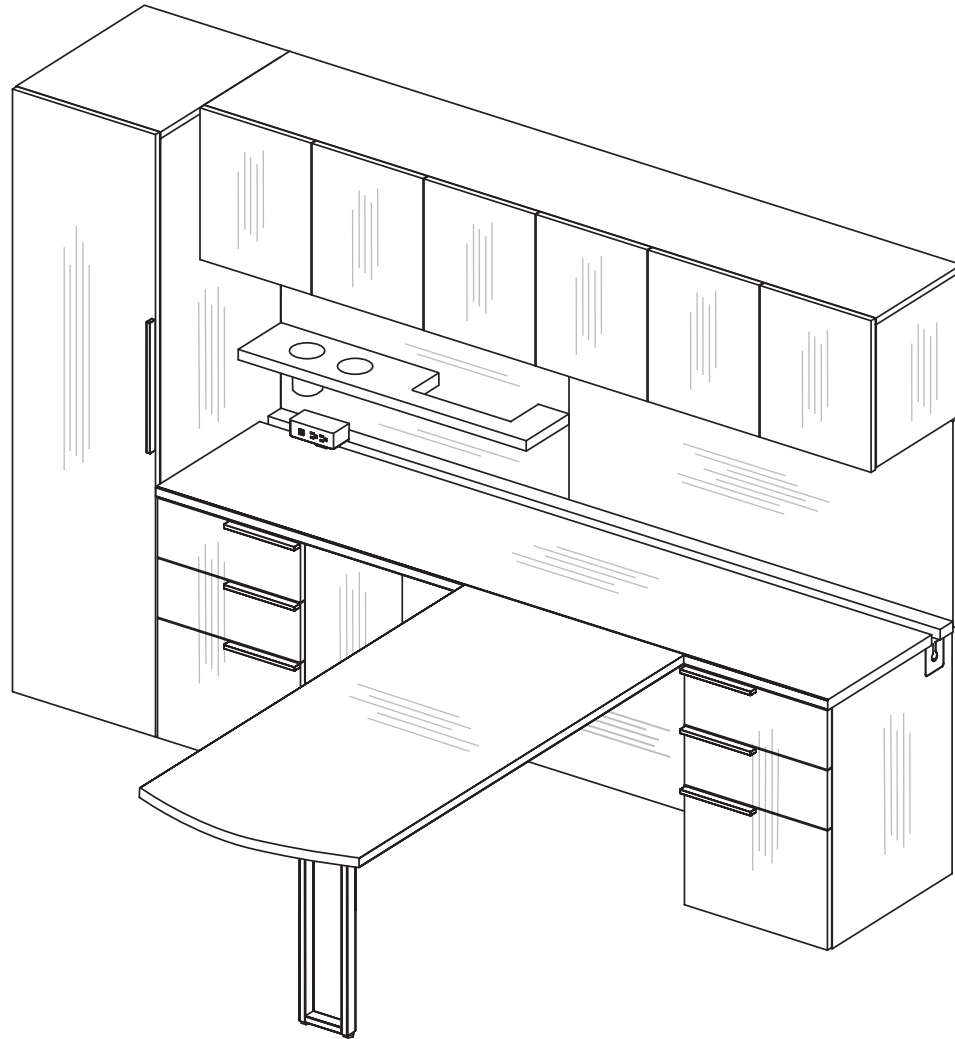

Laminate Grain

Laminate grain direction varies according to its casegood surface. Refer to the diagrams on this page for examples of standard direction.

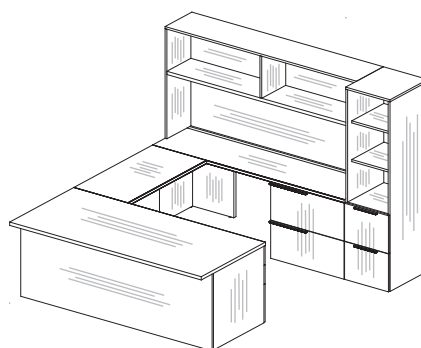

Flush Front Desk U Unit with Open Storage

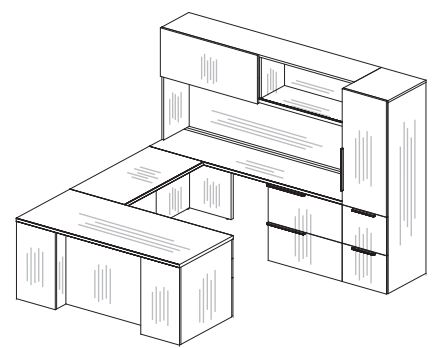

Breakfront Desk U Unit with Closed Storage

Flux Applied Materials

Vertical Veneer Grain Direction

All Flux veneer finishes can run vertical on all vertical surfaces. Worksurfaces run long grain except for bridges, returns, peninsula and run-off tops, which run short grain. Below are typical examples of vertical veneer grain direction.

PRODUCT INFORMATION

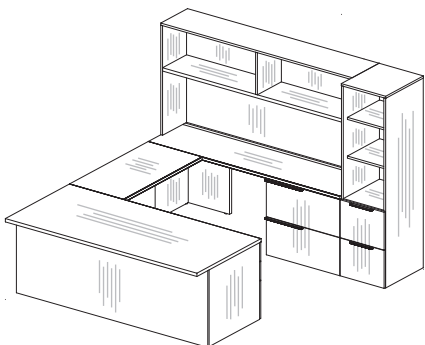

Flush Front Desk U Unit with Open Storage

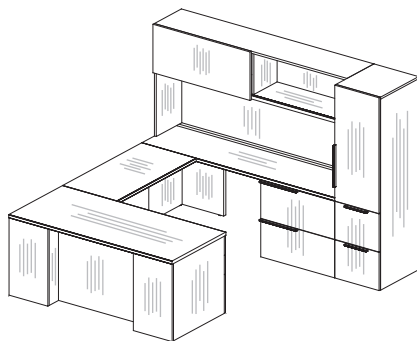

Breakfront Desk U Unit with Closed Storage

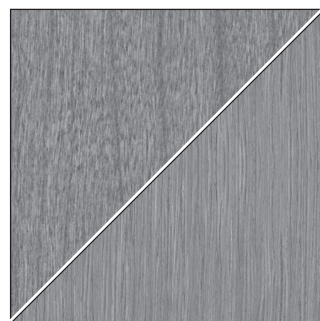
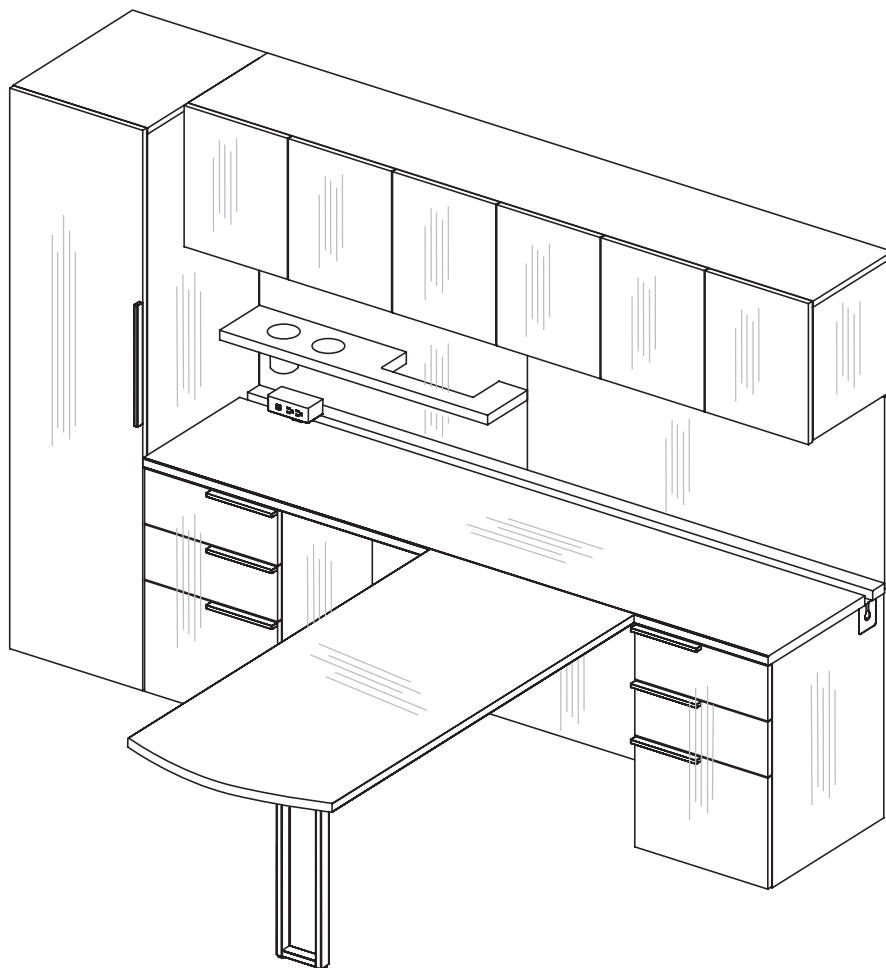

Vertical Grain Direction

Most veneer finishes run vertical as standard. Some linear grain patterns have an optional grain direction; specify at the time of order placement. See diagrams on this page for examples and exceptions.

Essentials Veneer

- Brickdust
- Cask
- Clay
- Fawn
- Flax
- Flint
- Loft
- Mesa
- Mineral
- Mocha
- Outback
- Pilsner
- Sienna
- Truffle
- Umber
- Valley

Artisan Veneer

- Barrel
- Buff
- Cinder
- Egret
- Raven
- Rye
- Sable
- Saddle

Flux Applied Materials

Horizontal Veneer Grain Direction

Linear grain patterns may be specified with a horizontal grain direction on all surfaces. Worksurfaces run long grain except for bridges, returns, peninsula and run-off tops, which run short grain. Below are typical examples of horizontal veneer grain direction.

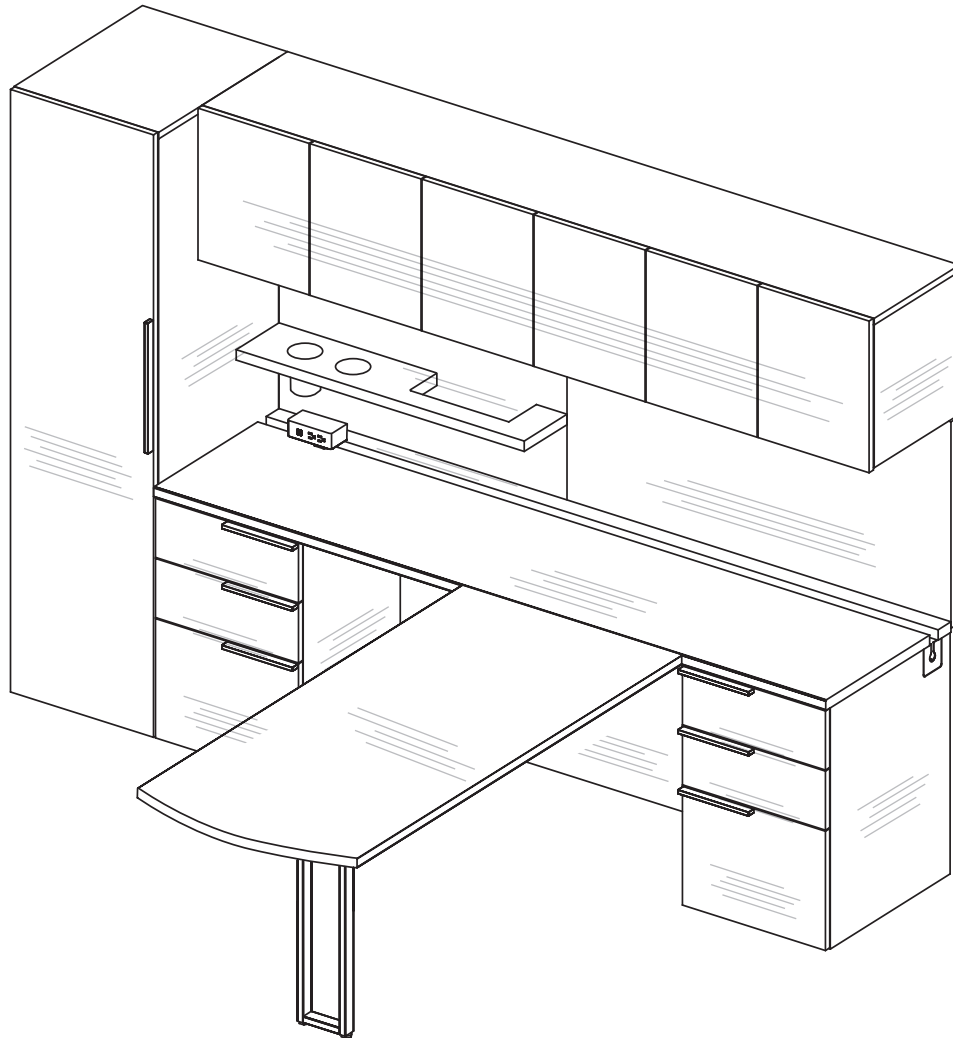

PRODUCT INFORMATION



Horizontal Grain Direction

Linear grain patterns may be specified to run horizontal; specify at the time of order placement. Refer to the diagrams on this page for examples.

Essentials Veneer Horizontal Grain Patterns: Fawn, Flint, Loft and Valley

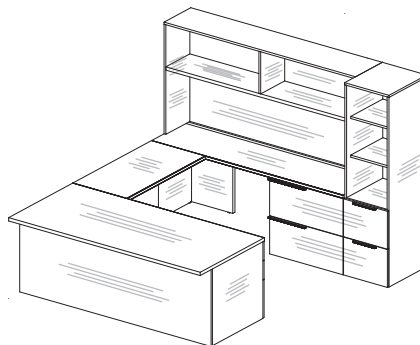

Flush Front Desk U Unit with Open Storage

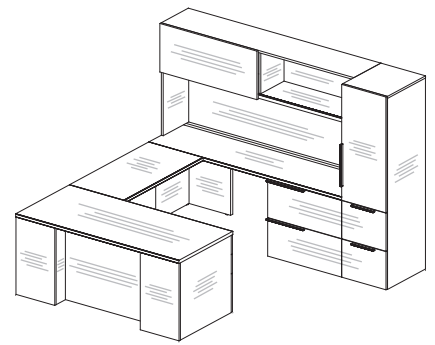

Breakfront Desk U Unit with Closed Storage

Flux Applied Materials

Flux Color Scheme

Flux offers the flexibility to specify contrasting drawer and door fronts, or a contrasting worksurface for laminates, separate from the standard chassis selection. See the options available below, depending on whether laminate or veneer is specified for the chassis.

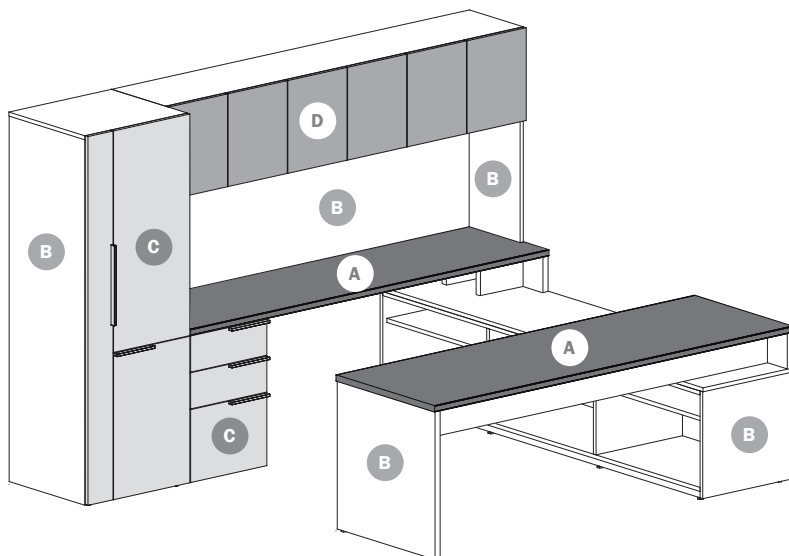

Laminate Surface Options

- A = Worksurface**
Laminate – see page 5 for selection
- B = Chassis**
Laminate – see page 5 for selection
- C = Drawer and Door Fronts**
 1. standard – same as chassis selection
 2. optional – contrasting laminate from standard selection
- D = Overhead and Worksurface Storage Doors**
 1. standard – same as chassis selection
 2. optional
 - a. contrasting laminate from standard selection
 - b. white back painted glass doors in an aluminum frame – see page 31
 - c. markerboard laminate with silver PVC edge see page 31

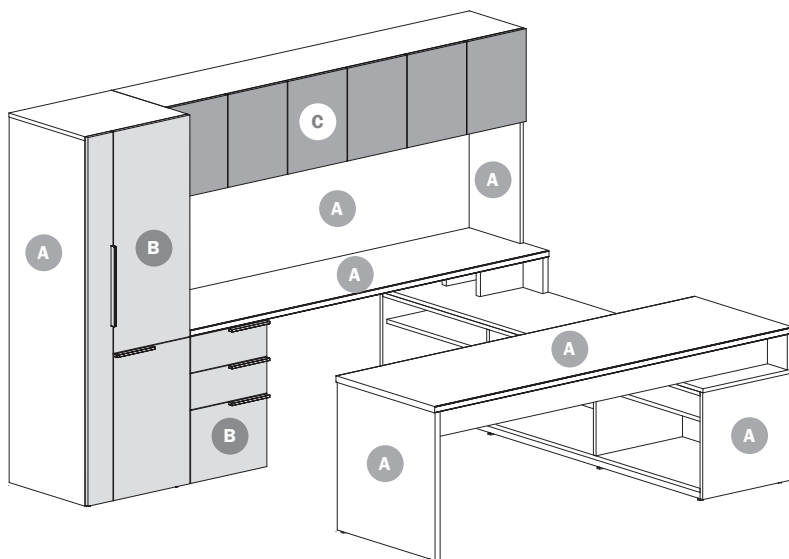

Veneer Surface Options

- A = Worksurface and Chassis**
Veneer – see page 5 for selection
- B = Drawer and Door Fronts**
 1. standard – same as chassis selection
 2. optional – paint color (vertical maple veneer substrate) – see page 5 for color selection
- C = Overhead and Worksurface Storage Doors**
 1. standard – same as chassis selection
 2. optional
 - a. paint color (vertical maple veneer substrate) see page 5 for color selection
 - b. white back painted glass doors in an aluminum frame – see page 31
 - c. markerboard laminate with silver PVC edge see page 31

Flux Desk Details

Pedestal Desks

Product Overview

The Flux pedestal desk is available with a break front or flush front. Options for wire management vary depending on the selected desk.

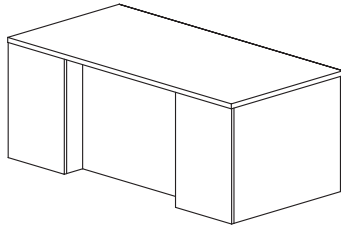

Break Front Desk
Pedestal access door optional

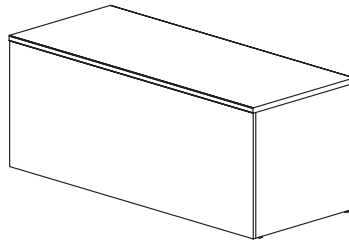

Flush Front Desk

PRODUCT INFORMATION

Wire Manager Tray

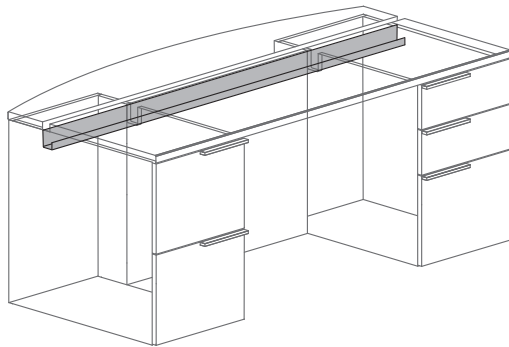

Desks with a split top have a continuous wire manager tray as a standard feature.

Note: desks do not have side end panel grommets.

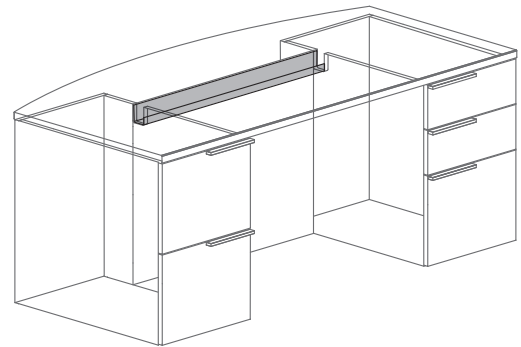

A wire manager tray can be ordered on desks with solid tops by optioning in the pedestal access door (available on break front desks) or by ordering a continuous wire manager tray.

Note: it is recommended that with either of these options, a top grommet be specified.

Pedestal Access Doors

Available on the front of break front desks to conceal cords. Both right and left pedestals of desk will have the access door with this option.

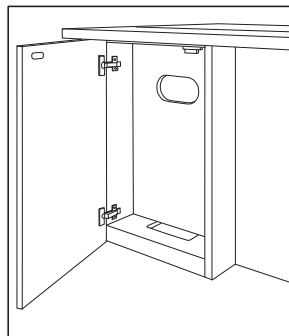

Flux Desk Details

Peninsula Desk with Secondary Credenza Support

Product Overview – Peninsula Desk

The Flux peninsula desk, which mounts to the top of a secondary height credenza for support, is available in a variety of top shapes and base styles. Edge profile and modesty panel options vary according to the style selected. Below are a few examples of top and base combinations.

PRODUCT INFORMATION

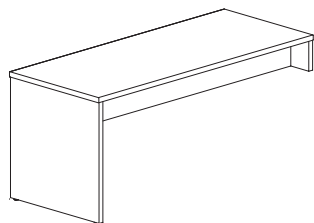

Rectangle Peninsula Table Desk with End Panel Support
Eased Edge only
Partial Modesty Panel standard

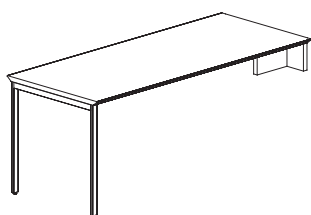

Rectangle Peninsula Table Desk with End Leg Assembly
Reverse Bevel Edge optional
Partial Modesty Panel optional

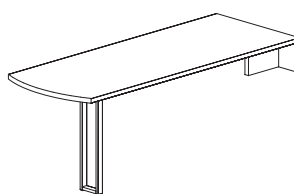

Arc End Peninsula Table Desk with Frame Base
Reverse Bevel Edge optional
Partial Modesty Panel optional

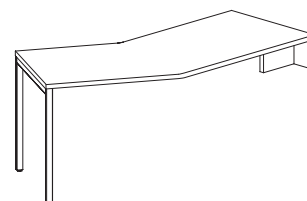

Boomerang Peninsula Table Desk with End Leg Assembly
Reverse Bevel Edge optional
Partial Modesty Panel optional

Product Overview – Secondary Height Credenza

The peninsula desk mounts to – and must be specified with – a secondary height credenza with an open compartment or sliding door compartment. See secondary height credenzas on pages 188-211 for pricing.

Secondary Credenza Examples

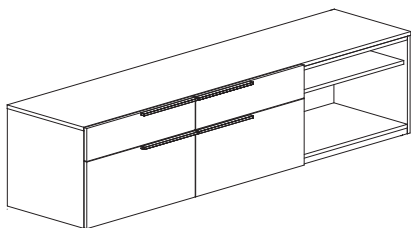

open compartment

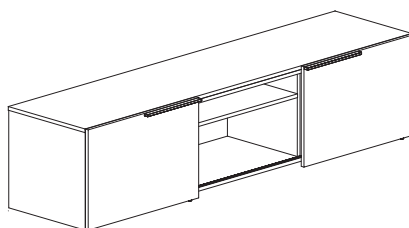

sliding door compartment

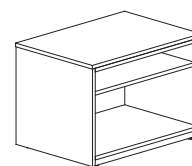

open compartment

Layout Requirements

27 1/2" desk can pair with any open compartment. 33 1/2" desk pairs with an open compartment 32" or greater in width.

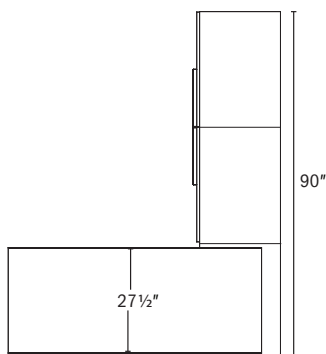

90" w credenza:
use 27 1/2" d desk

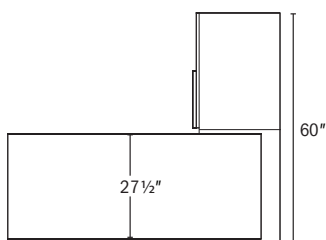

60" w credenza:
use 27 1/2" d desk

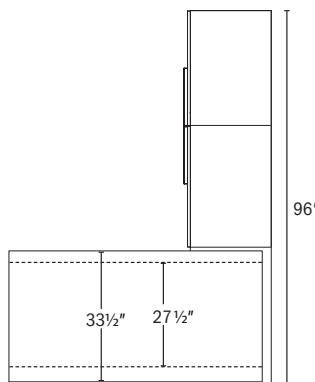

96" credenza:
use 27 1/2" d or 33 1/2" d desk

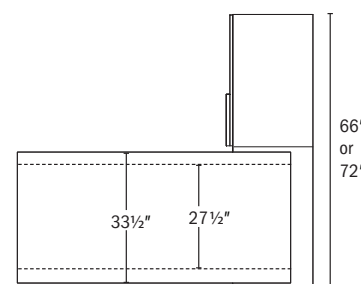

66" or 72" credenza:
use 27 1/2" d or 33 1/2" d desk

Flux Desk Details

Ordering the Secondary Height Credenza

When ordering the credenza, the mounting location for the peninsula desk must be specified as Left (L), Center (C) or Right (R), and the peninsula depth must be specified (22", 27 1/2" or 33 1/2"). A cut out for a power module in the credenza top may be specified by adding the letter E to the order code.

Mounting Code Table

Peninsula Depth	Left Mount	Center Mount	Right Mount	Left Mount with Power	Center Mount with Power	Right Mount with Power
22"	L22	C22	R22	L22E	C22E	R22E
27 1/2"	L28	C28	R28	L28E	C28E	R28E
33 1/2"	L34	C34	R34	L34E	C34E	R34E

Mounting Code Examples

L 28 = mounts **Left**, with a **27 1/2"-deep** peninsula desk

C 28 = mounts **Center**, with a **27 1/2"-deep** peninsula desk

R 28 = mounts **Right**, with a **27 1/2"-deep** peninsula desk

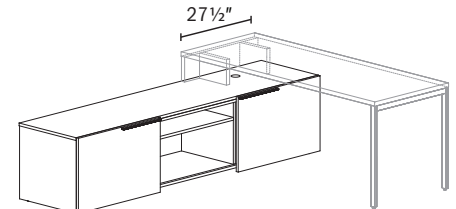
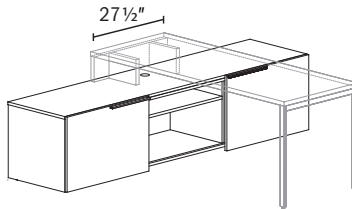
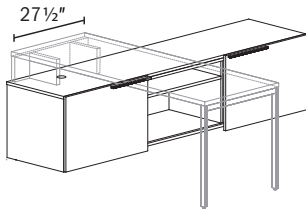

Technology Integration

Each mounting location comes with a 2 1/2"-diameter grommet for wire management. An EC26 power module cut out may also be added, and must be specified when ordering by adding the letter E to the mounting code. The power module must be ordered separately. See page 444.

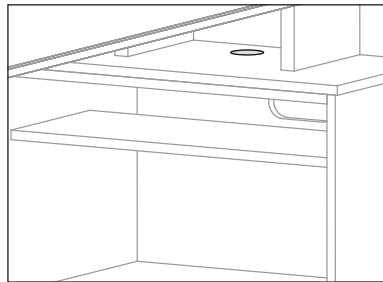

2 1/2"-diameter grommet

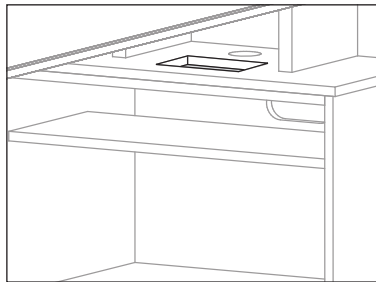

EC26 power module cut out

Power Module Cut Out Code

L 28 E

The grommet and EC26 power module locations are predetermined when selecting the peninsula mounting options; additional grommets or EC26 power modules can be specified at other locations on the secondary credenza. See page 45.

Flux Desk Details

Placement Locations

The peninsula desk may mount flush to the back panel of the credenza, or offset 5" to allow for an overhead hutch. Placement locations can be selected during field installation.

PRODUCT INFORMATION

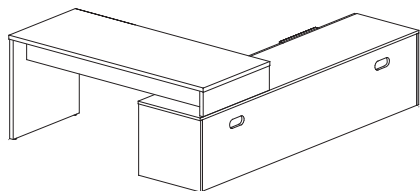

Placement 1 - Flush with Credenza Back

Can be used when no overhead storage is specified in the layout.

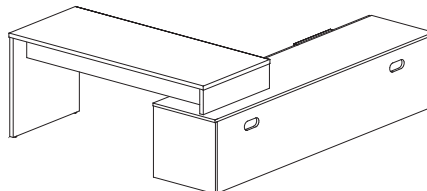

Placement 2 - Offset 5" from Back Panel

Must be used when placing an overhead on the secondary credenza.

Note: the overall foot print grows by 5"

Reverse Bevel Edge Rules

A reverse bevel edge adds 1 1/4" to the front of the desk top. Overheads that mount on the secondary credenza cannot be used with peninsula desks with reverse bevel edges. For more on edge profiles, see page 8.

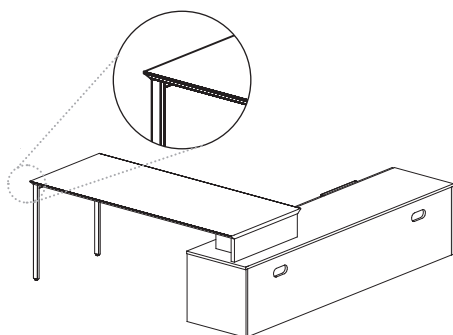

Peninsula desk with reverse bevel edge

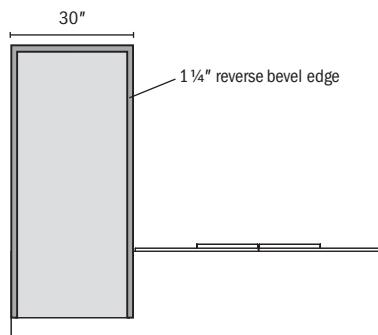

Plan view of peninsula with reverse bevel edge

Note: lacks required space for overhead mounting

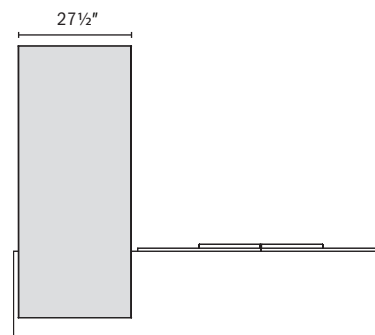

Plan view of peninsula with standard eased edge

Note: allows room for overhead mounting

Flux Desk Details

Run-off Desks

Product Overview

The Flux run-off desk, which mounts perpendicular to primary height credenzas, is available in a variety of top shapes and base styles. Edge profile and modesty panel options vary according to the style selected. Below are a few examples of top and base combinations.

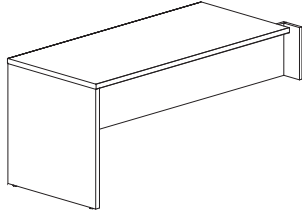

Rectangle Run-off Desk with End Panel Support
Eased Edge only
Partial Modesty Panel standard

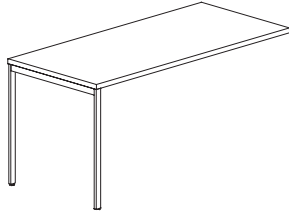

Rectangle Run-off Desk with End Leg Assembly
Reverse Bevel Edge optional
Partial Modesty Panel optional

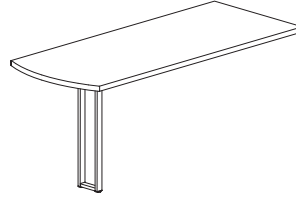

Arc End Run-off Desk with Frame Base
Reverse Bevel Edge optional
Partial Modesty Panel optional

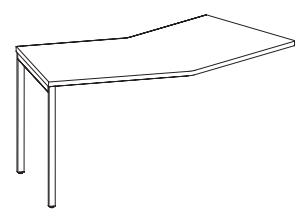

Boomerang Run-off Desk with End Leg Assembly
Reverse Bevel Edge optional
Partial Modesty Panel optional

Run-off Desk Attachment

The run-off desk mounts perpendicular to primary height units, and ships with two sets of brackets, for two types of credenzas attachments:

(1) Open Compartment Credenza

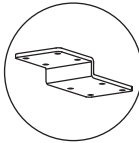
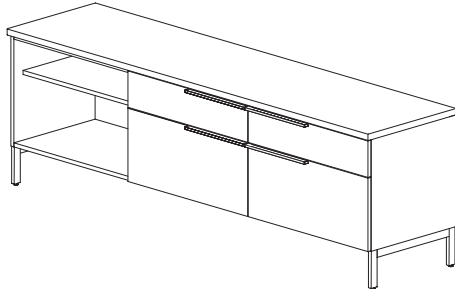

"Z" brackets

The run-off desk can be mounted to a credenza with open compartments. It attaches to the underside of the credenza with **"Z" brackets**. Run-off desks can not be mounted in sliding door compartments.

(2) Open Corner, Shell or Modular Credenza

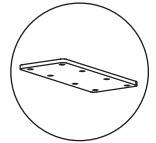
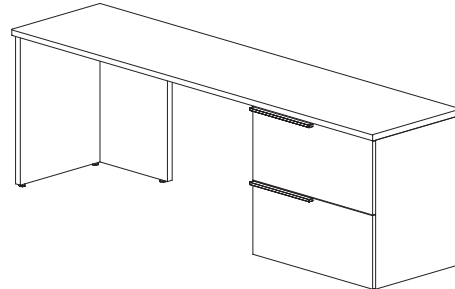

Flat brackets

The run-off desk can be mounted to an open corner credenza, credenza shell, or modular credenza. It attaches to the underside of the credenza with **flat brackets**. Use this type of credenza with run-off desks that have End Panel Supports with standard modesty panels.

Grain Direction

Grain direction runs "short" on run-off tops, though laminate tops longer than 60" run long grain. For more details, please reference grain direction on pages 11-13

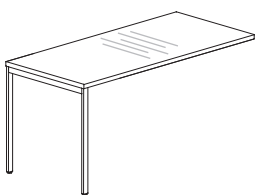

Short Grain
All veneer run-off tops
Laminate tops 60" or shorter

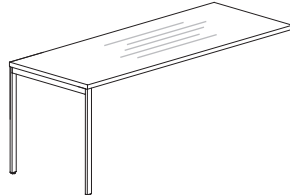

Long Grain
Laminate tops longer than 60"

Modesty Panels

13 1/2"-high hanging modesty panels are available for desks with End Leg Assembly or Frame Base. Desks with an End Panel Support come standard with an integrated modesty panel.

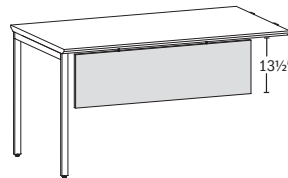

Hanging Modesty Panel
Optional for desks with metal bases

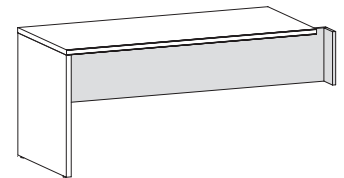

Integrated Modesty Panel
Standard with End Panel Support desks

Flux Desk Details

Adjustable Height Desks and Tables

Product Overview

Flux adjustable height desks and tables are available in a variety of top shapes and base styles, with pneumatic or electrical lift mechanisms. Metal finishes, wire management and modesty panel options vary according to the style selected. Below are various styles with adjustable height ranges.

PRODUCT INFORMATION

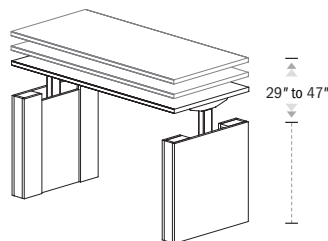

Adjustable Height Desks, Credenzas and Returns

Electrical lift mechanism
Adjustable range of 18"

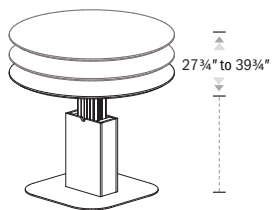

Adjustable Height Table Desks (meeting tables)

Electrical lift mechanism
Adjustable range of 18"
Round, square or rectangle shapes

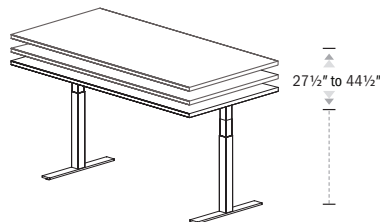

Adjustable Height Tables

Electrical or pneumatic lift mechanism
Adjustable range of 17"



Side Tables

Pneumatic lift mechanism
Adjustable range of 12"
Round, square or rectangle shapes
Nest with primary worksurfaces

Color Scheme

The finish on the adjustable lift column **A** will automatically be silver if you select Arctic Sliver or Soft Nickel metal. If Aged Bronze, Gold, Matte Black, Soft Bronze or Pewter metal is selected, the lift column **A** will be black.

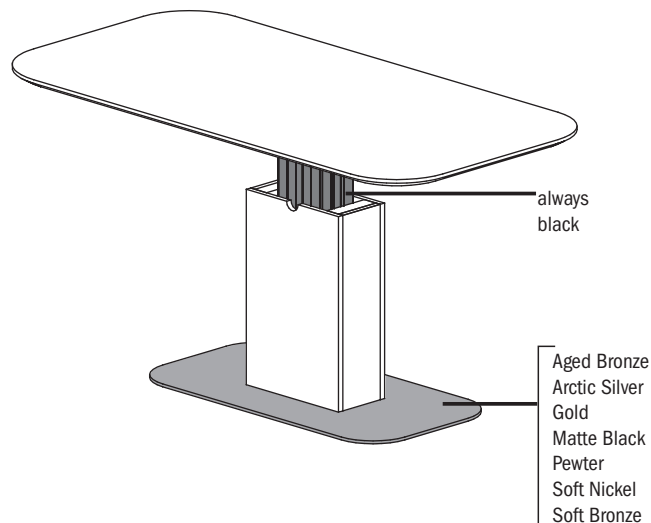
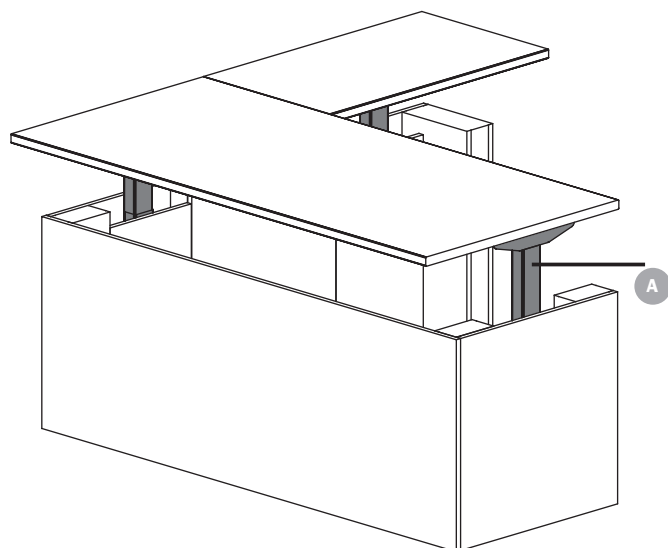

Metal finishes on electric adjustable height tables available in Alloy or Matte Black.
Metal finishes on pneumatic adjustable height tables available in Stardust Silver or Black Sandtex.

Flux Desk Details

Wire Management

Removable panels allow access to the lift columns and also provide wire management.

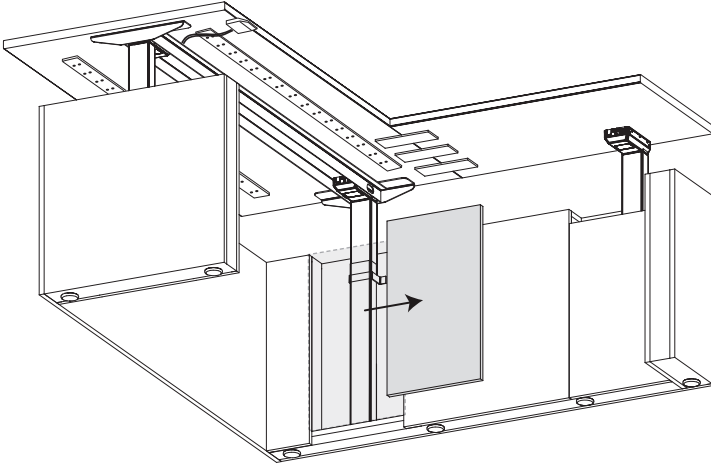

Removable panel shown from underside of adjustable height desk.

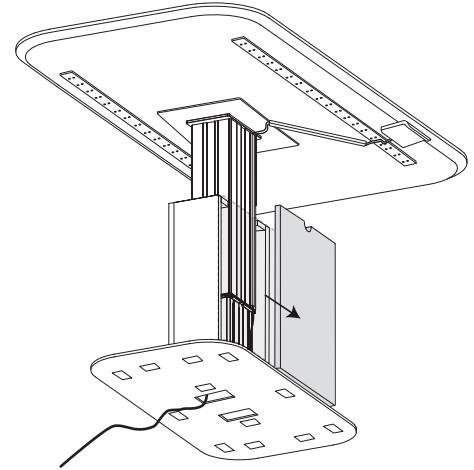

Electrical cord exits through the bottom side of the plate. Neoprene leveling pads allow the cord to lay flat.

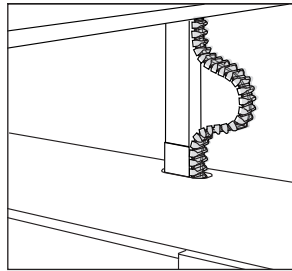

A flexible wire manager is included on adjustable desks, returns and credenzas.

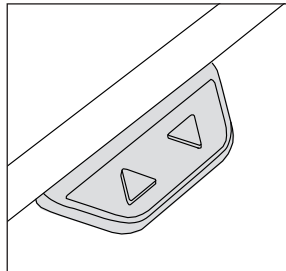

Controller can be mounted anywhere along top perimeter.

Optional Modesty Panel

An optional modesty panel can be added to an adjustable height desk or table desk.

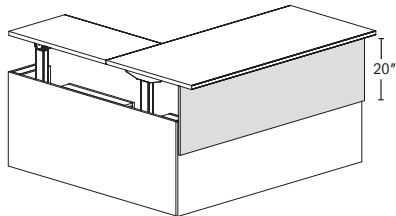

Adjustable Height Desk
Modesty panel mounts to the front of desk with overhang.

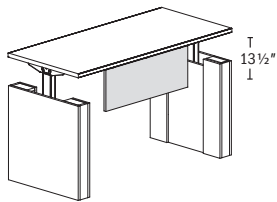

Adjustable Height Table Desk
Modesty panel mounts in between the end panels.

Nesting Side Table

Adjustable height side tables are designed to nest with primary height worksurfaces.

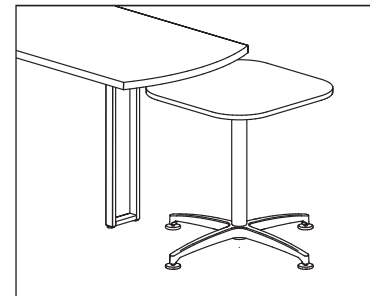

Flux Product Details

Credenzas

Product Overview

The Flux credenza is available as a 29 1/4" primary height credenza, or as a shorter, 21 1/4" secondary height credenza. Both heights come in three base styles as shown below.

PRODUCT INFORMATION

Primary Height

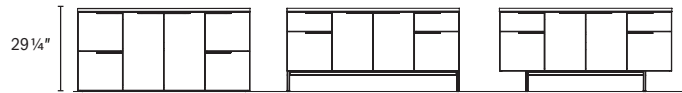

29F

Primary height
Extends to the floor

29L

Primary height
Elevated on legs

29S

Primary height
Elevated on inset legs

Secondary Height



21F

Secondary height
Extends to the floor

21L

Secondary height
Elevated on legs

21S

Secondary height
Elevated on inset legs

Drawer Alignment

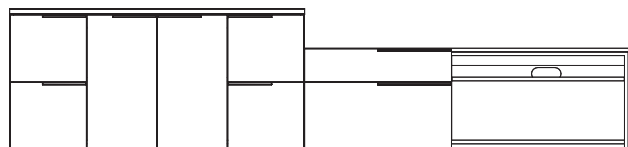

Drawers align between primary and secondary heights.

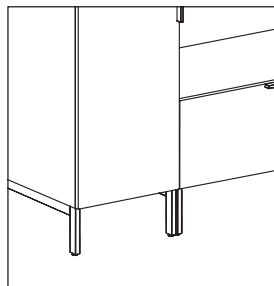

Legs pair up with adjacent units.

Credenza Oval Grommet Rules

Oval grommets for wire management are standard in all storage credenzas. Oval grommets in back panels can be eliminated upon request at no upcharge. Oval grommets are not offered in kneespace credenzas, open corner credenzas, modular pedestals, and pedestals under 18"w.

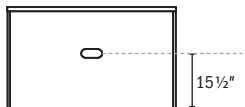
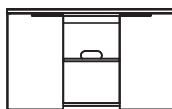
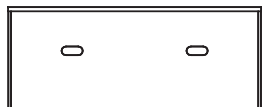
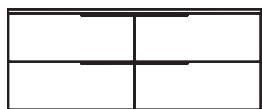
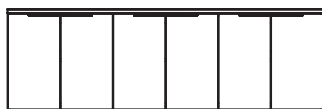

2 Grommets

Credenzas 60"w or greater with multiple storage compartments or drawer stacks have 2 grommets

1 Grommet

Credenzas under 60"w have 1 grommet

Flux Product Details

Credenza Options

Modesty Panel

A modesty panel can be added as an option to Kneespace and Open Corner Credenzas. A partial modesty panel, full modesty panel or removable modesty panel are available.

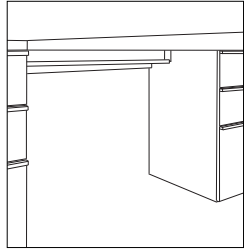

Standard without modesty panel

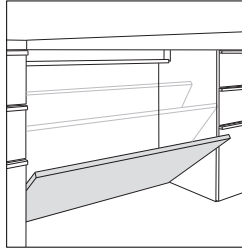

Removable modesty panel

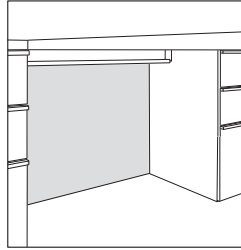

Fixed full height modesty panel

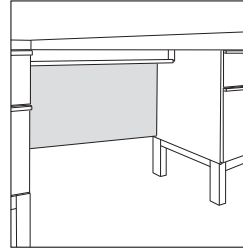

Fixed full height modesty panel with legs

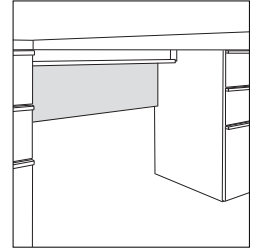

Fixed partial modesty panel

Concealed Drawers

Concealed drawers are available on credenzas with box/lateral file drawer configurations. This offers one continuous front.

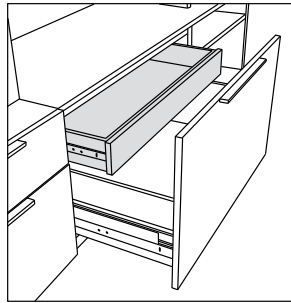

Trash Cans

Primary height credenzas with 18" wide hinge door storage can be outfitted with a trash can.

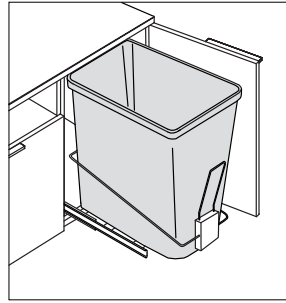

Seat Cushions

Seat Cushions are available in Rectangle, Oval, Square and Round and can be ordered separately for use on secondary credenzas.

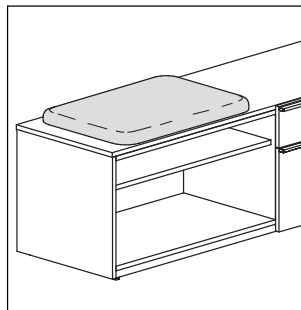

Rectangle seat cushion

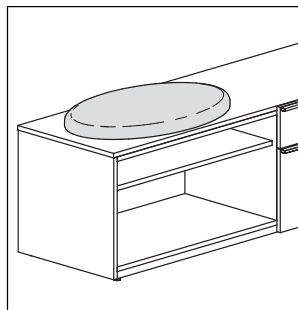

Oval seat cushion

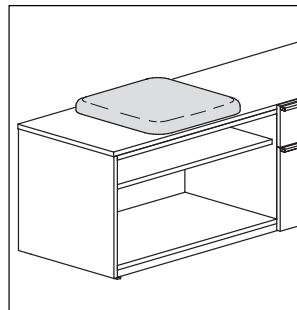

Square seat cushion

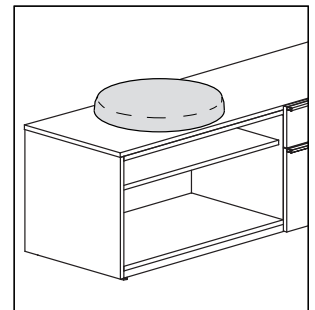

Round seat cushion

Flux General Options

Credenza Interior Compartment Heights

Primary height credenzas (29 1/4" h)

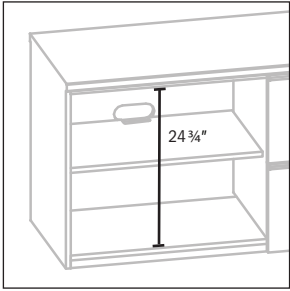

29F side compartment

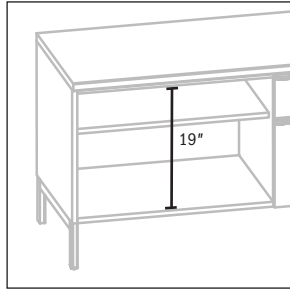

29L & 29S side compartment

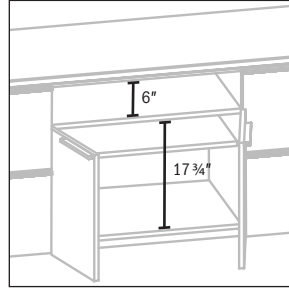

29F middle compartments

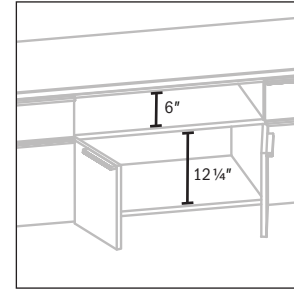

29L & 29S middle compartments

Secondary height credenzas (21 1/4" h)

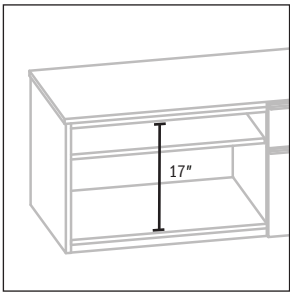

21F side compartment

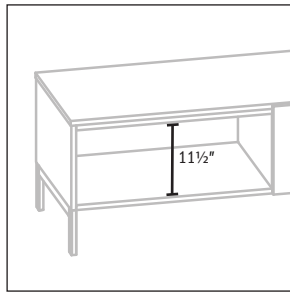

21L & 21S side compartment

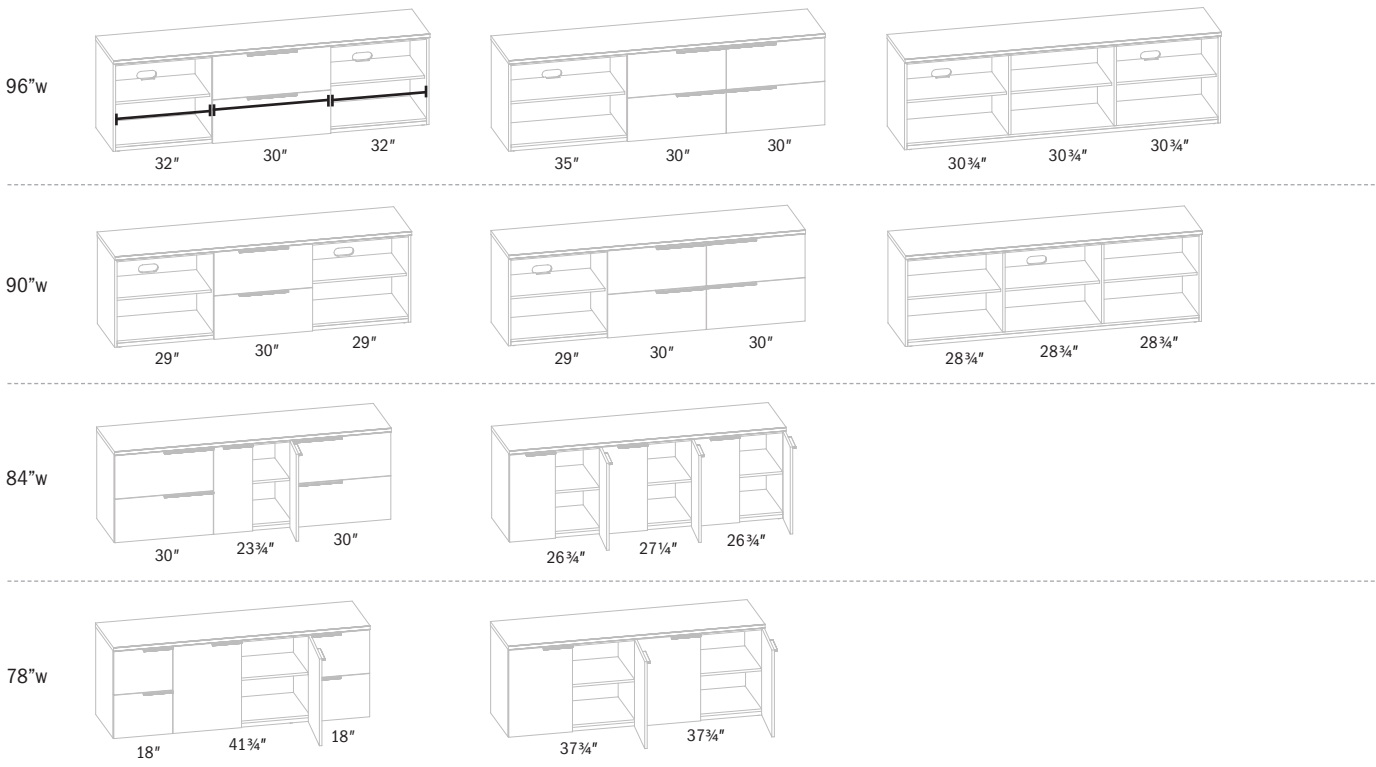

Credenza Interior Compartment Widths



PRODUCT INFORMATION

Flux General Options

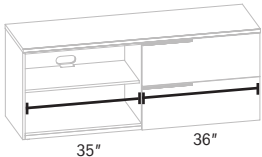
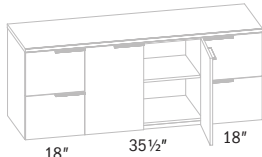
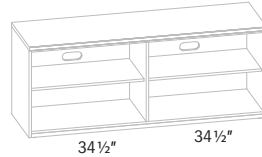
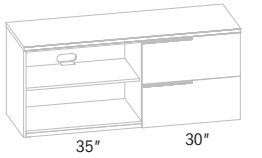
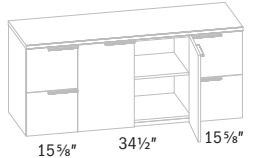
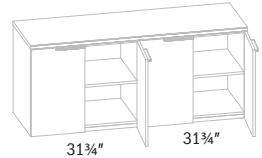
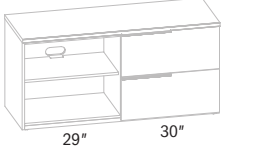
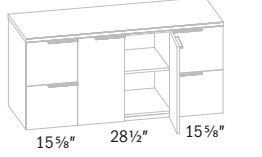
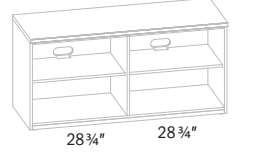
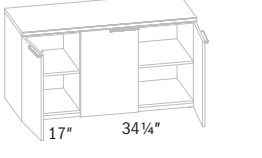
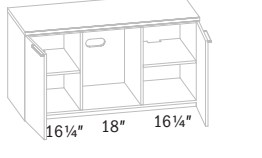
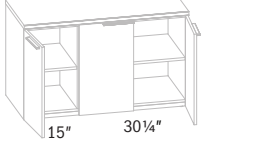
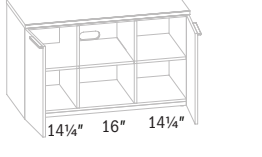
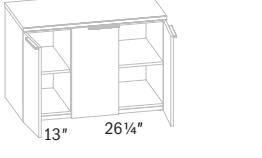
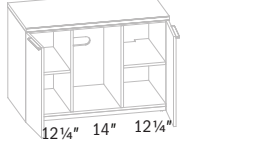
Credenza Interior Compartment Widths (continued)

72"w			
66"w			
60"w			
54"w			
48"w			
42"w			
36"w			
30"w			

Credenza Interior Depths
 Standard shelf depth = 18"
 Interior cabinet depth = 20 1/4"

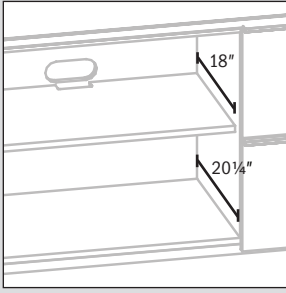

PRODUCT INFORMATION

All dimensions are rounded down to the nearest quarter inch. Call Customer Service if exact dimensions are needed.

Flux Product Details

Overhead Cabinets, Wall Mount Overheads and Wall Panel Stack-ups

Product Overview

Flux overhead cabinets, wall mount overheads and wall panels, when combined with lower storage, create an overall height of 69 ¼" or 81 ¼". Overhead cabinets are available in three heights: 40", 48" or 52". Wall mount overheads are available in two heights: 17" or 29" (add ¼" to overall height for self-pull). Wall panels are available in four heights to accommodate various combinations of use to create the overall height of 69 ¼" or 81 ¼". Wall panels include laminate, veneer, tackboard, markerboard, magnetic glass, and workwall panels.

PRODUCT INFORMATION

Overhead Cabinets (side view)

Wall Mount Overheads (side view)

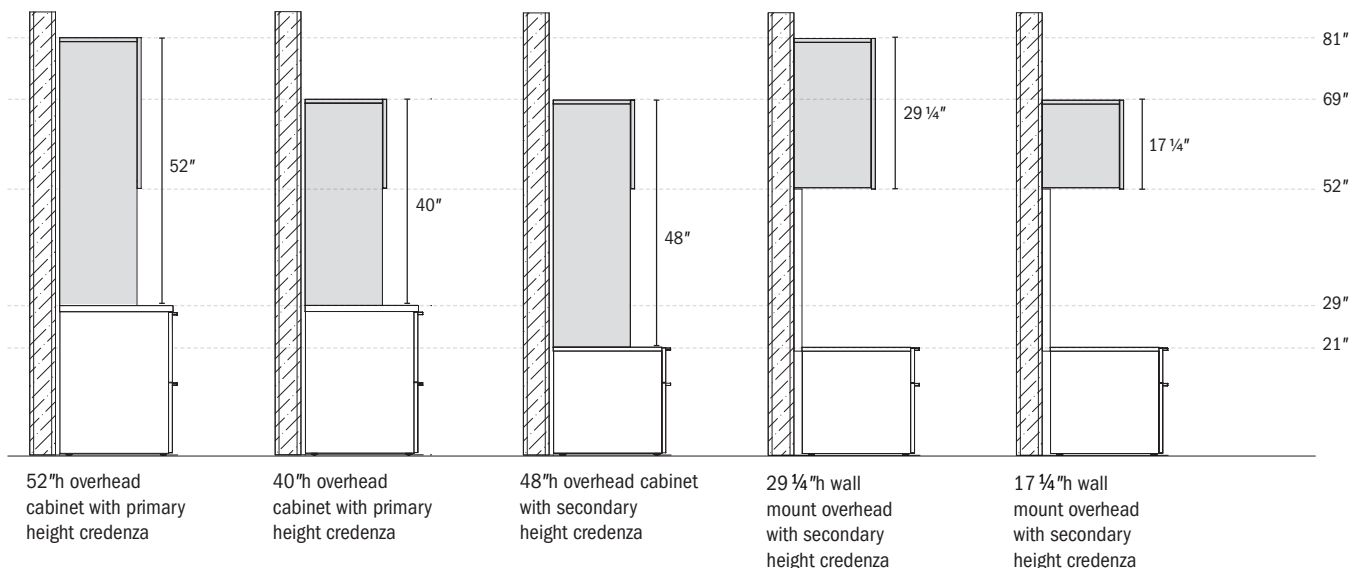

Wall Panels (side view)

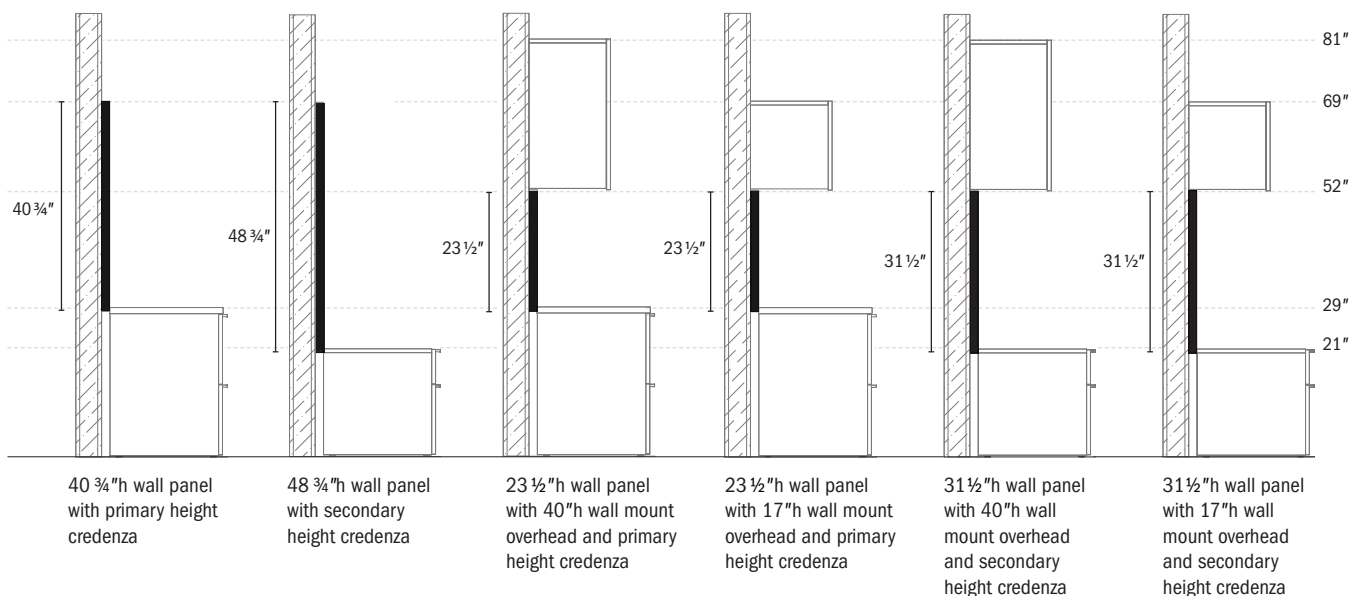

Flux Product Details

Wall Panel Installation

Proper installation when using wall panels will result in proper alignment.

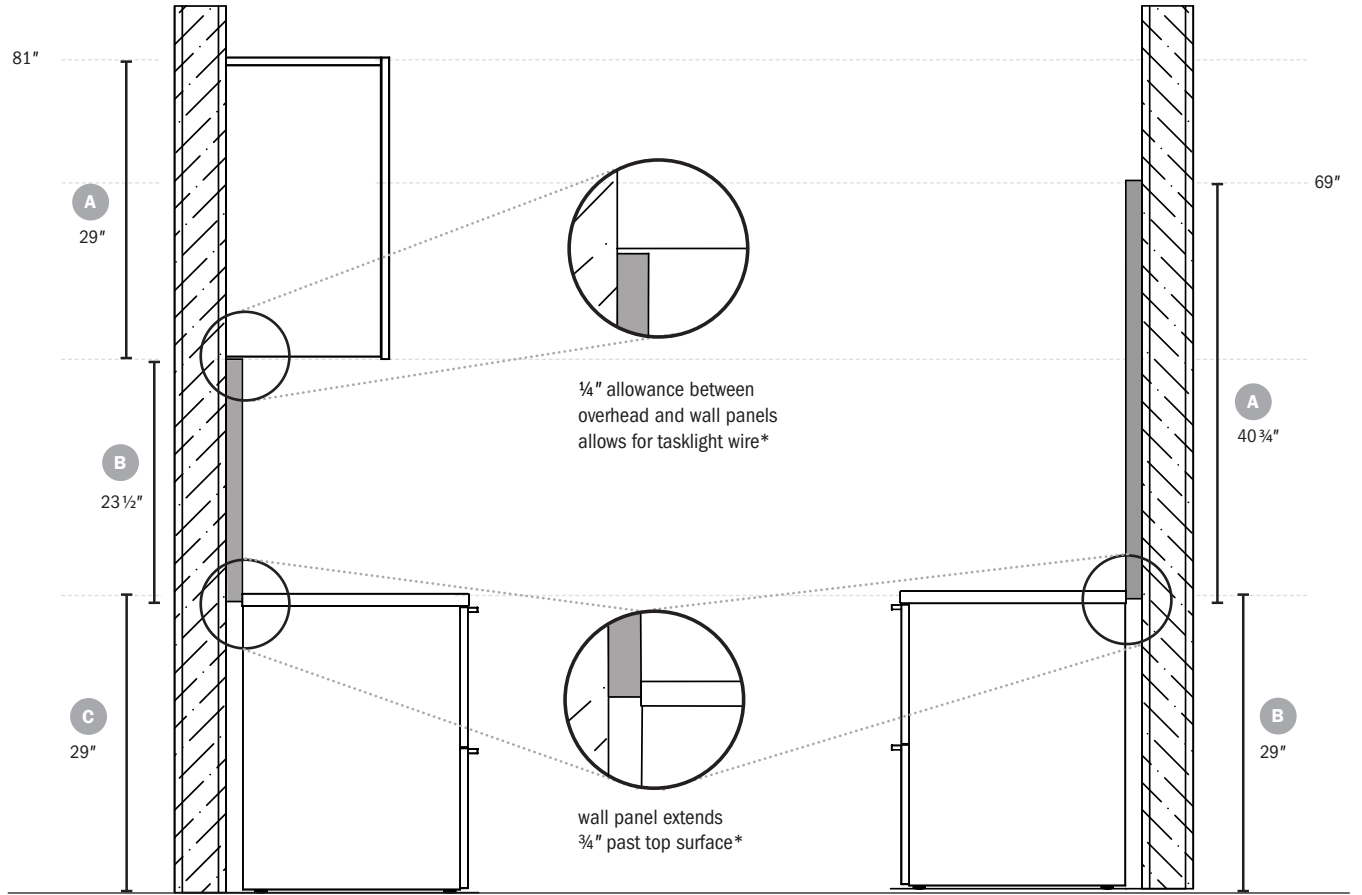

PRODUCT INFORMATION

	Height	Notes
A	29.00" wall side	29.25" overall with extended door for self pull
B	23.50" overall	0.75" of panel extends past the credenza
C	29.00" overall	
	81.50"	
	+ .25" between overhead and wall panel	
	- .75" extended panel	
	81.00" finished height	

	Height	Notes
	40.75" overall	0.75" of panel extends past the credenza
	29.00" overall	
	69.75"	
	- .75" extended panel	
	69.00" finished height	

*For correct alignment with other Flux components, these allowances must be factored into mounting of the overheads and wall panels during installation (instructions included).

Flux Product Details

40" Overhead Stack-up Options (with Primary Height Credenza)

A 40" overhead may be composed of: **A** storage cabinets/towers, **B** wall mount overheads paired with wall panels or **C** tall wall panels, creating an overall unit height of 69" when added to a primary height credenza.

PRODUCT INFORMATION

A

40"

Open Storage Cabinet

Sliding Door Cabinet

Hinged Door Storage Tower

Sliding Door Storage Tower

Side Wardrobe with Open Shelf

See pages 314-323 and 396-399 for additional storage cabinet and tower options.

B

17 1/4"
23 1/2"

Open Storage

Sliding Door

Shelf

Cubby

Panel with Accessory File Shelf

Panel with Mini Shelf

Wall Panel
(laminite, veneer, tack panel, markerboard or glass)

See pages 321-335 for additional wall mount overhead options.

See pages 340-343 and 352-355 for additional wall mount wall panel options.

C

40 3/4"

Markerboard

Glass Markerboard

Tack Panel

See pages 336-339 for additional wall mount wall panel options.

Flux Product Details

Double Height Overhead Stack-up Options (with Primary and Secondary Credenza)

A 52" overhead may be composed of: **A** double height storage cabinets/towers, or **B** double height wall mount overheads and wall panels, creating an overall unit height of 81" when added to a primary height credenza. A 60" overhead composed of **C** double height wall mount overheads and wall panels can create an overall unit height of 81" when added to a secondary height credenza.

A

52"

Open Storage Cabinet Sliding Door Cabinet Hinged Door Storage Tower Sliding Door Storage Tower Side Wardrobe with Open Shelf

See pages 270-281 and 350-351 for additional double height storage cabinet and tower options.

B

29 1/4"

23 1/2"

Open Storage Sliding Door Shelf

Panel with Accessory File Shelf Panel with Mini Shelf Wall Panel (laminates, veneer, tack panel, markerboard or glass)

See pages 310-321 for additional wall mount overhead options.

See pages 340-343 and 352-355 for additional wall mount overhead options.

C

29 1/4"

31 1/2"

Open Storage Sliding Door Shelf

Panel with Accessory File Shelf Panel with Mini Shelf Wall Panel (laminates, veneer, tack panel, markerboard or glass)

See pages 310-321 for additional wall mount overhead options.

See pages 344-347 and 356-359 for additional wall mount wall panel options.

PRODUCT INFORMATION

Flux Product Details

48" Overhead Stack-up Options (with Secondary Height Credenza)

A 48" overhead may be composed of: **A** storage cabinets/towers, **B** wall mount overheads paired with wall panels or **C** tall wall panels, creating an overall unit height of 69" when added to a secondary height credenza.

PRODUCT INFORMATION

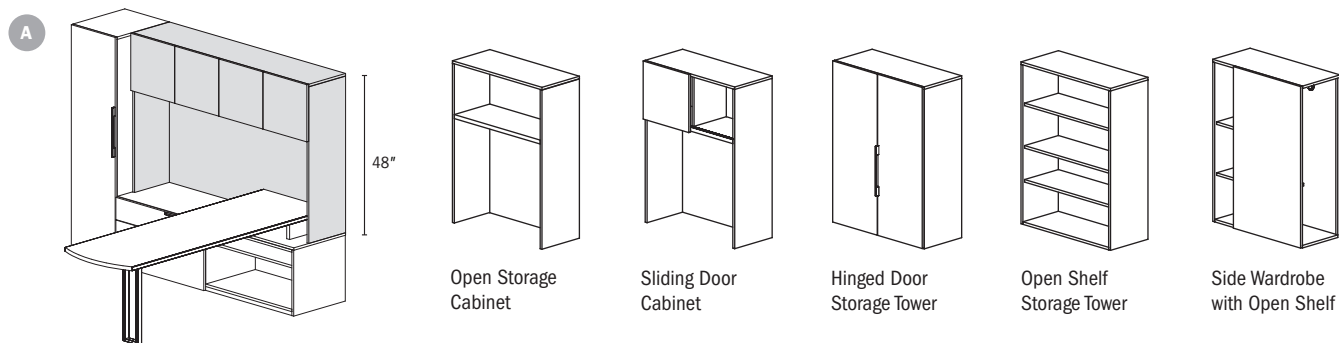

See pages 296-305 and 366-367 for additional storage cabinet and tower options.

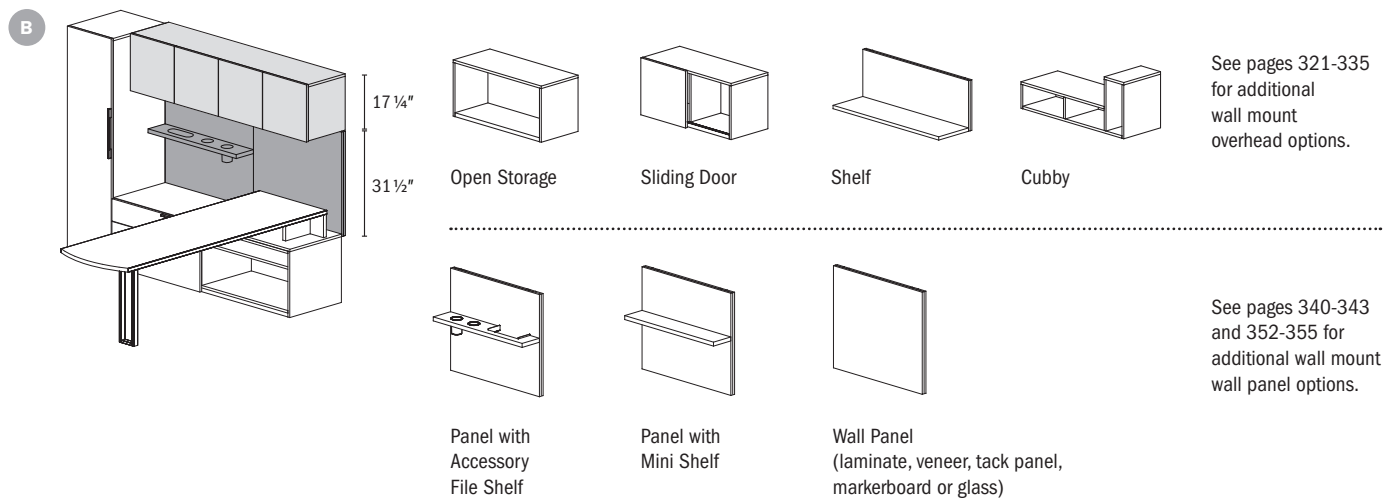

See pages 321-335 for additional wall mount overhead options.

See pages 340-343 and 352-355 for additional wall mount wall panel options.

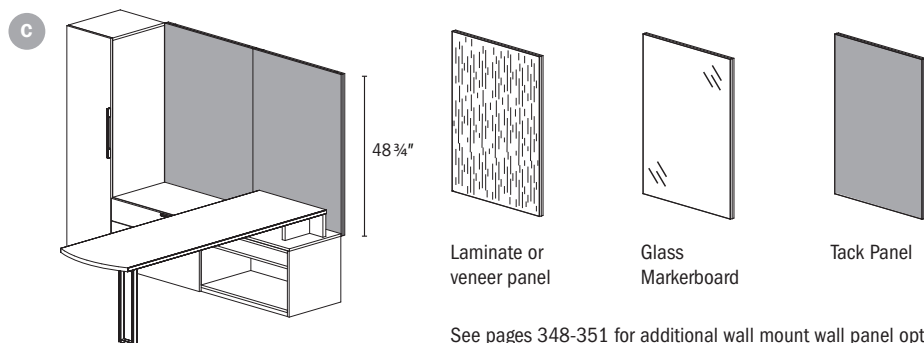

See pages 348-351 for additional wall mount wall panel options.

Flux Product Details

Overhead Options

Overhead Cabinet Doors

Contrasting door fronts, markerboard laminate fronts and white back painted glass fronts are available on overhead doors.

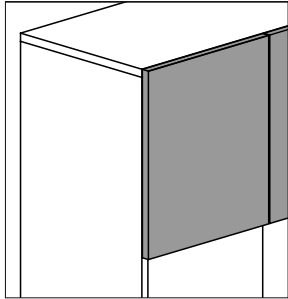

Contrasting laminate door fronts with any JSI standard laminate, or painted veneer fronts in JSI standard painted finishes.

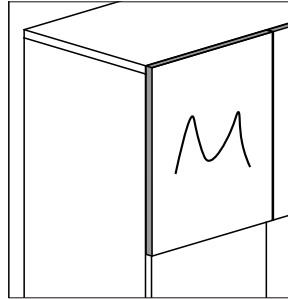

White markerboard laminate with silver vinyl wrapped door edges

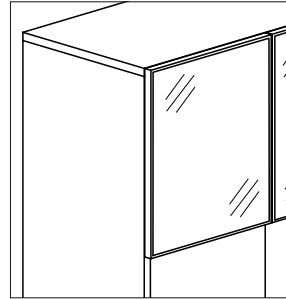

White back painted glass in a thin aluminum frame, with markerboard surface (locking not available on overhead with glass doors)

Overhead Cabinet Panels

Tackboard or laminate markerboard panels are available in overhead cabinets. Specify separately. Panels attach with dual lock fasteners.

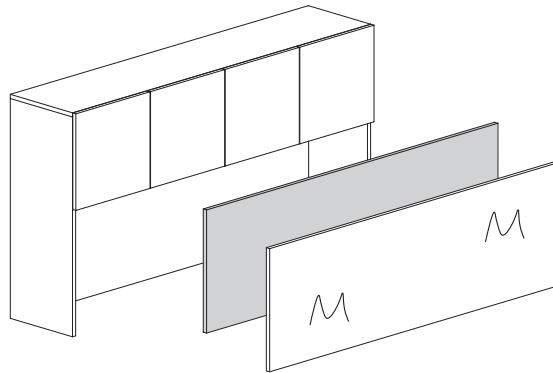

Tasklights

Flux tasklights are available for overhead cabinets. Specify separately. Grommet holes for wire management are $\frac{5}{8}$ " diameter for the LED tasklight. Refer to the chart to the right for the recommended tasklight length according to overhead cabinet width.

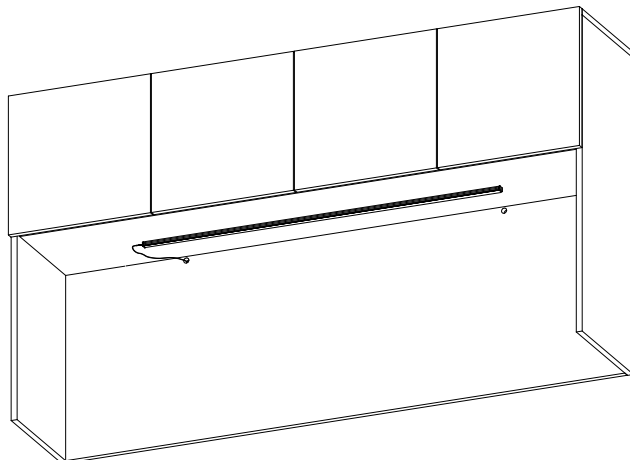

Overhead Width	Tasklight Model Number	Tasklight Length
96"	TL60LEDF	60"
90"	TL60LEDF	60"
84"	TL45LEDF	45"
78"	TL45LEDF	45"
72"	TL45LEDF	45"
66"	TL45LEDF	45"
60"	TL39LEDF	39"
54"	TL27LEDF	27"
48"	TL27LEDF	27"
42"	TL27LEDF	27"
36"	TL27LEDF	27"
30"	TL27LEDF	27"

Flux Product Details

Monitor Cabinets

Monitor cabinets allow a dual purpose layout: personal storage compartment and media compartment are available in various widths (96", 90", 84", 78", 72", 66", and 60") and configurations. Monitor cabinets should be used with primary height credenzas.

PRODUCT INFORMATION

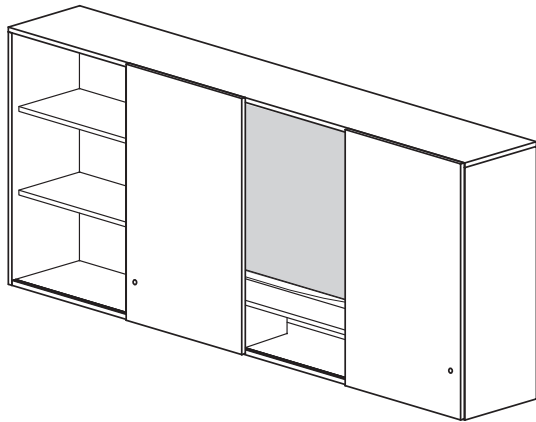

Center Monitor Cabinet

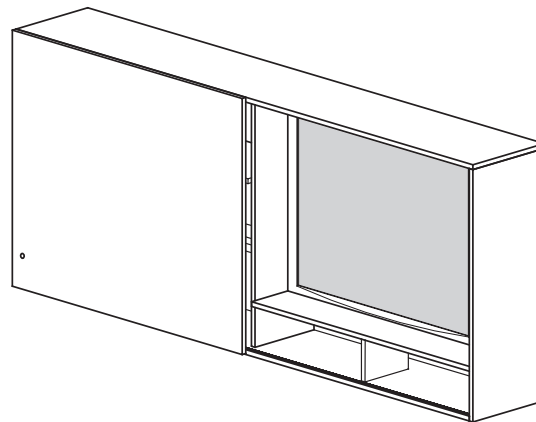

Right Monitor Cabinet

Center Monitor Cabinet Options

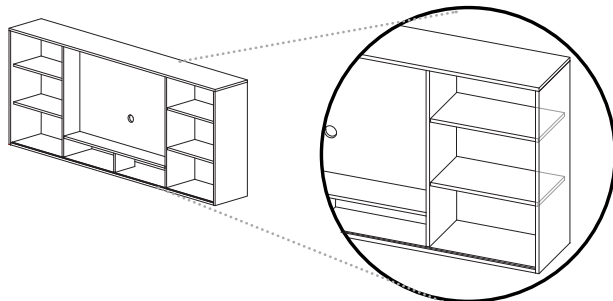

Center monitor with dual side shelf storage

Note: doors removed to show interior configurations

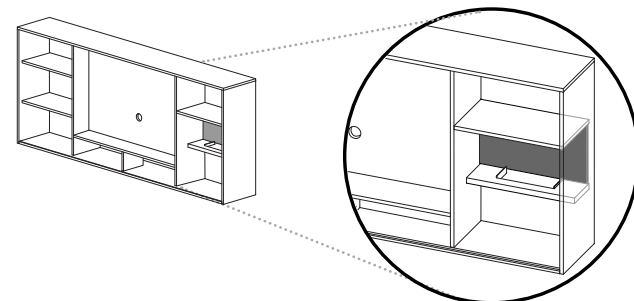

Center monitor with one side shelf storage and other side work-in-process storage (right or left), tackboard above filing shelf

Note: doors removed to show interior configurations

Flux Product Details

Right or Left Monitor Cabinet Options

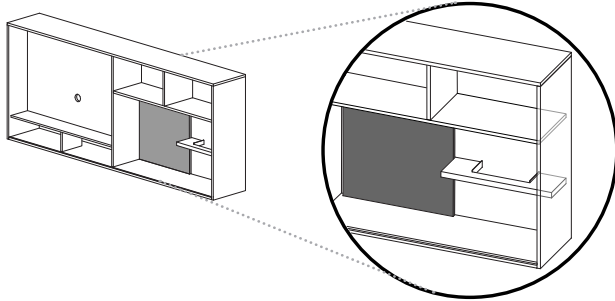

Right or left monitor with side work-in-process storage and side tackboard
Available only on 96", 90", and 84" cabinet widths

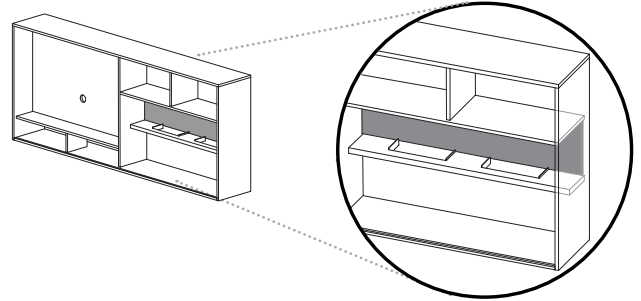

Right or left monitor with work-in-process storage and tackboard above filing shelf

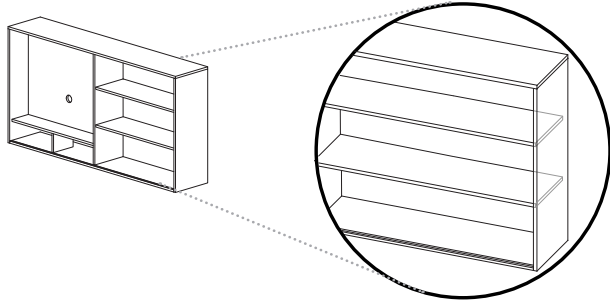

Right or left monitor with side shelf storage
Available only on 78", 72", 66" and 60" cabinet widths

Locking

Locks are standard on all sliding doors on monitor cabinets. Only the personal storage locations lock; monitor sections do not lock.

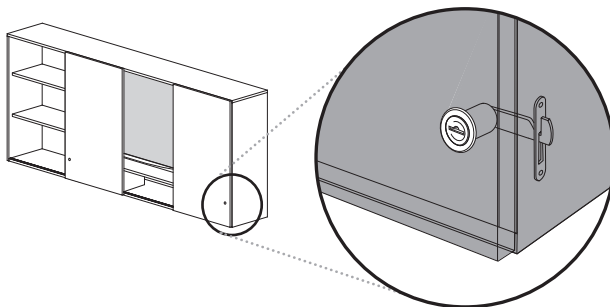

Compartment Sizes

Use the chart below to determine the maximum monitor size allowed.

Cabinet Width	Monitor Section Interior Width	Maximum Monitor Size
95 7/8"	48"	45"w x 29"h
89 7/8"	45"	42"w x 29"h
83 7/8"	42"	39"w x 29"h
77 7/8"	39"	36"w x 29"h
71 7/8"	36"	33"w x 29"h
65 7/8"	33"	30"w x 29"h
59 7/8"	30"	27"w x 29"h

Flux Product Details

Storage Cabinets and Wardrobes

Flux offers a large range of storage cabinets to align with primary height credenzas (18", 24", 30" and 36" widths; with 81 1/4" and 69 1/4" heights).

PRODUCT INFORMATION



Flux offers a large range of storage cabinets to align with secondary height credenzas (18", 24", 30" and 36" widths; with 81 1/4" and 69 1/4" heights).

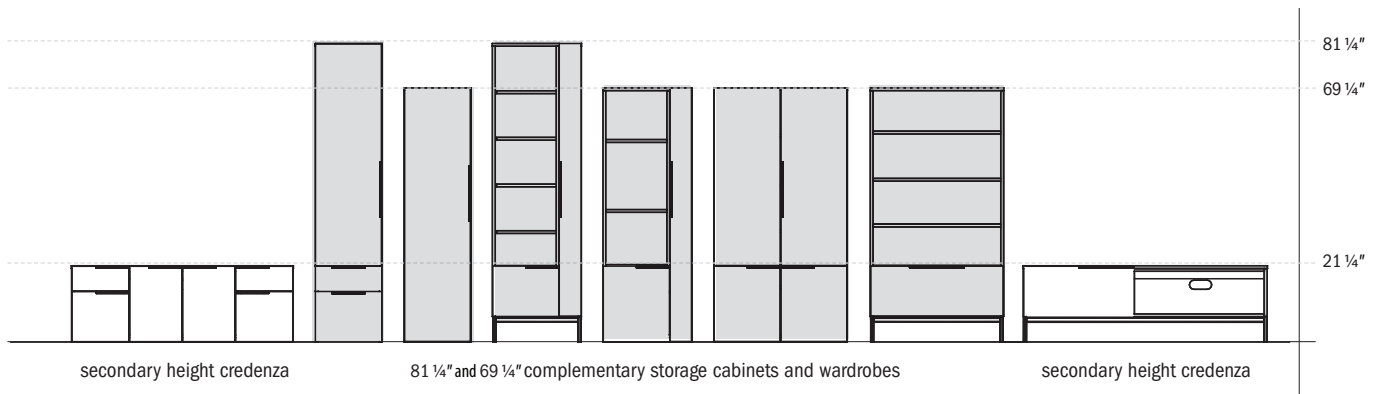

Fixed Shelf

All wardrobe cabinets with doors have a fixed shelf. All other shelves are adjustable.

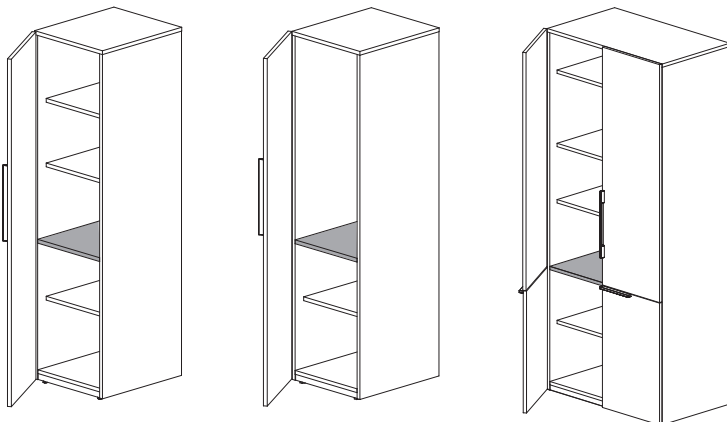

Flux Product Details

Vertical Storage Interior Dimensions

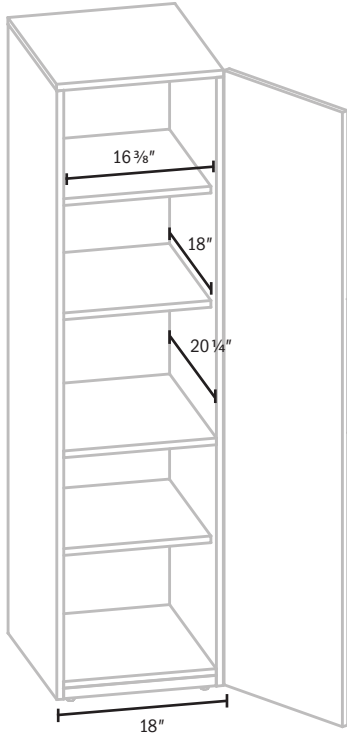

18" w full door storage cabinet

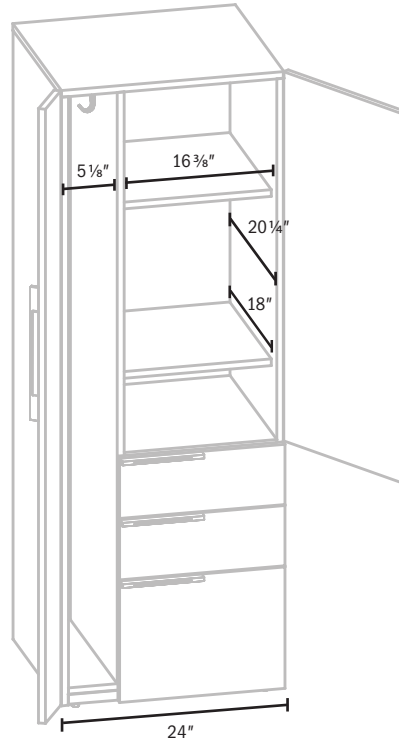

24" w side wardrobe with upper storage compartment

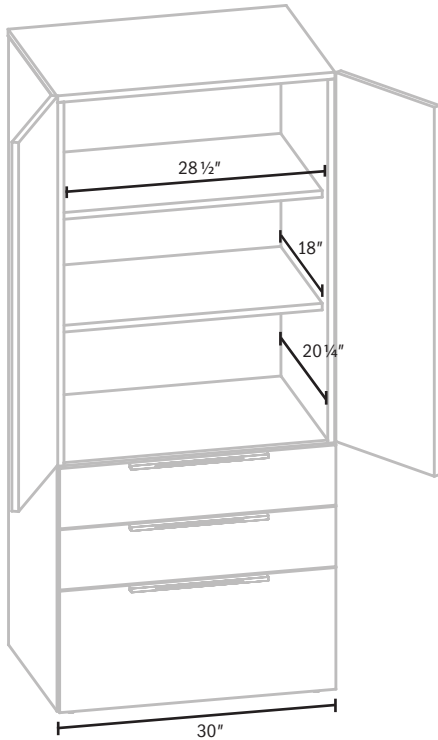

30" w upper storage compartment cabinet

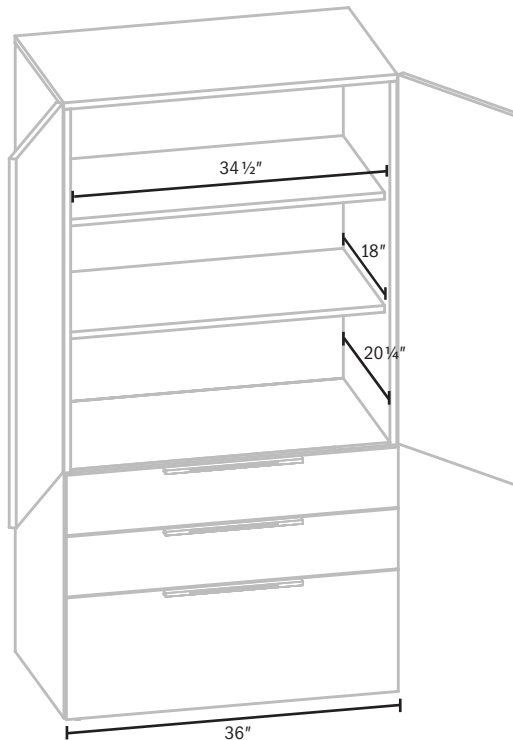

36" w upper storage compartment cabinet

Flux Product Details

Storage Cabinet and Wardrobe Options

Pantry Drawer

A pantry pull out drawer is a standard offering in storage cabinets and wardrobes without legs. Drawers are equipped with a support caster on the front underside of the drawer.

PRODUCT INFORMATION

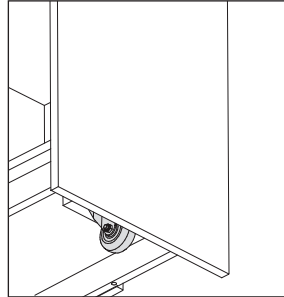
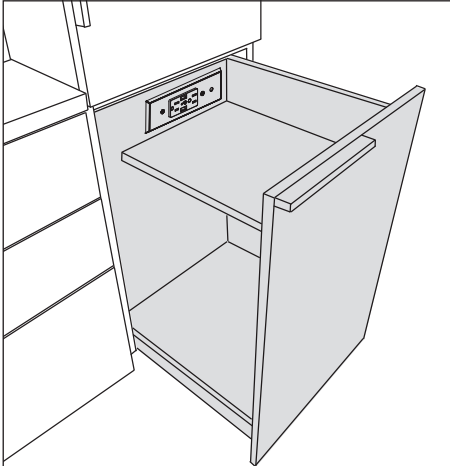

Underside of pantry pull out drawer highlighting support caster.

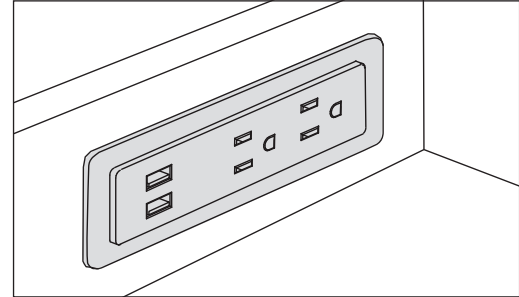

Optional electrical is available in the inside drawer and must be specified. Includes 2 grounded duplex and 2 USB charging outlets. Specify color.

Trash Cans

Storage Cabinets that work with primary height credenzas without legs, with lower hinge door storage, can be outfitted with a pull out trash can. Trash can is included.

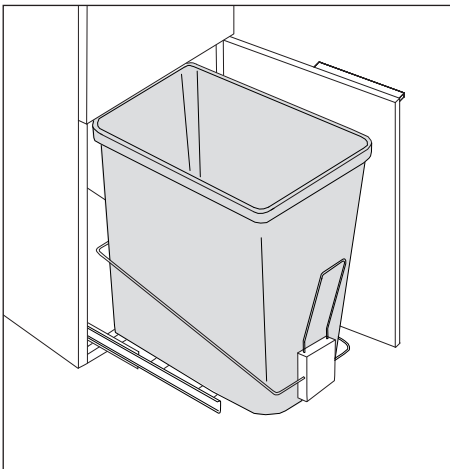

Flux Product Details

Modular Components

Modular items can be created by **(1)** adding tops to modular units or **(2)** using a credenza shell with a modular credenza shell pedestal. Hardware is included.

(1) Modular Top Construction

Example 1.1 - Open Corner Credenza

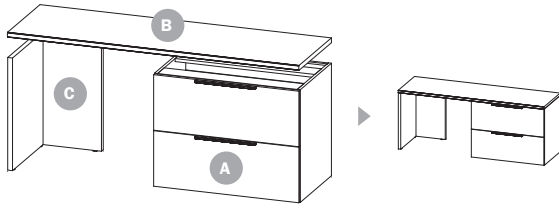

- A** = 36" w x 22" d modular lateral file
- B** = 72" w x 22" d modular primary height credenza top
- C** = 18" w x 22" d modular credenza wing end (left)
(Open spans over 48" require special consideration, consult with Customer Service)

Example 2.1 - Kneespace Credenza

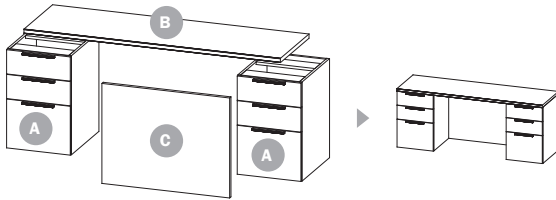

- A** = (qty 2) 18" w x 22" d modular pedestal
- B** = 72" w x 22" d modular primary height credenza top
- C** = 28" h x 36" w modular credenza modesty panel
(Open spans over 48" require special consideration, consult with Customer Service)

Example 3.1 - Storage Credenza

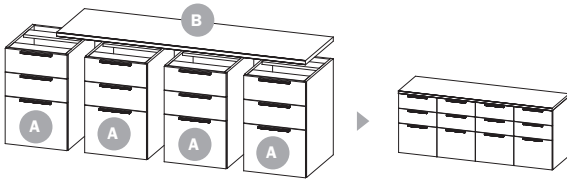

- A** = (qty 4) 18" w x 22" d modular pedestal
- B** = 72" w x 22" d modular primary height credenza top

Example 4.1 - Secondary Height Credenza

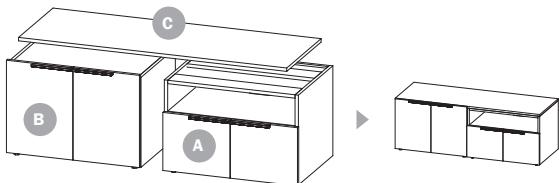

- A** = 30" w x 22" d modular hinged door storage with open shelf
- B** = 30" w x 22" d modular hinged door storage
- C** = 60" w x 21" d modular secondary height credenza top

(2) Credenza Shell Construction

Example 1.2 - Open Corner Credenza

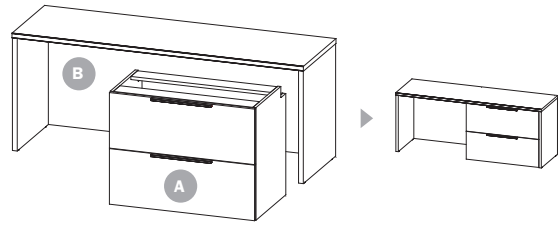

- A** = 36" w x 21" d modular credenza shell lateral file
- B** = 72" w x 22" d credenza shell
(Requires attachment to back of credenza and to underside of top)

Example 2.2 - Kneespace Credenza

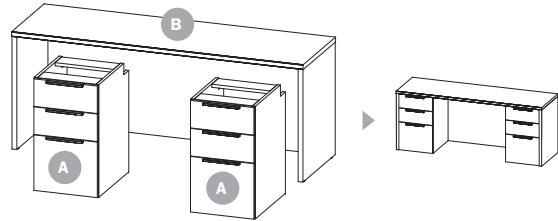

- A** = (qty 2) 18" w x 21" d modular credenza shell pedestal
- B** = 72" w x 22" d credenza shell
(Requires attachment to back of credenza and to underside of top)

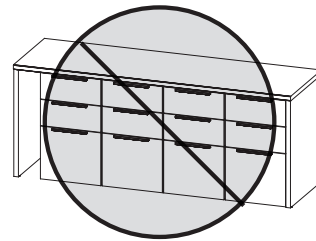

There is no combination of modular components that will allow a credenza shell to be filled between end panels; kneespace or open corner is required.

Flux Technology

Power Access and Wire Management Breakfront Pedestal Desk U Unit

PRODUCT INFORMATION

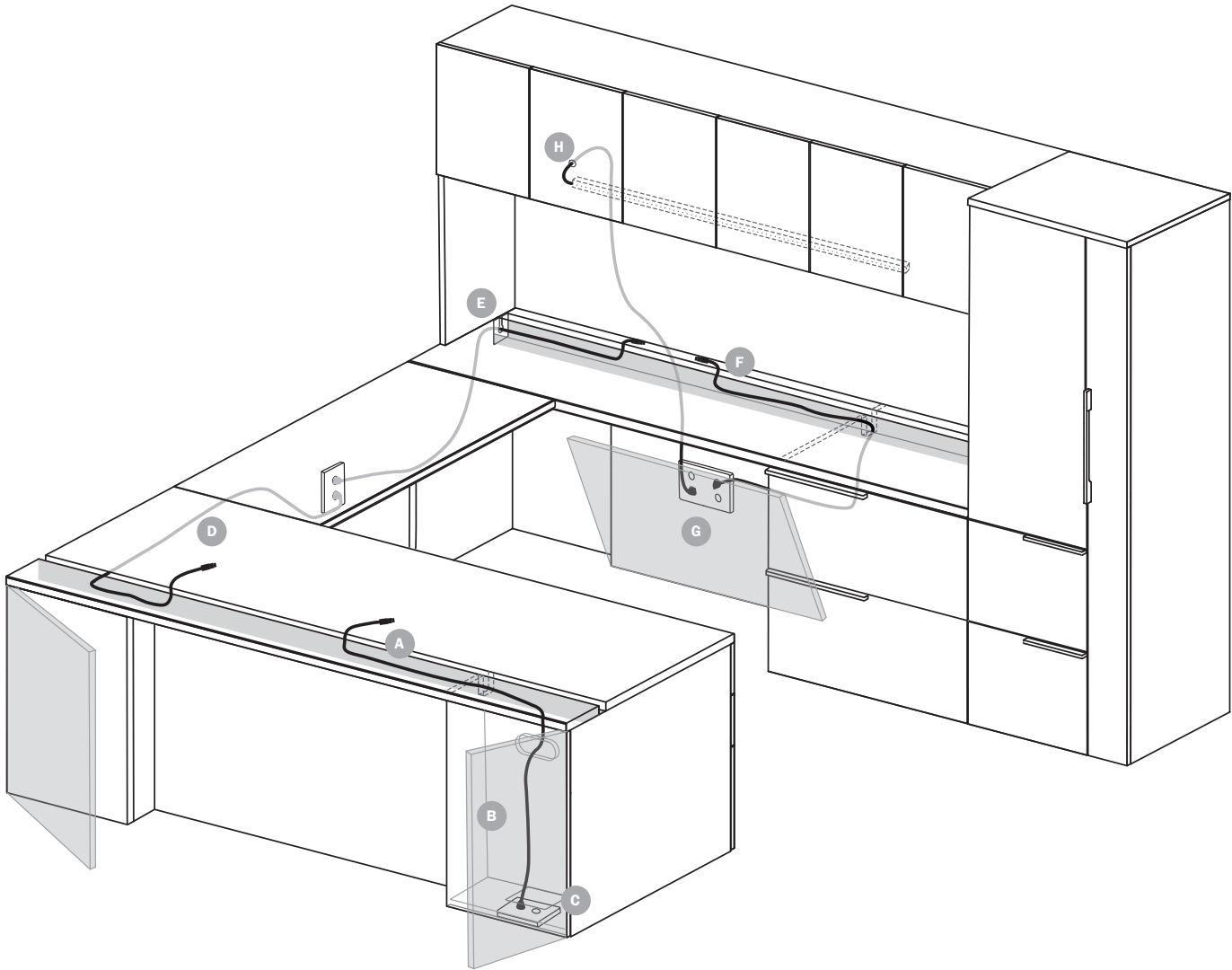

Wiring Paths

- A** = Split top allows wires to fall off at any location on the desk top
- B** = Pedestal access doors allow access to wiring or power supply
- C** = Hole in cabinet bottom allows for floor monument access
- D** = Wiring can be routed through the desk, under bridge and back to the credenza
- E** = End panel grommet in credenza allows wiring to exit the layout
- F** = Split top allows wires to fall off at any location on the credenza top
- G** = Optional removable modesty panel allows for access to wall electrical outlet
- H** = $\frac{5}{8}$ " holes in back panel allow TL-LED tasklight wires to be routed down the exterior of overhead back

Flux Technology

Power Access and Wire Management Peninsula Desk with Secondary Storage

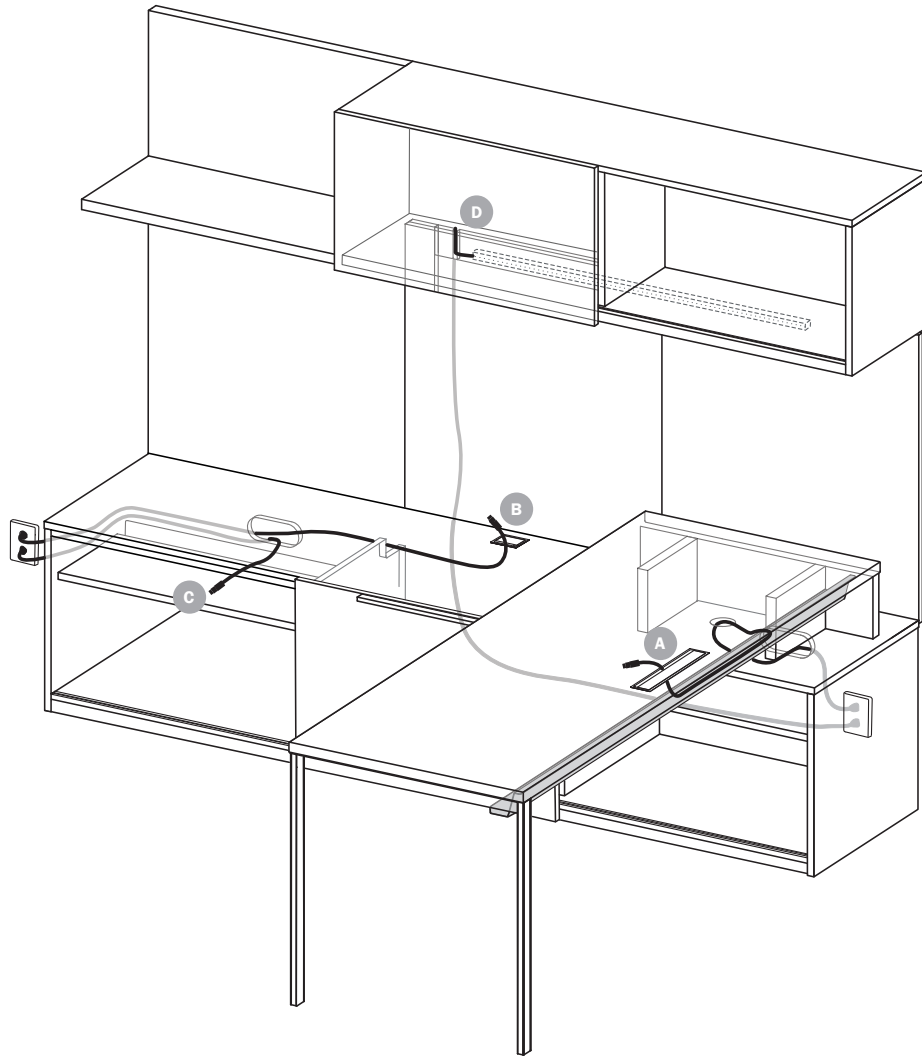

Adjustable Height Peninsula Desk with Secondary Storage

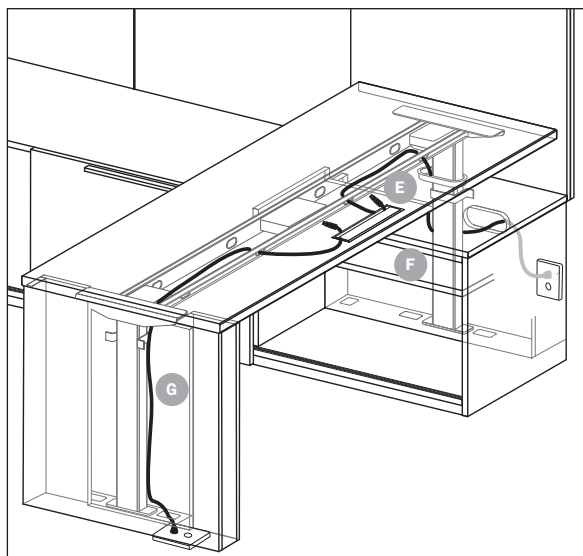

Wiring Paths

- A** = Optional 12" grommet allows wiring to run into optional wire channel, through the standard top credenza grommet and out the back panel's oval grommet
- B** = Optional 3" grommet allows wiring to enter the credenza compartment, move through the notched inside panels and out the back panel's oval grommet
- C** = Wiring for equipment can exit out the oval back grommet
- D** = Tasklight wiring can exit back side of the wall panels
- E** = Optional 12" grommet allows wiring to run into the adjustable height support rails then to a standard flexible wire manager into the lift mechanism compartment and out the back panel's oval grommet
- F** = Snap-on panel allows access to the lift mechanism compartment for access to the back oval grommet
- G** = Snap-on panel on the inside peninsula desk end allows access to the interior of the lift mechanism compartment to route wiring to floor monuments

Flux Technology

Grommets and Worksurface Power

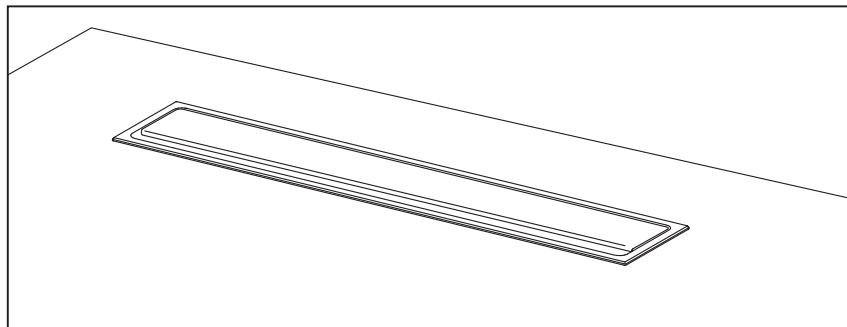
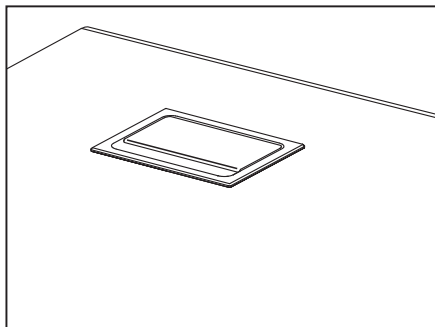

Optional Grommets

Flux offers two sizes of optional grommets: 3" (2½") and 12" (11½") grommets, available in arctic silver, soft nickel, matte black or pewter. Grommet locations are predetermined with a code; see the grommet and electrical locations in this section.

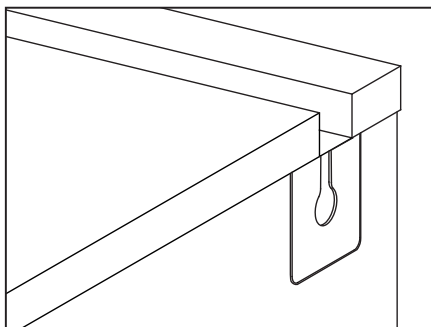
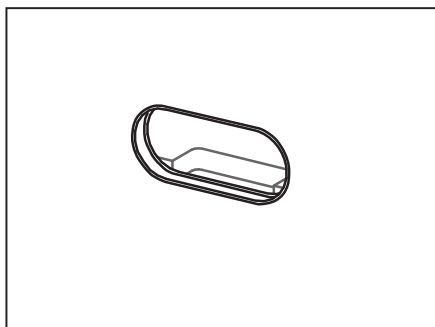

Oval Grommets

Oval grommets with a black trim ring are standard on the back of credenzas. See page 44 for actual location rules for the credenzas. These grommets can be eliminated at no charge. Must specify at the time of order entry.

Side Grommets

Magnetic side grommets are standard on credenza with split tops, and include an interior wire channel.

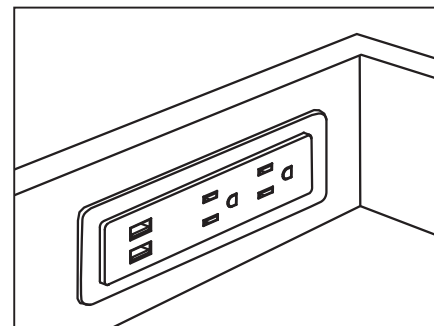
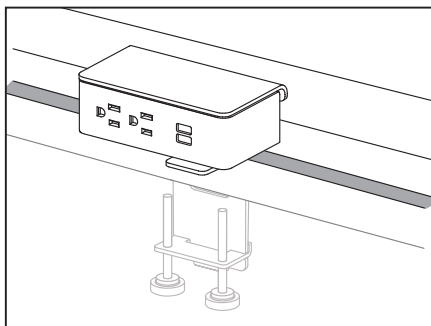
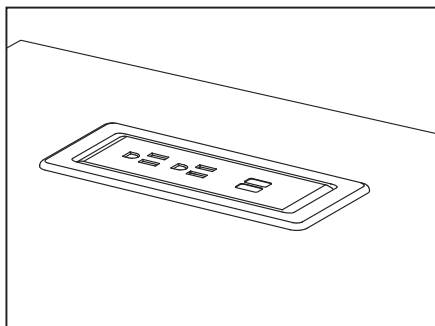

Optional EC26 Power Unit

Optional EC26 power unit can be located on tops, available in black or white; two AC 15 Amp 120 volt power outlets, one 2.4A reversible USB-A charging port & one 60 watt USB-C power delivery port. Locations are predetermined with a code; see the grommet and electrical locations in this section.

Optional EC28 Power Unit

Optional EC28 power unit can be clamped on desk or credenza with split tops, available in black or white; two AC 15 Amp 120 volt power outlets, one 2.4A reversible USB-A charging port & one 60 watt USB-C power delivery port; 10 ft. cord.

Optional EC26 Pantry Power Unit

Optional EC26 power unit can be specified in the pantry drawer, available in black or white; two AC 15 Amp 120 volt power outlets, one 2.4A reversible USB-A charging port & one 60 watt USB-C power delivery port.

Flux Technology

Dimensional Location of Grommets

The grommet locations below show standard dimensions for most products. If exact dimensional information is needed, contact Customer Service.

Desk (top view)

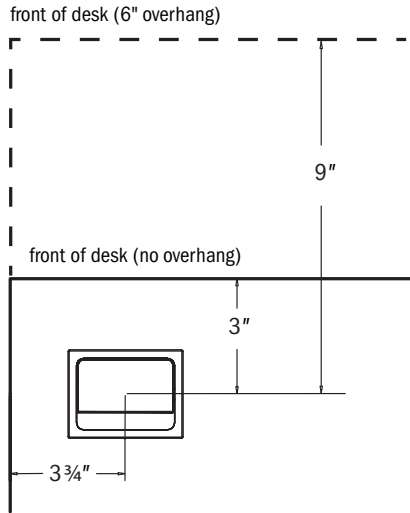

Grommet dimensions
 A and C positions on desk

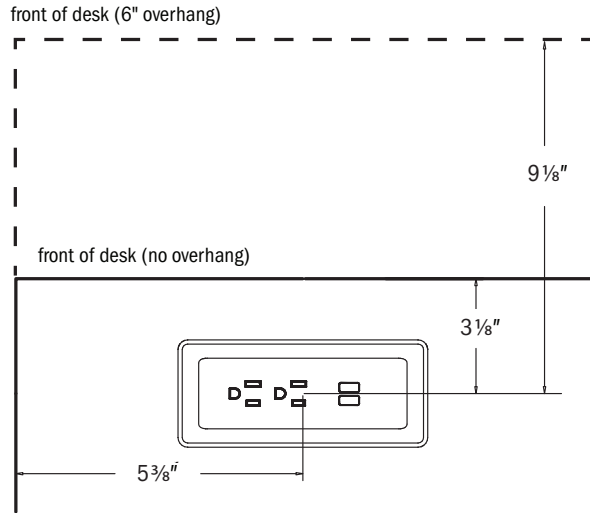

EC26 dimensions
 A and C positions on desk

Grommets or EC26 D position runs parallel to the side of the desk.

PRODUCT INFORMATION

Credenza (top view)

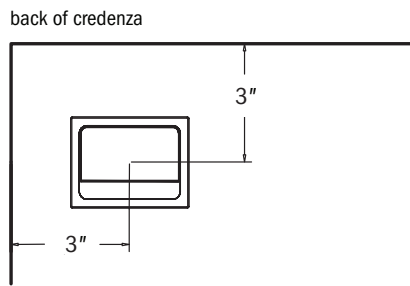

Grommet dimensions
 A and C positions on desk

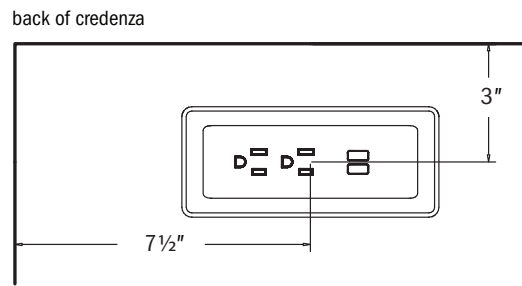

EC26 dimensions
 A and C positions on desk

Flux Technology

Location of Grommets and Worksurface Electrical

Reference the diagrams below to determine the letter code for specifying a desired grommet or power unit location. Available locations apply to all options listed within each category.

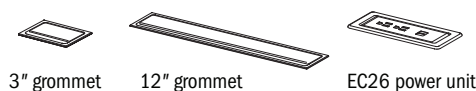

Double Pedestal Desks

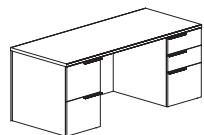

user side shown

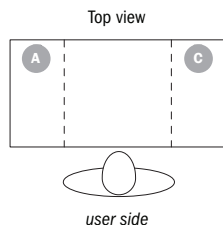

Available options:

- 3" grommet
- EC26 power unit

Available location codes:

- A or C
- Grommets are inset on desks with overhang tops

Single Pedestal Desks

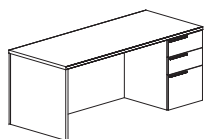

right side, user side shown

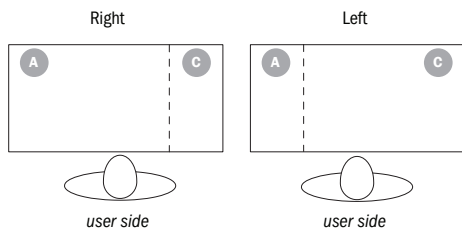

Available options:

- 3" grommet
- EC26 power unit

Available location codes:

- A or C
- Grommets are inset on desks with overhang tops

Peninsula Desks with End Panels

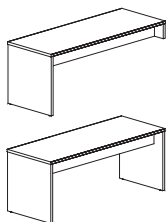

right side, approach view

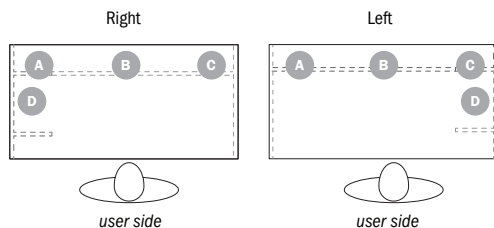

Available options:

- 3" grommet
- 12" grommet
- EC26 power unit

Available location codes:

- A B C or D

Peninsula Desks with End Frames or Post Frames

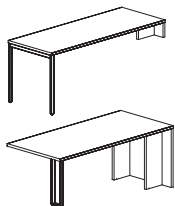

(frame post)

non-handed product - grommets hand units

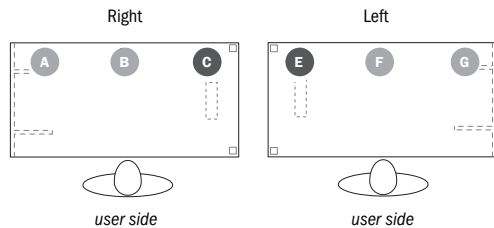

Dark gray locations (C & E) are not available on peninsula desks with frame post

Available options:

- 3" grommet
- 12" grommet
- EC26 power unit

Available location codes:

- A B or C (right)
- E F or G (left)
- Locations apply to rectangular and arc shape tops with end frames

Boomerang Peninsula Desks with End Frames

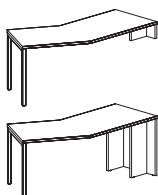

right side, approach view

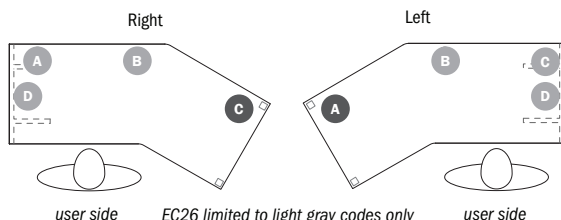

Available options:

- 3" grommet
- 12" grommet
- EC26 power unit (limited to 3 locations)

Available location codes:

- A B C or D
- EC26 power unit may not be located at outer end of bend

Flux Technology

Location of Grommets and Worksurface Electrical (continued)

Available locations apply to all options listed within each category.

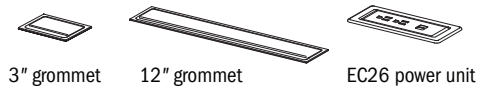

Rectangle Run-off Desks with End Panels

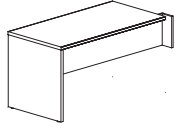

left side, approach view

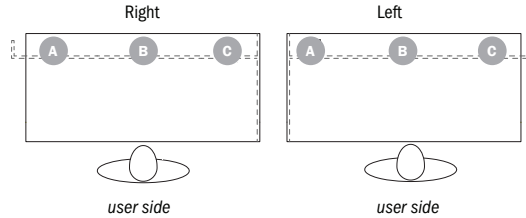

Available options:

- 3" grommet
- 12" grommet
- EC26 power unit

Available location codes:

- A B or C

Run-off Desks with End Frames or Post Frames

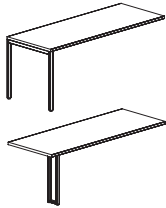

non-handed product – grommets hand units

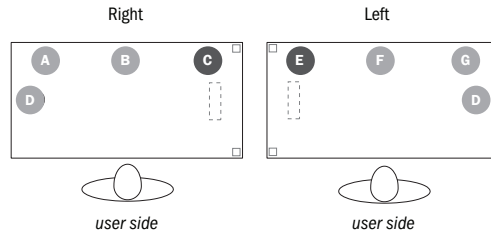

Dark gray locations (C & E) are not available on peninsula desks with frame post

Available options:

- 3" grommet
- 12" grommet
- EC26 power unit

Available location codes:

- A B C or D (right)
- E F G or D (left)
- Locations apply to rectangular and arc shape tops with end frames

Boomerang Run-off Desks with End Frames



right side, approach view

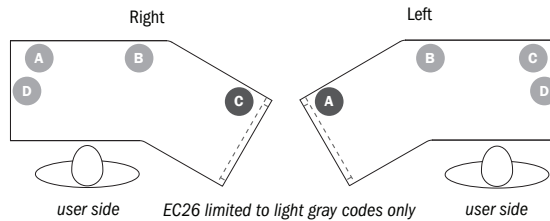

Available options:

- 3" grommet
- 12" grommet
- EC26 power unit (limited to 3 locations)

Available location codes:

- A B C or D
- EC26 power unit may not be located at outer end of bend

Bridge Tops

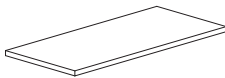

non-handed product

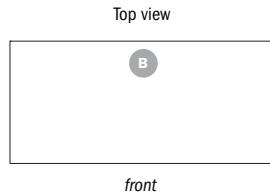

Available options:

- 3" grommet
- EC26 power unit

Available location codes:

- B

Returns

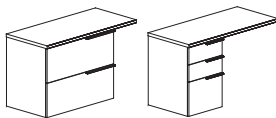

left side, user view

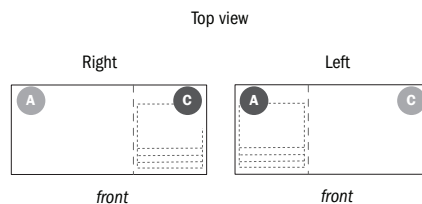

EC26 limited to light gray codes only

Available options:

- 3" grommet
- EC26 power unit (one location only)

Available location codes:

- A or C
- EC26 power unit may not be located above drawers

Flux Technology

Location of Grommets and Worksurface Electrical (continued)

Available locations apply to all credenza widths listed (primary or secondary height). EC26 power units may not be located above drawers.

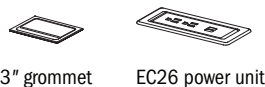

3" grommet

EC26 power unit

Lateral File Credenzas and Lateral File Pedestals

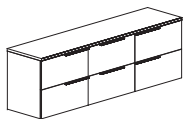

credenza with 3 file compartments, 90" w

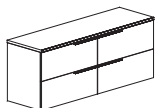
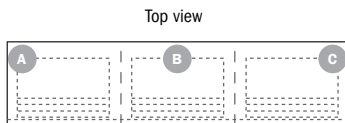

credenza with 2 file compartments, 72" w or 60" w

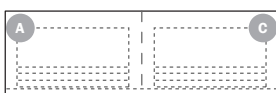

lateral file pedestal, 36" w or 30" w

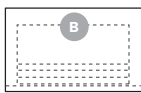

Available option:

- 3" grommet

Available location codes:

- A B or C (3 compartments)
- A or C (2 compartments)
- B (lateral file pedestal)
- Note: Grommets cannot be specified on secondary credenza at same location as the credenza mounts for a peninsula desk. See page 17 for additional information.

Storage Credenzas with Open Center Compartments

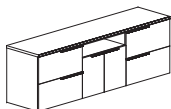

credenza with center storage/open compartment
96" w, 90" w, 84" w, 78" w, 72" w, 66" w or 60" w

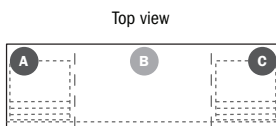

EC26 limited to center location B only

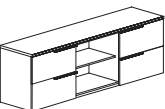

credenza with open center compartment
96" w or 90" w



Available options:

- 3" grommet
- EC26 power unit (one location only)

Available location codes:

- A B or C
- EC26 power unit may not be located above drawers; limited to center location B only
- Note: Grommets or EC26 power units cannot be specified on secondary credenza at same location as the credenza mounts for a peninsula desk. See page 17 for additional information.

Credenzas with Open, Sliding or Hinge Door Compartments

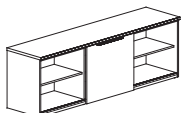

credenza without drawers, 96" w or 90" w

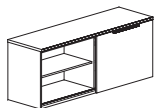
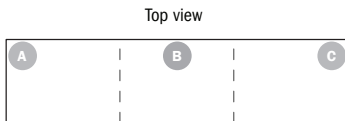

credenza without drawers, 72" w or 60" w

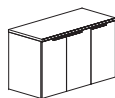

credenza without drawers, 54" w, 48" w or 42" w



storage unit without drawers, 36" w or 30" w



Available options:

- 3" grommet
- EC26 power unit

Available location codes:

- A B or C (3 compartments)
- A or C (2 compartments)
- B (1 compartment)
- Note: Grommets or EC26 power units cannot be specified on secondary credenza at same location as the credenza mounts for a peninsula desk. See page 17 for additional information.

Flux Technology

Location of Grommets and Worksurface Electrical (continued)

Available locations apply to all credenza widths listed (primary or secondary height). EC26 power units may not be located above drawers.

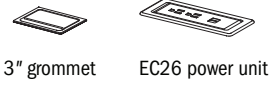

Lateral Storage Credenzas with End Open Compartment(s)

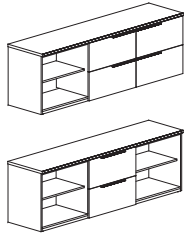

credenza with end open compartment(s)
96"w or 90"w

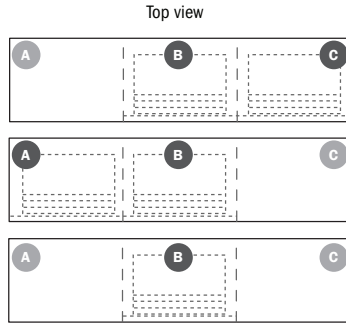

EC26 limited to open compartments only (light gray codes)

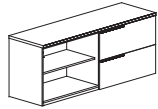

credenza with end open compartment
72"w, 66"w or 60"w

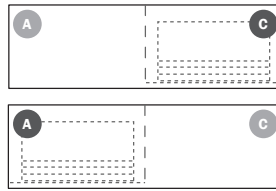

Kneespace Credenzas

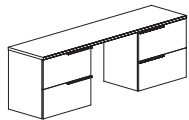

lateral drawer kneespace credenza
96"w or 90"w

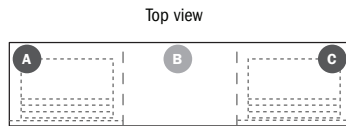

EC26 limited to center location B only

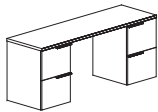

file drawer kneespace credenza
84"w, 78"w, 72"w, 66"w or 60"w



Available options:

- 3" grommet
- EC26 power unit (one location only)

Available location codes:

- A, B or C
- EC26 power unit may not be located above drawers; limited to center location B only

Lateral and File Credenzas

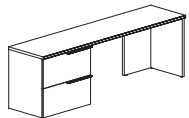

lateral drawer kneespace credenza
96"w, 90"w, 84"w, 78"w or 72"w

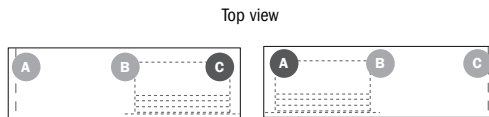

EC26 limited to open compartments only (light gray codes)

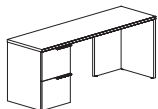

file drawer kneespace credenza
84"w, 78"w, 72"w, 66"w or 60"w

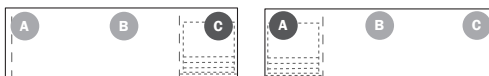

Available options:

- 3" grommet
- EC26 power unit (limited locations)

Available location codes:

- A, B or C
- EC26 power unit may not be located above drawers

Flux Technology

Location of Grommets and Worksurface Electrical (continued)

Available locations apply to all options listed within each category.
EC26 power units may not be located above drawers.

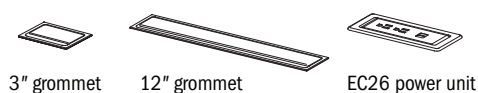

Peninsula Credenzas

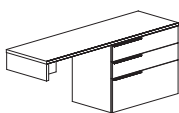

peninsula credenza , user view
96"w, 90"w, 84"w, 78"w or 72"w

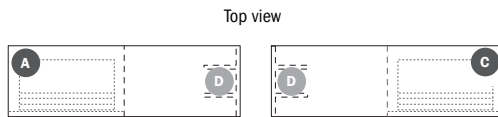

EC26 limited to location **D** only

Available options:

- 3" grommet
- EC26 power unit (one location only)

Available location codes:

- **A**, **C** or **D**
- EC26 power unit may not be located above drawers; limited to center location **D** only

PRODUCT INFORMATION

Credenza Shells and Return Shells

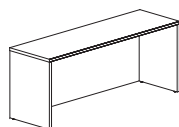

credenza shell and return
72"w or 66"w

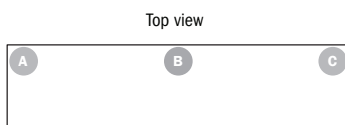

Available option:

- 3" grommet

Available location codes:

- **A**, **B** or **C** (72"w or 66"w units)
- **A** or **C** (units 60"w or less)

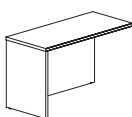

credenza shell and return
60"w, 54"w, 48"w or 42"w

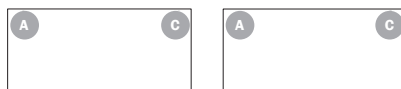

Adjustable Height Credenza Extensions and Return Shells

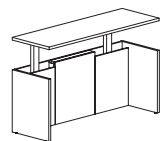

adjustable height credenza extension
72"w, 66"w, 60"w, 54"w or 48"w

Top view



Available option:

- 3" grommet

Available location codes:

- Codes apply only to adjustable height credenza extensions and adjustable height return shells.

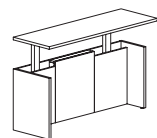

adjustable height return shell
72"w, 66"w, 60"w, 54"w or 48"w

Adjustable Height Credenza

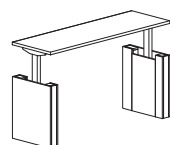

adjustable height credenza
72"w, 66"w, 60"w, 54"w or 48"w

Top view



Available option:

- 3" grommet

Available location codes:

- Codes apply only to adjustable height credenza.

Flux Technology

Location of Grommets and Worksurface Electrical (continued)

Available locations apply to all options listed within each category.



Adjustable Height Table Desks with End Panels

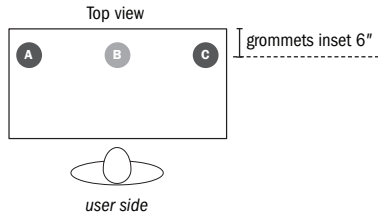
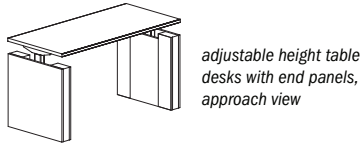

12" grommet limited to location **B** only

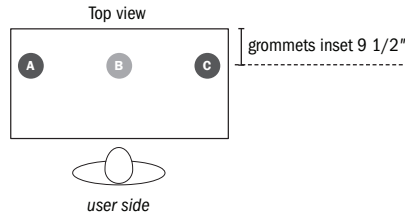
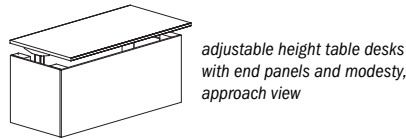

12" grommet limited to location **B** only

Available option:

- 3" grommet
- 12" grommet (one location only)

Available location codes:

- **A**, **B** or **C**
- 12" grommet limited to location **B** only
- Grommets are inset 6" to accommodate desk overhang
- Codes apply only to adjustable height table desks with end panels

Adjustable Height Peninsula Desk

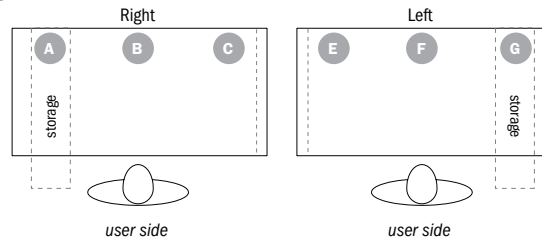
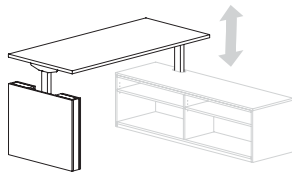

Available option:

- 3" grommet

Available location codes:

- **A**, **B** or **C** (right)
- **E**, **F** or **G** (left)
- Locations apply to rectangular adjustable height peninsula desk

Adjustable Height L Configuration Desks and Returns

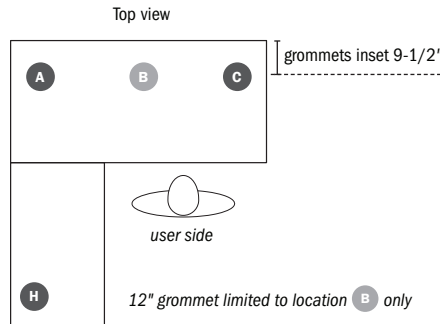
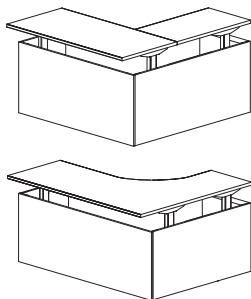

Available option:

- 3" grommet
- 12" grommet (one location only)

Available location codes:

- **A**, **B** or **C** (desk)
- **H** (return)
- 12" grommet limited to location **B** only
- Grommets are inset 6" to accommodate desk overhang

Adjustable Height Table Desks with Center Columns

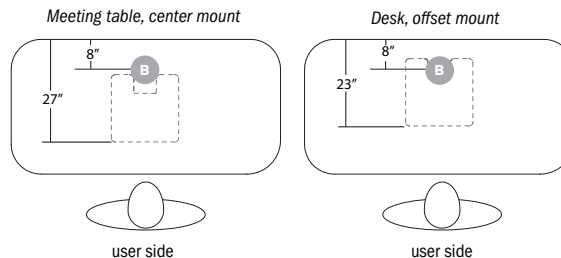
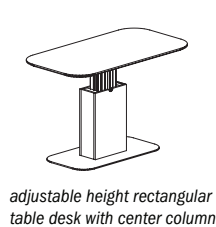

Available option:

- 3" grommet (grommets are off-center)

Available location codes:

- **B**
- Dimensional information for rectangular table desk is for a unit with a 36"d x 72"w top. Base can be mounted for a meeting table or a desk; grommet location remains the same on both mounting locations.

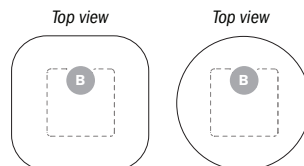
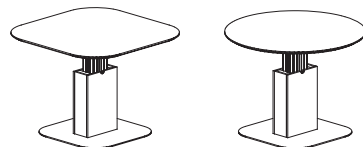

Flux Technology

Metal Wire Manager for Peninsula Desks and Run-off Desks

The wire manager is available in multiple lengths and four finishes: matte black, pewter, arctic silver and soft nickel. Use the charts on the following two pages to determine the appropriate wire manager model number for the selected peninsula or run-off desk.

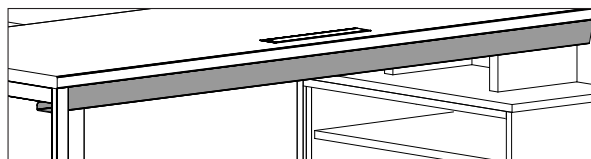

Recommend Size with Peninsula or Run-off Desk

Laminate/Veneer Model Number	Wire Manager Model Number	
	Eased Edge	Knife Edge
FLT/FLV2848ARCTP	FLB0438MWM	FLB0438MWM
FLT/FLV2848RRTN	FLB0444MWM	FLB0444MWM
FLT/FLV2848RRTP	FLB0444MWM	FLB0444MWM
FLT/FLV2848TD	FLB0444MWM	FLB0438MWM
FLT/FLV2854ARCTP	FLB0444MWM	FLB0444MWM
FLT/FLV2854RDEPL/R	FLB0450MWM	NA
FLT/FLV2854RRTN	FLB0450MWM	FLB0450MWM
FLT/FLV2854RRTP	FLB0450MWM	FLB0450MWM
FLT/FLV2854TD	FLB0450MWM	FLB0444MWM
FLT/FLV2860ARCTP	FLB0450MWM	FLB0450MWM
FLT/FLV2860BMTNL/R	FLB0432MWM	FLB0432MWM
FLT/FLV2860RDEPL/R	FLB0456MWM	NA
FLT/FLV2860RRTN	FLB0456MWM	FLB0456MWM
FLT/FLV2860RRTP	FLB0456MWM	FLB0456MWM
FLT/FLV2860TD	FLB0456MWM	FLB0450MWM
FLT/FLV2866ARCTP	FLB0456MWM	FLB0456MWM
FLT/FLV2866BMTNL/R	FLB0432MWM	FLB0432MWM
FLT/FLV2866DTEPL/R	FLB0456MWM	NA
FLT/FLV2866PARCP	FLB0456MWM	FLB0456MWM
FLT/FLV2866PARCPEP	FLB0456MWM	NA
FLT/FLV2866PBMNEPL/R	FLB0432MWM	NA
FLT/FLV2866PBMNL/R	FLB0432MWM	FLB0432MWM
FLT/FLV2866PDEPL	FLB0462MWM	NA
FLT/FLV2866PDEPPL/R	FLB0462MWM	NA
FLT/FLV2866PDEPR	FLB0462MWM	NA
FLT/FLV2866PDN	FLB0462MWM	FLB0456MWM
FLT/FLV2866PDNEP	FLB0462MWM	NA
FLT/FLV2866PDP	FLB0462MWM	FLB0456MWM
FLT/FLV2866PDPEP	FLB0462MWM	NA
FLT/FLV2866PDTEPL/R	FLB0456MWM	NA
FLT/FLV2866RDEPL/R	FLB0462MWM	NA
FLT/FLV2866RRTN	FLB0462MWM	FLB0462MWM
FLT/FLV2866RRTP	FLB0462MWM	FLB0462MWM
FLT/FLV2866TD	FLB0462MWM	FLB0456MWM
FLT/FLV2872ARCTP	FLB0462MWM	FLB0462MWM
FLT/FLV2872BMTNL/R	FLB0438MWM	FLB0438MWM
FLT/FLV2872DTEPL/R	FLB0462MWM	NA

Laminate/Veneer Model Number	Wire Manager Model Number	
	Eased Edge	Knife Edge
FLT/FLV2872PARCP	FLB0462MWM	FLB0462MWM
FLT/FLV2872PARCPEP	FLB0462MWM	NA
FLT/FLV2872PBMNEPL/R	FLB0438MWM	NA
FLT/FLV2872PBMNL/R	FLB0438MWM	FLB0438MWM
FLT/FLV2872PDEPL	FLB0468MWM	NA
FLT/FLV2872PDEPPL/R	FLB0468MWM	NA
FLT/FLV2872PDEPR	FLB0468MWM	NA
FLT/FLV2872PDN	FLB0468MWM	FLB0462MWM
FLT/FLV2872PDNEP	FLB0468MWM	NA
FLT/FLV2872PDP	FLB0468MWM	FLB0462MWM
FLT/FLV2872PDPEP	FLB0468MWM	NA
FLT/FLV2872PDTEPL/R	FLB0462MWM	NA
FLT/FLV2872RDEPL/R	FLB0468MWM	NA
FLT/FLV2872RRTN	FLB0468MWM	FLB0468MWM
FLT/FLV2872RRTP	FLB0468MWM	FLB0468MWM
FLT/FLV2872TD	FLB0468MWM	FLB0462MWM
FLT/FLV2878DTEPL/R	FLB0468MWM	NA
FLT/FLV2878PARCP	FLB0468MWM	FLB0468MWM
FLT/FLV2878PARCPEP	FLB0468MWM	NA
FLT/FLV2878PBMNEPL/R	FLB0444MWM	NA
FLT/FLV2878PBMNL/R	FLB0444MWM	FLB0444MWM
FLT/FLV2878PDEPL	FLB0474MWM	NA
FLT/FLV2878PDEPPR	FLB0474MWM	NA
FLT/FLV2878PDEPR	FLB0474MWM	NA
FLT/FLV2878PDN	FLB0474MWM	FLB0468MWM
FLT/FLV2878PDNEP	FLB0474MWM	NA
FLT/FLV2878PDP	FLB0474MWM	FLB0468MWM
FLT/FLV2878PDPEP	FLB0474MWM	NA
FLT/FLV2878PDTEPL/R	FLB0468MWM	NA
FLT/FLV2884DTEPL/R	FLB0474MWM	NA
FLT/FLV2884PARCP	FLB0474MWM	FLB0474MWM
FLT/FLV2884PARCPEP	FLB0474MWM	NA
FLT/FLV2884PBMNEPL/R	FLB0450MWM	NA
FLT/FLV2884PBMNL/R	FLB0450MWM	FLB0450MWM
FLT/FLV2884PDEPL	FLB0480MWM	NA
FLT/FLV2884PDEPPL/R	FLB0480MWM	NA
FLT/FLV2884PDEPR	FLB0480MWM	NA

Flux Technology

Recommend Size with Peninsula or Run-off Desk (continued)

Laminate/Veneer Model Number	Wire Manager Model Number	
	Eased Edge	Knife Edge
FLT/FLV2884PDN	FLB0480MWM	FLB0474MWM
FLT/FLV2884PDNEP	FLB0480MWM	NA
FLT/FLV2884PDP	FLB0480MWM	FLB0474MWM
FLT/FLV2884PDPEP	FLB0480MWM	NA
FLT/FLV2884PDTEPL/R	FLB0474MWM	NA
FLT/FLV3448ARCTP	FLB0438MWM	FLB0438MWM
FLT/FLV3448RRTN	FLB0444MWM	FLB0444MWM
FLT/FLV3448RRTP	FLB0444MWM	FLB0444MWM
FLT/FLV3454ARCTP	FLB0444MWM	FLB0444MWM
FLT/FLV3454RDEPL/R	FLB0450MWM	NA
FLT/FLV3454RRTN	FLB0450MWM	FLB0450MWM
FLT/FLV3454RRTP	FLB0450MWM	FLB0450MWM
FLT/FLV3460ARCTP	FLB0450MWM	FLB0450MWM
FLT/FLV3460BMTNL/R	FLB0432MWM	FLB0432MWM
FLT/FLV3460RDEPL/R	FLB0456MWM	NA
FLT/FLV3460RRTN	FLB0456MWM	FLB0456MWM
FLT/FLV3460RRTP	FLB0456MWM	FLB0456MWM
FLT/FLV3466ARCTP	FLB0456MWM	FLB0456MWM
FLT/FLV3466BMTNL/R	FLB0432MWM	FLB0432MWM
FLT/FLV3466DTEPL/R	FLB0456MWM	NA
FLT/FLV3466PARCP	FLB0456MWM	FLB0456MWM
FLT/FLV3466PARCPEP	FLB0456MWM	NA
FLT/FLV3466PBMNEPL/R	FLB0432MWM	NA
FLT/FLV3466PBMNL/R	FLB0432MWM	FLB0432MWM
FLT/FLV3466PDEPL	FLB0462MWM	NA
FLT/FLV3466PDEPPL/R	FLB0462MWM	NA
FLT/FLV3466PDEPR	FLB0462MWM	NA
FLT/FLV3466PDN	FLB0462MWM	FLB0456MWM
FLT/FLV3466PDNEP	FLB0462MWM	NA
FLT/FLV3466PDP	FLB0462MWM	FLB0456MWM
FLT/FLV3466PDPEP	FLB0462MWM	NA
FLT/FLV3466PDTEPL/R	FLB0456MWM	NA
FLT/FLV3466RDEPL/R	FLB0462MWM	NA
FLT/FLV3466RRTN	FLB0462MWM	FLB0462MWM
FLT/FLV3466RRTP	FLB0462MWM	FLB0462MWM
FLT/FLV3466TD	FLB0462MWM	FLB0456MWM
FLT/FLV3472ARCTP	FLB0462MWM	FLB0462MWM
FLT/FLV3472BMTNL/R	FLB0438MWM	FLB0438MWM
FLT/FLV3472DTEPL/R	FLB0462MWM	NA
FLT/FLV3472PARCP	FLB0462MWM	FLB0462MWM
FLT/FLV3472PARCPEP	FLB0462MWM	NA

Laminate/Veneer Model Number	Wire Manager Model Number	
	Eased Edge	Knife Edge
FLT/FLV3472PBMNEPL/R	FLB0438MWM	NA
FLT/FLV3472PBMNL/R	FLB0438MWM	FLB0438MWM
FLT/FLV3472PDEPL	FLB0468MWM	NA
FLT/FLV3472PDEPPL/R	FLB0468MWM	NA
FLT/FLV3472PDEPR	FLB0468MWM	NA
FLT/FLV3472PDN	FLB0468MWM	FLB0462MWM
FLT/FLV3472PDNEP	FLB0468MWM	NA
FLT/FLV3472PDP	FLB0468MWM	FLB0462MWM
FLT/FLV3472PDPEP	FLB0468MWM	NA
FLT/FLV3472PDTEPL/R	FLB0462MWM	NA
FLT/FLV3472RDEPL/R	FLB0468MWM	NA
FLT/FLV3472RRTN	FLB0468MWM	FLB0468MWM
FLT/FLV3472RRTP	FLB0468MWM	FLB0468MWM
FLT/FLV3472TD	FLB0468MWM	FLB0462MWM
FLT/FLV3478DTEPL/R	FLB0468MWM	NA
FLT/FLV3478PARCP	FLB0468MWM	FLB0468MWM
FLT/FLV3478PARCPEP	FLB0468MWM	NA
FLT/FLV3478PBMNEPL/R	FLB0444MWM	NA
FLT/FLV3478PBMNL/R	FLB0444MWM	FLB0444MWM
FLT/FLV3478PDEPL	FLB0474MWM	NA
FLT/FLV3478PDEPPL/R	FLB0474MWM	NA
FLT/FLV3478PDEPR	FLB0474MWM	NA
FLT/FLV3478PDN	FLB0474MWM	FLB0468MWM
FLT/FLV3478PDNEP	FLB0474MWM	NA
FLT/FLV3478PDP	FLB0474MWM	FLB0468MWM
FLT/FLV3478PDPEP	FLB0474MWM	NA
FLT/FLV3478PDTEPL/R	FLB0468MWM	NA
FLT/FLV3484DTEPL/R	FLB0474MWM	NA
FLT/FLV3484PARCP	FLB0474MWM	FLB0474MWM
FLT/FLV3484PARCPEP	FLB0474MWM	NA
FLT/FLV3484PBMNEPL/R	FLB0450MWM	NA
FLT/FLV3484PBMNL/R	FLB0450MWM	FLB0450MWM
FLT/FLV3484PDEPL	FLB0480MWM	NA
FLT/FLV3484PDEPPL/R	FLB0480MWM	NA
FLT/FLV3484PDEPR	FLB0480MWM	NA
FLT/FLV3484PDN	FLB0480MWM	FLB0474MWM
FLT/FLV3484PDNEP	FLB0480MWM	NA
FLT/FLV3484PDP	FLB0480MWM	FLB0474MWM
FLT/FLV3484PDPEP	FLB0480MWM	NA
FLT/FLV3484PDTEPL/R	FLB0474MWM	NA

Description	D	W	H	CTN WT	CU FT	① Model	HPL Laminate	Essentials Veneer	Artisan Veneer
Table Desk	33½	72	29	139	22	FLT3472TD	\$2,186		
	33½	72	29	139	22	FLV3472TD		\$2,667	\$2,936
	33½	66	29	130	20	FLT3466TD	\$2,159		
	33½	66	29	130	20	FLV3466TD		\$2,636	\$2,903

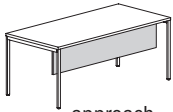
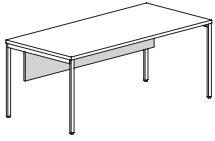

approach

Features:

- eased edge profile on approach and user sides

Options:

- reverse bevel edge available on approach and user sides, specify; add \$474 list for laminate or \$186 list for veneer; see page 8 for details
- casters available, two locking and two non-locking, specify and add \$109 list
- 13½”h modesty panel available, specify; add \$472 list for laminate or \$656 list for veneer; see page 21 for details
- 3” top grommet available, specify A or C location; add \$142 list each





eased

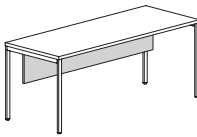
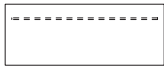
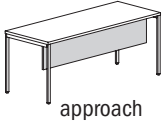

reverse bevel

edges

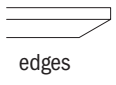
Description	D	W	H	CTN WT	CU FT	① Model	HPL Laminate	Essentials Veneer	Artisan Veneer
    eased  reverse bevel edges	27 1/2	72	29	112	18	FLT2872TD	\$2,086		
	27 1/2	72	29	112	18	FLV2872TD		\$2,561	\$2,817
	27 1/2	66	29	105	17	FLT2866TD	\$2,069		
	27 1/2	66	29	105	17	FLV2866TD		\$2,540	\$2,791
	27 1/2	60	29	99	15	FLT2860TD	\$2,050		
	27 1/2	60	29	99	15	FLV2860TD		\$2,514	\$2,766
	27 1/2	54	29	93	14	FLT2854TD	\$2,033		
	27 1/2	54	29	93	14	FLV2854TD		\$2,492	\$2,743
	27 1/2	48	29	87	12	FLT2848TD	\$2,007		
	27 1/2	48	29	87	12	FLV2848TD		\$2,464	\$2,582

Features:

- eased edge profile on approach and user sides

Options:

- reverse bevel edge available on approach and user sides, specify; add \$474 list for laminate or \$186 list for veneer; see page 8 for details
- casters available, two locking and two non-locking, specify and add \$109 list
- 13 1/2" h modesty panel available, specify; add \$474 list for laminate or \$656 list for veneer; see page 21 for details
- 3" top grommet available, specify A or C location; add \$142 list each

To Order, Specify:

① Laminate Model #	② Laminate Type	③ Laminate Selection	④ Metal Color	⑤ Other Product Options		
Laminate (FLT)	HPL	See Laminate Selection	See Metal Finish Color Options	See list of options for each specific unit; Specify and add accordingly.		
① Veneer Model #	② Wood Collection	③ Wood Finish	④ Metal Color	⑤ Other Product Options		
Veneer (FLV)	Essentials	See Essentials Wood Finish Options	See Metal Finish Color Options	See list of options for each specific unit; Specify and add accordingly.		
	Artisan	<table border="1"> <thead> <tr> <th>ⓐ Wood Finish</th> <th>ⓑ Chassis Grain Direction</th> </tr> </thead> <tbody> <tr> <td>See Artisan Wood Finish Options</td> <td>For Artisan Only: Vertical Horizontal</td> </tr> </tbody> </table>	ⓐ Wood Finish		ⓑ Chassis Grain Direction	See Artisan Wood Finish Options
ⓐ Wood Finish	ⓑ Chassis Grain Direction					
See Artisan Wood Finish Options	For Artisan Only: Vertical Horizontal					

FLUX

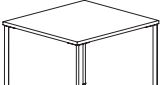
Description	D	W	H	CTN WT	CU FT	① Model	HPL Laminate	Essentials Veneer	Artisan Veneer
	48	48	29	94	14	FLT4848T	\$1,837		
	48	48	29	94	14	FLV4848T		\$2,415	\$2,657
	42	42	29	75	12	FLT4242T	\$1,561		
	42	42	29	75	12	FLV4242T		\$2,053	\$2,258

Features

- eased edge profile all sides

Options:

- reverse bevel edge available on top perimeter, specify; add \$474 list for laminate or \$186 list for veneer; see page 8 for details
- casters available, two locking and two non-locking, specify and add \$109 list



eased



reverse bevel
edges

	33½	33½	29	69	10	FLT3434T	\$1,483		
	33½	33½	29	69	10	FLV3434T		\$1,950	\$2,146
	27½	27½	29	51	9	FLT2828T	\$1,411		
	27½	27½	29	51	9	FLV2828T		\$1,852	\$2,040

Features:

- eased edge profile all sides

Options:

- reverse bevel edge available on top perimeter, specify; add \$474 list for laminate or \$186 list for veneer; see page 8 for details
- casters available, two locking and two non-locking, specify and add \$109 list



eased

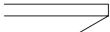

reverse bevel
edges

	48	48	29	301	46	FLT4848RT	\$1,925		
	48	48	29	77	14	FLV4848RT		\$2,532	\$2,786
	42	42	29	62	12	FLT4242RT	\$1,635		
	42	42	29	62	12	FLV4242RT		\$2,150	\$2,366

Features:

- eased edge profile

Options:

- reverse bevel edge available on top perimeter, specify; add \$474 list for laminate or \$186 list for veneer; see page 8 for details
- casters available, two locking and two non-locking, specify and add \$109 list



eased

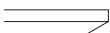

reverse bevel
edges

FLUX

Description	D	W	H	CTN WT	CU FT	① Model	HPL Laminate	Essentials Veneer	Artisan Veneer
 Square Stationary Height Table with Eased Edge Profile - Four Star Base	30	30	29	39	19	FLT3030ST4B	\$1,631		
	30	30	29	39	19	FLV3030ST4B		\$2,142	\$2,356
	24	24	29	31	13	FLT2424ST4B	\$1,588		
	24	24	29	31	13	FLV2424ST4B		\$2,088	\$2,299

Features:

- ¾" top with flat edge
- 4-star cast aluminum base

Options:

- casters available, two locking and two non-locking, specify and add \$109 list

Description	D	W	H	CTN WT	CU FT	① Model	HPL Laminate	Essentials Veneer	Artisan Veneer
 Round Stationary Height Table	36	36	29	43	27	FLT3636R4B	\$1,672		
	36	36	29	43	27	FLV3636R4B		\$2,198	\$2,417
	30	30	29	36	19	FLT3030R4B	\$1,631		
	30	30	29	36	19	FLV3030R4B		\$2,142	\$2,356

Features:

- ¾" top with flat edge
- 4-star cast aluminum base

Options:

- casters available, two locking and two non-locking, specify and add \$109 list

Description	D	W	H	CTN WT	CU FT	① Model	HPL Laminate	Essentials Veneer	Artisan Veneer
 Oval Stationary Height Table	26	36	29	39	20	FLT2636O4B	\$1,717		
	26	36	29	39	20	FLV2636O4B		\$2,254	\$2,478

Features:

- ¾" top with flat edge
- 4-star cast aluminum base

Options:

- casters available, two locking and two non-locking, specify and add \$109 list

To Order, Specify:

① Laminate Model #	② Laminate Type	③ Laminate Selection		④ Metal Color	⑤ Other Product Options
Laminate (FLT)	HPL	See Laminate Selection		See Metal Finish Color Options	See list of options for each specific unit; Specify and add accordingly.
① Veneer Model #	② Wood Collection	③ Wood Finish		④ Metal Color	⑤ Other Product Options
Veneer (FLV)	Essentials	See Essentials Wood Finish Options		See Metal Finish Color Options	See list of options for each specific unit; Specify and add accordingly.
	Artisan	ⓐ Wood Finish See Artisan Wood Finish Options	ⓑ Chassis Grain Direction For Artisan Only: Vertical Horizontal		

FLUX

Description	D	W	H	CTN WT	CU FT	① Model	HPL Laminate	Essentials Veneer	Artisan Veneer
Bow Front Double Pedestal Desk with Break Front Modesty Continuous Wire Channel - Split Top	42	84	29	359	69	FLT4284BDST	\$3,915		
	42	84	29	359	69	FLV4284BDST		\$5,376	\$5,914
	42	78	29	348	64	FLT4278BDST	\$3,824		
	42	78	29	348	64	FLV4278BDST		\$5,254	\$5,775
	42	72	29	337	59	FLT4272BDST	\$3,736		
	42	72	29	337	59	FLV4272BDST		\$5,130	\$5,641

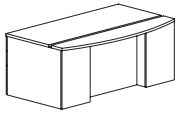
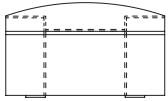
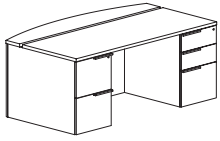

approach

Features:

- eased edge profile on approach and user sides
- built in horizontal wire channel
- 6" overhang on approach side
- pedestal front locking
- FLT4284BDST or FLV4284BDST - chassis 36" x 84"
- FLT4278BDST or FLV4278BDST - chassis 36" x 78"
- FLT4272BDST or FLV4272BDST - chassis 36" x 72"
- FLT4284BDST or FLV4284BDST - kneespace 48"
- FLT4278BDST or FLV4278BDST - kneespace 42"
- FLT4272BDST or FLV4272BDST - kneespace 36"

Options:

- must specify chassis grain direction on artisan veneer, see pages 13-15 for details
- veneer drawer fronts in paint available, specify paint color; add \$372 list; see page 16 for details
- on laminate units, contrasting worksurface tops and drawer fronts available, no upcharge; specify color, see page 16 for details
- must specify ledge or prism pull, specify and see page 9 for details
- pedestal access doors available, specify; add \$313 list for laminate or \$372 list for veneer; see page 17 for details

Description	D	W	H	CTN WT	CU FT	① Model	HPL Laminate	Essentials Veneer	Artisan Veneer
Bow Front Double Pedestal Desk with Break Front Modesty - Continuous Wire Channel - Split Top	36	84	29	341	60	FLT3684BDST	\$3,795		
	36	84	29	341	60	FLV3684BDST		\$5,124	\$5,636
	36	78	29	331	55	FLT3678BDST	\$3,715		
	36	78	29	331	55	FLV3678BDST		\$5,010	\$5,508
	36	72	29	320	51	FLT3672BDST	\$3,635		
	36	72	29	320	51	FLV3672BDST		\$4,899	\$5,388
	36	66	29	309	47	FLT3666BDST	\$3,572		
	36	66	29	309	47	FLV3666BDST		\$4,809	\$5,289
	36	60	29	298	43	FLT3660BDST	\$3,509		
	36	60	29	298	43	FLV3660BDST		\$4,724	\$5,194

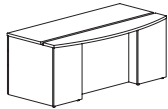
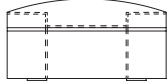
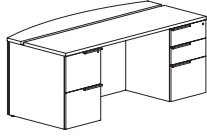

approach

Features:

- eased edge profile on approach and user sides
- built in horizontal wire channel
- 6" overhang on approach side
- pedestal front locking
- FLT3684BDST or FLV3684BDST - chassis 30" x 84"
- FLT3678BDST or FLV3678BDST - chassis 30" x 78"
- FLT3672BDST or FLV3672BDST - chassis 30" x 72"
- FLT3666BDST or FLV3666BDST - chassis 30" x 66"
- FLT3660BDST or FLV3660BDST - chassis 30" x 60"
- FLT3684BDST or FLV3684BDST - kneespace 48"
- FLT3678BDST or FLV3678BDST - kneespace 42"
- FLT3672BDST or FLV3672BDST - kneespace 36"
- FLT3666BDST or FLV3666BDST - kneespace 34 3/4"
- FLT3660BDST or FLV3660BDST - kneespace 28 3/4"

Options:

- veneer drawer fronts in paint available, specify paint color; add \$372 list; see page 16 for details
- on laminate units, contrasting worksurface tops and drawer fronts available, no upcharge; specify color, see page 16 for details
- ledge pulls standard; prism pulls available, specify and see page 9
- pedestal access doors available, specify; add \$313 list for laminate or \$372 list for veneer; see page 17 for details

To Order, Specify:

① Laminate Model #	② Laminate Type	③ Laminate Selection	④ Metal Color	⑤ Other Product Options		
Laminate (FLT)	HPL	See Laminate Selection	See Metal Finish Color Options	See list of options for each specific unit; Specify and add accordingly.		
① Veneer Model #	② Wood Collection	③ Wood Finish	④ Metal Color	⑤ Other Product Options		
Veneer (FLV)	Essentials	See Essentials Wood Finish Options	See Metal Finish Color Options	See list of options for each specific unit; Specify and add accordingly.		
	Artisan	<table border="1"> <thead> <tr> <th>③a Wood Finish</th> <th>③b Chassis Grain Direction</th> </tr> </thead> <tbody> <tr> <td>See Artisan Wood Finish Options</td> <td>For Artisan Only: Vertical Horizontal</td> </tr> </tbody> </table>	③a Wood Finish		③b Chassis Grain Direction	See Artisan Wood Finish Options
③a Wood Finish	③b Chassis Grain Direction					
See Artisan Wood Finish Options	For Artisan Only: Vertical Horizontal					

Description	D	W	H	CTN WT	CU FT	① Model	HPL Laminate	Essentials Veneer	Artisan Veneer
Bow Front Double Pedestal Desk with Break Front Modesty	42	84	29	359	69	FLT4284BD	\$3,695		
	42	84	29	359	69	FLV4284BD		\$5,160	\$5,676
	42	78	29	348	64	FLT4278BD	\$3,607		
	42	78	29	348	64	FLV4278BD		\$5,036	\$5,540
	42	72	29	337	59	FLT4272BD	\$3,520		
	42	72	29	337	59	FLV4272BD		\$4,910	\$5,403

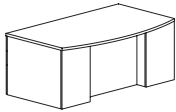
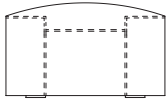
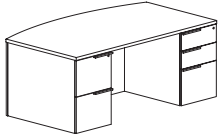

approach

Features:

- eased edge profile on approach and user sides
- 6" overhang on approach side
- pedestal front locking
- FLT4284BD or FLV4284BD - chassis 36" x 84"
- FLT4278BD or FLV4278BD - chassis 36" x 78"
- FLT4272BD or FLV4272BD - chassis 36" x 72"
- FLT4284BD or FLV4284BD - kneespace 48"
- FLT4278BD or FLV4278BD - kneespace 42"
- FLT4272BD or FLV4272BD - kneespace 36"

Options:

- must specify chassis grain direction on artisan veneer, see pages 13-15 for details
- veneer drawer fronts in paint available, specify paint color; add \$372 list; see page 16 for details
- on laminate units, contrasting worksurface tops and drawer fronts available, no upcharge; specify color, see page 16 for details
- ledge pulls standard; prism pulls available, specify and see page 9
- top grommet available, specify location; add \$142 list each; see page 44 for details
- worksurface power available, specify "to accommodate EC26" on your purchase order; EC26 unit must be ordered separately, see page 44
- pedestal access door with wire manager available, use with top grommet, specify; add \$372 list for laminate or \$431 list for veneer; see page 17 for details
- interior kneespace wire manager available, use with top grommet or power unit, specify and add \$126 list; see page 17 for details

Description	D	W	H	CTN WT	CU FT	① Model	HPL Laminate	Essentials Veneer	Artisan Veneer
Bow Front Double Pedestal Desk with Break Front Modesty	36	84	29	341	60	FLT3684BD	\$3,579		
	36	84	29	341	60	FLV3684BD		\$4,905	\$5,399
	36	78	29	331	55	FLT3678BD	\$3,498		
	36	78	29	331	55	FLV3678BD		\$4,790	\$5,269
	36	72	29	320	51	FLT3672BD	\$3,416		
	36	72	29	320	51	FLV3672BD		\$4,682	\$5,148
	36	66	29	309	47	FLT3666BD	\$3,357		
	36	66	29	309	47	FLV3666BD		\$4,593	\$5,052
	36	60	29	298	43	FLT3660BD	\$3,291		
	36	60	29	298	43	FLV3660BD		\$4,507	\$4,955

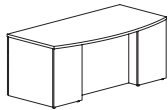
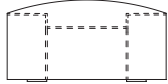
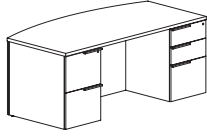

approach

Features:

- eased edge profile on approach and user sides
- 6" overhang on approach side
- pedestal front locking
- FLT3684BD or FLV3684BD - chassis 30" x 84"
- FLT3678BD or FLV3678BD - chassis 30" x 78"
- FLT3672BD or FLV3672BD - chassis 30" x 72"
- FLT3666BD or FLV3666BD - chassis 30" x 66"
- FLT3660BD or FLV3660BD - chassis 30" x 60"
- FLT3684BD or FLV3684BD - kneespace 48"
- FLT3678BD or FLV3678BD - kneespace 42"
- FLT3672BD or FLV3672BD - kneespace 36"
- FLT3666BD or FLV3666BD - kneespace 34 3/4"
- FLT3660BD or FLV3660BD - kneespace 28 3/4"

Options:

- must specify chassis grain direction on artisan veneer, see pages 13-15 for details
- veneer drawer fronts in paint available, specify paint color; add \$372 list; see page 16 for details
- on laminate units, contrasting worksurface tops and drawer fronts available, no upcharge; specify laminate color, see page 16 for details
- ledge pulls standard; prism pulls available, specify and see page 9
- top grommet available, specify location; add \$142 list each; see page 44 for details
- worksurface power available, specify "to accommodate EC26" on your purchase order; EC26 unit must be ordered separately, see page 44
- pedestal access door with wire manager available, use with top grommet, specify; add \$372 list for laminate or \$431 list for veneer; see page 17 for details

To Order, Specify:

① Laminate Model #	② Laminate Type	③ Laminate Selection	④ Metal Color	⑤ Other Product Options		
Laminate (FLT)	HPL	See Laminate Selection	See Metal Finish Color Options	See list of options for each specific unit; Specify and add accordingly.		
① Veneer Model #	② Wood Collection	③ Wood Finish	④ Metal Color	⑤ Other Product Options		
Veneer (FLV)	Essentials	See Essentials Wood Finish Options	See Metal Finish Color Options	See list of options for each specific unit; Specify and add accordingly.		
	Artisan	<table border="1"> <tr> <th>ⓐ Wood Finish</th> <th>ⓑ Chassis Grain Direction</th> </tr> <tr> <td>See Artisan Wood Finish Options</td> <td>For Artisan Only: Vertical Horizontal</td> </tr> </table>	ⓐ Wood Finish		ⓑ Chassis Grain Direction	See Artisan Wood Finish Options
ⓐ Wood Finish	ⓑ Chassis Grain Direction					
See Artisan Wood Finish Options	For Artisan Only: Vertical Horizontal					

Description	D	W	H	CTN WT	CU FT	① Model	HPL Laminate	Essentials Veneer	Artisan Veneer
Double Pedestal Desk with Break	42	84	29	370	69	FLT4284EDST	\$3,743		
Front Modesty Modesty	42	84	29	370	69	FLV4284EDST		\$5,140	\$5,654
Continuous Wire Channel - Split Top	42	78	29	357	64	FLT4278EDST	\$3,656		
	42	78	29	357	64	FLV4278EDST		\$5,017	\$5,523
	42	72	29	359	59	FLT4272EDST	\$3,575		
	42	72	29	359	59	FLV4272EDST		\$4,902	\$5,391

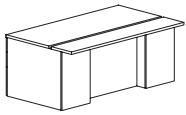
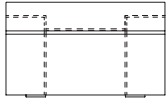
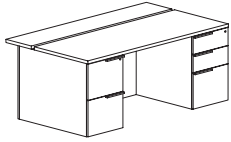

approach

Features:

- eased edge profile on approach and user sides
- built in horizontal wire channel
- 6" overhang on approach side
- pedestal front locking
- FLT4284EDST or FLV4284EDST - chassis 36" x 84"
- FLT4278EDST or FLV4278EDST - chassis 36" x 78"
- FLT4272EDST or FLV4272EDST - chassis 36" x 72"
- FLT4284EDST or FLV4284EDST - kneespace 48"
- FLT4278EDST or FLV4278EDST - kneespace 42"
- FLT4272EDST or FLV4272EDST - kneespace 36"

Options:

- must specify chassis grain direction on artisan veneer, see pages 13-15 for details
- veneer drawer fronts in paint available, specify paint color; add \$372 list; see page 16 for details
- on laminate units, contrasting worksurface tops and drawer fronts available, no upcharge; specify color, see page 16 for details
- ledge pulls standard; prism pulls available, specify and see page 9
- pedestal access doors available, specify; add \$313 list for laminate or \$372 list for veneer; see page 17 for details

Description	D	W	H	CTN WT	CU FT	① Model	HPL Laminate	Essentials Veneer	Artisan Veneer
Double Pedestal Desk with Break	36	84	29	325	60	FLT3684EDST	\$3,568		
Front Modesty - Continuous Wire Channel - Split Top	36	84	29	325	60	FLV3684EDST		\$4,898	\$5,387
	36	78	29	314	55	FLT3678EDST	\$3,488		
	36	78	29	314	55	FLV3678EDST		\$4,781	\$5,261
	36	72	29	303	51	FLT3672EDST	\$3,408		
	36	72	29	303	51	FLV3672EDST		\$4,670	\$5,137
	36	66	29	315	47	FLT3666EDST	\$3,342		
	36	66	29	315	47	FLV3666EDST		\$4,582	\$5,042
	36	60	29	304	43	FLT3660EDST	\$3,281		
	36	60	29	304	43	FLV3660EDST		\$4,496	\$4,945

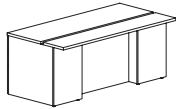
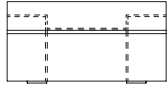
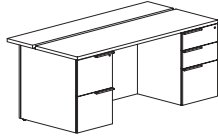

approach

Features:

- eased edge profile on approach and user sides
- built in horizontal wire channel
- 6" overhang on approach side
- pedestal front locking
- FLT3684EDST or FLV3684EDST - chassis 30" x 84"
- FLT3678EDST or FLV3678EDST - chassis 30" x 78"
- FLT3672EDST or FLV3672EDST - chassis 30" x 72"
- FLT3666EDST or FLV3666EDST - chassis 30" x 66"
- FLT3660EDST or FLV3660EDST - chassis 30" x 60"
- FLT3684EDST or FLV3684EDST - kneespace 48"
- FLT3678EDST or FLV3678EDST - kneespace 42"
- FLT3672EDST or FLV3672EDST - kneespace 36"
- FLT3666EDST or FLV3666EDST - kneespace 34 3/4"
- FLT3660EDST or FLV3660EDST - kneespace 28 3/4"

Options:

- must specify chassis grain direction on artisan veneer, see pages 13-15 for details
- veneer drawer fronts in paint available, specify paint color; add \$372 list; see page 16 for details
- on laminate units, contrasting worksurface tops and drawer fronts available, no upcharge; specify laminate color, see page 16 for details
- ledge pulls standard; prism pulls available, specify and see page 9
- pedestal access doors available, specify; add \$313 list for laminate or \$372 list for veneer; see page 17 for details

To Order, Specify:

① Laminate Model #	② Laminate Type	③ Laminate Selection	④ Metal Color	⑤ Other Product Options		
Laminate (FLT)	HPL	See Laminate Selection	See Metal Finish Color Options	See list of options for each specific unit; Specify and add accordingly.		
① Veneer Model #	② Wood Collection	③ Wood Finish	④ Metal Color	⑤ Other Product Options		
Veneer (FLV)	Essentials	See Essentials Wood Finish Options	See Metal Finish Color Options	See list of options for each specific unit; Specify and add accordingly.		
	Artisan	<table border="1"> <thead> <tr> <th>③a Wood Finish</th> <th>③b Chassis Grain Direction</th> </tr> </thead> <tbody> <tr> <td>See Artisan Wood Finish Options</td> <td>For Artisan Only: Vertical Horizontal</td> </tr> </tbody> </table>	③a Wood Finish		③b Chassis Grain Direction	See Artisan Wood Finish Options
③a Wood Finish	③b Chassis Grain Direction					
See Artisan Wood Finish Options	For Artisan Only: Vertical Horizontal					

Description	D	W	H	CTN WT	CU FT	① Model	HPL Laminate	Essentials Veneer	Artisan Veneer
Double Pedestal Desk with Break Front Modesty	42	84	29	357	69	FLT4284ED	\$3,526		
	42	84	29	357	69	FLV4284ED		\$4,924	\$5,416
	42	78	29	359	64	FLT4278ED	\$3,440		
	42	78	29	359	64	FLV4278ED		\$4,802	\$5,283
	42	72	29	349	59	FLT4272ED	\$3,358		
	42	72	29	349	59	FLV4272ED		\$4,686	\$5,152

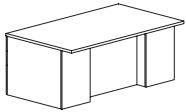
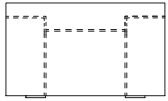
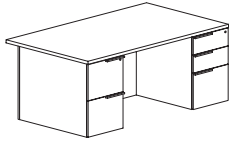

approach

Features:

- eased edge profile on approach and user sides
- 6" overhang on approach side
- pedestal front locking
- FLT4284ED or FLV4284ED - chassis 36" x 84"
- FLT4278ED or FLV4278ED - chassis 36" x 78"
- FLT4272ED or FLV4272ED - chassis 36" x 72"
- FLT4284ED or FLV4284ED - kneespace 48"
- FLT4278ED or FLV4278ED - kneespace 42"
- FLT4272ED or FLV4272ED - kneespace 36"

Options:

- must specify chassis grain direction on artisan veneer, see pages 13-15 for details
- veneer drawer fronts in paint available, specify paint color; add \$372 list; see page 16 for details
- on laminate units, contrasting worksurface tops and drawer fronts available, no upcharge; specify color, see page 16 for details
- ledge pulls standard; prism pulls available, specify and see page 9
- top grommet available, specify location; add \$142 list each; see page 44 for details
- worksurface power available, specify "to accommodate EC26" on your purchase order; EC26 unit must be ordered separately, see page 44
- pedestal access door with wire manager available, use with top grommet, specify; add \$372 list for laminate or \$431 list for veneer; see page 17 for details
- interior kneespace wire manager available, use with top grommet or power unit, specify and add \$126 list; see page 17 for details

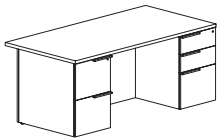
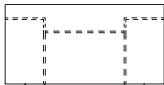
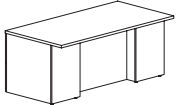
Description	D	W	H	CTN WT	CU FT	① Model	HPL Laminate	Essentials Veneer	Artisan Veneer
   approach	36	84	29	325	60	FLT3684ED	\$3,352		
	36	84	29	325	60	FLV3684ED		\$4,680	\$5,147
	36	78	29	314	55	FLT3678ED	\$3,271		
	36	78	29	314	55	FLV3678ED		\$4,565	\$5,022
	36	72	29	303	51	FLT3672ED	\$3,191		
	36	72	29	303	51	FLV3672ED		\$4,452	\$4,900
	36	66	29	315	47	FLT3666ED	\$3,127		
	36	66	29	315	47	FLV3666ED		\$4,365	\$4,802
	36	60	29	304	43	FLT3660ED	\$3,064		
	36	60	29	304	43	FLV3660ED		\$4,280	\$4,707

Features:

- eased edge profile on approach and user sides
- 6" overhang on approach side
- pedestal front locking
- FLT3684ED or FLV3684ED - chassis 30" x 84"
- FLT3678ED or FLV3678ED - chassis 30" x 78"
- FLT3672ED or FLV3672ED - chassis 30" x 72"
- FLT3666ED or FLV3666ED - chassis 30" x 66"
- FLT3660ED or FLV3660ED - chassis 30" x 72"
- FLT3684ED or FLV3684ED - kneespace 48"
- FLT3678ED or FLV3678ED - kneespace 42"
- FLT3672ED or FLV3672ED - kneespace 36"
- FLT3666ED or FLV3666ED - kneespace 28 3/4"
- FLT3660ED or FLV3660ED - kneespace 28 3/4"

Options:

- must specify chassis grain direction on artisan veneer, see pages 13-15 for details
- veneer drawer fronts in paint available, specify paint color; add \$372 list; see page 16 for details
- on laminate units, contrasting worksurface tops and drawer fronts available, no upcharge; specify laminate color, see page 16 for details
- ledge pulls standard; prism pulls available, specify and see page 9
- top grommet available, specify location; add \$142 list each; see page 44 for details
- worksurface power available, specify "to accommodate EC26" on your purchase order; EC26 unit must be ordered separately, see page 44
- pedestal access door with wire manager available, use with top grommet, specify; add \$372 list for laminate or \$431 list for veneer; see page 17 for details

To Order, Specify:

① Laminate Model #	② Laminate Type	③ Laminate Selection	④ Metal Color	⑤ Other Product Options		
Laminate (FLT)	HPL	See Laminate Selection	See Metal Finish Color Options	See list of options for each specific unit; Specify and add accordingly.		
① Veneer Model #	② Wood Collection	③ Wood Finish	④ Metal Color	⑤ Other Product Options		
Veneer (FLV)	Essentials	See Essentials Wood Finish Options	See Metal Finish Color Options	See list of options for each specific unit; Specify and add accordingly.		
	Artisan	<table border="1"> <thead> <tr> <th>ⓐ Wood Finish</th> <th>ⓑ Chassis Grain Direction</th> </tr> </thead> <tbody> <tr> <td>See Artisan Wood Finish Options</td> <td>For Artisan Only: Vertical Horizontal</td> </tr> </tbody> </table>	ⓐ Wood Finish		ⓑ Chassis Grain Direction	See Artisan Wood Finish Options
ⓐ Wood Finish	ⓑ Chassis Grain Direction					
See Artisan Wood Finish Options	For Artisan Only: Vertical Horizontal					

Description	D	W	H	CTN WT	CU FT	① Model	HPL Laminate	Essentials Veneer	Artisan Veneer
Double Pedestal Desk with Break	36	84	29	352	60	FLT3684DDST	\$3,672		
Front Modesty Continuous Wire Channel - Split Top	36	84	29	352	60	FLV3684DDST		\$5,042	\$5,546
	36	78	29	342	55	FLT3678DDST	\$3,589		
	36	78	29	342	55	FLV3678DDST		\$4,924	\$5,416
	36	72	29	331	51	FLT3672DDST	\$3,506		
	36	72	29	331	51	FLV3672DDST		\$4,807	\$5,288

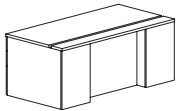
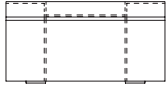
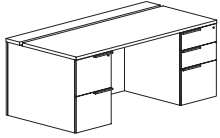

approach

Features:

- eased edge profile on approach and user sides
- built in horizontal wire channel
- pedestal front locking
- FLT3684DDST or FLV3684DDST - chassis 36" x 84"
- FLT3678DDST or FLV3678DDST - chassis 36" x 78"
- FLT3672DDST or FLV3672DDST - chassis 36" x 72"
- FLT3684DDST or FLV3684DDST - kneespace - 48"
- FLT3678DDST or FLV3678DDST - kneespace - 42"
- FLT3672DDST or FLV3672DDST - kneespace - 36"

Options:

- must specify chassis grain direction on artisan veneer, see pages 13-15 for details
- veneer drawer fronts in paint available, specify paint color; add \$372 list; see page 16 for details
- on laminate units, contrasting worksurface tops and drawer fronts available, no upcharge; specify color, see page 16 for details
- ledge pulls standard; prism pulls available, specify and see page 9
- pedestal access doors available, specify; add \$313 list for laminate or \$372 list for veneer; see page 17 for details

Description	D	W	H	CTN WT	CU FT	① Model	HPL Laminate	Essentials Veneer	Artisan Veneer
Double Pedestal Desk with Break	30	84	29	307	50	FLT3084DDST	\$3,533		
Front Modesty - Continuous Wire Channel - Split Top	30	84	29	307	50	FLV3084DDST		\$4,845	\$5,328
	30	78	29	297	47	FLT3078DDST	\$3,452		
	30	78	29	297	47	FLV3078DDST		\$4,731	\$5,206
	30	72	29	287	43	FLT3072DDST	\$3,372		
	30	72	29	287	43	FLV3072DDST		\$4,622	\$5,085
	30	66	29	278	40	FLT3066DDST	\$3,294		
	30	66	29	278	40	FLV3066DDST		\$4,514	\$4,968
	30	60	29	269	36	FLT3060DDST	\$3,220		
	30	60	29	269	36	FLV3060DDST		\$4,410	\$4,851

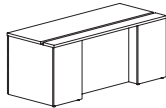
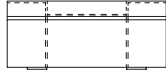
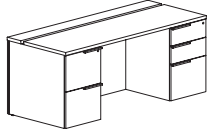

approach

Features:

- eased edge profile on approach and user sides
- built in horizontal wire channel
- pedestal front locking
- FLT3084DDST or FLV3084DDST - chassis 30" x 84"
- FLT3078DDST or FLV3078DDST - chassis 30" x 78"
- FLT3072DDST or FLV3072DDST - chassis 30" x 72"
- FLT3066DDST or FLV3066DDST - chassis 30" x 66"
- FLT3060DDST or FLV3060DDST - chassis 30" x 60"
- FLT3084DDST or FLV3084DDST - kneespace - 48"
- FLT3078DDST or FLV3078DDST - kneespace - 42"
- FLT3072DDST or FLV3072DDST - kneespace - 36"
- FLT3066DDST or FLV3066DDST - kneespace 34 3/4"
- FLT3060DDST or FLV3060DDST - kneespace 28 3/4"

Options:

- must specify chassis grain direction on artisan veneer, see pages 13-15 for details
- veneer drawer fronts in paint available, specify paint color; add \$372 list; see page 16 for details
- on laminate units, contrasting worksurface tops and drawer fronts available, no upcharge; specify laminate color, see page 16 for details
- pedestal access doors available, specify; add \$313 list for laminate or \$372 list for veneer; see page 17 for details

To Order, Specify:

① Laminate Model #	② Laminate Type	③ Laminate Selection	④ Metal Color	⑤ Other Product Options		
Laminate (FLT)	HPL	See Laminate Selection	See Metal Finish Color Options	See list of options for each specific unit; Specify and add accordingly.		
① Veneer Model #	② Wood Collection	③ Wood Finish	④ Metal Color	⑤ Other Product Options		
Veneer (FLV)	Essentials	See Essentials Wood Finish Options	See Metal Finish Color Options	See list of options for each specific unit; Specify and add accordingly.		
	Artisan	<table border="1"> <tr> <th>ⓐ Wood Finish</th> <th>ⓑ Chassis Grain Direction</th> </tr> <tr> <td>See Artisan Wood Finish Options</td> <td>For Artisan Only: Vertical Horizontal</td> </tr> </table>	ⓐ Wood Finish		ⓑ Chassis Grain Direction	See Artisan Wood Finish Options
ⓐ Wood Finish	ⓑ Chassis Grain Direction					
See Artisan Wood Finish Options	For Artisan Only: Vertical Horizontal					

Description	D	W	H	CTN WT	CU FT	① Model	HPL Laminate	Essentials Veneer	Artisan Veneer
Double Pedestal Desk with Break Front Modesty	36	84	29	352	60	FLT3684DD	\$3,455		
	36	84	29	352	60	FLV3684DD		\$4,823	\$5,306
	36	78	29	342	55	FLT3678DD	\$3,372		
	36	78	29	342	55	FLV3678DD		\$4,707	\$5,178
	36	72	29	331	51	FLT3672DD	\$3,290		
	36	72	29	331	51	FLV3672DD		\$4,592	\$5,050

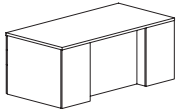
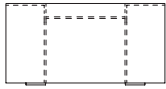
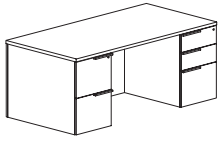

approach

Features:

- eased edge profile on approach and user sides
- pedestal front locking
- FLT3684DD or FLV3684DD - chassis 36" x 84"
- FLT3678DD or FLV3678DD - chassis 36" x 78"
- FLT3672DD or FLV3672DD - chassis 36" x 72"
- FLT3684DD or FLV3684DD - kneespace 48"
- FLT3678DD or FLV3678DD - kneespace 42"
- FLT3672DD or FLV3672DD - kneespace 36"

Options:

- must specify chassis grain direction on artisan veneer, see pages 13-15 for details
- veneer drawer fronts in paint available, specify paint color; add \$372 list; see page 16 for details
- on laminate units, contrasting worksurface tops and drawer fronts available, no upcharge; specify color, see page 16 for details
- ledge pulls standard; prism pulls available, specify and see page 9
- top grommet available, specify location; add \$142 list each; see page 44 for details
- worksurface power available, specify "to accommodate EC26" on your purchase order; EC26 unit must be ordered separately, see page 44
- pedestal access door with wire manager available, use with top grommet, specify; add \$372 list for laminate or \$431 list for veneer; see page 17 for details
- interior kneespace wire manager available, use with top grommet or power unit, specify and add \$126 list; see page 17 for details

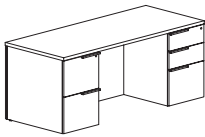
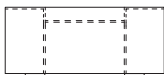
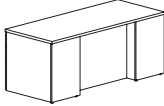
Description	D	W	H	CTN WT	CU FT	① Model	HPL Laminate	Essentials Veneer	Artisan Veneer
   approach	30	84	29	307	50	FLT3084DD	\$3,316		
	30	84	29	307	50	FLV3084DD		\$4,627	\$5,090
	30	78	29	297	47	FLT3078DD	\$3,236		
	30	78	29	297	47	FLV3078DD		\$4,514	\$4,968
	30	72	29	287	43	FLT3072DD	\$3,157		
	30	72	29	287	43	FLV3072DD		\$4,405	\$4,846
	30	66	29	278	40	FLT3066DD	\$3,079		
	30	66	29	278	40	FLV3066DD		\$4,298	\$4,729
	30	60	29	269	36	FLT3060DD	\$3,003		
	30	60	29	269	36	FLV3060DD		\$4,195	\$4,614

Features:

- eased edge profile on approach and user sides
- pedestal front locking
- FLT3084DD or FLV3084DD - chassis 30" x 84"
- FLT3078DD or FLV3078DD - chassis 30" x 78"
- FLT3072DD or FLV3072DD - chassis 30" x 72"
- FLT3066DD or FLV3066DD - chassis 30" x 66"
- FLT3060DD or FLV3060DD - chassis 30" x 60"
- FLT3084DD or FLV3084DD - kneespace 48"
- FLT3078DD or FLV3078DD - kneespace 42"
- FLT3072DD or FLV3072DD - kneespace 36"
- FLT3066DD or FLV3066DD - kneespace 34 3/4"
- FLT3060DD or FLV3060DD - kneespace 28 3/4"

Options:

- must specify chassis grain direction on artisan veneer, see pages 13-15 for details
- veneer drawer fronts in paint available, specify paint color; add \$372 list; see page 16 for details
- on laminate units, contrasting worksurface tops and drawer fronts available, no upcharge; specify laminate color, see page 16 for details
- ledge pulls standard; prism pulls available, specify and see page 9
- top grommet available, specify location; add \$142 list each; see page 44 for details
- worksurface power available, specify "to accommodate EC26" on your purchase order; EC26 unit must be ordered separately, see page 44
- pedestal access door with wire manager available, use with top grommet, specify; add \$372 list for laminate or \$431 list for veneer; see page 17 for details

To Order, Specify:

① Laminate Model #	② Laminate Type	③ Laminate Selection	④ Metal Color	⑤ Other Product Options		
Laminate (FLT)	HPL	See Laminate Selection	See Metal Finish Color Options	See list of options for each specific unit; Specify and add accordingly.		
① Veneer Model #	② Wood Collection	③ Wood Finish	④ Metal Color	⑤ Other Product Options		
Veneer (FLV)	Essentials	See Essentials Wood Finish Options	See Metal Finish Color Options	See list of options for each specific unit; Specify and add accordingly.		
	Artisan	<table border="1"> <thead> <tr> <th>ⓐ Wood Finish</th> <th>ⓑ Chassis Grain Direction</th> </tr> </thead> <tbody> <tr> <td>See Artisan Wood Finish Options</td> <td>For Artisan Only: Vertical Horizontal</td> </tr> </tbody> </table>	ⓐ Wood Finish		ⓑ Chassis Grain Direction	See Artisan Wood Finish Options
ⓐ Wood Finish	ⓑ Chassis Grain Direction					
See Artisan Wood Finish Options	For Artisan Only: Vertical Horizontal					

Description	D	W	H	CTN WT	CU FT	① Model	HPL Laminate	Essentials Veneer	Artisan Veneer
Double Pedestal Desk with Flush Modesty	36	84	29	333	60	FLT3684EDF	\$3,484		
	36	84	29	333	60	FLV3684EDF		\$4,567	\$5,023
	36	78	29	322	55	FLT3678EDF	\$3,400		
	36	78	29	322	55	FLV3678EDF		\$4,455	\$4,902
	36	72	29	312	51	FLT3672EDF	\$3,316		
	36	72	29	312	51	FLV3672EDF		\$4,346	\$4,779

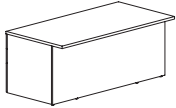
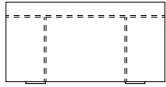
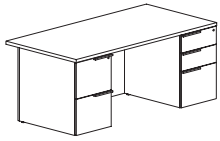

approach

Features:

- eased edge profile on approach and user sides
- 6" overhang on approach side
- pedestal front locking
- FLT3684EDF or FLV3684EDF - chassis 30" x 84"
- FLT3678EDF or FLV3678EDF - chassis 30" x 78"
- FLT3672EDF or FLV3672EDF - chassis 30" x 72"
- FLT3684EDF or FLV3684EDF - kneespace 48"
- FLT3678EDF or FLV3678EDF - kneespace 42"
- FLT3672EDF or FLV3672EDF - kneespace 36"

Options:

- must specify chassis grain direction on artisan veneer, see pages 13-15 for details
- veneer drawer fronts in paint available, specify paint color; add \$372 list; see page 16 for details
- on laminate units, contrasting worksurface tops and drawer fronts available, no upcharge; specify laminate color, see page 16 for details
- ledge pulls standard; prism pulls available, specify and see page 9
- top grommet available, specify location; add \$142 list each; see page 44 for details
- worksurface power available, specify "to accommodate EC26" on your purchase order; EC26 unit must be ordered separately, see page 44
- interior kneespace wire manager available, use with top grommet or power unit, specify and add \$126 list; see page 17 for details

Description	D	W	H	CTN WT	CU FT	① Model	HPL Laminate	Essentials Veneer	Artisan Veneer
Double Pedestal Desk with Flush Modesty	30	72	29	268	43	FLT3072EDF	\$3,002		
	30	72	29	268	43	FLV3072EDF		\$4,190	\$4,607
	30	66	29	261	40	FLT3066EDF	\$2,944		
	30	66	29	261	40	FLV3066EDF		\$4,106	\$4,517
	30	60	29	254	36	FLT3060EDF	\$2,883		
	30	60	29	254	36	FLV3060EDF		\$4,024	\$4,427

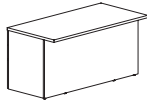
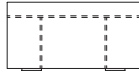
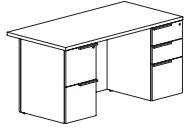

approach

Features:

- eased edge profile on approach and user sides
- 6" overhang on approach side
- pedestal front locking
- FLT3072EDF or FLV3072EDF - chassis 24" x 72"
- FLT3066EDF or FLV3066EDF - chassis 24" x 66"
- FLT3060EDF or FLV3060EDF - chassis 24" x 60"
- FLT3072EDF or FLV3072EDF - kneespace 36"
- FLT3066EDF or FLV3066EDF - kneespace 34 3/4"
- FLT3060EDF or FLV3060EDF - kneespace 28 3/4"

Options:

- must specify chassis grain direction on artisan veneer, see pages 13-15 for details
- veneer drawer fronts in paint available, specify paint color; add \$372 list; see page 16 for details
- on laminate units, contrasting worksurface tops and drawer fronts available, no upcharge; specify laminate color, see page 16 for details
- ledge pulls standard; prism pulls available, specify and see page 9
- top grommet available, specify location; add \$142 list each; see page 44 for details
- worksurface power available, specify "to accommodate EC26" on your purchase order; EC26 unit must be ordered separately, see page 44
- interior kneespace wire manager available, use with top grommet or power unit, specify and add \$126 list; see page 17 for details

To Order, Specify:

① Laminate Model #	② Laminate Type	③ Laminate Selection	④ Metal Color	⑤ Other Product Options		
Laminate (FLT)	HPL	See Laminate Selection	See Metal Finish Color Options	See list of options for each specific unit; Specify and add accordingly.		
① Veneer Model #	② Wood Collection	③ Wood Finish	④ Metal Color	⑤ Other Product Options		
Veneer (FLV)	Essentials	See Essentials Wood Finish Options	See Metal Finish Color Options	See list of options for each specific unit; Specify and add accordingly.		
	Artisan	<table border="1"> <thead> <tr> <th>ⓐ Wood Finish</th> <th>ⓑ Chassis Grain Direction</th> </tr> </thead> <tbody> <tr> <td>See Artisan Wood Finish Options</td> <td>For Artisan Only: Vertical Horizontal</td> </tr> </tbody> </table>	ⓐ Wood Finish		ⓑ Chassis Grain Direction	See Artisan Wood Finish Options
ⓐ Wood Finish	ⓑ Chassis Grain Direction					
See Artisan Wood Finish Options	For Artisan Only: Vertical Horizontal					

Description	D	W	H	CTN WT	CU FT	① Model	HPL Laminate	Essentials Veneer	Artisan Veneer
Double Pedestal Desk with Flush Modesty - Continuous Wire Channel - Split Top	30	84	29	307	50	FLT3084DDSTF	\$3,429		
	30	84	29	307	50	FLV3084DDSTF		\$4,922	\$5,413
	30	78	29	297	47	FLT3078DDSTF	\$3,351		
	30	78	29	297	47	FLV3078DDSTF		\$4,696	\$5,166
	30	72	29	287	43	FLT3072DDSTF	\$3,273		
	30	72	29	287	43	FLV3072DDSTF		\$4,485	\$4,931
	30	66	29	278	40	FLT3066DDSTF	\$3,210		
	30	66	29	278	40	FLV3066DDSTF		\$4,398	\$4,841
	30	60	29	269	36	FLT3060DDSTF	\$3,153		
	30	60	29	269	36	FLV3060DDSTF		\$4,316	\$4,746

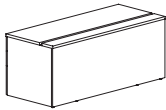
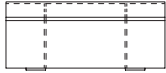
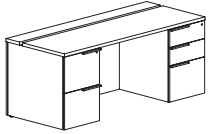

approach

Features:

- eased edge profile on approach and user sides
- built in horizontal wire channel
- pedestal front locking
- FLT3084DDSTF or FLV3084DDSTF - chassis 30" x 84"
- FLT3078DDSTF or FLV3078DDSTF - chassis 30" x 78"
- FLT3072DDSTF or FLV3072DDSTF - chassis 30" x 72"
- FLT3066DDSTF or FLV3066DDSTF - chassis 30" x 66"
- FLT3060DDSTF or FLV3060DDSTF - chassis 30" x 60"
- FLT3084DDSTF or FLV3084DDSTF - kneespace 48"
- FLT3078DDSTF or FLV3078DDSTF - kneespace 42"
- FLT3072DDSTF or FLV3072DDSTF - kneespace 36"
- FLT3066DDSTF or FLV3066DDSTF - kneespace 34 3/4"
- FLT3060DDSTF or FLV3060DDSTF - kneespace 28 3/4"

Options:

- must specify chassis grain direction on artisan veneer, see pages 13-15 for details
- veneer drawer fronts in paint available, specify paint color; add \$372 list; see page 16 for details
- on laminate units, contrasting worksurface tops and drawer fronts available, no upcharge; specify laminate color, see page 16 for details
- ledge pulls standard; prism pulls available, specify and see page 9

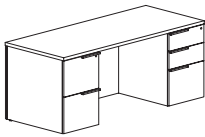
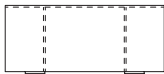
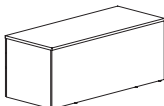
Description	D	W	H	CTN WT	CU FT	① Model	HPL Laminate	Essentials Veneer	Artisan Veneer
   approach	30	84	29	307	50	FLT3084DDF	\$3,210		
	30	84	29	307	50	FLV3084DDF		\$4,704	\$5,175
	30	78	29	297	47	FLT3078DDF	\$3,134		
	30	78	29	297	47	FLV3078DDF		\$4,482	\$4,927
	30	72	29	287	43	FLT3072DDF	\$3,055		
	30	72	29	287	43	FLV3072DDF		\$4,267	\$4,692
	30	66	29	278	40	FLT3066DDF	\$2,995		
	30	66	29	278	40	FLV3066DDF		\$4,181	\$4,601
	30	60	29	269	36	FLT3060DDF	\$2,936		
	30	60	29	269	36	FLV3060DDF		\$4,099	\$4,509

Features:

- eased edge profile on approach and user sides
- pedestal front locking
- FLT3084DDF or FLV3084DDF - chassis 30" x 84"
- FLT3078DDF or FLV3078DDF - chassis 30" x 78"
- FLT3072DDF or FLV3072DDF - chassis 30" x 72"
- FLT3066DDF or FLV3066DDF - chassis 30" x 60"
- FLT3060DDF or FLV3060DDF - chassis 30" x 60"
- FLT3084DDF or FLV3084DDF - kneespace 48"
- FLT3078DDF or FLV3078DDF - kneespace 42"
- FLT3072DDF or FLV3072DDF - kneespace 36"
- FLT3066DDF or FLV3066DDF - kneespace 34 3/4"
- FLT3060DDF or FLV3060DDF - kneespace 28 3/4"

Options:

- must specify chassis grain direction on artisan veneer, see pages 13-15 for details
- veneer drawer fronts in paint available, specify paint color; add \$372 list; see page 16 for details
- on laminate units, contrasting worksurface tops and drawer fronts available, no upcharge; specify laminate color, see page 16 for details
- ledge pulls standard; prism pulls available, specify and see page 9
- top grommet available, specify location; add \$142 list each; see page 44 for details
- worksurface power available, specify "to accommodate EC26" on your purchase order; EC26 unit must be ordered separately, see page 44

To Order, Specify:

① Laminate Model #	② Laminate Type	③ Laminate Selection	④ Metal Color	⑤ Other Product Options		
Laminate (FLT)	HPL	See Laminate Selection	See Metal Finish Color Options	See list of options for each specific unit; Specify and add accordingly.		
① Veneer Model #	② Wood Collection	③ Wood Finish	④ Metal Color	⑤ Other Product Options		
Veneer (FLV)	Essentials	See Essentials Wood Finish Options	See Metal Finish Color Options	See list of options for each specific unit; Specify and add accordingly.		
	Artisan	<table border="1"> <thead> <tr> <th>③a Wood Finish</th> <th>③b Chassis Grain Direction</th> </tr> </thead> <tbody> <tr> <td>See Artisan Wood Finish Options</td> <td>For Artisan Only: Vertical Horizontal</td> </tr> </tbody> </table>	③a Wood Finish		③b Chassis Grain Direction	See Artisan Wood Finish Options
③a Wood Finish	③b Chassis Grain Direction					
See Artisan Wood Finish Options	For Artisan Only: Vertical Horizontal					

Description	D	W	H	CTN WT	CU FT	① Model	HPL Laminate	Essentials Veneer	Artisan Veneer
Bow Front Single Pedestal Desk with Break Front Modesty Continuous Wire Channel - Split Top	42	84	29	318	69	FLT4284RBDST	\$3,415		
	42	84	29	318	69	FLV4284RBDST		\$4,594	\$5,053
	42	84	29	318	69	FLT4284LBDST	\$3,415		
	42	84	29	318	69	FLV4284LBDST		\$4,594	\$5,053
	42	78	29	307	64	FLT4278RBDST	\$3,342		
	42	78	29	307	64	FLV4278RBDST		\$4,492	\$4,943
	42	78	29	307	64	FLT4278LBDST	\$3,342		
	42	78	29	307	64	FLV4278LBDST		\$4,492	\$4,943
	42	72	29	296	59	FLT4272RBDST	\$3,273		
	42	72	29	296	59	FLV4272RBDST		\$4,395	\$4,832
	42	72	29	296	59	FLT4272LBDST	\$3,273		
	42	72	29	296	59	FLV4272LBDST		\$4,395	\$4,832

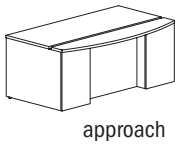
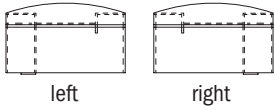
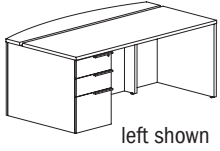

Features:

- eased edge profile on approach and user sides
- built in horizontal wire channel
- 6" overhang on approach side
- pedestal front locking
- FLT4284RBDST or FLT4284LBDST and FLV4284RBDST or FLV4284LBDST - chassis 36" x 84"
- FLT4278RBDST or FLT4278LBDST and FLV4278RBDST or FLV4278LBDST - chassis 36" x 78"
- FLT4272RBDST or FLT4272LBDST and FLV4272RBDST or FLV4272LBDST - chassis 36" x 72"

Options:

- must specify chassis grain direction on artisan veneer, see pages 13-15 for details
- veneer drawer fronts in paint available, specify paint color; add \$372 list; see page 16 for details
- on laminate units, contrasting worksurface tops and drawer fronts available, no upcharge; specify color, see page 16 for details
- ledge pulls standard; prism pulls available, specify and see page 9
- pedestal access doors available, specify; add \$313 list for laminate or \$372 list for veneer; see page 17 for details

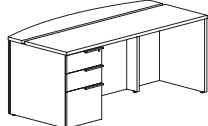
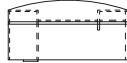
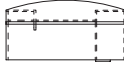
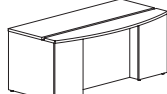
Description	D	W	H	CTN WT	CU FT	① Model	HPL Laminate	Essentials Veneer	Artisan Veneer
 <p>left shown</p>   <p>left right</p>  <p>approach</p>	36	84	29	285	60	FLT3684RBDST	\$3,253		
	36	84	29	285	60	FLV3684RBDST		\$4,455	\$4,902
	36	84	29	285	60	FLT3684LBDST	\$3,253		
	36	84	29	285	60	FLV3684LBDST		\$4,455	\$4,902
	36	78	29	276	55	FLT3678RBDST	\$3,179		
	36	78	29	276	55	FLV3678RBDST		\$4,354	\$4,785
	36	78	29	276	55	FLT3678LBDST	\$3,179		
	36	78	29	276	55	FLV3678LBDST		\$4,354	\$4,785
	36	72	29	267	51	FLT3672RBDST	\$3,108		
	36	72	29	267	51	FLV3672RBDST		\$4,250	\$4,677
	36	72	29	267	51	FLT3672LBDST	\$3,108		
	36	72	29	267	51	FLV3672LBDST		\$4,250	\$4,677
	36	66	29	258	47	FLT3666RBDST	\$3,038		
	36	66	29	258	47	FLV3666RBDST		\$4,154	\$4,570
	36	66	29	258	47	FLT3666LBDST	\$3,038		
	36	66	29	258	47	FLV3666LBDST		\$4,154	\$4,570
	36	60	29	249	43	FLT3660RBDST	\$2,968		
	36	60	29	249	43	FLV3660RBDST		\$4,058	\$4,464
	36	60	29	249	43	FLT3660LBDST	\$2,968		
	36	60	29	249	43	FLV3660LBDST		\$4,058	\$4,464

Features:

- eased edge profile on approach and user sides
- built in horizontal wire channel
- 6" overhang on approach side
- pedestal front locking
- FLT3684RBDST or FLT3684LBDST and FLV3684RBDST or FLV3684LBDST - chassis 30" x 84"
- FLT3678RBDST or FLT3678LBDST and FLV3678RBDST or FLV3678LBDST - chassis 30" x 78"
- FLT3672RBDST or FLT3672LBDST and FLV3672RBDST or FLV3672LBDST - chassis 30" x 72"
- FLT3666RBDST or FLT3666LBDST and FLV3666RBDST or FLV3666LBDST - chassis 30" x 66"
- FLT3660RBDST or FLT3660LBDST and FLV3660RBDST or FLV3660LBDST - chassis 30" x 60"

Options:

- must specify chassis grain direction on artisan veneer, see pages 13-15 for details
- veneer drawer fronts in paint available, specify paint color; add \$372 list; see page 16 for details
- on laminate units, contrasting worksurface tops and drawer fronts available, no upcharge; specify laminate color, see page 16 for details
- ledge pulls standard; prism pulls available, specify and see page 9
- pedestal access doors available, specify; add \$313 list for laminate or \$372 list for veneer; see page 17 for details

To Order, Specify:

① Laminate Model #	② Laminate Type	③ Laminate Selection	④ Metal Color	⑤ Other Product Options		
Laminate (FLT)	HPL	See Laminate Selection	See Metal Finish Color Options	See list of options for each specific unit; Specify and add accordingly.		
① Veneer Model #	② Wood Collection	③ Wood Finish	④ Metal Color	⑤ Other Product Options		
Veneer (FLV)	Essentials	See Essentials Wood Finish Options	See Metal Finish Color Options	See list of options for each specific unit; Specify and add accordingly.		
	Artisan	<table border="1"> <tr> <th>ⓐ Wood Finish</th> <th>ⓑ Chassis Grain Direction</th> </tr> <tr> <td>See Artisan Wood Finish Options</td> <td>For Artisan Only: Vertical Horizontal</td> </tr> </table>	ⓐ Wood Finish		ⓑ Chassis Grain Direction	See Artisan Wood Finish Options
ⓐ Wood Finish	ⓑ Chassis Grain Direction					
See Artisan Wood Finish Options	For Artisan Only: Vertical Horizontal					

Description	D	W	H	CTN WT	CU FT	① Model	HPL Laminate	Essentials Veneer	Artisan Veneer
Bow Front Single Pedestal Desk with Break Front Modesty	42	84	29	318	69	FLT4284RBD	\$3,200		
	42	84	29	318	69	FLV4284RBD		\$4,376	\$4,814
	42	84	29	318	69	FLT4284LBD	\$3,200		
	42	84	29	318	69	FLV4284LBD		\$4,376	\$4,814
	42	78	29	307	64	FLT4278RBD	\$3,127		
	42	78	29	307	64	FLV4278RBD		\$4,276	\$4,704
	42	78	29	307	64	FLT4278LBD	\$3,127		
	42	78	29	307	64	FLV4278LBD		\$4,276	\$4,704
	42	72	29	296	59	FLT4272RBD	\$3,055		
	42	72	29	296	59	FLV4272RBD		\$4,177	\$4,594
	42	72	29	296	59	FLT4272LBD	\$3,055		
	42	72	29	296	59	FLV4272LBD		\$4,177	\$4,594

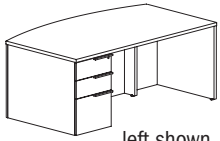

left shown

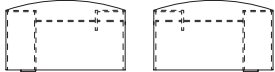

left

right

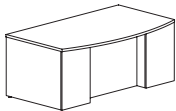



approach

Features:

- eased edge profile on approach and user sides
- 6" overhang on approach side
- pedestal front locking
- FLT4284RBD or FLT4284LBD and FLV4284RBD or FLV4284LBD - chassis 36" x 84"
- FLT4278RBD or FLT4278LBD and FLV4278RBD or FLV4278LBD - chassis 36" x 78"
- FLT4272RBD or FLT4272LBD and FLV4272RBD or FLV4272LBD - chassis 36" x 72"

Options:

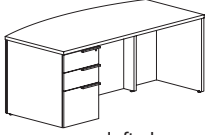
- must specify chassis grain direction on artisan veneer, see pages 13-15 for details
- veneer drawer fronts in paint available, specify paint color and add \$372 list; see page 16 for details
- on laminate units, contrasting worksurface tops and drawer fronts available, no upcharge; specify laminate color, see page 16 for details
- ledge pulls standard; prism pulls available, specify and see page 9
- top grommet available, specify location; add \$142 list each; see page 44 for details
- worksurface power available, specify "to accommodate EC26" on your purchase order; EC26 unit must be ordered separately, see page 44
- pedestal access door with wire manager available, use with top grommet, specify; add \$372 list for laminate or \$431 list for veneer; see page 17 for details
- interior kneespace wire manager available, use with top grommet or power unit, specify and add \$126 list; see page 17 for details

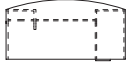
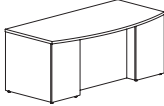
Description	D	W	H	CTN WT	CU FT	① Model	HPL Laminate	Essentials Veneer	Artisan Veneer
Bow Front Single Pedestal Desk with Break Front Modesty	36	84	29	285	60	FLT3684RBD	\$3,038		
	36	84	29	285	60	FLV3684RBD		\$4,239	\$4,662
	36	84	29	285	60	FLT3684LBD	\$3,038		
	36	84	29	285	60	FLV3684LBD		\$4,239	\$4,662
 	36	78	29	276	55	FLT3678RBD	\$2,964		
	36	78	29	276	55	FLV3678RBD		\$4,136	\$4,549
	36	78	29	276	55	FLT3678LBD	\$2,964		
	36	78	29	276	55	FLV3678LBD		\$4,136	\$4,549
	36	72	29	267	51	FLT3672RBD	\$2,891		
	36	72	29	267	51	FLV3672RBD		\$4,035	\$4,440
	36	72	29	267	51	FLT3672LBD	\$2,891		
	36	72	29	267	51	FLV3672LBD		\$4,035	\$4,440
	36	66	29	258	47	FLT3666RBD	\$2,822		
	36	66	29	258	47	FLV3666RBD		\$3,938	\$4,330
	36	66	29	258	47	FLT3666LBD	\$2,822		
	36	66	29	258	47	FLV3666LBD		\$3,938	\$4,330
	36	60	29	249	43	FLT3660RBD	\$2,751		
	36	60	29	249	43	FLV3660RBD		\$3,840	\$4,226
	36	60	29	249	43	FLT3660LBD	\$2,751		
	36	60	29	249	43	FLV3660LBD		\$3,840	\$4,226

Features:

- eased edge profile on approach and user sides
- 6" overhang on approach side
- pedestal front locking
- FLT3684RBD or FLT3684LBD and FLV3684RBD or FLV3684LBD - chassis 30" x 84"
- FLT3678RBD or FLT3678LBD and FLV3678RBD or FLV3678LBD - chassis 30" x 78"
- FLT3672RBD or FLT3672LBD and FLV3672RBD or FLV3672LBD - chassis 30" x 72"
- FLT3666RBD or FLT3666LBD and FLV3666RBD or FLV3666LBD - chassis 30" x 66"
- FLT3660RBD or FLT3660LBD and FLV3660RBD or FLV3660LBD - chassis 30" x 60"

Options:

- must specify chassis grain direction on artisan veneer, see pages 13-15 for details
- veneer drawer fronts in paint available, specify paint color; add \$372 list; see page 16 for details
- on laminate units, contrasting worksurface tops and drawer fronts available, no upcharge; specify laminate color, see page 16 for details
- ledge pulls standard; prism pulls available, specify and see page 9
- top grommet available, specify location; add \$142 list each; see page 44 for details
- worksurface power available, specify "to accommodate EC26" on your purchase order; EC26 unit must be ordered separately, see page 44
- pedestal access door with wire manager available, use with top grommet, specify; add \$372 list for laminate or \$431 list for veneer; see page 17 for details
- interior kneespace wire manager available, use with top grommet or power unit, specify and add \$126 list; see page 17 for details

To Order, Specify:

① Laminate Model #	② Laminate Type	③ Laminate Selection	④ Metal Color	⑤ Other Product Options		
Laminate (FLT)	HPL	See Laminate Selection	See Metal Finish Color Options	See list of options for each specific unit; Specify and add accordingly.		
① Veneer Model #	② Wood Collection	③ Wood Finish	④ Metal Color	⑤ Other Product Options		
Veneer (FLV)	Essentials	See Essentials Wood Finish Options	See Metal Finish Color Options	See list of options for each specific unit; Specify and add accordingly.		
	Artisan	<table border="1"> <tr> <th>ⓐ Wood Finish</th> <th>ⓑ Chassis Grain Direction</th> </tr> <tr> <td>See Artisan Wood Finish Options</td> <td>For Artisan Only: Vertical Horizontal</td> </tr> </table>	ⓐ Wood Finish		ⓑ Chassis Grain Direction	See Artisan Wood Finish Options
ⓐ Wood Finish	ⓑ Chassis Grain Direction					
See Artisan Wood Finish Options	For Artisan Only: Vertical Horizontal					

Description	D	W	H	CTN WT	CU FT	① Model	HPL Laminate	Essentials Veneer	Artisan Veneer
Single Pedestal Desk with Break	42	84	29	325	69	FLT4284REDST	\$3,190		
Front Modesty - Continuous Wire	42	84	29	325	69	FLV4284REDST		\$4,366	\$4,804
Channel - Split Top	42	84	29	325	69	FLT4284LEDST	\$3,190		
	42	84	29	325	69	FLV4284LEDST		\$4,366	\$4,804
	42	78	29	314	64	FLT4278REDST	\$3,118		
	42	78	29	314	64	FLV4278REDST		\$4,267	\$4,692
	42	78	29	314	64	FLT4278LEDST	\$3,118		
	42	78	29	314	64	FLV4278LEDST		\$4,267	\$4,692
	42	72	29	303	59	FLT4272REDST	\$3,047		
	42	72	29	303	59	FLV4272REDST		\$4,167	\$4,583
	42	72	29	303	59	FLT4272LEDST	\$3,047		
	42	72	29	303	59	FLV4272LEDST		\$4,167	\$4,583

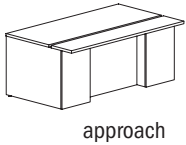
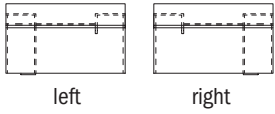
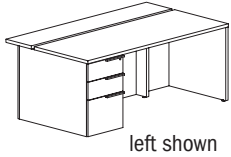

Features:

- eased edge profile on approach and user sides
- built in horizontal wire channel
- 6" overhang on approach side
- pedestal front locking
- FLT4284REDST or FLT4284LEDST and FLV4284REDST or FLV4284LEDST - chassis 36" x 84"
- FLT4278REDST or FLT4278LEDST and FLV4278REDST or FLV4278LEDST - chassis 36" x 78"
- FLT4272REDST or FLT4272LEDST and FLV4272REDST or FLV4272LEDST - chassis 36" x 72"

Options:

- must specify chassis grain direction on artisan veneer, see pages 13-15 for details
- veneer drawer fronts in paint available, specify paint color; add \$372 list; see page 16 for details
- on laminate units, contrasting worksurface tops and drawer fronts available, no upcharge; specify laminate color, see page 16 for details
- ledge pulls standard; prism pulls available, specify and see page 9
- pedestal access doors available, specify; add \$313 list for laminate or \$372 list for veneer; see page 17 for details

FLUX

Description	D	W	H	CTN WT	CU FT	① Model	HPL Laminate	Essentials Veneer	Artisan Veneer
Single Pedestal Desk with Break	36	84	29	289	60	FLT3684REDST	\$3,049		
Front Modesty - Continuous Wire Channel - Split Top	36	84	29	289	60	FLV3684REDST		\$4,170	\$4,587
	36	84	29	289	60	FLT3684LEDST	\$3,049		
	36	84	29	289	60	FLV3684LEDST		\$4,170	\$4,587
	36	78	29	280	55	FLT3678REDST	\$2,979		
	36	78	29	280	55	FLV3678REDST		\$4,076	\$4,483
	36	78	29	280	55	FLT3678LEDST	\$2,979		
	36	78	29	280	55	FLV3678LEDST		\$4,076	\$4,483
	36	72	29	271	51	FLT3672REDST	\$2,913		
	36	72	29	271	51	FLV3672REDST		\$3,978	\$4,376
	36	72	29	271	51	FLT3672LEDST	\$2,913		
	36	72	29	271	51	FLV3672LEDST		\$3,978	\$4,376
	36	66	29	264	47	FLT3666REDST	\$2,859		
	36	66	29	264	47	FLV3666REDST		\$3,903	\$4,293
	36	66	29	264	47	FLT3666LEDST	\$2,859		
	36	66	29	264	47	FLV3666LEDST		\$3,903	\$4,293
	36	60	29	255	43	FLT3660REDST	\$2,806		
	36	60	29	255	43	FLV3660REDST		\$3,831	\$4,215
	36	60	29	255	43	FLT3660LEDST	\$2,806		
	36	60	29	255	43	FLV3660LEDST		\$3,831	\$4,215

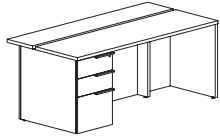

left shown



left

right

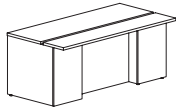

approach

Features:

- eased edge profile on approach and user sides
- built in horizontal wire channel
- 6" overhang on approach side
- pedestal front locking
- FLT3684REDST or FLT3684LEDST and FLV3684REDST or FLV3684LEDST - chassis 30" x 84"
- FLT3678REDST or FLT3678LEDST and FLV3678REDST or FLV3678LEDST - chassis 30" x 78"
- FLT3672REDST or FLT3672LEDST and FLV3672REDST or FLV3672LEDST - chassis 30" x 72"
- FLT3666REDST or FLT3666LEDST and FLV3666REDST or FLV3666LEDST - chassis 30" x 66"
- FLT3660REDST or FLT3660LEDST and FLV3660REDST or FLV3660LEDST - chassis 30" x 60"

Options:

- must specify chassis grain direction on artisan veneer, see pages 13-15 for details
- veneer drawer fronts in paint available, specify paint color; add \$372 list; see page 16 for details
- on laminate units, contrasting worksurface tops and drawer fronts available, no upcharge; specify laminate color, see page 16 for details
- ledge pulls standard; prism pulls available, specify and see page 9
- pedestal access doors available, specify; add \$313 list for laminate or \$372 list for veneer; see page 17 for details

To Order, Specify:

① Laminate Model #	② Laminate Type	③ Laminate Selection	④ Metal Color	⑤ Other Product Options		
Laminate (FLT)	HPL	See Laminate Selection	See Metal Finish Color Options	See list of options for each specific unit; Specify and add accordingly.		
① Veneer Model #	② Wood Collection	③ Wood Finish	④ Metal Color	⑤ Other Product Options		
Veneer (FLV)	Essentials	See Essentials Wood Finish Options	See Metal Finish Color Options	See list of options for each specific unit; Specify and add accordingly.		
	Artisan	<table border="1"> <tr> <th>ⓐ Wood Finish</th> <th>ⓑ Chassis Grain Direction</th> </tr> <tr> <td>See Artisan Wood Finish Options</td> <td>For Artisan Only: Vertical Horizontal</td> </tr> </table>	ⓐ Wood Finish		ⓑ Chassis Grain Direction	See Artisan Wood Finish Options
ⓐ Wood Finish	ⓑ Chassis Grain Direction					
See Artisan Wood Finish Options	For Artisan Only: Vertical Horizontal					

Description	D	W	H	CTN WT	CU FT	① Model	HPL Laminate	Essentials Veneer	Artisan Veneer
Single Pedestal Desk with Break Front Modesty	42	84	29	325	69	FLT4284RED	\$2,972		
	42	84	29	325	69	FLV4284RED		\$4,151	\$4,565
	42	84	29	325	69	FLT4284LED	\$2,972		
	42	84	29	325	69	FLV4284LED		\$4,151	\$4,565
	42	78	29	314	64	FLT4278RED	\$2,903		
	42	78	29	314	64	FLV4278RED		\$4,048	\$4,452
	42	78	29	314	64	FLT4278LED	\$2,903		
	42	78	29	314	64	FLV4278LED		\$4,048	\$4,452
	42	72	29	303	59	FLT4272RED	\$2,831		
	42	72	29	303	59	FLV4272RED		\$3,952	\$4,346
	42	72	29	303	59	FLT4272LED	\$2,831		
	42	72	29	303	59	FLV4272LED		\$3,952	\$4,346

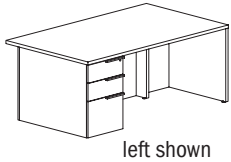

left shown

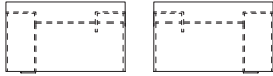

left

right

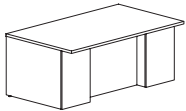

approach

Features:

- eased edge profile on approach and user sides
- 6" overhang on approach side
- pedestal front locking
- FLT4284RED or FLT4284LED and FLV4284RED or FLV4284LED - chassis 36" X 84"
- FLT4278RED or FLT4278LED and FLV4278RED or FLV4278LED - chassis 36" X 78"
- FLT4272RED or FLT4272LED and FLV4272RED or FLV4272LED - chassis 36" X 72"

Options:

- must specify chassis grain direction on artisan veneer, see pages 13-15 for details
- veneer drawer fronts in paint available, specify paint color and add \$372 list; see page 16 for details
- on laminate units, contrasting worksurface tops and drawer fronts available, no upcharge; specify laminate color, see page 16 for details
- ledge pulls standard; prism pulls available, specify and see page 9
- top grommet available, specify location; add \$142 list each; see page 44 for details
- worksurface power available, specify "to accommodate EC26" on your purchase order; EC26 unit must be ordered separately, see page 44
- pedestal access door with wire manager available, use with top grommet, specify; add \$372 list for laminate or \$431 list for veneer; see page 17 for details
- interior kneespace wire manager available, use with top grommet or power unit, specify and add \$126 list; see page 17 for details

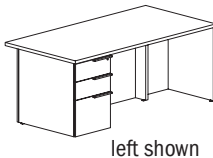
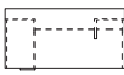
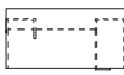
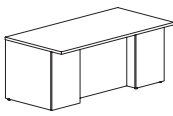
Description	D	W	H	CTN WT	CU FT	① Model	HPL Laminate	Essentials Veneer	Artisan Veneer
Single Pedestal Desk with Break Front Modesty	36	84	29	289	60	FLT3684RED	\$2,832		
	36	84	29	289	60	FLV3684RED		\$3,954	\$4,350
	36	84	29	289	60	FLT3684LED	\$2,832		
	36	84	29	289	60	FLV3684LED		\$3,954	\$4,350
	36	78	29	280	55	FLT3678RED	\$2,762		
	36	78	29	280	55	FLV3678RED		\$3,858	\$4,242
	36	78	29	280	55	FLT3678LED	\$2,762		
	36	78	29	280	55	FLV3678LED		\$3,858	\$4,242
	36	72	29	271	51	FLT3672RED	\$2,696		
	36	72	29	271	51	FLV3672RED		\$3,763	\$4,139
	36	72	29	271	51	FLT3672LED	\$2,696		
	36	72	29	271	51	FLV3672LED		\$3,763	\$4,139
	36	66	29	264	47	FLT3666RED	\$2,641		
	36	66	29	264	47	FLV3666RED		\$3,688	\$4,056
	36	66	29	264	47	FLT3666LED	\$2,641		
	36	66	29	264	47	FLV3666LED		\$3,688	\$4,056
	36	60	29	255	43	FLT3660RED	\$2,590		
	36	60	29	255	43	FLV3660RED		\$3,614	\$3,976
	36	60	29	255	43	FLT3660LED	\$2,590		
	36	60	29	255	43	FLV3660LED		\$3,614	\$3,976

Features:

- eased edge profile on approach and user sides
- 6" overhang on approach side
- pedestal front locking
- FLT3684RED or FLT3684LED and FLV3684RED or FLV3684LED - chassis 30" x 84"
- FLT3678RED or FLT3678LED and FLV3678RED or FLV3678LED - chassis 30" x 78"
- FLT3672RED or FLT3672LED and FLV3672RED or FLV3672LED - chassis 30" x 72"
- FLV3666RED or FLV3666LED and FLT3666RED or FLT3666LED - chassis 30" x 66"
- FLT3660RED or FLT3660LED and FLV3660RED or FLV3660LED - chassis 30" x 60"

Options:

- must specify chassis grain direction on artisan veneer, see pages 13-15 for details
- veneer drawer fronts in paint available, specify paint color; add \$372 list; see page 16 for details
- on laminate units, contrasting worksurface tops and drawer fronts available, no upcharge; specify laminate color, see page 16 for details
- ledge pulls standard; prism pulls available, specify and see page 9
- top grommet available, specify location; add \$142 list each; see page 44 for details
- worksurface power available, specify "to accommodate EC26" on your purchase order; EC26 unit must be ordered separately, see page 44
- pedestal access door with wire manager available, use with top grommet, specify; add \$372 list for laminate or \$431 list for veneer; see page 17 for details
- interior kneespace wire manager available, use with top grommet or power unit, specify and add \$126 list; see page 17 for details

To Order, Specify:

① Laminate Model #	② Laminate Type	③ Laminate Selection	④ Metal Color	⑤ Other Product Options			
Laminate (FLT)	HPL	See Laminate Selection	See Metal Finish Color Options	See list of options for each specific unit; Specify and add accordingly.			
① Veneer Model #	② Wood Collection	③ Wood Finish	④ Metal Color	⑤ Other Product Options			
Veneer (FLV)	Essentials	See Essentials Wood Finish Options	See Metal Finish Color Options	See list of options for each specific unit; Specify and add accordingly.			
	Artisan	<table border="1"> <tr> <th>ⓐ Wood Finish</th> <th>ⓑ Chassis Grain Direction</th> </tr> <tr> <td>See Artisan Wood Finish Options</td> <td>For Artisan Only: Vertical Horizontal</td> </tr> </table>	ⓐ Wood Finish	ⓑ Chassis Grain Direction	See Artisan Wood Finish Options	For Artisan Only: Vertical Horizontal	
ⓐ Wood Finish	ⓑ Chassis Grain Direction						
See Artisan Wood Finish Options	For Artisan Only: Vertical Horizontal						

Description	D	W	H	CTN WT	CU FT	① Model	HPL Laminate	Essentials Veneer	Artisan Veneer
Single Pedestal Desk with Break	36	84	29	306	60	FLT3684RDST	\$3,119		
Front Modesty -Continuous Wire Channel - Split Top	36	84	29	306	60	FLV3684RDST		\$4,269	\$4,695
	36	84	29	306	60	FLT3684LDST	\$3,119		
	36	84	29	306	60	FLV3684LDST		\$4,269	\$4,695
	36	78	29	295	55	FLT3678RDST	\$3,049		
	36	78	29	295	55	FLV3678RDST		\$4,170	\$4,587
	36	78	29	295	55	FLT3678LDST	\$3,049		
	36	78	29	295	55	FLV3678LDST		\$4,170	\$4,587
	36	72	29	284	51	FLT3672RDST	\$3,035		
	36	72	29	284	51	FLV3672RDST		\$4,074	\$4,482
	36	72	29	284	51	FLT3672LDST	\$3,035		
	36	72	29	284	51	FLV3672LDST		\$4,074	\$4,482

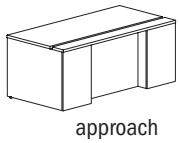
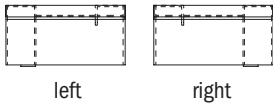
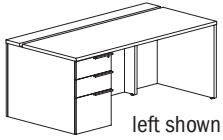



Features:

- eased edge profile on approach and user sides
- built in horizontal wire channel
- pedestal front locking
- FLT3684RDST or FLT3684LDST and FLV3684RDST or FLV3684LDST - chassis 36" x 84"
- FLT3678RDST or FLT3678LDST and FLV3678RDST or FLV3678LDST - chassis 36" x 78"
- FLT3672RDST or FLT3672LDST and FLV3672RDST or FLV3672LDST - chassis 36" x 72"

Options:

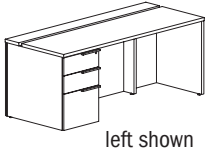
- must specify chassis grain direction on artisan veneer, see pages 13-15 for details
- veneer drawer fronts in paint available, specify paint color and add \$372 list; see page 16 for details
- on laminate units, contrasting worksurface tops and drawer fronts available, no upcharge; specify laminate color, see page 16 for details
- ledge pulls standard; prism pulls available, specify and see page 9
- pedestal access doors available, specify; add \$313 list for laminate or \$372 list for veneer; see page 17 for details

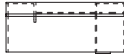
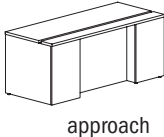
Description	D	W	H	CTN WT	CU FT	① Model	HPL Laminate	Essentials Veneer	Artisan Veneer
Single Pedestal Desk with Break Front Modesty - Continuous Wire Channel - Split Top	30	84	29	272	50	FLT3084RDST	\$3,011		
	30	84	29	272	50	FLV3084RDST		\$4,116	\$4,529
	30	84	29	272	50	FLT3084LDST	\$3,011		
	30	84	29	272	50	FLV3084LDST		\$4,116	\$4,529
 	30	78	29	264	47	FLT3078RDST	\$2,946		
	30	78	29	264	47	FLV3078RDST		\$4,022	\$4,424
	30	78	29	264	47	FLT3078LDST	\$2,946		
	30	78	29	264	47	FLV3078LDST		\$4,022	\$4,424
	30	72	29	256	43	FLT3072RDST	\$2,877		
	30	72	29	256	43	FLV3072RDST		\$3,931	\$4,321
	30	72	29	256	43	FLT3072LDST	\$2,877		
	30	72	29	256	43	FLV3072LDST		\$3,931	\$4,321
	30	66	29	248	40	FLT3066RDST	\$2,812		
	30	66	29	248	40	FLV3066RDST		\$3,839	\$4,225
	30	66	29	248	40	FLT3066LDST	\$2,812		
	30	66	29	248	40	FLV3066LDST		\$3,839	\$4,225
	30	60	29	240	36	FLT3060RDST	\$2,750		
	30	60	29	240	36	FLV3060RDST		\$3,751	\$4,128
	30	60	29	240	36	FLT3060LDST	\$2,750		
	30	60	29	240	36	FLV3060LDST		\$3,751	\$4,128

Features:

- eased edge profile on approach and user sides
- built in horizontal wire channel
- pedestal front locking
- FLT3084RDST or FLT3084LDST and FLV3084RDST or FLV3084LDST - chassis 30" x 84"
- FLT3078RDST or FLT3078LDST and FLV3078RDST or FLV3078LDST - chassis 30" x 78"
- FLT3072RDST or FLT3072LDST and FLV3072RDST or FLV3072LDST - chassis 30" x 72"
- FLT3066RDST or FLT3066LDST and FLV3066RDST or FLV3066LDST - chassis 30" x 66"
- FLT3060RDST or FLT3060LDST and FLV3060RDST or FLV3060LDST - chassis 30" x 60"

Options:

- must specify chassis grain direction on artisan veneer, see pages 13-15 for details
- veneer drawer fronts in paint available, specify paint color; add \$372 list; see page 16 for details
- on laminate units, contrasting worksurface tops and drawer fronts available, no upcharge; specify laminate color, see page 16 for details
- ledge pulls standard; prism pulls available, specify and see page 9
- pedestal access doors available, specify; add \$313 list for laminate or \$372 list for veneer; see page 17 for details

To Order, Specify:

① Laminate Model #	② Laminate Type	③ Laminate Selection	④ Metal Color	⑤ Other Product Options
Laminate (FLT)	HPL	See Laminate Selection	See Metal Finish Color Options	See list of options for each specific unit; Specify and add accordingly.
① Veneer Model #	② Wood Collection	③ Wood Finish	④ Metal Color	⑤ Other Product Options
Veneer (FLV)	Essentials	See Essentials Wood Finish Options	See Metal Finish Color Options	See list of options for each specific unit; Specify and add accordingly.
	Artisan	ⓐ Wood Finish See Artisan Wood Finish Options	ⓑ Chassis Grain Direction For Artisan Only: Vertical Horizontal	

Description	D	W	H	CTN WT	CU FT	① Model	HPL Laminate	Essentials Veneer	Artisan Veneer
Single Pedestal Desk with Break Front Modesty	36	84	29	306	60	FLT3684RD	\$2,904		
	36	84	29	306	60	FLV3684RD		\$4,051	\$4,457
	36	84	29	306	60	FLT3684LD	\$2,904		
	36	84	29	306	60	FLV3684LD		\$4,051	\$4,457
	36	78	29	295	55	FLT3678RD	\$2,832		
	36	78	29	295	55	FLV3678RD		\$3,954	\$4,350
	36	78	29	295	55	FLT3678LD	\$2,832		
	36	78	29	295	55	FLV3678LD		\$3,954	\$4,350
	36	72	29	284	51	FLT3672RD	\$2,817		
	36	72	29	284	51	FLV3672RD		\$3,857	\$4,241
	36	72	29	284	51	FLT3672LD	\$2,817		
	36	72	29	284	51	FLV3672LD		\$3,857	\$4,241

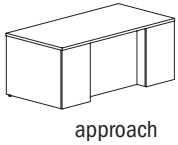
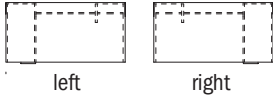
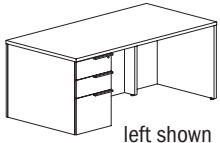

Features:

- eased edge profile on approach and user sides
- pedestal front locking
- FLT3684RD or FLT3684RD and FLV3684LD or FLV3684LD - chassis 36" x 84"
- FLT3678RD or FLT3678LD and FLV3678RD or FLV3678LD - chassis 36" x 78"
- FLT3672RD or FLT3672LD and FLV3672RD or FLV3672LD - chassis 36" x 72"

Options:

- must specify chassis grain direction on artisan veneer, see pages 13-15 for details
- veneer drawer fronts in paint available, specify paint color and add \$372 list; see page 16 for details
- on laminate units, contrasting worksurface tops and drawer fronts available, no upcharge; specify laminate color, see page 16 for details
- ledge pulls standard; prism pulls available, specify and see page 9
- top grommet available, specify location; add \$142 list each; see page 44 for details
- worksurface power available, specify "to accommodate EC26" on your purchase order; EC26 unit must be ordered separately, see page 44
- pedestal access door with wire manager available, use with top grommet, specify; add \$372 list for laminate or \$431 list for veneer; see page 17 for details
- interior kneespace wire manager available, use with top grommet or power unit, specify and add \$126 list; see page 17 for details

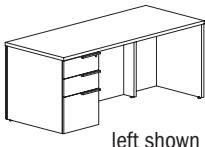
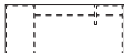
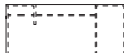
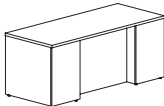
Description	D	W	H	CTN WT	CU FT	① Model	HPL Laminate	Essentials Veneer	Artisan Veneer
Single Pedestal Desk with Break Front Modesty	30	84	29	272	50	FLT3084RD	\$2,792		
	30	84	29	272	50	FLV3084RD		\$3,899	\$4,291
	30	84	29	272	50	FLT3084LD	\$2,792		
	30	84	29	272	50	FLV3084LD		\$3,899	\$4,291
 	30	78	29	264	47	FLT3078RD	\$2,725		
	30	78	29	264	47	FLV3078RD		\$3,807	\$4,185
	30	78	29	264	47	FLT3078LD	\$2,725		
	30	78	29	264	47	FLV3078LD		\$3,807	\$4,185
	30	72	29	256	43	FLT3072RD	\$2,661		
	30	72	29	256	43	FLV3072RD		\$3,714	\$4,084
	30	72	29	256	43	FLT3072LD	\$2,661		
	30	72	29	256	43	FLV3072LD		\$3,714	\$4,084
	30	66	29	248	40	FLT3066RD	\$2,595		
	30	66	29	248	40	FLV3066RD		\$3,623	\$3,986
	30	66	29	248	40	FLT3066LD	\$2,595		
	30	66	29	248	40	FLV3066LD		\$3,623	\$3,986
	30	60	29	240	36	FLT3060RD	\$2,532		
	30	60	29	240	36	FLV3060RD		\$3,535	\$3,889
	30	60	29	240	36	FLT3060LD	\$2,532		
	30	60	29	240	36	FLV3060LD		\$3,535	\$3,889

Features:

- eased edge profile on approach and user sides
- pedestal front locking
- FLT3084RD or FLT3084LD and FLV3084RD or FLV3084LD - chassis 30" x 84"
- FLT3078RD or FLT3078LD and FLV3078RD or FLV3078LD - chassis 30" x 78"
- FLT3072RD or FLT3072LD and FLV3072RD or FLV3072LD - chassis 30" x 72"
- FLT3066RD or FLT3066LD and FLV3066RD or FLV3066LD - chassis 30" x 66"
- FLT3060RD or FLT3060LD and FLV3060RD or FLV3060LD - chassis 30" x 60"

Options:

- must specify chassis grain direction on artisan veneer, see pages 13-15 for details
- veneer drawer fronts in paint available, specify paint color; add \$372 list; see page 16 for details
- on laminate units, contrasting worksurface tops and drawer fronts available, no upcharge; specify laminate color, see page 16 for details
- ledge pulls standard; prism pulls available, specify and see page 9
- top grommet available, specify location; add \$142 list each; see page 44 for details
- worksurface power available, specify "to accommodate EC26" on your purchase order; EC26 unit must be ordered separately, see page 44
- pedestal access door with wire manager available, use with top grommet, specify; add \$372 list for laminate or \$431 list for veneer; see page 17 for details
- interior kneespace wire manager available, use with top grommet or power unit, specify and add \$126 list; see page 17 for details

To Order, Specify:

① Laminate Model #	② Laminate Type	③ Laminate Selection	④ Metal Color	⑤ Other Product Options		
Laminate (FLT)	HPL	See Laminate Selection	See Metal Finish Color Options	See list of options for each specific unit; Specify and add accordingly.		
① Veneer Model #	② Wood Collection	③ Wood Finish	④ Metal Color	⑤ Other Product Options		
Veneer (FLV)	Essentials	See Essentials Wood Finish Options	See Metal Finish Color Options	See list of options for each specific unit; Specify and add accordingly.		
	Artisan	<table border="1"> <tr> <th>ⓐ Wood Finish</th> <th>ⓑ Chassis Grain Direction</th> </tr> <tr> <td>See Artisan Wood Finish Options</td> <td>For Artisan Only: Vertical Horizontal</td> </tr> </table>	ⓐ Wood Finish		ⓑ Chassis Grain Direction	See Artisan Wood Finish Options
ⓐ Wood Finish	ⓑ Chassis Grain Direction					
See Artisan Wood Finish Options	For Artisan Only: Vertical Horizontal					

Description	D	W	H	CTN WT	CU FT	① Model	HPL Laminate	Essentials Veneer	Artisan Veneer
Single Pedestal Desk with Flush Modesty	36	84	29	272	60	FLT3684REDF	\$2,686		
	36	84	29	272	60	FLV3684REDF		\$3,749	\$4,127
	36	84	29	272	60	FLT3684LEDF	\$2,686		
	36	84	29	272	60	FLV3684LEDF		\$3,749	\$4,127
	36	78	29	263	55	FLT3678REDF	\$2,621		
	36	78	29	263	55	FLV3678REDF		\$3,658	\$4,024
	36	78	29	263	55	FLT3678LEDF	\$2,621		
	36	78	29	263	55	FLV3678LEDF		\$3,658	\$4,024
	36	72	29	254	51	FLT3672REDF	\$2,558		
	36	72	29	254	51	FLV3672REDF		\$3,569	\$3,929
	36	72	29	254	51	FLT3672LEDF	\$2,558		
	36	72	29	254	51	FLV3672LEDF		\$3,569	\$3,929

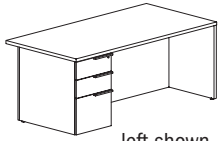

left shown

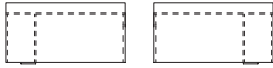

left

right

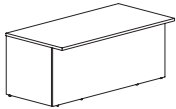

approach

Features:

- eased edge profile on approach and user sides
- 6" overhang on approach side
- pedestal front locking
- FLT3684REDF or FLT3684LEDF and FLV3684REDF or FLV3684LEDF - chassis 30" x 84"
- FLT3678REDF or FLV3678LEDF and FLV3678REDF or FLV3678LEDF - chassis 30" x 78"
- FLT3672REDF or FLT3672LEDF and FLV3672REDF or FLV3672LEDF - chassis 30" x 72"

Options:

- must specify chassis grain direction on artisan veneer, see pages 13-15 for details
- veneer drawer fronts in paint available, specify paint color and add \$372 list; see page 16 for details
- on laminate units, contrasting worksurface tops and drawer fronts available, no upcharge; specify laminate color, see page 16 for details
- ledge pulls standard; prism pulls available, specify and see page 9
- top grommet available, specify location; add \$142 list each; see page 44 for details
- worksurface power available, specify "to accommodate EC26" on your purchase order; EC26 unit must be ordered separately, see page 44
- interior kneespace wire manager available, use with top grommet or power unit, specify and add \$126 list; see page 17 for details

FLUX

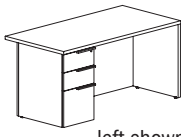
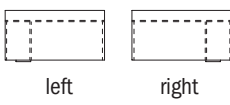
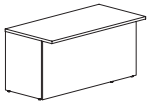
Description	D	W	H	CTN WT	CU FT	① Model	HPL Laminate	Essentials Veneer	Artisan Veneer
 <p>left shown</p>  <p>left right</p>  <p>approach</p>	30	72	29	219	43	FLT3072REDF	\$2,440		
	30	72	29	219	43	FLV3072REDF		\$3,407	\$3,747
	30	72	29	219	43	FLT3072LEDF	\$2,440		
	30	72	29	219	43	FLV3072LEDF		\$3,407	\$3,747
	30	66	29	212	40	FLT3066REDF	\$2,381		
	30	66	29	212	40	FLV3066REDF		\$3,323	\$3,654
	30	66	29	212	40	FLT3066LEDF	\$2,381		
	30	66	29	212	40	FLV3066LEDF		\$3,323	\$3,654
	30	60	29	205	36	FLT3060REDF	\$2,324		
	30	60	29	205	36	FLV3060REDF		\$3,242	\$3,567
	30	60	29	205	36	FLT3060LEDF	\$2,324		
	30	60	29	205	36	FLV3060LEDF		\$3,242	\$3,567

Features:

- eased edge profile on approach and user sides
- 6" overhang on approach side
- pedestal front locking
- FLT3072REDF or FLT3072LEDF and FLV3072REDF or FLV3072LEDF - chassis 24" x 72"
- FLT3066REDF or FLT3066LEDF and FLV3066REDF or FLV3066LEDF - chassis 24" x 66"
- FLT3060REDF or FLT3060LEDF and FLV3060REDF or FLV3060LEDF - chassis 24" x 60"

Options:

- must specify chassis grain direction on artisan veneer, see pages 13-15 for details
- veneer drawer fronts in paint available, specify paint color and add \$372 list; see page 16 for details
- on laminate units, contrasting worksurface tops and drawer fronts available, no upcharge; specify laminate color, see page 16 for details
- ledge pulls standard; prism pulls available, specify and see page 9
- top grommet available, specify location; add \$142 list each; see page 44 for details
- worksurface power available, specify "to accommodate EC26" on your purchase order; EC26 unit must be ordered separately, see page 44
- interior kneespace wire manager available, use with top grommet or power unit, specify and add \$126 list; see page 17 for details

To Order, Specify:

① Laminate Model #	② Laminate Type	③ Laminate Selection	④ Metal Color	⑤ Other Product Options		
Laminate (FLT)	HPL	See Laminate Selection	See Metal Finish Color Options	See list of options for each specific unit; Specify and add accordingly.		
① Veneer Model #	② Wood Collection	③ Wood Finish	④ Metal Color	⑤ Other Product Options		
Veneer (FLV)	Essentials	See Essentials Wood Finish Options	See Metal Finish Color Options	See list of options for each specific unit; Specify and add accordingly.		
	Artisan	<table border="1"> <thead> <tr> <th>ⓐ Wood Finish</th> <th>ⓑ Chassis Grain Direction</th> </tr> </thead> <tbody> <tr> <td>See Artisan Wood Finish Options</td> <td>For Artisan Only: Vertical Horizontal</td> </tr> </tbody> </table>	ⓐ Wood Finish		ⓑ Chassis Grain Direction	See Artisan Wood Finish Options
ⓐ Wood Finish	ⓑ Chassis Grain Direction					
See Artisan Wood Finish Options	For Artisan Only: Vertical Horizontal					

Description	D	W	H	CTN WT	CU FT	① Model	HPL Laminate	Essentials Veneer	Artisan Veneer
Single Pedestal Desk with Flush Modesty - Continuous Wire Channel - Split Top	30	84	29	259	50	FLT3084RDSTF	\$2,832		
	30	84	29	259	50	FLV3084RDSTF		\$3,866	\$4,252
	30	84	29	259	50	FLT3084LDSTF	\$2,832		
	30	84	29	259	50	FLV3084LDSTF		\$3,866	\$4,252
	30	78	29	251	47	FLT3078RDSTF	\$2,767		
	30	78	29	251	47	FLV3078RDSTF		\$3,778	\$4,156
	30	78	29	251	47	FLT3078LDSTF	\$2,767		
	30	78	29	251	47	FLV3078LDSTF		\$3,778	\$4,156
	30	72	29	243	43	FLT3072RDSTF	\$2,828		
	30	72	29	243	43	FLV3072RDSTF		\$3,690	\$4,060
	30	72	29	243	43	FLT3072LDSTF	\$2,828		
	30	72	29	243	43	FLV3072LDSTF		\$3,690	\$4,060
	30	66	29	235	40	FLT3066RDSTF	\$2,655		
	30	66	29	235	40	FLV3066RDSTF		\$3,621	\$3,984
	30	66	29	235	40	FLT3066LDSTF	\$2,655		
	30	66	29	235	40	FLV3066LDSTF		\$3,621	\$3,984
	30	60	29	227	36	FLT3060RDSTF	\$2,609		
	30	60	29	227	36	FLV3060RDSTF		\$3,553	\$3,909
	30	60	29	227	36	FLT3060LDSTF	\$2,609		
	30	60	29	227	36	FLV3060LDSTF		\$3,553	\$3,909

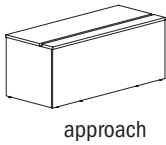
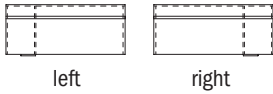
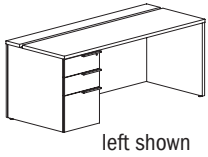

Features:

- eased edge profile on approach and user sides
- built in horizontal wire channel
- pedestal front locking
- FLT3084RDSTF or FLT3084LDSTF and FLV3084RDSTF or FLV3084LDSTF - chassis 30" x 84"
- FLT3078RDSTF or FLT3078LDSTF and FLV3078RDSTF or FLV3078LDSTF - chassis 30" x 78"
- FLT3072RDSTF or FLT3072LDSTF and FLV3072RDSTF or FLV3072LDSTF - chassis 30" x 72"
- FLT3066RDSTF or FLT3066LDSTF and FLV3066RDSTF or FLV3066LDSTF - chassis 30" x 66"
- FLT3060RDSTF or FLT3060LDSTF and FLV3060RDSTF or FLV3060LDSTF - chassis 30" x 60"

Options:

- must specify chassis grain direction on artisan veneer, see pages 13-15 for details
- veneer drawer fronts in paint available, specify paint color; add \$372 list; see page 16 for details
- on laminate units, contrasting worksurface tops and drawer fronts available, no upcharge; specify laminate color, see page 16 for details
- ledge pulls standard; prism pulls available, specify and see page 9

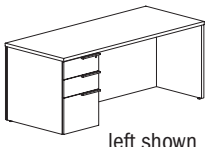
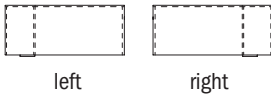
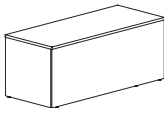
Description	D	W	H	CTN WT	CU FT	① Model	HPL Laminate	Essentials Veneer	Artisan Veneer
 <p>left shown</p>  <p>left right</p>  <p>approach</p>	30	84	29	259	50	FLT3084RDF	\$2,615		
	30	84	29	259	50	FLV3084RDF		\$3,649	\$4,014
	30	84	29	259	50	FLT3084LDF	\$2,615		
	30	84	29	259	50	FLV3084LDF		\$3,649	\$4,014
	30	78	29	251	47	FLT3078RDF	\$2,551		
	30	78	29	251	47	FLV3078RDF		\$3,561	\$3,918
	30	78	29	251	47	FLT3078LDF	\$2,551		
	30	78	29	251	47	FLV3078LDF		\$3,561	\$3,918
	30	72	29	243	43	FLT3072RDF	\$2,491		
	30	72	29	243	43	FLV3072RDF		\$3,474	\$3,820
	30	72	29	243	43	FLT3072LDF	\$2,491		
	30	72	29	243	43	FLV3072LDF		\$3,474	\$3,820
	30	66	29	235	40	FLT3066RDF	\$2,438		
	30	66	29	235	40	FLV3066RDF		\$3,405	\$3,744
	30	66	29	235	40	FLT3066LDF	\$2,438		
	30	66	29	235	40	FLV3066LDF		\$3,405	\$3,744
	30	60	29	227	36	FLT3060RDF	\$2,391		
	30	60	29	227	36	FLV3060RDF		\$3,335	\$3,670
	30	60	29	227	36	FLT3060LDF	\$2,391		
	30	60	29	227	36	FLV3060LDF		\$3,335	\$3,670

Features:



- eased edge profile on approach and user sides
- pedestal front locking
- FLT3084RDF or FLT3084LDF and FLV3084RDF or FLV3084LDF - chassis 30" x 84"
- FLT3078RDF or FLT3078LDF and FLV3078RDF or FLV3078LDF - chassis 30" x 78"
- FLT3072RDF or FLT3072LDF and FLV3072RDF or FLV3072LDF - chassis 30" x 72"
- FLT3066RDF or FLT3066LDF and FLV3066RDF or FLV3066LDF - chassis 30" x 66"
- FLT3060RDF or FLT3060LDF and FLV3060RDF or FLV3060LDF - chassis 30" x 60"

Options:

- must specify chassis grain direction on artisan veneer, see pages 13-15 for details
- veneer drawer fronts in paint available, specify paint color; add \$372 list; see page 16 for details
- on laminate units, contrasting worksurface tops and drawer fronts available, no upcharge; specify laminate color, see page 16 for details
- ledge pulls standard; prism pulls available, specify and see page 9
- top grommet available, specify location; add \$142 list each; see page 44 for details
- worksurface power available, specify "to accommodate EC26" on your purchase order; EC26 unit must be ordered separately, see page 44
- interior kneespace wire manager available, use with top grommet or power unit, specify and add \$126 list; see page 17 for details

To Order, Specify:

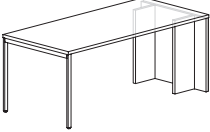
① Laminate Model #	② Laminate Type	③ Laminate Selection	④ Metal Color	⑤ Other Product Options
Laminate (FLT)	HPL	See Laminate Selection	See Metal Finish Color Options	See list of options for each specific unit; Specify and add accordingly.
① Veneer Model #	② Wood Collection	③ Wood Finish	④ Metal Color	⑤ Other Product Options
Veneer (FLV)	Essentials	See Essentials Wood Finish Options	See Metal Finish Color Options	See list of options for each specific unit; Specify and add accordingly.
	Artisan	ⓐ Wood Finish See Artisan Wood Finish Options	ⓑ Chassis Grain Direction For Artisan Only: Vertical Horizontal	

Description	D	W	H	CTN WT	CU FT	① Model	HPL Laminate	Essentials Veneer	Artisan Veneer
Rectangular Peninsula Table Desk with End Leg Assembly and Panel End  	33½	84	29	169	56	FLT3484PDNEP	\$2,419		
	33½	84	29	169	56	FLV3484PDNEP		\$3,190	\$3,510
	33½	78	29	161	52	FLT3478PDNEP	\$2,379		
	33½	78	29	161	52	FLV3478PDNEP		\$3,135	\$3,450
	33½	72	29	153	48	FLT3472PDNEP	\$2,338		
	33½	72	29	153	48	FLV3472PDNEP		\$3,082	\$3,390
	33½	66	29	145	44	FLT3466PDNEP	\$2,300		
	33½	66	29	145	44	FLV3466PDNEP		\$3,030	\$3,333

Features:

- intended to be used with bridges or return units, see pages 154-159
- eased edge profile on approach and user sides

Options:

- must specify support panels grain direction on artisan veneer, see pages 13-15 for details
- on laminate units, contrasting worksurface tops and chassis available, no upcharge; specify color see page 16 for details
- 13 ½”h modesty panel available, specify; add \$474 list for laminate or \$656 list for veneer; see page 21 for details
- top grommet available, specify location; add \$142 list each; see page 44 for details
- 12” wide top grommet available, specify location; add \$186 list each; see page 44 for details
- worksurface power available, specify “to accommodate EC26” on your purchase order; EC26 unit must be ordered separately, see page 44
- wire manager tray available see accessory section on pages 50-51 for details

Description	D	W	H	CTN WT	CU FT	① Model	HPL Laminate	Essentials Veneer	Artisan Veneer
Rectangular Peninsula Table	27 1/2	84	29	145	46	FLT2884PDNEP	\$2,334		
Desk with End Leg Assembly and Panel End	27 1/2	84	29	145	46	FLV2884PDNEP		\$3,078	\$3,385
	27 1/2	78	29	139	43	FLT2878PDNEP	\$2,296		
	27 1/2	78	29	139	43	FLV2878PDNEP		\$3,027	\$3,328
	27 1/2	72	29	133	40	FLT2872PDNEP	\$2,258		
	27 1/2	72	29	133	40	FLV2872PDNEP		\$2,972	\$3,271
	27 1/2	66	29	127	37	FLT2866PDNEP	\$2,231		
	27 1/2	66	29	127	37	FLV2866PDNEP		\$2,936	\$3,231

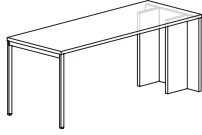

Features:

- intended to be used with bridges or return units, see pages 154-159
- eased edge profile on approach and user sides



Options:

- must specify support panels grain direction on artisan veneer, see pages 13-15 for details
- on laminate units, contrasting worksurface tops and chassis available, no upcharge; specify color see page 16 for details
- 13 1/2" h modesty panel available, specify; add \$474 list for laminate or \$656 list for veneer; see page 21 for details
- top grommet available, specify location; add \$142 list each; see page 44 for details
- 12" wide top grommet available, specify location; add \$186 list each; see page 44 for details
- worksurface power available, specify "to accommodate EC26" on your purchase order; EC26 unit must be ordered separately, see page 44
- wire manager tray available see accessory section on pages 50-51 for details

FLUX

To Order, Specify:

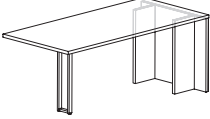
① Laminate Model #	② Laminate Type	③ Laminate Selection	④ Metal Color	⑤ Other Product Options		
Laminate (FLT)	HPL	See Laminate Selection	See Metal Finish Color Options	See list of options for each specific unit; Specify and add accordingly.		
① Veneer Model #	② Wood Collection	③ Wood Finish	④ Metal Color	⑤ Other Product Options		
Veneer (FLV)	Essentials	See Essentials Wood Finish Options	See Metal Finish Color Options	See list of options for each specific unit; Specify and add accordingly.		
	Artisan	<table border="1"> <tr> <th>ⓐ Wood Finish</th> <th>ⓑ Chassis Grain Direction</th> </tr> <tr> <td>See Artisan Wood Finish Options</td> <td>For Artisan Only: Vertical Horizontal</td> </tr> </table>	ⓐ Wood Finish		ⓑ Chassis Grain Direction	See Artisan Wood Finish Options
ⓐ Wood Finish	ⓑ Chassis Grain Direction					
See Artisan Wood Finish Options	For Artisan Only: Vertical Horizontal					

Description	D	W	H	CTN WT	CU FT	① Model	HPL Laminate	Essentials Veneer	Artisan Veneer
Rectangular Peninsula Table Desk with Frame Base and Panel End  	33½	84	29	169	56	FLT3484PDPEP	\$2,419		
	33½	84	29	169	56	FLV3484PDPEP		\$3,190	\$3,510
	33½	78	29	161	52	FLT3478PDPEP	\$2,379		
	33½	78	29	161	52	FLV3478PDPEP		\$3,135	\$3,450
	33½	72	29	153	48	FLT3472PDPEP	\$2,338		
	33½	72	29	153	48	FLV3472PDPEP		\$3,082	\$3,390
	33½	66	29	145	44	FLT3466PDPEP	\$2,300		
	33½	66	29	145	44	FLV3466PDPEP		\$3,030	\$3,333

Features:

- must be used with run-off credenza or return units, see pages 154-159
- eased edge profile on approach and user sides

Options:

- must specify support panels grain direction on artisan veneer, see pages 13-15 for details
- on laminate units, contrasting worksurface tops and chassis available, no upcharge; specify color see page 16 for details
- 13 ½”h modesty panel available, specify; add \$474 list for laminate or \$656 list for veneer; see page 21 for details
- top grommet available, specify location; add \$142 list each; see page 44 for details
- 12” wide top grommet available, specify location; add \$186 list each; see page 44 for details
- worksurface power available, specify “to accommodate EC26” on your purchase order; EC26 unit must be ordered separately, see page 44
- wire manager tray available see accessory section on pages 50-51 for details

Description	D	W	H	CTN WT	CU FT	① Model	HPL Laminate	Essentials Veneer	Artisan Veneer
Rectangular Peninsula Table	27 1/2	84	29	145	46	FLT2884PDPEP	\$2,334		
Desk with Frame Base and Panel End	27 1/2	84	29	145	46	FLV2884PDPEP		\$3,078	\$3,385
	27 1/2	78	29	139	43	FLT2878PDPEP	\$2,296		
	27 1/2	78	29	139	43	FLV2878PDPEP		\$3,027	\$3,328
	27 1/2	72	29	133	40	FLT2872PDPEP	\$2,258		
	27 1/2	72	29	133	40	FLV2872PDPEP		\$2,972	\$3,271
	27 1/2	66	29	127	37	FLT2866PDPEP	\$2,231		
	27 1/2	66	29	127	37	FLV2866PDPEP		\$2,936	\$3,231

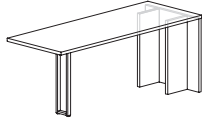

Features:

- must be used with run-off credenza or return units, see pages 154-159
- eased edge profile on approach and user sides

Options:

- must specify support panels grain direction on artisan veneer, see pages 13-15 for details
- on laminate units, contrasting worksurface tops and chassis available, no upcharge; specify color see page 16 for details
- 13 1/2" h modesty panel available, specify; add \$474 list for laminate or \$656 list for veneer; see page 21 for details
- top grommet available, specify location; add \$142 list each; see page 44 for details
- 12" wide top grommet available, specify location; add \$186 list each; see page 44 for details
- worksurface power available, specify "to accommodate EC26" on your purchase order; EC26 unit must be ordered separately, see page 44
- wire manager tray available see accessory section on pages 50-51 for details

FLUX

To Order, Specify:

① Laminate Model #	② Laminate Type	③ Laminate Selection	④ Metal Color	⑤ Other Product Options		
Laminate (FLT)	HPL	See Laminate Selection	See Metal Finish Color Options	See list of options for each specific unit; Specify and add accordingly.		
① Veneer Model #	② Wood Collection	③ Wood Finish	④ Metal Color	⑤ Other Product Options		
Veneer (FLV)	Essentials	See Essentials Wood Finish Options	See Metal Finish Color Options	See list of options for each specific unit; Specify and add accordingly.		
	Artisan	<table border="1"> <tr> <th>ⓐ Wood Finish</th> <th>ⓑ Chassis Grain Direction</th> </tr> <tr> <td>See Artisan Wood Finish Options</td> <td>For Artisan Only: Vertical Horizontal</td> </tr> </table>	ⓐ Wood Finish		ⓑ Chassis Grain Direction	See Artisan Wood Finish Options
ⓐ Wood Finish	ⓑ Chassis Grain Direction					
See Artisan Wood Finish Options	For Artisan Only: Vertical Horizontal					

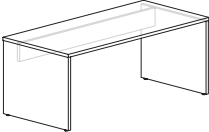
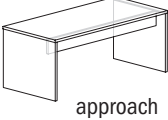
Description	D	W	H	CTN WT	CU FT	① Model	HPL Laminate	Essentials Veneer	Artisan Veneer
  approach	33½	84	29	181	56	FLT3484PDEPPR	\$1,596		
	33½	84	29	181	56	FLV3484PDEPPR		\$2,415	\$2,657
	33½	84	29	181	56	FLT3484PDEPPL	\$1,596		
	33½	84	29	181	56	FLV3484PDEPPL		\$2,415	\$2,657
	33½	78	29	172	52	FLT3478PDEPPR	\$1,558		
	33½	78	29	172	52	FLV3478PDEPPR		\$2,356	\$2,593
	33½	78	29	172	52	FLT3478PDEPPL	\$1,558		
	33½	78	29	172	52	FLV3478PDEPPL		\$2,356	\$2,593
	33½	72	29	163	48	FLT3472PDEPPR	\$1,520		
	33½	72	29	163	48	FLV3472PDEPPR		\$2,300	\$2,530
	33½	72	29	163	48	FLT3472PDEPPL	\$1,520		
	33½	72	29	163	48	FLV3472PDEPPL		\$2,300	\$2,530
	33½	66	29	154	44	FLT3466PDEPPR	\$1,499		
	33½	66	29	154	44	FLV3466PDEPPR		\$2,266	\$2,492
	33½	66	29	154	44	FLT3466PDEPPL	\$1,499		
	33½	66	29	154	44	FLV3466PDEPPL		\$2,266	\$2,492



*desks are handed when grommets are applied; see page 44

Features:

- eased edge profile on approach and user sides
- 6¾" h modesty with horizontal wire channel

Options:

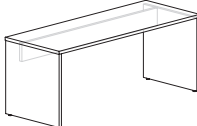
- must specify support panels grain direction on artisan veneer, see pages 13-15 for details
- on laminate units, contrasting worksurface tops and chassis available, no upcharge; specify color see page 16 for details
- top grommet available, specify location; add \$142 list each; see page 44 for details
- 12" wide top grommet available, specify location; add \$186 list each; see page 44 for details
- worksurface power available, specify "to accommodate EC26" on your purchase order; EC26 unit must be ordered separately, see page 44
- wire manager tray available see accessory section on pages 50-51 for details

Description	D	W	H	CTN WT	CU FT	① Model	HPL Laminate	Essentials Veneer	Artisan Veneer
  approach	27 1/2	84	29	154	46	FLT2884PDEPPR	\$1,509		
	27 1/2	84	29	154	46	FLV2884PDEPPR		\$2,284	\$2,512
	27 1/2	84	29	154	46	FLT2884PDEPPL	\$1,509		
	27 1/2	84	29	154	46	FLV2884PDEPPL		\$2,284	\$2,512
	27 1/2	78	29	148	43	FLT2878PDEPPR	\$1,474		
	27 1/2	78	29	148	43	FLV2878PDEPPR		\$2,228	\$2,451
	27 1/2	78	29	148	43	FLT2878PDEPPL	\$1,474		
	27 1/2	78	29	148	43	FLV2878PDEPPL		\$2,228	\$2,451
	27 1/2	72	29	142	40	FLT2872PDEPPR	\$1,436		
	27 1/2	72	29	142	40	FLV2872PDEPPR		\$2,175	\$2,392
	27 1/2	72	29	142	40	FLT2872PDEPPL	\$1,436		
	27 1/2	72	29	142	40	FLV2872PDEPPL		\$2,175	\$2,392
	27 1/2	66	29	136	37	FLT2866PDEPPR	\$1,416		
	27 1/2	66	29	136	37	FLV2866PDEPPR		\$2,141	\$2,355
27 1/2	66	29	136	37	FLT2866PDEPPL	\$1,416			
27 1/2	66	29	136	37	FLV2866PDEPPL		\$2,141	\$2,355	

*desks are handed when grommets are applied; see page 44

Features:



- eased edge profile on approach and user sides
- 6 3/4" h modesty with horizontal wire channel

Options:

- must specify support panels grain direction on artisan veneer, see pages 13-15 for details
- on laminate units, contrasting worksurface tops and chassis available, no upcharge; specify color see page 16 for details
- top grommet available, specify location; add \$142 list each; see page 44 for details
- 12" wide top grommet available, specify location; add \$186 list each; see page 44 for details
- worksurface power available, specify "to accommodate EC26" on your purchase order; EC26 unit must be ordered separately, see page 44
- wire manager tray available see accessory section on pages 50-51 for details

To Order, Specify:

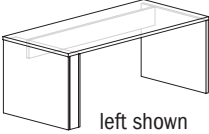
① Laminate Model #	② Laminate Type	③ Laminate Selection	④ Metal Color	⑤ Other Product Options		
Laminate (FLT)	HPL	See Laminate Selection	See Metal Finish Color Options	See list of options for each specific unit; Specify and add accordingly.		
① Veneer Model #	② Wood Collection	③ Wood Finish	④ Metal Color	⑤ Other Product Options		
Veneer (FLV)	Essentials	See Essentials Wood Finish Options	See Metal Finish Color Options	See list of options for each specific unit; Specify and add accordingly.		
	Artisan	<table border="1"> <thead> <tr> <th>ⓐ Wood Finish</th> <th>ⓑ Chassis Grain Direction</th> </tr> </thead> <tbody> <tr> <td>See Artisan Wood Finish Options</td> <td>For Artisan Only: Vertical Horizontal</td> </tr> </tbody> </table>	ⓐ Wood Finish		ⓑ Chassis Grain Direction	See Artisan Wood Finish Options
ⓐ Wood Finish	ⓑ Chassis Grain Direction					
See Artisan Wood Finish Options	For Artisan Only: Vertical Horizontal					

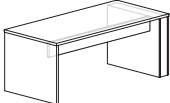
Description	D	W	H	CTN WT	CU FT	① Model	HPL Laminate	Essentials Veneer	Artisan Veneer
Rectangular Peninsula Table Desk with 6" w Full Support Panel and Panel End  left shown  left right  approach - left	33½	84	29	207	56	FLT3484PDTEPR	\$2,144		
	33½	84	29	207	56	FLV3484PDTEPR		\$3,246	\$3,572
	33½	84	29	207	56	FLT3484PDTEPL	\$2,144		
	33½	84	29	207	56	FLV3484PDTEPL		\$3,246	\$3,572
	33½	78	29	198	52	FLT3478PDTEPR	\$2,091		
	33½	78	29	198	52	FLV3478PDTEPR		\$3,167	\$3,483
	33½	78	29	198	52	FLT3478PDTEPL	\$2,091		
	33½	78	29	198	52	FLV3478PDTEPL		\$3,167	\$3,483
	33½	72	29	189	48	FLT3472PDTEPR	\$2,042		
	33½	72	29	189	48	FLV3472PDTEPR		\$3,091	\$3,400
	33½	72	29	189	48	FLT3472PDTEPL	\$2,042		
	33½	72	29	189	48	FLV3472PDTEPL		\$3,091	\$3,400
	33½	66	29	180	44	FLT3466PDTEPR	\$2,011		
	33½	66	29	180	44	FLV3466PDTEPR		\$3,043	\$3,350
	33½	66	29	180	44	FLT3466PDTEPL	\$2,011		
	33½	66	29	180	44	FLV3466PDTEPL		\$3,043	\$3,350

Features:

- eased edge profile on approach and user sides
- 6¾" h modesty with horizontal wire channel

Options:

- must specify support panels grain direction on artisan veneer, see pages 13-15 for details
- on laminate units, contrasting worksurface tops and chassis available, no upcharge; specify color see page 16 for details
- top grommet available, specify location; add \$142 list each; see page 44 for details
- 12" wide top grommet available, specify location; add \$186 list each; see page 44 for details
- worksurface power available, specify "to accommodate EC26" on your purchase order; EC26 unit must be ordered separately, see page 44
- wire manager tray available see accessory section on pages 50-51 for details

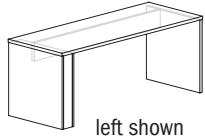
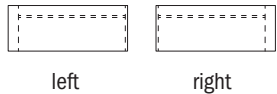
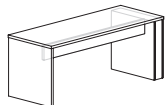
Description	D	W	H	CTN WT	CU FT	① Model	HPL Laminate	Essentials Veneer	Artisan Veneer
 left shown  left right  approach - left	27 1/2	84	29	177	46	FLT2884PDTEPR	\$2,041		
	27 1/2	84	29	177	46	FLV2884PDTEPR		\$3,087	\$3,398
	27 1/2	84	29	177	46	FLT2884PDTEPL	\$2,041		
	27 1/2	84	29	177	46	FLV2884PDTEPL		\$3,087	\$3,398
	27 1/2	78	29	171	43	FLT2878PDTEPR	\$1,992		
	27 1/2	78	29	171	43	FLV2878PDTEPR		\$3,012	\$3,315
	27 1/2	78	29	171	43	FLT2878PDTEPL	\$1,992		
	27 1/2	78	29	171	43	FLV2878PDTEPL		\$3,012	\$3,315
	27 1/2	72	29	165	40	FLT2872PDTEPR	\$1,941		
	27 1/2	72	29	165	40	FLV2872PDTEPR		\$2,942	\$3,236
	27 1/2	72	29	165	40	FLT2872PDTEPL	\$1,941		
	27 1/2	72	29	165	40	FLV2872PDTEPL		\$2,942	\$3,236
	27 1/2	66	29	159	37	FLT2866PDTEPR	\$1,914		
	27 1/2	66	29	159	37	FLV2866PDTEPR		\$2,896	\$3,187
	27 1/2	66	29	159	37	FLT2866PDTEPL	\$1,914		
27 1/2	66	29	159	37	FLV2866PDTEPL		\$2,896	\$3,187	

Features:

- eased edge profile on approach and user sides
- 6 3/4" h modesty with horizontal wire channel

Options:

- must specify support panels grain direction on artisan veneer, see pages 13-15 for details
- on laminate units, contrasting worksurface tops and chassis available, no upcharge; specify color see page 16 for details
- top grommet available, specify location; add \$142 list each; see page 44 for details
- 12" wide top grommet available, specify location; add \$186 list each; see page 44 for details
- worksurface power available, specify "to accommodate EC26" on your purchase order; EC26 unit must be ordered separately, see page 44
- wire manager tray available see accessory section on pages 50-51 for details

To Order, Specify:

① Laminate Model #	② Laminate Type	③ Laminate Selection	④ Metal Color	⑤ Other Product Options		
Laminate (FLT)	HPL	See Laminate Selection	See Metal Finish Color Options	See list of options for each specific unit; Specify and add accordingly.		
① Veneer Model #	② Wood Collection	③ Wood Finish	④ Metal Color	⑤ Other Product Options		
Veneer (FLV)	Essentials	See Essentials Wood Finish Options	See Metal Finish Color Options	See list of options for each specific unit; Specify and add accordingly.		
	Artisan	<table border="1"> <tr> <th>ⓐ Wood Finish</th> <th>ⓑ Chassis Grain Direction</th> </tr> <tr> <td>See Artisan Wood Finish Options</td> <td>For Artisan Only: Vertical Horizontal</td> </tr> </table>	ⓐ Wood Finish		ⓑ Chassis Grain Direction	See Artisan Wood Finish Options
ⓐ Wood Finish	ⓑ Chassis Grain Direction					
See Artisan Wood Finish Options	For Artisan Only: Vertical Horizontal					

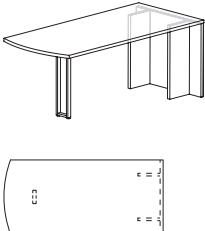

Description	D	W	H	CTN WT	CU FT	① Model	HPL Laminate	Essentials Veneer	Artisan Veneer
Arc Peninsula Table Desk with Frame Base and Panel End 	33½	84	29	169	56	FLT3484PARCPEP	\$2,615		
	33½	84	29	169	56	FLV3484PARCPEP		\$3,455	\$3,801
	33½	78	29	161	52	FLT3478PARCPEP	\$2,560		
	33½	78	29	161	52	FLV3478PARCPEP		\$3,380	\$3,719
	33½	72	29	153	48	FLT3472PARCPEP	\$2,507		
	33½	72	29	153	48	FLV3472PARCPEP		\$3,311	\$3,642
	33½	66	29	145	44	FLT3466PARCPEP	\$2,485		
	33½	66	29	145	44	FLV3466PARCPEP		\$3,280	\$3,607

Features:

- must be used with run-off credenza or return units, see pages 122-127
- eased edge profile on approach and user sides

Options:

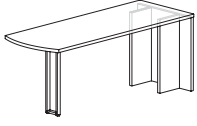
- must specify support panels grain direction on artisan veneer, see pages 13-15 for details
- on laminate units, contrasting worksurface tops and chassis available, no upcharge; specify color see page 16 for details
- 13 ½”h modesty panel available, specify; add \$474 list for laminate or \$656 list for veneer; see page 21 for details
- top grommet available, specify location; add \$142 list each; see page 44 for details
- 12” wide top grommet available, specify location; add \$186 list each; see page 44 for details
- worksurface power available, specify “to accommodate EC26” on your purchase order; EC26 unit must be ordered separately, see page 44
- wire manager tray available see accessory section on pages 50-51 for details

Description	D	W	H	CTN WT	CU FT	① Model	HPL Laminate	Essentials Veneer	Artisan Veneer
 	27 1/2	84	29	145	46	FLT2884PARCPEP	\$2,531		
	27 1/2	84	29	145	46	FLV2884PARCPEP		\$3,339	\$3,675
	27 1/2	78	29	139	43	FLT2878PARCPEP	\$2,477		
	27 1/2	78	29	139	43	FLV2878PARCPEP		\$3,271	\$3,600
	27 1/2	72	29	133	40	FLT2872PARCPEP	\$2,425		
	27 1/2	72	29	133	40	FLV2872PARCPEP		\$3,200	\$3,521
	27 1/2	66	29	127	37	FLT2866PARCPEP	\$2,406		
	27 1/2	66	29	127	37	FLV2866PARCPEP		\$3,171	\$3,490

Features:

- must be used with run-off credenza or return units, see pages 122-127
- eased edge profile on approach and user sides

Options:

- must specify support panels grain direction on artisan veneer, see pages 13-15 for details
- on laminate units, contrasting worksurface tops and chassis available, no upcharge; specify color see page 16 for details
- 13 1/2" h modesty panel available, specify; add \$474 list for laminate or \$656 list for veneer; see page 21 for details
- top grommet available, specify location; add \$142 list each; see page 44 for details
- 12" wide top grommet available, specify location; add \$186 list each; see page 44 for details
- worksurface power available, specify "to accommodate EC26" on your purchase order; EC26 unit must be ordered separately, see page 44
- wire manager tray available see accessory section on pages 50-51 for details

FLUX

To Order, Specify:

① Laminate Model #	② Laminate Type	③ Laminate Selection	④ Metal Color	⑤ Other Product Options		
Laminate (FLT)	HPL	See Laminate Selection	See Metal Finish Color Options	See list of options for each specific unit; Specify and add accordingly.		
① Veneer Model #	② Wood Collection	③ Wood Finish	④ Metal Color	⑤ Other Product Options		
Veneer (FLV)	Essentials	See Essentials Wood Finish Options	See Metal Finish Color Options	See list of options for each specific unit; Specify and add accordingly.		
	Artisan	<table border="1"> <thead> <tr> <th>ⓐ Wood Finish</th> <th>ⓑ Chassis Grain Direction</th> </tr> </thead> <tbody> <tr> <td>See Artisan Wood Finish Options</td> <td>For Artisan Only: Vertical Horizontal</td> </tr> </tbody> </table>	ⓐ Wood Finish		ⓑ Chassis Grain Direction	See Artisan Wood Finish Options
ⓐ Wood Finish	ⓑ Chassis Grain Direction					
See Artisan Wood Finish Options	For Artisan Only: Vertical Horizontal					

Description	D	W	H	CTN WT	CU FT	① Model	HPL Laminate	Essentials Veneer	Artisan Veneer
Boomerang Peninsula Table Desk with End Leg Assembly and Panel End	33½	84	29	169	56	FLT3484PBMNEPR	\$3,320		
	33½	84	29	169	56	FLV3484PBMNEPR		\$4,408	\$4,849
	33½	84	29	169	56	FLT3484PBMNEPL	\$3,320		
	33½	84	29	169	56	FLV3484PBMNEPL		\$4,408	\$4,849
	33½	78	29	161	52	FLT3478PBMNEPR	\$3,247		
	33½	78	29	161	52	FLV3478PBMNEPR		\$4,312	\$4,740
	33½	78	29	161	52	FLT3478PBMNEPL	\$3,247		
	33½	78	29	161	52	FLV3478PBMNEPL		\$4,312	\$4,740
	33½	72	29	153	48	FLT3472PBMNEPR	\$3,176		
	33½	72	29	153	48	FLV3472PBMNEPR		\$4,217	\$4,638
	33½	72	29	153	48	FLT3472PBMNEPL	\$3,176		
	33½	72	29	153	48	FLV3472PBMNEPL		\$4,217	\$4,638
	33½	66	29	145	44	FLT3466PBMNEPR	\$3,135		
	33½	66	29	145	44	FLV3466PBMNEPR		\$4,158	\$4,576
	33½	66	29	145	44	FLT3466PBMNEPL	\$3,135		
	33½	66	29	145	44	FLV3466PBMNEPL		\$4,158	\$4,576

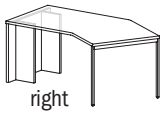
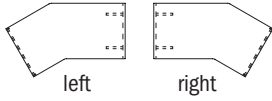
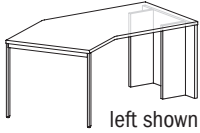

Features:

- must be used with run-off credenza or return units, see pages 122-127
- eased edge profile on approach and user sides

Options:

- must specify support panels grain direction on artisan veneer, see pages 13-15 for details
- on laminate units, contrasting worksurface tops and chassis available, no upcharge; specify color see page 16 for details
- 13 ½" h modesty panel available for 84" w and 78" w desk, specify; add \$474 list for laminate or \$656 list for veneer; see page 21 for details
- top grommet available, specify location; add \$142 list each; see page 44 for details
- 12" wide top grommet available, specify location; add \$186 list each; see page 44 for details
- worksurface power available, specify "to accommodate EC26" on your purchase order; EC26 unit must be ordered separately, see page 44
- wire manager tray available see accessory section on pages 50-51 for details

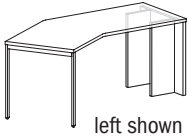
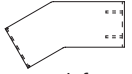
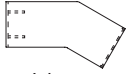
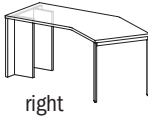
Description	D	W	H	CTN WT	CU FT	① Model	HPL Laminate	Essentials Veneer	Artisan Veneer
Boomerang Peninsula Table Desk with End Leg Assembly and Panel End  left shown  left  right  right	27 1/2	84	29	145	46	FLT2884PBMNEPR	\$3,255		
	27 1/2	84	29	145	46	FLV2884PBMNEPR		\$4,321	\$4,756
	27 1/2	84	29	145	46	FLT2884PBMNEPL	\$3,255		
	27 1/2	84	29	145	46	FLV2884PBMNEPL		\$4,321	\$4,756
	27 1/2	78	29	139	43	FLT2878PBMNEPR	\$3,187		
	27 1/2	78	29	139	43	FLV2878PBMNEPR		\$4,227	\$4,650
	27 1/2	78	29	133	43	FLT2878PBMNEPL	\$3,187		
	27 1/2	78	29	133	43	FLV2878PBMNEPL		\$4,227	\$4,650
	27 1/2	72	29	133	40	FLT2872PBMNEPR	\$3,117		
	27 1/2	72	29	133	40	FLV2872PBMNEPR		\$4,134	\$4,547
	27 1/2	72	29	133	40	FLT2872PBMNEPL	\$3,117		
	27 1/2	72	29	133	40	FLV2872PBMNEPL		\$4,134	\$4,547
	27 1/2	66	29	127	37	FLT2866PBMNEPR	\$3,060		
	27 1/2	66	29	127	37	FLV2866PBMNEPR		\$4,078	\$4,486
	27 1/2	66	29	127	37	FLT2866PBMNEPL	\$3,060		
27 1/2	66	29	127	37	FLV2866PBMNEPL		\$4,078	\$4,486	

Features:

- must be used with run-off credenza or return units, see pages 122-127
- eased edge profile on approach and user sides

Options:

- must specify support panels grain direction on artisan veneer, see pages 13-15 for details
- on laminate units, contrasting worksurface tops and chassis available, no upcharge; specify color see page 16 for details
- 13 1/2" h modesty panel available for 84" w and 78" w desk, specify; add \$474 list for laminate or \$656 list for veneer; see page 21 for details
- top grommet available, specify location; add \$142 list each; see page 44 for details
- 12" wide top grommet available, specify location; add \$186 list each; see page 44 for details
- worksurface power available, specify "to accommodate EC26" on your purchase order; EC26 unit must be ordered separately, see page 44
- wire manager tray available see accessory section on pages 50-51 for details

To Order, Specify:

① Laminate Model #	② Laminate Type	③ Laminate Selection	④ Metal Color	⑤ Other Product Options		
Laminate (FLT)	HPL	See Laminate Selection	See Metal Finish Color Options	See list of options for each specific unit; Specify and add accordingly.		
① Veneer Model #	② Wood Collection	③ Wood Finish	④ Metal Color	⑤ Other Product Options		
Veneer (FLV)	Essentials	See Essentials Wood Finish Options	See Metal Finish Color Options	See list of options for each specific unit; Specify and add accordingly.		
	Artisan	<table border="1"> <thead> <tr> <th>ⓐ Wood Finish</th> <th>ⓑ Chassis Grain Direction</th> </tr> </thead> <tbody> <tr> <td>See Artisan Wood Finish Options</td> <td>For Artisan Only: Vertical Horizontal</td> </tr> </tbody> </table>	ⓐ Wood Finish		ⓑ Chassis Grain Direction	See Artisan Wood Finish Options
ⓐ Wood Finish	ⓑ Chassis Grain Direction					
See Artisan Wood Finish Options	For Artisan Only: Vertical Horizontal					

Description	D	W	H	CTN WT	CU FT	① Model	HPL Laminate	Essentials Veneer	Artisan Veneer
Rectangular Peninsula Table Desk with End Leg Assembly and Secondary Support End	33½	84	29	149	31	FLT3484PDN	\$2,279		
	33½	84	29	149	31	FLV3484PDN		\$2,999	\$3,301
	33½	78	29	140	28	FLT3478PDN	\$2,239		
	33½	78	29	140	28	FLV3478PDN		\$2,948	\$3,241
	33½	72	29	131	26	FLT3472PDN	\$2,198		
	33½	72	29	131	26	FLV3472PDN		\$2,892	\$3,181
	33½	66	29	122	24	FLT3466PDN	\$2,159		
	33½	66	29	122	24	FLV3466PDN		\$2,839	\$3,124

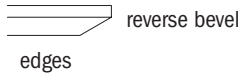
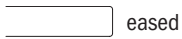
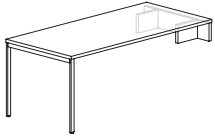

Features:

- peninsula desk mounting included in the list price of the unit, but must be specified when ordering secondary credenza; see pages 18-20 for details
- eased edge profile on approach and user sides

Options:

- must specify support panels grain direction on artisan veneer, see pages 13-15 for details
- on laminate units, contrasting worksurface tops and chassis available, no upcharge; specify color see page 16 for details
- reverse bevel edge available on three sides, specify; add \$474 list for laminate or \$186 list for veneer; see page 8 for details
- 13 ½" h modesty panel available, specify; add \$474 list for laminate or \$656 list for veneer; see page 21 for details
- top grommet available, specify location; add \$142 list each; see page 47 for details
- 12" wide top grommet available, specify location; add \$186 list each; see page 44 for details
- worksurface power available, specify "to accommodate EC26" on your purchase order; EC26 unit must be ordered separately, see page 44
- wire manager tray available see accessory section on pages 50-51 for details

Description	D	W	H	CTN WT	CU FT	① Model	HPL Laminate	Essentials Veneer	Artisan Veneer
Rectangular Peninsula Table	27 1/2	84	29	128	25	FLT2884PDN	\$2,196		
Desk with End Leg Assembly and Secondary Support End	27 1/2	84	29	128	25	FLV2884PDN		\$2,886	\$3,176
	27 1/2	78	29	122	24	FLT2878PDN	\$2,156		
	27 1/2	78	29	122	24	FLV2878PDN		\$2,835	\$3,119
	27 1/2	72	29	116	22	FLT2872PDN	\$2,117		
	27 1/2	72	29	116	22	FLV2872PDN		\$2,784	\$3,063
	27 1/2	66	29	110	20	FLT2866PDN	\$2,090		
	27 1/2	66	29	110	20	FLV2866PDN		\$2,747	\$3,021

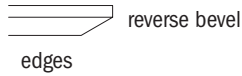
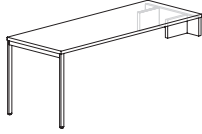

Features:

- peninsula desk mounting included in the list price of the unit, but must be specified when ordering secondary credenza; see pages 18-20 for details
- eased edge profile on approach and user sides

Options:

- must specify support panels grain direction on artisan veneer, see pages 13-15 for details
- on laminate units, contrasting worksurface tops and chassis available, no upcharge; specify color see page 16 for details
- reverse bevel edge available on three sides, specify; add \$474 list for laminate or \$186 list for veneer; see page 8 for details
- 13 1/2" h modesty panel available, specify; add \$474 list for laminate or \$656 list for veneer; see page 21 for details
- top grommet available, specify location; add \$142 list each; see page 47 for details
- 12" wide top grommet available, specify location; add \$186 list each; see page 44 for details
- worksurface power available, specify "to accommodate EC26" on your purchase order; EC26 unit must be ordered separately, see page 44
- wire manager tray available see accessory section on pages 50-51 for details

To Order, Specify:

① Laminate Model #	② Laminate Type	③ Laminate Selection	④ Metal Color	⑤ Other Product Options	
Laminate (FLT)	HPL	See Laminate Selection	See Metal Finish Color Options	See list of options for each specific unit; Specify and add accordingly.	
① Veneer Model #	② Wood Collection	③ Wood Finish	④ Metal Color	⑤ Other Product Options	
Veneer (FLV)	Essentials	See Essentials Wood Finish Options	See Metal Finish Color Options	See list of options for each specific unit; Specify and add accordingly.	
	Artisan	<table border="1"> <tr> <th>ⓐ Wood Finish</th> <th>ⓑ Chassis Grain Direction</th> </tr> <tr> <td>See Artisan Wood Finish Options</td> <td>For Artisan Only: Vertical Horizontal</td> </tr> </table>			ⓐ Wood Finish
ⓐ Wood Finish	ⓑ Chassis Grain Direction				
See Artisan Wood Finish Options	For Artisan Only: Vertical Horizontal				

Description	D	W	H	CTN WT	CU FT	① Model	HPL Laminate	Essentials Veneer	Artisan Veneer
Rectangular Peninsula Table Desk with Frame Base and Secondary Support End	33½	84	29	149	31	FLT3484PDP	\$2,279		
	33½	84	29	149	31	FLV3484PDP		\$2,999	\$3,301
	33½	78	29	140	28	FLT3478PDP	\$2,239		
	33½	78	29	140	28	FLV3478PDP		\$2,948	\$3,241
	33½	72	29	131	26	FLT3472PDP	\$2,198		
	33½	72	29	131	26	FLV3472PDP		\$2,892	\$3,181
	33½	66	29	122	24	FLT3466PDP	\$2,159		
	33½	66	29	122	24	FLV3466PDP		\$2,839	\$3,124

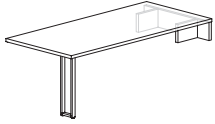

eased



reverse bevel

edges

Features:

- peninsula desk mounting included in the list price of the unit, but must be specified when ordering secondary credenza; see pages 18-20 for details
- eased edge profile on approach and user sides

Options:

- must specify support panels grain direction on artisan veneer, see pages 13-15 for details
- on laminate units, contrasting worksurface tops and chassis available, no upcharge; specify color see page 16 for details
- reverse bevel edge available on three sides, specify; add \$474 list for laminate or \$186 list for veneer; see page 8 for details
- 13 ½" h modesty panel available, specify; add \$474 list for laminate or \$656 list for veneer; see page 21 for details
- top grommet available, specify location; add \$142 list each; see page 47 for details
- 12" wide top grommet available, specify location; add \$186 list each; see page 44 for details
- worksurface power available, specify "to accommodate EC26" on your purchase order; EC26 unit must be ordered separately, see page 44
- wire manager tray available see accessory section on pages 50-51 for details

Description	D	W	H	CTN WT	CU FT	① Model	HPL Laminate	Essentials Veneer	Artisan Veneer
	27 1/2	84	29	128	25	FLT2884PDP	\$2,196		
	27 1/2	84	29	128	25	FLV2884PDP		\$2,886	\$3,176
	27 1/2	78	29	122	24	FLT2878PDP	\$2,156		
	27 1/2	78	29	122	24	FLV2878PDP		\$2,835	\$3,119
	27 1/2	72	29	116	22	FLT2872PDP	\$2,117		
	27 1/2	72	29	116	22	FLV2872PDP		\$2,784	\$3,063
	27 1/2	66	29	110	20	FLT2866PDP	\$2,090		
	27 1/2	66	29	110	20	FLV2866PDP		\$2,747	\$3,021

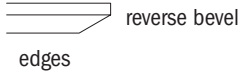

Features:

- peninsula desk mounting included in the list price of the unit, but must be specified when ordering secondary credenza; see pages 18-20 for details
- eased edge profile on approach and user sides

Options:

- must specify support panels grain direction on artisan veneer, see pages 13-15 for details
- on laminate units, contrasting worksurface tops and chassis available, no upcharge; specify color see page 16 for details
- reverse bevel edge available on three sides, specify; add \$474 list for laminate or \$186 list for veneer; see page 8 for details
- 13 1/2" h modesty panel available, specify; add \$474 list for laminate or \$656 list for veneer; see page 21 for details
- top grommet available, specify location; add \$142 list each; see page 47 for details
- 12" wide top grommet available, specify location; add \$186 list each; see page 44 for details
- worksurface power available, specify "to accommodate EC26" on your purchase order; EC26 unit must be ordered separately, see page 44
- wire manager tray available see accessory section on pages 50-51 for details

FLUX

To Order, Specify:

① Laminate Model #	② Laminate Type	③ Laminate Selection	④ Metal Color	⑤ Other Product Options		
Laminate (FLT)	HPL	See Laminate Selection	See Metal Finish Color Options	See list of options for each specific unit; Specify and add accordingly.		
① Veneer Model #	② Wood Collection	③ Wood Finish	④ Metal Color	⑤ Other Product Options		
Veneer (FLV)	Essentials	See Essentials Wood Finish Options	See Metal Finish Color Options	See list of options for each specific unit; Specify and add accordingly.		
	Artisan	<table border="1"> <thead> <tr> <th>③a Wood Finish</th> <th>③b Chassis Grain Direction</th> </tr> </thead> <tbody> <tr> <td>See Artisan Wood Finish Options</td> <td>For Artisan Only: Vertical Horizontal</td> </tr> </tbody> </table>	③a Wood Finish		③b Chassis Grain Direction	See Artisan Wood Finish Options
③a Wood Finish	③b Chassis Grain Direction					
See Artisan Wood Finish Options	For Artisan Only: Vertical Horizontal					

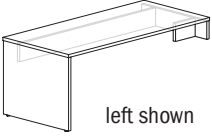
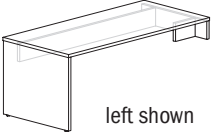
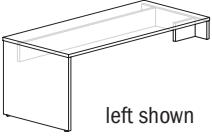
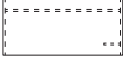
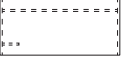
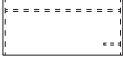
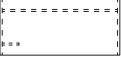
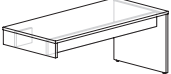
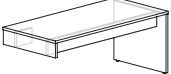
Description	D	W	H	CTN WT	CU FT	① Model	HPL Laminate	Essentials Veneer	Artisan Veneer
Rectangular Peninsula Table	33½	84	29	163	56	FLT3484PDEPR	\$1,594		
Desk with Full Support Panel and Secondary Support End	33½	84	29	163	56	FLV3484PDEPR		\$2,412	\$2,653
	33½	84	29	163	56	FLT3484PDEPL	\$1,594		
	33½	84	29	163	56	FLV3484PDEPL		\$2,412	\$2,653
	33½	78	29	154	52	FLT3478PDEPR	\$1,556		
	33½	78	29	154	52	FLV3478PDEPR		\$2,351	\$2,589
	33½	78	29	154	52	FLT3478PDEPL	\$1,556		
	33½	78	29	154	52	FLV3478PDEPL		\$2,351	\$2,589
	33½	72	29	146	48	FLT3472PDEPR	\$1,516		
 	33½	72	29	146	48	FLV3472PDEPR		\$2,293	\$2,525
	33½	72	29	146	48	FLT3472PDEPL	\$1,516		
 	33½	72	29	146	48	FLV3472PDEPL		\$2,293	\$2,525
	33½	66	29	158	44	FLT3466PDEPR	\$1,486		
	33½	66	29	158	44	FLV3466PDEPR		\$2,250	\$2,474
	33½	66	29	158	44	FLT3466PDEPL	\$1,486		
	33½	66	29	158	44	FLV3466PDEPL		\$2,250	\$2,474



Features:

- peninsula desk mounting included in the list price of the unit, but must be specified when ordering secondary credenza; see pages 18-20 for details
- eased edge profile on approach and user sides
- 6¾”h modesty with horizontal wire channel

Options:

- must specify support panels grain direction on artisan veneer, see pages 13-15 for details
- on laminate units, contrasting worksurface tops and drawer fronts available, no upcharge; specify laminate color, see page 16 for details
- top grommet available, specify location; add \$142 list each; see page 44 for details
- 12” wide top grommet available, specify location; add \$186 list each; see page 44 for details
- worksurface power available, specify “to accommodate EC26” on your purchase order; EC26 unit must be ordered separately, see page 44
- wire manager tray available see accessory section on pages 50-51 for details

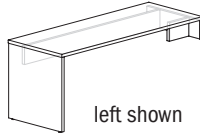
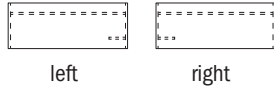
FLUX

Description	D	W	H	CTN WT	CU FT	① Model	HPL Laminate	Essentials Veneer	Artisan Veneer
Rectangular Peninsula Table	27 1/2	84	29	144	46	FLT2884PDEPR	\$1,318		
Desk with Full Support Panel and Secondary Support End	27 1/2	84	29	144	46	FLV2884PDEPR		\$1,995	\$2,196
	27 1/2	84	29	144	46	FLT2884PDEPL	\$1,318		
 left shown  left right  approach - left	27 1/2	84	29	144	46	FLV2884PDEPL		\$1,995	\$2,196
	27 1/2	78	29	137	43	FLT2878PDEPR	\$1,287		
	27 1/2	78	29	137	43	FLV2878PDEPR		\$1,947	\$2,141
	27 1/2	78	29	137	43	FLT2878PDEPL	\$1,287		
	27 1/2	78	29	137	43	FLV2878PDEPL		\$1,947	\$2,141
	27 1/2	72	29	130	40	FLT2872PDEPR	\$1,255		
	27 1/2	72	29	130	40	FLV2872PDEPR		\$1,900	\$2,090
	27 1/2	72	29	130	40	FLT2872PDEPL	\$1,255		
	27 1/2	72	29	130	40	FLV2872PDEPL		\$1,900	\$2,090
	27 1/2	66	29	123	37	FLT2866PDEPR	\$1,231		
	27 1/2	66	29	123	37	FLV2866PDEPR		\$1,862	\$2,047
	27 1/2	66	29	123	37	FLT2866PDEPL	\$1,231		
	27 1/2	66	29	123	37	FLV2866PDEPL		\$1,862	\$2,047

Features:

- peninsula desk mounting included in the list price of the unit, but must be specified when ordering secondary credenza; see pages 18-20 for details
- eased edge profile on approach and user sides
- 6 3/4" h modesty with horizontal wire channel



Options:

- must specify support panels grain direction on artisan veneer, see pages 13-15 for details
- on laminate units, contrasting worksurface tops and drawer fronts available, no upcharge; specify laminate color, see page 16 for details
- top grommet available, specify location; add \$142 list each; see page 44 for details
- 12" wide top grommet available, specify location; add \$186 list each; see page 44 for details
- worksurface power available, specify "to accommodate EC26" on your purchase order; EC26 unit must be ordered separately, see page 44
- wire manager tray available see accessory section on pages 50-51 for details

To Order, Specify:

① Laminate Model #	② Laminate Type	③ Laminate Selection	④ Metal Color	⑤ Other Product Options
Laminate (FLT)	HPL	See Laminate Selection	See Metal Finish Color Options	See list of options for each specific unit; Specify and add accordingly.
① Veneer Model #	② Wood Collection	③ Wood Finish	④ Metal Color	⑤ Other Product Options
Veneer (FLV)	Essentials	See Essentials Wood Finish Options	See Metal Finish Color Options	See list of options for each specific unit; Specify and add accordingly.
	Artisan	ⓐ Wood Finish See Artisan Wood Finish Options	ⓑ Chassis Grain Direction For Artisan Only: Vertical Horizontal	

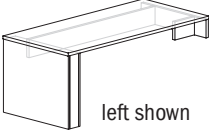
FLUX

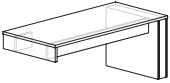
Description	D	W	H	CTN WT	CU FT	① Model	HPL Laminate	Essentials Veneer	Artisan Veneer
Rectangular Peninsula Table Desk with 6" w Full Support Panel and Secondary Support End     approach - left	33½	84	29	189	56	FLT3484DTEPR	\$2,141		
	33½	84	29	189	56	FLV3484DTEPR		\$3,241	\$3,565
	33½	84	29	189	56	FLT3484DTEPL	\$2,141		
	33½	84	29	189	56	FLV3484DTEPL		\$3,241	\$3,565
	33½	78	29	181	52	FLT3478DTEPR	\$2,088		
	33½	78	29	181	52	FLV3478DTEPR		\$3,163	\$3,478
	33½	78	29	181	52	FLT3478DTEPL	\$2,088		
	33½	78	29	181	52	FLV3478DTEPL		\$3,163	\$3,478
	33½	72	29	173	48	FLT3472DTEPR	\$2,040		
	33½	72	29	173	48	FLV3472DTEPR		\$3,085	\$3,394
	33½	72	29	173	48	FLT3472DTEPL	\$2,040		
	33½	72	29	173	48	FLV3472DTEPL		\$3,085	\$3,394
	33½	66	29	165	44	FLT3466DTEPR	\$1,997		
	33½	66	29	165	44	FLV3466DTEPR		\$3,026	\$3,326
	33½	66	29	165	44	FLT3466DTEPL	\$1,997		
	33½	66	29	165	44	FLV3466DTEPL		\$3,026	\$3,326

Features:

- peninsula desk mounting included in the list price of the unit, but must be specified when ordering secondary credenza; see pages 18-20 for details
- eased edge profile on approach and user sides
- 6¾" h modesty with horizontal wire channel

Options:

- must specify support panels grain direction on artisan veneer, see pages 13-15 for details
- on laminate units, contrasting worksurface tops and drawer fronts available, no upcharge; specify laminate color, see page 16 for details
- top grommet available, specify location; add \$142 list each; see page 44 for details
- 12" wide top grommet available, specify location; add \$186 list each; see page 44 for details
- worksurface power available, specify "to accommodate EC26" on your purchase order; EC26 unit must be ordered separately, see page 44
- wire manager tray available see accessory section on pages 50-51 for details

FLUX

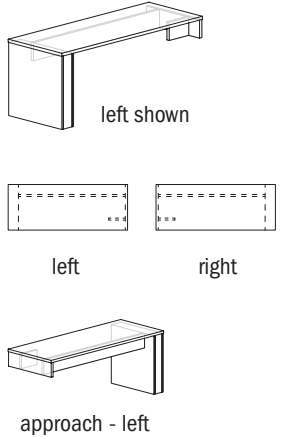
Description	D	W	H	CTN WT	CU FT	① Model	HPL Laminate	Essentials Veneer	Artisan Veneer
 <p>left shown</p> <p>left right</p> <p>approach - left</p>	27 1/2	84	29	162	46	FLT2884DTEPR	\$1,847		
	27 1/2	84	29	162	46	FLV2884DTEPR		\$2,800	\$3,080
	27 1/2	84	29	162	46	FLT2884DTEPL	\$1,847		
	27 1/2	84	29	162	46	FLV2884DTEPL		\$2,800	\$3,080
	27 1/2	78	29	155	43	FLT2878DTEPR	\$1,802		
	27 1/2	78	29	155	43	FLV2878DTEPR		\$2,733	\$3,005
	27 1/2	78	29	155	43	FLT2878DTEPL	\$1,802		
	27 1/2	78	29	155	43	FLV2878DTEPL		\$2,733	\$3,005
	27 1/2	72	29	148	40	FLT2872DTEPR	\$1,761		
	27 1/2	72	29	148	40	FLV2872DTEPR		\$2,665	\$2,930
	27 1/2	72	29	148	40	FLT2872DTEPL	\$1,761		
	27 1/2	72	29	148	40	FLV2872DTEPL		\$2,665	\$2,930
	27 1/2	66	29	141	37	FLT2866DTEPR	\$1,726		
	27 1/2	66	29	141	37	FLV2866DTEPR		\$2,612	\$2,874
	27 1/2	66	29	141	37	FLT2866DTEPL	\$1,726		
	27 1/2	66	29	141	37	FLV2866DTEPL		\$2,612	\$2,874

Features:



- peninsula desk mounting included in the list price of the unit, but must be specified when ordering secondary credenza; see pages 18-20 for details
- eased edge profile on approach and user sides
- 6 3/4" h modesty with horizontal wire channel

Options:

- must specify support panels grain direction on artisan veneer, see pages 13-15 for details
- on laminate units, contrasting worksurface tops and drawer fronts available, no upcharge; specify laminate color, see page 16 for details
- top grommet available, specify location; add \$142 list each; see page 44 for details
- 12" wide top grommet available, specify location; add \$186 list each; see page 44 for details
- worksurface power available, specify "to accommodate EC26" on your purchase order; EC26 unit must be ordered separately, see page 44
- wire manager tray available see accessory section on pages 50-51 for details

To Order, Specify:

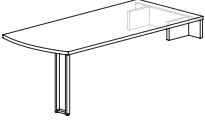
① Laminate Model #	② Laminate Type	③ Laminate Selection	④ Metal Color	⑤ Other Product Options		
Laminate (FLT)	HPL	See Laminate Selection	See Metal Finish Color Options	See list of options for each specific unit; Specify and add accordingly.		
① Veneer Model #	② Wood Collection	③ Wood Finish	④ Metal Color	⑤ Other Product Options		
Veneer (FLV)	Essentials	See Essentials Wood Finish Options	See Metal Finish Color Options	See list of options for each specific unit; Specify and add accordingly.		
	Artisan	<table border="1"> <thead> <tr> <th>ⓐ Wood Finish</th> <th>ⓑ Chassis Grain Direction</th> </tr> </thead> <tbody> <tr> <td>See Artisan Wood Finish Options</td> <td>For Artisan Only: Vertical Horizontal</td> </tr> </tbody> </table>	ⓐ Wood Finish		ⓑ Chassis Grain Direction	See Artisan Wood Finish Options
ⓐ Wood Finish	ⓑ Chassis Grain Direction					
See Artisan Wood Finish Options	For Artisan Only: Vertical Horizontal					

Description	D	W	H	CTN WT	CU FT	① Model	HPL Laminate	Essentials Veneer	Artisan Veneer
Arc Peninsula Table Desk with Frame Base and Secondary Support End 	33½	84	29	149	31	FLT3484PARCP	\$2,474		
	33½	84	29	149	31	FLV3484PARCP		\$3,268	\$3,593
	33½	78	29	140	28	FLT3478PARCP	\$2,421		
	33½	78	29	140	28	FLV3478PARCP		\$3,191	\$3,511
	33½	72	29	131	26	FLT3472PARCP	\$2,367		
	33½	72	29	131	26	FLV3472PARCP		\$3,119	\$3,432
	33½	66	29	122	24	FLT3466PARCP	\$2,345		
	33½	66	29	122	24	FLV3466PARCP		\$3,091	\$3,400
									

Features:

- peninsula desk mounting included in the list price of the unit, but must be specified when ordering secondary credenza; see pages 18-20 for details
- eased edge profile on approach and user sides

Options:

- must specify support panels grain direction on artisan veneer, see pages 13-15 for details
- on laminate units, contrasting worksurface tops and chassis available, no upcharge; specify color see page 16 for details
- reverse bevel edge available on three sides, specify; add \$474 list for laminate or \$186 list for veneer; see page 8 for details
- 13 ½" h modesty panel available, specify; add \$474 list for laminate or \$656 list for veneer; see page 21 for details
- top grommet available, specify location; add \$142 list each; see page 47 for details
- 12" wide top grommet available, specify location; add \$186 list each; see page 44 for details
- worksurface power available, specify "to accommodate EC26" on your purchase order; EC26 unit must be ordered separately, see page 44
- wire manager tray available see accessory section on pages 50-51 for details



eased



reverse bevel

edges

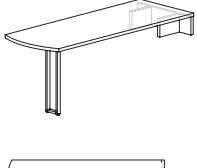
Description	D	W	H	CTN WT	CU FT	① Model	HPL Laminate	Essentials Veneer	Artisan Veneer
	27 1/2	84	29	128	25	FLT2884PARCP	\$2,391		
	27 1/2	84	29	128	25	FLV2884PARCP		\$3,153	\$3,467
	27 1/2	78	29	122	24	FLT2878PARCP	\$2,338		
	27 1/2	78	29	122	24	FLV2878PARCP		\$3,082	\$3,390
	27 1/2	72	29	116	22	FLT2872PARCP	\$2,285		
	27 1/2	72	29	116	22	FLV2872PARCP		\$3,011	\$3,314
	27 1/2	66	29	110	20	FLT2866PARCP	\$2,266		
	27 1/2	66	29	110	20	FLV2866PARCP		\$2,984	\$3,282

Features:

- peninsula desk mounting included in the list price of the unit, but must be specified when ordering secondary credenza; see pages 18-20 for details
- eased edge profile on approach and user sides

Options:

- must specify support panels grain direction on artisan veneer, see pages 13-15 for details
- on laminate units, contrasting worksurface tops and chassis available, no upcharge; specify color see page 16 for details
- reverse bevel edge available on three sides, specify; add \$474 list for laminate or \$186 list for veneer; see page 8 for details
- 13 1/2" h modesty panel available, specify; add \$474 list for laminate or \$656 list for veneer; see page 21 for details
- top grommet available, specify location; add \$142 list each; see page 47 for details
- 12" wide top grommet available, specify location; add \$186 list each; see page 44 for details
- worksurface power available, specify "to accommodate EC26" on your purchase order; EC26 unit must be ordered separately, see page 44
- wire manager tray available see accessory section on pages 50-51 for details

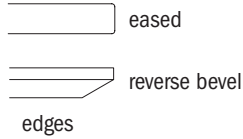

FLUX

To Order, Specify:

① Laminate Model #	② Laminate Type	③ Laminate Selection	④ Metal Color	⑤ Other Product Options		
Laminate (FLT)	HPL	See Laminate Selection	See Metal Finish Color Options	See list of options for each specific unit; Specify and add accordingly.		
① Veneer Model #	② Wood Collection	③ Wood Finish	④ Metal Color	⑤ Other Product Options		
Veneer (FLV)	Essentials	See Essentials Wood Finish Options	See Metal Finish Color Options	See list of options for each specific unit; Specify and add accordingly.		
	Artisan	<table border="1"> <tr> <th>ⓐ Wood Finish</th> <th>ⓑ Chassis Grain Direction</th> </tr> <tr> <td>See Artisan Wood Finish Options</td> <td>For Artisan Only: Vertical Horizontal</td> </tr> </table>	ⓐ Wood Finish		ⓑ Chassis Grain Direction	See Artisan Wood Finish Options
ⓐ Wood Finish	ⓑ Chassis Grain Direction					
See Artisan Wood Finish Options	For Artisan Only: Vertical Horizontal					

Description	D	W	H	CTN WT	CU FT	① Model	HPL Laminate	Essentials Veneer	Artisan Veneer
Boomerang Peninsula Table Desk with End Leg Assembly and Secondary Support End	33½	84	29	149	31	FLT3484PBMNR	\$2,964		
	33½	84	29	149	31	FLV3484PBMNR		\$4,002	\$4,402
	33½	84	29	149	31	FLT3484PBMNL	\$2,964		
	33½	84	29	149	31	FLV3484PBMNL		\$4,002	\$4,402
	33½	78	29	140	28	FLT3478PBMNR	\$2,891		
	33½	78	29	140	28	FLV3478PBMNR		\$3,905	\$4,294
	33½	78	29	140	28	FLT3478PBMNL	\$2,891		
	33½	78	29	140	28	FLV3478PBMNL		\$3,905	\$4,294
	33½	72	29	131	26	FLT3472PBMNR	\$2,822		
	33½	72	29	131	26	FLV3472PBMNR		\$3,810	\$4,192
	33½	72	29	131	26	FLT3472PBMNL	\$2,822		
	33½	72	29	131	26	FLV3472PBMNL		\$3,810	\$4,192
	33½	66	29	122	24	FLT3466PBMNR	\$2,778		
	33½	66	29	122	24	FLV3466PBMNR		\$3,752	\$4,129
	33½	66	29	122	24	FLT3466PBMNL	\$2,778		
	33½	66	29	122	24	FLV3466PBMNL		\$3,752	\$4,129

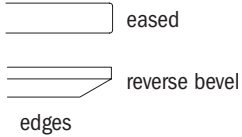
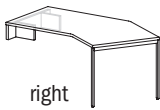
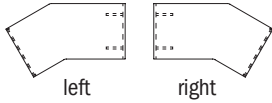
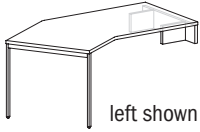

Features:

- peninsula desk mounting included in the list price of the unit, but must be specified when ordering secondary credenza; see pages 18-20 for details
- eased edge profile on approach and user sides

Options:

- must specify support panels grain direction on artisan veneer, see pages 13-15 for details
- on laminate units, contrasting worksurface tops and chassis available, no upcharge; specify color see page 16 for details
- reverse bevel edge available on three sides, specify; add \$474 list for laminate or \$186 list for veneer; see page 8 for details
- 13½" h modesty panel available for 84" w and 78" w desk, specify; add \$474 list for laminate or \$656 list for veneer; see page 21 for details
- top grommet available, specify location; add \$142 list each; see page 44 for details
- 12" wide top grommet available, specify location; add \$186 list each; see page 44 for details
- worksurface power available, specify "to accommodate EC26" on your purchase order; EC26 unit must be ordered separately, see page 44
- wire manager tray available see accessory section on pages 50-51 for details

Description	D	W	H	CTN WT	CU FT	① Model	HPL Laminate	Essentials Veneer	Artisan Veneer
Boomerang Peninsula Table	27 1/2	84	29	128	25	FLT2884PBMNR	\$2,901		
Desk with End Leg Assembly and Secondary Support End	27 1/2	84	29	128	25	FLV2884PBMNR		\$3,917	\$4,308
	27 1/2	84	29	128	25	FLT2884PBMNL	\$2,901		
	27 1/2	84	29	128	25	FLV2884PBMNL		\$3,917	\$4,308
	27 1/2	78	29	122	24	FLT2878PBMNR	\$2,829		
	27 1/2	78	29	122	24	FLV2878PBMNR		\$3,820	\$4,204
	27 1/2	78	29	122	24	FLT2878PBMNL	\$2,829		
	27 1/2	78	29	122	24	FLV2878PBMNL		\$3,820	\$4,204
	27 1/2	72	29	116	22	FLT2872PBMNR	\$2,759		
	27 1/2	72	29	116	22	FLV2872PBMNR		\$3,727	\$4,100
	27 1/2	72	29	116	22	FLT2872PBMNL	\$2,759		
	27 1/2	72	29	116	22	FLV2872PBMNL		\$3,727	\$4,100
	27 1/2	66	29	110	20	FLT2866PBMNR	\$2,012		
	27 1/2	66	29	110	20	FLV2866PBMNR		\$2,719	\$2,992
	27 1/2	66	29	110	20	FLT2866PBMNL	\$2,012		
	27 1/2	66	29	110	20	FLV2866PBMNL		\$2,719	\$2,992

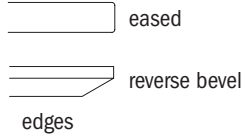
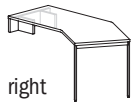
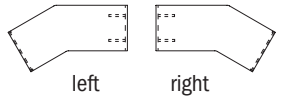
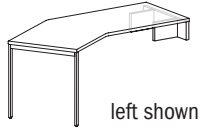

Features:

- peninsula desk mounting included in the list price of the unit, but must be specified when ordering secondary credenza; see pages 18-20 for details
- eased edge profile on approach and user sides

Options:

- must specify support panels grain direction on artisan veneer, see pages 13-15 for details
- on laminate units, contrasting worksurface tops and chassis available, no upcharge; specify color see page 16 for details
- reverse bevel edge available on three sides, specify; add \$474 list for laminate or \$186 list for veneer; see page 8 for details
- 13 1/2" h modesty panel available for 84" w and 78" w desk, specify; add \$474 list for laminate or \$656 list for veneer; see page 21 for details
- top grommet available, specify location; add \$142 list each; see page 44 for details
- 12" wide top grommet available, specify location; add \$186 list each; see page 44 for details
- worksurface power available, specify "to accommodate EC26" on your purchase order; EC26 unit must be ordered separately, see page 44
- wire manager tray available see accessory section on pages 50-51 for details

To Order, Specify:

① Laminate Model #	② Laminate Type	③ Laminate Selection	④ Metal Color	⑤ Other Product Options		
Laminate (FLT)	HPL	See Laminate Selection	See Metal Finish Color Options	See list of options for each specific unit; Specify and add accordingly.		
① Veneer Model #	② Wood Collection	③ Wood Finish	④ Metal Color	⑤ Other Product Options		
Veneer (FLV)	Essentials	See Essentials Wood Finish Options	See Metal Finish Color Options	See list of options for each specific unit; Specify and add accordingly.		
	Artisan	<table border="1"> <tr> <th>ⓐ Wood Finish</th> <th>ⓑ Chassis Grain Direction</th> </tr> <tr> <td>See Artisan Wood Finish Options</td> <td>For Artisan Only: Vertical Horizontal</td> </tr> </table>	ⓐ Wood Finish		ⓑ Chassis Grain Direction	See Artisan Wood Finish Options
ⓐ Wood Finish	ⓑ Chassis Grain Direction					
See Artisan Wood Finish Options	For Artisan Only: Vertical Horizontal					

Description	D	W	H	CTN WT	CU FT	① Model	HPL Laminate	Essentials Veneer	Artisan Veneer
Rectangular Run-off Desk with End Leg Assembly	33½	72	29	119	22	FLT3472RRTN	\$1,808		
	33½	72	29	119	22	FLV3472RRTN		\$2,366	\$2,602
	33½	66	29	112	20	FLT3466RRTN	\$1,770		
	33½	66	29	112	20	FLV3466RRTN		\$2,314	\$2,545
	33½	60	29	105	18	FLT3460RRTN	\$1,731		
	33½	60	29	105	18	FLV3460RRTN		\$2,263	\$2,490
	33½	54	29	98	17	FLT3454RRTN	\$1,695		
	33½	54	29	98	17	FLV3454RRTN		\$2,211	\$2,432
	33½	48	29	91	16	FLT3448RRTN	\$1,672		
	33½	48	29	91	16	FLV3448RRTN		\$2,183	\$2,402

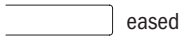

eased



reverse bevel



edges

Features:

- mounts perpendicular to primary height units
- eased edge profile on approach and user sides
- laminate tops wider than 60" are long grain

Options:

- reverse bevel edge available on three sides, specify; add \$474 list for laminate or \$186 list for veneer; see page 8 for details
- 13 ½" h modesty panel available, specify; add \$474 list for laminate or \$656 list for veneer; see page 21 for details
- top grommet available, specify location; add \$142 list each; see page 45 for details
- 12" wide top grommet available, specify location; add \$186 list each; see page 45 for details
- worksurface power available, specify "to accommodate EC26" on your purchase order; EC26 unit must be ordered separately, see page 45
- wire manager tray available see accessory section on pages 50-51 for details

Description	D	W	H	CTN WT	CU FT	① Model	HPL Laminate	Essentials Veneer	Artisan Veneer
 	27 1/2	72	29	101	18	FLT2872RRTN	\$1,784		
	27 1/2	72	29	101	18	FLV2872RRTN		\$2,331	\$2,566
	27 1/2	66	29	94	17	FLT2866RRTN	\$1,746		
	27 1/2	66	29	94	17	FLV2866RRTN		\$2,280	\$2,508
	27 1/2	60	29	87	15	FLT2860RRTN	\$1,708		
	27 1/2	60	29	87	15	FLV2860RRTN		\$2,230	\$2,452
	27 1/2	54	29	80	14	FLT2854RRTN	\$1,671		
	27 1/2	54	29	80	14	FLV2854RRTN		\$2,181	\$2,399
	27 1/2	48	29	80	13	FLT2848RRTN	\$1,649		
	27 1/2	48	29	80	13	FLV2848RRTN		\$2,152	\$2,367

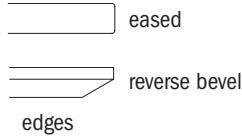

Features:

- mounts perpendicular to primary height units
- eased edge profile on approach and user sides
- laminate tops wider than 60" are long grain

Options:

- reverse bevel edge available on three sides, specify; add \$474 list for laminate or \$186 list for veneer; see page 8 for details
- 13 1/2" h modesty panel available, specify; add \$474 list for laminate or \$656 list for veneer; see page 21 for details
- top grommet available, specify location; add \$142 list each; see page 45 for details
- 12" wide top grommet available, specify location; add \$186 list each; see page 45 for details
- worksurface power available, specify "to accommodate EC26" on your purchase order; EC26 unit must be ordered separately, see page 45
- wire manager tray available see accessory section on pages 50-51 for details

To Order, Specify:

① Laminate Model #	② Laminate Type	③ Laminate Selection	④ Metal Color	⑤ Other Product Options		
Laminate (FLT)	HPL	See Laminate Selection	See Metal Finish Color Options	See list of options for each specific unit; Specify and add accordingly.		
① Veneer Model #	② Wood Collection	③ Wood Finish	④ Metal Color	⑤ Other Product Options		
Veneer (FLV)	Essentials	See Essentials Wood Finish Options	See Metal Finish Color Options	See list of options for each specific unit; Specify and add accordingly.		
	Artisan	<table border="1"> <thead> <tr> <th>ⓐ Wood Finish</th> <th>ⓑ Chassis Grain Direction</th> </tr> </thead> <tbody> <tr> <td>See Artisan Wood Finish Options</td> <td>For Artisan Only: Vertical Horizontal</td> </tr> </tbody> </table>	ⓐ Wood Finish		ⓑ Chassis Grain Direction	See Artisan Wood Finish Options
ⓐ Wood Finish	ⓑ Chassis Grain Direction					
See Artisan Wood Finish Options	For Artisan Only: Vertical Horizontal					

Description	D	W	H	CTN WT	CU FT	① Model	HPL Laminate	Essentials Veneer	Artisan Veneer
Rectangular Run-off Desk with Frame Base	33½	72	29	119	22	FLT3472RRTP	\$1,808		
	33½	72	29	119	22	FLV3472RRTP		\$2,366	\$2,602
	33½	66	29	112	20	FLT3466RRTP	\$1,770		
	33½	66	29	112	20	FLV3466RRTP		\$2,314	\$2,545
	33½	60	29	105	18	FLT3460RRTP	\$1,731		
	33½	60	29	105	18	FLV3460RRTP		\$2,263	\$2,490
	33½	54	29	98	17	FLT3454RRTP	\$1,695		
	33½	54	29	98	17	FLV3454RRTP		\$2,211	\$2,432
	33½	48	29	91	16	FLT3448RRTP	\$1,672		
	33½	48	29	91	16	FLV3448RRTP		\$2,183	\$2,402

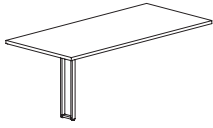

eased



reverse bevel

edges

Features:

- mounts perpendicular to primary height units
- eased edge profile on approach and user sides
- laminate tops wider than 60" are long grain

Options:

- reverse bevel edge available on three sides, specify; add \$474 list for laminate or \$186 list for veneer; see page 8 for details
- 13 ½" h modesty panel available, specify; add \$474 list for laminate or \$656 list for veneer; see page 21 for details
- top grommet available, specify location; add \$142 list each; see page 45 for details
- 12" wide top grommet available, specify location; add \$186 list each; see page 45 for details
- worksurface power available, specify "to accommodate EC26" on your purchase order; EC26 unit must be ordered separately, see page 45
- wire manager tray available see accessory section on pages 50-51 for details

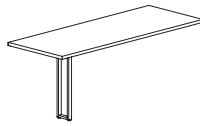
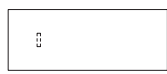
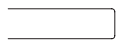
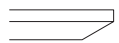
Description	D	W	H	CTN WT	CU FT	① Model	HPL Laminate	Essentials Veneer	Artisan Veneer
   eased  reverse bevel edges	27 1/2	72	29	101	18	FLT2872RRTP	\$1,784		
	27 1/2	72	29	101	18	FLV2872RRTP		\$2,331	\$2,566
	27 1/2	66	29	94	17	FLT2866RRTP	\$1,746		
	27 1/2	66	29	94	17	FLV2866RRTP		\$2,280	\$2,508
	27 1/2	60	29	87	15	FLT2860RRTP	\$1,708		
	27 1/2	60	29	87	15	FLV2860RRTP		\$2,230	\$2,452
	27 1/2	54	29	80	14	FLT2854RRTP	\$1,671		
	27 1/2	54	29	80	14	FLV2854RRTP		\$2,181	\$2,399
	27 1/2	48	29	80	13	FLT2848RRTP	\$1,649		
	27 1/2	48	29	80	13	FLV2848RRTP		\$2,152	\$2,367

Features:

- mounts perpendicular to primary height units
- eased edge profile on approach and user sides
- laminate tops wider than 60" are long grain



Options:

- reverse bevel edge available on three sides, specify; add \$474 list for laminate or \$186 list for veneer; see page 8 for details
- 13 1/2" h modesty panel available, specify; add \$474 list for laminate or \$656 list for veneer; see page 21 for details
- top grommet available, specify location; add \$142 list each; see page 45 for details
- 12" wide top grommet available, specify location; add \$186 list each; see page 45 for details
- worksurface power available, specify "to accommodate EC26" on your purchase order; EC26 unit must be ordered separately, see page 45
- wire manager tray available see accessory section on pages 50-51 for details

To Order, Specify:

① Laminate Model #	② Laminate Type	③ Laminate Selection	④ Metal Color	⑤ Other Product Options		
Laminate (FLT)	HPL	See Laminate Selection	See Metal Finish Color Options	See list of options for each specific unit; Specify and add accordingly.		
① Veneer Model #	② Wood Collection	③ Wood Finish	④ Metal Color	⑤ Other Product Options		
Veneer (FLV)	Essentials	See Essentials Wood Finish Options	See Metal Finish Color Options	See list of options for each specific unit; Specify and add accordingly.		
	Artisan	<table border="1"> <thead> <tr> <th>③a Wood Finish</th> <th>③b Chassis Grain Direction</th> </tr> </thead> <tbody> <tr> <td>See Artisan Wood Finish Options</td> <td>For Artisan Only: Vertical Horizontal</td> </tr> </tbody> </table>	③a Wood Finish		③b Chassis Grain Direction	See Artisan Wood Finish Options
③a Wood Finish	③b Chassis Grain Direction					
See Artisan Wood Finish Options	For Artisan Only: Vertical Horizontal					

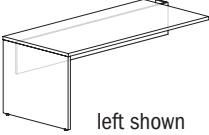
FLUX

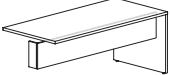
Description	D	W	H	CTN WT	CU FT	① Model	HPL Laminate	Essentials Veneer	Artisan Veneer
Rectangular Run-off Desk with End Panel Support     approach - left	33½	72	29	141	48	FLT3472RDEPR	\$1,505		
	33½	72	29	141	48	FLV3472RDEPR		\$2,277	\$2,504
	33½	72	29	141	48	FLT3472RDEPL	\$1,505		
	33½	72	29	141	48	FLV3472RDEPL		\$2,277	\$2,504
	33½	66	29	130	44	FLT3466RDEPR	\$1,475		
	33½	66	29	130	44	FLV3466RDEPR		\$2,231	\$2,455
	33½	66	29	130	44	FLT3466RDEPL	\$1,475		
	33½	66	29	130	44	FLV3466RDEPL		\$2,231	\$2,455
	33½	60	29	119	40	FLT3460RDEPR	\$1,443		
	33½	60	29	119	40	FLV3460RDEPR		\$2,187	\$2,404
	33½	60	29	119	40	FLT3460RDEPL	\$1,443		
	33½	60	29	119	40	FLV3460RDEPL		\$2,187	\$2,404
	33½	54	29	108	36	FLT3454RDEPR	\$1,418		
	33½	54	29	108	36	FLV3454RDEPR		\$2,142	\$2,356
	33½	54	29	108	36	FLT3454RDEPL	\$1,418		
33½	54	29	108	36	FLV3454RDEPL		\$2,142	\$2,356	

Features:

- to be used with open corner primary height credenzas; see page 19
- mounts perpendicular to primary height units
- eased edge profile on approach and user sides
- laminate tops wider than 60" are long grain
- 6¾" h modesty with horizontal wire channel

Options:

- must specify support panels grain direction on artisan veneer, see pages 13-15 for details
- on laminate units, contrasting worksurface tops and chassis available, no upcharge; specify color, see page 16 for details
- top grommet available, specify location; add \$142 list each; see page 45 for details
- 12" wide top grommet available, specify location; add \$186 list each; see page 45 for details
- worksurface power available, specify "to accommodate EC26" on your purchase order; EC26 unit must be ordered separately, see page 45
- wire manager tray available see accessory section on pages 50-51 for details

FLUX

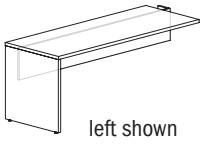
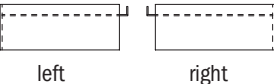
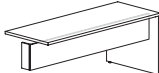
Description	D	W	H	CTN WT	CU FT	① Model	HPL Laminate	Essentials Veneer	Artisan Veneer
 left shown  left right  approach - left	27 1/2	72	29	120	40	FLT2872RDEPR	\$1,242		
	27 1/2	72	29	120	40	FLV2872RDEPR		\$1,881	\$2,069
	27 1/2	72	29	120	40	FLT2872RDEPL	\$1,242		
	27 1/2	72	29	120	40	FLV2872RDEPL		\$1,881	\$2,069
	27 1/2	66	29	111	37	FLT2866RDEPR	\$1,218		
	27 1/2	66	29	111	37	FLV2866RDEPR		\$1,843	\$2,029
	27 1/2	66	29	111	37	FLT2866RDEPL	\$1,218		
	27 1/2	66	29	111	37	FLV2866RDEPL		\$1,843	\$2,029
	27 1/2	60	29	102	34	FLT2860RDEPR	\$1,194		
	27 1/2	60	29	102	34	FLV2860RDEPR		\$1,804	\$1,988
	27 1/2	60	29	102	34	FLT2860RDEPL	\$1,194		
	27 1/2	60	29	102	34	FLV2860RDEPL		\$1,804	\$1,988
	27 1/2	54	29	93	30	FLT2854RDEPR	\$1,171		
	27 1/2	54	29	93	30	FLV2854RDEPR		\$1,770	\$1,948
	27 1/2	54	29	93	30	FLT2854RDEPL	\$1,171		
	27 1/2	54	29	93	30	FLV2854RDEPL		\$1,770	\$1,948

Features:

- to be used with open corner primary height credenzas; see page 19
- mounts perpendicular to primary height units
- eased edge profile on approach and user sides
- laminate tops wider than 60" are long grain
- 6 3/4" h modesty with horizontal wire channel

Options:

- must specify support panels grain direction on artisan veneer, see pages 13-15 for details
- on laminate units, contrasting worksurface tops and chassis available, no upcharge; specify color, see page 16 for details
- top grommet available, specify location; add \$142 list each; see page 45 for details
- 12" wide top grommet available, specify location; add \$186 list each; see page 45 for details
- worksurface power available, specify "to accommodate EC26" on your purchase order; EC26 unit must be ordered separately, see page 45
- wire manager tray available see accessory section on pages 50-51 for details

To Order, Specify:

① Laminate Model #	② Laminate Type	③ Laminate Selection	④ Metal Color	⑤ Other Product Options		
Laminate (FLT)	HPL	See Laminate Selection	See Metal Finish Color Options	See list of options for each specific unit; Specify and add accordingly.		
① Veneer Model #	② Wood Collection	③ Wood Finish	④ Metal Color	⑤ Other Product Options		
Veneer (FLV)	Essentials	See Essentials Wood Finish Options	See Metal Finish Color Options	See list of options for each specific unit; Specify and add accordingly.		
	Artisan	<table border="1"> <tr> <th>ⓐ Wood Finish</th> <th>ⓑ Chassis Grain Direction</th> </tr> <tr> <td>See Artisan Wood Finish Options</td> <td>For Artisan Only: Vertical Horizontal</td> </tr> </table>	ⓐ Wood Finish		ⓑ Chassis Grain Direction	See Artisan Wood Finish Options
ⓐ Wood Finish	ⓑ Chassis Grain Direction					
See Artisan Wood Finish Options	For Artisan Only: Vertical Horizontal					

Description	D	W	H	CTN WT	CU FT	① Model	HPL Laminate	Essentials Veneer	Artisan Veneer
Arc End Run-off Desk with Frame Base	33½	72	29	119	22	FLT3472ARCTP	\$1,984		
	33½	72	29	119	22	FLV3472ARCTP		\$2,606	\$2,865
	33½	66	29	112	20	FLT3466ARCTP	\$1,941		
	33½	66	29	112	20	FLV3466ARCTP		\$2,548	\$2,801
	33½	60	29	105	18	FLT3460ARCTP	\$1,900		
	33½	60	29	105	18	FLV3460ARCTP		\$2,490	\$2,738
	33½	54	29	98	17	FLT3454ARCTP	\$1,875		
	33½	54	29	98	17	FLV3454ARCTP		\$2,456	\$2,702
	33½	48	29	91	16	FLT3448ARCTP	\$1,850		
	33½	48	29	91	16	FLV3448ARCTP		\$2,423	\$2,665

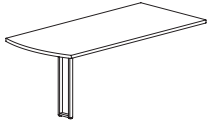

eased



reverse bevel

edges

Features:

- mounts perpendicular to primary height units
- eased edge profile on approach and user sides
- laminate tops wider than 60" are long grain

Options:

- reverse bevel edge available on three sides, specify; add \$474 list for laminate or \$186 list for veneer; see page 8 for details
- 13 ½" h modesty panel available, specify; add \$474 list for laminate or \$656 list for veneer; see page 21 for details
- top grommet available, specify location; add \$142 list each; see page 45 for details
- 12" wide top grommet available, specify location; add \$186 list each; see page 45 for details
- worksurface power available, specify "to accommodate EC26" on your purchase order; EC26 unit must be ordered separately, see page 45
- wire manager tray available see accessory section on pages 50-51 for details

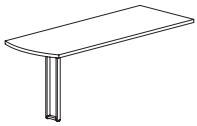
Description	D	W	H	CTN WT	CU FT	① Model	HPL Laminate	Essentials Veneer	Artisan Veneer
Arc End Run-off Desk with Frame Base 	27 1/2	72	29	101	18	FLT2872ARCTP	\$1,936		
	27 1/2	72	29	101	18	FLV2872ARCTP		\$2,540	\$2,791
	27 1/2	66	29	94	17	FLT2866ARCTP	\$1,893		
	27 1/2	66	29	94	17	FLV2866ARCTP		\$2,483	\$2,732
	27 1/2	60	29	87	15	FLT2860ARCTP	\$1,852		
	27 1/2	60	29	87	15	FLV2860ARCTP		\$2,426	\$2,671
	27 1/2	54	29	80	14	FLT2854ARCTP	\$1,814		
	27 1/2	54	29	80	14	FLV2854ARCTP		\$2,372	\$2,611
	27 1/2	48	29	80	13	FLT2848ARCTP	\$1,791		
	27 1/2	48	29	80	13	FLV2848ARCTP		\$2,343	\$2,574



 eased

 reverse bevel edges

Features:

- mounts perpendicular to primary height units
- eased edge profile on approach and user sides
- laminate tops wider than 60" are long grain

Options:

- reverse bevel edge available on three sides, specify; add \$474 list for laminate or \$186 list for veneer; see page 8 for details
- 13 1/2" h modesty panel available, specify; add \$474 list for laminate or \$656 list for veneer; see page 21 for details
- top grommet available, specify location; add \$142 list each; see page 45 for details
- 12" wide top grommet available, specify location; add \$186 list each; see page 45 for details
- worksurface power available, specify "to accommodate EC26" on your purchase order; EC26 unit must be ordered separately, see page 45
- wire manager tray available see accessory section on pages 50-51 for details

FLUX

To Order, Specify:

① Laminate Model #	② Laminate Type	③ Laminate Selection	④ Metal Color	⑤ Other Product Options		
Laminate (FLT)	HPL	See Laminate Selection	See Metal Finish Color Options	See list of options for each specific unit; Specify and add accordingly.		
① Veneer Model #	② Wood Collection	③ Wood Finish	④ Metal Color	⑤ Other Product Options		
Veneer (FLV)	Essentials	See Essentials Wood Finish Options	See Metal Finish Color Options	See list of options for each specific unit; Specify and add accordingly.		
	Artisan	<table border="1"> <tr> <th>ⓐ Wood Finish</th> <th>ⓑ Chassis Grain Direction</th> </tr> <tr> <td>See Artisan Wood Finish Options</td> <td>For Artisan Only: Vertical Horizontal</td> </tr> </table>	ⓐ Wood Finish		ⓑ Chassis Grain Direction	See Artisan Wood Finish Options
ⓐ Wood Finish	ⓑ Chassis Grain Direction					
See Artisan Wood Finish Options	For Artisan Only: Vertical Horizontal					

Description	D	W	H	CTN WT	CU FT	① Model	HPL Laminate	Essentials Veneer	Artisan Veneer
Boomerang Run-off Desk with End Leg Assembly	33½	72	29	119	22	FLT3472BMTNR	\$2,646		
	33½	72	29	119	22	FLV3472BMTNR		\$3,499	\$3,850
	33½	72	29	119	22	FLT3472BMTNL	\$2,646		
	33½	72	29	119	22	FLV3472BMTNL		\$3,499	\$3,850
	33½	66	29	112	20	FLT3466BMTNR	\$2,598		
	33½	66	29	112	20	FLV3466BMTNR		\$3,435	\$3,778
	33½	66	29	112	20	FLT3466BMTNL	\$2,598		
	33½	66	29	112	20	FLV3466BMTNL		\$3,435	\$3,778
	33½	60	29	105	18	FLT3460BMTNR	\$2,551		
	33½	60	29	105	18	FLV3460BMTNR		\$3,370	\$3,707
	33½	60	29	105	18	FLT3460BMTNL	\$2,551		
	33½	60	29	105	18	FLV3460BMTNL		\$3,370	\$3,707

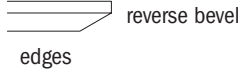
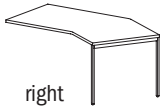
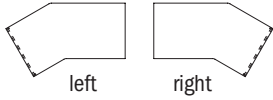
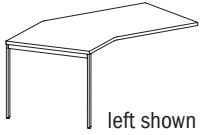

Features:

- mounts perpendicular to primary height units
- eased edge profile on approach and user sides
- laminate tops wider than 60" are long grain

Options:

- reverse bevel edge available on three sides, specify; add \$474 list for laminate or \$186 list for veneer; see page 8 for details
- 13 ½" h modesty panel available, specify; add \$474 list for laminate or \$656 list for veneer; see page 21 for details
- top grommet available, specify location; add \$142 list each; see page 45 for details
- 12" wide top grommet available, specify location; add \$186 list each; see page 45 for details
- worksurface power available, specify "to accommodate EC26" on your purchase order; EC26 unit must be ordered separately, see page 45
- wire manager tray available see accessory section on pages 50-51 for details

Description	D	W	H	CTN WT	CU FT	① Model	HPL Laminate	Essentials Veneer	Artisan Veneer
Boomerang Run-off Desk with End Leg Assembly	27 1/2	72	29	101	18	FLT2872BMTNR	\$2,587		
	27 1/2	72	29	101	18	FLV2872BMTNR		\$3,415	\$3,759
	27 1/2	66	29	94	17	FLT2866BMTNL	\$2,541		
	27 1/2	66	29	94	17	FLV2866BMTNL		\$3,354	\$3,689
	27 1/2	60	29	87	15	FLT2860BMTNR	\$2,494		
	27 1/2	60	29	87	15	FLV2860BMTNR		\$3,291	\$3,621
	27 1/2	72	29	101	18	FLT2872BMTNL	\$2,587		
	27 1/2	72	29	101	18	FLV2872BMTNL		\$3,415	\$3,759
	27 1/2	66	29	94	17	FLT2866BMTNR	\$2,541		
	27 1/2	66	29	94	17	FLV2866BMTNR		\$3,354	\$3,689
	27 1/2	60	29	87	15	FLT2860BMTNL	\$2,494		
	27 1/2	60	29	87	15	FLV2860BMTNL		\$3,291	\$3,621

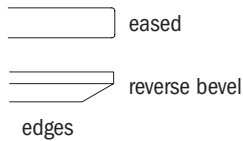
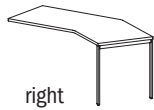
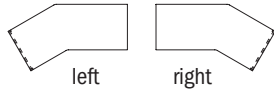
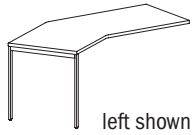

Features:

- mounts perpendicular to primary height units
- eased edge profile on approach and user sides
- laminate tops wider than 60" are long grain

Options:

- reverse bevel edge available on three sides, specify; add \$474 list for laminate or \$186 list for veneer; see page 8 for details
- 13 1/2" h modesty panel available, specify; add \$474 list for laminate or \$656 list for veneer; see page 21 for details
- top grommet available, specify location; add \$142 list each; see page 45 for details
- 12" wide top grommet available, specify location; add \$186 list each; see page 45 for details
- worksurface power available, specify "to accommodate EC26" on your purchase order; EC26 unit must be ordered separately, see page 45
- wire manager tray available see accessory section on pages 50-51 for details

To Order, Specify:

① Laminate Model #	② Laminate Type	③ Laminate Selection	④ Metal Color	⑤ Other Product Options		
Laminate (FLT)	HPL	See Laminate Selection	See Metal Finish Color Options	See list of options for each specific unit; Specify and add accordingly.		
① Veneer Model #	② Wood Collection	③ Wood Finish	④ Metal Color	⑤ Other Product Options		
Veneer (FLV)	Essentials	See Essentials Wood Finish Options	See Metal Finish Color Options	See list of options for each specific unit; Specify and add accordingly.		
	Artisan	<table border="1"> <tr> <th>ⓐ Wood Finish</th> <th>ⓑ Chassis Grain Direction</th> </tr> <tr> <td>See Artisan Wood Finish Options</td> <td>For Artisan Only: Vertical Horizontal</td> </tr> </table>	ⓐ Wood Finish		ⓑ Chassis Grain Direction	See Artisan Wood Finish Options
ⓐ Wood Finish	ⓑ Chassis Grain Direction					
See Artisan Wood Finish Options	For Artisan Only: Vertical Horizontal					

Description	D	W	H	CTN WT	CU FT	① Model	HPL Laminate	Essentials Veneer	Artisan Veneer
 left shown	22	60	29	129	27	FLT2260-29FERR	\$1,762		
	22	60	29	129	27	FLV2260-29FERR		\$2,461	\$2,705
	22	60	29	129	27	FLT2260-29FELR	\$1,762		
	22	60	29	129	27	FLV2260-29FELR		\$2,461	\$2,705
	22	54	29	124	25	FLT2254-29FERR	\$1,728		
	22	54	29	124	25	FLV2254-29FERR		\$2,412	\$2,653
	22	54	29	124	25	FLT2254-29FELR	\$1,728		
	22	54	29	124	25	FLV2254-29FELR		\$2,412	\$2,653
	22	48	29	119	22	FLT2248-29FERR	\$1,695		
	22	48	29	119	22	FLV2248-29FERR		\$2,366	\$2,602
	22	48	29	119	22	FLT2248-29FELR	\$1,695		
	22	48	29	119	22	FLV2248-29FELR		\$2,366	\$2,602
	22	42	29	114	20	FLT2242-29FERR	\$1,662		
	22	42	29	114	20	FLV2242-29FERR		\$2,320	\$2,550
	22	42	29	114	20	FLT2242-29FELR	\$1,662		
	22	42	29	114	20	FLV2242-29FELR		\$2,320	\$2,550

Features:

- eased edge user side only
- pedestal front locking

Options:

- must specify chassis grain direction on artisan veneer, see pages 13-15 for details
- standard without kneespace modesty panel, partial and full modesty panels available; add \$179 list for laminate or \$223 list for veneer; see page 12 for details
- veneer drawer fronts in paint available, specify paint color; add \$372 list; see page 16 for details
- on laminate units, contrasting worksurface tops and drawer fronts available, no upcharge; specify color, see page 16 for details
- ledge pulls standard; prism pulls available, specify and see page 9
- interior wire manager from side to side in upper back, specify and add \$126 list; see page 17 for details
- top grommet available, specify location and add \$142 list each; see page 45 for details
- worksurface power available, specify "to accommodate EC26" on your purchase order; EC26 unit must be ordered separately, see page 45

FLUX

Description	D	W	H	CTN WT	CU FT	① Model	HPL Laminate	Essentials Veneer	Artisan Veneer
 <p>left shown</p>	22	60	29	129	27	FLT2260-29FERY	\$1,772		
	22	60	29	129	27	FLV2260-29FERY		\$2,468	\$2,713
	22	60	29	129	27	FLT2260-29FELY	\$1,772		
	22	60	29	129	27	FLV2260-29FELY		\$2,468	\$2,713
	22	54	29	124	25	FLT2254-29FERY	\$1,737		
	22	54	29	124	25	FLV2254-29FERY		\$2,421	\$2,663
	22	54	29	124	25	FLT2254-29FELY	\$1,737		
	22	54	29	124	25	FLV2254-29FELY		\$2,421	\$2,663
	22	48	29	119	22	FLT2248-29FERY	\$1,705		
	22	48	29	119	22	FLV2248-29FERY		\$2,372	\$2,611
	22	48	29	119	22	FLT2248-29FELY	\$1,705		
	22	48	29	119	22	FLV2248-29FELY		\$2,372	\$2,611
	22	42	29	114	20	FLT2242-29FERY	\$1,670		
	22	42	29	114	20	FLV2242-29FERY		\$2,326	\$2,558
	22	42	29	114	20	FLT2242-29FELY	\$1,670		
	22	42	29	114	20	FLV2242-29FELY		\$2,326	\$2,558

Features:

- eased edge user side only
- pedestal front locking

Options:

- must specify chassis grain direction on artisan veneer, see pages 13-15 for details
- standard without kneespace modesty panel, partial and full modesty panels available; add \$179 list for laminate or \$223 list for veneer; see page 12 for details
- veneer drawer fronts in paint available, specify paint color; add \$372 list; see page 16 for details
- on laminate units, contrasting worksurface tops and drawer fronts available, no upcharge; specify color, see page 16 for details
- ledge pulls standard; prism pulls available, specify and see page 9
- interior wire manager from side to side in upper back, specify and add \$126 list; see page 17 for details
- top grommet available, specify location and add \$142 list each; see page 45 for details
- worksurface power available, specify "to accommodate EC26" on your purchase order; EC26 unit must be ordered separately, see page 45

To Order, Specify:

① Laminate Model #	② Laminate Type	③ Laminate Selection	④ Metal Color	⑤ Other Product Options		
Laminate (FLT)	HPL	See Laminate Selection	See Metal Finish Color Options	See list of options for each specific unit; Specify and add accordingly.		
① Veneer Model #	② Wood Collection	③ Wood Finish	④ Metal Color	⑤ Other Product Options		
Veneer (FLV)	Essentials	See Essentials Wood Finish Options	See Metal Finish Color Options	See list of options for each specific unit; Specify and add accordingly.		
	Artisan	<table border="1"> <thead> <tr> <th>ⓐ Wood Finish</th> <th>ⓑ Chassis Grain Direction</th> </tr> </thead> <tbody> <tr> <td>See Artisan Wood Finish Options</td> <td>For Artisan Only: Vertical Horizontal</td> </tr> </tbody> </table>	ⓐ Wood Finish		ⓑ Chassis Grain Direction	See Artisan Wood Finish Options
ⓐ Wood Finish	ⓑ Chassis Grain Direction					
See Artisan Wood Finish Options	For Artisan Only: Vertical Horizontal					

Description	D	W	H	CTN WT	CU FT	① Model	HPL Laminate	Essentials Veneer	Artisan Veneer
 left shown	22	60	29	185	27	FLT2260-29FLRR	\$2,081		
	22	60	29	185	27	FLV2260-29FLRR		\$2,905	\$3,194
	22	60	29	185	27	FLT2260-29FLLR	\$2,081		
	22	60	29	185	27	FLV2260-29FLLR		\$2,905	\$3,194
	22	54	29	180	25	FLT2254-29FLRR	\$2,031		
	22	54	29	180	25	FLV2254-29FLRR		\$2,833	\$3,117
	22	54	29	180	25	FLT2254-29FLLR	\$2,031		
	22	54	29	180	25	FLV2254-29FLLR		\$2,833	\$3,117
	22	48	29	175	22	FLT2248-29FLRR	\$1,981		
	22	48	29	175	22	FLV2248-29FLRR		\$2,765	\$3,042
	22	48	29	175	22	FLT2248-29FLLR	\$1,981		
	22	48	29	175	22	FLV2248-29FLLR		\$2,765	\$3,042

Features:

- eased edge user side only
- pedestal front locking

Options:

- must specify chassis grain direction on artisan veneer, see pages 13-15 for details
- standard without kneespace modesty panel, partial and full modesty panels available; add \$179 list for laminate or \$223 list for veneer; see page 12 for details
- veneer drawer fronts in paint available, specify paint color; add \$372 list; see page 16 for details
- on laminate units, contrasting worksurface tops and drawer fronts available, no upcharge; specify color, see page 16 for details
- ledge pulls standard; prism pulls available, specify and see page 9
- interior wire manager from side to side in upper back, specify and add \$126 list; see page 17 for details
- top grommet available, specify location and add \$142 list each; see page 45 for details
- worksurface power available, specify "to accommodate EC26" on your purchase order; EC26 unit must be ordered separately, see page 45

Description	D	W	H	CTN WT	CU FT	① Model	HPL Laminate	Essentials Veneer	Artisan Veneer
 left shown	22	60	29	185	27	FLT2260-29FLRY	\$2,091		
	22	60	29	185	27	FLV2260-29FLRY		\$2,919	\$3,210
	22	60	29	185	27	FLT2260-29FLLY	\$2,091		
	22	60	29	185	27	FLV2260-29FLLY		\$2,919	\$3,210
	22	54	29	180	25	FLT2254-29FLRY	\$2,042		
	22	54	29	180	25	FLV2254-29FLRY		\$2,848	\$3,134
	22	54	29	180	25	FLT2254-29FLLY	\$2,042		
	22	54	29	180	25	FLV2254-29FLLY		\$2,848	\$3,134
	22	48	29	175	22	FLT2248-29FLRY	\$1,992		
	22	48	29	175	22	FLV2248-29FLRY		\$2,779	\$3,056
	22	48	29	175	22	FLT2248-29FLLY	\$1,992		
	22	48	29	175	22	FLV2248-29FLLY		\$2,779	\$3,056

Features:

- eased edge user side only
- pedestal front locking

Options:

- must specify chassis grain direction on artisan veneer, see pages 13-15 for details
- standard without kneespace modesty panel, partial and full modesty panels available; add \$179 list for laminate or \$223 list for veneer; see page 12 for details
- veneer drawer fronts in paint available, specify paint color; add \$372 list; see page 16 for details
- on laminate units, contrasting worksurface tops and drawer fronts available, no upcharge; specify color, see page 16 for details
- ledge pulls standard; prism pulls available, specify and see page 9
- interior wire manager from side to side in upper back, specify and add \$126 list; see page 17 for details
- top grommet available, specify location and add \$142 list each; see page 45 for details
- worksurface power available, specify "to accommodate EC26" on your purchase order; EC26 unit must be ordered separately, see page 45

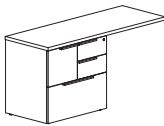
Description	D	W	H	CTN WT	CU FT	① Model	HPL Laminate	Essentials Veneer	Artisan Veneer
 Multi-File Return left shown	22	60	29	191	27	FLT2260-29FMRR	\$2,224		
	22	60	29	191	27	FLV2260-29FMRR		\$3,107	\$3,415
	22	60	29	191	27	FLT2260-29FMLR	\$2,224		
	22	60	29	191	27	FLV2260-29FMLR		\$3,107	\$3,415
	22	54	29	186	25	FLT2254-29FMRR	\$2,173		
	22	54	29	186	25	FLV2254-29FMRR		\$3,032	\$3,334
	22	54	29	186	25	FLT2254-29FMLR	\$2,173		
	22	54	29	186	25	FLV2254-29FMLR		\$3,032	\$3,334
	22	48	29	181	22	FLT2248-29FMRR	\$2,117		
	22	48	29	181	22	FLV2248-29FMRR		\$2,958	\$3,253
	22	48	29	181	22	FLT2248-29FMLR	\$2,117		
	22	48	29	181	22	FLV2248-29FMLR		\$2,958	\$3,253

Features:

- eased edge user side only
- pedestal front locking

Options:

- must specify chassis grain direction on artisan veneer, see pages 13-15 for details
- standard without kneespace modesty panel, partial and full modesty panels available; add \$179 list for laminate or \$223 list for veneer; see page 12 for details
- veneer drawer fronts in paint available, specify paint color; add \$372 list; see page 16 for details
- on laminate units, contrasting worksurface tops and drawer fronts available, no upcharge; specify color, see page 16 for details
- ledge pulls standard; prism pulls available, specify and see page 9
- interior wire manager from side to side in upper back, specify and add \$126 list; see page 17 for details
- top grommet available, specify location and add \$142 list each; see page 45 for details
- worksurface power available, specify "to accommodate EC26" on your purchase order; EC26 unit must be ordered separately, see page 45

FLUX

To Order, Specify:

① Laminate Model #	② Laminate Type	③ Laminate Selection	④ Metal Color	⑤ Other Product Options		
Laminate (FLT)	HPL	See Laminate Selection	See Metal Finish Color Options	See list of options for each specific unit; Specify and add accordingly.		
① Veneer Model #	② Wood Collection	③ Wood Finish	④ Metal Color	⑤ Other Product Options		
Veneer (FLV)	Essentials	See Essentials Wood Finish Options	See Metal Finish Color Options	See list of options for each specific unit; Specify and add accordingly.		
	Artisan	<table border="1"> <tr> <th>ⓐ Wood Finish</th> <th>ⓑ Chassis Grain Direction</th> </tr> <tr> <td>See Artisan Wood Finish Options</td> <td>For Artisan Only: Vertical Horizontal</td> </tr> </table>	ⓐ Wood Finish		ⓑ Chassis Grain Direction	See Artisan Wood Finish Options
ⓐ Wood Finish	ⓑ Chassis Grain Direction					
See Artisan Wood Finish Options	For Artisan Only: Vertical Horizontal					

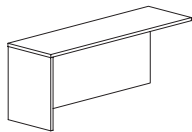
Description	D	W	H	CTN WT	CU FT	① Model	HPL Laminate	Essentials Veneer	Artisan Veneer
 Return Shell left shown	22	72	29	119	33	FLT2272RSHR	\$1,247		
	22	72	29	119	33	FLV2272RSHR		\$1,886	\$2,076
	22	72	29	119	33	FLT2272LSHR	\$1,247		
	22	72	29	119	33	FLV2272LSHR		\$1,886	\$2,076
	22	66	29	114	30	FLT2266RSHR	\$1,212		
	22	66	29	114	30	FLV2266RSHR		\$1,833	\$2,013
	22	66	29	114	30	FLT2266LSHR	\$1,212		
	22	66	29	114	30	FLV2266LSHR		\$1,833	\$2,013
	22	60	29	109	27	FLT2260RSHR	\$1,174		
	22	60	29	109	27	FLV2260RSHR		\$1,776	\$1,955
	22	60	29	109	27	FLT2260LSHR	\$1,174		
	22	60	29	109	27	FLV2260LSHR		\$1,776	\$1,955
	22	54	29	104	25	FLT2254RSHR	\$1,140		
	22	54	29	104	25	FLV2254RSHR		\$1,724	\$1,896
	22	54	29	104	25	FLT2254LSHR	\$1,140		
	22	54	29	104	25	FLV2254LSHR		\$1,724	\$1,896
	22	48	29	99	22	FLT2248RSHR	\$1,105		
	22	48	29	99	22	FLV2248RSHR		\$1,671	\$1,840
	22	48	29	99	22	FLT2248LSHR	\$1,105		
	22	48	29	99	22	FLV2248LSHR		\$1,671	\$1,840
22	42	29	94	20	FLT2242RSHR	\$1,071			
22	42	29	94	20	FLV2242RSHR		\$1,623	\$1,784	
22	42	29	94	20	FLT2242LSHR	\$1,071			
22	42	29	94	20	FLV2242LSHR		\$1,623	\$1,784	
22	36	29	89	17	FLT2236RSHR	\$1,041			
22	36	29	89	17	FLV2236RSHR		\$1,574	\$1,730	
22	36	29	89	17	FLT2236LSHR	\$1,041			
22	36	29	89	17	FLV2236LSHR		\$1,574	\$1,730	

Features:

- eased edge user side only
- laminate tops wider than 60" are long grain

Options:

- must specify chassis grain direction on artisan veneer, see pages 13-15 for details
- top grommet available, specify location; add \$142 list each; see page 45 for details

FLUX

Description	D	W	H	CTN WT	CU FT	① Model	HPL Laminate	Essentials Veneer	Artisan Veneer
Bridge 	22	50	1 3/16	69	3	FLT2250EB	\$658		
	22	50	1 3/16	69	3	FLV2250EB		\$821	\$901
	22	44	1 3/16	64	3	FLT2244EB	\$615		
	22	44	1 3/16	64	3	FLV2244EB		\$768	\$847
	22	38	1 3/16	59	2	FLT2238EB	\$605		
	22	38	1 3/16	59	2	FLV2238EB		\$756	\$831

Features:

- eased edge user side only

Options:

- standard without kneespace modesty panel, partial and full modesty panels available; add \$179 list for laminate or \$223 list for veneer; see page 12 for details
- when specify modesty with artisan veneer, specify grain direction, see pages 13-15 for details
- top grommet available, specify location; add \$142 list each; see page 45 for details
- worksurface power available, specify "to accommodate EC26" on your purchase order; EC26 unit must be ordered separately, see page 45

FLUX

To Order, Specify:

① Laminate Model #	② Laminate Type	③ Laminate Selection	④ Metal Color	⑤ Other Product Options		
Laminate (FLT)	HPL	See Laminate Selection	See Metal Finish Color Options	See list of options for each specific unit; Specify and add accordingly.		
① Veneer Model #	② Wood Collection	③ Wood Finish	④ Metal Color	⑤ Other Product Options		
Veneer (FLV)	Essentials	See Essentials Wood Finish Options	See Metal Finish Color Options	See list of options for each specific unit; Specify and add accordingly.		
	Artisan	<table border="1"> <thead> <tr> <th>ⓐ Wood Finish</th> <th>ⓑ Chassis Grain Direction</th> </tr> </thead> <tbody> <tr> <td>See Artisan Wood Finish Options</td> <td>For Artisan Only: Vertical Horizontal</td> </tr> </tbody> </table>	ⓐ Wood Finish		ⓑ Chassis Grain Direction	See Artisan Wood Finish Options
ⓐ Wood Finish	ⓑ Chassis Grain Direction					
See Artisan Wood Finish Options	For Artisan Only: Vertical Horizontal					

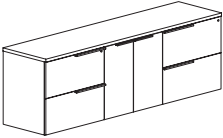
Description	D	W	H	CTN WT	CU FT	① Model	HPL Laminate	Essentials Veneer	Artisan Veneer
	22	96	29	437	43	FLT2296-29F474	\$3,847		
	22	96	29	437	43	FLV2296-29F474		\$5,366	\$5,904
	22	90	29	416	40	FLT2290-29F474	\$3,734		
	22	90	29	416	40	FLV2290-29F474		\$5,212	\$5,732
	22	84	29	395	38	FLT2284-29F474	\$3,623		
	22	84	29	395	38	FLV2284-29F474		\$5,059	\$5,565

Features:

- eased edge profile user side
- pedestal front locking
- hinged door compartment has one adjustable shelf

Options:

- must specify chassis grain direction on artisan veneer, see pages 13-15 for details
- locking doors available, specify and add \$153 list
- veneer door and drawer fronts in paint available, specify paint color and add \$372; see page 16 for details
- on laminate units, contrasting worksurface tops and door fronts available, no upcharge; specify laminate color, see page 16 for details
- ledge pulls standard; prism pulls available, specify and see page 9
- oval grommets in back panel can be eliminated upon request, no upcharge
- interior horizontal wire manager with end grommets available, specify and add \$199 list; see page 40 for details
- top grommet available, specify location; add \$142 list each; see page 45 for details
- worksurface power available, specify "to accommodate EC26" on your purchase order; EC26 unit must be ordered separately, see page 45

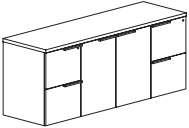
	22	78	29	354	35	FLT2278-29F272	\$3,181		
	22	78	29	354	35	FLV2278-29F272		\$4,442	\$4,886
	22	72	29	333	32	FLT2272-29F272	\$3,090		
	22	72	29	333	32	FLV2272-29F272		\$4,312	\$4,740
	22	66	29	310	30	FLT2266-29F272	\$3,028		
	22	66	29	310	30	FLV2266-29F272		\$4,226	\$4,649
	22	60	29	289	27	FLT2260-29F272	\$2,966		
	22	60	29	289	27	FLV2260-29F272		\$4,140	\$4,556

Features:

- eased edge profile user side
- pedestal front locking
- hinged door compartment has one adjustable shelf

Options:

- must specify chassis grain direction on artisan veneer, see pages 13-15 for details
- locking doors available, specify and add \$153 list
- veneer door and drawer fronts in paint available, specify paint color and add \$372; see page 16 for details
- on laminate units, contrasting worksurface tops and door fronts available, no upcharge; specify laminate color, see page 16 for details
- ledge pulls standard; prism pulls available, specify and see page 9
- oval grommets in back panel can be eliminated upon request, no upcharge
- interior horizontal wire manager with end grommets available, specify and add \$199 list; see page 40 for details
- top grommet available, specify location; add \$142 list each; see page 45 for details
- worksurface power available, specify "to accommodate EC26" on your purchase order; EC26 unit must be ordered separately, see page 45

FLUX

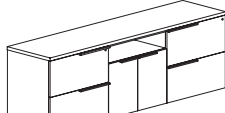
Description	D	W	H	CTN WT	CU FT	① Model	HPL Laminate	Essentials Veneer	Artisan Veneer
Storage Credenza with Open Center 	22	96	29	447	43	FLT2296-29F484	\$3,933		
	22	96	29	447	43	FLV2296-29F484		\$5,491	\$6,040
	22	90	29	425	40	FLT2290-29F484	\$3,818		
	22	90	29	425	40	FLV2290-29F484		\$5,331	\$5,862
	22	84	29	402	38	FLT2284-29F484	\$3,707		
	22	84	29	402	38	FLV2284-29F484		\$5,177	\$5,694

Features:

- eased edge profile user side
- pedestal front locking
- hinged door compartment has one adjustable shelf

Options:

- must specify chassis grain direction on artisan veneer, see pages 13-15 for details
- locking doors available, specify and add \$153 list
- veneer door and drawer fronts in paint available, specify paint color and add \$372; see page 16 for details
- on laminate units, contrasting worksurface tops and door fronts available, no upcharge; specify laminate color, see page 16 for details
- ledge pulls standard; prism pulls available, specify and see page 9
- oval grommets in back panel can be eliminated upon request, no upcharge
- interior horizontal wire manager with end grommets available, specify and add \$199 list; see page 40 for details
- top grommet available, specify location; add \$142 list each; see page 45 for details
- worksurface power available, specify "to accommodate EC26" on your purchase order; EC26 unit must be ordered separately, see page 45

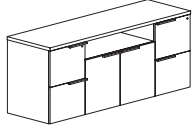
Storage Credenza with Open Center 	22	78	29	366	35	FLT2278-29F282	\$3,198		
	22	78	29	366	35	FLV2278-29F282		\$4,464	\$4,909
	22	72	29	344	32	FLT2272-29F282	\$3,105		
	22	72	29	344	32	FLV2272-29F282		\$4,334	\$4,769
	22	66	29	320	30	FLT2266-29F282	\$3,042		
	22	66	29	320	30	FLV2266-29F282		\$4,248	\$4,674
	22	60	29	298	27	FLT2260-29F282	\$2,982		
	22	60	29	298	27	FLV2260-29F282		\$4,163	\$4,580

Features:

- eased edge profile user side
- pedestal front locking
- hinged door compartment has one adjustable shelf

Options:

- must specify chassis grain direction on artisan veneer, see pages 13-15 for details
- locking doors available, specify and add \$153 list
- veneer door and drawer fronts in paint available, specify paint color and add \$372; see page 16 for details
- on laminate units, contrasting worksurface tops and door fronts available, no upcharge; specify laminate color, see page 16 for details
- ledge pulls standard; prism pulls available, specify and see page 9
- oval grommets in back panel can be eliminated upon request, no upcharge
- interior horizontal wire manager with end grommets available, specify and add \$199 list; see page 40 for details
- top grommet available, specify location; add \$142 list each; see page 45 for details
- worksurface power available, specify "to accommodate EC26" on your purchase order; EC26 unit must be ordered separately, see page 45

To Order, Specify:

① Laminate Model #	② Laminate Type	③ Laminate Selection	④ Metal Color	⑤ Other Product Options
Laminate (FLT)	HPL	See Laminate Selection	See Metal Finish Color Options	See list of options for each specific unit; Specify and add accordingly.
① Veneer Model #	② Wood Collection	③ Wood Finish	④ Metal Color	⑤ Other Product Options
Veneer (FLV)	Essentials	See Essentials Wood Finish Options	See Metal Finish Color Options	See list of options for each specific unit; Specify and add accordingly.
	Artisan	Ⓐ Wood Finish See Artisan Wood Finish Options	Ⓑ Chassis Grain Direction For Artisan Only: Vertical Horizontal	

Description	D	W	H	CTN WT	CU FT	① Model	HPL Laminate	Essentials Veneer	Artisan Veneer
Lateral File Credenza	22	90	29	448	40	FLT2290-29F444	\$3,477		
	22	90	29	448	40	FLV2290-29F444		\$4,847	\$5,332

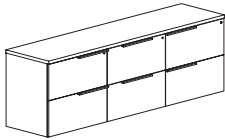

Features:

- eased edge profile user side
- pedestal front locking

Options:

- must specify chassis grain direction on artisan veneer, see pages 13-15 for details
- veneer drawer fronts in paint available, specify paint color and add \$372 list; see page 16 for details
- on laminate units, contrasting worksurface tops and drawer fronts available, no upcharge; specify color, see page 16 for details
- ledge pulls standard; prism pulls available, specify and see page 9
- oval grommets in back panel can be eliminated upon request, no upcharge
- top grommet available, specify location and add \$142 list each; see page 45 for details

Lateral File Credenza	22	72	29	354	32	FLT2272-29F44	\$2,599		
	22	72	29	354	32	FLV2272-29F44		\$3,629	\$3,992
	22	60	29	310	27	FLT2260-29F44	\$2,501		
	22	60	29	310	27	FLV2260-29F44		\$3,489	\$3,837

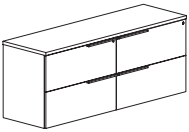

Features:

- eased edge profile user side
- pedestal front locking

Options:

- must specify chassis grain direction on artisan veneer, see pages 13-15 for details
- veneer drawer fronts in paint available, specify paint color and add \$372 list; see page 16 for details
- on laminate units, contrasting worksurface tops and drawer fronts available, no upcharge; specify color, see page 16 for details
- ledge pulls standard; prism pulls available, specify and see page 9
- oval grommets in back panel can be eliminated upon request, no upcharge
- top grommet available, specify location and add \$142 list each; see page 45 for details

Lateral File Pedestal	22	36	29	166	17	FLT2236-29F4	\$1,924		
	22	36	29	166	17	FLV2236-29F4		\$2,685	\$2,954
	22	30	29	150	14	FLT2230-29F4	\$1,648		
	22	30	29	150	17	FLV2230-29F4		\$2,300	\$2,530

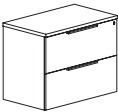

Features:

- eased edge profile user side
- pedestal front locking
- anti-tip interlock mechanism

Options:

- must specify chassis grain direction on artisan veneer, see pages 13-15 for details
- veneer drawer fronts in paint available, specify paint color and add \$372 list; see page 16 for details
- on laminate units, contrasting worksurface tops and drawer fronts available, no upcharge; specify color, see page 16 for details
- ledge pulls standard; prism pulls available, specify and see page 9
- oval grommet in back panel can be eliminated upon request, no upcharge
- top grommet available, specify location and add \$142 list each; see page 45 for details

FLUX

Description	D	W	H	CTN WT	CU FT	① Model	HPL Laminate	Essentials Veneer	Artisan Veneer
 Box/Box/Lateral File Pedestal	22	36	29	166	17	FLT2236-29F3	\$1,937		
	22	36	29	166	17	FLV2236-29F3		\$2,699	\$2,969
	22	30	29	150	14	FLT2230-29F3	\$1,661		
	22	30	29	150	17	FLV2230-29F3		\$2,312	\$2,544

Features:

- eased edge profile user side
- pedestal front locking
- anti-tip interlock mechanism

Options:

- must specify chassis grain direction on artisan veneer, see pages 13-15 for details
- veneer drawer fronts in paint available, specify paint color and add \$372 list; see page 16 for details
- on laminate units, contrasting worksurface tops and drawer fronts available, no upcharge; specify color, see page 16 for details
- ledge pulls standard; prism pulls available, specify and see page 9
- oval grommet in back panel can be eliminated upon request, no upcharge
- top grommet available, specify location and add \$142 list each; see page 45 for details

FLUX

To Order, Specify:

① Laminate Model #	② Laminate Type	③ Laminate Selection		④ Metal Color	⑤ Other Product Options
Laminate (FLT)	HPL	See Laminate Selection		See Metal Finish Color Options	See list of options for each specific unit; Specify and add accordingly.
① Veneer Model #	② Wood Collection	③ Wood Finish		④ Metal Color	⑤ Other Product Options
Veneer (FLV)	Essentials	See Essentials Wood Finish Options		See Metal Finish Color Options	See list of options for each specific unit; Specify and add accordingly.
	Artisan	ⓐ Wood Finish See Artisan Wood Finish Options	ⓑ Chassis Grain Direction For Artisan Only: Vertical Horizontal		

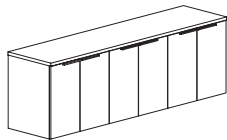
Description	D	W	H	CTN WT	CU FT	① Model	HPL Laminate	Essentials Veneer	Artisan Veneer
Six Door Storage Credenza 	22	96	29	386	43	FLT2296-29F777	\$3,169		
	22	96	29	386	43	FLV2296-29F777		\$4,659	\$5,127
	22	90	29	365	40	FLT2290-29F777	\$3,078		
	22	90	29	365	40	FLV2290-29F777		\$4,524	\$4,976
	22	84	29	344	38	FLT2284-29F777	\$2,999		
	22	84	29	344	38	FLV2284-29F777		\$4,410	\$4,851

Features:

- eased edge profile user side
- each hinged door compartment has one adjustable shelf

Options:

- must specify chassis grain direction on artisan veneer, see pages 13-15 for details
- locking doors available, specify and add \$459 list
- veneer door fronts in paint available, specify paint color and add \$372 list; see page 16 for details
- on laminate units, contrasting worksurface tops and door fronts available, no upcharge; specify color, see page 16 for details
- ledge pulls standard; prism pulls available, specify and see page 9
- oval grommets in back panel can be eliminated upon request, no upcharge
- interior horizontal wire manager with end grommets available, specify and add \$199 list; see page 40 for details
- top grommet available, specify location; add \$142 list each; see page 45 for details
- worksurface power available, specify "to accommodate EC26" on your purchase order; EC26 unit must be ordered separately, see page 45

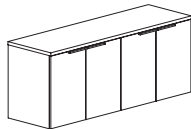
Four Door Storage Credenza 	22	78	29	312	34	FLT2278-29F77	\$2,753		
	22	78	29	312	34	FLV2278-29F77		\$4,044	\$4,448
	22	72	29	291	32	FLT2272-29F77	\$2,674		
	22	72	29	291	32	FLV2272-29F77		\$3,929	\$4,319
	22	66	29	270	29	FLT2266-29F77	\$2,566		
	22	66	29	270	29	FLV2266-29F77		\$3,770	\$4,148
	22	60	29	265	27	FLT2260-29F77	\$2,464		
	22	60	29	265	27	FLV2260-29F77		\$3,621	\$3,984

Features:

- eased edge profile user side
- each hinged door compartment has one adjustable shelf

Options:

- must specify chassis grain direction on artisan veneer, see pages 13-15 for details
- locking doors available, specify and add \$306 list
- veneer door fronts in paint available, specify paint color and add \$372 list; see page 16 for details
- on laminate units, contrasting worksurface tops and door fronts available, no upcharge; specify color, see page 16 for details
- ledge pulls standard; prism pulls available, specify and see page 9
- oval grommets in back panel can be eliminated upon request, no upcharge
- interior horizontal wire manager with end grommets available, specify and add \$199 list; see page 40 for details
- top grommet available, specify location; add \$142 list each; see page 45 for details
- worksurface power available, specify "to accommodate EC26" on your purchase order; EC26 unit must be ordered separately, see page 45

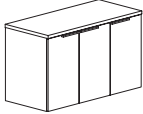
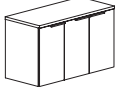
Description	D	W	H	CTN WT	CU FT	① Model	HPL Laminate	Essentials Veneer	Artisan Veneer
 right shown  left	22	54	29	228	24	FLT2254-29F77R	\$2,243		
	22	54	29	228	24	FLV2254-29F77R		\$3,293	\$3,623
	22	54	29	228	24	FLT2254-29F77L	\$2,243		
	22	54	29	228	24	FLV2254-29F77L		\$3,293	\$3,623
	22	48	29	206	22	FLT2248-29F77R	\$2,130		
	22	48	29	206	22	FLV2248-29F77R		\$3,129	\$3,446
	22	48	29	206	22	FLT2248-29F77L	\$2,130		
	22	48	29	206	22	FLV2248-29F77L		\$3,129	\$3,446
	22	42	29	185	19	FLT2242-29F77R	\$2,023		
	22	42	29	185	19	FLV2242-29F77R		\$2,972	\$3,271
	22	42	29	185	19	FLT2242-29F77L	\$2,023		
	22	42	29	185	19	FLV2242-29F77L		\$2,972	\$3,271

Features:

- eased edge profile user side
- each hinged door compartment has one adjustable shelf

Options:

- must specify chassis grain direction on artisan veneer, see pages 13-15 for details
- locking doors available, specify and add \$306 list
- veneer door fronts in paint available, specify paint color and add \$372 list; see page 16 for details
- on laminate units, contrasting worksurface tops and door fronts available, no upcharge; specify color, see page 16 for details
- ledge pulls standard; prism pulls available, specify and see page 9
- oval grommets in back panel can be eliminated upon request, no upcharge
- interior horizontal wire manager with end grommets available, specify and add \$199 list; see page 40 for details
- top grommet available, specify location; add \$142 list each; see page 45 for details
- worksurface power available, specify "to accommodate EC26" on your purchase order; EC26 unit must be ordered separately, see page 45
- pull out trash can available, specify and add \$503 list; see page 36 for details

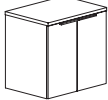
	22	36	29	156	17	FLT2236-29F7	\$1,438		
	22	36	29	156	17	FLV2236-29F7		\$2,114	\$2,325
	22	30	29	132	14	FLT2230-29F7	\$1,381		
	22	30	29	132	14	FLV2230-29F7		\$2,029	\$2,232

Features:

- eased edge profile user side
- each hinged door compartment has one adjustable shelf

Options:

- must specify chassis grain direction on artisan veneer, see pages 13-15 for details
- locking doors available, specify and add \$153 list
- veneer door fronts in paint available, specify paint color and add \$372 list; see page 16 for details
- on laminate units, contrasting worksurface tops and door fronts available, no upcharge; specify color, see page 16 for details
- ledge pulls standard; prism pulls available, specify and see page 9
- oval grommets in back panel can be eliminated upon request, no upcharge
- interior horizontal wire manager with end grommets available, specify and add \$199 list; see page 40 for details
- top grommet available, specify location; add \$142 list each; see page 45 for details
- worksurface power available, specify "to accommodate EC26" on your purchase order; EC26 unit must be ordered separately, see page 45

To Order, Specify:

① Laminate Model #	② Laminate Type	③ Laminate Selection	④ Metal Color	⑤ Other Product Options
Laminate (FLT)	HPL	See Laminate Selection	See Metal Finish Color Options	See list of options for each specific unit; Specify and add accordingly.
① Veneer Model #	② Wood Collection	③ Wood Finish	④ Metal Color	⑤ Other Product Options
Veneer (FLV)	Essentials	See Essentials Wood Finish Options	See Metal Finish Color Options	See list of options for each specific unit; Specify and add accordingly.
	Artisan	Ⓐ Wood Finish See Artisan Wood Finish Options	Ⓑ Chassis Grain Direction For Artisan Only: Vertical Horizontal	

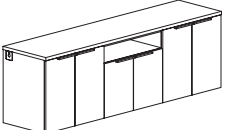
Description	D	W	H	CTN WT	CU FT	① Model	HPL Laminate	Essentials Veneer	Artisan Veneer
Six Door Credenza with Open Center 	22	96	29	394	43	FLT2296-29F787	\$3,303		
	22	96	29	394	43	FLV2296-29F787		\$4,609	\$5,070
	22	90	29	372	40	FLT2290-29F787	\$3,207		
	22	90	29	372	40	FLV2290-29F787		\$4,480	\$4,925
	22	84	29	353	38	FLT2284-29F787	\$3,114		
	22	84	29	353	38	FLV2284-29F787		\$4,346	\$4,779

Features:

- eased edge profile user side
- each hinged door compartment has one adjustable shelf

Options:

- must specify chassis grain direction on artisan veneer, see pages 13-15 for details
- locking doors available, specify and add \$459 list
- veneer door and drawer fronts in paint available, specify paint color and add \$372; see page 16 for details
- on laminate units, contrasting worksurface tops and door fronts available, no upcharge; specify color, see page 16 for details
- ledge pulls standard; prism pulls available, specify and see page 9
- oval grommets in back panel can be eliminated upon request, no upcharge
- interior horizontal wire manager with end grommets available, specify and add \$199 list; see page 40 for details
- top grommet available, specify location; add \$142 list each; see page 45 for details
- worksurface power available, specify "to accommodate EC26" on your purchase order; EC26 unit must be ordered separately, see page 45

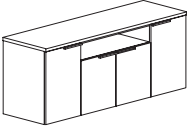
Four Door Credenza with Open Center 	22	78	29	339	35	FLT2278-29F787	\$2,848		
	22	78	29	339	35	FLV2278-29F787		\$4,185	\$4,605
	22	72	29	310	32	FLT2272-29F787	\$2,753		
	22	72	29	310	32	FLV2272-29F787		\$4,044	\$4,448
	22	66	29	288	30	FLT2266-29F787	\$2,671		
	22	66	29	288	30	FLV2266-29F787		\$3,925	\$4,318
	22	60	29	266	27	FLT2260-29F787	\$2,592		
	22	60	29	266	27	FLV2260-29F787		\$3,808	\$4,186

Features:

- eased edge profile user side
- each hinged door compartment has one adjustable shelf

Options:

- must specify chassis grain direction on artisan veneer, see pages 13-15 for details
- locking doors available, specify and add \$459 list
- veneer door and drawer fronts in paint available, specify paint color and add \$372; see page 16 for details
- on laminate units, contrasting worksurface tops and door fronts available, no upcharge; specify color, see page 16 for details
- ledge pulls standard; prism pulls available, specify and see page 9
- oval grommets in back panel can be eliminated upon request, no upcharge
- interior horizontal wire manager with end grommets available, specify and add \$199 list; see page 40 for details
- top grommet available, specify location; add \$142 list each; see page 45 for details
- worksurface power available, specify "to accommodate EC26" on your purchase order; EC26 unit must be ordered separately, see page 45
- pull out trash can available, specify and add \$503 list; see page 40 for details

FLUX

Description	D	W	H	CTN WT	CU FT	① Model	HPL Laminate	Essentials Veneer	Artisan Veneer
Two Door Credenza with Open Storage Compartment	22	54	29	228	25	FLT2254-29F707	\$2,358		
	22	54	29	228	25	FLV2254-29F707		\$3,462	\$3,812
	22	48	29	208	22	FLT2248-29F707	\$2,242		
	22	48	29	208	22	FLV2248-29F707		\$3,292	\$3,622
	22	42	29	189	19	FLT2242-29F707	\$2,129		
	22	42	29	189	19	FLV2242-29F707		\$3,127	\$3,442

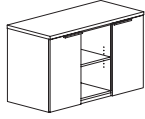

Features:

- eased edge profile user side
- each compartment has one adjustable shelf

Options:

- must specify chassis grain direction on artisan veneer, see pages 13-15 for details
- locking doors available, specify and add \$306 list
- veneer door fronts in paint available, specify paint color and add \$372 list; see page 16 for details
- on laminate units, contrasting worksurface tops and door fronts available, no upcharge; specify color, see page 16 for details
- ledge pulls standard; prism pulls available, specify and see page 9
- oval grommets in back panel can be eliminated upon request, no upcharge
- interior horizontal wire manager with end grommets available, specify and add \$199 list; see page 40 for details
- top grommet available, specify location; add \$142 list each; see page 45 for details
- worksurface power available, specify "to accommodate EC26" on your purchase order; EC26 unit must be ordered separately, see page 45
- pull out trash can available, specify and add \$503 list; see page 40 for details

FLUX

To Order, Specify:

① Laminate Model #	② Laminate Type	③ Laminate Selection	④ Metal Color	⑤ Other Product Options		
Laminate (FLT)	HPL	See Laminate Selection	See Metal Finish Color Options	See list of options for each specific unit; Specify and add accordingly.		
① Veneer Model #	② Wood Collection	③ Wood Finish	④ Metal Color	⑤ Other Product Options		
Veneer (FLV)	Essentials	See Essentials Wood Finish Options	See Metal Finish Color Options	See list of options for each specific unit; Specify and add accordingly.		
	Artisan	<table border="1"> <thead> <tr> <th>ⓐ Wood Finish</th> <th>ⓑ Chassis Grain Direction</th> </tr> </thead> <tbody> <tr> <td>See Artisan Wood Finish Options</td> <td>For Artisan Only: Vertical Horizontal</td> </tr> </tbody> </table>	ⓐ Wood Finish		ⓑ Chassis Grain Direction	See Artisan Wood Finish Options
ⓐ Wood Finish	ⓑ Chassis Grain Direction					
See Artisan Wood Finish Options	For Artisan Only: Vertical Horizontal					

Description	D	W	H	CTN WT	CU FT	① Model	HPL Laminate	Essentials Veneer	Artisan Veneer
Lateral File and Open Storage Credenza	22	96	29	426	43	FLT2296-29F044	\$3,396		
	22	96	29	426	43	FLV2296-29F044		\$4,737	\$5,213
	22	96	29	436	43	FLT2296-29F440	\$3,396		
	22	96	29	436	43	FLV2296-29F440		\$4,737	\$5,213
	22	90	29	409	40	FLT2290-29F044	\$3,292		
	22	90	29	409	40	FLV2290-29F044		\$4,596	\$5,057
	22	90	29	409	40	FLT2290-29F440	\$3,292		
	22	90	29	409	40	FLV2290-29F440		\$4,596	\$5,057

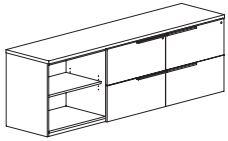

*044 shown

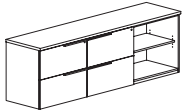

*440

Features:

- eased edge profile user side
- pedestal front locking
- open compartment with adjustable shelf
- shelf 12 1/2"d

Options:

- must specify chassis grain direction on artisan veneer, see pages 13-15 for details
- veneer drawer fronts in paint available, specify paint color and add \$372 list; see page 16 for details
- on laminate units, contrasting worksurface tops and drawer fronts available, no upcharge; specify color, see page 16 for details
- ledge pulls standard; prism pulls available, specify and see page 9
- oval grommets in back panel can be eliminated upon request, no upcharge
- interior horizontal wire manager with end grommets available, specify and add \$199 list; see page 40 for details
- top grommet available, specify location; add \$142 list each; see page 45 for details
- worksurface power available, specify "to accommodate EC26" on your purchase order; EC26 unit must be ordered separately, see page 45

Lateral File and Open Storage Credenza	22	72	29	295	32	FLT2272-29F04	\$2,617		
	22	72	29	295	32	FLV2272-29F04		\$3,653	\$4,019
	22	72	29	295	32	FLT2272-29F40	\$2,617		
	22	72	29	295	32	FLV2272-29F40		\$3,653	\$4,019
	22	66	29	273	30	FLT2266-29F04	\$2,489		
	22	66	29	273	30	FLV2266-29F04		\$3,472	\$3,818
	22	66	29	273	30	FLT2266-29F40	\$2,489		
	22	66	29	273	30	FLV2266-29F40		\$3,472	\$3,818
	22	60	29	256	27	FLT2260-29F04	\$2,365		
	22	60	29	256	27	FLV2260-29F04		\$3,296	\$3,627
	22	60	29	256	27	FLT2260-29F40	\$2,365		
	22	60	29	256	27	FLV2260-29F40		\$3,296	\$3,627

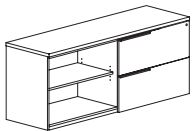

*04 shown

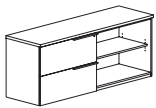

*40

Features:

- eased edge profile user side
- pedestal front locking
- open compartment with adjustable shelf
- shelf 12 1/2"d

Options:

- must specify chassis grain direction on artisan veneer, see pages 13-15 for details
- veneer drawer fronts in paint available, specify paint color and add \$372 list; see page 16 for details
- on laminate units, contrasting worksurface tops and drawer fronts available, no upcharge; specify color, see page 14 for details
- ledge pulls standard; prism pulls available, specify and see page 9
- oval grommets in back panel can be eliminated upon request, no upcharge
- interior horizontal wire manager with end grommets available, specify and add \$199 list; see page 40 for details
- top grommet available, specify location; add \$142 list each; see page 45 for details
- worksurface power available, specify "to accommodate EC26" on your purchase order; EC26 unit must be ordered separately, see page 44

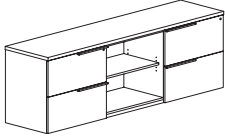
Description	D	W	H	CTN WT	CU FT	① Model	HPL Laminate	Essentials Veneer	Artisan Veneer
Lateral Files and Open Storage Credenza 	22	96	29	416	43	FLT2296-29F404	\$3,396		
	22	96	29	416	43	FLV2296-29F404		\$4,737	\$5,213
	22	90	29	399	40	FLT2290-29F404	\$3,292		
	22	90	29	399	40	FLV2290-29F404		\$4,596	\$5,057

Features:

- eased edge profile user side
- pedestal front locking
- open compartment with adjustable shelf
- shelf 12 1/2"d

Options:

- must specify chassis grain direction on artisan veneer, see pages 13-15 for details
- veneer drawer fronts in paint available, specify paint color and add \$372 list; see page 16 for details
- on laminate units, contrasting worksurface tops and drawer fronts available, no upcharge; specify color, see page 16 for details
- ledge pulls standard; prism pulls available, specify and see page 9
- oval grommets in back panel can be eliminated upon request, no upcharge
- interior horizontal wire manager with end grommets available, specify and add \$199 list; see page 40 for details
- top grommet available, specify location; add \$142 list each; see page 45 for details
- worksurface power available, specify "to accommodate EC26" on your purchase order; EC26 unit must be ordered separately, see page 45

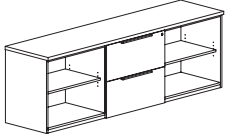
Description	D	W	H	CTN WT	CU FT	① Model	HPL Laminate	Essentials Veneer	Artisan Veneer
Lateral File and Open Storage Credenza 	22	96	29	375	43	FLT2296-29F040	\$3,148		
	22	96	29	375	43	FLV2296-29F040		\$4,396	\$4,835
	22	90	29	353	40	FLT2290-29F040	\$3,053		
	22	90	29	353	40	FLV2290-29F040		\$4,265	\$4,690

Features:

- eased edge profile user side
- pedestal front locking
- open compartment with adjustable shelf
- shelf 12 1/2"d

Options:

- must specify chassis grain direction on artisan veneer, see pages 13-15 for details
- veneer drawer fronts in paint available, specify paint color and add \$372 list; see page 16 for details
- on laminate units, contrasting worksurface tops and drawer fronts available, no upcharge; specify color, see page 16 for details
- ledge pulls standard; prism pulls available, specify and see page 9
- oval grommets in back panel can be eliminated upon request, no upcharge
- interior horizontal wire manager with end grommets available, specify and add \$199 list; see page 40 for details
- top grommet available, specify location; add \$142 list each; see page 45 for details
- worksurface power available, specify "to accommodate EC26" on your purchase order; EC26 unit must be ordered separately, see page 45

To Order, Specify:

① Laminate Model #	② Laminate Type	③ Laminate Selection	④ Metal Color	⑤ Other Product Options		
Laminate (FLT)	HPL	See Laminate Selection	See Metal Finish Color Options	See list of options for each specific unit; Specify and add accordingly.		
① Veneer Model #	② Wood Collection	③ Wood Finish	④ Metal Color	⑤ Other Product Options		
Veneer (FLV)	Essentials	See Essentials Wood Finish Options	See Metal Finish Color Options	See list of options for each specific unit; Specify and add accordingly.		
	Artisan	<table border="1"> <thead> <tr> <th>ⓐ Wood Finish</th> <th>ⓑ Chassis Grain Direction</th> </tr> </thead> <tbody> <tr> <td>See Artisan Wood Finish Options</td> <td>For Artisan Only: Vertical Horizontal</td> </tr> </tbody> </table>	ⓐ Wood Finish		ⓑ Chassis Grain Direction	See Artisan Wood Finish Options
ⓐ Wood Finish	ⓑ Chassis Grain Direction					
See Artisan Wood Finish Options	For Artisan Only: Vertical Horizontal					

FLUX

Description	D	W	H	CTN WT	CU FT	① Model	HPL Laminate	Essentials Veneer	Artisan Veneer
Double Sliding Door Credenza	22	90	29	345	40	FLT2290-29F909	\$2,728		
	22	90	29	345	40	FLV2290-29F909		\$4,007	\$4,409

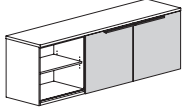
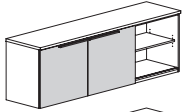
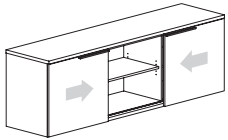

Features:

- eased edge profile user side
- locking doors not available
- each compartment has one adjustable shelf
- shelves 12 1/2" d

Options:

- must specify chassis grain direction on artisan veneer, see pages 13-15 for details
- veneer door fronts in paint available, specify paint color and add \$372 list; see page 16 for details
- on laminate units, contrasting worksurface tops and door fronts available, no upcharge; specify color, see page 16 for details
- ledge pulls standard; prism pulls available, specify and see page 9
- oval grommets in back panel can be eliminated upon request, no upcharge
- interior horizontal wire manager with end grommets available, specify and add \$199 list; see page 40 for details
- top grommet available, specify location; add \$142 list each; see page 45 for details
- worksurface power available, specify "to accommodate EC26" on your purchase order; EC26 unit must be ordered separately, see page 45

Sliding Door Credenza	22	90	29	327	40	FLT2290-29F090	\$2,592		
	22	90	29	327	40	FLV2290-29F090		\$3,808	\$4,186

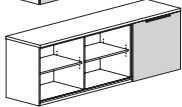
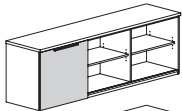
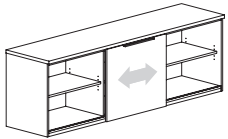

Features:

- eased edge profile user side
- locking doors not available
- each compartment has one adjustable shelf
- shelves 12 1/2" d

Options:

- must specify chassis grain direction on artisan veneer, see pages 13-15 for details
- veneer door fronts in paint available, specify paint color and add \$372 list; see page 16 for details
- on laminate units, contrasting worksurface tops and door fronts available, no upcharge; specify color, see page 16 for details
- ledge pulls standard; prism pulls available, specify and see page 9
- oval grommets in back panel can be eliminated upon request, no upcharge
- interior horizontal wire manager with end grommets available, specify and add \$199 list; see page 40 for details
- top grommet available, specify location; add \$142 list each; see page 45 for details
- worksurface power available, specify "to accommodate EC26" on your purchase order; EC26 unit must be ordered separately, see page 45

FLUX

Description	D	W	H	CTN WT	CU FT	① Model	HPL Laminate	Essentials Veneer	Artisan Veneer
Sliding Door Credenza	22	72	29	268	32	FLT2272-29F09	\$2,280		
	22	72	29	268	32	FLV2272-29F09		\$3,351	\$3,687
	22	60	29	228	27	FLT2260-29F09	\$2,152		
	22	60	29	228	27	FLV2260-29F09		\$3,162	\$3,477

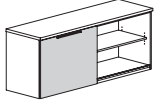
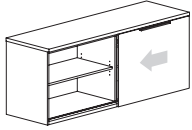

Features:

- eased edge profile user side
- locking doors not available
- each compartment has one adjustable shelf
- shelves 12 1/2"d

Options:

- must specify chassis grain direction on artisan veneer, see pages 13-15 for details
- veneer door fronts in paint available, specify paint color and add \$372 list; see page 16 for details
- on laminate units, contrasting worksurface tops and door fronts available, no upcharge; specify color, see page 16 for details
- ledge pulls standard; prism pulls available, specify and see page 9
- oval grommets in back panel can be eliminated upon request, no upcharge
- interior horizontal wire manager with end grommets available, specify and add \$199 list; see page 40 for details
- top grommet available, specify location; add \$142 list each; see page 45 for details
- worksurface power available, specify "to accommodate EC26" on your purchase order; EC26 unit must be ordered separately, see page 45

FLUX

To Order, Specify:

① Laminate Model #	② Laminate Type	③ Laminate Selection	④ Metal Color	⑤ Other Product Options		
Laminate (FLT)	HPL	See Laminate Selection	See Metal Finish Color Options	See list of options for each specific unit; Specify and add accordingly.		
① Veneer Model #	② Wood Collection	③ Wood Finish	④ Metal Color	⑤ Other Product Options		
Veneer (FLV)	Essentials	See Essentials Wood Finish Options	See Metal Finish Color Options	See list of options for each specific unit; Specify and add accordingly.		
	Artisan	<table border="1"> <thead> <tr> <th>ⓐ Wood Finish</th> <th>ⓑ Chassis Grain Direction</th> </tr> </thead> <tbody> <tr> <td>See Artisan Wood Finish Options</td> <td>For Artisan Only: Vertical Horizontal</td> </tr> </tbody> </table>	ⓐ Wood Finish		ⓑ Chassis Grain Direction	See Artisan Wood Finish Options
ⓐ Wood Finish	ⓑ Chassis Grain Direction					
See Artisan Wood Finish Options	For Artisan Only: Vertical Horizontal					

Description	D	W	H	CTN WT	CU FT	① Model	HPL Laminate	Essentials Veneer	Artisan Veneer
	22	96	29	325	43	FLT2296-29F000	\$2,424		
	22	96	29	325	43	FLV2296-29F000		\$3,562	\$3,919
	22	90	29	308	40	FLT2290-29F000	\$2,354		
	22	90	29	308	40	FLV2290-29F000		\$3,458	\$3,807

Features:

- eased edge profile user side
- each open compartment has one adjustable shelf
- shelves 12 1/2" d

Options:

- must specify chassis grain direction on artisan veneer, see pages 13-15 for details
- contrasting laminate worksurface tops, no upcharge; specify laminate color, see page 16 for details
- oval grommets in back panel can be eliminated upon request, no upcharge
- interior horizontal wire manager with end grommets available, specify and add \$199 list; see page 40 for details
- top grommet available, specify location and add \$142 list each; see page 45 for details
- worksurface power available, specify "to accommodate EC26" on your purchase order; EC26 unit must be ordered separately, see page 45

	22	72	29	245	32	FLT2272-29F00	\$2,146		
	22	72	29	245	32	FLV2272-29F00		\$3,156	\$3,470
	22	60	29	210	27	FLT2260-29F00	\$2,025		
	22	60	29	210	27	FLV2260-29F00		\$2,973	\$3,272

Features:

- eased edge profile user side
- each open compartment has one adjustable shelf
- shelves 12 1/2" d

Options:

- must specify chassis grain direction on artisan veneer, see pages 13-15 for details
- contrasting laminate worksurface tops, no upcharge; specify laminate color, see page 16 for details
- oval grommets in back panel can be eliminated upon request, no upcharge
- interior horizontal wire manager with end grommets available, specify and add \$199 list; see page 40 for details
- top grommet available, specify location and add \$142 list each; see page 45 for details
- worksurface power available, specify "to accommodate EC26" on your purchase order; EC26 unit must be ordered separately, see page 45

FLUX

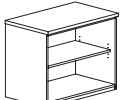
Description	D	W	H	CTN WT	CU FT	① Model	HPL Laminate	Essentials Veneer	Artisan Veneer
 Open Compartment	22	36	29	131	17	FLT2236-29F0	\$1,372		
	22	36	29	131	17	FLV2236-29F0		\$2,012	\$2,212
	22	30	29	113	14	FLT2230-29F0	\$1,317		
	22	30	29	113	14	FLV2230-29F0		\$1,936	\$2,130

Features:

- eased edge profile user side
- open compartment with adjustable shelf
- shelf 12 1/2" d

Options:

- must specify chassis grain direction on artisan veneer, see pages 13-15 for details
- contrasting laminate worksurface tops, no upcharge; specify laminate color, see page 16 for details
- oval grommet in back panel can be eliminated upon request, no upcharge
- top grommet available, specify location; add \$142 list each; see page 45 for details
- worksurface power available, specify "to accommodate EC26" on your purchase order; EC26 unit must be ordered separately, see page 45

FLUX

To Order, Specify:

① Laminate Model #	② Laminate Type	③ Laminate Selection	④ Metal Color	⑤ Other Product Options		
Laminate (FLT)	HPL	See Laminate Selection	See Metal Finish Color Options	See list of options for each specific unit; Specify and add accordingly.		
① Veneer Model #	② Wood Collection	③ Wood Finish	④ Metal Color	⑤ Other Product Options		
Veneer (FLV)	Essentials	See Essentials Wood Finish Options	See Metal Finish Color Options	See list of options for each specific unit; Specify and add accordingly.		
	Artisan	<table border="1"> <thead> <tr> <th>③a Wood Finish</th> <th>③b Chassis Grain Direction</th> </tr> </thead> <tbody> <tr> <td>See Artisan Wood Finish Options</td> <td>For Artisan Only: Vertical Horizontal</td> </tr> </tbody> </table>	③a Wood Finish		③b Chassis Grain Direction	See Artisan Wood Finish Options
③a Wood Finish	③b Chassis Grain Direction					
See Artisan Wood Finish Options	For Artisan Only: Vertical Horizontal					

Description	D	W	H	CTN WT	CU FT	① Model	HPL Laminate	Essentials Veneer	Artisan Veneer
Split Top Lateral File	22	96	29	336	43	FLT2296-29F4K4ST	\$3,925		
Kneespace Credenza	22	96	29	336	43	FLV2296-29F4K4ST		\$5,358	\$5,894
	22	90	29	328	40	FLT2290-29F4K4ST	\$3,836		
	22	90	29	328	40	FLV2290-29F4K4ST		\$5,234	\$5,762

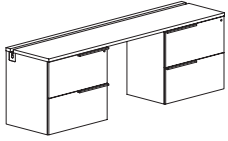

Features:

- eased edge profile user side
- built in horizontal wire channel
- 5”h back apron rail standard in kneespace
- pedestal front locking

Options:

- must specify chassis grain direction on artisan veneer, see pages 13-15 for details
- fixed half or full modesty panel available, specify style; add \$179 list for laminate panel or \$223 list for veneer panel, see page 25 for details
- removable modesty panel available, specify; add \$271 list for laminate or \$359 for veneer panel, see page 25 for details
- veneer drawer fronts in paint available, specify paint color and add \$372 list; see page 16 for details
- on laminate units, contrasting worksurface tops and drawer fronts available, no upcharge; specify color, see page 16 for details
- ledge pulls standard; prism pulls available, specify and see page 9

modesty panel options:

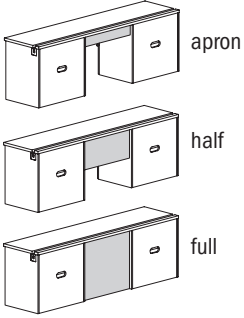

Description	D	W	H	CTN WT	CU FT	① Model	HPL Laminate	Essentials Veneer	Artisan Veneer
Lateral File Kneespace Credenza	22	96	29	343	43	FLT2296-29F4K4	\$3,622		
	22	96	29	343	43	FLV2296-29F4K4		\$5,055	\$5,560
	22	90	29	235	40	FLT2290-29F4K4	\$3,534		
	22	90	29	235	40	FLV2290-29F4K4		\$4,932	\$5,425

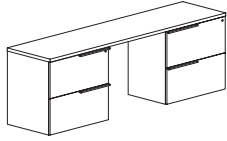

modesty panel options:

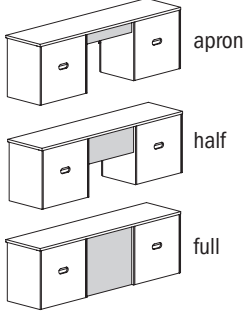

Features:

- eased edge profile user side
- 5”h back apron rail standard in kneespace
- pedestal front locking

Options:

- must specify chassis grain direction on artisan veneer, see pages 13-15 for details
- fixed half or full modesty panel available, specify style; add \$179 list for laminate panel or \$223 list for veneer panel, see page 25 for details
- removable modesty panel available, specify; add \$271 list for laminate or \$359 for veneer panel, see page 25 for details
- veneer drawer fronts in paint available, specify paint color and add \$372 list; see page 16 for details
- on laminate units, contrasting worksurface tops and drawer fronts available, no upcharge; specify color, see page 16 for details
- ledge pulls standard; prism pulls available, specify and see page 9
- interior horizontal wire manager with end grommets available, specify and add \$199 list; see page 40 for details
- top grommet available, specify location; add \$142 list each; see page 45 for details
- worksurface power available, specify “to accommodate EC26” on your purchase order; EC26 unit must be ordered separately, see page 45

FLUX

To Order, Specify:

① Laminate Model #	② Laminate Type	③ Laminate Selection	④ Metal Color	⑤ Other Product Options		
Laminate (FLT)	HPL	See Laminate Selection	See Metal Finish Color Options	See list of options for each specific unit; Specify and add accordingly.		
① Veneer Model #	② Wood Collection	③ Wood Finish	④ Metal Color	⑤ Other Product Options		
Veneer (FLV)	Essentials	See Essentials Wood Finish Options	See Metal Finish Color Options	See list of options for each specific unit; Specify and add accordingly.		
	Artisan	<table border="1"> <thead> <tr> <th>③a Wood Finish</th> <th>③b Chassis Grain Direction</th> </tr> </thead> <tbody> <tr> <td>See Artisan Wood Finish Options</td> <td>For Artisan Only: Vertical Horizontal</td> </tr> </tbody> </table>	③a Wood Finish		③b Chassis Grain Direction	See Artisan Wood Finish Options
③a Wood Finish	③b Chassis Grain Direction					
See Artisan Wood Finish Options	For Artisan Only: Vertical Horizontal					

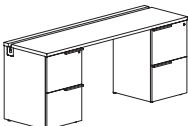
Description	D	W	H	CTN WT	CU FT	① Model	HPL Laminate	Essentials Veneer	Artisan Veneer
Split Top File/File	22	84	29	261	38	FLT2284-29F2K2ST	\$3,393		
Kneespace Credenza	22	84	29	261	38	FLV2284-29F2K2ST		\$4,615	\$5,076
	22	78	29	253	35	FLT2278-29F2K2ST	\$3,317		
	22	78	29	253	35	FLV2278-29F2K2ST		\$4,509	\$4,961
	22	72	29	245	32	FLT2272-29F2K2ST	\$3,244		
	22	72	29	245	32	FLV2272-29F2K2ST		\$4,407	\$4,847
	22	66	29	227	30	FLT2266-29F2K2ST	\$3,169		
	22	66	29	227	30	FLV2266-29F2K2ST		\$4,305	\$4,735
	22	60	29	219	27	FLT2260-29F2K2ST	\$3,097		
	22	60	29	219	27	FLV2260-29F2K2ST		\$4,204	\$4,625

modesty panel options:

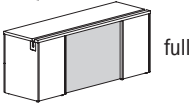
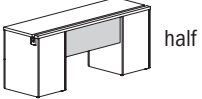
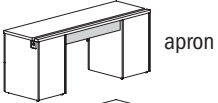

Features:

- eased edge profile user side
- built in horizontal wire channel
- 5”h back apron rail standard in kneespace
- pedestal front locking

Options:

- must specify chassis grain direction on artisan veneer, see pages 13-15 for details
- fixed half or full modesty panel available, specify style; add \$179 list for laminate panel or \$223 list for veneer panel, see page 25 for details
- removable modesty panel available, specify; add \$271 list for laminate or \$359 for veneer panel, see page 25 for details
- veneer drawer fronts in paint available, specify paint color and add \$372 list; see page 16 for details
- on laminate units, contrasting worksurface tops and drawer fronts available, no upcharge; specify color, see page 16 for details
- ledge pulls standard; prism pulls available, specify and see page 9

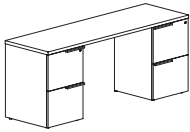
Description	D	W	H	CTN WT	CU FT	① Model	HPL Laminate	Essentials Veneer	Artisan Veneer
File/ File Kneespace Credenza 	22	84	29	265	38	FLT2284-29F2K2	\$3,090		
	22	84	29	265	38	FLV2284-29F2K2		\$4,312	\$4,740
	22	78	29	257	35	FLT2278-29F2K2	\$3,014		
	22	78	29	257	35	FLV2278-29F2K2		\$4,205	\$4,626
	22	72	29	249	32	FLT2272-29F2K2	\$2,942		
	22	72	29	249	32	FLV2272-29F2K2		\$4,102	\$4,513
	22	66	29	230	30	FLT2266-29F2K2	\$2,869		
	22	66	29	230	30	FLV2266-29F2K2		\$4,002	\$4,402
	22	60	29	222	27	FLT2260-29F2K2	\$2,792		
	22	60	29	222	27	FLV2260-29F2K2		\$3,899	\$4,291

modesty panel options:

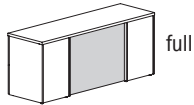
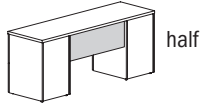
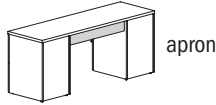

Features:

- eased edge profile user side
- 5”h back apron rail standard in kneespace
- pedestal front locking

Options:

- must specify chassis grain direction on artisan veneer, see pages 13-15 for details
- fixed half or full modesty panel available, specify style; add \$179 list for laminate panel or \$223 list for veneer panel, see page 25 for details
- removable modesty panel available, specify; add \$271 list for laminate or \$359 for veneer panel, see page 25 for details
- veneer drawer fronts in paint available, specify paint color and add \$372 list; see page 16 for details
- on laminate units, contrasting worksurface tops and drawer fronts available, no upcharge; specify color, see page 16 for details
- ledge pulls standard; prism pulls available, specify and see page 9
- interior horizontal wire manager with end grommets available, specify and add \$199 list; see page 40 for details
- top grommet available, specify location; add \$142 list each; see page 45 for details
- worksurface power available, specify “to accommodate EC26” on your purchase order; EC26 unit must be ordered separately, see page 45

FLUX

To Order, Specify:

① Laminate Model #	② Laminate Type	③ Laminate Selection	④ Metal Color	⑤ Other Product Options		
Laminate (FLT)	HPL	See Laminate Selection	See Metal Finish Color Options	See list of options for each specific unit; Specify and add accordingly.		
① Veneer Model #	② Wood Collection	③ Wood Finish	④ Metal Color	⑤ Other Product Options		
Veneer (FLV)	Essentials	See Essentials Wood Finish Options	See Metal Finish Color Options	See list of options for each specific unit; Specify and add accordingly.		
	Artisan	<table border="1"> <tr> <th>ⓐ Wood Finish</th> <th>ⓑ Chassis Grain Direction</th> </tr> <tr> <td>See Artisan Wood Finish Options</td> <td>For Artisan Only: Vertical Horizontal</td> </tr> </table>	ⓐ Wood Finish		ⓑ Chassis Grain Direction	See Artisan Wood Finish Options
ⓐ Wood Finish	ⓑ Chassis Grain Direction					
See Artisan Wood Finish Options	For Artisan Only: Vertical Horizontal					

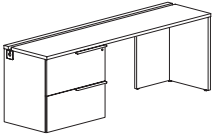
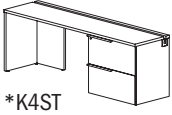
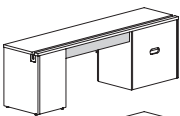
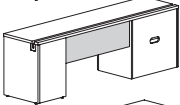
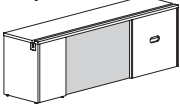
Description	D	W	H	CTN WT	CU FT	① Model	HPL Laminate	Essentials Veneer	Artisan Veneer
Lateral File Pedestal Credenza with Continuous Wire Channel - Split Top	22	96	29	269	43	FLT2296-29FK4ST	\$2,995		
	22	96	29	269	43	FLV2296-29FK4ST		\$4,060	\$4,465
 *4KST shown  *K4ST modesty panel options:  apron  half  full	22	96	29	269	43	FLT2296-29F4KST	\$2,995		
	22	96	29	269	43	FLV2296-29F4KST		\$4,060	\$4,465
	22	90	29	261	40	FLT2290-29FK4ST	\$2,914		
	22	90	29	261	40	FLV2290-29FK4ST		\$3,951	\$4,343
	22	90	29	261	40	FLT2290-29F4KST	\$2,914		
	22	90	29	261	40	FLV2290-29F4KST		\$3,951	\$4,343
	22	84	29	254	38	FLT2284-29FK4ST	\$2,835		
	22	84	29	254	38	FLV2284-29FK4ST		\$3,837	\$4,224
	22	84	29	254	38	FLT2284-29F4KST	\$2,835		
	22	84	29	254	38	FLV2284-29F4KST		\$3,837	\$4,224
	22	78	29	246	35	FLT2278-29FK4ST	\$2,761		
	22	78	29	246	35	FLV2278-29FK4ST		\$3,734	\$4,106
	22	78	29	246	35	FLT2278-29F4KST	\$2,761		
	22	78	29	246	35	FLV2278-29F4KST		\$3,734	\$4,106
	22	72	29	238	32	FLT2272-29FK4ST	\$2,686		
	22	72	29	238	32	FLV2272-29FK4ST		\$3,630	\$3,995
	22	72	29	238	32	FLT2272-29F4KST	\$2,686		
	22	72	29	238	32	FLV2272-29F4KST		\$3,630	\$3,995

Features:

- eased edge profile user side
- built in horizontal wire channel
- 5”h back apron rail standard in kneespace
- pedestal front locking

Options:

- must specify chassis grain direction on artisan veneer, see pages 13-15 for details
- fixed half or full modesty panel available, specify style; add \$179 list for laminate panel or \$223 list for veneer panel, see page 25 for details
- removable modesty panel available, specify; add \$271 list for laminate or \$359 for veneer panel, see page 25 for details
- veneer drawer fronts in paint available, specify paint color and add \$372 list; see page 16 for details
- on laminate units, contrasting worksurface tops and drawer fronts available, no upcharge; specify color, see page 16 for details
- ledge pulls standard; prism pulls available, specify and see page 9
- knee clearance end panel available 13” depth, specify; no upcharge

FLUX

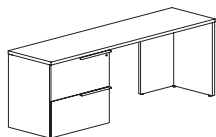
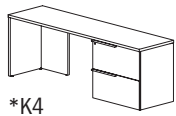
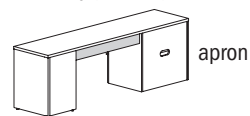
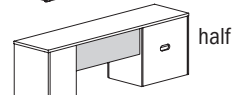
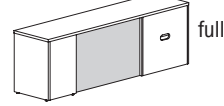
Description	D	W	H	CTN WT	CU FT	① Model	HPL Laminate	Essentials Veneer	Artisan Veneer
 <p>*4K shown</p>  <p>*K4</p> <p>modesty panel options:</p>  <p>apron</p>  <p>half</p>  <p>full</p>	22	96	29	275	43	FLT2296-29FK4	\$2,691		
	22	96	29	275	43	FLV2296-29FK4		\$3,756	\$4,132
	22	96	29	275	43	FLT2296-29F4K	\$2,691		
	22	96	29	275	43	FLV2296-29F4K		\$3,756	\$4,132
	22	90	29	267	40	FLT2290-29FK4	\$2,611		
	22	90	29	267	40	FLV2290-29FK4		\$3,646	\$4,009
	22	90	29	267	40	FLT2290-29F4K	\$2,611		
	22	90	29	267	40	FLV2290-29F4K		\$3,646	\$4,009
	22	84	29	259	38	FLT2284-29FK4	\$2,532		
	22	84	29	259	38	FLV2284-29FK4		\$3,535	\$3,889
	22	84	29	259	38	FLT2284-29F4K	\$2,532		
	22	84	29	259	38	FLV2284-29F4K		\$3,535	\$3,889
	22	78	29	251	35	FLT2278-29FK4	\$2,459		
	22	78	29	251	35	FLV2278-29FK4		\$3,430	\$3,774
	22	78	29	251	35	FLT2278-29F4K	\$2,459		
	22	78	29	251	35	FLV2278-29F4K		\$3,430	\$3,774
	22	72	29	243	32	FLT2272-29FK4	\$2,384		
	22	72	29	243	32	FLV2272-29FK4		\$3,327	\$3,658
22	72	29	243	32	FLT2272-29F4K	\$2,384			
22	72	29	243	32	FLV2272-29F4K		\$3,327	\$3,658	

Features:

- eased edge profile user side
- 5”h back apron rail standard in kneespace
- pedestal front locking

Options:

- must specify chassis grain direction on artisan veneer, see pages 13-15 for details
- fixed half or full modesty panel available, specify style; add \$179 list for laminate panel or \$223 list for veneer panel, see page 25 for details
- removable modesty panel available, specify; add \$271 list for laminate or \$359 for veneer panel, see page 25 for details
- veneer drawer fronts in paint available, specify paint color and add \$372 list; see page 16 for details
- on laminate units, contrasting worksurface tops and drawer fronts available, no upcharge; specify color, see page 16 for details
- ledge pulls standard; prism pulls available, specify and see page 9
- interior horizontal wire manager with end grommets available, specify and add \$199 list; see page 40 for details
- top grommet available, specify location; add \$142 list each; see page 45 for details
- worksurface power available, specify “to accommodate EC26” on your purchase order; EC26 unit must be ordered separately, see page 45
- knee clearance end panel available 13” depth, specify; no upcharge

To Order, Specify:

① Laminate Model #	② Laminate Type	③ Laminate Selection	④ Metal Color	⑤ Other Product Options		
Laminate (FLT)	HPL	See Laminate Selection	See Metal Finish Color Options	See list of options for each specific unit; Specify and add accordingly.		
① Veneer Model #	② Wood Collection	③ Wood Finish	④ Metal Color	⑤ Other Product Options		
Veneer (FLV)	Essentials	See Essentials Wood Finish Options	See Metal Finish Color Options	See list of options for each specific unit; Specify and add accordingly.		
	Artisan	<table border="1"> <tr> <th>ⓐ Wood Finish</th> <th>ⓑ Chassis Grain Direction</th> </tr> <tr> <td>See Artisan Wood Finish Options</td> <td>For Artisan Only: Vertical Horizontal</td> </tr> </table>	ⓐ Wood Finish		ⓑ Chassis Grain Direction	See Artisan Wood Finish Options
ⓐ Wood Finish	ⓑ Chassis Grain Direction					
See Artisan Wood Finish Options	For Artisan Only: Vertical Horizontal					

Description	D	W	H	CTN WT	CU FT	① Model	HPL Laminate	Essentials Veneer	Artisan Veneer
File/File Pedestal Credenza with Continuous Wire Channel - Split Top	22	84	29	224	38	FLT2284-29FK2ST	\$2,677		
	22	84	29	224	38	FLV2284-29FK2ST		\$3,615	\$3,977
	22	84	29	224	38	FLT2284-29F2KST	\$2,677		
	22	84	29	224	38	FLV2284-29F2KST		\$3,615	\$3,977
	22	78	29	216	35	FLT2278-29FK2ST	\$2,606		
	22	78	29	216	35	FLV2278-29FK2ST		\$3,518	\$3,870
	22	78	29	216	35	FLT2278-29F2KST	\$2,606		
	22	78	29	216	35	FLV2278-29F2KST		\$3,518	\$3,870
	22	72	29	208	32	FLT2272-29FK2ST	\$2,538		
	22	72	29	208	32	FLV2272-29FK2ST		\$3,417	\$3,763
	22	72	29	208	32	FLT2272-29F2KST	\$2,538		
	22	72	29	208	32	FLV2272-29F2KST		\$3,417	\$3,763
	22	66	29	193	30	FLT2266-29FK2ST	\$2,469		
	22	66	29	193	30	FLV2266-29FK2ST		\$3,327	\$3,658
	22	66	29	193	30	FLT2266-29F2KST	\$2,469		
	22	66	29	193	30	FLV2266-29F2KST		\$3,327	\$3,658
	22	60	29	185	27	FLT2260-29FK2ST	\$2,404		
	22	60	29	185	27	FLV2260-29FK2ST		\$3,237	\$3,559
22	60	29	185	27	FLT2260-29F2KST	\$2,404			
22	60	29	185	27	FLV2260-29F2KST		\$3,237	\$3,559	

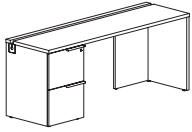

*2KST shown

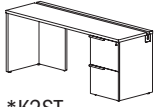

*K2ST

modesty panel options:

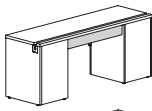

apron

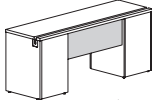

half

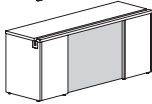

full

Features:

- eased edge profile user side
- built in horizontal wire channel
- 5”h back apron rail standard in kneespace
- pedestal front locking

Options:

- must specify chassis grain direction on artisan veneer, see pages 13-15 for details
- fixed half or full modesty panel available, specify style; add \$179 list for laminate panel or \$223 list for veneer panel, see page 25 for details
- removable modesty panel available, specify; add \$271 list for laminate or \$359 for veneer panel, see page 25 for details
- veneer drawer fronts in paint available, specify paint color and add \$372 list; see page 16 for details
- on laminate units, contrasting worksurface tops and drawer fronts available, no upcharge; specify color, see page 16 for details
- ledge pulls standard; prism pulls available, specify and see page 9
- knee clearance end panel available 13” depth, specify; no upcharge

FLUX

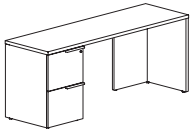
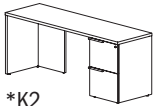
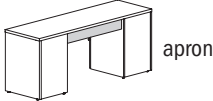
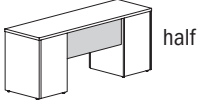
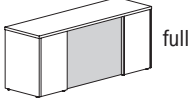
Description	D	W	H	CTN WT	CU FT	① Model	HPL Laminate	Essentials Veneer	Artisan Veneer
 <p>*2K shown</p>  <p>*K2</p> <p>modesty panel options:</p>  <p>apron</p>  <p>half</p>  <p>full</p>	22	84	29	228	38	FLT2284-29FK2	\$2,371		
	22	84	29	228	38	FLV2284-29FK2		\$3,314	\$3,645
	22	84	29	228	38	FLT2284-29F2K	\$2,371		
	22	84	29	228	38	FLV2284-29F2K		\$3,314	\$3,645
	22	78	29	220	35	FLT2278-29FK2	\$2,301		
	22	78	29	220	35	FLV2278-29FK2		\$3,212	\$3,535
	22	78	29	220	35	FLT2278-29F2K	\$2,301		
	22	78	29	220	35	FLV2278-29F2K		\$3,212	\$3,535
	22	72	29	212	32	FLT2272-29FK2	\$2,234		
	22	72	29	212	32	FLV2272-29FK2		\$3,117	\$3,429
	22	72	29	212	32	FLT2272-29F2K	\$2,234		
	22	72	29	212	32	FLV2272-29F2K		\$3,117	\$3,429
	22	66	29	200	30	FLT2266-29FK2	\$2,165		
	22	66	29	200	30	FLV2266-29FK2		\$3,026	\$3,326
	22	66	29	200	30	FLT2266-29F2K	\$2,165		
	22	66	29	200	30	FLV2266-29F2K		\$3,026	\$3,326
	22	60	29	192	27	FLT2260-29FK2	\$2,103		
	22	60	29	192	27	FLV2260-29FK2		\$2,930	\$3,228
22	60	29	192	27	FLT2260-29F2K	\$2,103			
22	60	29	192	27	FLV2260-29F2K		\$2,930	\$3,228	

Features:

- eased edge profile user side
- 5”h back apron rail standard in kneespace
- pedestal front locking

Options:

- must specify chassis grain direction on artisan veneer, see pages 13-15 for details
- fixed half or full modesty panel available, specify style; add \$179 list for laminate panel or \$223 list for veneer panel, see page 25 for details
- removable modesty panel available, specify; add \$271 list for laminate or \$359 for veneer panel, see page 25 for details
- veneer drawer fronts in paint available, specify paint color and add \$372 list; see page 16 for details
- on laminate units, contrasting worksurface tops and drawer fronts available, no upcharge; specify color, see page 16 for details
- ledge pulls standard; prism pulls available, specify and see page 9
- interior horizontal wire manager with end grommets available, specify and add \$199 list; see page 40 for details
- top grommet available, specify location; add \$142 list each; see page 45 for details
- worksurface power available, specify “to accommodate EC26” on your purchase order; EC26 unit must be ordered separately, see page 45
- knee clearance end panel available 13” depth, specify; no upcharge

To Order, Specify:

① Laminate Model #	② Laminate Type	③ Laminate Selection	④ Metal Color	⑤ Other Product Options		
Laminate (FLT)	HPL	See Laminate Selection	See Metal Finish Color Options	See list of options for each specific unit; Specify and add accordingly.		
① Veneer Model #	② Wood Collection	③ Wood Finish	④ Metal Color	⑤ Other Product Options		
Veneer (FLV)	Essentials	See Essentials Wood Finish Options	See Metal Finish Color Options	See list of options for each specific unit; Specify and add accordingly.		
	Artisan	<table border="1"> <tr> <th>ⓐ Wood Finish</th> <th>ⓑ Chassis Grain Direction</th> </tr> <tr> <td>See Artisan Wood Finish Options</td> <td>For Artisan Only: Vertical Horizontal</td> </tr> </table>	ⓐ Wood Finish		ⓑ Chassis Grain Direction	See Artisan Wood Finish Options
ⓐ Wood Finish	ⓑ Chassis Grain Direction					
See Artisan Wood Finish Options	For Artisan Only: Vertical Horizontal					

Description	D	W	H	CTN WT	CU FT	① Model	HPL Laminate	Essentials Veneer	Artisan Veneer
	22	72	29	151	32	FLT2272-29FK	\$1,511		
	22	72	29	151	32	FLV2272-29FK		\$2,286	\$2,514
	22	66	29	142	30	FLT2266-29FK	\$1,466		
	22	66	29	142	30	FLV2266-29FK		\$2,220	\$2,441

Features:

- freestanding shell, modular pedestal units below and on the following two pages may be ordered: see page 39 for details
- eased edge profile user side

Options:

- must specify chassis grain direction on artisan veneer, see pages 13-15 for details
- top grommet available, specify location and add \$142 list each; see page 46 for details

	20 ¹⁵ / ₁₆	18	28	74	9	FLT2118-CSM2	\$1,232		
	20 ¹⁵ / ₁₆	18	28	74	9	FLV2118-CSM2		\$1,847	\$2,035
	20 ¹⁵ / ₁₆	15 ⁵ / ₁₆	28	74	9	FLT2116-CSM2	\$1,218		
	20 ¹⁵ / ₁₆	15 ⁵ / ₁₆	28	74	9	FLV2116-CSM2		\$1,829	\$2,011

Features:

- use inside of credenza shells or return shells, see page 39
- pedestal front locking

Options:

- must specify chassis grain direction on artisan veneer, see pages 13-15 for details
- veneer drawer fronts in paint available, specify paint color and add \$372 list; see page 16 for details
- on laminate units, contrasting fronts available, no upcharge; specify color, see page 16 for details
- ledge pulls standard; prism pulls available, specify and see page 9

	20 ¹⁵ / ₁₆	18	28	87	9	FLT2118-CSM1	\$1,238		
	20 ¹⁵ / ₁₆	18	28	87	9	FLV2118-CSM1		\$1,859	\$2,045
	20 ¹⁵ / ₁₆	15 ⁵ / ₁₆	28	80	8	FLT2116-CSM1	\$1,224		
	20 ¹⁵ / ₁₆	15 ⁵ / ₁₆	28	80	8	FLV2116-CSM1		\$1,837	\$2,019

Features:

- use inside of credenza shells or return shells, see page 39
- pedestal front locking

Options:

- must specify chassis grain direction on artisan veneer, see pages 13-15 for details
- veneer drawer fronts in paint available, specify paint color and add \$372 list; see page 16 for details
- on laminate units, contrasting fronts available, no upcharge; specify color, see page 16 for details
- ledge pulls standard; prism pulls available, specify and see page 9

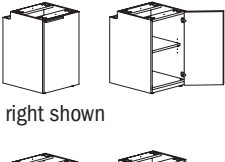
 <p>right shown</p> <p>left</p>	20 ¹⁵ / ₁₆	18	28	68	8	FLT2118-CSM7R	\$762		
	20 ¹⁵ / ₁₆	18	28	68	8	FLV2118-CSM7R		\$1,145	\$1,259
	20 ¹⁵ / ₁₆	18	28	68	8	FLT2118-CSM7L	\$762		
	20 ¹⁵ / ₁₆	18	28	68	8	FLV2118-CSM7L		\$1,145	\$1,259
	20 ¹⁵ / ₁₆	15 ⁵ / ₁₆	28	141	16	FLT2116-CSM7R	\$749		
	20 ¹⁵ / ₁₆	15 ⁵ / ₁₆	28	141	16	FLV2116-CSM7R		\$1,123	\$1,235
	20 ¹⁵ / ₁₆	15 ⁵ / ₁₆	28	129	14	FLT2116-CSM7L	\$749		
	20 ¹⁵ / ₁₆	15 ⁵ / ₁₆	28	129	14	FLV2116-CSM7L		\$1,123	\$1,235

Features:

- use inside of credenza shells or return shells, see page 39

Options:

- hinged door compartment has one adjustable shelf
- must specify chassis grain direction on artisan veneer, see pages 13-15 for details
- locking door available, specify and add \$153 list
- veneer door fronts in paint available, specify paint color and add \$372 list; see page 16 for details
- on laminate units, contrasting fronts available, no upcharge; specify color, see page 16 for details
- ledge pulls standard; prism pulls available, specify and see page 9

Description	D	W	H	CTN WT	CU FT	① Model	HPL Laminate	Essentials Veneer	Artisan Veneer
Modular Lateral Credenza	20 ¹⁵ / ₁₆	36	28	141	16	FLT2136-CSM4	\$1,498		
Shell Pedestal	20 ¹⁵ / ₁₆	36	28	141	16	FLV2136-CSM4		\$2,245	\$2,470
	20 ¹⁵ / ₁₆	30	28	128	14	FLT2130-CSM4	\$1,460		
	20 ¹⁵ / ₁₆	30	28	128	14	FLV2130-CSM4		\$2,190	\$2,411

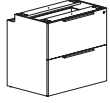

Features:

- use inside of credenza shells or return shells, see page 39
- pedestal front locking

Options:

- must specify chassis grain direction on artisan veneer, see pages 13-15 for details
- veneer drawer fronts in paint available, specify paint color and add \$372 list; see page 16 for details
- on laminate units, contrasting fronts available, no upcharge; specify color, see page 16 for details
- ledge pulls standard; prism pulls available, specify and see page 9

Modular Lateral Credenza	20 ¹⁵ / ₁₆	36	28	141	16	FLT2136-CSM3	\$1,505		
Shell Pedestal	20 ¹⁵ / ₁₆	36	28	141	16	FLV2136-CSM3		\$2,258	\$2,484
	20 ¹⁵ / ₁₆	30	28	128	14	FLT2130-CSM3	\$1,466		
	20 ¹⁵ / ₁₆	30	28	128	14	FLV2130-CSM3		\$2,201	\$2,423



Features:

- use inside of credenza shells or return shells, see page 39
- pedestal front locking

Options:

- must specify chassis grain direction on artisan veneer, see pages 13-15 for details
- veneer drawer fronts in paint available, specify paint color and add \$372 list; see page 16 for details
- on laminate units, contrasting fronts available, no upcharge; specify color, see page 16 for details
- ledge pulls standard; prism pulls available, specify and see page 9

FLUX

To Order, Specify:

① Laminate Model #	② Laminate Type	③ Laminate Selection	④ Metal Color	⑤ Other Product Options		
Laminate (FLT)	HPL	See Laminate Selection	See Metal Finish Color Options	See list of options for each specific unit; Specify and add accordingly.		
① Veneer Model #	② Wood Collection	③ Wood Finish	④ Metal Color	⑤ Other Product Options		
Veneer (FLV)	Essentials	See Essentials Wood Finish Options	See Metal Finish Color Options	See list of options for each specific unit; Specify and add accordingly.		
	Artisan	<table border="1"> <thead> <tr> <th>ⓐ Wood Finish</th> <th>ⓑ Chassis Grain Direction</th> </tr> </thead> <tbody> <tr> <td>See Artisan Wood Finish Options</td> <td>For Artisan Only: Vertical Horizontal</td> </tr> </tbody> </table>	ⓐ Wood Finish		ⓑ Chassis Grain Direction	See Artisan Wood Finish Options
ⓐ Wood Finish	ⓑ Chassis Grain Direction					
See Artisan Wood Finish Options	For Artisan Only: Vertical Horizontal					

Description	D	W	H	CTN WT	CU FT	① Model	HPL Laminate	Essentials Veneer	Artisan Veneer
Modular Credenza Shell	20 15/16	30	28	138	14	FLT2130-CSMRM	\$1,586		
Multi-File Pedestal	20 15/16	30	28	138	14	FLV2130-CSMRM		\$2,382	\$2,620
	20 15/16	30	28	138	14	FLT2130-CSMLM	\$1,586		
	20 15/16	30	28	138	14	FLV2130-CSMLM		\$2,382	\$2,620



right shown



left

Features:

- use inside of credenza shells or return shells, see page 39
- pedestal front locking

Options:

- must specify chassis grain direction on artisan veneer, see pages 13-15 for details
- veneer drawer fronts in paint available, specify paint color and add \$372 list; see page 16 for details
- on laminate units, contrasting fronts available, no upcharge; specify color, see page 16 for details
- ledge pulls standard; prism pulls available, specify and see page 9

Modular Hinge Door Credenza Shell Pedestal	20 15/16	36	28	122	16	FLT2136-CSM7	\$1,270		
	20 15/16	36	28	122	16	FLV2136-CSM7		\$1,906	\$2,093
	20 15/16	30	28	108	14	FLT2130-CSM7	\$1,218		
	20 15/16	30	28	108	14	FLV2130-CSM7		\$1,830	\$2,012

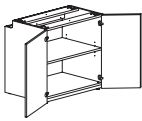

Features:

- use inside of credenza shells or return shells, see page 39
- hinged door compartment has one adjustable shelf

Options:

- must specify chassis grain direction on artisan veneer, see pages 13-15 for details
- locking doors available, specify and add \$153 list
- veneer door fronts in paint available, specify paint color and add \$372 list; see page 16 for details
- on laminate units, contrasting laminate door fronts available, no upcharge; specify laminate color, see page 16 for details
- ledge pulls standard; prism pulls available, specify and see page 9

Modular Hinge Door Credenza Shell Pedestal	20 15/16	36	28	132	16	FLT2136-CSM8	\$1,289		
	20 15/16	36	28	132	16	FLV2136-CSM8		\$1,934	\$2,129
	20 15/16	30	28	116	14	FLT2130-CSM8	\$1,239		
	20 15/16	30	28	116	14	FLV2130-CSM8		\$1,862	\$2,047

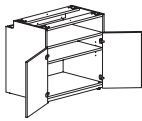

Features:

- use inside of credenza shells or return shells, see page 39
- hinged door compartment has one adjustable shelf

Options:

- must specify chassis grain direction on artisan veneer, see pages 13-15 for details
- locking doors available, specify and add \$153 list
- veneer door fronts in paint available, specify paint color and add \$372 list; see page 16 for details
- on laminate units, contrasting laminate door fronts available, no upcharge; specify laminate color, see page 16 for details
- ledge pulls standard; prism pulls available, specify and see page 9

Modular Open Credenza Shell Compartment	20 15/16	36	28	101	16	FLT2136-CSMO	\$1,124		
	20 15/16	36	28	101	16	FLV2136-CSMO		\$1,688	\$1,858
	20 15/16	30	28	91	14	FLT2130-CSMO	\$1,098		
	20 15/16	30	28	91	14	FLV2130-CSMO		\$1,647	\$1,812



Features:

- use inside of credenza shells or return shells, see page 39
- compartment has one adjustable shelf

Options:

- must specify chassis grain direction on artisan veneer, see pages 13-15 for details

Description	D	W	H	CTN WT	CU FT	① Model	HPL Laminate	Essentials Veneer	Artisan Veneer
Mobile Pedestal	18	15½	25	91	6	FLT1816-25FMP	\$1,487		
	18	15½	25	91	6	FLV1816-25FMP		\$1,993	\$2,191



Features:

- box, box file only; letter width pedestal
- pedestal front locking
- no additional top needed
- dual wheel casters

Options:

- must specify chassis grain direction on artisan veneer, see pages 13-15 for details
- ledge pulls standard; prism pulls available, specify and see page 9

Box/File Mobile Pedestal	18	15¾	21	67	5	FLT1816-21FMP	\$1,338		
	18	15¾	21	67	5	FLV1816-21FMP		\$1,865	\$2,050



Features:

- dual wheel casters
- pedestal front locking

Options:

- must specify chassis grain direction on artisan veneer, see pages 13-15 for details
- veneer drawer fronts in paint available, specify paint color and add \$372 list; see page 16 for details
- on laminate units, contrasting fronts available, no upcharge; specify color, see page 16 for details
- ledge pulls standard; prism pulls available, specify and see page 9
- round or square seat cushion available, see page 17 for more details and page 213 for pricing

Mobile Pedestal - Top Storage	12¾	15¾	22	65	7	FLT1816-21FMPT	\$1,467		
	12¾	15¾	22	65	7	FLV1816-21FMPT		\$2,006	\$2,205



Features:

- pedestal front locking

Options:

- must specify chassis grain direction on artisan veneer, see pages 13-15 for details
- veneer drawer front available in contrasting paint color, specify paint color and add \$372 list
- laminate drawer fronts available in contrasting color, no upcharge, specify color; see pages 14 for details

To Order, Specify:

① Laminate Model #	② Laminate Type	③ Laminate Selection	④ Metal Color	⑤ Other Product Options		
Laminate (FLT)	HPL	See Laminate Selection	See Metal Finish Color Options	See list of options for each specific unit; Specify and add accordingly.		
① Veneer Model #	② Wood Collection	③ Wood Finish	④ Metal Color	⑤ Other Product Options		
Veneer (FLV)	Essentials	See Essentials Wood Finish Options	See Metal Finish Color Options	See list of options for each specific unit; Specify and add accordingly.		
	Artisan	<table border="1"> <thead> <tr> <th>ⓐ Wood Finish</th> <th>ⓑ Chassis Grain Direction</th> </tr> </thead> <tbody> <tr> <td>See Artisan Wood Finish Options</td> <td>For Artisan Only: Vertical Horizontal</td> </tr> </tbody> </table>	ⓐ Wood Finish		ⓑ Chassis Grain Direction	See Artisan Wood Finish Options
ⓐ Wood Finish	ⓑ Chassis Grain Direction					
See Artisan Wood Finish Options	For Artisan Only: Vertical Horizontal					

Description	D	W	H	CTN WT	CU FT	① Model	HPL Laminate	Essentials Veneer	Artisan Veneer
Split Top Box/File Kneespace	22	96	29	314	43	FLT2296-29L6K6ST	\$4,298		
Credenza - Flush Legs	22	96	29	314	43	FLV2296-29L6K6ST		\$5,490	\$6,038
	22	90	29	307	40	FLT2290-29L6K6ST	\$4,182		
	22	90	29	307	40	FLV2290-29L6K6ST		\$5,339	\$5,872

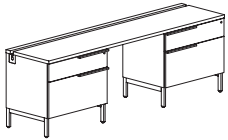

modesty panel options:

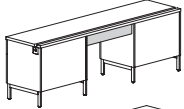

apron

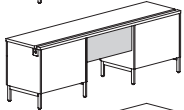

half

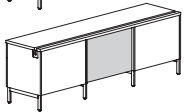

full

Features:

- eased edge profile user side
- built in horizontal wire channel
- 5”h back apron rail standard in kneespace
- pedestal front locking

Options:

- must specify chassis grain direction on artisan veneer, see pages 13-15 for details
- concealed box drawer(s) available, specify location in unit; add \$259 list for each laminate drawer or \$394 for each veneer drawer, see page 25 for details
- fixed half or full modesty panel available, specify style; add \$179 list for laminate panel or \$223 list for veneer panel, see page 25 for details
- veneer drawer fronts in paint available, specify paint color and add \$372 list; see page 16 for details
- on laminate units, contrasting worksurface tops and drawer fronts available, no upcharge; specify color, see page 16 for details
- ledge pulls standard; prism pulls available, specify and see page 9

Description	D	W	H	CTN WT	CU FT	① Model	HPL Laminate	Essentials Veneer	Artisan Veneer
Box/File Kneespace Credenza - Flush Legs	22	96	29	320	43	FLT2296-29L6K6	\$3,996		
	22	96	29	320	43	FLV2296-29L6K6		\$5,186	\$5,705
	22	90	29	320	40	FLT2290-29L6K6	\$3,879		
	22	90	29	320	40	FLV2290-29L6K6		\$5,036	\$5,540

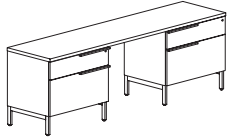

modesty panel options:

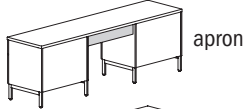

apron

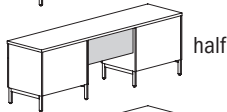

half

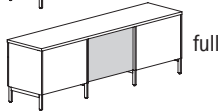

full

Features:

- eased edge profile user side
- 5”h back apron rail standard in kneespace
- pedestal front locking

Options:

- must specify chassis grain direction on artisan veneer, see pages 13-15 for details
- concealed box drawer(s) available, specify location in unit; add \$259 list for each laminate drawer or \$394 for each veneer drawer, see page 25 for details
- fixed half or full modesty panel available, specify style; add \$179 list for laminate panel or \$223 list for veneer panel, see page 25 for details
- veneer drawer fronts in paint available, specify paint color and add \$372 list; see page 16 for details
- on laminate units, contrasting worksurface tops and drawer fronts available, no upcharge; specify color, see page 16 for details
- ledge pulls standard; prism pulls available, specify and see page 9
- interior horizontal wire manager with end grommets available, specify and add \$199 list; see page 40 for details
- top grommet available, specify location; add \$142 list each; see page 45 for details
- worksurface power available, specify “to accommodate EC26” on your purchase order; EC26 unit must be ordered separately, see page 45

FLUX

To Order, Specify:

① Laminate Model #	② Laminate Type	③ Laminate Selection	④ Metal Color	⑤ Other Product Options		
Laminate (FLT)	HPL	See Laminate Selection	See Metal Finish Color Options	See list of options for each specific unit; Specify and add accordingly.		
① Veneer Model #	② Wood Collection	③ Wood Finish	④ Metal Color	⑤ Other Product Options		
Veneer (FLV)	Essentials	See Essentials Wood Finish Options	See Metal Finish Color Options	See list of options for each specific unit; Specify and add accordingly.		
	Artisan	<table border="1"> <thead> <tr> <th>ⓐ Wood Finish</th> <th>ⓑ Chassis Grain Direction</th> </tr> </thead> <tbody> <tr> <td>See Artisan Wood Finish Options</td> <td>For Artisan Only: Vertical Horizontal</td> </tr> </tbody> </table>	ⓐ Wood Finish		ⓑ Chassis Grain Direction	See Artisan Wood Finish Options
ⓐ Wood Finish	ⓑ Chassis Grain Direction					
See Artisan Wood Finish Options	For Artisan Only: Vertical Horizontal					

Description	D	W	H	CTN WT	CU FT	① Model	HPL Laminate	Essentials Veneer	Artisan Veneer
Split Top Box/File Kneespace Credenza - Flush Legs	22	84	29	247	38	FLT2284-29L5K5ST	\$3,765		
	22	84	29	247	38	FLV2284-29L5K5ST		\$4,799	\$5,278
	22	78	29	240	35	FLT2278-29L5K5ST	\$3,665		
	22	78	29	240	35	FLV2278-29L5K5ST		\$4,665	\$5,134
	22	72	29	233	32	FLT2272-29L5K5ST	\$3,567		
	22	72	29	233	32	FLV2272-29L5K5ST		\$4,538	\$4,992
	22	66	29	219	30	FLT2266-29L5K5ST	\$3,484		
	22	66	29	219	30	FLV2266-29L5K5ST		\$4,436	\$4,878
	22	60	29	212	27	FLT2260-29L5K5ST	\$3,406		
	22	60	29	212	27	FLV2260-29L5K5ST		\$4,330	\$4,765

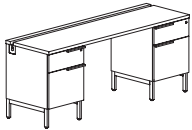

modesty panel options:

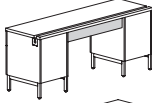

apron

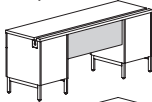

half

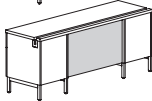

full

Features:

- eased edge profile user side
- built in horizontal wire channel
- 5”h back apron rail standard in kneespace
- pedestal front locking

Options:

- must specify chassis grain direction on artisan veneer, see pages 13-15 for details
- fixed half or full modesty panel available, specify style; add \$179 list for laminate panel or \$223 list for veneer panel, see page 25 for details
- veneer drawer fronts in paint available, specify paint color and add \$372 list; see page 16 for details
- on laminate units, contrasting worksurface tops and drawer fronts available, no upcharge; specify color, see page 16 for details
- ledge pulls standard; prism pulls available, specify and see page 9

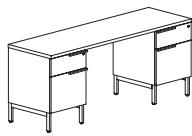
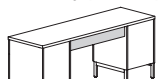
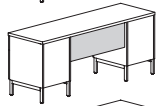
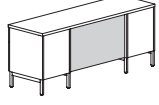
Description	D	W	H	CTN WT	CU FT	① Model	HPL Laminate	Essentials Veneer	Artisan Veneer	
 Box/File Kneespace Credenza - Flush Legs	22	84	29	252	38	FLT2284-29L5K5	\$3,460			
	22	84	29	252	38	FLV2284-29L5K5		\$4,493	\$4,944	
	22	78	29	245	35	FLT2278-29L5K5	\$3,362			
	22	78	29	245	35	FLV2278-29L5K5		\$4,363	\$4,800	
	22	72	29	237	32	FLT2272-29L5K5	\$3,262			
	22	72	29	237	32	FLV2272-29L5K5		\$4,236	\$4,659	
	22	66	29	222	30	FLT2266-29L5K5	\$3,181			
	22	66	29	222	30	FLV2266-29L5K5		\$4,131	\$4,543	
	22	60	29	215	27	FLT2260-29L5K5	\$3,102			
	22	60	29	215	27	FLV2260-29L5K5		\$4,027	\$4,433	
	modesty panel options:									
	 apron									
 half										
 full										

Features:

- eased edge profile user side
- 5”h back apron rail standard in kneespace
- pedestal front locking

Options:

- must specify chassis grain direction on artisan veneer, see pages 13-15 for details
- fixed half or full modesty panel available, specify style; add \$179 list for laminate panel or \$223 list for veneer panel, see page 25 for details
- veneer drawer fronts in paint available, specify paint color and add \$372 list; see page 16 for details
- on laminate units, contrasting worksurface tops and drawer fronts available, no upcharge; specify color, see page 16 for details
- ledge pulls standard; prism pulls available, specify and see page 9
- interior horizontal wire manager with end grommets available, specify and add \$199 list; see page 40 for details
- top grommet available, specify location; add \$142 list each; see page 45 for details
- worksurface power available, specify “to accommodate EC26” on your purchase order; EC26 unit must be ordered separately, see page 45

To Order, Specify:

① Laminate Model #	② Laminate Type	③ Laminate Selection	④ Metal Color	⑤ Other Product Options		
Laminate (FLT)	HPL	See Laminate Selection	See Metal Finish Color Options	See list of options for each specific unit; Specify and add accordingly.		
① Veneer Model #	② Wood Collection	③ Wood Finish	④ Metal Color	⑤ Other Product Options		
Veneer (FLV)	Essentials	See Essentials Wood Finish Options	See Metal Finish Color Options	See list of options for each specific unit; Specify and add accordingly.		
	Artisan	<table border="1"> <tr> <th>ⓐ Wood Finish</th> <th>ⓑ Chassis Grain Direction</th> </tr> <tr> <td>See Artisan Wood Finish Options</td> <td>For Artisan Only: Vertical Horizontal</td> </tr> </table>	ⓐ Wood Finish		ⓑ Chassis Grain Direction	See Artisan Wood Finish Options
ⓐ Wood Finish	ⓑ Chassis Grain Direction					
See Artisan Wood Finish Options	For Artisan Only: Vertical Horizontal					

FLUX

Description	D	W	H	CTN WT	CU FT	① Model	HPL Laminate	Essentials Veneer	Artisan Veneer
Split Top Open Corner Lateral Credenza - Flush Legs	22	96	29	251	43	FLT2296-29LK6ST	\$3,313		
	22	96	29	251	43	FLV2296-29LK6ST		\$4,207	\$4,627
	22	96	29	251	43	FLT2296-29L6KST	\$3,313		
	22	96	29	251	43	FLV2296-29L6KST		\$4,207	\$4,627
	22	90	29	244	40	FLT2290-29LK6ST	\$3,238		
	22	90	29	244	40	FLV2290-29LK6ST		\$4,111	\$4,524
	22	90	29	256	40	FLT2290-29L6KST	\$3,238		
	22	90	29	256	40	FLV2290-29L6KST		\$4,111	\$4,524

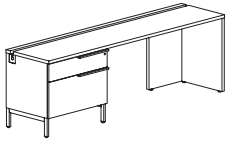

*6KST shown

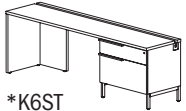

*K6ST

Features:

- eased edge profile user side
- built in horizontal wire channel
- 5”h back apron rail standard in kneespace
- pedestal front locking

Options:

- must specify chassis grain direction on artisan veneer, see pages 13-15 for details
- concealed box drawer available, specify; add \$259 list for each laminate drawer or \$394 for each veneer drawer, see page 25 for details
- fixed half or full modesty panel available, specify style; add \$179 list for laminate panel or \$223 list for veneer panel, see page 25 for details
- veneer drawer fronts in paint available, specify paint color and add \$372 list; see page 16 for details
- on laminate units, contrasting worksurface tops and drawer fronts available, no upcharge; specify color, see page 16 for details
- ledge pulls standard; prism pulls available, specify and see page 9
- knee clearance end panel available 13” depth, specify; no upcharge

modesty panel options:

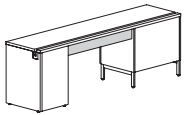

apron

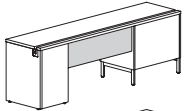

half

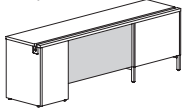

full

FLUX

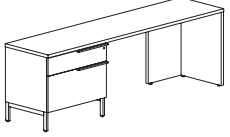
Description	D	W	H	CTN WT	CU FT	① Model	HPL Laminate	Essentials Veneer	Artisan Veneer
Open Corner Lateral Credenza - Flush Legs  *6K shown	22	96	29	256	43	FLT2296-29LK6	\$3,008		
	22	96	29	256	43	FLV2296-29LK6		\$3,903	\$4,293
	22	96	29	256	43	FLT2296-29L6K	\$3,008		
	22	96	29	256	43	FLV2296-29L6K		\$3,903	\$4,293
	22	90	29	249	40	FLT2290-29LK6	\$2,931		
	22	90	29	249	40	FLV2290-29LK6		\$3,809	\$4,190
	22	90	29	249	40	FLT2290-29L6K	\$2,931		
	22	90	29	249	40	FLV2290-29L6K		\$3,809	\$4,190

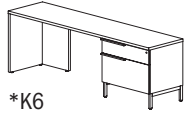

Features:

- eased edge profile user side
- 5”h back apron rail standard in kneespace
- pedestal front locking

Options:

- must specify chassis grain direction on artisan veneer, see pages 13-15 for details
- concealed box drawer available, specify; add \$259 list for each laminate drawer or \$394 for each veneer drawer, see page 25 for details
- fixed half or full modesty panel available, specify style; add \$179 list for laminate panel or \$223 list for veneer panel, see page 25 for details
- veneer drawer fronts in paint available, specify paint color and add \$372 list; see page 16 for details
- on laminate units, contrasting worksurface tops and drawer fronts available, no upcharge; specify color, see page 16 for details
- ledge pulls standard; prism pulls available, specify and see page 9
- interior horizontal wire manager with end grommets available, specify and add \$199 list; see page 40 for details
- top grommet available, specify location; add \$142 list each; see page 45 for details
- worksurface power available, specify “to accommodate EC26” on your purchase order; EC26 unit must be ordered separately, see page 45
- knee clearance end panel available 13” depth, specify; no upcharge

modesty panel options:

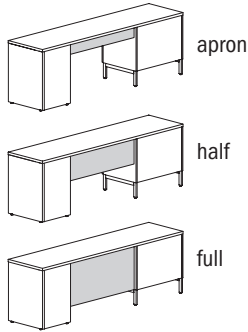

To Order, Specify:

① Laminate Model #	② Laminate Type	③ Laminate Selection	④ Metal Color	⑤ Other Product Options		
Laminate (FLT)	HPL	See Laminate Selection	See Metal Finish Color Options	See list of options for each specific unit; Specify and add accordingly.		
① Veneer Model #	② Wood Collection	③ Wood Finish	④ Metal Color	⑤ Other Product Options		
Veneer (FLV)	Essentials	See Essentials Wood Finish Options	See Metal Finish Color Options	See list of options for each specific unit; Specify and add accordingly.		
	Artisan	<table border="1"> <thead> <tr> <th>ⓐ Wood Finish</th> <th>ⓑ Chassis Grain Direction</th> </tr> </thead> <tbody> <tr> <td>See Artisan Wood Finish Options</td> <td>For Artisan Only: Vertical Horizontal</td> </tr> </tbody> </table>	ⓐ Wood Finish		ⓑ Chassis Grain Direction	See Artisan Wood Finish Options
ⓐ Wood Finish	ⓑ Chassis Grain Direction					
See Artisan Wood Finish Options	For Artisan Only: Vertical Horizontal					

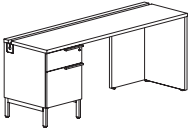
Description	D	W	H	CTN WT	CU FT	① Model	HPL Laminate	Essentials Veneer	Artisan Veneer
Split Top Open Corner Credenza - Flush Legs	22	84	29	211	38	FLT2284-29LK5ST	\$3,222		
	22	84	29	211	38	FLV2284-29LK5ST		\$4,042	\$4,446
 *5KST shown	22	84	29	211	38	FLT2284-29L5KST	\$3,222		
	22	84	29	211	38	FLV2284-29L5KST		\$4,042	\$4,446
	22	78	29	218	35	FLT2278-29LK5ST	\$3,163		
	22	78	29	218	35	FLV2278-29LK5ST		\$3,967	\$4,365
	22	78	29	218	35	FLT2278-29L5KST	\$3,163		
	22	78	29	218	35	FLV2278-29L5KST		\$3,967	\$4,365
	22	72	29	177	32	FLT2272-29LK5ST	\$3,107		
	22	72	29	177	32	FLV2272-29LK5ST		\$3,895	\$4,284
	22	72	29	177	32	FLT2272-29L5KST	\$3,107		
	22	72	29	177	32	FLV2272-29L5KST		\$3,895	\$4,284



Features:

- eased edge profile user side
- built in horizontal wire channel
- 5”h back apron rail standard in kneespace
- pedestal front locking

Options:

- must specify chassis grain direction on artisan veneer, see pages 13-15 for details
- fixed half or full modesty panel available, specify style; add \$179 list for laminate panel or \$223 list for veneer panel, see page 25 for details
- veneer drawer fronts in paint available, specify paint color and add \$372 list; see page 16 for details
- ledge pulls standard; prism pulls available, specify and see page 9
- knee clearance end panel available 13” depth, specify; no upcharge

modesty panel options:

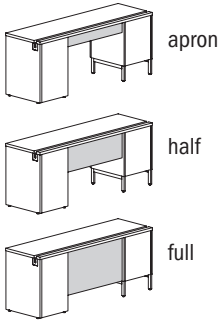

FLUX

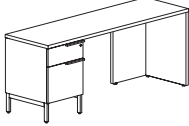
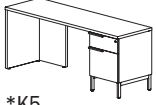
Description	D	W	H	CTN WT	CU FT	① Model	HPL Laminate	Essentials Veneer	Artisan Veneer
 <p>*5K shown</p>  <p>*K5</p>	22	84	29	216	38	FLT2284-29LK5	\$2,918		
	22	84	29	216	38	FLV2284-29LK5		\$3,738	\$4,112
	22	84	29	216	38	FLT2284-29L5K	\$2,918		
	22	84	29	216	38	FLV2284-29L5K		\$3,738	\$4,112
	22	78	29	208	35	FLT2278-29LK5	\$2,859		
	22	78	29	208	35	FLV2278-29LK5		\$3,666	\$4,032
	22	78	29	208	35	FLT2278-29L5K	\$2,859		
	22	78	29	208	35	FLV2278-29L5K		\$3,666	\$4,032
	22	72	29	201	32	FLT2272-29LK5	\$2,803		
	22	72	29	201	32	FLV2272-29LK5		\$3,591	\$3,953
	22	72	29	201	32	FLT2272-29L5K	\$2,803		
	22	72	29	201	32	FLV2272-29L5K		\$3,591	\$3,953

Features:

- eased edge profile user side
- 5”h back apron rail standard in kneespace
- pedestal front locking

Options:

- must specify chassis grain direction on artisan veneer, see pages 13-15 for details
- fixed half or full modesty panel available, specify style; add \$179 list for laminate panel or \$223 list for veneer panel, see page 25 for details
- veneer drawer fronts in paint available, specify paint color and add \$372 list; see page 16 for details
- on laminate units, contrasting worksurface tops and drawer fronts available, no upcharge; specify color, see page 16 for details
- ledge pulls standard; prism pulls available, specify and see page 9
- interior horizontal wire manager with end grommets available, specify and add \$199 list; see page 40 for details
- top grommet available, specify location; add \$142 list each; see page 45 for details
- worksurface power available, specify “to accommodate EC26” on your purchase order; EC26 unit must be ordered separately, see page 45
- knee clearance end panel available 13” depth, specify; no upcharge

modesty panel options:

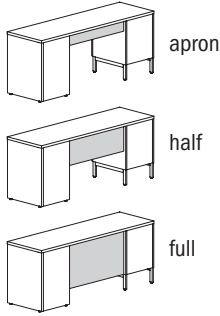

To Order, Specify:

① Laminate Model #	② Laminate Type	③ Laminate Selection	④ Metal Color	⑤ Other Product Options		
Laminate (FLT)	HPL	See Laminate Selection	See Metal Finish Color Options	See list of options for each specific unit; Specify and add accordingly.		
① Veneer Model #	② Wood Collection	③ Wood Finish	④ Metal Color	⑤ Other Product Options		
Veneer (FLV)	Essentials	See Essentials Wood Finish Options	See Metal Finish Color Options	See list of options for each specific unit; Specify and add accordingly.		
	Artisan	<table border="1"> <thead> <tr> <th>ⓐ Wood Finish</th> <th>ⓑ Chassis Grain Direction</th> </tr> </thead> <tbody> <tr> <td>See Artisan Wood Finish Options</td> <td>For Artisan Only: Vertical Horizontal</td> </tr> </tbody> </table>	ⓐ Wood Finish		ⓑ Chassis Grain Direction	See Artisan Wood Finish Options
ⓐ Wood Finish	ⓑ Chassis Grain Direction					
See Artisan Wood Finish Options	For Artisan Only: Vertical Horizontal					

Description	D	W	H	CTN WT	CU FT	① Model	HPL Laminate	Essentials Veneer	Artisan Veneer
Split Top Open Corner Credenza - Flush Legs	22	66	29	184	30	FLT2266-29LK5ST	\$2,435		
	22	66	29	184	30	FLV2266-29LK5ST		\$3,038	\$3,338
	22	66	29	184	30	FLT2266-29L5KST	\$2,435		
	22	66	29	184	30	FLV2266-29L5KST		\$3,038	\$3,338
	22	60	29	177	27	FLT2260-29LK5ST	\$2,393		
	22	60	29	177	27	FLV2260-29LK5ST		\$2,982	\$3,281
	22	60	29	177	27	FLT2260-29L5KST	\$2,393		
	22	60	29	177	27	FLV2260-29L5KST		\$2,982	\$3,281
	22	60	29	177	27	FLV2260-29L5KST		\$2,982	\$3,281

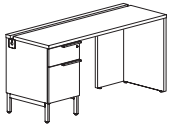

*5KST shown



*K5ST

Features:

- eased edge profile user side
- built in horizontal wire channel
- 5”h back apron rail standard in kneespace
- pedestal front locking

Options:

- must specify chassis grain direction on artisan veneer, see pages 13-15 for details
- fixed half or full modesty panel available, specify style; add \$179 list for laminate panel or \$223 list for veneer panel, see page 25 for details
- veneer drawer fronts in paint available, specify paint color and add \$372 list; see page 16 for details
- on laminate units, contrasting worksurface tops and drawer fronts available, no upcharge; specify color, see page 16 for details
- ledge pulls standard; prism pulls available, specify and see page 9
- knee clearance end panel available 13” depth, specify; no upcharge

modesty panel options:



apron

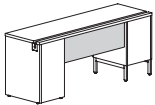

half

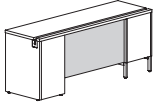

full

FLUX

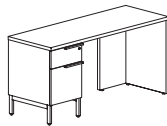
Description	D	W	H	CTN WT	CU FT	① Model	HPL Laminate	Essentials Veneer	Artisan Veneer
 <p>*5K shown</p>	22	66	29	187	30	FLT2266-29LK5	\$2,132		
	22	66	29	187	30	FLV2266-29LK5		\$2,734	\$3,007
	22	66	29	187	30	FLT2266-29L5K	\$2,132		
	22	66	29	187	30	FLV2266-29L5K		\$2,734	\$3,007
	22	60	29	180	27	FLT2260-29LK5	\$2,090		
	22	60	29	180	27	FLV2260-29LK5		\$2,679	\$2,949
	22	60	29	180	27	FLT2260-29L5K	\$2,090		
	22	60	29	180	27	FLV2260-29L5K		\$2,679	\$2,949

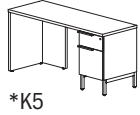

Features:

- eased edge profile user side
- 5”h back apron rail standard in kneespace
- pedestal front locking

Options:



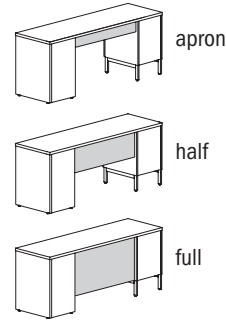

- must specify chassis grain direction on artisan veneer, see pages 13-15 for details
- fixed half or full modesty panel available, specify style; add \$179 list for laminate panel or \$223 list for veneer panel, see page 25 for details
- veneer drawer fronts in paint available, specify paint color and add \$372 list; see page 16 for details
- on laminate units, contrasting worksurface tops and drawer fronts available, no upcharge; specify color, see page 16 for details
- ledge pulls standard; prism pulls available, specify and see page 9
- interior horizontal wire manager with end grommets available, specify and add \$199 list; see page 40 for details
- top grommet available, specify location; add \$142 list each; see page 45 for details
- worksurface power available, specify “to accommodate EC26” on your purchase order; EC26 unit must be ordered separately, see page 45
- knee clearance end panel available 13” depth, specify; no upcharge

modesty panel options:

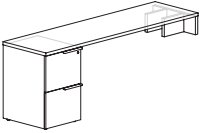

To Order, Specify:

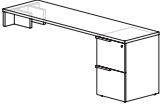
① Laminate Model #	② Laminate Type	③ Laminate Selection	④ Metal Color	⑤ Other Product Options		
Laminate (FLT)	HPL	See Laminate Selection	See Metal Finish Color Options	See list of options for each specific unit; Specify and add accordingly.		
① Veneer Model #	② Wood Collection	③ Wood Finish	④ Metal Color	⑤ Other Product Options		
Veneer (FLV)	Essentials	See Essentials Wood Finish Options	See Metal Finish Color Options	See list of options for each specific unit; Specify and add accordingly.		
	Artisan	<table border="1"> <thead> <tr> <th>ⓐ Wood Finish</th> <th>ⓑ Chassis Grain Direction</th> </tr> </thead> <tbody> <tr> <td>See Artisan Wood Finish Options</td> <td>For Artisan Only: Vertical Horizontal</td> </tr> </tbody> </table>	ⓐ Wood Finish		ⓑ Chassis Grain Direction	See Artisan Wood Finish Options
ⓐ Wood Finish	ⓑ Chassis Grain Direction					
See Artisan Wood Finish Options	For Artisan Only: Vertical Horizontal					

Description	D	W	H	CTN WT	CU FT	① Model	HPL Laminate	Essentials Veneer	Artisan Veneer
File/File Peninsula Credenza   *2K shown   *K2	22	96	29	172	43	FLT2296-29FPC2K	\$2,502		
	22	96	29	172	43	FLV2296-29FPC2K		\$3,490	\$3,839
	22	96	29	172	43	FLT2296-29FPC2K	\$2,502		
	22	96	29	172	43	FLV2296-29FPC2K		\$3,490	\$3,839
	22	90	29	171	40	FLT2290-29FPC2K	\$2,440		
	22	90	29	171	40	FLV2290-29FPC2K		\$3,407	\$3,747
	22	90	29	171	40	FLT2290-29FPC2K	\$2,440		
	22	90	29	171	40	FLV2290-29FPC2K		\$3,407	\$3,747
	22	84	29	166	38	FLT2284-29FPC2K	\$2,381		
	22	84	29	166	38	FLV2284-29FPC2K		\$3,323	\$3,654
	22	84	29	166	38	FLT2284-29FPC2K	\$2,381		
	22	84	29	166	38	FLV2284-29FPC2K		\$3,323	\$3,654
	22	78	29	161	35	FLT2278-29FPC2K	\$2,324		
	22	78	29	161	35	FLV2278-29FPC2K		\$3,242	\$3,567
	22	78	29	161	35	FLT2278-29FPC2K	\$2,324		
	22	78	29	161	35	FLV2278-29FPC2K		\$3,242	\$3,567
	22	72	29	156	32	FLT2272-29FPC2K	\$2,267		
	22	72	29	156	32	FLV2272-29FPC2K		\$3,163	\$3,478
	22	72	29	156	32	FLT2272-29FPC2K	\$2,267		
	22	72	29	156	32	FLV2272-29FPC2K		\$3,163	\$3,478

Features:

- intended to be used with secondary height credenzas; specify mounting location when ordering credenzas, see page 17
- eased edge profile user side
- pedestal front locking

Options:

- must specify chassis grain direction on artisan veneer, see pages 13-15 for details
- veneer drawer fronts in paint available, specify paint color and add \$372 list; see page 16 for details
- on laminate units, contrasting fronts available, no upcharge; specify color, see page 16 for details
- ledge pulls standard; prism pulls available, specify and see page 9
- top grommet available, specify location and add \$142 list each; see page 46 for details
- worksurface power available, specify "to accommodate EC26" on your purchase order; EC26 unit must be ordered separately, see page 46

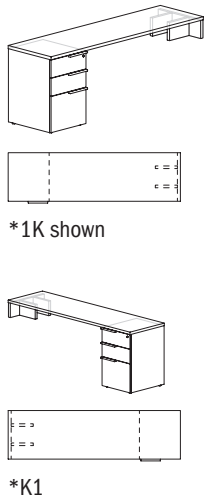
Description	D	W	H	CTN WT	CU FT	① Model	HPL Laminate	Essentials Veneer	Artisan Veneer
Box/Box/File Peninsula Credenza	22	96	29	174	43	FLT2296-29FPCK1	\$2,508		
	22	96	29	174	43	FLV2296-29FPCK1		\$3,500	\$3,851
	22	96	29	174	43	FLT2296-29FPC1K	\$2,508		
	22	96	29	174	43	FLV2296-29FPC1K		\$3,500	\$3,851
	22	90	29	173	40	FLT2290-29FPCK1	\$2,448		
	22	90	29	173	40	FLV2290-29FPCK1		\$3,414	\$3,758
	22	90	29	173	40	FLT2290-29FPC1K	\$2,448		
	22	90	29	173	40	FLV2290-29FPC1K		\$3,414	\$3,758
	22	84	29	168	38	FLT2284-29FPCK1	\$2,388		
	22	84	29	168	38	FLV2284-29FPCK1		\$3,330	\$3,666
	22	84	29	168	38	FLT2284-29FPC1K	\$2,388		
	22	84	29	168	38	FLV2284-29FPC1K		\$3,330	\$3,666
	22	78	29	165	35	FLT2278-29FPCK1	\$2,329		
	22	78	29	165	35	FLV2278-29FPCK1		\$3,249	\$3,577
	22	78	29	165	35	FLT2278-29FPC1K	\$2,329		
	22	78	29	165	35	FLV2278-29FPC1K		\$3,249	\$3,577
	22	72	29	158	32	FLT2272-29FPCK1	\$2,275		
	22	72	29	158	32	FLV2272-29FPCK1		\$3,170	\$3,489
	22	72	29	158	32	FLT2272-29FPC1K	\$2,275		
	22	72	29	158	32	FLV2272-29FPC1K		\$3,170	\$3,489

Features:

- intended to be used with secondary height credenzas; specify mounting location when ordering credenzas, see page 17
- eased edge profile user side
- pedestal front locking

Options:

- must specify chassis grain direction on artisan veneer, see pages 13-15 for details
- veneer drawer fronts in paint available, specify paint color and add \$372 list; see page 16 for details
- on laminate units, contrasting fronts available, no upcharge; specify color, see page 16 for details
- ledge pulls standard; prism pulls available, specify and see page 9
- top grommet available, specify location and add \$142 list each; see page 46 for details
- worksurface power available, specify "to accommodate EC26" on your purchase order; EC26 unit must be ordered separately, see page 46

To Order, Specify:

① Laminate Model #	② Laminate Type	③ Laminate Selection	④ Metal Color	⑤ Other Product Options		
Laminate (FLT)	HPL	See Laminate Selection	See Metal Finish Color Options	See list of options for each specific unit; Specify and add accordingly.		
① Veneer Model #	② Wood Collection	③ Wood Finish	④ Metal Color	⑤ Other Product Options		
Veneer (FLV)	Essentials	See Essentials Wood Finish Options	See Metal Finish Color Options	See list of options for each specific unit; Specify and add accordingly.		
	Artisan	<table border="1"> <tr> <th>ⓐ Wood Finish</th> <th>ⓑ Chassis Grain Direction</th> </tr> <tr> <td>See Artisan Wood Finish Options</td> <td>For Artisan Only: Vertical Horizontal</td> </tr> </table>	ⓐ Wood Finish		ⓑ Chassis Grain Direction	See Artisan Wood Finish Options
ⓐ Wood Finish	ⓑ Chassis Grain Direction					
See Artisan Wood Finish Options	For Artisan Only: Vertical Horizontal					

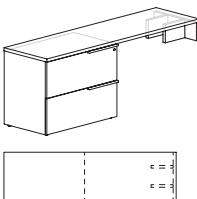
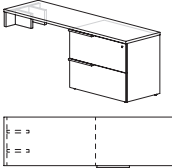
Description	D	W	H	CTN WT	CU FT	① Model	HPL Laminate	Essentials Veneer	Artisan Veneer
 <p>*4K shown</p>	22	96	29	224	43	FLT2296-29FPCK4	\$2,754		
	22	96	29	224	43	FLV2296-29FPCK4		\$3,841	\$4,227
	22	96	29	224	43	FLT2296-29FPC4K	\$2,754		
	22	96	29	224	43	FLV2296-29FPC4K		\$3,841	\$4,227
	22	90	29	219	40	FLT2290-29FPCK4	\$2,685		
	22	90	29	219	40	FLV2290-29FPCK4		\$3,749	\$4,127
	22	90	29	219	40	FLT2290-29FPC4K	\$2,685		
	22	90	29	219	40	FLV2290-29FPC4K		\$3,749	\$4,127
	22	84	29	214	38	FLT2284-29FPCK4	\$2,620		
	22	84	29	214	38	FLV2284-29FPCK4		\$3,657	\$4,023
 <p>*K4</p>	22	84	29	214	38	FLT2284-29FPC4K	\$2,620		
	22	84	29	214	38	FLV2284-29FPC4K		\$3,657	\$4,023
	22	78	29	209	35	FLT2278-29FPCK4	\$2,557		
	22	78	29	209	35	FLV2278-29FPCK4		\$3,569	\$3,929
	22	78	29	209	35	FLT2278-29FPC4K	\$2,557		
	22	78	29	209	35	FLV2278-29FPC4K		\$3,569	\$3,929
	22	72	29	205	32	FLT2272-29FPCK4	\$2,495		
	22	72	29	205	32	FLV2272-29FPCK4		\$3,481	\$3,830
	22	72	29	205	32	FLT2272-29FPC4K	\$2,495		
	22	72	29	205	32	FLV2272-29FPC4K		\$3,481	\$3,830

Features:

- intended to be used with secondary height credenzas; specify mounting location when ordering credenzas, see page 17
- eased edge profile user side
- pedestal front locking

Options:

- must specify chassis grain direction on artisan veneer, see pages 13-15 for details
- veneer drawer fronts in paint available, specify paint color and add \$372 list; see page 16 for details
- on laminate units, contrasting fronts available, no upcharge; specify color, see page 16 for details
- ledge pulls standard; prism pulls available, specify and see page 9
- top grommet available, specify location and add \$142 list each; see page 46 for details
- worksurface power available, specify "to accommodate EC26" on your purchase order; EC26 unit must be ordered separately, see page 46

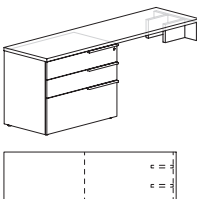
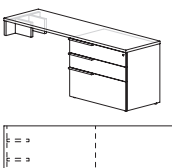
 <p>*3K shown</p>	22	96	29	224	43	FLT2296-29FPCK3	\$2,764		
	22	96	29	224	43	FLV2296-29FPCK3		\$3,858	\$4,242
	22	96	29	224	43	FLT2296-29FPC3K	\$2,764		
	22	96	29	224	43	FLV2296-29FPC3K		\$3,858	\$4,242
	22	90	29	220	40	FLT2290-29FPCK3	\$2,696		
	22	90	29	220	40	FLV2290-29FPCK3		\$3,764	\$4,140
	22	90	29	220	40	FLT2290-29FPC3K	\$2,696		
	22	90	29	220	40	FLV2290-29FPC3K		\$3,764	\$4,140
	22	84	29	215	38	FLT2284-29FPCK3	\$2,632		
	22	84	29	215	38	FLV2284-29FPCK3		\$3,672	\$4,039
 <p>*K3</p>	22	84	29	215	38	FLT2284-29FPC3K	\$2,632		
	22	84	29	215	38	FLV2284-29FPC3K		\$3,672	\$4,039
	22	78	29	211	35	FLT2278-29FPCK3	\$2,567		
	22	78	29	211	35	FLV2278-29FPCK3		\$3,582	\$3,941
	22	78	29	211	35	FLT2278-29FPC3K	\$2,567		
	22	78	29	211	35	FLV2278-29FPC3K		\$3,582	\$3,941
	22	72	29	206	32	FLT2272-29FPCK3	\$2,504		
	22	72	29	206	32	FLV2272-29FPCK3		\$3,496	\$3,847
	22	72	29	206	32	FLT2272-29FPC3K	\$2,504		
	22	72	29	206	32	FLV2272-29FPC3K		\$3,496	\$3,847

Features:

- intended to be used with secondary height credenzas; specify mounting location when ordering credenzas, see page 17
- eased edge profile user side
- pedestal front locking

Options:

- must specify chassis grain direction on artisan veneer, see pages 13-15 for details
- veneer drawer fronts in paint available, specify paint color and add \$372 list; see page 16 for details
- on laminate units, contrasting fronts available, no upcharge; specify color, see page 16 for details
- ledge pulls standard; prism pulls available, specify and see page 9
- top grommet available, specify location and add \$142 list each; see page 46 for details
- worksurface power available, specify "to accommodate EC26" on your purchase order; EC26 unit must be ordered separately, see page 46

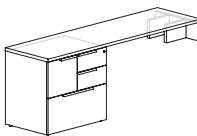
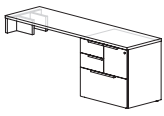
Description	D	W	H	CTN WT	CU FT	① Model	HPL Laminate	Essentials Veneer	Artisan Veneer
 left shown  right	22	96	29	225	43	FLT2296-29FPMRR	\$2,906		
	22	96	29	225	43	FLV2296-29FPMRR		\$4,056	\$4,460
	22	96	29	225	43	FLT2296-29FPMLR	\$2,906		
	22	96	29	225	43	FLV2296-29FPMLR		\$4,056	\$4,460
	22	90	29	220	40	FLT2290-29FPMRR	\$2,834		
	22	90	29	220	40	FLV2290-29FPMRR		\$3,957	\$4,354
	22	90	29	220	40	FLT2290-29FPMLR	\$2,834		
	22	90	29	220	40	FLV2290-29FPMLR		\$3,957	\$4,354
	22	84	29	214	38	FLT2284-29FPMRR	\$2,765		
	22	84	29	214	38	FLV2284-29FPMRR		\$3,861	\$4,246
	22	84	29	214	38	FLT2284-29FPMLR	\$2,765		
	22	84	29	214	38	FLV2284-29FPMLR		\$3,861	\$4,246
	22	78	29	209	35	FLT2278-29FPMRR	\$2,699		
	22	78	29	209	35	FLV2278-29FPMRR		\$3,767	\$4,144
	22	78	29	209	35	FLT2278-29FPMLR	\$2,699		
	22	78	29	209	35	FLV2278-29FPMLR		\$3,767	\$4,144
	22	72	29	204	32	FLT2272-29FPMRR	\$2,633		
	22	72	29	204	32	FLV2272-29FPMRR		\$3,673	\$4,041
	22	72	29	204	32	FLT2272-29FPMLR	\$2,633		
	22	72	29	204	32	FLV2272-29FPMLR		\$3,673	\$4,041

Features:

- intended to be used with secondary height credenzas; specify mounting location when ordering credenzas, see page 17
- eased edge profile user side
- pedestal front locking

Options:

- must specify chassis grain direction on artisan veneer, see pages 13-15 for details
- veneer drawer fronts in paint available, specify paint color and add \$372 list; see page 16 for details
- on laminate units, contrasting fronts available, no upcharge; specify color, see page 16 for details
- ledge pulls standard; prism pulls available, specify and see page 9
- top grommet available, specify location and add \$142 list each; see page 46 for details
- worksurface power available, specify "to accommodate EC26" on your purchase order; EC26 unit must be ordered separately, see page 46

To Order, Specify:

① Laminate Model #	② Laminate Type	③ Laminate Selection	④ Metal Color	⑤ Other Product Options
Laminate (FLT)	HPL	See Laminate Selection	See Metal Finish Color Options	See list of options for each specific unit; Specify and add accordingly.
① Veneer Model #	② Wood Collection	③ Wood Finish	④ Metal Color	⑤ Other Product Options
Veneer (FLV)	Essentials	See Essentials Wood Finish Options	See Metal Finish Color Options	See list of options for each specific unit; Specify and add accordingly.
	Artisan	ⓐ Wood Finish See Artisan Wood Finish Options	ⓑ Chassis Grain Direction For Artisan Only: Vertical Horizontal	

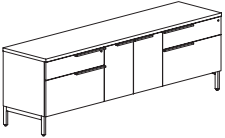
Description	D	W	H	CTN WT	CU FT	① Model	HPL Laminate	Essentials Veneer	Artisan Veneer
	22	96	29	377	43	FLT2296-29L676	\$4,659		
	22	96	29	377	43	FLV2296-29L676		\$6,050	\$6,655
	22	90	29	359	40	FLT2290-29L676	\$4,521		
	22	90	29	359	40	FLV2290-29L676		\$5,871	\$6,459
	22	84	29	340	38	FLT2284-29L676	\$4,388		
	22	84	29	340	38	FLV2284-29L676		\$5,699	\$6,269

Features:

- eased edge profile user side
- pedestal front locking
- hinged door compartment has one adjustable shelf

Options:

- must specify chassis grain direction on artisan veneer, see pages 13-15 for details
- locking door available, specify and add \$153 list
- concealed box drawer(s) available, specify location in unit; add \$259 list for each laminate drawer or \$394 for each veneer drawer, see page 25 for details
- veneer door and drawer fronts in paint available, specify paint color and add \$372; see page 16 for details
- on laminate units, contrasting worksurface tops and door fronts available, no upcharge; specify laminate color, see page 16 for details
- ledge pulls standard; prism pulls available, specify and see page 9
- oval grommets in back panel can be eliminated upon request, no upcharge
- interior horizontal wire manager with end grommets available, specify and add \$199 list; see page 40 for details
- top grommet available, specify location; add \$142 list each; see page 46 for details
- worksurface power available, specify "to accommodate EC26" on your purchase order; EC26 unit must be ordered separately, see page 46

	22	90	29	369	40	FLT2290-29S676	\$4,521		
	22	90	29	369	40	FLV2290-29S676		\$5,871	\$6,459

Features:

- eased edge profile user side
- pedestal front locking
- hinged door compartment has one adjustable shelf

Options:

- must specify chassis grain direction on artisan veneer, see pages 13-15 for details
- locking door available, specify and add \$153 list
- concealed box drawer(s) available, specify location in unit; add \$259 list for each laminate drawer or \$394 for each veneer drawer, see page 25 for details
- veneer door and drawer fronts in paint available, specify paint color and add \$372; see page 16 for details
- on laminate units, contrasting worksurface tops and door fronts available, no upcharge; specify laminate color, see page 16 for details
- ledge pulls standard; prism pulls available, specify and see page 9
- oval grommets in back panel can be eliminated upon request, no upcharge
- interior horizontal wire manager with end grommets available, specify and add \$199 list; see page 40 for details
- top grommet available, specify location; add \$142 list each; see page 46 for details
- worksurface power available, specify "to accommodate EC26" on your purchase order; EC26 unit must be ordered separately, see page 46

FLUX

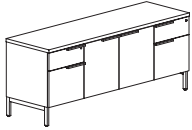
Description	D	W	H	CTN WT	CU FT	① Model	HPL Laminate	Essentials Veneer	Artisan Veneer
 Storage Credenza - Flush Legs	22	78	29	311	35	FLT2278-29L575	\$4,110		
	22	78	29	311	35	FLV2278-29L575		\$5,334	\$5,869
	22	72	29	292	32	FLT2272-29L575	\$3,995		
	22	72	29	292	32	FLV2272-29L575		\$5,184	\$5,702
	22	66	29	273	30	FLT2266-29L575	\$3,929		
	22	66	29	273	30	FLV2266-29L575		\$5,097	\$5,609
	22	60	29	255	27	FLT2260-29L575	\$3,857		
	22	60	29	255	27	FLV2260-29L575		\$5,005	\$5,506

Features:

- eased edge profile user side
- pedestal front locking
- hinged door compartment has one adjustable shelf

Options:

- must specify chassis grain direction on artisan veneer, see pages 13-15 for details
- locking door available, specify and add \$153 list
- concealed box drawer(s) available, specify location in unit; add \$259 list for each laminate drawer or \$394 for each veneer drawer, see page 25 for details
- veneer door and drawer fronts in paint available, specify paint color and add \$372; see page 16 for details
- on laminate units, contrasting worksurface tops and door fronts available, no upcharge; specify laminate color, see page 16 for details
- ledge pulls standard; prism pulls available, specify and see page 9
- oval grommets in back panel can be eliminated upon request, no upcharge
- interior horizontal wire manager with end grommets available, specify and add \$199 list; see page 40 for details
- top grommet available, specify location; add \$142 list each; see page 46 for details
- worksurface power available, specify "to accommodate EC26" on your purchase order; EC26 unit must be ordered separately, see page 46

 Storage Credenza - Inset Legs	22	72	29	298	32	FLT2272-29S575	\$3,995		
	22	72	29	298	32	FLV2272-29S575		\$5,184	\$5,702
	22	60	29	254	27	FLT2260-29S575	\$3,857		
	22	60	29	254	27	FLV2260-29S575		\$5,005	\$5,506

Features:

- eased edge profile user side
- pedestal front locking
- hinged door compartment has one adjustable shelf

Options:

- must specify chassis grain direction on artisan veneer, see pages 13-15 for details
- locking door available, specify and add \$153 list
- concealed box drawer(s) available, specify location in unit; add \$259 list for each laminate drawer or \$394 for each veneer drawer, see page 25 for details
- veneer door and drawer fronts in paint available, specify paint color and add \$372; see page 16 for details
- on laminate units, contrasting worksurface tops and door fronts available, no upcharge; specify laminate color, see page 16 for details
- ledge pulls standard; prism pulls available, specify and see page 9
- oval grommets in back panel can be eliminated upon request, no upcharge
- interior horizontal wire manager with end grommets available, specify and add \$199 list; see page 40 for details
- top grommet available, specify location; add \$142 list each; see page 46 for details
- worksurface power available, specify "to accommodate EC26" on your purchase order; EC26 unit must be ordered separately, see page 46

To Order, Specify:

① Laminate Model #	② Laminate Type	③ Laminate Selection	④ Metal Color	⑤ Other Product Options
Laminate (FLT)	HPL	See Laminate Selection	See Metal Finish Color Options	See list of options for each specific unit; Specify and add accordingly.
① Veneer Model #	② Wood Collection	③ Wood Finish	④ Metal Color	⑤ Other Product Options
Veneer (FLV)	Essentials	See Essentials Wood Finish Options	See Metal Finish Color Options	See list of options for each specific unit; Specify and add accordingly.
	Artisan	Ⓐ Wood Finish See Artisan Wood Finish Options	Ⓑ Chassis Grain Direction For Artisan Only: Vertical Horizontal	

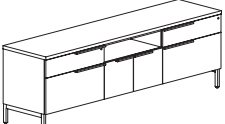
Description	D	W	H	CTN WT	CU FT	① Model	HPL Laminate	Essentials Veneer	Artisan Veneer
Box/Lateral Storage Credenza with Open Center - Flush Legs 	22	96	29	365	43	FLT2296-29L686	\$4,706		
	22	96	29	365	43	FLV2296-29L686		\$6,108	\$6,720
	22	90	29	355	40	FLT2290-29L686	\$4,570		
	22	90	29	355	40	FLV2290-29L686		\$5,931	\$6,526
	22	84	29	332	38	FLT2284-29L686	\$4,437		
	22	84	29	332	38	FLV2284-29L686		\$5,762	\$6,337

Features:

- eased edge profile user side
- pedestal front locking
- hinged door compartment has one adjustable shelf

Options:

- must specify chassis grain direction on artisan veneer, see pages 13-15 for details
- locking door available, specify and add \$153 list
- concealed box drawer(s) available, specify location in unit; add \$259 list for each laminate drawer or \$394 for each veneer drawer, see page 25 for details
- veneer door and drawer fronts in paint available, specify paint color and add \$372; see page 16 for details
- on laminate units, contrasting worksurface tops and door fronts available, no upcharge; specify laminate color, see page 16 for details
- ledge pulls standard; prism pulls available, specify and see page 9
- oval grommets in back panel can be eliminated upon request, no upcharge
- interior horizontal wire manager with end grommets available, specify and add \$199 list; see page 40 for details
- top grommet available, specify location; add \$142 list each; see page 46 for details
- worksurface power available, specify "to accommodate EC26" on your purchase order; EC26 unit must be ordered separately, see page 46

Box/Lateral Storage Credenza with Open Center - Inset Legs 	22	90	29	390	40	FLT2290-29S686	\$4,570		
	22	90	29	390	40	FLV2290-29S686		\$5,931	\$6,526

Features:

- eased edge profile user side
- pedestal front locking
- hinged door compartment has one adjustable shelf

Options:

- must specify chassis grain direction on artisan veneer, see pages 13-15 for details
- locking door available, specify and add \$153 list
- concealed box drawer(s) available, specify location in unit; add \$259 list for each laminate drawer or \$394 for each veneer drawer, see page 25 for details
- veneer door and drawer fronts in paint available, specify paint color and add \$372; see page 16 for details
- on laminate units, contrasting worksurface tops and door fronts available, no upcharge; specify laminate color, see page 16 for details
- ledge pulls standard; prism pulls available, specify and see page 9
- oval grommets in back panel can be eliminated upon request, no upcharge
- interior horizontal wire manager with end grommets available, specify and add \$199 list; see page 40 for details
- top grommet available, specify location; add \$142 list each; see page 46 for details
- worksurface power available, specify "to accommodate EC26" on your purchase order; EC26 unit must be ordered separately, see page 46

FLUX

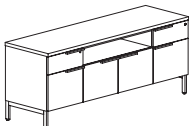
Description	D	W	H	CTN WT	CU FT	① Model	HPL Laminate	Essentials Veneer	Artisan Veneer
 Box/File Storage Credenza with Open Center - Flush Legs	22	78	29	300	35	FLT2278-29L585	\$4,156		
	22	78	29	300	35	FLV2278-29L585		\$5,395	\$5,936
	22	72	29	288	32	FLT2272-29L585	\$4,039		
	22	72	29	288	32	FLV2272-29L585		\$5,243	\$5,768
	22	66	29	269	30	FLT2266-29L585	\$3,973		
	22	66	29	269	30	FLV2266-29L585		\$5,159	\$5,675
	22	60	29	252	27	FLT2260-29L585	\$3,901		
	22	60	29	252	27	FLV2260-29L585		\$5,067	\$5,573

Features:

- eased edge profile user side
- pedestal front locking
- hinged door compartment has one adjustable shelf

Options:

- must specify chassis grain direction on artisan veneer, see pages 13-15 for details
- locking doors available, specify and add \$153 list
- veneer door and drawer fronts in paint available, specify paint color and add \$372; see page 16 for details
- on laminate units, contrasting worksurface tops and door fronts available, no upcharge; specify laminate color, see page 16 for details
- ledge pulls standard; prism pulls available, specify and see page 9
- oval grommets in back panel can be eliminated upon request, no upcharge
- interior horizontal wire manager with end grommets available, specify and add \$199 list; see page 40 for details
- top grommet available, specify location; add \$142 list each; see page 46 for details
- worksurface power available, specify "to accommodate EC26" on your purchase order; EC26 unit must be ordered separately, see page 46

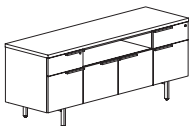
 Box/File Storage Credenza with Open Center - Inset Legs	22	72	29	295	32	FLT2272-29S585	\$4,039		
	22	72	29	295	32	FLV2272-29S585		\$5,243	\$5,768
	22	60	29	250	27	FLT2260-29S585	\$3,901		
	22	60	29	250	27	FLV2260-29S585		\$5,067	\$5,573

Features:

- eased edge profile user side
- pedestal front locking
- hinged door compartment has one adjustable shelf

Options:

- must specify chassis grain direction on artisan veneer, see pages 13-15 for details
- locking doors available, specify and add \$153 list
- veneer door and drawer fronts in paint available, specify paint color and add \$372; see page 16 for details
- on laminate units, contrasting worksurface tops and door fronts available, no upcharge; specify laminate color, see page 16 for details
- ledge pulls standard; prism pulls available, specify and see page 9
- oval grommets in back panel can be eliminated upon request, no upcharge
- interior horizontal wire manager with end grommets available, specify and add \$199 list; see page 40 for details
- top grommet available, specify location; add \$142 list each; see page 46 for details
- worksurface power available, specify "to accommodate EC26" on your purchase order; EC26 unit must be ordered separately, see page 46

To Order, Specify:

① Laminate Model #	② Laminate Type	③ Laminate Selection	④ Metal Color	⑤ Other Product Options
Laminate (FLT)	HPL	See Laminate Selection	See Metal Finish Color Options	See list of options for each specific unit; Specify and add accordingly.
① Veneer Model #	② Wood Collection	③ Wood Finish	④ Metal Color	⑤ Other Product Options
Veneer (FLV)	Essentials	See Essentials Wood Finish Options	See Metal Finish Color Options	See list of options for each specific unit; Specify and add accordingly.
	Artisan	③a Wood Finish See Artisan Wood Finish Options	③b Chassis Grain Direction For Artisan Only: Vertical Horizontal	

Description	D	W	H	CTN WT	CU FT	① Model	HPL Laminate	Essentials Veneer	Artisan Veneer
Box/Lateral File Credenza - Flush Legs	22	90	29	392	40	FLT2290-29L666	\$4,459		
	22	90	29	392	40	FLV2290-29L666		\$5,790	\$6,370

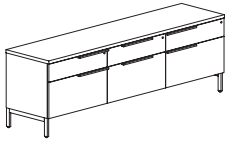

Features:

- eased edge profile user side
- pedestal front locking

Options:

- must specify chassis grain direction on artisan veneer, see pages 13-15 for details
- concealed box drawer(s) available, specify location in unit; add \$259 list for each laminate drawer or \$394 for each veneer drawer, see page 25 for details
- veneer drawer fronts in paint available, specify paint color and add \$372 list; see page 16 for details
- on laminate units, contrasting worksurface tops and drawer fronts available, no upcharge; specify color, see page 16 for details
- ledge pulls standard; prism pulls available, specify and see page 9
- oval grommets in back panel can be eliminated upon request, no upcharge
- interior horizontal wire manager with end grommets available, specify and add \$199 list; see page 40 for details
- top grommet available, specify location; add \$142 list each; see page 46 for details

FLUX

Box/Lateral File Credenza - Inset Legs	22	90	29	301	32	FLT2290-29S666	\$4,459		
	22	90	29	301	32	FLV2290-29S666		\$5,790	\$6,370

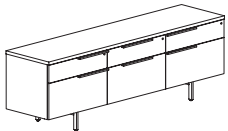

Features:

- eased edge profile user side
- pedestal front locking

Options:

- must specify chassis grain direction on artisan veneer, see pages 13-15 for details
- concealed box drawer(s) available, specify location in unit; add \$259 list for each laminate drawer or \$394 for each veneer drawer, see page 25 for details
- veneer drawer fronts in paint available, specify paint color and add \$372 list; see page 16 for details
- on laminate units, contrasting worksurface tops and drawer fronts available, no upcharge; specify color, see page 16 for details
- ledge pulls standard; prism pulls available, specify and see page 9
- oval grommets in back panel can be eliminated upon request, no upcharge
- interior horizontal wire manager with end grommets available, specify and add \$199 list; see page 40 for details
- top grommet available, specify location; add \$142 list each; see page 46 for details

Description	D	W	H	CTN WT	CU FT	① Model	HPL Laminate	Essentials Veneer	Artisan Veneer
Box/Lateral File Credenza - Flush Legs	22	72	29	303	32	FLT2272-29L66	\$3,498		
	22	72	29	303	32	FLV2272-29L66		\$4,538	\$4,992
	22	60	29	268	27	FLT2260-29L66	\$3,387		
	22	60	29	268	27	FLV2260-29L66		\$4,399	\$4,842



Features:

- eased edge profile user side
- pedestal front locking

Options:

- must specify chassis grain direction on artisan veneer, see pages 13-15 for details
- concealed box drawer(s) available, specify location in unit; add \$259 list for each laminate drawer or \$394 for each veneer drawer, see page 25 for details
- veneer drawer fronts in paint available, specify paint color and add \$372 list; see page 16 for details
- on laminate units, contrasting worksurface tops and drawer fronts available, no upcharge; specify color, see page 16 for details
- ledge pulls standard; prism pulls available, specify and see page 9
- oval grommets in back panel can be eliminated upon request, no upcharge
- interior horizontal wire manager with end grommets available, specify and add \$199 list; see page 40 for details
- top grommet available, specify location; add \$142 list each; see page 46 for details

Description	D	W	H	CTN WT	CU FT	① Model	HPL Laminate	Essentials Veneer	Artisan Veneer
Box/Lateral File Credenza - Inset Legs	22	72	29	266	27	FLT2272-29S66	\$3,498		
	22	72	29	266	27	FLV2272-29S66		\$4,538	\$4,992
	22	60	29	323	40	FLT2260-29S66	\$3,387		
	22	60	29	323	40	FLV2260-29S66		\$4,399	\$4,842



Features:

- eased edge profile user side
- pedestal front locking

Options:

- must specify chassis grain direction on artisan veneer, see pages 13-15 for details
- concealed box drawer(s) available, specify location in unit; add \$259 list for each laminate drawer or \$394 for each veneer drawer, see page 25 for details
- veneer drawer fronts in paint available, specify paint color and add \$372 list; see page 16 for details
- on laminate units, contrasting worksurface tops and drawer fronts available, no upcharge; specify color, see page 16 for details
- ledge pulls standard; prism pulls available, specify and see page 9
- oval grommets in back panel can be eliminated upon request, no upcharge
- interior horizontal wire manager with end grommets available, specify and add \$199 list; see page 40 for details
- top grommet available, specify location; add \$142 list each; see page 46 for details

To Order, Specify:

① Laminate Model #	② Laminate Type	③ Laminate Selection	④ Metal Color	⑤ Other Product Options		
Laminate (FLT)	HPL	See Laminate Selection	See Metal Finish Color Options	See list of options for each specific unit; Specify and add accordingly.		
① Veneer Model #	② Wood Collection	③ Wood Finish	④ Metal Color	⑤ Other Product Options		
Veneer (FLV)	Essentials	See Essentials Wood Finish Options	See Metal Finish Color Options	See list of options for each specific unit; Specify and add accordingly.		
	Artisan	<table border="1"> <thead> <tr> <th>ⓐ Wood Finish</th> <th>ⓑ Chassis Grain Direction</th> </tr> </thead> <tbody> <tr> <td>See Artisan Wood Finish Options</td> <td>For Artisan Only: Vertical Horizontal</td> </tr> </tbody> </table>	ⓐ Wood Finish		ⓑ Chassis Grain Direction	See Artisan Wood Finish Options
ⓐ Wood Finish	ⓑ Chassis Grain Direction					
See Artisan Wood Finish Options	For Artisan Only: Vertical Horizontal					

FLUX

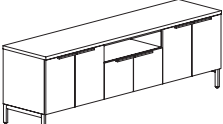
Description	D	W	H	CTN WT	CU FT	① Model	HPL Laminate	Essentials Veneer	Artisan Veneer
Six Door Credenza Open Center - Flush Legs 	22	96	29	332	43	FLT2296-29L787	\$4,277		
	22	96	29	332	43	FLV2296-29L787		\$5,552	\$6,108
	22	90	29	321	40	FLT2290-29L787	\$4,174		
	22	90	29	321	40	FLV2290-29L787		\$5,421	\$5,962
	22	84	29	296	38	FLT2284-29L787	\$4,065		
	22	84	29	296	38	FLV2284-29L787		\$5,278	\$5,806

Features:

- eased edge profile user side
- each end compartment has one adjustable shelf

Options:

- must specify chassis grain direction on artisan veneer, see pages 13-15 for details
- locking doors available, specify and add \$459 list
- veneer door fronts in paint available, specify paint color and add \$372 list; see page 16 for details
- on laminate units, contrasting worksurface tops and door fronts available, no upcharge; specify laminate color, see page 16 for details
- ledge pulls standard; prism pulls available, specify and see page 9
- oval grommets in back panel can be eliminated upon request, no upcharge
- interior horizontal wire manager with end grommets available, specify and add \$199 list; see page 40 for details
- top grommet available, specify location; add \$142 list each; see page 46 for details
- worksurface power available, specify "to accommodate EC26" on your purchase order; EC26 unit must be ordered separately, see page 46

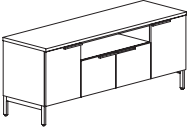
Four Door Credenza Open Center - Flush Legs 	22	78	29	279	35	FLT2278-29L787	\$3,942		
	22	78	29	279	35	FLV2278-29L787		\$5,119	\$5,630
	22	72	29	265	32	FLT2272-29L787	\$3,817		
	22	72	29	265	32	FLV2272-29L787		\$4,954	\$5,451
	22	66	29	247	30	FLT2266-29L787	\$3,725		
	22	66	29	247	30	FLV2266-29L787		\$4,836	\$5,320
	22	60	29	229	27	FLT2260-29L787	\$3,627		
	22	60	29	229	27	FLV2260-29L787		\$4,709	\$5,181

Features:

- eased edge profile user side
- each end compartment has one adjustable shelf

Options:

- must specify chassis grain direction on artisan veneer, see pages 13-15 for details
- locking doors available, specify and add \$459 list
- veneer door fronts in paint available, specify paint color and add \$372 list; see page 16 for details
- on laminate units, contrasting worksurface tops and door fronts available, no upcharge; specify laminate color, see page 16 for details
- ledge pulls standard; prism pulls available, specify and see page 9
- oval grommets in back panel can be eliminated upon request, no upcharge
- interior horizontal wire manager with end grommets available, specify and add \$199 list; see page 40 for details
- top grommet available, specify location; add \$142 list each; see page 46 for details
- worksurface power available, specify "to accommodate EC26" on your purchase order; EC26 unit must be ordered separately, see page 46

Description	D	W	H	CTN WT	CU FT	① Model	HPL Laminate	Essentials Veneer	Artisan Veneer
Six Door Storage with Open Center - Inset Legs	22	90	29	318	40	FLT2290-29S787	\$4,174		
	22	90	29	318	40	FLV2290-29S787		\$5,421	\$5,962

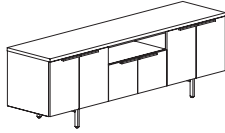

Features:

- eased edge profile user side
- each end compartment has one adjustable shelf

Options:

- must specify chassis grain direction on artisan veneer, see pages 13-15 for details
- locking doors available, specify and add \$459 list
- veneer door fronts in paint available, specify paint color and add \$372 list; see page 16 for details
- on laminate units, contrasting worksurface tops and door fronts available, no upcharge; specify color, see page 16 for details
- ledge pulls standard; prism pulls available, specify and see page 9
- oval grommets in back panel can be eliminated upon request, no upcharge
- interior horizontal wire manager with end grommets available, specify and add \$199 list; see page 40 for details
- top grommet available, specify location; add \$142 list each; see page 46 for details
- worksurface power available, specify "to accommodate EC26" on your purchase order; EC26 unit must be ordered separately, see page 46

Hinge Door Storage with Open Center - Inset Legs	22	72	29	270	32	FLT2272-29S787	\$3,817		
	22	72	29	270	32	FLV2272-29S787		\$4,954	\$5,451
	22	60	29	234	27	FLT2260-29S787	\$3,627		
	22	60	29	234	27	FLV2260-29S787		\$4,709	\$5,181

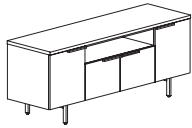

Features:

- eased edge profile user side
- each end compartment has one adjustable shelf

Options:

- must specify chassis grain direction on artisan veneer, see pages 13-15 for details
- locking doors available, specify and add \$459 list
- veneer door fronts in paint available, specify paint color and add \$372 list; see page 16 for details
- on laminate units, contrasting worksurface tops and door fronts available, no upcharge; specify color, see page 16 for details
- ledge pulls standard; prism pulls available, specify and see page 9
- oval grommets in back panel can be eliminated upon request, no upcharge
- interior horizontal wire manager with end grommets available, specify and add \$199 list; see page 40 for details
- top grommet available, specify location; add \$142 list each; see page 46 for details
- worksurface power available, specify "to accommodate EC26" on your purchase order; EC26 unit must be ordered separately, see page 46

To Order, Specify:

① Laminate Model #	② Laminate Type	③ Laminate Selection	④ Metal Color	⑤ Other Product Options		
Laminate (FLT)	HPL	See Laminate Selection	See Metal Finish Color Options	See list of options for each specific unit; Specify and add accordingly.		
① Veneer Model #	② Wood Collection	③ Wood Finish	④ Metal Color	⑤ Other Product Options		
Veneer (FLV)	Essentials	See Essentials Wood Finish Options	See Metal Finish Color Options	See list of options for each specific unit; Specify and add accordingly.		
	Artisan	<table border="1"> <thead> <tr> <th>③a Wood Finish</th> <th>③b Chassis Grain Direction</th> </tr> </thead> <tbody> <tr> <td>See Artisan Wood Finish Options</td> <td>For Artisan Only: Vertical Horizontal</td> </tr> </tbody> </table>	③a Wood Finish		③b Chassis Grain Direction	See Artisan Wood Finish Options
③a Wood Finish	③b Chassis Grain Direction					
See Artisan Wood Finish Options	For Artisan Only: Vertical Horizontal					

FLUX

Description	D	W	H	CTN WT	CU FT	① Model	HPL Laminate	Essentials Veneer	Artisan Veneer
Six Door Storage Credenza - Flush Legs	22	96	29	336	43	FLT2296-29L777	\$4,316		
	22	96	29	336	43	FLV2296-29L777		\$5,603	\$6,165
	22	90	29	326	40	FLT2290-29L777	\$4,211		
	22	90	29	326	40	FLV2290-29L777		\$5,467	\$6,015
	22	84	29	302	38	FLT2284-29L777	\$4,113		
	22	84	29	302	38	FLV2284-29L777		\$5,343	\$5,877

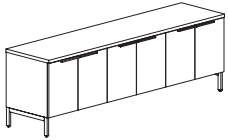

Features:

- eased edge profile user side
- each hinged door compartment has one adjustable shelf

Options:

- must specify chassis grain direction on artisan veneer, see pages 13-15 for details
- locking doors available, specify and add \$459 list
- veneer door fronts in paint available, specify paint color and add \$372 list; see page 16 for details
- on laminate units, contrasting worksurface tops and door fronts available, no upcharge; specify color, see page 16 for details
- ledge pulls standard; prism pulls available, specify and see page 9
- oval grommets in back panel can be eliminated upon request, no upcharge
- interior horizontal wire manager with end grommets available, specify and add \$199 list; see page 40 for details
- top grommet available, specify location; add \$142 list each; see page 46 for details
- worksurface power available, specify "to accommodate EC26" on your purchase order; EC26 unit must be ordered separately, see page 46

Six Door Storage Credenza - Inset Legs	22	90	29	320	40	FLT2290-29S777	\$4,211		
	22	90	29	320	40	FLV2290-29S777		\$5,467	\$6,015

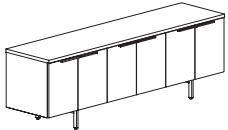

Features:

- eased edge profile user side
- each hinged door compartment has one adjustable shelf

Options:

- must specify chassis grain direction on artisan veneer, see pages 13-15 for details
- locking doors available, specify and add \$459 list
- veneer door fronts in paint available, specify paint color and add \$372 list; see page 16 for details
- on laminate units, contrasting worksurface tops and door fronts available, no upcharge; specify color, see page 16 for details
- ledge pulls standard; prism pulls available, specify and see page 9
- oval grommets in back panel can be eliminated upon request, no upcharge
- interior horizontal wire manager with end grommets available, specify and add \$199 list; see page 40 for details
- top grommet available, specify location; add \$142 list each; see page 46 for details
- worksurface power available, specify "to accommodate EC26" on your purchase order; EC26 unit must be ordered separately, see page 46

FLUX

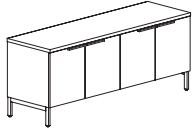
Description	D	W	H	CTN WT	CU FT	① Model	HPL Laminate	Essentials Veneer	Artisan Veneer
Four Door Storage Credenza - Flush Legs 	22	78	29	277	35	FLT2278-29L77	\$3,832		
	22	78	29	277	35	FLV2278-29L77		\$4,977	\$5,475
	22	72	29	263	32	FLT2272-29L77	\$3,726		
	22	72	29	263	32	FLV2272-29L77		\$4,838	\$5,322
	22	66	29	239	30	FLT2266-29L77	\$3,606		
	22	66	29	239	30	FLV2266-29L77		\$4,682	\$5,148
	22	60	29	226	27	FLT2260-29L77	\$3,483		
	22	60	29	226	27	FLV2260-29L77		\$4,524	\$4,976

Features:

- eased edge profile user side
- each hinged door compartment has one adjustable shelf

Options:

- must specify chassis grain direction on artisan veneer, see pages 13-15 for details
- locking doors available, specify and add \$306 list
- veneer door fronts in paint available, specify paint color and add \$372 list; see page 16 for details
- on laminate units, contrasting worksurface tops and door fronts available, no upcharge; specify color, see page 16 for details
- ledge pulls standard; prism pulls available, specify and see page 9
- oval grommets in back panel can be eliminated upon request, no upcharge
- interior horizontal wire manager with end grommets available, specify and add \$199 list; see page 40 for details
- top grommet available, specify location; add \$142 list each; see page 46 for details
- worksurface power available, specify "to accommodate EC26" on your purchase order; EC26 unit must be ordered separately, see page 46

Four Door Storage Credenza - Inset Legs 	22	72	29	258	32	FLT2272-29S77	\$3,726		
	22	72	29	258	32	FLV2272-29S77		\$4,838	\$5,322
	22	60	29	224	27	FLT2260-29S77	\$3,483		
	22	60	29	224	27	FLV2260-29S77		\$4,524	\$4,976

Features:

- eased edge profile user side
- each hinged door compartment has one adjustable shelf

Options:

- must specify chassis grain direction on artisan veneer, see pages 13-15 for details
- locking doors available, specify and add \$306 list
- veneer door fronts in paint available, specify paint color and add \$372 list; see page 16 for details
- on laminate units, contrasting worksurface tops and door fronts available, no upcharge; specify color, see page 16 for details
- ledge pulls standard; prism pulls available, specify and see page 9
- oval grommets in back panel can be eliminated upon request, no upcharge
- interior horizontal wire manager with end grommets available, specify and add \$199 list; see page 40 for details
- top grommet available, specify location; add \$142 list each; see page 46 for details
- worksurface power available, specify "to accommodate EC26" on your purchase order; EC26 unit must be ordered separately, see page 46

To Order, Specify:

① Laminate Model #	② Laminate Type	③ Laminate Selection	④ Metal Color	⑤ Other Product Options
Laminate (FLT)	HPL	See Laminate Selection	See Metal Finish Color Options	See list of options for each specific unit; Specify and add accordingly.
① Veneer Model #	② Wood Collection	③ Wood Finish	④ Metal Color	⑤ Other Product Options
Veneer (FLV)	Essentials	See Essentials Wood Finish Options	See Metal Finish Color Options	See list of options for each specific unit; Specify and add accordingly.
	Artisan	ⓐ Wood Finish See Artisan Wood Finish Options	ⓑ Chassis Grain Direction For Artisan Only: Vertical Horizontal	

Description	D	W	H	CTN WT	CU FT	① Model	HPL Laminate	Essentials Veneer	Artisan Veneer
Three Door Storage Credenza - Flush Legs	22	54	29	207	25	FLT2254-29L77R	\$3,222		
	22	54	29	207	25	FLV2254-29L77R		\$4,182	\$4,602
	22	54	29	207	25	FLT2254-29L77L	\$3,222		
	22	54	29	207	25	FLV2254-29L77L		\$4,182	\$4,602
	22	42	29	171	19	FLT2242-29L77R	\$3,085		
	22	42	29	171	19	FLV2242-29L77R		\$4,005	\$4,405
	22	42	29	171	19	FLT2242-29L77L	\$3,085		
	22	42	29	171	19	FLV2242-29L77L		\$4,005	\$4,405

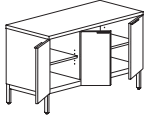

left shown

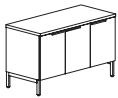

right

Features:

- eased edge profile user side
- each hinged door compartment has one adjustable shelf

Options:

- must specify chassis grain direction on artisan veneer, see pages 13-15 for details
- locking doors available, specify and add \$306 list
- veneer door fronts in paint available, specify paint color and add \$372 list; see page 16 for details
- on laminate units, contrasting worksurface tops and door fronts available, no upcharge; specify color, see page 16 for details
- ledge pulls standard; prism pulls available, specify and see page 9
- oval grommet in back panel can be eliminated upon request, no upcharge
- interior horizontal wire manager with end grommets available, specify and add \$199 list; see page 40 for details
- top grommet available, specify location; add \$142 list each; see page 46 for details
- worksurface power available, specify "to accommodate EC26" on your purchase order; EC26 unit must be ordered separately, see page 46

Description	D	W	H	CTN WT	CU FT	① Model	HPL Laminate	Essentials Veneer	Artisan Veneer
Two Door Storage - Flush Legs	22	36	29	144	17	FLT2236-29L7	\$2,965		
	22	36	29	144	17	FLV2236-29L7		\$3,849	\$4,231
	22	30	29	126	14	FLT2230-29L7	\$2,906		
	22	30	29	126	14	FLV2230-29L7		\$3,770	\$4,148



Features:

- eased edge profile user side
- hinged door compartment has one adjustable shelf

Options:

- must specify chassis grain direction on artisan veneer, see pages 13-15 for details
- locking doors available, specify and add \$153 list
- veneer door fronts in paint available, specify paint color and add \$372 list; see page 16 for details
- on laminate units, contrasting worksurface tops and door fronts available, no upcharge; specify color, see page 16 for details
- ledge pulls standard; prism pulls available, specify and see page 9
- oval grommet in back panel can be eliminated upon request, no upcharge
- interior horizontal wire manager with end grommets available, specify and add \$199 list; see page 40 for details
- top grommet available, specify location; add \$142 list each; see page 46 for details
- worksurface power available, specify "to accommodate EC26" on your purchase order; EC26 unit must be ordered separately, see page 46

FLUX

To Order, Specify:

① Laminate Model #	② Laminate Type	③ Laminate Selection	④ Metal Color	⑤ Other Product Options	
Laminate (FLT)	HPL	See Laminate Selection	See Metal Finish Color Options	See list of options for each specific unit; Specify and add accordingly.	
① Veneer Model #	② Wood Collection	③ Wood Finish	④ Metal Color	⑤ Other Product Options	
Veneer (FLV)	Essentials	See Essentials Wood Finish Options	See Metal Finish Color Options	See list of options for each specific unit; Specify and add accordingly.	
	Artisan	<table border="1"> <thead> <tr> <th>③a Wood Finish</th> <th>③b Chassis Grain Direction</th> </tr> </thead> <tbody> <tr> <td>See Artisan Wood Finish Options</td> <td>For Artisan Only: Vertical Horizontal</td> </tr> </tbody> </table>			③a Wood Finish
③a Wood Finish	③b Chassis Grain Direction				
See Artisan Wood Finish Options	For Artisan Only: Vertical Horizontal				

Description	D	W	H	CTN WT	CU FT	① Model	HPL Laminate	Essentials Veneer	Artisan Veneer
Box/Lateral with Open Storage Credenza - Flush Legs	22	96	29	352	43	FLT2296-29L606	\$4,374		
	22	96	29	352	43	FLV2296-29L606		\$5,679	\$6,248
	22	90	29	345	40	FLT2290-29L606	\$4,269		
	22	90	29	345	40	FLV2290-29L606		\$5,541	\$6,096

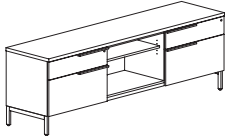

Features:

- eased edge profile user side
- pedestal front locking
- open compartment with adjustable shelf
- shelf 12 1/2"d

Options:

- must specify chassis grain direction on artisan veneer, see pages 13-15 for details
- concealed box drawer(s) available, specify location in unit; add \$259 list for each laminate drawer or \$394 for each veneer drawer, see page 25 for details
- veneer drawer fronts in paint available, specify paint color and add \$372 list; see page 16 for details
- on laminate units, contrasting worksurface tops and drawer fronts available, no upcharge; specify color, see page 16 for details
- ledge pulls standard; prism pulls available, specify and see page 9
- oval grommets in back panel can be eliminated upon request, no upcharge
- interior horizontal wire manager with end grommets available, specify and add \$199 list; see page 40 for details
- top grommet available, specify location; add \$142 list each; see page 46 for details
- worksurface power available, specify "to accommodate EC26" on your purchase order; EC26 unit must be ordered separately, see page 46

Box/Lateral File with Open Storage Credenza - Inset Legs	22	90	29	367	40	FLT2290-29S606	\$4,269		
	22	90	29	367	40	FLV2290-29S606		\$5,541	\$6,096

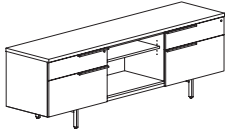

Features:

- eased edge profile user side
- pedestal front locking
- open compartment with adjustable shelf
- shelf 12 1/2"d

Options:

- must specify chassis grain direction on artisan veneer, see pages 13-15 for details
- concealed box drawer(s) available, specify location in unit; add \$259 list for each laminate drawer or \$394 for each veneer drawer, see page 25 for details
- veneer drawer fronts in paint available, specify paint color and add \$372 list; see page 16 for details
- on laminate units, contrasting worksurface tops and drawer fronts available, no upcharge; specify color, see page 16 for details
- ledge pulls standard; prism pulls available, specify and see page 9
- oval grommets in back panel can be eliminated upon request, no upcharge
- interior horizontal wire manager with end grommets available, specify and add \$199 list; see page 40 for details
- top grommet available, specify location; add \$142 list each; see page 46 for details
- worksurface power available, specify "to accommodate EC26" on your purchase order; EC26 unit must be ordered separately, see page 46

FLUX

Description	D	W	H	CTN WT	CU FT	① Model	HPL Laminate	Essentials Veneer	Artisan Veneer
Box/Lateral with Open Storage Credenza - Flush Legs	22	96	29	320	43	FLT2296-29L060	\$4,110		
	22	96	29	320	43	FLV2296-29L060		\$5,337	\$5,871
	22	90	29	312	40	FLT2290-29L060	\$4,010		
	22	90	29	312	40	FLV2290-29L060		\$5,208	\$5,728

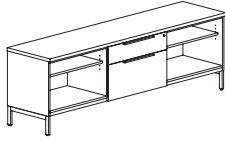

Features:

- eased edge profile user side
- pedestal front locking
- each open compartment has one adjustable shelf
- shelves 12 1/2"d

Options:

- must specify chassis grain direction on artisan veneer, see pages 13-15 for details
- concealed box drawer available, specify; add \$259 list for each laminate drawer or \$394 for each veneer drawer, see page 25 for details
- veneer drawer fronts in paint available, specify paint color and add \$372 list; see page 16 for details
- on laminate units, contrasting worksurface tops and drawer fronts available, no upcharge; specify color, see page 16 for details
- ledge pulls standard; prism pulls available, specify and see page 9
- oval grommets in back panel can be eliminated upon request, no upcharge
- interior horizontal wire manager with end grommets available, specify and add \$199 list; see page 40 for details
- top grommet available, specify location; add \$142 list each; see page 46 for details
- worksurface power available, specify "to accommodate EC26" on your purchase order; EC26 unit must be ordered separately, see page 46

Box/File with Open Storage Credenza - Inset Legs	22	90	29	330	40	FLT2290-29S060	\$4,010		
	22	90	29	330	40	FLV2290-29S060		\$5,208	\$5,728

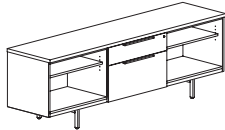

Features:

- eased edge profile user side
- pedestal front locking
- each open compartment has one adjustable shelf
- shelves 12 1/2"d

Options:

- must specify chassis grain direction on artisan veneer, see pages 13-15 for details
- concealed box drawer available, specify; add \$259 list for each laminate drawer or \$394 for each veneer drawer, see page 25 for details
- veneer drawer fronts in paint available, specify paint color and add \$372 list; see page 16 for details
- on laminate units, contrasting worksurface tops and drawer fronts available, no upcharge; specify color, see page 16 for details
- ledge pulls standard; prism pulls available, specify and see page 9
- oval grommets in back panel can be eliminated upon request, no upcharge
- interior horizontal wire manager with end grommets available, specify and add \$199 list; see page 40 for details
- top grommet available, specify location; add \$142 list each; see page 46 for details
- worksurface power available, specify "to accommodate EC26" on your purchase order; EC26 unit must be ordered separately, see page 46

To Order, Specify:

① Laminate Model #	② Laminate Type	③ Laminate Selection	④ Metal Color	⑤ Other Product Options		
Laminate (FLT)	HPL	See Laminate Selection	See Metal Finish Color Options	See list of options for each specific unit; Specify and add accordingly.		
① Veneer Model #	② Wood Collection	③ Wood Finish	④ Metal Color	⑤ Other Product Options		
Veneer (FLV)	Essentials	See Essentials Wood Finish Options	See Metal Finish Color Options	See list of options for each specific unit; Specify and add accordingly.		
	Artisan	<table border="1"> <thead> <tr> <th>ⓐ Wood Finish</th> <th>ⓑ Chassis Grain Direction</th> </tr> </thead> <tbody> <tr> <td>See Artisan Wood Finish Options</td> <td>For Artisan Only: Vertical Horizontal</td> </tr> </tbody> </table>	ⓐ Wood Finish		ⓑ Chassis Grain Direction	See Artisan Wood Finish Options
ⓐ Wood Finish	ⓑ Chassis Grain Direction					
See Artisan Wood Finish Options	For Artisan Only: Vertical Horizontal					

Description	D	W	H	CTN WT	CU FT	① Model	HPL Laminate	Essentials Veneer	Artisan Veneer
Box/Lateral File with Open Storage Credenza - Flush Legs	22	96	29	360	43	FLT2296-29L066	\$4,374		
	22	96	29	360	43	FLV2296-29L066		\$5,679	\$6,248
	22	96	29	360	43	FLT2296-29L660	\$4,374		
	22	96	29	360	43	FLV2296-29L660		\$5,679	\$6,248
	22	90	29	353	40	FLT2290-29L066	\$4,269		
	22	90	29	353	40	FLV2290-29L066		\$5,541	\$6,096
	22	90	29	353	40	FLT2290-29L660	\$4,269		
	22	90	29	353	40	FLV2290-29L660		\$5,541	\$6,096

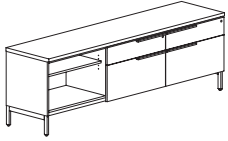

*066 shown

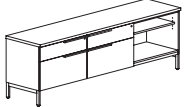

*660

Features:

- eased edge profile user side
- pedestal front locking
- open compartment with adjustable shelf
- shelf 12 1/2"d

Options:

- must specify chassis grain direction on artisan veneer, see pages 13-15 for details
- concealed box drawer(s) available, specify location in unit; add \$259 list for each laminate drawer or \$394 for each veneer drawer, see page 25 for details
- veneer drawer fronts in paint available, specify paint color and add \$372 list; see page 16 for details
- on laminate units, contrasting worksurface tops and drawer fronts available, no upcharge; specify color, see page 16 for details
- ledge pulls standard; prism pulls available, specify and see page 9
- oval grommets in back panel can be eliminated upon request, no upcharge
- interior horizontal wire manager with end grommets available, specify and add \$199 list; see page 40 for details
- top grommet available, specify location; add \$142 list each; see page 47 for details
- worksurface power available, specify "to accommodate EC26" on your purchase order; EC26 unit must be ordered separately, see page 47

Description	D	W	H	CTN WT	CU FT	① Model	HPL Laminate	Essentials Veneer	Artisan Veneer
Box/Lateral File with Open Storage Credenza - Inset Legs	22	90	29	350	40	FLT2290-29S066	\$4,269		
	22	90	29	350	40	FLV2290-29S066		\$5,541	\$6,096
	22	90	29	350	40	FLT2290-29S660	\$4,269		
	22	90	29	350	40	FLV2290-29S660		\$5,541	\$6,096

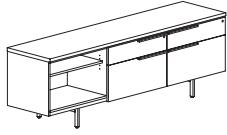

*066 shown

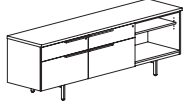

*660

Features:

- eased edge profile user side
- pedestal front locking
- open compartment with adjustable shelf
- shelf 12 1/2" d

Options:

- must specify chassis grain direction on artisan veneer, see pages 13-15 for details
- concealed box drawer(s) available, specify location in unit; add \$259 list for each laminate drawer or \$394 for each veneer drawer, see page 25 for details
- veneer drawer fronts in paint available, specify paint color and add \$372 list; see page 16 for details
- on laminate units, contrasting worksurface tops and drawer fronts available, no upcharge; specify color, see page 16 for details
- ledge pulls standard; prism pulls available, specify and see page 9
- oval grommets in back panel can be eliminated upon request, no upcharge
- interior horizontal wire manager with end grommets available, specify and add \$199 list; see page 40 for details
- top grommet available, specify location; add \$142 list each; see page 47 for details
- worksurface power available, specify "to accommodate EC26" on your purchase order; EC26 unit must be ordered separately, see page 47

FLUX

To Order, Specify:

① Laminate Model #	② Laminate Type	③ Laminate Selection	④ Metal Color	⑤ Other Product Options		
Laminate (FLT)	HPL	See Laminate Selection	See Metal Finish Color Options	See list of options for each specific unit; Specify and add accordingly.		
① Veneer Model #	② Wood Collection	③ Wood Finish	④ Metal Color	⑤ Other Product Options		
Veneer (FLV)	Essentials	See Essentials Wood Finish Options	See Metal Finish Color Options	See list of options for each specific unit; Specify and add accordingly.		
	Artisan	<table border="1"> <tr> <th>ⓐ Wood Finish</th> <th>ⓑ Chassis Grain Direction</th> </tr> <tr> <td>See Artisan Wood Finish Options</td> <td>For Artisan Only: Vertical Horizontal</td> </tr> </table>	ⓐ Wood Finish		ⓑ Chassis Grain Direction	See Artisan Wood Finish Options
ⓐ Wood Finish	ⓑ Chassis Grain Direction					
See Artisan Wood Finish Options	For Artisan Only: Vertical Horizontal					

Description	D	W	H	CTN WT	CU FT	① Model	HPL Laminate	Essentials Veneer	Artisan Veneer
Box/Lateral File with Open	22	72	29	265	32	FLT2272-29L06	\$3,517		
Storage Credenza - Flush Legs	22	72	29	265	32	FLV2272-29L06		\$4,564	\$5,018
	22	72	29	265	32	FLT2272-29L60	\$3,517		
	22	72	29	265	32	FLV2272-29L60		\$4,564	\$5,018
	22	66	29	238	30	FLT2266-29L06	\$3,374		
	22	66	29	238	30	FLV2266-29L06		\$4,381	\$4,819
	22	66	29	238	30	FLT2266-29L60	\$3,374		
	22	66	29	238	30	FLV2266-29L60		\$4,381	\$4,819
	22	60	29	238	27	FLT2260-29L06	\$3,237		
	22	60	29	238	27	FLV2260-29L06		\$4,202	\$4,622
	22	60	29	228	27	FLT2260-29L60	\$3,237		
	22	60	29	228	27	FLV2260-29L60		\$4,202	\$4,622

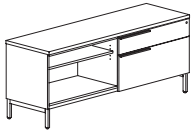

*06 shown

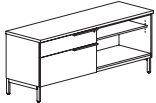

*60

Features:

- eased edge profile user side
- pedestal front locking
- open compartment with adjustable shelf
- shelf 12 1/2"d

Options:

- must specify chassis grain direction on artisan veneer, see pages 13-15 for details
- concealed box drawer available, specify; add \$259 list for each laminate drawer or \$394 for each veneer drawer, see page 25 for details
- veneer drawer fronts in paint available, specify paint color and add \$372 list; see page 16 for details
- on laminate units, contrasting worksurface tops and drawer fronts available, no upcharge; specify color, see page 16 for details
- ledge pulls standard; prism pulls available, specify and see page 9
- oval grommets in back panel can be eliminated upon request, no upcharge
- interior horizontal wire manager with end grommets available, specify and add \$199 list; see page 40 for details
- top grommet available, specify location; add \$142 list each; see page 47 for details
- worksurface power available, specify "to accommodate EC26" on your purchase order; EC26 unit must be ordered separately, see page 47

Description	D	W	H	CTN WT	CU FT	① Model	HPL Laminate	Essentials Veneer	Artisan Veneer
Box/Lateral File with Open Storage Credenza - Inset Legs	22	72	29	265	32	FLT2272-29S06	\$3,517		
	22	72	29	265	32	FLV2272-29S06		\$4,564	\$5,018
	22	72	29	265	32	FLT2272-29S60	\$3,517		
	22	72	29	265	32	FLV2272-29S60		\$4,564	\$5,018
	22	60	29	226	27	FLT2260-29S06	\$3,237		
	22	60	29	226	27	FLV2260-29S06		\$4,202	\$4,622
	22	60	29	226	27	FLT2260-29S60	\$3,237		
	22	60	29	226	27	FLV2260-29S60		\$4,202	\$4,622

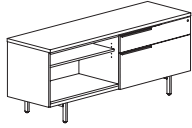

*06 shown

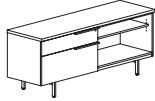

*60

Features:

- eased edge profile user side
- pedestal front locking
- open compartment with adjustable shelf
- shelf 12 1/2" d

Options:

- must specify chassis grain direction on artisan veneer, see pages 13-15 for details
- concealed box drawer available, specify; add \$259 list for each laminate drawer or \$394 for each veneer drawer, see page 25 for details
- veneer drawer fronts in paint available, specify paint color and add \$372 list; see page 16 for details
- on laminate units, contrasting worksurface tops and drawer fronts available, no upcharge; specify color, see page 16 for details
- ledge pulls standard; prism pulls available, specify and see page 9
- oval grommets in back panel can be eliminated upon request, no upcharge
- interior horizontal wire manager with end grommets available, specify and add \$199 list; see page 40 for details
- top grommet available, specify location; add \$142 list each; see page 47 for details
- worksurface power available, specify "to accommodate EC26" on your purchase order; EC26 unit must be ordered separately, see page 47

To Order, Specify:

① Laminate Model #	② Laminate Type	③ Laminate Selection	④ Metal Color	⑤ Other Product Options		
Laminate (FLT)	HPL	See Laminate Selection	See Metal Finish Color Options	See list of options for each specific unit; Specify and add accordingly.		
① Veneer Model #	② Wood Collection	③ Wood Finish	④ Metal Color	⑤ Other Product Options		
Veneer (FLV)	Essentials	See Essentials Wood Finish Options	See Metal Finish Color Options	See list of options for each specific unit; Specify and add accordingly.		
	Artisan	<table border="1"> <thead> <tr> <th>③a Wood Finish</th> <th>③b Chassis Grain Direction</th> </tr> </thead> <tbody> <tr> <td>See Artisan Wood Finish Options</td> <td>For Artisan Only: Vertical Horizontal</td> </tr> </tbody> </table>	③a Wood Finish		③b Chassis Grain Direction	See Artisan Wood Finish Options
③a Wood Finish	③b Chassis Grain Direction					
See Artisan Wood Finish Options	For Artisan Only: Vertical Horizontal					

Description	D	W	H	CTN WT	CU FT	① Model	HPL Laminate	Essentials Veneer	Artisan Veneer
Double Sliding Door Credenza - Flush Legs	22	90	29	336	40	FLT2290-29L909	\$3,814		
	22	90	29	336	40	FLV2290-29L909		\$4,949	\$5,446

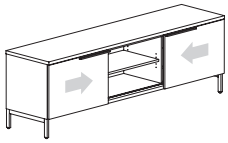

Features:

- eased edge profile user side
- locking doors not available
- open compartment with adjustable shelf
- shelves 12 1/2"d

Options:

- must specify chassis grain direction on artisan veneer, see pages 13-15 for details
- veneer door fronts in paint available, specify paint color and add \$372 list; see page 16 for details
- on laminate units, contrasting worksurface tops and door fronts available, no upcharge; specify color, see page 16 for details
- ledge pulls standard; prism pulls available, specify and see page 9
- oval grommets in back panel can be eliminated upon request, no upcharge
- interior horizontal wire manager with end grommets available, specify and add \$199 list; see page 40 for details
- top grommet available, specify location; add \$142 list each; see page 47 for details
- worksurface power available, specify "to accommodate EC26" on your purchase order; EC26 unit must be ordered separately, see page 47

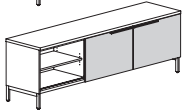
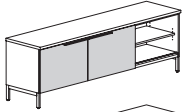

Double Sliding Door Credenza - Inset Legs	22	90	29	333	40	FLT2290-29S909	\$3,814		
	22	90	29	333	40	FLV2290-29S909		\$4,949	\$5,446

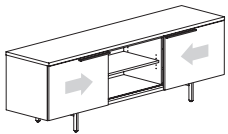

Features:

- eased edge profile user side
- locking doors not available
- open compartment with adjustable shelf
- shelves 12 1/2"d

Options:

- must specify chassis grain direction on artisan veneer, see pages 13-15 for details
- veneer door fronts in paint available, specify paint color and add \$372 list; see page 16 for details
- on laminate units, contrasting worksurface tops and door fronts available, no upcharge; specify color, see page 16 for details
- ledge pulls standard; prism pulls available, specify and see page 9
- oval grommets in back panel can be eliminated upon request, no upcharge
- interior horizontal wire manager with end grommets available, specify and add \$199 list; see page 40 for details
- top grommet available, specify location; add \$142 list each; see page 47 for details
- worksurface power available, specify "to accommodate EC26" on your purchase order; EC26 unit must be ordered separately, see page 47

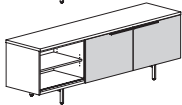
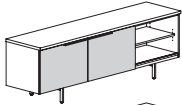

FLUX

Description	D	W	H	CTN WT	CU FT	① Model	HPL Laminate	Essentials Veneer	Artisan Veneer
Sliding Door Credenza - Flush Legs	22	90	29	319	40	FLT2290-29L090	\$3,658		
	22	90	29	319	40	FLV2290-29L090		\$4,750	\$5,225

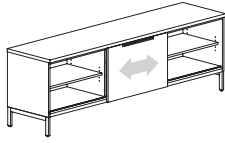

Features:

- eased edge profile user side
- locking door not available
- open compartment with adjustable shelf
- shelves 12 1/2"d

Options:

- must specify chassis grain direction on artisan veneer, see pages 13-15 for details
- veneer door fronts in paint available, specify paint color and add \$372 list; see page 16 for details
- on laminate units, contrasting worksurface tops and door fronts available, no upcharge; specify color, see page 16 for details
- ledge pulls standard; prism pulls available, specify and see page 9
- oval grommets in back panel can be eliminated upon request, no upcharge
- interior horizontal wire manager with end grommets available, specify and add \$199 list; see page 40 for details
- top grommet available, specify location; add \$142 list each; see page 47 for details
- worksurface power available, specify "to accommodate EC26" on your purchase order; EC26 unit must be ordered separately, see page 47

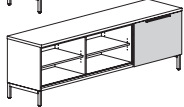
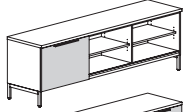

Sliding Door Credenza - Flush Legs	22	90	29	316	40	FLT2290-29S090	\$3,658		
	22	90	29	316	40	FLV2290-29S090		\$4,750	\$5,225

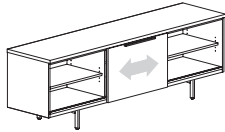

Features:

- eased edge profile user side
- locking door not available
- open compartment with adjustable shelf
- shelves 12 1/2"d

Options:

- must specify chassis grain direction on artisan veneer, see pages 13-15 for details
- veneer door fronts in paint available, specify paint color and add \$372 list; see page 16 for details
- on laminate units, contrasting worksurface tops and door fronts available, no upcharge; specify color, see page 16 for details
- ledge pulls standard; prism pulls available, specify and see page 9
- oval grommets in back panel can be eliminated upon request, no upcharge
- interior horizontal wire manager with end grommets available, specify and add \$199 list; see page 40 for details
- top grommet available, specify location; add \$142 list each; see page 47 for details
- worksurface power available, specify "to accommodate EC26" on your purchase order; EC26 unit must be ordered separately, see page 47

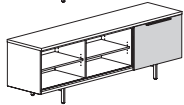
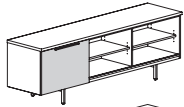

To Order, Specify:

① Laminate Model #	② Laminate Type	③ Laminate Selection	④ Metal Color	⑤ Other Product Options		
Laminate (FLT)	HPL	See Laminate Selection	See Metal Finish Color Options	See list of options for each specific unit; Specify and add accordingly.		
① Veneer Model #	② Wood Collection	③ Wood Finish	④ Metal Color	⑤ Other Product Options		
Veneer (FLV)	Essentials	See Essentials Wood Finish Options	See Metal Finish Color Options	See list of options for each specific unit; Specify and add accordingly.		
	Artisan	<table border="1"> <thead> <tr> <th>③a Wood Finish</th> <th>③b Chassis Grain Direction</th> </tr> </thead> <tbody> <tr> <td>See Artisan Wood Finish Options</td> <td>For Artisan Only: Vertical Horizontal</td> </tr> </tbody> </table>	③a Wood Finish		③b Chassis Grain Direction	See Artisan Wood Finish Options
③a Wood Finish	③b Chassis Grain Direction					
See Artisan Wood Finish Options	For Artisan Only: Vertical Horizontal					

Description	D	W	H	CTN WT	CU FT	① Model	HPL Laminate	Essentials Veneer	Artisan Veneer
Sliding Door Credenza - Flush Legs	22	72	29	250	32	FLT2272-29L09	\$3,281		
	22	72	29	250	32	FLV2272-29L09		\$4,260	\$4,687
	22	60	29	215	27	FLT2260-29L09	\$3,129		
	22	60	29	215	27	FLV2260-29L09		\$4,064	\$4,468

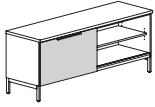
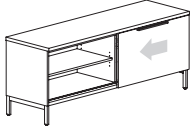

Features:

- eased edge profile user side
- locking door not available
- each compartment has one adjustable shelf
- shelves 12 1/2"d

Options:

- must specify chassis grain direction on artisan veneer, see pages 13-15 for details
- veneer door fronts in paint available, specify paint color and add \$372 list; see page 16 for details
- on laminate units, contrasting worksurface tops and door fronts available, no upcharge; specify color, see page 16 for details
- ledge pulls standard; prism pulls available, specify and see page 9
- oval grommets in back panel can be eliminated upon request, no upcharge
- interior horizontal wire manager with end grommets available, specify and add \$199 list; see page 40 for details
- top grommet available, specify location; add \$142 list each; see page 47 for details
- worksurface power available, specify "to accommodate EC26" on your purchase order; EC26 unit must be ordered separately, see page 47

Description	D	W	H	CTN WT	CU FT	① Model	HPL Laminate	Essentials Veneer	Artisan Veneer
Sliding Door Credenza - Inset Legs	22	72	29	244	32	FLT2272-29S09	\$3,281		
	22	72	29	244	32	FLV2272-29S09		\$4,260	\$4,687
	22	60	29	210	27	FLT2260-29S09	\$3,129		
	22	60	29	210	27	FLV2260-29S09		\$4,064	\$4,468

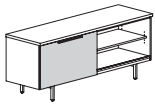
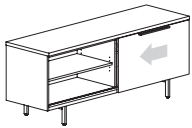

Features:

- eased edge profile user side
- locking door not available
- each compartment has one adjustable shelf
- shelves 12 1/2"d

Options:

- must specify chassis grain direction on artisan veneer, see pages 13-15 for details
- veneer door fronts in paint available, specify paint color and add \$372 list; see page 16 for details
- on laminate units, contrasting worksurface tops and door fronts available, no upcharge; specify color, see page 16 for details
- ledge pulls standard; prism pulls available, specify and see page 9
- oval grommets in back panel can be eliminated upon request, no upcharge
- interior horizontal wire manager with end grommets available, specify and add \$199 list; see page 40 for details
- top grommet available, specify location; add \$142 list each; see page 47 for details
- worksurface power available, specify "to accommodate EC26" on your purchase order; EC26 unit must be ordered separately, see page 47

FLUX

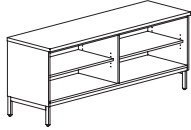
Description	D	W	H	CTN WT	CU FT	① Model	HPL Laminate	Essentials Veneer	Artisan Veneer
 Open Compartment Credenza - Flush Legs	22	72	29	230	32	FLT2272-29L00	\$3,129		
	22	72	29	230	32	FLV2272-29L00		\$4,064	\$4,468
	22	60	29	199	27	FLT2260-29L00	\$2,989		
	22	60	29	199	27	FLV2260-29L00		\$3,877	\$4,267

Features:

- eased edge profile user side
- each open compartment has one adjustable shelf
- shelves 12 1/2"d

Options:

- must specify chassis grain direction on artisan veneer, see pages 13-15 for details
- contrasting laminate worksurface tops, no upcharge; specify laminate color, see page 16 for details
- oval grommets in back panel can be eliminated upon request, no upcharge
- interior horizontal wire manager with end grommets available, specify and add \$199 list; see page 40 for details
- top grommet available, specify location and add \$142 list each; see page 47 for details

 Open Compartment - Flush Legs	22	36	29	136	17	FLT2236-29L0	\$2,253		
	22	36	29	136	17	FLV2236-29L0		\$2,923	\$3,213
	22	30	29	111	14	FLT2230-29L0	\$2,188		
	22	30	29	111	14	FLV2230-29L0		\$2,838	\$3,123

Features:

- eased edge profile user side
- open compartment with adjustable shelf
- shelves 12 1/2"d

Options:

- must specify chassis grain direction on artisan veneer, see pages 13-15 for details
- contrasting laminate worksurface tops, no upcharge; specify laminate color, see page 16 for details
- oval grommets in back panel can be eliminated upon request, no upcharge
- interior horizontal wire manager with end grommets available, specify and add \$199 list; see page 40 for details
- top grommet available, specify location and add \$142 list each; see page 47 for details

To Order, Specify:

① Laminate Model #	② Laminate Type	③ Laminate Selection	④ Metal Color	⑤ Other Product Options
Laminate (FLT)	HPL	See Laminate Selection	See Metal Finish Color Options	See list of options for each specific unit; Specify and add accordingly.
① Veneer Model #	② Wood Collection	③ Wood Finish	④ Metal Color	⑤ Other Product Options
Veneer (FLV)	Essentials	See Essentials Wood Finish Options	See Metal Finish Color Options	See list of options for each specific unit; Specify and add accordingly.
	Artisan	③a Wood Finish See Artisan Wood Finish Options	③b Chassis Grain Direction For Artisan Only: Vertical Horizontal	

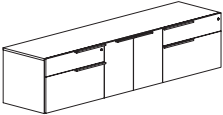
Description	D	W	H	CTN WT	CU FT	① Model	HPL Laminate	Essentials Veneer	Artisan Veneer
Storage Credenza 	22	96	21	350	32	FLT2296-21F676	\$2,973		
	22	96	21	350	32	FLV2296-21F676		\$4,152	\$4,569
	22	90	21	335	30	FLT2290-21F676	\$2,904		
	22	90	21	335	30	FLV2290-21F676		\$4,051	\$4,457
	22	84	21	311	28	FLT2284-21F676	\$2,832		
	22	84	21	311	28	FLV2284-21F676		\$3,954	\$4,350

Features:

- pedestal front locking
- hinged door compartment has one adjustable shelf

Options:

- must specify chassis grain direction on artisan veneer, see pages 13-15 for details
- concealed box drawer(s) available, specify location in unit; add \$259 list for each laminate drawer or \$394 for each veneer drawer, see page 25 for details
- locking doors available, specify and add \$153 list
- veneer door and drawer fronts in paint available, specify paint color and add \$372; see page 16 for details
- on laminate units, contrasting door and drawer fronts available, no upcharge; specify color, see page 16 for details
- ledge pulls standard; prism pulls available, specify and see page 9
- oval grommets in back panel can be eliminated upon request, no upcharge
- oval or rectangular seat cushion available, see page 25 for more details and page 212 for pricing
- interior horizontal wire manager with end grommets available, specify and add \$199 list; see page 40 for details
- top grommet available, specify location; add \$142 list each; see page 46 for details
- worksurface power available, specify "to accommodate EC26" on your purchase order; EC26 unit must be ordered separately, see page 46

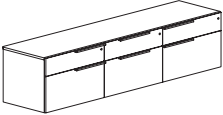
Box/Lateral File Credenza 	22	90	21	371	30	FLT2290-21F666	\$3,369		
	22	90	21	371	30	FLV2290-21F666		\$4,704	\$5,175

Features:

- pedestal front locking

Options:

- must specify chassis grain direction on artisan veneer, see pages 13-15 for details
- concealed box drawer(s) available, specify location in unit; add \$259 list for each laminate drawer or \$394 for each veneer drawer, see page 25 for details
- veneer drawer fronts in paint available, specify paint color and add \$372 list; see page 16 for details
- on laminate units, contrasting fronts available, no upcharge; specify color, see page 16 for details
- ledge pulls standard; prism pulls available, specify and see page 9
- oval grommets in back panel can be eliminated upon request, no upcharge
- oval or rectangular seat cushion available, see page 25 for more details and page 212 for pricing
- interior horizontal wire manager with end grommets available, specify and add \$199 list; see page 40 for details
- top grommet available, specify location; add \$142 list each; see page 46 for details

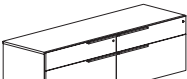
Box/Lateral File Credenza 	22	72	21	289	24	FLT2272-21F66	\$2,508		
	22	72	21	289	24	FLV2272-21F66		\$3,500	\$3,851
	22	60	21	251	20	FLT2260-21F66	\$2,408		
	22	60	21	251	20	FLV2260-21F66		\$3,363	\$3,698

Features:

- pedestal front locking

Options:

- must specify chassis grain direction on artisan veneer, see pages 13-15 for details
- concealed box drawer(s) available, specify location in unit; add \$259 list for each laminate drawer or \$394 for each veneer drawer, see page 25 for details
- veneer drawer fronts in paint available, specify paint color and add \$372 list; see page 16 for details
- on laminate units, contrasting fronts available, no upcharge; specify color, see page 16 for details
- ledge pulls standard; prism pulls available, specify and see page 9
- oval grommets in back panel can be eliminated upon request, no upcharge
- oval or rectangular seat cushion available, see page 25 for more details and page 212 for pricing
- interior horizontal wire manager with end grommets available, specify and add \$199 list; see page 40 for details
- top grommet available, specify location; add \$142 list each; see page 46 for details

Description	D	W	H	CTN WT	CU FT	① Model	HPL Laminate	Essentials Veneer	Artisan Veneer
 Box/Lateral File Pedestal	22	36	21	146	13	FLT2236-21F6	\$1,459		
	22	36	21	146	13	FLV2236-21F6		\$2,035	\$2,239
	22	30	21	126	11	FLT2230-21F6	\$1,424		
	22	30	21	126	11	FLV2230-21F6		\$1,984	\$2,186

Features:

- pedestal front locking

Options:

- must specify chassis grain direction on artisan veneer, see pages 13-15 for details
- concealed box drawer available, specify; add \$259 list for each laminate drawer or \$394 for each veneer drawer, see page 25 for details
- veneer drawer fronts in paint available, specify paint color and add \$372 list; see page 16 for details
- on laminate units, contrasting fronts available, no upcharge; specify color, see page 16 for details
- ledge pulls standard; prism pulls available, specify and see page 9
- oval grommet in back panel can be eliminated upon request, no upcharge
- oval or rectangular seat cushion available, see page 25 for more details and page 212 for pricing
- interior horizontal wire manager with end grommets available, specify and add \$199 list; see page 40 for details
- top grommet available, specify location; add \$142 list each; see page 46 for details

FLUX

To Order, Specify:

① Laminate Model #	② Laminate Type	③ Laminate Selection	④ Metal Color	⑤ Other Product Options		
Laminate (FLT)	HPL	See Laminate Selection	See Metal Finish Color Options	See list of options for each specific unit; Specify and add accordingly.		
① Veneer Model #	② Wood Collection	③ Wood Finish	④ Metal Color	⑤ Other Product Options		
Veneer (FLV)	Essentials	See Essentials Wood Finish Options	See Metal Finish Color Options	See list of options for each specific unit; Specify and add accordingly.		
	Artisan	<table border="1"> <thead> <tr> <th>ⓐ Wood Finish</th> <th>ⓑ Chassis Grain Direction</th> </tr> </thead> <tbody> <tr> <td>See Artisan Wood Finish Options</td> <td>For Artisan Only: Vertical Horizontal</td> </tr> </tbody> </table>	ⓐ Wood Finish		ⓑ Chassis Grain Direction	See Artisan Wood Finish Options
ⓐ Wood Finish	ⓑ Chassis Grain Direction					
See Artisan Wood Finish Options	For Artisan Only: Vertical Horizontal					

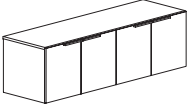

Description	D	W	H	CTN WT	CU FT	① Model	HPL Laminate	Essentials Veneer	Artisan Veneer
	22	78	21	254	26	FLT2278-21F77	\$2,067		
	22	78	21	254	26	FLV2278-21F77		\$3,038	\$3,338
	22	72	21	238	24	FLT2272-21F77	\$2,016		
	22	72	21	238	24	FLV2272-21F77		\$2,964	\$3,259
	22	66	21	220	22	FLT2266-21F77	\$1,936		
	22	66	21	220	22	FLV2266-21F77		\$2,844	\$3,128
	22	60	21	205	20	FLT2260-21F77	\$1,860		
	22	60	21	205	20	FLV2260-21F77		\$2,732	\$3,003

Features:

- each hinged door compartment has one adjustable shelf

Options:

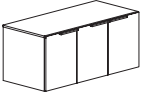
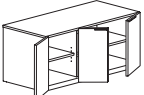
- must specify chassis grain direction on artisan veneer, see pages 13-15 for details
- locking doors available, specify and add \$306 list
- veneer door fronts in paint available, specify paint color and add \$372 list; see page 16 for details
- on laminate units, contrasting laminate door fronts available, no upcharge; specify laminate color, see page 16 for details
- ledge pulls standard; prism pulls available, specify and see page 9
- oval grommets in back panel can be eliminated upon request, no upcharge
- oval or rectangular seat cushion available, see page 25 for more details and page 212 for pricing
- interior horizontal wire manager with end grommets available, specify and add \$199 list; see page 40 for details
- top grommet available, specify location; add \$142 list each; see page 45 for details
- worksurface power available, specify "to accommodate EC26" on your purchase order; EC26 unit must be ordered separately, see page 46

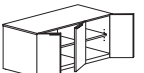
Description	D	W	H	CTN WT	CU FT	① Model	HPL Laminate	Essentials Veneer	Artisan Veneer
  left shown   right	22	54	21	188	18	FLT2254-21F77R	\$1,692		
	22	54	21	188	18	FLV2254-21F77R		\$2,486	\$2,735
	22	54	21	185	18	FLT2254-21F77L	\$1,692		
	22	54	21	185	18	FLV2254-21F77L		\$2,486	\$2,735
	22	48	21	169	16	FLT2248-21F77R	\$1,606		
	22	48	21	169	16	FLV2248-21F77R		\$2,364	\$2,598
	22	48	21	163	16	FLT2248-21F77L	\$1,606		
	22	48	21	163	16	FLV2248-21F77L		\$2,364	\$2,598
	22	42	21	153	15	FLT2242-21F77R	\$1,526		
	22	42	21	153	15	FLV2242-21F77R		\$2,244	\$2,468
	22	42	21	150	15	FLT2242-21F77L	\$1,526		
	22	42	21	150	15	FLV2242-21F77L		\$2,244	\$2,468

Features:

- each hinged door compartment has one adjustable shelf

Options:

- must specify chassis grain direction on artisan veneer, see pages 13-15 for details
- locking doors available, specify and add \$306 list
- veneer door fronts in paint available, specify paint color and add \$372 list; see page 16 for details
- on laminate units, contrasting laminate door fronts available, no upcharge; specify laminate color, see page 16 for details
- ledge pulls standard; prism pulls available, specify and see page 9
- oval grommet in back panel can be eliminated upon request, no upcharge
- oval or rectangular seat cushion available, see page 25 for more details and page 212 for pricing
- interior horizontal wire manager with end grommets available, specify and add \$199 list; see page 40 for details
- top grommet available, specify location; add \$142 list each; see page 45 for details
- worksurface power available, specify "to accommodate EC26" on your purchase order; EC26 unit must be ordered separately, see page 46

FLUX

Description	D	W	H	CTN WT	CU FT	① Model	HPL Laminate	Essentials Veneer	Artisan Veneer
Two Door Storage 	22	36	21	127	13	FLT2236-21F7	\$1,088		
	22	36	21	127	13	FLV2236-21F7		\$1,595	\$1,755
	22	30	21	109	11	FLT2230-21F7	\$1,044		
	22	30	21	109	11	FLV2230-21F7		\$1,529	\$1,685

Features:

- compartment has one adjustable shelf

Options:

- must specify chassis grain direction on artisan veneer, see pages 13-15 for details
- locking doors available, specify and add \$153 list
- veneer door fronts in paint available, specify paint color and add \$372 list; see page 16 for details
- on laminate units, contrasting laminate door fronts available, no upcharge; specify laminate color, see page 16 for details
- ledge pulls standard; prism pulls available, specify and see page 9
- oval grommets in back panel can be eliminated upon request, no upcharge
- oval or rectangular seat cushion available, see page 25 for more details and page 212 for pricing
- interior horizontal wire manager with end grommets available, specify and add \$199 list; see page 40 for details
- top grommet available, specify location; add \$142 list each; see page 45 for details
- worksurface power available, specify "to accommodate EC26" on your purchase order; EC26 unit must be ordered separately, see page 46

FLUX

To Order, Specify:

① Laminate Model #	② Laminate Type	③ Laminate Selection	④ Metal Color	⑤ Other Product Options	
Laminate (FLT)	HPL	See Laminate Selection	See Metal Finish Color Options	See list of options for each specific unit; Specify and add accordingly.	
① Veneer Model #	② Wood Collection	③ Wood Finish	④ Metal Color	⑤ Other Product Options	
Veneer (FLV)	Essentials	See Essentials Wood Finish Options	See Metal Finish Color Options	See list of options for each specific unit; Specify and add accordingly.	
	Artisan	<table border="1"> <thead> <tr> <th>ⓐ Wood Finish</th> <th>ⓑ Chassis Grain Direction</th> </tr> </thead> <tbody> <tr> <td>See Artisan Wood Finish Options</td> <td>For Artisan Only: Vertical Horizontal</td> </tr> </tbody> </table>			ⓐ Wood Finish
ⓐ Wood Finish	ⓑ Chassis Grain Direction				
See Artisan Wood Finish Options	For Artisan Only: Vertical Horizontal				

Description	D	W	H	CTN WT	CU FT	① Model	HPL Laminate	Essentials Veneer	Artisan Veneer
Box/Lateral File with Open Storage Credenza	22	96	21	327	32	FLT2296-21F606	\$3,127		
	22	96	21	327	32	FLV2296-21F606		\$4,365	\$4,802
	22	90	21	323	30	FLT2290-21F606	\$3,038		
	22	90	21	323	30	FLV2290-21F606		\$4,239	\$4,662

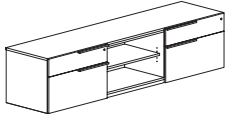

Features:

- pedestal front locking
- compartment has one adjustable shelf
- shelves 12 1/2" d

Options:

- must specify chassis grain direction on artisan veneer, see pages 13-15 for details
- peninsula desk mounting must be specified when ordering secondary credenza; see page 17 for details
- concealed box drawer(s) available, specify location in unit; add \$259 list for each laminate drawer or \$394 for each veneer drawer, see page 25 for details
- veneer drawer fronts in paint available, specify paint color and add \$372 list; see page 16 for details
- on laminate units, contrasting fronts available, no upcharge; specify color, see page 16 for details
- ledge pulls standard; prism pulls available, specify and see page 9
- oval grommets in back panel can be eliminated upon request, no upcharge
- oval or rectangular seat cushion available, see page 25 for more details and page 212 for pricing
- interior horizontal wire manager with end grommets available, specify and add \$199 list; see page 40 for details
- top grommet available, specify location; add \$142 list each; see page 46 for details
- worksurface power available, specify "to accommodate EC26" on your purchase order; EC26 unit must be ordered separately, see page 46

Description	D	W	H	CTN WT	CU FT	① Model	HPL Laminate	Essentials Veneer	Artisan Veneer
Box/Lateral File with Open Storage Credenza	22	96	21	291	32	FLT2296-21F060	\$2,905		
	22	96	21	291	32	FLV2296-21F060		\$4,055	\$4,459
	22	90	21	288	30	FLT2290-21F060	\$2,822		
	22	90	21	288	30	FLV2290-21F060		\$3,936	\$4,329

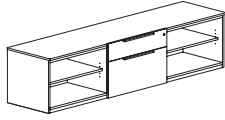

Features:

- pedestal front locking
- each open compartment has one adjustable shelf
- shelves 12 1/2" d

Options:

- must specify chassis grain direction on artisan veneer, see pages 13-15 for details
- peninsula desk mounting must be specified when ordering secondary credenza; see page 17 for details
- concealed box drawer available, specify; add \$259 list for each laminate drawer or \$394 for each veneer drawer, see page 25 for details
- veneer drawer fronts in paint available, specify paint color and add \$372 list; see page 16 for details
- on laminate units, contrasting fronts available, no upcharge; specify color, see page 16 for details
- ledge pulls standard; prism pulls available, specify and see page 9
- oval grommets in back panel can be eliminated upon request, no upcharge
- oval or rectangular seat cushion available, see page 25 for more details and page 212 for pricing
- interior horizontal wire manager with end grommets available, specify and add \$199 list; see page 40 for details
- top grommet available, specify location; add \$142 list each; see page 46 for details
- worksurface power available, specify "to accommodate EC26" on your purchase order; EC26 unit must be ordered separately, see page 46

FLUX

To Order, Specify:

① Laminate Model #	② Laminate Type	③ Laminate Selection	④ Metal Color	⑤ Other Product Options	
Laminate (FLT)	HPL	See Laminate Selection	See Metal Finish Color Options	See list of options for each specific unit; Specify and add accordingly.	
① Veneer Model #	② Wood Collection	③ Wood Finish	④ Metal Color	⑤ Other Product Options	
Veneer (FLV)	Essentials	See Essentials Wood Finish Options	See Metal Finish Color Options	See list of options for each specific unit; Specify and add accordingly.	
	Artisan	<table border="1"> <tr> <th>③a Wood Finish</th> <th>③b Chassis Grain Direction</th> </tr> <tr> <td>See Artisan Wood Finish Options</td> <td>For Artisan Only: Vertical Horizontal</td> </tr> </table>			③a Wood Finish
③a Wood Finish	③b Chassis Grain Direction				
See Artisan Wood Finish Options	For Artisan Only: Vertical Horizontal				

Description	D	W	H	CTN WT	CU FT	① Model	HPL Laminate	Essentials Veneer	Artisan Veneer
Box/Lateral File with Open Storage Credenza	22	96	21	364	32	FLT2296-21F066	\$3,127		
	22	96	21	364	32	FLV2296-21F066		\$4,365	\$4,802
	22	96	21	332	32	FLT2296-21F660	\$3,127		
	22	96	21	332	32	FLV2296-21F660		\$4,365	\$4,802
	22	90	21	320	30	FLT2290-21F066	\$3,038		
	22	90	21	320	30	FLV2290-21F066		\$4,239	\$4,662
	22	90	21	320	30	FLT2290-21F660	\$3,038		
	22	90	21	320	30	FLV2290-21F660		\$4,239	\$4,662

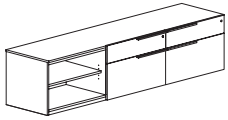

*066 shown



*660

Features:

- pedestal front locking
- compartment has one adjustable shelf
- shelf 12 1/2"d

Options:

- must specify chassis grain direction on artisan veneer, see pages 13-15 for details
- peninsula desk mounting must be specified when ordering secondary credenza; see page 17 for details
- concealed box drawer(s) available, specify location in unit; add \$259 list for each laminate drawer or \$394 for each veneer drawer, see page 25 for details
- veneer drawer fronts in paint available, specify paint color and add \$372 list; see page 16 for details
- on laminate units, contrasting fronts available, no upcharge; specify color, see page 16 for details
- ledge pulls standard; prism pulls available, specify and see page 9
- oval grommets in back panel can be eliminated upon request, no upcharge
- oval or rectangular seat cushion available, see page 25 for more details and page 212 for pricing
- interior horizontal wire manager with end grommets available, specify and add \$199 list; see page 40 for details
- top grommet available, specify location; add \$142 list each; see page 47 for details
- worksurface power available, specify "to accommodate EC26" on your purchase order; EC26 unit must be ordered separately, see page 47

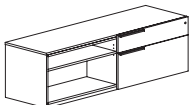
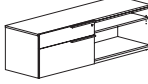
Description	D	W	H	CTN WT	CU FT	① Model	HPL Laminate	Essentials Veneer	Artisan Veneer
Box/Lateral File with Open Storage Credenza  *06 shown  *60	22	72	21	232	24	FLT2272-21F06	\$2,485		
	22	72	21	232	24	FLV2272-21F06		\$3,329	\$3,665
	22	72	21	232	24	FLT2272-21F60	\$2,485		
	22	72	21	232	24	FLV2272-21F60		\$3,329	\$3,665
	22	66	21	214	22	FLT2266-21F06	\$2,413		
	22	66	21	214	22	FLV2266-21F06		\$3,234	\$3,557
	22	66	21	214	22	FLT2266-21F60	\$2,413		
	22	66	21	214	22	FLV2266-21F60		\$3,234	\$3,557
	22	60	21	203	20	FLT2260-21F06	\$2,344		
	22	60	21	203	20	FLV2260-21F06		\$3,137	\$3,452
	22	60	21	203	20	FLT2260-21F60	\$2,344		
	22	60	21	203	20	FLV2260-21F60		\$3,137	\$3,452

Features:

- pedestal front locking
- compartment has one adjustable shelf
- shelf 12 1/2" d

Options:

- must specify chassis grain direction on artisan veneer, see pages 13-15 for details
- peninsula desk mounting must be specified when ordering secondary credenza; see page 17 for details
- concealed box drawer available, specify; add \$259 list for each laminate drawer or \$394 for each veneer drawer, see page 25 for details
- veneer drawer fronts in paint available, specify paint color and add \$372 list; see page 16 for details
- on laminate units, contrasting fronts available, no upcharge; specify color, see page 16 for details
- ledge pulls standard; prism pulls available, specify and see page 9
- oval grommets in back panel can be eliminated upon request, no upcharge
- oval or rectangular seat cushion available, see page 25 for more details and page 212 for pricing
- interior horizontal wire manager with end grommets available, specify and add \$199 list; see page 40 for details
- top grommet available, specify location; add \$142 list each; see page 47 for details
- worksurface power available, specify "to accommodate EC26" on your purchase order; EC26 unit must be ordered separately, see page 47

To Order, Specify:

① Laminate Model #	② Laminate Type	③ Laminate Selection	④ Metal Color	⑤ Other Product Options		
Laminate (FLT)	HPL	See Laminate Selection	See Metal Finish Color Options	See list of options for each specific unit; Specify and add accordingly.		
① Veneer Model #	② Wood Collection	③ Wood Finish	④ Metal Color	⑤ Other Product Options		
Veneer (FLV)	Essentials	See Essentials Wood Finish Options	See Metal Finish Color Options	See list of options for each specific unit; Specify and add accordingly.		
	Artisan	<table border="1"> <tr> <th>ⓐ Wood Finish</th> <th>ⓑ Chassis Grain Direction</th> </tr> <tr> <td>See Artisan Wood Finish Options</td> <td>For Artisan Only: Vertical Horizontal</td> </tr> </table>	ⓐ Wood Finish		ⓑ Chassis Grain Direction	See Artisan Wood Finish Options
ⓐ Wood Finish	ⓑ Chassis Grain Direction					
See Artisan Wood Finish Options	For Artisan Only: Vertical Horizontal					

FLUX

Description	D	W	H	CTN WT	CU FT	① Model	HPL Laminate	Essentials Veneer	Artisan Veneer
Double Sliding Door Credenza	22	90	21	291	30	FLT2290-21F909	\$2,606		
	22	90	21	291	30	FLV2290-21F909		\$3,635	\$4,000

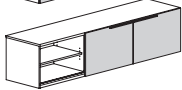
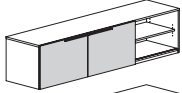
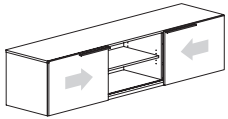

Features:

- locking doors not available
- each compartment has one adjustable shelf
- shelves 12 1/2"d

Options:

- must specify chassis grain direction on artisan veneer, see pages 13-15 for details
- peninsula desk mounting must be specified when ordering secondary credenza; see page 17 for details
- veneer door fronts in paint available, specify paint color and add \$372 list; see page 16 for details
- on laminate units, contrasting laminate door fronts available, no upcharge; specify laminate color, see page 16 for details
- ledge pulls standard; prism pulls available, specify and see page 9
- oval grommets in back panel can be eliminated upon request, no upcharge
- oval or rectangular seat cushion available, see page 25 for more details and page 212 for pricing
- interior horizontal wire manager with end grommets available, specify and add \$199 list; see page 40 for details
- top grommet available, specify location; add \$142 list each; see page 47 for details
- worksurface power available, specify "to accommodate EC26" on your purchase order; EC26 unit must be ordered separately, see page 47

Sliding Door Credenza	22	90	21	274	30	FLT2290-21F090	\$2,480		
	22	90	21	274	30	FLV2290-21F090		\$3,461	\$3,810

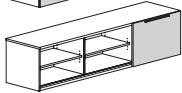
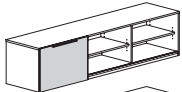
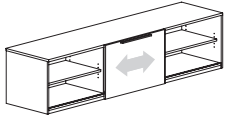

Features:

- locking doors not available
- each compartment has one adjustable shelf
- shelves 12 1/2"d

Options:

- must specify chassis grain direction on artisan veneer, see pages 13-15 for details
- peninsula desk mounting must be specified when ordering secondary credenza; see page 17 for details
- veneer door fronts in paint available, specify paint color and add \$372 list; see page 16 for details
- on laminate units, contrasting laminate door fronts available, no upcharge; specify laminate color, see page 16 for details
- ledge pulls standard; prism pulls available, specify and see page 9
- oval grommets in back panel can be eliminated upon request, no upcharge
- oval or rectangular seat cushion available, see page 25 for more details and page 212 for pricing
- interior horizontal wire manager with end grommets available, specify and add \$199 list; see page 40 for details
- top grommet available, specify location; add \$142 list each; see page 47 for details
- worksurface power available, specify "to accommodate EC26" on your purchase order; EC26 unit must be ordered separately, see page 47

FLUX

Description	D	W	H	CTN WT	CU FT	① Model	HPL Laminate	Essentials Veneer	Artisan Veneer
Sliding Door Credenza	22	72	21	211	24	FLT2272-21F09	\$2,261		
	22	72	21	211	24	FLV2272-21F09		\$3,158	\$3,474
	22	60	21	185	20	FLT2260-21F09	\$2,133		
	22	60	21	185	20	FLV2260-21F09		\$2,976	\$3,276

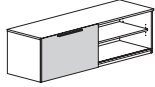
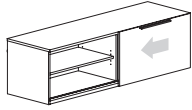

Features:

- locking doors not available
- each compartment has one adjustable shelf
- shelves 12 1/2"d

Options:

- must specify chassis grain direction on artisan veneer, see pages 13-15 for details
- peninsula desk mounting must be specified when ordering secondary credenza; see page 17 for details
- veneer door fronts in paint available, specify paint color and add \$372 list; see page 16 for details
- on laminate units, contrasting laminate door fronts available, no upcharge; specify laminate color, see page 16 for details
- ledge pulls standard; prism pulls available, specify and see page 9
- oval grommets in back panel can be eliminated upon request, no upcharge
- oval or rectangular seat cushion available, see page 25 for more details and page 212 for pricing
- interior horizontal wire manager with end grommets available, specify and add \$199 list; see page 40 for details
- top grommet available, specify location; add \$142 list each; see page 47 for details
- worksurface power available, specify "to accommodate EC26" on your purchase order; EC26 unit must be ordered separately, see page 47

FLUX

To Order, Specify:

① Laminate Model #	② Laminate Type	③ Laminate Selection	④ Metal Color	⑤ Other Product Options	
Laminate (FLT)	HPL	See Laminate Selection	See Metal Finish Color Options	See list of options for each specific unit; Specify and add accordingly.	
① Veneer Model #	② Wood Collection	③ Wood Finish	④ Metal Color	⑤ Other Product Options	
Veneer (FLV)	Essentials	See Essentials Wood Finish Options	See Metal Finish Color Options	See list of options for each specific unit; Specify and add accordingly.	
	Artisan	<table border="1"> <thead> <tr> <th>ⓐ Wood Finish</th> <th>ⓑ Chassis Grain Direction</th> </tr> </thead> <tbody> <tr> <td>See Artisan Wood Finish Options</td> <td>For Artisan Only: Vertical Horizontal</td> </tr> </tbody> </table>			ⓐ Wood Finish
ⓐ Wood Finish	ⓑ Chassis Grain Direction				
See Artisan Wood Finish Options	For Artisan Only: Vertical Horizontal				

Description	D	W	H	CTN WT	CU FT	① Model	HPL Laminate	Essentials Veneer	Artisan Veneer
Open Compartment Storage Credenza	22	90	21	246	30	FLT2290-21F000	\$2,153		
	22	90	21	246	30	FLV2290-21F000		\$3,003	\$3,305

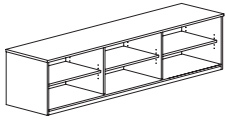

Features:

- square edge on top
- each open compartment has one adjustable shelf
- shelves 12 1/2"d

Options:

- must specify chassis grain direction on artisan veneer, see pages 13-15 for details
- peninsula desk mounting must be specified when ordering secondary credenza; see page 17 for details
- oval or rectangular seat cushion available, see page 25 for more details and page 212 for pricing
- oval grommets in back panel can be eliminated upon request, no upcharge
- interior horizontal wire manager with end grommets available, specify and add \$199 list; see page 40 for details
- top grommet available, specify location and add \$142 list each; see page 46 for details
- worksurface power available, specify "to accommodate EC26" on your purchase order; EC26 unit must be ordered separately, see page 46

Open Compartment Storage Credenza	22	72	21	193	24	FLT2272-21F00	\$1,962		
	22	72	21	193	24	FLV2272-21F00		\$2,740	\$3,014
	22	60	21	169	20	FLT2260-21F00	\$1,837		
	22	60	21	169	20	FLV2260-21F00		\$2,585	\$2,840

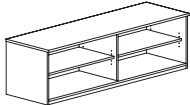

Features:

- square edge on top
- each open compartment has one adjustable shelf
- shelves 12 1/2"d

Options:

- must specify chassis grain direction on artisan veneer, see pages 13-15 for details
- peninsula desk mounting must be specified when ordering secondary credenza; see page 17 for details
- oval or rectangular seat cushion available, see page 25 for more details and page 212 for pricing
- oval grommets in back panel can be eliminated upon request, no upcharge
- interior horizontal wire manager with end grommets available, specify and add \$199 list; see page 40 for details
- top grommet available, specify location and add \$142 list each; see page 46 for details
- worksurface power available, specify "to accommodate EC26" on your purchase order; EC26 unit must be ordered separately, see page 46

FLUX

Description	D	W	H	CTN WT	CU FT	① Model	HPL Laminate	Essentials Veneer	Artisan Veneer
Open Storage with Side Power Access	22	36	21	118	13	FLT2236-21FE0	\$1,767		
	22	36	21	118	13	FLV2236-21FE0		\$2,291	\$2,520
	22	36	21	124	13	FLT2236-21FOE	\$1,767		
	22	36	21	124	13	FLV2236-21FOE		\$2,291	\$2,520
	22	30	21	101	11	FLT2230-21FE0	\$1,714		
	22	30	21	101	11	FLV2230-21FE0		\$2,223	\$2,446
	22	30	21	107	11	FLT2230-21FOE	\$1,714		
	22	30	21	107	11	FLV2230-21FOE		\$2,223	\$2,446



*OE shown

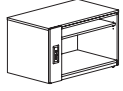

*EO

Features:

- square edge on top
- electrical power unit - EC26 included, specify color
- open compartment with adjustable shelf
- shelf 12 1/2" d

Options:

- must specify chassis grain direction on artisan veneer, see pages 13-15 for details
- oval or rectangular seat cushion available, see page 25 for more details and page 212 for pricing
- oval grommet in back panel can be eliminated upon request, no upcharge

FLUX

To Order, Specify:

① Laminate Model #	② Laminate Type	③ Laminate Selection	④ Metal Color	⑤ Other Product Options		
Laminate (FLT)	HPL	See Laminate Selection	See Metal Finish Color Options	See list of options for each specific unit; Specify and add accordingly.		
① Veneer Model #	② Wood Collection	③ Wood Finish	④ Metal Color	⑤ Other Product Options		
Veneer (FLV)	Essentials	See Essentials Wood Finish Options	See Metal Finish Color Options	See list of options for each specific unit; Specify and add accordingly.		
	Artisan	<table border="1"> <tr> <th>③a Wood Finish</th> <th>③b Chassis Grain Direction</th> </tr> <tr> <td>See Artisan Wood Finish Options</td> <td>For Artisan Only: Vertical Horizontal</td> </tr> </table>	③a Wood Finish		③b Chassis Grain Direction	See Artisan Wood Finish Options
③a Wood Finish	③b Chassis Grain Direction					
See Artisan Wood Finish Options	For Artisan Only: Vertical Horizontal					

Description	D	W	H	CTN WT	CU FT	① Model	HPL Laminate	Essentials Veneer	Artisan Veneer
Lateral File Pedestal Credenza - Flush Legs	22	90	21	285	30	FLT2290-21L666	\$4,158		
	22	90	21	285	30	FLV2290-21L666		\$5,401	\$5,940

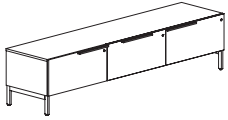

Features:

- pedestal front locking

Options:

- must specify chassis grain direction on artisan veneer, see pages 13-15 for details
- veneer drawer fronts in paint available, specify paint color and add \$372 list; see page 16 for details
- on laminate units, contrasting fronts available, no upcharge; specify color, see page 16 for details
- ledge pulls standard; prism pulls available, specify and see page 9
- oval or rectangular seat cushion available, see page 25 for more details and page 212 for pricing
- oval grommets in back panel can be eliminated upon request, no upcharge
- interior horizontal wire manager with end grommets available, specify and add \$199 list; see page 40 for details
- top grommet available, specify location and add \$142 list each; see page 46 for details

Lateral Credenza - Inset Legs	22	90	21	280	30	FLT2290-21S666	\$4,158		
	22	90	21	280	30	FLV2290-21S666		\$5,401	\$5,940

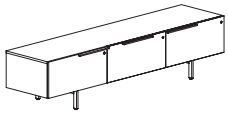

Features:

- pedestal front locking

Options:

- must specify chassis grain direction on artisan veneer, see pages 13-15 for details
- veneer drawer fronts in paint available, specify paint color and add \$372 list; see page 16 for details
- on laminate units, contrasting fronts available, no upcharge; specify color, see page 16 for details
- ledge pulls standard; prism pulls available, specify and see page 9
- oval or rectangular seat cushion available, see page 25 for more details and page 212 for pricing
- oval grommets in back panel can be eliminated upon request, no upcharge
- interior horizontal wire manager with end grommets available, specify and add \$199 list; see page 40 for details
- top grommet available, specify location and add \$142 list each; see page 46 for details

Lateral File Pedestal Credenza - Flush Legs	22	72	21	225	24	FLT2272-21L66	\$3,285		
	22	72	21	225	24	FLV2272-21L66		\$4,267	\$4,692
	22	60	21	198	20	FLT2260-21L66	\$3,100		
	22	60	21	198	20	FLV2260-21L66		\$4,024	\$4,427

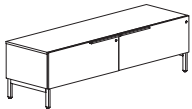

Features:

- pedestal front locking

Options:

- must specify chassis grain direction on artisan veneer, see pages 13-15 for details
- veneer drawer fronts in paint available, specify paint color and add \$372 list; see page 16 for details
- on laminate units, contrasting fronts available, no upcharge; specify color, see page 16 for details
- ledge pulls standard; prism pulls available, specify and see page 9
- oval or rectangular seat cushion available, see page 25 for more details and page 212 for pricing
- oval grommets in back panel can be eliminated upon request, no upcharge
- interior horizontal wire manager with end grommets available, specify and add \$199 list; see page 40 for details
- top grommet available, specify location and add \$142 list each; see page 46 for details

Description	D	W	H	CTN WT	CU FT	① Model	HPL Laminate	Essentials Veneer	Artisan Veneer
Lateral Credenza - Inset Legs	22	72	21	220	24	FLT2272-21S66	\$3,285		
	22	72	21	220	24	FLV2272-21S66		\$4,267	\$4,692

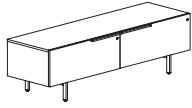

Features:

- pedestal front locking

Options:

- must specify chassis grain direction on artisan veneer, see pages 13-15 for details
- veneer drawer fronts in paint available, specify paint color and add \$372 list; see page 16 for details
- on laminate units, contrasting fronts available, no upcharge; specify color, see page 16 for details
- ledge pulls standard; prism pulls available, specify and see page 9
- oval or rectangular seat cushion available, see page 25 for more details and page 212 for pricing
- oval grommets in back panel can be eliminated upon request, no upcharge
- interior horizontal wire manager with end grommets available, specify and add \$199 list; see page 40 for details
- top grommet available, specify location and add \$142 list each; see page 46 for details

Lateral File Pedestal Credenza - Flush Legs	22	36	21	127	13	FLT2236-21L6	\$2,380		
	22	36	21	127	13	FLV2236-21L6		\$3,091	\$3,400
	22	30	21	104	11	FLT2230-21L6	\$2,312		
	22	30	21	104	11	FLV2230-21L6		\$2,998	\$3,300

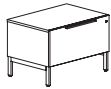

Features:

- pedestal front locking

Options:

- must specify chassis grain direction on artisan veneer, see pages 13-15 for details
- veneer drawer fronts in paint available, specify paint color and add \$372 list; see page 16 for details
- on laminate units, contrasting fronts available, no upcharge; specify color, see page 16 for details
- ledge pulls standard; prism pulls available, specify and see page 9
- oval or rectangular seat cushion available, see page 25 for more details and page 212 for pricing
- oval grommets in back panel can be eliminated upon request, no upcharge
- interior horizontal wire manager with end grommets available, specify and add \$199 list; see page 40 for details
- top grommet available, specify location and add \$135 list each; see page 46 for details

To Order, Specify:

① Laminate Model #	② Laminate Type	③ Laminate Selection	④ Metal Color	⑤ Other Product Options		
Laminate (FLT)	HPL	See Laminate Selection	See Metal Finish Color Options	See list of options for each specific unit; Specify and add accordingly.		
① Veneer Model #	② Wood Collection	③ Wood Finish	④ Metal Color	⑤ Other Product Options		
Veneer (FLV)	Essentials	See Essentials Wood Finish Options	See Metal Finish Color Options	See list of options for each specific unit; Specify and add accordingly.		
	Artisan	<table border="1"> <thead> <tr> <th>ⓐ Wood Finish</th> <th>ⓑ Chassis Grain Direction</th> </tr> </thead> <tbody> <tr> <td>See Artisan Wood Finish Options</td> <td>For Artisan Only: Vertical Horizontal</td> </tr> </tbody> </table>	ⓐ Wood Finish		ⓑ Chassis Grain Direction	See Artisan Wood Finish Options
ⓐ Wood Finish	ⓑ Chassis Grain Direction					
See Artisan Wood Finish Options	For Artisan Only: Vertical Horizontal					

FLUX

Description	D	W	H	CTN WT	CU FT	① Model	HPL Laminate	Essentials Veneer	Artisan Veneer
Lateral File and Open Storage Credenza - Flush Legs	22	96	21	250	32	FLT2296-21L606	\$3,885		
	22	96	21	250	32	FLV2296-21L606		\$5,045	\$5,548
	22	90	21	258	30	FLT2290-21L606	\$3,770		
	22	90	21	258	30	FLV2290-21L606		\$4,898	\$5,387

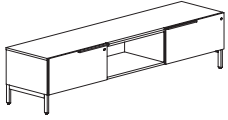

Features:

- pedestal front locking

Options:

- must specify chassis grain direction on artisan veneer, see pages 13-15 for details
- peninsula desk mounting must be specified when ordering secondary credenza; see page 17 for details
- veneer drawer fronts in paint available, specify paint color and add \$372 list; see page 16 for details
- on laminate units, contrasting fronts available, no upcharge; specify color, see page 16 for details
- ledge pulls standard; prism pulls available, specify and see page 9
- oval or rectangular seat cushion available, see page 25 for more details and page 212 for pricing
- oval grommets in back panel can be eliminated upon request, no upcharge
- interior horizontal wire manager with end grommets available, specify and add \$199 list; see page 40 for details
- top grommet available, specify location; add \$142 list each; see page 46 for details
- worksurface power available, specify "to accommodate EC26" on your purchase order; EC26 unit must be ordered separately, see page 46

Lateral File and Open Storage Credenza - Inset Legs	22	90	21	247	30	FLT2290-21S606	\$3,885		
	22	90	21	247	30	FLV2290-21S606		\$5,045	\$5,548

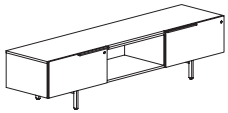

Features:

- pedestal front locking

Options:

- must specify chassis grain direction on artisan veneer, see pages 13-15 for details
- peninsula desk mounting must be specified when ordering secondary credenza; see page 17 for details
- veneer drawer fronts in paint available, specify paint color and add \$372 list; see page 16 for details
- on laminate units, contrasting fronts available, no upcharge; specify color, see page 16 for details
- ledge pulls standard; prism pulls available, specify and see page 9
- oval or rectangular seat cushion available, see page 25 for more details and page 212 for pricing
- oval grommets in back panel can be eliminated upon request, no upcharge
- interior horizontal wire manager with end grommets available, specify and add \$199 list; see page 40 for details
- top grommet available, specify location; add \$142 list each; see page 46 for details
- worksurface power available, specify "to accommodate EC26" on your purchase order; EC26 unit must be ordered separately, see page 46

FLUX

Description	D	W	H	CTN WT	CU FT	① Model	HPL Laminate	Essentials Veneer	Artisan Veneer
Lateral File and Open Storage Credenza - Flush Legs	22	96	21	232	32	FLT2296-21L060	\$3,639		
	22	96	21	232	32	FLV2296-21L060		\$4,724	\$5,194
	22	90	21	252	30	FLT2290-21L060	\$3,533		
	22	90	21	252	30	FLV2290-21L060		\$4,584	\$5,046

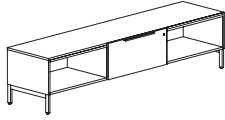

Features:

- pedestal front locking

Options:

- must specify chassis grain direction on artisan veneer, see pages 13-15 for details
- peninsula desk mounting must be specified when ordering secondary credenza; see page 17 for details
- veneer drawer fronts in paint available, specify paint color and add \$372 list; see page 16 for details
- on laminate units, contrasting fronts available, no upcharge; specify color, see page 16 for details
- ledge pulls standard; prism pulls available, specify and see page 9
- oval or rectangular seat cushion available, see page 25 for more details and page 212 for pricing
- oval grommets in back panel can be eliminated upon request, no upcharge
- interior horizontal wire manager with end grommets available, specify and add \$199 list; see page 40 for details
- top grommet available, specify location; add \$142 list each; see page 46 for details
- worksurface power available, specify "to accommodate EC26" on your purchase order; EC26 unit must be ordered separately, see page 46

Lateral File and Open Storage Credenza with Inset Legs	22	90	21	251	30	FLT2290-21S060	\$3,639		
	22	90	21	251	30	FLV2290-21S060		\$4,724	\$5,194

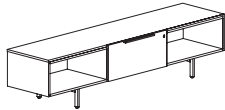

Features:

- pedestal front locking

Options:

- must specify chassis grain direction on artisan veneer, see pages 13-15 for details
- peninsula desk mounting must be specified when ordering secondary credenza; see page 17 for details
- veneer drawer fronts in paint available, specify paint color and add \$372 list; see page 16 for details
- on laminate units, contrasting fronts available, no upcharge; specify color, see page 16 for details
- ledge pulls standard; prism pulls available, specify and see page 9
- oval or rectangular seat cushion available, see page 25 for more details and page 212 for pricing
- oval grommets in back panel can be eliminated upon request, no upcharge
- interior horizontal wire manager with end grommets available, specify and add \$199 list; see page 40 for details
- top grommet available, specify location; add \$142 list each; see page 46 for details
- worksurface power available, specify "to accommodate EC26" on your purchase order; EC26 unit must be ordered separately, see page 46

To Order, Specify:

① Laminate Model #	② Laminate Type	③ Laminate Selection	④ Metal Color	⑤ Other Product Options		
Laminate (FLT)	HPL	See Laminate Selection	See Metal Finish Color Options	See list of options for each specific unit; Specify and add accordingly.		
① Veneer Model #	② Wood Collection	③ Wood Finish	④ Metal Color	⑤ Other Product Options		
Veneer (FLV)	Essentials	See Essentials Wood Finish Options	See Metal Finish Color Options	See list of options for each specific unit; Specify and add accordingly.		
	Artisan	<table border="1"> <thead> <tr> <th>ⓐ Wood Finish</th> <th>ⓑ Chassis Grain Direction</th> </tr> </thead> <tbody> <tr> <td>See Artisan Wood Finish Options</td> <td>For Artisan Only: Vertical Horizontal</td> </tr> </tbody> </table>	ⓐ Wood Finish		ⓑ Chassis Grain Direction	See Artisan Wood Finish Options
ⓐ Wood Finish	ⓑ Chassis Grain Direction					
See Artisan Wood Finish Options	For Artisan Only: Vertical Horizontal					

Description	D	W	H	CTN WT	CU FT	① Model	HPL Laminate	Essentials Veneer	Artisan Veneer
Lateral File and Open Storage Credenza - Flush Legs	22	96	21	256	32	FLT2296-21L066	\$3,885		
	22	96	21	256	32	FLV2296-21L066		\$5,045	\$5,548
	22	96	21	256	32	FLT2296-21L660	\$3,885		
	22	96	21	256	32	FLV2296-21L660		\$5,045	\$5,548
	22	90	21	256	30	FLT2290-21L066	\$3,770		
	22	90	21	256	30	FLV2290-21L066		\$4,898	\$5,387
	22	90	21	256	30	FLT2290-21L660	\$3,770		
	22	90	21	256	30	FLV2290-21L660		\$4,898	\$5,387

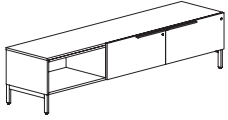

*066 shown

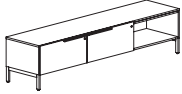

*660

Features:

- pedestal front locking

Options:

- must specify chassis grain direction on artisan veneer, see pages 13-15 for details
- peninsula desk mounting must be specified when ordering secondary credenza; see page 17 for details
- veneer drawer fronts in paint available, specify paint color and add \$372 list; see page 16 for details
- on laminate units, contrasting fronts available, no upcharge; specify color, see page 16 for details
- ledge pulls standard; prism pulls available, specify and see page 9
- oval or rectangular seat cushion available, see page 25 for more details and page 212 for pricing
- oval grommets in back panel can be eliminated upon request, no upcharge
- interior horizontal wire manager with end grommets available, specify and add \$199 list; see page 40 for details
- top grommet available, specify location; add \$142 list each; see page 47 for details
- worksurface power available, specify "to accommodate EC26" on your purchase order; EC26 unit must be ordered separately, see page 47

Description	D	W	H	CTN WT	CU FT	① Model	HPL Laminate	Essentials Veneer	Artisan Veneer
Lateral File and Open Storage	22	90	21	251	30	FLT2290-21S066	\$3,885		
Credenza with Inset Legs -	22	90	21	251	30	FLV2290-21S066		\$5,045	\$5,548
Secondary Height	22	90	21	251	30	FLT2290-21S660	\$3,885		
	22	90	21	251	30	FLV2290-21S660		\$5,045	\$5,548

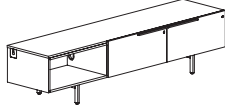

*066 shown

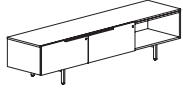

*660

Features:

- pedestal front locking

Options:

- must specify chassis grain direction on artisan veneer, see pages 13-15 for details
- peninsula desk mounting must be specified when ordering secondary credenza; see page 17 for details
- veneer drawer fronts in paint available, specify paint color and add \$372 list; see page 16 for details
- on laminate units, contrasting fronts available, no upcharge; specify color, see page 16 for details
- ledge pulls standard; prism pulls available, specify and see page 9
- oval or rectangular seat cushion available, see page 25 for more details and page 212 for pricing
- oval grommets in back panel can be eliminated upon request, no upcharge
- interior horizontal wire manager with end grommets available, specify and add \$199 list; see page 40 for details
- top grommet available, specify location; add \$142 list each; see page 47 for details
- worksurface power available, specify "to accommodate EC26" on your purchase order; EC26 unit must be ordered separately, see page 47

FLUX

To Order, Specify:

① Laminate Model #	② Laminate Type	③ Laminate Selection	④ Metal Color	⑤ Other Product Options	
Laminate (FLT)	HPL	See Laminate Selection	See Metal Finish Color Options	See list of options for each specific unit; Specify and add accordingly.	
① Veneer Model #	② Wood Collection	③ Wood Finish	④ Metal Color	⑤ Other Product Options	
Veneer (FLV)	Essentials	See Essentials Wood Finish Options	See Metal Finish Color Options	See list of options for each specific unit; Specify and add accordingly.	
	Artisan	<table border="1"> <tr> <th>ⓐ Wood Finish</th> <th>ⓑ Chassis Grain Direction</th> </tr> <tr> <td>See Artisan Wood Finish Options</td> <td>For Artisan Only: Vertical Horizontal</td> </tr> </table>			ⓐ Wood Finish
ⓐ Wood Finish	ⓑ Chassis Grain Direction				
See Artisan Wood Finish Options	For Artisan Only: Vertical Horizontal				

Description	D	W	H	CTN WT	CU FT	① Model	HPL Laminate	Essentials Veneer	Artisan Veneer
Lateral File and Open Storage Credenza - Flush Legs	22	72	21	210	24	FLT2272-21L06	\$3,032		
	22	72	21	210	24	FLV2272-21L06		\$3,936	\$4,329
	22	72	21	210	24	FLT2272-21L60	\$3,032		
	22	72	21	210	24	FLV2272-21L60		\$3,936	\$4,329
	22	66	21	186	22	FLT2266-21L06	\$2,944		
	22	66	21	186	22	FLV2266-21L06		\$3,818	\$4,200
	22	66	21	177	22	FLT2266-21L60	\$2,944		
	22	66	21	177	22	FLV2266-21L60		\$3,818	\$4,200
	22	60	21	169	20	FLT2260-21L06	\$2,854		
	22	60	21	169	20	FLV2260-21L06		\$3,701	\$4,074
	22	60	21	169	20	FLT2260-21L60	\$2,854		
	22	60	21	169	20	FLV2260-21L60		\$3,701	\$4,074

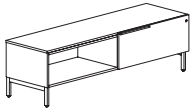

*06 shown



*60 shown

Features:

- pedestal front locking

Options:

- must specify chassis grain direction on artisan veneer, see pages 13-15 for details
- peninsula desk mounting must be specified when ordering secondary credenza; see page 17 for details
- veneer drawer fronts in paint available, specify paint color and add \$372 list; see page 16 for details
- on laminate units, contrasting fronts available, no upcharge; specify color, see page 16 for details
- ledge pulls standard; prism pulls available, specify and see page 9
- oval or rectangular seat cushion available, see page 25 for more details and page 212 for pricing
- oval grommets in back panel can be eliminated upon request, no upcharge
- interior horizontal wire manager with end grommets available, specify and add \$199 list; see page 40 for details
- top grommet available, specify location; add \$142 list each; see page 47 for details
- worksurface power available, specify "to accommodate EC26" on your purchase order; EC26 unit must be ordered separately, see page 47

Lateral File and Open Storage Credenza - Inset Legs	22	72	21	205	24	FLT2272-21S06	\$3,032		
	22	72	21	205	24	FLV2272-21S06		\$3,936	\$4,328
	22	72	21	205	24	FLT2272-21S60	\$3,032		
	22	72	21	205	24	FLV2272-21S60		\$3,936	\$4,328
	22	60	21	161	20	FLT2260-21S06	\$2,854		
	22	60	21	161	20	FLV2260-21S06		\$3,701	\$4,074
	22	60	21	161	20	FLT2260-21S60	\$2,854		
	22	60	21	161	20	FLV2260-21S60		\$3,701	\$4,074

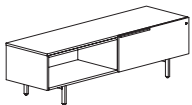

*06 shown

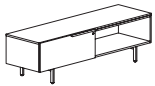

*60

Features:

- pedestal front locking

Options:

- must specify chassis grain direction on artisan veneer, see pages 13-15 for details
- peninsula desk mounting must be specified when ordering secondary credenza; see page 17 for details
- veneer drawer fronts in paint available, specify paint color and add \$372 list; see page 16 for details
- on laminate units, contrasting fronts available, no upcharge; specify color, see page 16 for details
- ledge pulls standard; prism pulls available, specify and see page 9
- oval or rectangular seat cushion available, see page 25 for more details and page 212 for pricing
- oval grommets in back panel can be eliminated upon request, no upcharge
- interior horizontal wire manager with end grommets available, specify and add \$199 list; see page 40 for details
- top grommet available, specify location; add \$142 list each; see page 47 for details
- worksurface power available, specify "to accommodate EC26" on your purchase order; EC26 unit must be ordered separately, see page 47

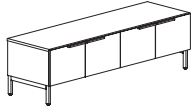
Description	D	W	H	CTN WT	CU FT	① Model	HPL Laminate	Essentials Veneer	Artisan Veneer
	22	72	21	189	24	FLT2272-21L77	\$2,562		
	22	72	21	189	24	FLV2272-21L77		\$3,326	\$3,657
	22	60	21	160	20	FLT2260-21L77	\$2,408		
	22	60	21	160	20	FLV2260-21L77		\$3,125	\$3,440

Options:

- must specify chassis grain direction on artisan veneer, see pages 13-15 for details
- locking doors available, specify and add \$306 list
- veneer door fronts in paint available, specify paint color and add \$372 list; see page 16 for details
- on laminate units, contrasting laminate door fronts available, no upcharge; specify laminate color, see page 16 for details
- ledge pulls standard; prism pulls available, specify and see page 9
- oval or rectangular seat cushion available, see page 25 for more details and page 212 for pricing
- on laminate units, contrasting laminate door fronts available, no upcharge; specify laminate color, see page 16 for details
- interior horizontal wire manager with end grommets available, specify and add \$199 list; see page 40 for details
- top grommet available, specify location; add \$142 list each; see page 46 for details
- worksurface power available, specify "to accommodate EC26" on your purchase order; EC26 unit must be ordered separately, see page 46

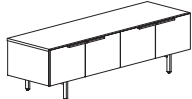
Description	D	W	H	CTN WT	CU FT	① Model	HPL Laminate	Essentials Veneer	Artisan Veneer
	22	72	21	196	20	FLT2272-21S77	\$2,562		
	22	72	21	196	20	FLV2272-21S77		\$3,326	\$3,657
	22	60	21	152	20	FLT2260-21S77	\$2,408		
	22	60	21	152	20	FLV2260-21S77		\$3,125	\$3,439

Options:

- must specify chassis grain direction on artisan veneer, see pages 13-15 for details
- locking doors available, specify and add \$306 list
- veneer door fronts in paint available, specify paint color and add \$372 list; see page 16 for details
- on laminate units, contrasting laminate door fronts available, no upcharge; specify laminate color, see page 16 for details
- ledge pulls standard; prism pulls available, specify and see page 9
- oval or rectangular seat cushion available, see page 25 for more details and page 212 for pricing
- oval grommets in back panel can be eliminated upon request, no upcharge
- interior horizontal wire manager with end grommets available, specify and add \$199 list; see page 40 for details
- top grommet available, specify location; add \$142 list each; see page 46 for details
- worksurface power available, specify "to accommodate EC26" on your purchase order; EC26 unit must be ordered separately, see page 46

To Order, Specify:

① Laminate Model #	② Laminate Type	③ Laminate Selection	④ Metal Color	⑤ Other Product Options		
Laminate (FLT)	HPL	See Laminate Selection	See Metal Finish Color Options	See list of options for each specific unit; Specify and add accordingly.		
① Veneer Model #	② Wood Collection	③ Wood Finish	④ Metal Color	⑤ Other Product Options		
Veneer (FLV)	Essentials	See Essentials Wood Finish Options	See Metal Finish Color Options	See list of options for each specific unit; Specify and add accordingly.		
	Artisan	<table border="1"> <thead> <tr> <th>③a Wood Finish</th> <th>③b Chassis Grain Direction</th> </tr> </thead> <tbody> <tr> <td>See Artisan Wood Finish Options</td> <td>For Artisan Only: Vertical Horizontal</td> </tr> </tbody> </table>	③a Wood Finish		③b Chassis Grain Direction	See Artisan Wood Finish Options
③a Wood Finish	③b Chassis Grain Direction					
See Artisan Wood Finish Options	For Artisan Only: Vertical Horizontal					

FLUX

Description	D	W	H	CTN WT	CU FT	① Model	HPL Laminate	Essentials Veneer	Artisan Veneer
Open Compartment Storage Credenza - Flush Legs	22	90	21	193	30	FLT2290-21L000	\$2,880		
	22	90	21	193	30	FLV2290-21L000		\$3,738	\$4,112

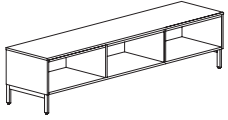

Options:

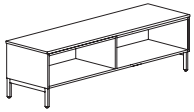

- must specify chassis grain direction on artisan veneer, see pages 13-15 for details
- peninsula desk mounting must be specified when ordering secondary credenza; see page 17 for details
- oval or rectangular seat cushion available, see page 25 for more details and page 212 for pricing
- oval grommets in back panel can be eliminated upon request, no upcharge
- top grommet available, specify location; add \$142 list each; see page 45 for details
- worksurface power available, specify "to accommodate EC26" on your purchase order; EC26 unit must be ordered separately, see page 47

Open Compartment Storage Credenza - Flush Legs	22	72	21	136	24	FLT2272-21L00	\$2,304		
	22	72	21	136	24	FLV2272-21L00		\$2,993	\$3,291
	22	60	21	136	20	FLT2260-21L00	\$2,171		
	22	60	21	136	20	FLV2260-21L00		\$2,816	\$3,097



Options:

- must specify chassis grain direction on artisan veneer, see pages 13-15 for details
- peninsula desk mounting must be specified when ordering secondary credenza; see page 17 for details
- oval or rectangular seat cushion available, see page 25 for more details and page 212 for pricing
- oval grommets in back panel can be eliminated upon request, no upcharge
- top grommet available, specify location; add \$142 list each; see page 45 for details
- worksurface power available, specify "to accommodate EC26" on your purchase order; EC26 unit must be ordered separately, see page 47

Description	D	W	H	CTN WT	CU FT	① Model	HPL Laminate	Essentials Veneer	Artisan Veneer
 *OE shown  *EO	22	36	21	100	13	FLT2236-21LE0	\$2,366		
	22	36	21	100	13	FLV2236-21LE0		\$3,069	\$3,376
	22	36	21	96	13	FLT2236-21LOE	\$2,366		
	22	36	21	96	13	FLV2236-21LOE		\$3,069	\$3,376
	22	30	21	84	11	FLT2230-21LE0	\$2,320		
	22	30	21	84	11	FLV2230-21LE0		\$3,008	\$3,311
	22	30	21	84	11	FLT2230-21LOE	\$2,320		
	22	30	21	84	11	FLV2230-21LOE		\$3,008	\$3,311

Features:

- square edge on top
- electrical power unit - EC26 included, specify color

Options:

- must specify chassis grain direction on artisan veneer, see pages 13-15 for details
- oval or rectangular seat cushion available, see page 25 for more details and page 212 for pricing
- oval grommet in back panel can be eliminated upon request, no upcharge

FLUX

To Order, Specify:

① Laminate Model #	② Laminate Type	③ Laminate Selection	④ Metal Color	⑤ Other Product Options	
Laminate (FLT)	HPL	See Laminate Selection	See Metal Finish Color Options	See list of options for each specific unit; Specify and add accordingly.	
① Veneer Model #	② Wood Collection	③ Wood Finish	④ Metal Color	⑤ Other Product Options	
Veneer (FLV)	Essentials	See Essentials Wood Finish Options	See Metal Finish Color Options	See list of options for each specific unit; Specify and add accordingly.	
	Artisan	<table border="1"> <thead> <tr> <th>③a Wood Finish</th> <th>③b Chassis Grain Direction</th> </tr> </thead> <tbody> <tr> <td>See Artisan Wood Finish Options</td> <td>For Artisan Only: Vertical Horizontal</td> </tr> </tbody> </table>			③a Wood Finish
③a Wood Finish	③b Chassis Grain Direction				
See Artisan Wood Finish Options	For Artisan Only: Vertical Horizontal				

Description	D	W	H	CTN WT	CU FT	① Model	List Price Per Grade	
Oval Cushion	20	29	1 3/4	10	2	FLB2029VCUSH	COM \$317	
 <ul style="list-style-type: none"> · use with secondary height units 30" - 36" wide · com ydg: 1 1/4 							A \$373	
								B \$385
								COL/C \$418
								D \$466
								E \$510
								F \$558
								G \$616
								H \$701
								I \$727
								J \$800
								L1 \$695
								L2 \$720

Rectangular Cushion	20	29	1 3/4	11	2	FLB2029RECUSH	COM \$317	
 <ul style="list-style-type: none"> · use with secondary height units 30" - 36" wide · com ydg: 1 1/4 							A \$373	
								B \$385
								COL/C \$418
								D \$466
								E \$510
								F \$558
								G \$616
								H \$701
								I \$727
								J \$800
								L1 \$695
								L2 \$720

FLUX

Description	D	W	H	CTN WT	CU FT	① Model	List Price Per Grade
Round Cushion	15 ¼	15 ¼	1 ¾	5	1	FLB1515RDCUSH	COM \$256
	<ul style="list-style-type: none"> · use with secondary height units · com ydg: ¾ 						A \$290
							B \$297
							COL/C \$317
							D \$346
							E \$371
							F \$401
							G \$435
							H \$488
							I \$503
							J \$548
							L1 \$482
							L2 \$498

Square Cushion	15 ¼	15 ¼	1 ¾	5	1	FLB1515SQCUSH	COM \$256
	<ul style="list-style-type: none"> · use with secondary height units · com ydg: ¾ 						A \$290
							B \$297
							COL/C \$317
							D \$346
							E \$371
							F \$401
							G \$435
							H \$488
							I \$503
							J \$548
							L1 \$482
							L2 \$498

FLUX

To Order, Specify:

① Model Number	② Fabric Selection	
(FLB)	Vendor Pattern Color	Visit www.jsifurniture.com/finishes-and-materials/textiles for our textiles program. See selection of standard and graded in manufacturers and patterns.

Description	D	W	H	CTN WT	CU FT	① Model	HPL Laminate	Essentials Veneer	Artisan Veneer
Adjustable Height Rectangular Table Desk	36	72	Adj.	340	51	FLT3672AHT	\$6,712		
	36	72	Adj.	340	51	FLV3672AHT		\$7,310	\$8,040
	32	66	Adj.	323	42	FLT3266AHT	\$6,653		
	32	66	Adj.	323	42	FLV3266AHT		\$7,245	\$7,969
	32	60	Adj.	314	39	FLT3260AHT	\$6,628		
	32	60	Adj.	314	39	FLV3260AHT		\$7,215	\$7,935

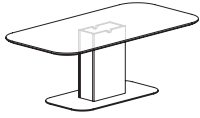

center mount

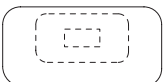
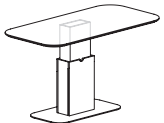

offset mount

Features:

- eased edge profile all sides
- top may be installed offset for a desk or centered for a meeting table, see page 47 for details
- removable panel provides access to power column and wiring
- powder coat steel base plate with neoprene leveling pads
- 27¾" to 45¾" height adjustment with digital controller, wire guide and 10' power cord
- maximum weight rating 140 lbs. (evenly distributed load)

Options:

- reverse bevel edge available on top perimeter, specify; add \$474 list for laminate or \$186 list for veneer; see page 8 for details
- top grommet available, specify location; add \$142 list each; see page 49 for details

Adjustable Height Square Table Desk	60	60	Adj.	377	70	FLT6060SAHT	\$7,163		
	60	60	Adj.	377	70	FLV6060SAHT		\$7,802	\$8,584
	54	54	Adj.	359	57	FLT5454SAHT	\$6,956		
	54	54	Adj.	359	57	FLV5454SAHT		\$7,583	\$8,342
	48	48	Adj.	314	46	FLT4848SAHT	\$6,883		
	48	48	Adj.	314	46	FLV4848SAHT		\$7,504	\$8,252

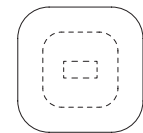
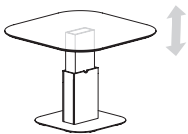
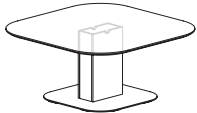

Features:

- eased edge profile all sides
- removable panel provides access to power column and wiring
- powder coat steel base plate with neoprene leveling pads
- 27¾" to 45¾" height adjustment with digital controller, wire guide and 10' power cord
- maximum weight rating 140 lbs. (evenly distributed load)

Options:

- reverse bevel edge available on top perimeter, specify; add \$474 list for laminate or \$186 list for veneer; see page 8 for details
- top grommet available, specify location; add \$142 list each; see page 49 for details

Description	D	W	H	CTN WT	CU FT	① Model	HPL Laminate	Essentials Veneer	Artisan Veneer
Adjustable Height Round Table Desk	60	60	Adj.	404	70	FLT6060RAHT	\$7,163		
	60	60	Adj.	377	70	FLV6060RAHT		\$7,802	\$8,584
	54	54	Adj.	381	57	FLT5454RAHT	\$6,956		
	54	54	Adj.	359	57	FLV5454RAHT		\$7,583	\$8,342
	48	48	Adj.	314	46	FLT4848RAHT	\$6,883		
	48	48	Adj.	301	46	FLV4848RAHT		\$7,504	\$8,252

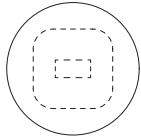
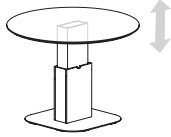
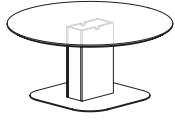

Features:

- eased edge profile all sides
- removable panel provides access to power column and wiring
- powder coat steel base plate with neoprene leveling pads
- 27¾" to 45¾" height adjustment with digital controller, wire guide and 10' power cord
- maximum weight rating 140 lbs. (evenly distributed load)

Options:

- reverse bevel edge available on top perimeter, specify; add \$474 list for laminate or \$186 list for veneer; see page 8 for details
- top grommet available, specify location; add \$142 list each; see page 49 for details

Adjustable Height Table - 120°	30	84	Adj.	233	23	FLT3084-29AH120T	\$4,097		
	30	84	Adj.	233	23	FLV3084-29AH120T		\$5,078	\$5,433
	24	84	Adj.	218	21	FLT2484-29AH120T	\$4,013		
	24	84	Adj.	218	21	FLV2484-29AH120T		\$4,976	\$5,324

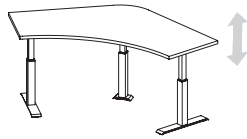
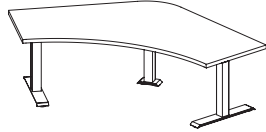

Features:

- eased edge profile on approach and user sides
- 22 ½" to 48 ½" height adjustment
- maximum weight rating 140 lbs. (evenly distributed load)
- key pad features height display with three memory settings; key pad mounts left or right
- 120" power cord

Options:

- specify Matte Black (MBK) or Arctic Silver (ASL) base finish
- top grommet available in center location, specify location; add \$142 list each
- optional EC33 unit must be ordered separately, see page 457
- undermount power available, specify and add \$1,044 list

To Order, Specify:

① Laminate Model #	② Laminate Type	③ Laminate Selection		④ Metal Color	⑤ Other Product Options
Laminate (FLT)	HPL	See Laminate Selection		See Metal Finish Color Options	See list of options for each specific unit; Specify and add accordingly.
① Veneer Model #	② Wood Collection	③ Wood Finish		④ Metal Color	⑤ Other Product Options
Veneer (FLV)	Essentials	See Essentials Wood Finish Options		See Metal Finish Color Options	See list of options for each specific unit; Specify and add accordingly.
	Artisan	ⓐ Wood Finish	ⓑ Chassis Grain Direction		
		See Artisan Wood Finish Options	For Artisan Only: Vertical Horizontal		

Description	D	W	H	CTN WT	CU FT	① Model	HPL Laminate	Essentials Veneer	Artisan Veneer
Electric Adjustable Height Table Desk 	36	72	Adj.	194	18	FLT3672AHTD-EL	\$2,697		
	36	72	Adj.	194	18	FLV3672AHTD-EL		\$3,360	\$3,553
	30	72	Adj.	175	16	FLT3072AHTD-EL	\$2,602		
	30	72	Adj.	175	16	FLV3072AHTD-EL		\$3,232	\$3,413
	30	66	Adj.	168	15	FLT3066AHTD-EL	\$2,568		
	30	66	Adj.	168	15	FLV3066AHTD-EL		\$3,196	\$3,373
	30	60	Adj.	160	14	FLT3060AHTD-EL	\$2,533		
	30	60	Adj.	160	14	FLV3060AHTD-EL		\$3,157	\$3,332
	24	72	Adj.	151	12	FLT2472AHTD-EL	\$2,510		
	24	72	Adj.	151	12	FLV2472AHTD-EL		\$3,102	\$3,276
	24	66	Adj.	146	11	FLT2466AHTD-EL	\$2,475		
	24	66	Adj.	146	11	FLV2466AHTD-EL		\$3,072	\$3,244
	24	60	Adj.	140	10	FLT2460AHTD-EL	\$2,444		
	24	60	Adj.	140	10	FLV2460AHTD-EL		\$3,042	\$3,211

Features:

- eased edge profile on approach and user sides
- 22½" to 49" height adjustment
- maximum weight rating 140 lbs. (evenly distributed load)
- key pad features height display with three memory settings; key pad mounts left or right
- display will reference position to the nearest ½"
- 120" power cord

Options:

- specify Matte Black (MBK) or Arctic Silver (ASL) base finish
- reverse bevel edge available on desk approach side only, specify; add \$474 list for laminate or \$186 list for veneer; see page 8 for details
- top grommet available, specify location and add \$142 list each; see page 49 for details
- undermount power available, specify and add \$1,044 list; power infeed sold separately, see page 224

Description	D	W	H	CTN WT	CU FT	① Model	HPL Laminate	Essentials Veneer	Artisan Veneer
Pneumatic Adjustable Height Table Desk 	36	72	Adj.	194	18	FLT3672AHTD-PN	\$4,627		
	36	72	Adj.	194	18	FLV3672AHTD-PN		\$5,474	\$6,019
	30	72	Adj.	175	16	FLT3072AHTD-PN	\$4,531		
	30	72	Adj.	175	16	FLV3072AHTD-PN		\$5,238	\$5,762
	30	66	Adj.	168	15	FLT3066AHTD-PN	\$4,437		
	30	66	Adj.	168	15	FLV3066AHTD-PN		\$5,085	\$5,594
	30	60	Adj.	160	14	FLT3060AHTD-PN	\$4,334		
	30	60	Adj.	160	14	FLV3060AHTD-PN		\$4,923	\$5,413
	24	72	Adj.	151	12	FLT2472AHTD-PN	\$4,339		
	24	72	Adj.	151	12	FLV2472AHTD-PN		\$4,903	\$5,393
	24	66	Adj.	146	11	FLT2466AHTD-PN	\$4,300		
	24	66	Adj.	146	11	FLV2466AHTD-PN		\$4,818	\$5,300
	24	60	Adj.	140	10	FLT2460AHTD-PN	\$4,242		
	24	60	Adj.	140	10	FLV2460AHTD-PN		\$4,712	\$5,184

Features:

- eased edge profile on approach and user sides
- 27½" to 44½" height adjustment
- 20 lbs. lift force, maximum weight rating 140 lbs. (evenly distributed load)
- release lever mounts under edge of top

Options:

- specify Matte Black (MBK) or Alloy (ALY) base finish
- reverse bevel edge available on desk approach side only, specify; add \$474 list for laminate or \$186 list for veneer; see page 8 for details
- top grommet available, specify location; add \$142 list each; see page 49 for details

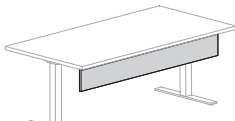
Description	D	W	H	CTN WT	CU FT	① Model	HPL Laminate	Essentials Veneer	Artisan Veneer
Modesty Panels for Adjustable Height Tables 	¾	64	9	18	3	FLT0964TDM	\$482		
	¾	64	9	18	3	FLV0964TDM		\$804	\$885
	¾	58	9	16	2	FLT0958TDM	\$471		
	¾	58	9	16	2	FLV0958TDM		\$780	\$855
	¾	52	9	14	2	FLT0952TDM	\$455		
	¾	52	9	14	2	FLV0952TDM		\$753	\$828

Features:

- FLV0964TDM or FLT0964TDM use with 72" wide adjustable height table desk
- FLV0958TDM or FLT0958TDM use with 66" wide adjustable height table desk
- FLV0952TDM or FLT0952TDM use with 60" wide adjustable height table desk

Options:

- specify modesty panel bracket finish; Black Sandtex (BSX) or Stardust Silver (STS)

FLUX

To Order, Specify:

① Laminate Model #	② Laminate Type	③ Laminate Selection	④ Metal Color	⑤ Other Product Options		
Laminate (FLT)	HPL	See Laminate Selection	See Metal Finish Color Options	See list of options for each specific unit; Specify and add accordingly.		
① Veneer Model #	② Wood Collection	③ Wood Finish	④ Metal Color	⑤ Other Product Options		
Veneer (FLV)	Essentials	See Essentials Wood Finish Options	See Metal Finish Color Options	See list of options for each specific unit; Specify and add accordingly.		
	Artisan	<table border="1"> <thead> <tr> <th>ⓐ Wood Finish</th> <th>ⓑ Chassis Grain Direction</th> </tr> </thead> <tbody> <tr> <td>See Artisan Wood Finish Options</td> <td>For Artisan Only: Vertical Horizontal</td> </tr> </tbody> </table>	ⓐ Wood Finish		ⓑ Chassis Grain Direction	See Artisan Wood Finish Options
ⓐ Wood Finish	ⓑ Chassis Grain Direction					
See Artisan Wood Finish Options	For Artisan Only: Vertical Horizontal					

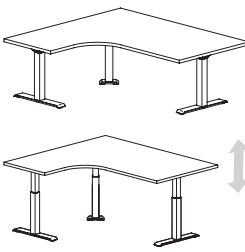
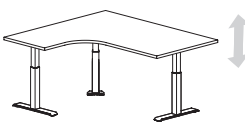
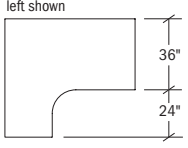
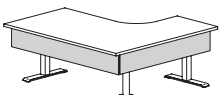
Description	D	W	H	CTN WT	CU FT	① Model	HPL Laminate	Essentials Veneer	Artisan Veneer
Adjustable Height Corner Table - 90° One Piece Top   left shown   optional modesty panels	60	72	Adj.	259	33	FLT3672CT24AHR	\$4,325		
	60	72	Adj.	259	33	FLV3672CT24AHR		\$5,362	\$5,738
	60	72	Adj.	259	33	FLT3672CT24AHL	\$4,325		
	60	72	Adj.	259	33	FLV3672CT24AHL		\$5,362	\$5,738
	60	66	Adj.	240	31	FLT3666CT24AHR	\$4,242		
	60	66	Adj.	240	31	FLV3666CT24AHR		\$5,259	\$5,628
	60	66	Adj.	240	31	FLT3666CT24AHL	\$4,242		
	60	66	Adj.	240	31	FLV3666CT24AHL		\$5,259	\$5,628
	60	60	Adj.	231	28	FLT3660CT24AHR	\$4,161		
	60	60	Adj.	231	28	FLV3660CT24AHR		\$5,158	\$5,519
	60	60	Adj.	231	28	FLT3660CT24AHL	\$4,161		
	60	60	Adj.	231	28	FLV3660CT24AHL		\$5,158	\$5,519

Features:

- eased edge profile on approach and user sides
- 22½" to 49" height adjustment
- maximum weight rating 140 lbs. (evenly distributed load)
- key pad features height display with three memory settings; key pad mounts left or right
- display will reference position to the nearest ½"
- 120" power cord

Options:

- specify Matte Black (MBK) or Arctic Silver (ASL) base finish
- reverse bevel edge available on desk approach side only, specify; add \$474 list for laminate or \$186 list for veneer; see page 8 for details
- top grommet available, specify location and add \$142 list each; see page 49 for details
- modesty panel available (2-sides) moves with worksurface, specify \$981 list for laminate or \$1,578 list for veneer; see page 21 for details
- undermount power available, specify and add \$1,014 list; power infeed sold separately, see page 224

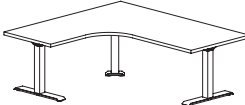
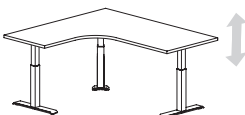
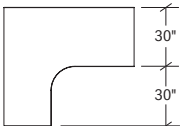
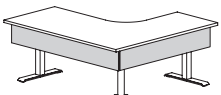
Adjustable Height Corner Table - 90° One Piece Top   left shown   optional modesty panels	60	72	Adj.	234	33	FLT3072CT30AHR	\$4,325		
	60	72	Adj.	234	33	FLV3072CT30AHR		\$5,362	\$5,738
	60	72	Adj.	234	33	FLT3072CT30AHL	\$4,325		
	60	72	Adj.	234	33	FLV3072CT30AHL		\$5,362	\$5,738
	60	66	Adj.	230	31	FLT3066CT30AHR	\$4,242		
	60	66	Adj.	230	31	FLV3066CT30AHR		\$5,259	\$5,628
	60	66	Adj.	230	31	FLT3066CT30AHL	\$4,242		
	60	66	Adj.	230	31	FLV3066CT30AHL		\$5,259	\$5,628
	60	60	Adj.	222	28	FLT3060CT30AHR	\$4,161		
	60	60	Adj.	222	28	FLV3060CT30AHR		\$5,158	\$5,519
	60	60	Adj.	222	28	FLT3060CT30AHL	\$4,161		
	60	60	Adj.	222	28	FLV3060CT30AHL		\$5,158	\$5,519

Features:

- eased edge profile on approach and user sides
- 22½" to 49" height adjustment
- maximum weight rating 140 lbs. (evenly distributed load)
- key pad features height display with three memory settings; key pad mounts left or right
- display will reference position to the nearest ½"
- 120" power cord

Options:

- specify Matte Black (MBK) or Arctic Silver (ASL) base finish
- reverse bevel edge available on desk approach side only, specify; add \$474 list for laminate or \$186 list for veneer; see page 8 for details
- top grommet available, specify location and add \$142 list each; see page 49 for details
- modesty panel available (2-sides) moves with worksurface, specify \$981 list for laminate or \$1,578 list for veneer; see page 21 for details
- undermount power available, specify and add \$1,014 list; power infeed sold separately, see page 224

Description	D	W	H	CTN WT	CU FT	① Model	HPL Laminate	Essentials Veneer	Artisan Veneer
Adjustable Height Corner Table - 90° One Piece Top	60	72	Adj.	225	33	FLT2472CT36AHR	\$4,325		
	60	72	Adj.	225	33	FLV2472CT36AHR		\$5,362	\$5,738
	60	72	Adj.	225	33	FLT2472CT36AHL	\$4,325		
	60	72	Adj.	225	33	FLV2472CT36AHL		\$5,362	\$5,738
	60	66	Adj.	220	31	FLT2466CT36AHR	\$4,242		
	60	66	Adj.	220	31	FLV2466CT36AHR		\$5,259	\$5,628
	60	66	Adj.	220	31	FLT2466CT36AHL	\$4,242		
	60	66	Adj.	220	31	FLV2466CT36AHL		\$5,259	\$5,628
	60	60	Adj.	214	28	FLT2460CT36AHR	\$4,161		
	60	60	Adj.	214	28	FLV2460CT36AHR		\$5,158	\$5,519
	60	60	Adj.	214	28	FLT2460CT36AHL	\$4,161		
	60	60	Adj.	214	28	FLV2460CT36AHL		\$5,158	\$5,519

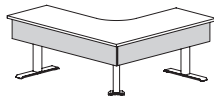
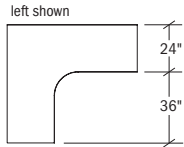
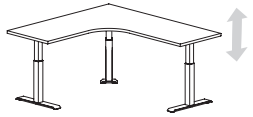
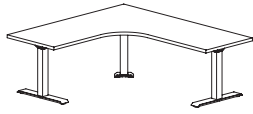

optional modesty panels

Features:

- eased edge profile on approach and user sides
- 22½" to 49" height adjustment
- maximum weight rating 140 lbs. (evenly distributed load)
- key pad features height display with three memory settings; key pad mounts left or right
- display will reference position to the nearest ½"
- 120" power cord

Options:

- specify Matte Black (MBK) or Arctic Silver (ASL) base finish
- reverse bevel edge available on desk approach side only, specify; add \$474 list for laminate or \$186 list for veneer; see page 8 for details
- top grommet available, specify location and add \$142 list each; see page 49 for details
- modesty panel available (2-sides) moves with worksurface, specify \$981 list for laminate or \$1,578 list for veneer; see page 21 for details
- undermount power available, specify and add \$946 list; power infeed sold separately, see page 224

To Order, Specify:

① Laminate Model #	② Laminate Type	③ Laminate Selection	④ Metal Color	⑤ Other Product Options		
Laminate (FLT)	HPL	See Laminate Selection	See Metal Finish Color Options	See list of options for each specific unit; Specify and add accordingly.		
① Veneer Model #	② Wood Collection	③ Wood Finish	④ Metal Color	⑤ Other Product Options		
Veneer (FLV)	Essentials	See Essentials Wood Finish Options	See Metal Finish Color Options	See list of options for each specific unit; Specify and add accordingly.		
	Artisan	<table border="1"> <tr> <th>ⓐ Wood Finish</th> <th>ⓑ Chassis Grain Direction</th> </tr> <tr> <td>See Artisan Wood Finish Options</td> <td>For Artisan Only: Vertical Horizontal</td> </tr> </table>	ⓐ Wood Finish		ⓑ Chassis Grain Direction	See Artisan Wood Finish Options
ⓐ Wood Finish	ⓑ Chassis Grain Direction					
See Artisan Wood Finish Options	For Artisan Only: Vertical Horizontal					

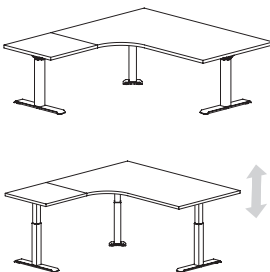
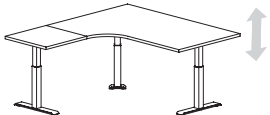
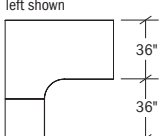
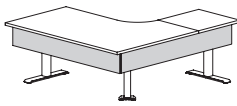
Description	D	W	H	CTN WT	CU FT	① Model	HPL Laminate	Essentials Veneer	Artisan Veneer
Adjustable Height Corner Table - 90° Two Piece Top   left shown   optional modesty panels	72	72	Adj.	255	27	FLT3672CDT36R	\$4,427		
	72	72	Adj.	255	27	FLV3672CDT36R		\$5,489	\$5,874
	72	72	Adj.	255	27	FLT3672CDT36L	\$4,427		
	72	72	Adj.	255	27	FLV3672CDT36L		\$5,489	\$5,874
	72	66	Adj.	247	25	FLT3666CDT36R	\$4,383		
	72	66	Adj.	247	25	FLV3666CDT36R		\$5,435	\$5,815
	72	66	Adj.	247	25	FLT3666CDT36L	\$4,383		
	72	66	Adj.	247	25	FLV3666CDT36L		\$5,435	\$5,815
	72	60	Adj.	237	23	FLT3660CDT36R	\$4,338		
	72	60	Adj.	237	23	FLV3660CDT36R		\$5,379	\$5,754
	72	60	Adj.	237	23	FLT3660CDT36L	\$4,338		
	72	60	Adj.	237	23	FLV3660CDT36L		\$5,379	\$5,754

Features:

- eased edge profile on approach and user sides
- 22½" to 49" height adjustment
- maximum weight rating 140 lbs. (evenly distributed load)
- key pad features height display with three memory settings; key pad mounts left or right
- display will reference position to the nearest ½"
- 120" power cord

Options:

- specify Matte Black (MBK) or Arctic Silver (ASL) base finish
- reverse bevel edge available on desk approach side only, specify; add \$474 list for laminate or \$186 list for veneer; see page 8 for details
- top grommet available, specify location and add \$142 list each; see page 49 for details
- modesty panel available (2-sides) moves with worksurface, specify \$981 list for laminate or \$1,578 list for veneer; see page 21 for details
- undermount power available, specify and add \$1,014 list; power infeed sold separately, see page 224

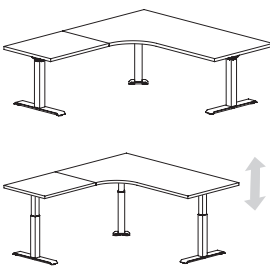
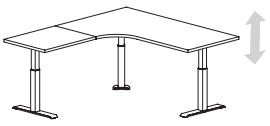
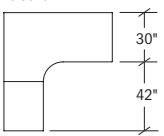
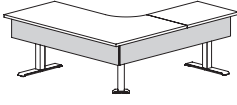
Adjustable Height Corner Table - 90° Two Piece Top   left shown   optional modesty panels	72	72	Adj.	223	24	FLT3072CDT42R	\$4,427		
	72	72	Adj.	223	24	FLV3072CDT42R		\$5,489	\$5,874
	72	72	Adj.	223	24	FLT3072CDT42L	\$4,427		
	72	72	Adj.	223	24	FLV3072CDT42L		\$5,489	\$5,874
	72	66	Adj.	213	22	FLT3066CDT42R	\$4,383		
	72	66	Adj.	213	22	FLV3066CDT42R		\$5,435	\$5,815
	72	66	Adj.	213	22	FLT3066CDT42L	\$4,383		
	72	66	Adj.	213	22	FLV3066CDT42L		\$5,435	\$5,815
	72	60	Adj.	203	21	FLT3060CDT42R	\$4,338		
	72	60	Adj.	203	21	FLV3060CDT42R		\$5,379	\$5,754
	72	60	Adj.	203	21	FLT3060CDT42L	\$4,338		
	72	60	Adj.	203	21	FLV3060CDT42L		\$5,379	\$5,754

Features:

- eased edge profile on approach and user sides
- 22½" to 49" height adjustment
- maximum weight rating 140 lbs. (evenly distributed load)
- key pad features height display with three memory settings; key pad mounts left or right
- display will reference position to the nearest ½"
- 120" power cord

Options:

- specify Matte Black (MBK) or Arctic Silver (ASL) base finish
- reverse bevel edge available on desk approach side only, specify; add \$474 list for laminate or \$186 list for veneer; see page 8 for details
- top grommet available, specify location and add \$142 list each; see page 49 for details
- modesty panel available (2-sides) moves with worksurface, specify \$981 list for laminate or \$1,578 list for veneer; see page 21 for details
- undermount power available, specify and add \$1,014 list; power infeed sold separately, see page 224

Description	D	W	H	CTN WT	CU FT	① Model	HPL Laminate	Essentials Veneer	Artisan Veneer
Adjustable Height Corner Table - 90° Two Piece Top	72	72	Adj.	232	21	FLT2472CDT48R	\$4,427		
	72	72	Adj.	232	21	FLV2472CDT48R		\$5,489	\$5,874
	72	72	Adj.	232	21	FLT2472CDT48L	\$4,427		
	72	72	Adj.	232	21	FLV2472CDT48L		\$5,489	\$5,874
	72	66	Adj.	225	20	FLT2466CDT48R	\$4,383		
	72	66	Adj.	225	20	FLV2466CDT48R		\$5,435	\$5,815
	72	66	Adj.	225	20	FLT2466CDT48L	\$4,383		
	72	66	Adj.	225	20	FLV2466CDT48L		\$5,435	\$5,815
	72	60	Adj.	219	18	FLT2460CDT48R	\$4,338		
	72	60	Adj.	219	18	FLV2460CDT48R		\$5,379	\$5,754
	72	60	Adj.	219	18	FLT2460CDT48L	\$4,338		
	72	60	Adj.	219	18	FLV2460CDT48L		\$5,379	\$5,754

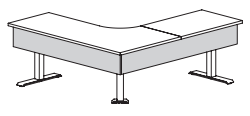
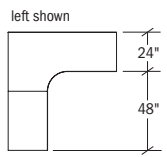
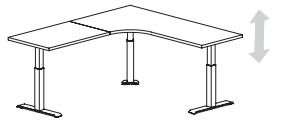
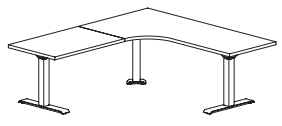

optional modesty panels

Features:

- eased edge profile on approach and user sides
- 22½" to 49" height adjustment
- maximum weight rating 140 lbs. (evenly distributed load)
- key pad features height display with three memory settings; key pad mounts left or right
- display will reference position to the nearest ½"
- 120" power cord

Options:

- specify Matte Black (MBK) or Arctic Silver (ASL) base finish
- reverse bevel edge available on desk approach side only, specify; add \$474 list for laminate or \$186 list for veneer; see page 8 for details
- top grommet available, specify location and add \$142 list each; see page 49 for details
- modesty panel available (2-sides) moves with worksurface, specify \$981 list for laminate or \$1,578 list for veneer; see page 21 for details
- undermount power available, specify and add \$1,014 list; power infeed sold separately, see page 224

To Order, Specify:

① Laminate Model #	② Laminate Type	③ Laminate Selection	④ Metal Color	⑤ Other Product Options
Laminate (FLT)	HPL	See Laminate Selection	See Metal Finish Color Options	See list of options for each specific unit; Specify and add accordingly.

① Veneer Model #	② Wood Collection	③ Wood Finish	④ Metal Color	⑤ Other Product Options		
Veneer (FLV)	Essentials	See Essentials Wood Finish Options	See Metal Finish Color Options	See list of options for each specific unit; Specify and add accordingly.		
	Artisan	<table border="1"> <thead> <tr> <th>ⓐ Wood Finish</th> <th>ⓑ Chassis Grain Direction</th> </tr> </thead> <tbody> <tr> <td>See Artisan Wood Finish Options</td> <td>For Artisan Only: Vertical Horizontal</td> </tr> </tbody> </table>	ⓐ Wood Finish		ⓑ Chassis Grain Direction	See Artisan Wood Finish Options
ⓐ Wood Finish	ⓑ Chassis Grain Direction					
See Artisan Wood Finish Options	For Artisan Only: Vertical Horizontal					

FLUX

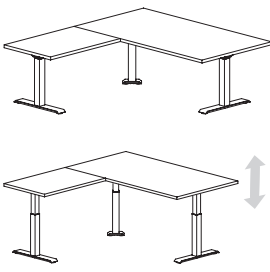
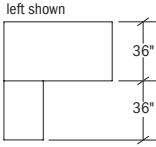
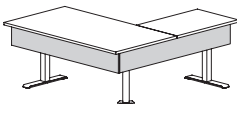
Description	D	W	H	CTN WT	CU FT	① Model	HPL Laminate	Essentials Veneer	Artisan Veneer
Adjustable Height Table & Return - 90° Two Piece Top   left shown  optional modesty panels	72	72	Adj.	253	20	FLT3672RTAH36R	\$3,566		
	72	72	Adj.	253	20	FLV3672RTAH36R		\$4,423	\$4,732
	72	72	Adj.	253	20	FLT3672RTAH36L	\$3,566		
	72	72	Adj.	253	20	FLV3672RTAH36L		\$4,423	\$4,732
	72	66	Adj.	248	19	FLT3666RTAH36R	\$3,525		
	72	66	Adj.	248	19	FLV3666RTAH36R		\$4,371	\$4,672
	72	66	Adj.	248	19	FLT3666RTAH36L	\$3,525		
	72	66	Adj.	248	19	FLV3666RTAH36L		\$4,371	\$4,672
	72	60	Adj.	239	17	FLT3660RTAH36R	\$3,484		
	72	60	Adj.	239	17	FLV3660RTAH36R		\$4,319	\$4,622
	72	60	Adj.	239	17	FLT3660RTAH36L	\$3,484		
	72	60	Adj.	239	17	FLV3660RTAH36L		\$4,319	\$4,622

Features:

- eased edge profile on approach and user sides
- 22½" to 49" height adjustment
- maximum weight rating 140 lbs. (evenly distributed load)
- key pad features height display with three memory settings; key pad mounts left or right
- display will reference position to the nearest ½"
- 120" power cord

Options:

- specify Matte Black (MBK) or Arctic Silver (ASL) base finish
- reverse bevel edge available on desk approach side only, specify; add \$474 list for laminate or \$186 list for veneer; see page 8 for details
- top grommet available, specify location and add \$142 list each; see page 49 for details
- modesty panel available (2-sides) moves with worksurface, specify \$981 list for laminate or \$1,578 list for veneer; see page 21 for details
- undermount power available, specify and add \$1,014 list; power infeed sold separately, see page 224

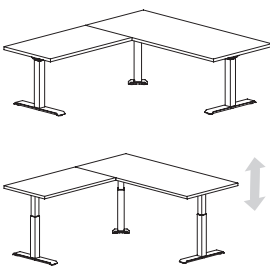
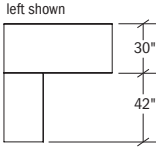
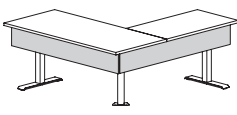
Adjustable Height Table & Return - 90° Two Piece Top   left shown  optional modesty panels	72	72	Adj.	242	18	FLT3072RTAH42R	\$3,494		
	72	72	Adj.	242	18	FLV3072RTAH42R		\$4,334	\$4,637
	72	72	Adj.	242	18	FLT3072RTAH42L	\$3,494		
	72	72	Adj.	242	18	FLV3072RTAH42L		\$4,334	\$4,637
	72	66	Adj.	233	17	FLT3066RTAH42R	\$3,455		
	72	66	Adj.	233	17	FLV3066RTAH42R		\$4,283	\$4,583
	72	66	Adj.	233	17	FLT3066RTAH42L	\$3,455		
	72	66	Adj.	233	17	FLV3066RTAH42L		\$4,283	\$4,583
	72	60	Adj.	224	16	FLT3060RTAH42R	\$3,413		
	72	60	Adj.	224	16	FLV3060RTAH42R		\$4,233	\$4,528
	72	60	Adj.	224	16	FLT3060RTAH42L	\$3,413		
	72	60	Adj.	224	16	FLV3060RTAH42L		\$4,233	\$4,525

Features:

- eased edge profile on approach and user sides
- 22½" to 49" height adjustment
- maximum weight rating 140 lbs. (evenly distributed load)
- key pad features height display with three memory settings; key pad mounts left or right
- display will reference position to the nearest ½"
- 120" power cord

Options:

- specify Matte Black (MBK) or Arctic Silver (ASL) base finish
- reverse bevel edge available on desk approach side only, specify; add \$474 list for laminate or \$186 list for veneer; see page 8 for details
- top grommet available, specify location and add \$142 list each; see page 49 for details
- modesty panel available (2-sides) moves with worksurface, specify \$981 list for laminate or \$1,578 list for veneer; see page 21 for details
- undermount power available, specify and add \$1,014 list; power infeed sold separately, see page 224

Description	D	W	H	CTN WT	CU FT	① Model	HPL Laminate	Essentials Veneer	Artisan Veneer
Adjustable Height Table & Return - 90° Two Piece Top	72	72	Adj.	231	15	FLT2472RTAH48R	\$3,426		
	72	72	Adj.	231	15	FLV2472RTAH48R		\$4,247	\$4,545
	72	72	Adj.	231	15	FLT2472RTAH48L	\$3,426		
	72	72	Adj.	231	15	FLV2472RTAH48L		\$4,247	\$4,545
	72	66	Adj.	225	14	FLT2466RTAH48R	\$3,387		
	72	66	Adj.	225	14	FLV2466RTAH48R		\$4,197	\$4,491
	72	66	Adj.	225	14	FLT2466RTAH48L	\$3,387		
	72	66	Adj.	225	14	FLV2466RTAH48L		\$4,197	\$4,491
	72	60	Adj.	219	13	FLT2460RTAH48R	\$3,345		
	72	60	Adj.	219	13	FLV2460RTAH48R		\$4,146	\$4,436
	72	60	Adj.	219	13	FLT2460RTAH48L	\$3,345		
	72	60	Adj.	219	13	FLV2460RTAH48L		\$4,146	\$4,436

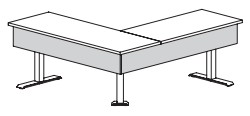
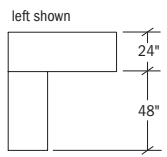
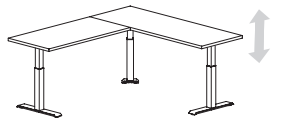
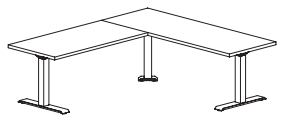

optional modesty panels

Features:

- eased edge profile on approach and user sides
- 22½" to 49" height adjustment
- maximum weight rating 140 lbs. (evenly distributed load)
- key pad features height display with three memory settings; key pad mounts left or right
- display will reference position to the nearest ½"
- 120" power cord

Options:

- specify Matte Black (MBK) or Arctic Silver (ASL) base finish
- reverse bevel edge available on desk approach side only, specify; add \$474 list for laminate or \$186 list for veneer; see page 8 for details
- top grommet available, specify location and add \$142 list each; see page 49 for details
- modesty panel available (2-sides) moves with worksurface, specify \$981 list for laminate or \$1,578 list for veneer; see page 21 for details
- undermount power available, specify and add \$1,014 list; power infeed sold separately, see page 224

To Order, Specify:

① Laminate Model #	② Laminate Type	③ Laminate Selection	④ Metal Color	⑤ Other Product Options
Laminate (FLT)	HPL	See Laminate Selection	See Metal Finish Color Options	See list of options for each specific unit; Specify and add accordingly.

① Veneer Model #	② Wood Collection	③ Wood Finish	④ Metal Color	⑤ Other Product Options		
Veneer (FLV)	Essentials	See Essentials Wood Finish Options	See Metal Finish Color Options	See list of options for each specific unit; Specify and add accordingly.		
	Artisan	<table border="1"> <thead> <tr> <th>ⓐ Wood Finish</th> <th>ⓑ Chassis Grain Direction</th> </tr> </thead> <tbody> <tr> <td>See Artisan Wood Finish Options</td> <td>For Artisan Only: Vertical Horizontal</td> </tr> </tbody> </table>	ⓐ Wood Finish		ⓑ Chassis Grain Direction	See Artisan Wood Finish Options
ⓐ Wood Finish	ⓑ Chassis Grain Direction					
See Artisan Wood Finish Options	For Artisan Only: Vertical Horizontal					

FLUX

Description	D	W	H	CTN WT	CU FT	① Model	List Price
3 Prong Plug - 110 Power Infeed for Link System		72		1	1	EC-PI-L-72-A	\$292

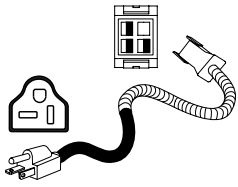

plug included:
15 amp adapter

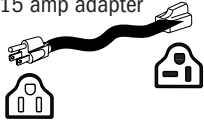

Features:

- 72" plug power infeed
- 20 amps/110 volts max
- 3 prong plug - 15 amp adapter plug
- single circuit use only
- use in conjunction with other link electrical items

Hardwire Power Infeed for Link System		72		1	1	EC-PI-L-72-H	\$190
--	--	----	--	---	---	--------------	-------

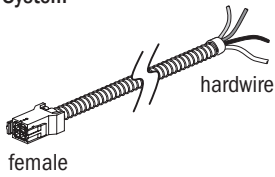

Features:

- 72" hardwire power infeed
- 20 amps/120 volts max
- single or two circuit
- electrical contractor responsible for connection to building power source
- use in conjunction with other link electrical items

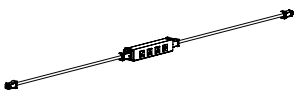
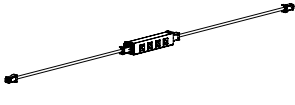
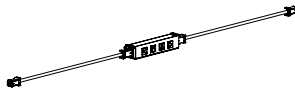
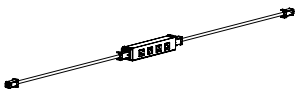
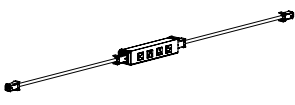
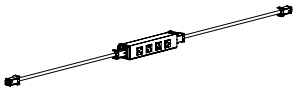
Description	D	W	H	CTN WT	CU FT	① Model	List Price
72" Power Link Kits - Circuit 1 						ECAH-72UP-1	\$987
<ul style="list-style-type: none"> · use with 72" tables · 72" plug power infeed required, sold separately · 20 amps/110 volts max · Circuit 1 · kit includes, undermount power with 4 outlets, jumpers, mounting brackets with screws, clamps & loop cable with black mesh 							
72" Power Link Kits - Circuit 2 						ECAH-72UP-2	\$987
<ul style="list-style-type: none"> · use with 72" tables · 72" plug power infeed required, sold separately · 20 amps/110 volts max · Circuit 2 · kit includes, undermount power with 4 outlets, jumpers, mounting brackets with screws, clamps & loop cable with black mesh 							
66" Power Link Kits - Circuit 1 						ECAH-66UP-1	\$970
<ul style="list-style-type: none"> · use with 66" tables · 72" plug power infeed required, sold separately · 20 amps/110 volts max · Circuit 1 · kit includes, undermount power with 4 outlets, jumpers, mounting brackets with screws, clamps & loop cable with black mesh 							
66" Power Link Kits - Circuit 2 						ECAH-66UP-2	\$970
<ul style="list-style-type: none"> · use with 66" tables · 72" plug power infeed required, sold separately · 20 amps/110 volts max · Circuit 2 · kit includes, undermount power with 4 outlets, jumpers, mounting brackets with screws, clamps & loop cable with black mesh 							
60" Power Link Kits - Circuit 1 						ECAH-60UP-1	\$950
<ul style="list-style-type: none"> · use with 60" tables · 72" plug power infeed · 20 amps/110 volts max · Circuit 1 							
60" Power Link Kits - Circuit 2 						ECAH-60UP-2	\$950
<ul style="list-style-type: none"> · use with 60" tables · 72" plug power infeed required, sold separately · 20 amps/110 volts max · Circuit 2 · kit includes, undermount power with 4 outlets, jumpers, mounting brackets with screws, clamps & loop cable with black mesh 							

FLUX

To Order, Specify:

① Model Number	
----------------	--

Description	D	W	H	CTN WT	CU FT	① Model	HPL Laminate	Essentials Veneer	Artisan Veneer
Adjustable Height Freestanding Desk Shell with Flush Modesty Panel	36	72	Adj.	305	51	FLT3672AHFDS	\$6,157		
	36	72	Adj.	305	51	FLV3672AHFDS		\$7,969	\$8,767
	36	66	Adj.	292	47	FLT3666AHFDS	\$6,118		
	36	66	Adj.	292	47	FLV3666AHFDS		\$7,916	\$8,707
	36	60	Adj.	279	43	FLT3660AHFDS	\$6,083		
	36	60	Adj.	279	43	FLV3660AHFDS		\$7,864	\$8,650

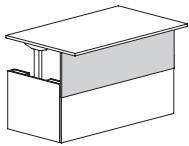
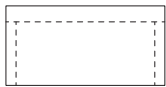
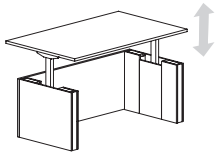
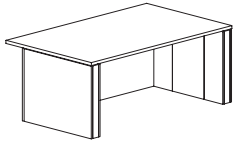

optional 20" modesty

Features:

- eased edge profile on approach and user sides
- 29" to 47" height adjustment with digital controller, wire guide and 10' power cord
- maximum weight rating 140 lbs. (evenly distributed load)

Options:

- must specify chassis grain direction on artisan veneer, see pages 13-15 for details
- reverse bevel edge available on desk approach side only, specify; add \$474 list for laminate or \$186 list for veneer; see page 8 for details
- 20"h modesty panel available, moves with worksurface, specify \$474 list for laminate or \$656 list for veneer; see page 17 for details
- top grommet available, specify location; add \$142 list each; see page 49 for details

Adjustable Height Freestanding Desk Shell with Flush Modesty Panel	30	72	Adj.	283	43	FLT3072AHFDS	\$5,978		
	30	72	Adj.	283	43	FLV3072AHFDS		\$7,731	\$8,505
	30	66	Adj.	271	40	FLT3066AHFDS	\$5,946		
	30	66	Adj.	271	40	FLV3066AHFDS		\$7,683	\$8,452
	30	60	Adj.	259	36	FLT3060AHFDS	\$5,913		
	30	60	Adj.	259	36	FLV3060AHFDS		\$7,638	\$8,399

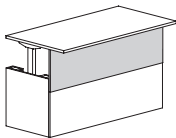
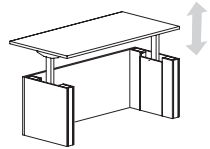
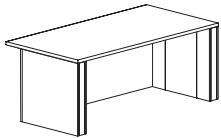

optional 20" modesty

Features:

- eased edge profile on approach and user sides
- 29" to 47" height adjustment with digital controller, wire guide and 10' power cord
- maximum weight rating 140 lbs. (evenly distributed load)

Options:

- must specify chassis grain direction on artisan veneer, see pages 13-15 for details
- reverse bevel edge available on desk approach side only, specify; add \$474 list for laminate or \$186 list for veneer; see page 8 for details
- 20"h modesty panel available, moves with worksurface, specify \$474 list for laminate or \$656 list for veneer; see page 17 for details
- top grommet available, specify location; add \$142 list each; see page 47 for details

FLUX

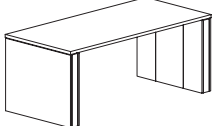
Description	D	W	H	CTN WT	CU FT	① Model	HPL Laminate	Essentials Veneer	Artisan Veneer
Adjustable Height Freestanding Table 	33 1/2	72	Adj.	261	48	FLT3472AHFT	\$6,163		
	33 1/2	72	Adj.	261	48	FLV3472AHFT		\$7,985	\$8,781
	33 1/2	66	Adj.	253	44	FLT3466AHFT	\$6,126		
	33 1/2	66	Adj.	253	44	FLV3466AHFT		\$7,928	\$8,723
	33 1/2	60	Adj.	245	40	FLT3460AHFT	\$6,097		
	33 1/2	60	Adj.	245	40	FLV3460AHFT		\$7,877	\$8,665

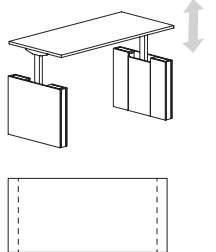

Features:

- eased edge profile on approach and user sides
- 29" to 47" height adjustment with digital controller, wire guide and 10' power cord
- maximum weight rating 140 lbs. (evenly distributed load)

Options:

- must specify chassis grain direction on artisan veneer, see pages 13-15 for details
- reverse bevel edge available on desk approach side only, specify; add \$474 list for laminate or \$186 list for veneer; see page 8 for details
- 13 1/2" h modesty panel available, moves with worksurface, specify \$474 list for laminate or \$656 list for veneer; see page 17 for details
- top grommet available, specify location; add \$142 list each; see page 47 for details

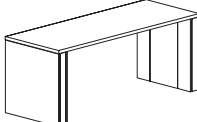
Adjustable Height Freestanding Table 	27 1/2	72	Adj.	227	40	FLT2872AHFT	\$5,983		
	27 1/2	72	Adj.	227	40	FLV2872AHFT		\$7,743	\$8,518
	27 1/2	66	Adj.	220	37	FLT2866AHFT	\$5,951		
	27 1/2	66	Adj.	220	37	FLV2866AHFT		\$7,693	\$8,465
	27 1/2	60	Adj.	213	34	FLT2860AHFT	\$5,919		
	27 1/2	60	Adj.	213	34	FLV2860AHFT		\$7,648	\$8,414

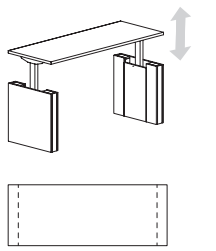

Features:

- eased edge profile on approach and user sides
- 29" to 47" height adjustment with digital controller, wire guide and 10' power cord
- maximum weight rating 140 lbs. (evenly distributed load)

Options:

- must specify chassis grain direction on artisan veneer, see pages 13-15 for details
- reverse bevel edge available on desk approach side only, specify; add \$474 list for laminate or \$186 list for veneer; see page 8 for details
- 13 1/2" h modesty panel available, moves with worksurface, specify \$474 list for laminate or \$656 list for veneer; see page 17 for details
- top grommet available, specify location; add \$142 list each; see page 47 for details

To Order, Specify:

① Laminate Model #	② Laminate Type	③ Laminate Selection	④ Metal Color	⑤ Other Product Options		
Laminate (FLT)	HPL	See Laminate Selection	See Metal Finish Color Options	See list of options for each specific unit; Specify and add accordingly.		
① Veneer Model #	② Wood Collection	③ Wood Finish	④ Metal Color	⑤ Other Product Options		
Veneer (FLV)	Essentials	See Essentials Wood Finish Options	See Metal Finish Color Options	See list of options for each specific unit; Specify and add accordingly.		
	Artisan	<table border="1"> <tr> <th>ⓐ Wood Finish</th> <th>ⓑ Chassis Grain Direction</th> </tr> <tr> <td>See Artisan Wood Finish Options</td> <td>For Artisan Only: Vertical Horizontal</td> </tr> </table>	ⓐ Wood Finish		ⓑ Chassis Grain Direction	See Artisan Wood Finish Options
ⓐ Wood Finish	ⓑ Chassis Grain Direction					
See Artisan Wood Finish Options	For Artisan Only: Vertical Horizontal					

FLUX

Description	D	W	H	CTN WT	CU FT	① Model	HPL Laminate	Essentials Veneer	Artisan Veneer
	22	72	Adj.	251	32	FLT2272-29FAHC	\$5,978		
	22	72	Adj.	251	32	FLV2272-29FAHC		\$7,731	\$8,505
	22	66	Adj.	243	30	FLT2266-29FAHC	\$5,946		
	22	66	Adj.	243	30	FLV2266-29FAHC		\$7,683	\$8,452
	22	60	Adj.	233	27	FLT2260-29FAHC	\$5,913		
	22	60	Adj.	233	27	FLV2260-29FAHC		\$7,638	\$8,399
	22	54	Adj.	222	25	FLT2254-29FAHC	\$5,884		
	22	54	Adj.	222	25	FLV2254-29FAHC		\$7,593	\$8,351
	22	48	Adj.	205	22	FLT2248-29FAHC	\$5,856		
	22	48	Adj.	205	22	FLV2248-29FAHC		\$7,549	\$8,304

Features:

- use to expand work station
- eased edge profile user side
- 29" to 47" height adjustment with digital controller, wire guide and 10' power cord

Options:

- must specify chassis grain direction on artisan veneer, see pages 13-15 for details
- top grommet available, specify location; add \$142 list each; see page 48 for details

Description	D	W	H	CTN WT	CU FT	① Model	HPL Laminate	Essentials Veneer	Artisan Veneer
	22	72	Adj.	261	32	FLT2272-29FAHCE	\$5,050		
	22	72	Adj.	261	32	FLV2272-29FAHCE		\$6,295	\$6,923
	22	66	Adj.	249	30	FLT2266-29FAHCE	\$5,017		
	22	66	Adj.	249	30	FLV2266-29FAHCE		\$6,251	\$6,875
	22	60	Adj.	242	27	FLT2260-29FAHCE	\$4,989		
	22	60	Adj.	242	27	FLV2260-29FAHCE		\$6,210	\$6,829
	22	54	Adj.	232	25	FLT2254-29FAHCE	\$4,960		
	22	54	Adj.	232	25	FLV2254-29FAHCE		\$6,166	\$6,782
	22	48	Adj.	226	22	FLT2248-29FAHCE	\$4,931		
	22	48	Adj.	226	22	FLV2248-29FAHCE		\$6,124	\$6,737

Features:

- use to expand work station
- eased edge profile user side
- 29" to 47" height adjustment with digital controller, wire guide and 10' power cord

Options:

- must specify chassis grain direction on artisan veneer, see pages 13-15 for details
- top grommet available, specify location; add \$142 list each; see page 48 for details
- wall access cutouts available, specify and add \$256 list

FLUX

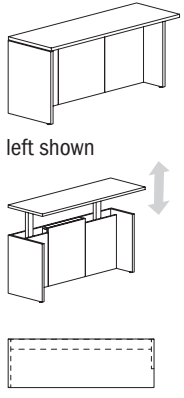
Description	D	W	H	CTN WT	CU FT	① Model	HPL Laminate	Essentials Veneer	Artisan Veneer
Adjustable Height Return Shell  left shown	22	72	Adj.	220	33	FLT2272-29FAHRR	\$5,050		
	22	72	Adj.	220	33	FLV2272-29FAHRR		\$6,295	\$6,923
	22	72	Adj.	220	33	FLT2272-29FAHRL	\$5,050		
	22	72	Adj.	220	33	FLV2272-29FAHRL		\$6,295	\$6,923
	22	66	Adj.	208	30	FLT2266-29FAHRR	\$5,017		
	22	66	Adj.	208	30	FLV2266-29FAHRR		\$6,251	\$6,875
	22	66	Adj.	208	30	FLT2266-29FAHRL	\$5,017		
	22	66	Adj.	208	30	FLV2266-29FAHRL		\$6,251	\$6,875
	22	60	Adj.	196	27	FLT2260-29FAHRR	\$4,989		
	22	60	Adj.	196	27	FLV2260-29FAHRR		\$6,210	\$6,829
	22	60	Adj.	196	27	FLT2260-29FAHRL	\$4,989		
	22	60	Adj.	196	27	FLV2260-29FAHRL		\$6,210	\$6,829
	22	54	Adj.	184	25	FLT2254-29FAHRR	\$4,960		
	22	54	Adj.	184	25	FLV2254-29FAHRR		\$6,166	\$6,782
	22	54	Adj.	184	25	FLT2254-29FAHRL	\$4,960		
	22	54	Adj.	184	25	FLV2254-29FAHRL		\$6,166	\$6,782
	22	48	Adj.	172	22	FLT2248-29FAHRR	\$4,931		
	22	48	Adj.	172	22	FLV2248-29FAHRR		\$6,124	\$6,737
	22	48	Adj.	172	22	FLT2248-29FAHRL	\$4,931		
	22	48	Adj.	172	22	FLV2248-29FAHRL		\$6,124	\$6,737

Features:

- must be used with desk
- laminate tops wider than 60" are long grain
- 29" to 47" height adjustment with digital controller, wire guide and 10' power cord
- maximum weight rating 100 lbs. (evenly distributed load)

Options:

- must specify chassis grain direction on artisan veneer, see pages 13-15 for details
- top grommet available, specify location; add \$142 list each; see page 48 for details
- wall access cutouts available, specify and add \$256 list

To Order, Specify:

① Laminate Model #	② Laminate Type	③ Laminate Selection	④ Metal Color	⑤ Other Product Options
Laminate (FLT)	HPL	See Laminate Selection	See Metal Finish Color Options	See list of options for each specific unit; Specify and add accordingly.
① Veneer Model #	② Wood Collection	③ Wood Finish	④ Metal Color	⑤ Other Product Options
Veneer (FLV)	Essentials	See Essentials Wood Finish Options	See Metal Finish Color Options	See list of options for each specific unit; Specify and add accordingly.
	Artisan	ⓐ Wood Finish See Artisan Wood Finish Options	ⓑ Chassis Grain Direction For Artisan Only: Vertical Horizontal	

Description	D	W	H	CTN WT	CU FT	① Model	HPL Laminate	Essentials Veneer	Artisan Veneer
Adjustable Height U-Configuration Desk and Bridge	80	72	Adj.	470	110	FLT3672-U44AHR	\$8,961		
	80	72	Adj.	470	110	FLV3672-U44AHR		\$11,418	\$12,558
	80	72	Adj.	470	110	FLT3672-U44AHL	\$8,961		
	80	72	Adj.	470	110	FLV3672-U44AHL		\$11,418	\$12,558
	80	66	Adj.	433	101	FLT3666-U44AHR	\$8,853		
	80	66	Adj.	433	101	FLV3666-U44AHR		\$11,263	\$12,388
	80	66	Adj.	433	101	FLT3666-U44AHL	\$8,853		
	80	66	Adj.	433	101	FLV3666-U44AHL		\$11,263	\$12,388
	80	60	Adj.	419	92	FLT3660-U44AHR	\$8,748		
	80	60	Adj.	419	92	FLV3660-U44AHR		\$11,111	\$12,224
	80	60	Adj.	419	92	FLT3660-U44AHL	\$8,748		
	80	60	Adj.	419	92	FLV3660-U44AHL		\$11,111	\$12,224

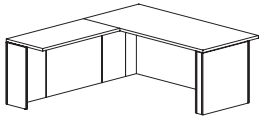

left shown

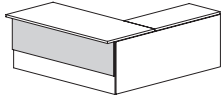
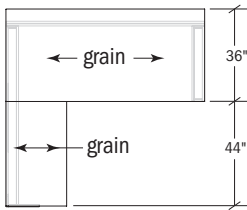
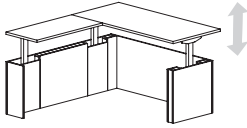

20"h optional modesty

Features:

- must attach to open corner credenza
- eased edge profile on approach and user sides
- 29" to 47" height adjustment with digital controller, wire guide and 10' power cord
- maximum weight rating 210 lbs. (evenly distributed load)

Options:

- must specify chassis grain direction on artisan veneer, see pages 13-15 for details
- reverse bevel edge available on desk approach side only, specify; add \$474 list for laminate or \$186 list for veneer; see page 8 for details
- 20"h modesty panel available, moves with worksurface, specify \$474 list for laminate or \$656 list for veneer; see page 17 for details
- top grommet available, specify location; add \$142 list each; see page 49 for details
- wall access cutouts available, specify and add \$256 list

FLUX

Description	D	W	H	CTN WT	CU FT	① Model	HPL Laminate	Essentials Veneer	Artisan Veneer
Adjustable Height U-Configuration Desk and Bridge	74	72	Adj.	452	102	FLT3672-U38AHR	\$8,929		
	74	72	Adj.	452	102	FLV3672-U38AHR		\$11,369	\$12,506
	74	72	Adj.	452	102	FLT3672-U38AHL	\$8,929		
	74	72	Adj.	452	102	FLV3672-U38AHL		\$11,369	\$12,506
	74	66	Adj.	415	94	FLT3666-U38AHR	\$8,819		
	74	66	Adj.	415	94	FLV3666-U38AHR		\$11,213	\$12,337
	74	66	Adj.	415	94	FLT3666-U38AHL	\$8,819		
	74	66	Adj.	415	94	FLV3666-U38AHL		\$11,213	\$12,337
	74	60	Adj.	401	86	FLT3660-U38AHR	\$8,712		
	74	60	Adj.	401	86	FLV3660-U38AHR		\$11,062	\$12,168
	74	60	Adj.	401	86	FLT3660-U38AHL	\$8,712		
	74	60	Adj.	401	86	FLV3660-U38AHL		\$11,062	\$12,168

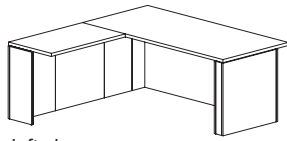

left shown

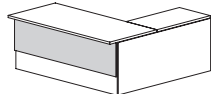
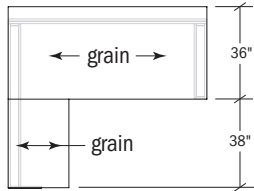
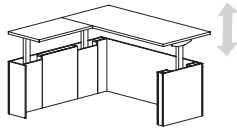

20" h optional modesty

Features:

- must attach to open corner credenza
- eased edge profile on approach and user sides
- 29" to 47" height adjustment with digital controller, wire guide and 10' power cord
- maximum weight rating 210 lbs. (evenly distributed load)

Options:

- must specify chassis grain direction on artisan veneer, see pages 13-15 for details
- reverse bevel edge available on desk approach side only, specify; add \$474 list for laminate or \$186 list for veneer; see page 8 for details
- 20" h modesty panel available, moves with worksurface, specify \$474 list for laminate or \$656 list for veneer; see page 17 for details
- top grommet available, specify location; add \$142 list each; see page 49 for details
- wall access cutouts available, specify and add \$256 list

FLUX

To Order, Specify:

① Laminate Model #	② Laminate Type	③ Laminate Selection	④ Metal Color	⑤ Other Product Options		
Laminate (FLT)	HPL	See Laminate Selection	See Metal Finish Color Options	See list of options for each specific unit; Specify and add accordingly.		
① Veneer Model #	② Wood Collection	③ Wood Finish	④ Metal Color	⑤ Other Product Options		
Veneer (FLV)	Essentials	See Essentials Wood Finish Options	See Metal Finish Color Options	See list of options for each specific unit; Specify and add accordingly.		
	Artisan	<table border="1"> <tr> <th>ⓐ Wood Finish</th> <th>ⓑ Chassis Grain Direction</th> </tr> <tr> <td>See Artisan Wood Finish Options</td> <td>For Artisan Only: Vertical Horizontal</td> </tr> </table>	ⓐ Wood Finish		ⓑ Chassis Grain Direction	See Artisan Wood Finish Options
ⓐ Wood Finish	ⓑ Chassis Grain Direction					
See Artisan Wood Finish Options	For Artisan Only: Vertical Horizontal					

Description	D	W	H	CTN WT	CU FT	① Model	HPL Laminate	Essentials Veneer	Artisan Veneer
Adjustable Height U-Configuration Desk and Bridge	74	72	Adj.	433	102	FLT3072-U44AHR	\$8,705		
	74	72	Adj.	433	102	FLV3072-U44AHR		\$11,123	\$12,234
	74	72	Adj.	433	102	FLT3072-U44AHL	\$8,705		
	74	72	Adj.	433	102	FLV3072-U44AHL		\$11,123	\$12,234
	74	66	Adj.	396	94	FLT3066-U44AHR	\$8,598		
	74	66	Adj.	396	94	FLV3066-U44AHR		\$10,969	\$12,065
	74	66	Adj.	396	94	FLT3066-U44AHL	\$8,598		
	74	66	Adj.	396	94	FLV3066-U44AHL		\$10,969	\$12,065
	74	60	Adj.	382	86	FLT3060-U44AHR	\$8,493		
	74	60	Adj.	382	86	FLV3060-U44AHR		\$10,814	\$11,897
	74	60	Adj.	382	86	FLT3060-U44AHL	\$8,493		
	74	60	Adj.	382	86	FLV3060-U44AHL		\$10,814	\$11,897

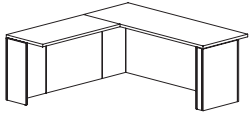

left shown

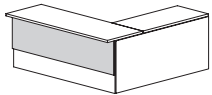
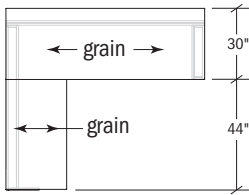
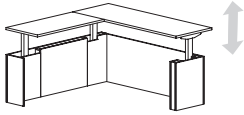

20"h optional modesty

Features:

- must attach to open corner credenza
- eased edge profile on approach and user sides
- 29" to 47" height adjustment with digital controller, wire guide and 10' power cord
- maximum weight rating 210 lbs. (evenly distributed load)

Options:

- must specify chassis grain direction on artisan veneer, see pages 13-15 for details
- reverse bevel edge available on desk approach side only, specify; add \$474 list for laminate or \$186 list for veneer; see page 8 for details
- 20"h modesty panel available, moves with worksurface, specify \$474 list for laminate or \$656 list for veneer; see page 17 for details
- top grommet available, specify location; add \$142 list each; see page 49 for details
- wall access cutouts available, specify and add \$256 list

FLUX

Description	D	W	H	CTN WT	CU FT	① Model	HPL Laminate	Essentials Veneer	Artisan Veneer
Adjustable Height U-Configuration Desk and Bridge	68	72	Adj.	415	94	FLT3072-U38AHR	\$8,673		
	68	72	Adj.	415	94	FLV3072-U38AHR		\$11,073	\$12,180
	68	72	Adj.	415	94	FLT3072-U38AHL	\$8,673		
	68	72	Adj.	415	94	FLV3072-U38AHL		\$11,073	\$12,180
	68	66	Adj.	378	87	FLT3066-U38AHR	\$8,565		
	68	66	Adj.	378	87	FLV3066-U38AHR		\$10,920	\$12,010
	68	66	Adj.	378	87	FLT3066-U38AHL	\$8,565		
	68	66	Adj.	378	87	FLV3066-U38AHL		\$10,920	\$12,010
	68	60	Adj.	364	79	FLT3060-U38AHR	\$8,458		
	68	60	Adj.	364	79	FLV3060-U38AHR		\$10,767	\$11,841
	68	60	Adj.	364	79	FLT3060-U38AHL	\$8,458		
	68	60	Adj.	364	79	FLV3060-U38AHL		\$10,767	\$11,841

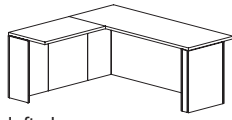

left shown

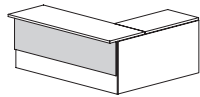
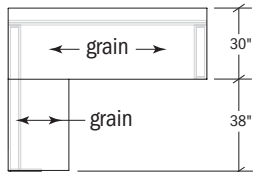
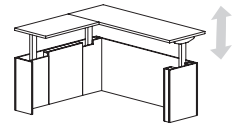

20"h optional modesty

Features:

- must attach to open corner credenza
- eased edge profile on approach and user sides
- 29" to 47" height adjustment with digital controller, wire guide and 10' power cord
- maximum weight rating 210 lbs. (evenly distributed load)

Options:

- must specify chassis grain direction on artisan veneer, see pages 13-15 for details
- reverse bevel edge available on desk approach side only, specify; add \$474 list for laminate or \$186 list for veneer; see page 8 for details
- 20"h modesty panel available, moves with worksurface, specify \$474 list for laminate or \$656 list for veneer; see page 17 for details
- top grommet available, specify location; add \$142 list each; see page 49 for details
- wall access cutouts available, specify and add \$256 list

FLUX

To Order, Specify:

① Laminate Model #	② Laminate Type	③ Laminate Selection	④ Metal Color	⑤ Other Product Options		
Laminate (FLT)	HPL	See Laminate Selection	See Metal Finish Color Options	See list of options for each specific unit; Specify and add accordingly.		
① Veneer Model #	② Wood Collection	③ Wood Finish	④ Metal Color	⑤ Other Product Options		
Veneer (FLV)	Essentials	See Essentials Wood Finish Options	See Metal Finish Color Options	See list of options for each specific unit; Specify and add accordingly.		
	Artisan	<table border="1"> <tr> <th>ⓐ Wood Finish</th> <th>ⓑ Chassis Grain Direction</th> </tr> <tr> <td>See Artisan Wood Finish Options</td> <td>For Artisan Only: Vertical Horizontal</td> </tr> </table>	ⓐ Wood Finish		ⓑ Chassis Grain Direction	See Artisan Wood Finish Options
ⓐ Wood Finish	ⓑ Chassis Grain Direction					
See Artisan Wood Finish Options	For Artisan Only: Vertical Horizontal					

Description	D	W	H	CTN WT	CU FT	① Model	HPL Laminate	Essentials Veneer	Artisan Veneer
Adjustable Height L-Configuration Desk and Return	80	72	Adj.	481	110	FLT3672-L44AHR	\$8,961		
	80	72	Adj.	481	110	FLV3672-L44AHR		\$11,418	\$12,558
	80	72	Adj.	481	110	FLT3672-L44AHL	\$8,961		
	80	72	Adj.	481	110	FLV3672-L44AHL		\$11,418	\$12,558
	80	66	Adj.	444	101	FLT3666-L44AHR	\$8,853		
	80	66	Adj.	444	101	FLV3666-L44AHR		\$11,263	\$12,388
	80	66	Adj.	444	101	FLT3666-L44AHL	\$8,853		
	80	66	Adj.	444	101	FLV3666-L44AHL		\$11,263	\$12,388
	80	60	Adj.	430	92	FLT3660-L44AHR	\$8,748		
	80	60	Adj.	430	92	FLV3660-L44AHR		\$11,111	\$12,224
	80	60	Adj.	430	92	FLT3660-L44AHL	\$8,748		
	80	60	Adj.	430	92	FLV3660-L44AHL		\$11,111	\$12,224

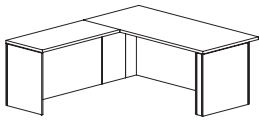

left shown

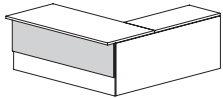
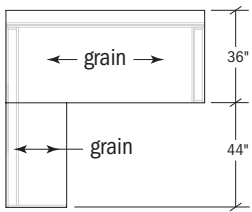
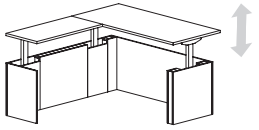

20"h optional modesty

Features:

- eased edge profile on approach and user sides
- 29" to 47" height adjustment with digital controller, wire guide and 10' power cord
- maximum weight rating 210 lbs. (evenly distributed load)

Options:

- must specify chassis grain direction on artisan veneer, see pages 13-15 for details
- reverse bevel edge available on desk approach side only, specify; add \$474 list for laminate or \$186 list for veneer; see page 8 for details
- 20"h modesty panel available, moves with worksurface, specify \$474 list for laminate or \$656 list for veneer; see page 17 for details
- top grommet available, specify location; add \$142 list each; see page 49 for details
- wall access cutouts available, specify and add \$256 list

FLUX

Description	D	W	H	CTN WT	CU FT	① Model	HPL Laminate	Essentials Veneer	Artisan Veneer
Adjustable Height L-Configuration Desk and Return left shown 20"h optional modesty	74	72	Adj.	463	102	FLT3672-L38AHR	\$8,929		
	74	72	Adj.	463	102	FLV3672-L38AHR		\$11,369	\$12,506
	74	72	Adj.	463	102	FLT3672-L38AHL	\$8,929		
	74	72	Adj.	463	102	FLV3672-L38AHL		\$11,369	\$12,506
	74	66	Adj.	426	94	FLT3666-L38AHR	\$8,819		
	74	66	Adj.	426	94	FLV3666-L38AHR		\$11,213	\$12,337
	74	66	Adj.	426	94	FLT3666-L38AHL	\$8,819		
	74	66	Adj.	426	94	FLV3666-L38AHL		\$11,213	\$12,337
	74	60	Adj.	412	86	FLT3660-L38AHR	\$8,712		
	74	60	Adj.	412	86	FLV3660-L38AHR		\$11,062	\$12,168
	74	60	Adj.	412	86	FLT3660-L38AHL	\$8,712		
	74	60	Adj.	412	86	FLV3660-L38AHL		\$11,062	\$12,168

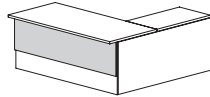
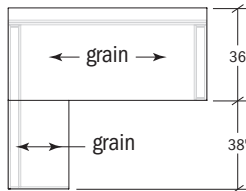
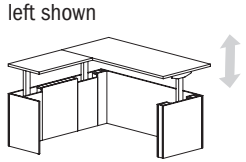
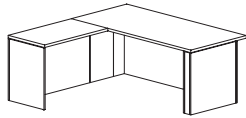

Features:

- eased edge profile on approach and user sides
- 29" to 47" height adjustment with digital controller, wire guide and 10' power cord
- maximum weight rating 210 lbs. (evenly distributed load)

Options:

- must specify chassis grain direction on artisan veneer, see pages 13-15 for details
- reverse bevel edge available on desk approach side only, specify; add \$474 list for laminate or \$186 list for veneer; see page 8 for details
- 20"h modesty panel available, moves with worksurface, specify \$474 list for laminate or \$656 list for veneer; see page 17 for details
- top grommet available, specify location; add \$142 list each; see page 49 for details
- wall access cutouts available, specify and add \$256 list

To Order, Specify:

① Laminate Model #	② Laminate Type	③ Laminate Selection	④ Metal Color	⑤ Other Product Options		
Laminate (FLT)	HPL	See Laminate Selection	See Metal Finish Color Options	See list of options for each specific unit; Specify and add accordingly.		
① Veneer Model #	② Wood Collection	③ Wood Finish	④ Metal Color	⑤ Other Product Options		
Veneer (FLV)	Essentials	See Essentials Wood Finish Options	See Metal Finish Color Options	See list of options for each specific unit; Specify and add accordingly.		
	Artisan	<table border="1"> <tr> <th>③a Wood Finish</th> <th>③b Chassis Grain Direction</th> </tr> <tr> <td>See Artisan Wood Finish Options</td> <td>For Artisan Only: Vertical Horizontal</td> </tr> </table>	③a Wood Finish		③b Chassis Grain Direction	See Artisan Wood Finish Options
③a Wood Finish	③b Chassis Grain Direction					
See Artisan Wood Finish Options	For Artisan Only: Vertical Horizontal					

Description	D	W	H	CTN WT	CU FT	① Model	HPL Laminate	Essentials Veneer	Artisan Veneer
Adjustable Height L-Configuration Desk and Return	74	72	Adj.	444	102	FLT3072-L44AHR	\$8,705		
	74	72	Adj.	444	102	FLV3072-L44AHR		\$11,123	\$12,234
	74	72	Adj.	444	102	FLT3072-L44AHL	\$8,705		
	74	72	Adj.	444	102	FLV3072-L44AHL		\$11,123	\$12,234
	74	66	Adj.	407	94	FLT3066-L44AHR	\$8,598		
	74	66	Adj.	407	94	FLV3066-L44AHR		\$10,969	\$12,065
	74	66	Adj.	407	94	FLT3066-L44AHL	\$8,598		
	74	66	Adj.	407	94	FLV3066-L44AHL		\$10,969	\$12,065
	74	60	Adj.	393	86	FLT3060-L44AHR	\$8,493		
	74	60	Adj.	393	86	FLV3060-L44AHR		\$10,814	\$11,897
	74	60	Adj.	393	86	FLT3060-L44AHL	\$8,493		
	74	60	Adj.	393	86	FLV3060-L44AHL		\$10,814	\$11,897

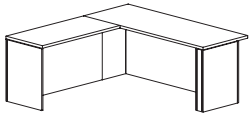

left shown

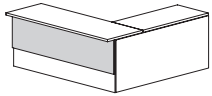
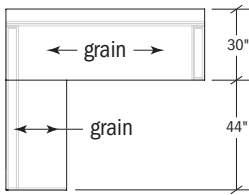
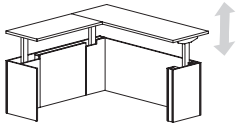

20"h optional modesty

Features:

- eased edge profile on approach and user sides
- 29" to 47" height adjustment with digital controller, wire guide and 10' power cord
- maximum weight rating 210 lbs. (evenly distributed load)

Options:

- must specify chassis grain direction on artisan veneer, see pages 13-15 for details
- reverse bevel edge available on desk approach side only, specify; add \$474 list for laminate or \$186 list for veneer; see page 8 for details
- 20"h modesty panel available, moves with worksurface, specify \$474 list for laminate or \$656 list for veneer; see page 17 for details
- top grommet available, specify location; add \$142 list each; see page 49 for details
- wall access cutouts available, specify and add \$256 list

FLUX

Description	D	W	H	CTN WT	CU FT	① Model	HPL Laminate	Essentials Veneer	Artisan Veneer
Adjustable Height L-Configuration Desk and Return left shown 20"h optional modesty	68	72	Adj.	426	94	FLT3072-L38AHR	\$8,673		
	68	72	Adj.	426	94	FLV3072-L38AHR		\$11,073	\$12,180
	68	72	Adj.	426	94	FLT3072-L38AHL	\$8,673		
	68	72	Adj.	426	94	FLV3072-L38AHL		\$11,073	\$12,180
	68	66	Adj.	389	87	FLT3066-L38AHR	\$8,565		
	68	66	Adj.	389	87	FLV3066-L38AHR		\$10,920	\$12,010
	68	66	Adj.	389	87	FLT3066-L38AHL	\$8,565		
	68	66	Adj.	389	87	FLV3066-L38AHL		\$10,920	\$12,010
	68	60	Adj.	375	79	FLT3060-L38AHR	\$8,458		
	68	60	Adj.	375	79	FLV3060-L38AHR		\$10,767	\$11,841
	68	60	Adj.	375	79	FLT3060-L38AHL	\$8,458		
	68	60	Adj.	375	79	FLV3060-L38AHL		\$10,767	\$11,841

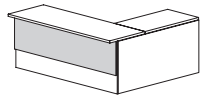
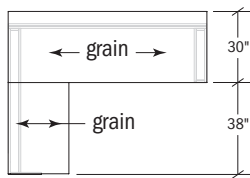
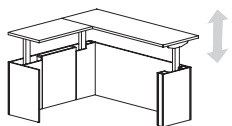
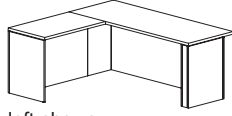

Features:

- eased edge profile on approach and user sides
- 29" to 47" height adjustment with digital controller, wire guide and 10' power cord
- maximum weight rating 210 lbs. (evenly distributed load)

Options:

- must specify chassis grain direction on artisan veneer, see pages 13-15 for details
- reverse bevel edge available on desk approach side only, specify; add \$474 list for laminate or \$186 list for veneer; see page 8 for details
- 20"h modesty panel available, moves with worksurface, specify \$474 list for laminate or \$656 list for veneer; see page 17 for details
- top grommet available, specify location; add \$142 list each; see page 49 for details
- wall access cutouts available, specify and add \$256 list

To Order, Specify:

① Laminate Model #	② Laminate Type	③ Laminate Selection	④ Metal Color	⑤ Other Product Options
Laminate (FLT)	HPL	See Laminate Selection	See Metal Finish Color Options	See list of options for each specific unit; Specify and add accordingly.

① Veneer Model #	② Wood Collection	③ Wood Finish	④ Metal Color	⑤ Other Product Options		
Veneer (FLV)	Essentials	See Essentials Wood Finish Options	See Metal Finish Color Options	See list of options for each specific unit; Specify and add accordingly.		
	Artisan	<table border="1"> <thead> <tr> <th>③a Wood Finish</th> <th>③b Chassis Grain Direction</th> </tr> </thead> <tbody> <tr> <td>See Artisan Wood Finish Options</td> <td>For Artisan Only: Vertical Horizontal</td> </tr> </tbody> </table>	③a Wood Finish		③b Chassis Grain Direction	See Artisan Wood Finish Options
③a Wood Finish	③b Chassis Grain Direction					
See Artisan Wood Finish Options	For Artisan Only: Vertical Horizontal					

FLUX

Description	D	W	H	CTN WT	CU FT	① Model	HPL Laminate	Essentials Veneer	Artisan Veneer
Adjustable Height L-Configuration Desk and Return with One Piece Top	60	72	Adj.	449	83	FLT3672-C24AHR	\$8,904		
	60	72	Adj.	449	83	FLV3672-C24AHR		\$11,336	\$12,471
	60	72	Adj.	449	83	FLT3672-C24AHL	\$8,904		
	60	72	Adj.	449	83	FLV3672-C24AHL		\$11,336	\$12,471
	60	66	Adj.	412	77	FLT3666-C24AHR	\$8,796		
	60	66	Adj.	412	77	FLV3666-C24AHR		\$11,182	\$12,300
	60	66	Adj.	412	77	FLT3666-C24AHL	\$8,796		
	60	66	Adj.	412	77	FLV3666-C24AHL		\$11,182	\$12,300
	60	60	Adj.	398	70	FLT3660-C24AHR	\$8,692		
	60	60	Adj.	398	70	FLV3660-C24AHR		\$11,029	\$12,133
	60	60	Adj.	398	70	FLT3660-C24AHL	\$8,692		
	60	60	Adj.	398	70	FLV3660-C24AHL		\$11,029	\$12,133

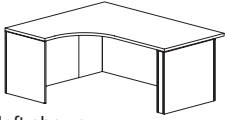

left shown

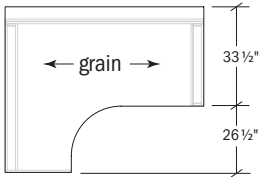
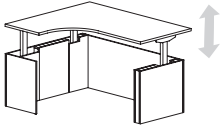

Features:

- eased edge profile on approach and user sides
- 29" to 47" height adjustment with digital controller, wire guide and 10' power cord
- maximum weight rating 210 lbs. (evenly distributed load)

Options:

- must specify chassis grain direction on artisan veneer, see pages 13-15 for details
- reverse bevel edge available on desk approach side only, specify; add \$474 list for laminate or \$186 list for veneer; see page 8 for details
- 20"h modesty panel available, moves with worksurface, specify \$474 list for laminate or \$656 list for veneer; see page 17 for details
- top grommet available, specify location; add \$142 list each; see page 49 for details
- wall access cutouts available, specify and add \$256 list

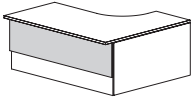

20"h optional modesty

FLUX

Description	D	W	H	CTN WT	CU FT	① Model	HPL Laminate	Essentials Veneer	Artisan Veneer
Adjustable Height L-Configuration Desk and Return with One Piece Top	60	72	Adj.	412	83	FLT3072-C30AHR	\$8,682		
	60	72	Adj.	412	83	FLV3072-C30AHR		\$11,090	\$12,199
	60	72	Adj.	412	83	FLT3072-C30AHL	\$8,682		
	60	72	Adj.	412	83	FLV3072-C30AHL		\$11,090	\$12,199
	60	66	Adj.	375	77	FLT3066-C30AHR	\$8,574		
	60	66	Adj.	375	77	FLV3066-C30AHR		\$10,934	\$12,029
	60	66	Adj.	375	77	FLT3066-C30AHL	\$8,574		
	60	66	Adj.	375	77	FLV3066-C30AHL		\$10,934	\$12,029
	60	60	Adj.	361	70	FLT3060-C30AHR	\$8,470		
	60	60	Adj.	361	70	FLV3060-C30AHR		\$10,783	\$11,862
	60	60	Adj.	361	70	FLT3060-C30AHL	\$8,470		
	60	60	Adj.	361	70	FLV3060-C30AHL		\$10,783	\$11,862

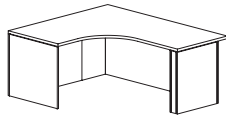

left shown

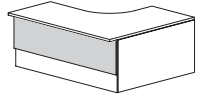
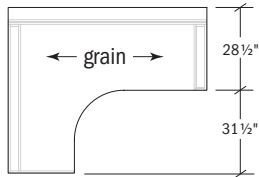
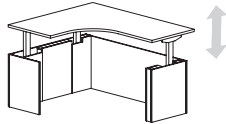

20"h optional modesty

Features:

- eased edge profile on approach and user sides
- 29" to 47" height adjustment with digital controller, wire guide and 10' power cord
- maximum weight rating 210 lbs. (evenly distributed load)

Options:

- must specify chassis grain direction on artisan veneer, see pages 13-15 for details
- reverse bevel edge available on desk approach side only, specify; add \$474 list for laminate or \$186 list for veneer; see page 8 for details
- 20"h modesty panel available, moves with worksurface, specify \$474 list for laminate or \$656 list for veneer; see page 17 for details
- top grommet available, specify location; add \$142 list each; see page 49 for details
- wall access cutouts available, specify and add \$256 list

FLUX

To Order, Specify:

① Laminate Model #	② Laminate Type	③ Laminate Selection	④ Metal Color	⑤ Other Product Options		
Laminate (FLT)	HPL	See Laminate Selection	See Metal Finish Color Options	See list of options for each specific unit; Specify and add accordingly.		
① Veneer Model #	② Wood Collection	③ Wood Finish	④ Metal Color	⑤ Other Product Options		
Veneer (FLV)	Essentials	See Essentials Wood Finish Options	See Metal Finish Color Options	See list of options for each specific unit; Specify and add accordingly.		
	Artisan	<table border="1"> <tr> <th>ⓐ Wood Finish</th> <th>ⓑ Chassis Grain Direction</th> </tr> <tr> <td>See Artisan Wood Finish Options</td> <td>For Artisan Only: Vertical Horizontal</td> </tr> </table>	ⓐ Wood Finish		ⓑ Chassis Grain Direction	See Artisan Wood Finish Options
ⓐ Wood Finish	ⓑ Chassis Grain Direction					
See Artisan Wood Finish Options	For Artisan Only: Vertical Horizontal					

Description	D	W	H	CTN WT	CU FT	① Model	HPL Laminate	Essentials Veneer	Artisan Veneer
33" Adjustable Height Modular Peninsula Desk	33½	72	Adj.	205	26	FLT3472PAHD	\$4,969		
	33½	72	Adj.	205	26	FLV3472PAHD		\$6,212	\$6,831
	33½	66	Adj.	198	25	FLT3466PAHD	\$4,943		
	33½	66	Adj.	198	25	FLV3466PAHD		\$6,171	\$6,789
	33½	60	Adj.	191	24	FLT3460PAHD	\$4,918		
	33½	60	Adj.	191	24	FLV3460PAHD		\$6,136	\$6,747

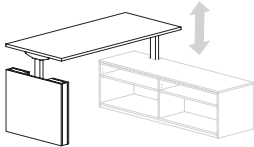
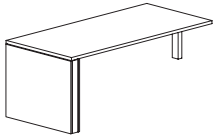

in application

Features:

- must be used with 96", 72" and 36" wide secondary height peninsula mount credenzas
- 29" to 47" height adjustment with digital controller, wire guide and 10' power cord
- maximum weight rating 140 lbs. (evenly distributed load)

Options:

- must specify chassis grain direction on artisan veneer, see pages 13-15 for details
- reverse bevel edge available on approach and user sides, specify; add \$474 list for laminate or \$186 list for veneer; see page 8 for details
- 13½" h modesty panel available, specify; add \$474 list for laminate or \$656 list for veneer; see page 21 for details
- top grommet available, specify location; add \$142 list each; see page 49 for details
- worksurface power available, specify "to accommodate EC26" on your purchase order; EC26 unit must be ordered separately, see page 49

Box/Lateral File Storage Credenza with Peninsula Desk Mount	22	96	21	306	32	FLT2296-21FM60	\$3,220		
	22	96	21	306	32	FLV2296-21FM60		\$4,315	\$4,744
	22	96	21	306	32	FLT2296-21F06M	\$3,220		
	22	96	21	306	32	FLV2296-21F06M		\$4,315	\$4,744

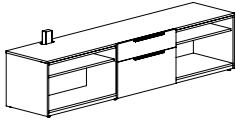

*M60 shown

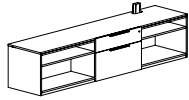

*O6M

Features:

- must be used with 33" deep adjustable height modular peninsula desk
- desk lift column can only be mounted in sections with an open compartment, see page 39 for details
- open compartments with adjustable shelves

Options:

- must specify chassis grain direction on artisan veneer, see pages 13-15 for details
- veneer drawer fronts in paint available, specify paint color; add \$372 list; see page 16 for details
- on laminate units, contrasting worksurface tops and drawer fronts available, no upcharge; specify laminate color, see page 16 for details
- ledge pulls standard; prism pulls available, specify and see page 9
- oval grommets in back panels can be eliminated upon request, no upcharge
- concealed box drawer(s) available, specify location in unit; add \$259 list for each laminate drawer or \$394 list for each veneer drawer, see page 25 for details
- seat cushion available, see page 25 for more details and page 212 for pricing
- top grommet available, specify location; add \$142 list each; see page 46 for details
- interior wire manager from side to side in upper back, specify and add \$126 list; see page 17 for details

Box/Lateral File Storage Credenza with Peninsula Desk Mount	22	96	21	341	32	FLT2296-21FM66	\$3,453		
	22	96	21	341	32	FLV2296-21FM66		\$4,627	\$5,090
	22	96	21	341	32	FLT2296-21F66M	\$3,453		
	22	96	21	341	32	FLV2296-21F66M		\$4,627	\$5,090

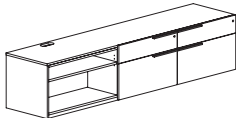

*M66 shown

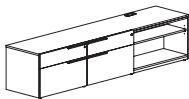

*66M

Features:

- must be used with 33" deep adjustable height modular peninsula desk
- desk lift column can only be mounted in sections with an open compartment, see page 39 for details
- open compartment with adjustable shelf

Options:

- must specify chassis grain direction on artisan veneer, see pages 13-15 for details
- veneer drawer fronts in paint available, specify paint color; add \$372 list; see page 16 for details
- on laminate units, contrasting worksurface tops and drawer fronts available, no upcharge; specify laminate color, see page 16 for details
- ledge pulls standard; prism pulls available, specify and see page 9
- oval grommets in back panels can be eliminated upon request, no upcharge
- concealed box drawer(s) available, specify location in unit; add \$259 list for each laminate drawer or \$394 list for each veneer drawer, see page 25 for details
- seat cushion available, see page 25 for more details and page 212 for pricing
- top grommet available, specify location; add \$142 list each; see page 47 for details
- interior wire manager from side to side in upper back, specify and add \$126 list; see page 17 for details

Description	D	W	H	CTN WT	CU FT	① Model	HPL Laminate	Essentials Veneer	Artisan Veneer
Box/Lateral File Storage	22	72	21	267	24	FLT2272-21FM6	\$2,873		
Credenza with Peninsula Desk Mount	22	72	21	267	24	FLV2272-21FM6		\$3,849	\$4,231
	22	72	21	267	24	FLT2272-21F6M	\$2,873		
	22	72	21	267	24	FLV2272-21F6M		\$3,849	\$4,231

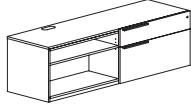

*M6 shown

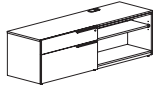

*6M

Features:

- must be used with 33" deep adjustable height modular peninsula desk
- desk lift column can only be mounted in sections with an open compartment, see page 39 for details
- open compartment with adjustable shelf

Options:

- must specify chassis grain direction on artisan veneer, see pages 13-15 for details
- veneer drawer fronts in paint available, specify paint color; add \$372 list; see page 16 for details
- on laminate units, contrasting worksurface tops and drawer fronts available, no upcharge; specify laminate color, see page 16 for details
- ledge pulls standard; prism pulls available, specify and see page 9
- oval grommets in back panels can be eliminated upon request, no upcharge
- concealed box drawer(s) available, specify location in unit; add \$259 list for each laminate drawer or \$394 list for each open compartment, see page 25 for details
- seat cushion available, see page 25 for more details and page 212 for pricing
- top grommet available, specify location; add \$142 list each; see page 47 for details
- interior wire manager from side to side in upper back, specify and add \$126 list; see page 17 for details

Sliding Door Credenza with Peninsula Desk Mount	22	72	21	225	24	FLT2272-21FM9	\$3,171		
	22	72	21	225	24	FLV2272-21FM9		\$4,250	\$4,677
	22	72	21	225	24	FLT2272-21F9M	\$3,171		
	22	72	21	225	24	FLV2272-21F9M		\$4,250	\$4,677

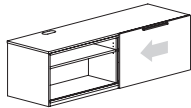

*M9 shown

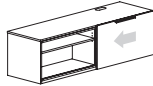
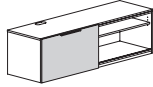

*9M

Features:

- must be used with 33" deep adjustable height modular peninsula desk
- desk lift column can only be mounted in sections with an open compartment, see page 39 for details
- each compartment has one adjustable shelf

Options:

- must specify chassis grain direction on artisan veneer, see pages 13-15 for details
- veneer door fronts in paint available, specify paint color; add \$372 list; see page 16 for details
- on laminate units, contrasting worksurface tops and drawer fronts available, no upcharge; specify laminate color, see page 16 for details
- ledge pulls standard; prism pulls available, specify and see page 9
- oval grommets in back panels can be eliminated upon request, no upcharge
- seat cushion available, see page 25 for more details and page 212 for pricing
- top grommet available, specify location; add \$142 list each; see page 47 for details
- interior wire manager from side to side in upper back, specify and add \$126 list; see page 17 for details

To Order, Specify:

① Laminate Model #	② Laminate Type	③ Laminate Selection	④ Metal Color	⑤ Other Product Options		
Laminate (FLT)	HPL	See Laminate Selection	See Metal Finish Color Options	See list of options for each specific unit; Specify and add accordingly.		
① Veneer Model #	② Wood Collection	③ Wood Finish	④ Metal Color	⑤ Other Product Options		
Veneer (FLV)	Essentials	See Essentials Wood Finish Options	See Metal Finish Color Options	See list of options for each specific unit; Specify and add accordingly.		
	Artisan	<table border="1"> <tr> <th>ⓐ Wood Finish</th> <th>ⓑ Chassis Grain Direction</th> </tr> <tr> <td>See Artisan Wood Finish Options</td> <td>For Artisan Only: Vertical Horizontal</td> </tr> </table>	ⓐ Wood Finish		ⓑ Chassis Grain Direction	See Artisan Wood Finish Options
ⓐ Wood Finish	ⓑ Chassis Grain Direction					
See Artisan Wood Finish Options	For Artisan Only: Vertical Horizontal					

Description	D	W	H	CTN WT	CU FT	① Model	HPL Laminate	Essentials Veneer	Artisan Veneer
Open Compartment Storage	22	96	21	266	32	FLT2296-21FM00	\$2,823		
Credenza with Peninsula	22	96	21	266	32	FLV2296-21FM00		\$3,973	\$4,371
Desk Mount	22	96	21	266	32	FLT2296-21F00M	\$2,823		
	22	96	21	266	32	FLV2296-21F00M		\$3,973	\$4,371

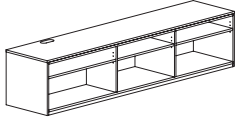

*M00 shown

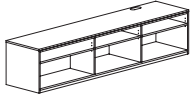

*O0M

Features:

- must be used with 33" deep adjustable height modular peninsula desk
- square edge on top
- each compartment has one adjustable shelf

Options:

- must specify chassis grain direction on artisan veneer, see pages 13-15 for details
- oval grommets in back panels can be eliminated upon request, no upcharge
- seat cushion available, see page 25 for more details and page 212 for pricing
- top grommet available, specify location; add \$142 list each; see page 47 for details
- interior wire manager from side to side in upper back, specify and add \$126 list; see page 17 for details

Open Compartment Storage	22	72	21	204	24	FLT2272-21FM0	\$2,497		
Credenza with Peninsula Desk	22	72	21	204	24	FLV2272-21FM0		\$3,518	\$3,870
Mount	22	72	21	204	24	FLT2272-21F0M	\$2,497		
	22	72	21	204	24	FLV2272-21F0M		\$3,518	\$3,870

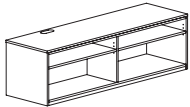

*M0 shown

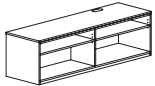

*OM

Features:

- must be used with 33" deep adjustable height modular peninsula desk
- square edge on top
- each compartment has one adjustable shelf

Options:

- must specify chassis grain direction on artisan veneer, see pages 13-15 for details
- oval grommets in back panels can be eliminated upon request, no upcharge
- seat cushion available, see page 25 for more details and page 212 for pricing
- top grommet available, specify location; add \$142 list each; see page 47 for details
- interior wire manager from side to side in upper back, specify and add \$126 list; see page 17 for details

FLUX

Description	D	W	H	CTN WT	CU FT	① Model	HPL Laminate	Essentials Veneer	Artisan Veneer
Open Compartment Storage Pedestal with Peninsula Desk Mount	22	36	21	111	13	FLT2236-21FMR	\$1,906		
	22	36	21	111	13	FLV2236-21FMR		\$2,680	\$2,950
	22	36	21	111	13	FLT2236-21FML	\$1,906		
	22	36	21	111	13	FLV2236-21FML		\$2,680	\$2,950



*MR shown



*ML

Features:

- must be used with 33" deep adjustable height modular peninsula desk
- square edge on top
- open compartment with adjustable shelf

Options:

- must specify chassis grain direction on artisan veneer, see pages 13-15 for details
- oval grommets in back panels can be eliminated upon request, no upcharge
- seat cushion available, see page 25 for more details and page 212 for pricing
- interior wire manager from side to side in upper back, specify and add \$126 list; see page 17 for details

FLUX

To Order, Specify:

① Laminate Model #	② Laminate Type	③ Laminate Selection	④ Metal Color	⑤ Other Product Options	
Laminate (FLT)	HPL	See Laminate Selection	See Metal Finish Color Options	See list of options for each specific unit; Specify and add accordingly.	
① Veneer Model #	② Wood Collection	③ Wood Finish	④ Metal Color	⑤ Other Product Options	
Veneer (FLV)	Essentials	See Essentials Wood Finish Options	See Metal Finish Color Options	See list of options for each specific unit; Specify and add accordingly.	
	Artisan	<table border="1"> <thead> <tr> <th>③a Wood Finish</th> <th>③b Chassis Grain Direction</th> </tr> </thead> <tbody> <tr> <td>See Artisan Wood Finish Options</td> <td>For Artisan Only: Vertical Horizontal</td> </tr> </tbody> </table>			③a Wood Finish
③a Wood Finish	③b Chassis Grain Direction				
See Artisan Wood Finish Options	For Artisan Only: Vertical Horizontal				

Description	D	W	H	CTN WT	CU FT	① Model	HPL Laminate	Essentials Veneer	Artisan Veneer
27" Adjustable Height Modular Peninsula Desk	27½	72	Adj.	182	21	FLT2872PAHD	\$4,728		
	27½	72	Adj.	182	21	FLV2872PAHD		\$5,982	\$6,582
	27½	66	Adj.	176	19	FLT2866PAHD	\$4,700		
	27½	66	Adj.	176	19	FLV2866PAHD		\$5,945	\$6,538
	27½	60	Adj.	170	19	FLT2860PAHD	\$4,672		
	27½	60	Adj.	170	19	FLV2860PAHD		\$5,905	\$6,496

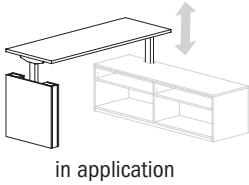
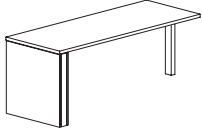

Features:

- must be used with 90", 60" and 30" wide secondary height peninsula mount credenzas
- 29" to 47" height adjustment with digital controller, wire guide and 10' power cord
- maximum weight rating 140 lbs. (evenly distributed load)

Options:

- must specify support panels grain direction on artisan veneer, see pages 13-15 for details
- reverse bevel edge available on approach and user sides, specify; add \$474 list for laminate or \$186 list for veneer; see page 8 for details
- 13½" h modesty panel available, specify; add \$474 list for laminate or \$656 list for veneer; see page 21 for details
- top grommet available, specify location; add \$142 list each; see page 49 for details
- worksurface power available, specify "to accommodate EC26" on your purchase order; EC26 unit must be ordered separately, see page 49

Box/Lateral File Storage Credenza with Peninsula Desk Mount	22	90	21	278	30	FLT2290-21FM60	\$3,125		
	22	90	21	278	30	FLV2290-21FM60		\$4,186	\$4,606
	22	90	21	278	30	FLT2290-21F06M	\$3,125		
	22	90	21	278	30	FLV2290-21F06M		\$4,186	\$4,606

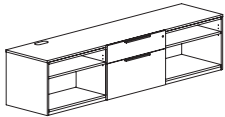

*M60 shown

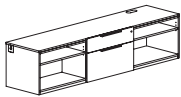

*06M

Features:

- must be used with 27" deep adjustable height modular peninsula desk
- desk lift column can only be mounted in sections with an open compartment, see page 39 for details
- open compartment with adjustable shelf

Options:

- must specify chassis grain direction on artisan veneer, see pages 13-15 for details
- veneer drawer fronts in paint available, specify paint color; add \$372 list; see page 16 for details
- on laminate units, contrasting worksurface tops and drawer fronts available, no upcharge; specify laminate color, see page 16 for details
- ledge pulls standard; prism pulls available, specify and see page 9
- oval grommets in back panels can be eliminated upon request, no upcharge
- concealed box drawer(s) available, specify location in unit; add \$259 list for each laminate drawer or \$394 list for each veneer drawer, see page 25 for details
- seat cushion available, see page 25 for more details and page 212 for pricing
- top grommet available, specify location; add \$142 list each; see page 47 for details
- interior wire manager from side to side in upper back, specify and add \$126 list; see page 17 for details

FLUX

Description	D	W	H	CTN WT	CU FT	① Model	HPL Laminate	Essentials Veneer	Artisan Veneer
Box/Lateral File Storage	22	90	21	313	30	FLT2290-21FM66	\$3,305		
Credenza with Peninsula Desk Mount	22	90	21	313	30	FLV2290-21FM66		\$4,491	\$4,942
	22	90	21	313	30	FLT2290-21F66M	\$3,305		
	22	90	21	313	30	FLV2290-21F66M		\$4,491	\$4,942

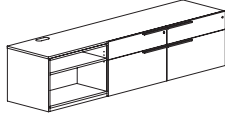

*M66 shown

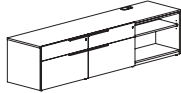

*66M

Features:

- must be used with 27" deep adjustable height modular peninsula desk
- desk lift column can only be mounted in sections with an open compartment, see page 39 for details
- open compartment with adjustable shelf

Options:

- must specify chassis grain direction on artisan veneer, see pages 13-15 for details
- veneer drawer fronts in paint available, specify paint color; add \$372 list; see page 16 for details
- on laminate units, contrasting worksurface tops and drawer fronts available, no upcharge; specify laminate color, see page 16 for details
- ledge pulls standard; prism pulls available, specify and see page 9
- oval grommets in back panels can be eliminated upon request, no upcharge
- concealed box drawer(s) available, specify location in unit; add \$259 list for each laminate drawer or \$394 list for each veneer drawer, see page 25 for details
- seat cushion available, see page 25 for more details and page 212 for pricing
- top grommet available, specify location; add \$142 list each; see page 47 for details
- interior wire manager from side to side in upper back, specify and add \$126 list; see page 17 for details

Box/Lateral File Storage	22	60	21	239	21	FLT2260-21FM6	\$2,708		
Credenza with Peninsula Desk Mount	22	60	21	239	21	FLV2260-21FM6		\$3,629	\$3,992
	22	60	21	239	21	FLT2260-21F6M	\$2,708		
	22	60	21	239	21	FLV2260-21F6M		\$3,629	\$3,992

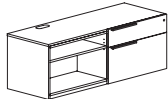

*M6 shown

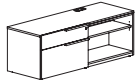

*6M

Features:

- must be used with 27" deep adjustable height modular peninsula desk
- desk lift column can only be mounted in sections with an open compartment, see page 39 for details
- open compartment with adjustable shelf

Options:

- must specify chassis grain direction on artisan veneer, see pages 13-15 for details
- veneer drawer fronts in paint available, specify paint color; add \$372 list; see page 16 for details
- on laminate units, contrasting worksurface tops and drawer fronts available, no upcharge; specify laminate color, see page 16 for details
- ledge pulls standard; prism pulls available, specify and see page 9
- oval grommets in back panels can be eliminated upon request, no upcharge
- concealed box drawer(s) available, specify location in unit; add \$259 list for each laminate drawer or \$394 list for each veneer drawer, see page 25 for details
- seat cushion available, see page 25 for more details and page 212 for pricing
- top grommet available, specify location; add \$142 list each; see page 47 for details
- interior wire manager from side to side in upper back, specify and add \$126 list; see page 17 for details

To Order, Specify:

① Laminate Model #	② Laminate Type	③ Laminate Selection	④ Metal Color	⑤ Other Product Options		
Laminate (FLT)	HPL	See Laminate Selection	See Metal Finish Color Options	See list of options for each specific unit; Specify and add accordingly.		
① Veneer Model #	② Wood Collection	③ Wood Finish	④ Metal Color	⑤ Other Product Options		
Veneer (FLV)	Essentials	See Essentials Wood Finish Options	See Metal Finish Color Options	See list of options for each specific unit; Specify and add accordingly.		
	Artisan	<table border="1"> <tr> <th>ⓐ Wood Finish</th> <th>ⓑ Chassis Grain Direction</th> </tr> <tr> <td>See Artisan Wood Finish Options</td> <td>For Artisan Only: Vertical Horizontal</td> </tr> </table>	ⓐ Wood Finish		ⓑ Chassis Grain Direction	See Artisan Wood Finish Options
ⓐ Wood Finish	ⓑ Chassis Grain Direction					
See Artisan Wood Finish Options	For Artisan Only: Vertical Horizontal					

Description	D	W	H	CTN WT	CU FT	① Model	HPL Laminate	Essentials Veneer	Artisan Veneer
Sliding Door Credenza with Peninsula Desk Mount	22	90	21	276	31	FLT2290-21FM99	\$2,994		
	22	90	21	276	31	FLV2290-21FM99		\$4,010	\$4,413
	22	90	21	276	31	FLT2290-21F99M	\$2,994		
	22	90	21	276	31	FLV2290-21F99M		\$4,010	\$4,413

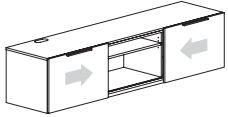

*M99 shown

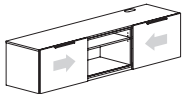
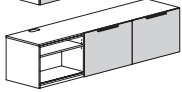
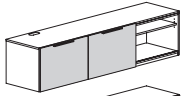

*99M

Features:

- must be used with 27" deep adjustable height modular peninsula desk
- desk lift column can only be mounted in sections with an open compartment, see page 39 for details
- each compartment has one adjustable shelf

Options:

- must specify chassis grain direction on artisan veneer, see pages 13-15 for details
- veneer door fronts in paint available, specify paint color; add \$372 list; see page 16 for details
- on laminate units, contrasting worksurface tops and drawer fronts available, no upcharge; specify laminate color, see page 16 for details
- ledge pulls standard; prism pulls available, specify and see page 9
- oval grommets in back panels can be eliminated upon request, no upcharge
- seat cushion available, see page 25 for more details and page 212 for pricing
- top grommet available, specify location; add \$142 list each; see page 47 for details
- interior wire manager from side to side in upper back, specify and add \$126 list; see page 17 for details

Sliding Door Credenza with Peninsula Desk Mount	22	90	21	259	31	FLT2290-21FM90	\$2,880		
	22	90	21	259	31	FLV2290-21FM90		\$3,858	\$4,242
	22	90	21	259	31	FLT2290-21F09M	\$2,880		
	22	90	21	259	31	FLV2290-21F09M		\$3,858	\$4,242

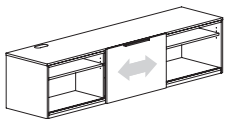

*M90 shown

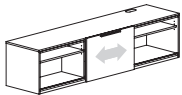
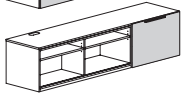
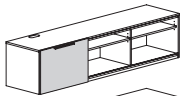

*09M

Features:

- must be used with 27" deep adjustable height modular peninsula desk
- desk lift column can only be mounted in sections with an open compartment, see page 39 for details
- each compartment has one adjustable shelf

Options:

- must specify chassis grain direction on artisan veneer, see pages 13-15 for details
- veneer door fronts in paint available, specify paint color; add \$372 list; see page 16 for details
- on laminate units, contrasting worksurface tops and drawer fronts available, no upcharge; specify laminate color, see page 16 for details
- ledge pulls standard; prism pulls available, specify and see page 9
- oval grommets in back panels can be eliminated upon request, no upcharge
- seat cushion available, see page 25 for more details and page 212 for pricing
- top grommet available, specify location; add \$142 list each; see page 47 for details
- interior wire manager from side to side in upper back, specify and add \$126 list; see page 17 for details

FLUX

Description	D	W	H	CTN WT	CU FT	① Model	HPL Laminate	Essentials Veneer	Artisan Veneer
Sliding Door Credenza with Peninsula Desk Mount	22	60	21	185	21	FLT2260-21FM9	\$2,475		
	22	60	21	185	21	FLV2260-21FM9		\$3,317	\$3,649
	22	60	21	185	21	FLT2260-21F9M	\$2,475		
	22	60	21	185	21	FLV2260-21F9M		\$3,317	\$3,649

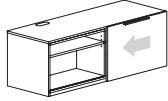

*M9 shown

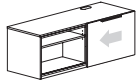
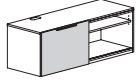

*9M

Features:

- must be used with 27" deep adjustable height modular peninsula desk
- desk lift column can only be mounted in sections with an open compartment, see page 39 for details
- each compartment has one adjustable shelf

Options:

- must specify chassis grain direction on artisan veneer, see pages 13-15 for details
- veneer door fronts in paint available, specify paint color; add \$372 list; see page 16 for details
- on laminate units, contrasting worksurface tops and drawer fronts available, no upcharge; specify laminate color, see page 16 for details
- ledge pulls standard; prism pulls available, specify and see page 9
- oval grommets in back panels can be eliminated upon request, no upcharge
- seat cushion available, see page 25 for more details and page 212 for pricing
- top grommet available, specify location; add \$142 list each; see page 47 for details
- interior wire manager from side to side in upper back, specify and add \$126 list; see page 17 for details

FLUX

To Order, Specify:

① Laminate Model #	② Laminate Type	③ Laminate Selection	④ Metal Color	⑤ Other Product Options		
Laminate (FLT)	HPL	See Laminate Selection	See Metal Finish Color Options	See list of options for each specific unit; Specify and add accordingly.		
① Veneer Model #	② Wood Collection	③ Wood Finish	④ Metal Color	⑤ Other Product Options		
Veneer (FLV)	Essentials	See Essentials Wood Finish Options	See Metal Finish Color Options	See list of options for each specific unit; Specify and add accordingly.		
	Artisan	<table border="1"> <thead> <tr> <th>③a Wood Finish</th> <th>③b Chassis Grain Direction</th> </tr> </thead> <tbody> <tr> <td>See Artisan Wood Finish Options</td> <td>For Artisan Only: Vertical Horizontal</td> </tr> </tbody> </table>	③a Wood Finish		③b Chassis Grain Direction	See Artisan Wood Finish Options
③a Wood Finish	③b Chassis Grain Direction					
See Artisan Wood Finish Options	For Artisan Only: Vertical Horizontal					

Description	D	W	H	CTN WT	CU FT	① Model	HPL Laminate	Essentials Veneer	Artisan Veneer
Open Compartment Storage	22	90	21	238	30	FLT2290-21FM00	\$2,414		
Credenza with Peninsula	22	90	21	238	30	FLV2290-21FM00		\$3,399	\$3,737
Desk Mount	22	90	21	238	30	FLT2290-21F00M	\$2,414		
	22	90	21	238	30	FLV2290-21F00M		\$3,399	\$3,737

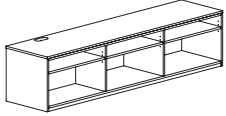

*M00 shown

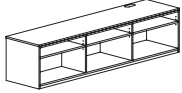

*O0M

Features:

- must be used with 27" deep adjustable height modular peninsula desk
- square edge on top
- each compartment has one adjustable shelf

Options:

- must specify chassis grain direction on artisan veneer, see pages 13-15 for details
- oval grommets in back panels can be eliminated upon request, no upcharge
- seat cushion available, see page 25 for more details and page 212 for pricing
- top grommet available, specify location; add \$142 list each; see page 47 for details
- interior wire manager from side to side in upper back, specify and add \$126 list; see page 17 for details

Open Compartment Storage	22	60	21	176	21	FLT2260-21FM0	\$2,078		
Credenza with Peninsula	22	60	21	176	21	FLV2260-21FM0		\$2,923	\$3,213
Desk Mount	22	60	21	176	21	FLT2260-21F0M	\$2,078		
	22	60	21	176	21	FLV2260-21F0M		\$2,923	\$3,213

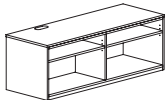

*M0

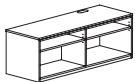

*OM

Features:

- must be used with 27" deep adjustable height modular peninsula desk
- square edge on top
- each compartment has one adjustable shelf

Options:

- must specify chassis grain direction on artisan veneer, see pages 13-15 for details
- oval grommets in back panels can be eliminated upon request, no upcharge
- seat cushion available, see page 25 for more details and page 212 for pricing
- top grommet available, specify location; add \$142 list each; see page 47 for details
- interior wire manager from side to side in upper back, specify and add \$126 list; see page 17 for details

FLUX

Description	D	W	H	CTN WT	CU FT	① Model	HPL Laminate	Essentials Veneer	Artisan Veneer
Open Compartment Storage	22	30	21	83	11	FLT2230-21FMR	\$1,833		
Pedestal with Peninsula Desk	22	30	21	83	11	FLV2230-21FMR		\$2,574	\$2,833
Mount	22	30	21	83	11	FLT2230-21FML	\$1,833		
	22	30	21	83	11	FLV2230-21FML		\$2,574	\$2,833

*MR shown



*ML

Features:

- must be used with 27" deep adjustable height modular peninsula desk
- square edge on top
- open compartment with adjustable shelf

Options:

- must specify chassis grain direction on artisan veneer, see pages 13-15 for details
- oval grommets in back panels can be eliminated upon request, no upcharge
- interior wire manager from side to side in upper back, specify and add \$126 list; see page 17 for details

FLUX

To Order, Specify:

① Laminate Model #	② Laminate Type	③ Laminate Selection		④ Metal Color	⑤ Other Product Options
Laminate (FLT)	HPL	See Laminate Selection		See Metal Finish Color Options	See list of options for each specific unit; Specify and add accordingly.
① Veneer Model #	② Wood Collection	③ Wood Finish		④ Metal Color	⑤ Other Product Options
Veneer (FLV)	Essentials	See Essentials Wood Finish Options		See Metal Finish Color Options	See list of options for each specific unit; Specify and add accordingly.
	Artisan	See Artisan Wood Finish Options	④b Chassis Grain Direction		
			For Artisan Only: Vertical Horizontal		

Description	D	W	H	CTN WT	CU FT	① Model	HPL Laminate	Essentials Veneer	Artisan Veneer
Square Pneumatic Adjustable Height Table 	30	30	Adj.	42	19	FLT3030SAT4B	\$2,083		
	30	30	Adj.	42	19	FLV3030SAT4B		\$2,570	\$2,827
	24	24	Adj.	34	13	FLT2424SAT4B	\$2,041		
	24	24	Adj.	34	13	FLV2424SAT4B		\$2,517	\$2,770

Features:

- ¾" top with flat edge
- 4-star cast aluminum base
- 26" to 38" height adjustment, casters increase heights by 2"
- release lever mounts under edge of top
- 15 lbs. lift force, maximum weight rating 75 lbs. (evenly distributed load)

Options:

- casters available, four locking, specify and add \$109 list

Round Pneumatic Adjustable Height Table 	36	36	Adj.	46	27	FLT3636RAT4B	\$2,123		
	36	36	Adj.	46	27	FLV3636RAT4B		\$2,622	\$2,885
	30	30	Adj.	39	19	FLT3030RAT4B	\$2,083		
	30	30	Adj.	39	19	FLV3030RAT4B		\$2,570	\$2,827

Features:

- ¾" top with flat edge
- 4-star cast aluminum base
- 26" to 38" height adjustment, casters increase heights by 2"
- release lever mounts under edge of top
- 15 lbs. lift force, maximum weight rating 75 lbs. (evenly distributed load)

Options:

- casters available, four locking, specify and add \$109 list

FLUX

Description	D	W	H	CTN WT	CU FT	① Model	HPL Laminate	Essentials Veneer	Artisan Veneer
Oval Pneumatic Adjustable	26	36	Adj.	42	20	FLT26360AT4B	\$2,166		
Height Table	26	36	Adj.	42	20	FLV26360AT4B		\$2,676	\$2,944



Features:

- ¾" top with flat edge
- 4-star cast aluminum base
- 26" to 38" height adjustment, casters increase heights by 2"
- release lever mounts under edge of top
- 15 lbs. lift force, maximum weight rating 75 lbs. (evenly distributed load)



Options:

- casters available, four locking, specify and add \$109 list

FLUX



To Order, Specify:

① Laminate Model #	② Laminate Type	③ Laminate Selection	④ Metal Color	⑤ Other Product Options	
Laminate (FLT)	HPL	See Laminate Selection	See Metal Finish Color Options	See list of options for each specific unit; Specify and add accordingly.	
① Veneer Model #	② Wood Collection	③ Wood Finish	④ Metal Color	⑤ Other Product Options	
Veneer (FLV)	Essentials	See Essentials Wood Finish Options	See Metal Finish Color Options	See list of options for each specific unit; Specify and add accordingly.	
	Artisan	<table border="1"> <thead> <tr> <th>③a Wood Finish</th> <th>③b Chassis Grain Direction</th> </tr> </thead> <tbody> <tr> <td>See Artisan Wood Finish Options</td> <td>For Artisan Only: Vertical Horizontal</td> </tr> </tbody> </table>			③a Wood Finish
③a Wood Finish	③b Chassis Grain Direction				
See Artisan Wood Finish Options	For Artisan Only: Vertical Horizontal				

Description	D	W	H	CTN WT	CU FT	① Model	HPL Laminate	Essentials Veneer	Artisan Veneer
Modular Bow Front Desk Top  	36	84	1 3/16	103	7	FLT3684BMCT	\$1,688		
	36	84	1 3/16	103	7	FLV3684BMCT		\$2,610	\$2,872
	36	78	1 3/16	96	6	FLT3678BMCT	\$1,627		
	36	78	1 3/16	96	6	FLV3678BMCT		\$2,507	\$2,757
	36	72	1 3/16	89	6	FLT3672BMCT	\$1,565		
	36	72	1 3/16	89	6	FLV3672BMCT		\$2,407	\$2,646
	36	66	1 3/16	82	5	FLT3666BMCT	\$1,546		
	36	66	1 3/16	82	5	FLV3666BMCT		\$2,371	\$2,610
	36	60	1 3/16	75	5	FLT3660BMCT	\$1,520		
	36	60	1 3/16	75	5	FLV3660BMCT		\$2,335	\$2,570

Features:

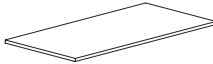
- eased edge profile on approach and user sides

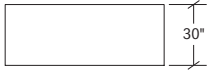
Description	D	W	H	CTN WT	CU FT	① Model	HPL Laminate	Essentials Veneer	Artisan Veneer
Modular Rectangular Desk Top    	36	84	1 3/16	101	7	FLT3684MCT	\$1,248		
	36	84	1 3/16	101	7	FLV3684MCT		\$1,972	\$2,173
	36	78	1 3/16	94	6	FLT3678MCT	\$1,160		
	36	78	1 3/16	94	6	FLV3678MCT		\$1,835	\$2,016
	36	72	1 3/16	87	6	FLT3672MCT	\$1,070		
	36	72	1 3/16	87	6	FLV3672MCT		\$1,693	\$1,864
	36	66	1 3/16	80	5	FLT3666MCT	\$983		
	36	66	1 3/16	80	5	FLV3666MCT		\$1,552	\$1,708
	36	60	1 3/16	73	5	FLT3660MCT	\$894		
	36	60	1 3/16	73	5	FLV3660MCT		\$1,414	\$1,554
	30	84	1 3/16	85	6	FLT3084MCT	\$1,043		
	30	84	1 3/16	85	6	FLV3084MCT		\$1,646	\$1,809
	30	78	1 3/16	79	5	FLT3078MCT	\$968		
	30	78	1 3/16	79	5	FLV3078MCT		\$1,527	\$1,683
	30	72	1 3/16	73	5	FLT3072MCT	\$894		
	30	72	1 3/16	73	5	FLV3072MCT		\$1,414	\$1,554
	30	66	1 3/16	68	5	FLT3066MCT	\$819		
	30	66	1 3/16	68	5	FLV3066MCT		\$1,295	\$1,425
	30	60	1 3/16	62	4	FLT3060MCT	\$745		
	30	60	1 3/16	62	4	FLV3060MCT		\$1,179	\$1,296

· eased edge profile on approach and user sides

FLUX

To Order, Specify:

① Laminate Model #	② Laminate Type	③ Laminate Selection	④ Metal Color	⑤ Other Product Options		
Laminate (FLT)	HPL	See Laminate Selection	See Metal Finish Color Options	See list of options for each specific unit; Specify and add accordingly.		
① Veneer Model #	② Wood Collection	③ Wood Finish	④ Metal Color	⑤ Other Product Options		
Veneer (FLV)	Essentials	See Essentials Wood Finish Options	See Metal Finish Color Options	See list of options for each specific unit; Specify and add accordingly.		
	Artisan	<table border="1"> <thead> <tr> <th>ⓐ Wood Finish</th> <th>ⓑ Chassis Grain Direction</th> </tr> </thead> <tbody> <tr> <td>See Artisan Wood Finish Options</td> <td>For Artisan Only: Vertical Horizontal</td> </tr> </tbody> </table>	ⓐ Wood Finish		ⓑ Chassis Grain Direction	See Artisan Wood Finish Options
ⓐ Wood Finish	ⓑ Chassis Grain Direction					
See Artisan Wood Finish Options	For Artisan Only: Vertical Horizontal					

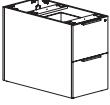
Description	D	W	H	CTN WT	CU FT	① Model	HPL Laminate	Essentials Veneer	Artisan Veneer
	36	18	28	110	14	FLT3618-29FM2	\$1,310		
	36	18	28	110	14	FLV3618-29FM2		\$1,968	\$2,163
	36	15%	28	100	12	FLT3616-29FM2	\$1,290		
	36	15%	28	100	12	FLV3616-29FM2		\$1,938	\$2,132
	30	18	28	97	12	FLT3018-29FM2	\$1,273		
	30	18	28	97	12	FLV3018-29FM2		\$1,911	\$2,103
	30	15%	28	90	10	FLT3016-29FM2	\$1,252		
	30	15%	28	90	10	FLV3016-29FM2		\$1,882	\$2,070

Features:

- use with other modular components, requires a modular top, see page 39
- pedestal front locking

Options:

- must specify chassis grain direction on artisan veneer, see pages 13-15 for details
- veneer drawer fronts in paint available, specify paint color and add \$372 list; see page 16 for details
- on laminate units, contrasting fronts available, no upcharge; specify color, see page 16 for details
- ledge pulls standard; prism pulls available, specify and see page 9

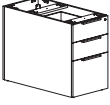
Description	D	W	H	CTN WT	CU FT	① Model	HPL Laminate	Essentials Veneer	Artisan Veneer
	36	18	28	114	14	FLT3618-29FM1	\$1,316		
	36	18	28	114	14	FLV3618-29FM1		\$1,978	\$2,175
	36	15%	28	104	12	FLT3616-29FM1	\$1,297		
	36	15%	28	104	12	FLV3616-29FM1		\$1,948	\$2,142
	30	18	28	102	12	FLT3018-29FM1	\$1,278		
	30	18	28	102	12	FLV3018-29FM1		\$1,919	\$2,112
	30	15%	28	95	10	FLT3016-29FM1	\$1,259		
	30	15%	28	95	10	FLV3016-29FM1		\$1,890	\$2,081

Features:

- use with other modular components, requires a modular top, see page 39
- pedestal front locking

Options:

- must specify chassis grain direction on artisan veneer, see pages 13-15 for details
- veneer drawer fronts in paint available, specify paint color and add \$372 list; see page 16 for details
- on laminate units, contrasting fronts available, no upcharge; specify color, see page 16 for details
- ledge pulls standard; prism pulls available, specify and see page 9

FLUX

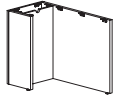

Description	D	W	H	CTN WT	CU FT	① Model	HPL Laminate	Essentials Veneer	Artisan Veneer
 left shown  right	36	18	28	74	14	FLT3618WEAR	\$961		
	36	18	28	74	14	FLV3618WEAR		\$1,441	\$1,586
	36	18	28	74	14	FLT3618WEAL	\$961		
	36	18	28	74	14	FLV3618WEAL		\$1,441	\$1,586
	36	15 3/8	28	71	12	FLT3616WEAR	\$945		
	36	15 3/8	28	71	12	FLV3616WEAR		\$1,423	\$1,563
	36	15 3/8	28	71	12	FLT3616WEAL	\$945		
	36	15 3/8	28	71	12	FLV3616WEAL		\$1,423	\$1,563

Features:

- use with other modular components, requires a modular top, see page 39

Options:

- must specify chassis grain direction on artisan veneer, see pages 13-15 for details

Description	D	W	H	CTN WT	CU FT	① Model	HPL Laminate	Essentials Veneer	Artisan Veneer
 left shown  right	30	18	28	68	12	FLT3018WEAR	\$942		
	30	18	28	68	12	FLV3018WEAR		\$1,416	\$1,557
	30	18	28	68	12	FLT3018WEAL	\$942		
	30	18	28	68	12	FLV3018WEAL		\$1,416	\$1,557
	30	15 3/8	28	65	10	FLT3016WEAR	\$929		
	30	15 3/8	28	65	10	FLV3016WEAR		\$1,392	\$1,533
	30	15 3/8	28	65	10	FLT3016WEAL	\$929		
	30	15 3/8	28	65	10	FLV3016WEAL		\$1,392	\$1,533

Features:

- use with other modular components, requires a modular top, see page 39

Options:

- must specify chassis grain direction on artisan veneer, see pages 13-15 for details

To Order, Specify:

① Laminate Model #	② Laminate Type	③ Laminate Selection	④ Metal Color	⑤ Other Product Options
Laminate (FLT)	HPL	See Laminate Selection	See Metal Finish Color Options	See list of options for each specific unit; Specify and add accordingly.
① Veneer Model #	② Wood Collection	③ Wood Finish	④ Metal Color	⑤ Other Product Options
Veneer (FLV)	Essentials	See Essentials Wood Finish Options	See Metal Finish Color Options	See list of options for each specific unit; Specify and add accordingly.
	Artisan	ⓐ Wood Finish See Artisan Wood Finish Options	ⓑ Chassis Grain Direction For Artisan Only: Vertical Horizontal	

Description	D	W	H	CTN WT	CU FT	① Model	HPL Laminate	Essentials Veneer	Artisan Veneer
	7/8	48	28	34	3	FLT2848MDA	\$448		
	7/8	48	28	34	3	FLV2848MDA		\$668	\$735
	7/8	42	28	31	3	FLT2842MDA	\$388		
	7/8	42	28	31	3	FLV2842MDA		\$579	\$638
	7/8	36	28	27	2	FLT2836MDA	\$360		
	7/8	36	28	27	2	FLV2836MDA		\$537	\$592
	7/8	40 3/4	28	30	3	FLT2841MDA	\$383		
	7/8	40 3/4	28	30	3	FLV2841MDA		\$570	\$626
	7/8	34 3/4	28	27	2	FLT2835MDA	\$349		
	7/8	34 3/4	28	27	2	FLV2835MDA		\$521	\$574
	7/8	27 3/4	28	23	2	FLT2829MDA	\$348		
	7/8	27 3/4	28	23	2	FLV2829MDA		\$510	\$558

Features:

- use with other modular components, requires a modular top, see page 39

Options:

- must specify chassis grain direction on artisan veneer, see pages 13-15 for details

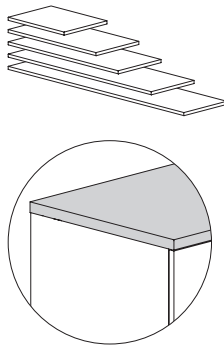
Description	D	W	H	CTN WT	CU FT	① Model	HPL Laminate	Essentials Veneer	Artisan Veneer
	22	108	1 3/16	80	5	FLT22108MCT	\$983		
	22	108	1 3/16	80	5	FLV22108MCT		\$1,552	\$1,708
	22	102	1 3/16	76	5	FLT22102MCT	\$929		
	22	102	1 3/16	76	5	FLV22102MCT		\$1,466	\$1,614
	22	96	1 3/16	72	5	FLT2296MCT	\$875		
	22	96	1 3/16	72	5	FLV2296MCT		\$1,380	\$1,517
	22	90	1 3/16	68	5	FLT2290MCT	\$819		
	22	90	1 3/16	68	5	FLV2290MCT		\$1,295	\$1,425
	22	84	1 3/16	64	4	FLT2284MCT	\$764		
	22	84	1 3/16	64	4	FLV2284MCT		\$1,208	\$1,330
	22	78	1 3/16	59	4	FLT2278MCT	\$712		
	22	78	1 3/16	59	4	FLV2278MCT		\$1,123	\$1,235
	22	72	1 3/16	55	4	FLT2272MCT	\$657		
	22	72	1 3/16	55	4	FLV2272MCT		\$1,034	\$1,141
	22	66	1 3/16	51	4	FLT2266MCT	\$602		
	22	66	1 3/16	51	4	FLV2266MCT		\$951	\$1,046
	22	60	1 3/16	47	3	FLT2260MCT	\$548		
	22	60	1 3/16	47	3	FLV2260MCT		\$865	\$951
	22	54	1 3/16	43	3	FLT2254MCT	\$495		
	22	54	1 3/16	43	3	FLV2254MCT		\$781	\$857
	22	48	1 3/16	39	3	FLT2248MCT	\$439		
	22	48	1 3/16	39	3	FLV2248MCT		\$692	\$761
	22	42	1 3/16	35	2	FLT2242MCT	\$386		
	22	42	1 3/16	35	2	FLV2242MCT		\$607	\$668
	22	36	1 3/16	30	2	FLT2236MCT	\$330		
	22	36	1 3/16	30	2	FLV2236MCT		\$520	\$573
	22	30	1 3/16	26	2	FLT2230MCT	\$276		
	22	30	1 3/16	26	2	FLV2230MCT		\$434	\$477
22	18	1 3/16	15	1	FLT2218MCT	\$247			
22	18	1 3/16	15	1	FLV2218MCT		\$357	\$393	

Features:

- use with primary height modular components
- eased edge profile user side

To Order, Specify:

① Laminate Model #	② Laminate Type	③ Laminate Selection	④ Metal Color	⑤ Other Product Options		
Laminate (FLT)	HPL	See Laminate Selection	See Metal Finish Color Options	See list of options for each specific unit; Specify and add accordingly.		
① Veneer Model #	② Wood Collection	③ Wood Finish	④ Metal Color	⑤ Other Product Options		
Veneer (FLV)	Essentials	See Essentials Wood Finish Options	See Metal Finish Color Options	See list of options for each specific unit; Specify and add accordingly.		
	Artisan	<table border="1"> <tr> <th>ⓐ Wood Finish</th> <th>ⓑ Chassis Grain Direction</th> </tr> <tr> <td>See Artisan Wood Finish Options</td> <td>For Artisan Only: Vertical Horizontal</td> </tr> </table>	ⓐ Wood Finish		ⓑ Chassis Grain Direction	See Artisan Wood Finish Options
ⓐ Wood Finish	ⓑ Chassis Grain Direction					
See Artisan Wood Finish Options	For Artisan Only: Vertical Horizontal					

Description	D	W	H	CTN WT	CU FT	① Model	HPL Laminate	Essentials Veneer	Artisan Veneer
Modular Return Top for Primary Height (short grain)	22	60	1 3/16	47	3	FLT6022MRT	\$571		
	22	60	1 3/16	47	3	FLV6022MRT		\$887	\$975
	22	54	1 3/16	43	3	FLT5422MRT	\$518		
	22	54	1 3/16	43	3	FLV5422MRT		\$803	\$879
	22	48	1 3/16	39	3	FLT4822MRT	\$464		
	22	48	1 3/16	39	3	FLV4822MRT		\$716	\$785
	22	42	1 3/16	32	4	FLT4222MRT	\$415		
	22	42	1 3/16	32	4	FLV4222MRT		\$639	\$704
	22	36	1 3/16	29	4	FLT3622MRT	\$374		
	22	36	1 3/16	29	4	FLV3622MRT		\$579	\$634

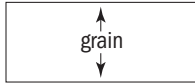
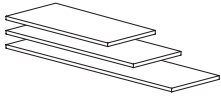

Features:

- use with primary height modular components
- eased edge profile user side
- grain patterns runs short
- mounting brackets included

Modular File/File Credenza Pedestal	22	18	28	87	9	FLT2218-29FM2	\$1,232		
	22	18	28	87	9	FLV2218-29FM2		\$1,847	\$2,035
	22	15 5/8	28	80	8	FLT2216-29FM2	\$1,218		
	22	15 5/8	28	80	8	FLV2216-29FM2		\$1,829	\$2,011



Features:

- use with other modular components, requires a modular top, see page 39
- pedestal front locking

Options:

- must specify chassis grain direction on artisan veneer, see pages 13-15 for details
- veneer drawer fronts in paint available, specify paint color and add \$372 list; see page 16 for details
- on laminate units, contrasting fronts available, no upcharge; specify color, see page 16 for details
- ledge pulls standard; prism pulls available, specify and see page 9

Modular Box/Box/File Credenza Pedestal	22	18	28	89	9	FLT2218-29FM1	\$1,238		
	22	18	28	89	9	FLV2218-29FM1		\$1,859	\$2,045
	22	15 5/8	28	82	8	FLT2216-29FM1	\$1,224		
	22	15 5/8	28	82	8	FLV2216-29FM1		\$1,837	\$2,019



Features:

- use with other modular components, requires a modular top, see page 39
- pedestal front locking

Options:

- must specify chassis grain direction on artisan veneer, see pages 13-15 for details
- veneer drawer fronts in paint available, specify paint color and add \$372 list; see page 16 for details
- on laminate units, contrasting fronts available, no upcharge; specify color, see page 16 for details
- ledge pulls standard; prism pulls available, specify and see page 9

Description	D	W	H	CTN WT	CU FT	① Model	HPL Laminate	Essentials Veneer	Artisan Veneer
Modular Hinge Door Storage Pedestal	22	18	28	74	9	FLT2218-29FM7R	\$762		
	22	18	28	74	9	FLV2218-29FM7R		\$1,145	\$1,259
	22	18	28	74	9	FLT2218-29FM7L	\$762		
	22	18	28	74	9	FLV2218-29FM7L		\$1,145	\$1,259
	22	15 3/8	28	68	8	FLT2216-29FM7R	\$749		
	22	15 3/8	28	68	8	FLV2216-29FM7R		\$1,123	\$1,235
	22	15 3/8	28	68	8	FLT2216-29FM7L	\$749		
	22	15 3/8	28	68	8	FLV2216-29FM7L		\$1,123	\$1,235

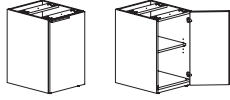

right shown

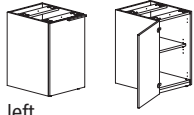

left

Features:

- use with other modular components, requires a modular top, see page 39
- hinged door compartment has one adjustable shelf

Options:

- must specify chassis grain direction on artisan veneer, see pages 13-15 for details
- locking doors available, specify and add \$153 list
- veneer door fronts in paint available, specify paint color and add \$372 list; see page 16 for details
- on laminate units, contrasting fronts available, no upcharge; specify color, see page 16 for details
- ledge pulls standard; prism pulls available, specify and see page 9
- pull out trash can available, specify, add \$503 list; see page 38 for details

Modular Open Compartment	22	18	28	66	13	FLT2218-29FM0	\$695		
	22	18	28	66	13	FLV2218-29FM0		\$1,043	\$1,147



Features:

- use with other modular components, requires a modular top, see page 39
- compartment has one adjustable shelf

Options:

- must specify chassis grain direction on artisan veneer, see pages 13-15 for details

To Order, Specify:

① Laminate Model #	② Laminate Type	③ Laminate Selection	④ Metal Color	⑤ Other Product Options		
Laminate (FLT)	HPL	See Laminate Selection	See Metal Finish Color Options	See list of options for each specific unit; Specify and add accordingly.		
① Veneer Model #	② Wood Collection	③ Wood Finish	④ Metal Color	⑤ Other Product Options		
Veneer (FLV)	Essentials	See Essentials Wood Finish Options	See Metal Finish Color Options	See list of options for each specific unit; Specify and add accordingly.		
	Artisan	<table border="1"> <thead> <tr> <th>③a Wood Finish</th> <th>③b Chassis Grain Direction</th> </tr> </thead> <tbody> <tr> <td>See Artisan Wood Finish Options</td> <td>For Artisan Only: Vertical Horizontal</td> </tr> </tbody> </table>	③a Wood Finish		③b Chassis Grain Direction	See Artisan Wood Finish Options
③a Wood Finish	③b Chassis Grain Direction					
See Artisan Wood Finish Options	For Artisan Only: Vertical Horizontal					

Description	D	W	H	CTN WT	CU FT	① Model	HPL Laminate	Essentials Veneer	Artisan Veneer
Modular Lateral Credenza Pedestal	22	36	28	141	16	FLT2236-29FM4	\$1,498		
	22	36	28	141	16	FLV2236-29FM4		\$2,245	\$2,470
	22	30	28	128	14	FLT2230-29FM4	\$1,460		
	22	30	28	128	14	FLV2230-29FM4		\$2,190	\$2,411



Features:

- use with other modular components, requires a modular top, see page 39
- pedestal front locking

Options:

- must specify chassis grain direction on artisan veneer, see pages 13-15 for details
- veneer drawer fronts in paint available, specify paint color and add \$372 list; see page 16 for details
- on laminate units, contrasting fronts available, no upcharge; specify color, see page 16 for details
- ledge pulls standard; prism pulls available, specify and see page 9

Modular Lateral Credenza Pedestal	22	36	28	141	16	FLT2236-29FM3	\$1,505		
	22	36	28	141	16	FLV2236-29FM3		\$2,258	\$2,484
	22	30	28	129	14	FLT2230-29FM3	\$1,466		
	22	30	28	129	14	FLV2230-29FM3		\$2,201	\$2,423



Features:

- use with other modular components, requires a modular top, see page 39
- pedestal front locking

Options:

- must specify chassis grain direction on artisan veneer, see pages 13-15 for details
- veneer drawer fronts in paint available, specify paint color and add \$372 list; see page 16 for details
- on laminate units, contrasting fronts available, no upcharge; specify color, see page 16 for details
- ledge pulls standard; prism pulls available, specify and see page 9

Modular Credenza Multi-File Pedestal	22	30	28	138	14	FLT2230-29FMRM	\$1,586		
	22	30	28	138	14	FLV2230-29FMRM		\$2,382	\$2,620
	22	30	28	138	14	FLT2230-29FMLM	\$1,586		
	22	30	28	138	14	FLV2230-29FMLM		\$2,382	\$2,620



right shown



left

Features:

- use with other modular components, requires a modular top, see page 39
- pedestal front locking

Options:

- must specify chassis grain direction on artisan veneer, see pages 13-15 for details
- veneer drawer fronts in paint available, specify paint color and add \$372 list; see page 16 for details
- on laminate units, contrasting fronts available, no upcharge; specify color, see page 16 for details
- ledge pulls standard; prism pulls available, specify and see page 9

Modular Hinge Door Credenza Pedestal	22	36	28	122	16	FLT2236-29FM7	\$1,270		
	22	36	28	122	16	FLV2236-29FM7		\$1,906	\$2,093
	22	30	28	108	14	FLT2230-29FM7	\$1,218		
	22	30	28	108	14	FLV2230-29FM7		\$1,830	\$2,012

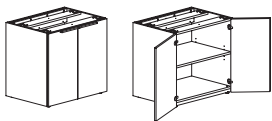

Features:

- use with other modular components, requires a modular top, see page 39
- hinged door compartment has one adjustable shelf

Options:

- must specify chassis grain direction on artisan veneer, see pages 13-15 for details
- locking doors available, specify and add \$153 list
- veneer door fronts in paint available, specify paint color and add \$372 list; see page 16 for details
- on laminate units, contrasting laminate door fronts available, no upcharge; specify laminate color, see page 16 for details
- ledge pulls standard; prism pulls available, specify and see page 9

Description	D	W	H	CTN WT	CU FT	① Model	HPL Laminate	Essentials Veneer	Artisan Veneer
Modular Hinge Door with Open Shelf Credenza Pedestal	22	36	28	132	16	FLT2236-29FM8	\$1,289		
	22	36	28	132	16	FLV2236-29FM8		\$1,934	\$2,129
	22	30	28	116	14	FLT2230-29FM8	\$1,239		
	22	30	28	116	14	FLV2230-29FM8		\$1,862	\$2,047

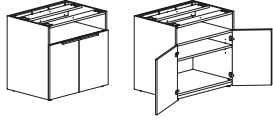

Features:

- use with other modular components, requires a modular top, see page 39
- hinged door compartment has one adjustable shelf

Options:

- must specify chassis grain direction on artisan veneer, see pages 13-15 for details
- locking doors available, specify and add \$153 list
- veneer door fronts in paint available, specify paint color and add \$372 list; see page 16 for details
- on laminate units, contrasting laminate door fronts available, no upcharge; specify laminate color, see page 16 for details
- ledge pulls standard; prism pulls available, specify and see page 9

Modular Open Compartment	D	W	H	CTN WT	CU FT	Model	HPL Laminate	Essentials Veneer	Artisan Veneer
Modular Open Compartment	22	36	28	101	16	FLT2236-29FM0	\$1,124		
	22	36	28	101	16	FLV2236-29FM0		\$1,688	\$1,858
	22	30	28	91	14	FLT2230-29FM0	\$1,098		
	22	30	28	91	14	FLV2230-29FM0		\$1,647	\$1,812



Features:

- use with other modular components, requires a modular top, see page 39
- compartment has one adjustable shelf

Options:

- must specify chassis grain direction on artisan veneer, see pages 13-15 for details

To Order, Specify:

① Laminate Model #	② Laminate Type	③ Laminate Selection	④ Metal Color	⑤ Other Product Options		
Laminate (FLT)	HPL	See Laminate Selection	See Metal Finish Color Options	See list of options for each specific unit; Specify and add accordingly.		
① Veneer Model #	② Wood Collection	③ Wood Finish	④ Metal Color	⑤ Other Product Options		
Veneer (FLV)	Essentials	See Essentials Wood Finish Options	See Metal Finish Color Options	See list of options for each specific unit; Specify and add accordingly.		
	Artisan	<table border="1"> <thead> <tr> <th>ⓐ Wood Finish</th> <th>ⓑ Chassis Grain Direction</th> </tr> </thead> <tbody> <tr> <td>See Artisan Wood Finish Options</td> <td>For Artisan Only: Vertical Horizontal</td> </tr> </tbody> </table>	ⓐ Wood Finish		ⓑ Chassis Grain Direction	See Artisan Wood Finish Options
ⓐ Wood Finish	ⓑ Chassis Grain Direction					
See Artisan Wood Finish Options	For Artisan Only: Vertical Horizontal					

Description	D	W	H	CTN WT	CU FT	① Model	HPL Laminate	Essentials Veneer	Artisan Veneer
Modular Box/File Pedestal - Primary Height	22	18	28	85	9	FLT2218-29LM5	\$1,936		
	22	18	28	85	9	FLV2218-29LM5		\$2,512	\$2,764



Features:

- must be connected to another unit with a common top, this unit is not freestanding
- pedestal front locking

Options:

- must specify chassis grain direction on artisan veneer, see pages 13-15 for details
- veneer drawer fronts in paint available, specify paint color and add \$372 list; see page 16 for details
- on laminate units, contrasting fronts available, no upcharge; specify color, see page 16 for details
- ledge pulls standard; prism pulls available, specify and see page 9

Modular Single Door Storage Pedestal - Primary Height	22	18	28	72	9	FLT2218-29LM7R	\$1,737		
	22	18	28	72	9	FLV2218-29LM7R		\$2,254	\$2,478
	22	18	28	72	9	FLT2218-29LM7L	\$1,737		
	22	18	28	72	9	FLV2218-29LM7L		\$2,254	\$2,478



right shown

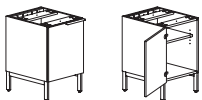

left

Features:

- must be connected to another unit with a common top, this unit is not freestanding

Options:

- must specify chassis grain direction on artisan veneer, see pages 13-15 for details
- locking door available, specify and add \$153 list
- veneer door fronts in paint available, specify paint color and add \$372 list; see page 16 for details
- on laminate units, contrasting laminate door fronts available, no upcharge; specify laminate color, see page 16 for details
- ledge pulls standard; prism pulls available, specify and see page 9

Modular Open Compartment - Primary Height	22	18	28	66	13	FLT2218-29LM0	\$1,669		
	22	18	28	66	13	FLV2218-29LM0		\$2,151	\$2,366



Features:

- use with other modular components, requires a modular top, see page 39
- open compartment with adjustable shelf

Options:

- must specify chassis grain direction on artisan veneer, see pages 13-15 for details

Modular Box/Lateral File - Primary Height	22	36	28	129	16	FLT2236-29LM6	\$2,254		
	22	36	28	129	16	FLV2236-29LM6		\$2,924	\$3,217
	22	30	28	125	14	FLT2230-29LM6	\$2,188		
	22	30	28	125	14	FLV2230-29LM6		\$2,838	\$3,123



Features:

- must be connected to another unit with a common top, this unit is not freestanding
- pedestal front locking

Options:

- must specify chassis grain direction on artisan veneer, see pages 13-15 for details
- veneer drawer fronts in paint available, specify paint color and add \$372 list; see page 16 for details
- on laminate units, contrasting fronts available, no upcharge; specify color, see page 16 for details
- ledge pulls standard; prism pulls available, specify and see page 9

Modular Hidden Drawer Pedestal - Primary Height	22	36	28	131	16	FLT2236-29LMB	\$2,514		
	22	36	28	131	16	FLV2236-29LMB		\$3,262	\$3,590
	22	30	28	121	14	FLT2230-29LMB	\$2,450		
	22	30	28	121	14	FLV2230-29LMB		\$3,178	\$3,497



Features:

- must be connected to another unit with a common top, this unit is not freestanding
- pedestal front locking
- concealed box drawer

Options:

- must specify chassis grain direction on artisan veneer, see pages 13-15 for details
- veneer drawer fronts in paint available, specify paint color and add \$372 list; see page 16 for details
- on laminate units, contrasting fronts available, no upcharge; specify color, see page 16 for details
- ledge pulls standard; prism pulls available, specify and see page 9

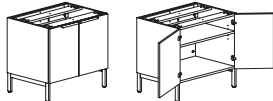
Description	D	W	H	CTN WT	CU FT	① Model	HPL Laminate	Essentials Veneer	Artisan Veneer
	22	36	28	114	16	FLT2236-29LM7	\$1,957		
	22	36	28	114	16	FLV2236-29LM7		\$2,540	\$2,791
	22	30	28	103	14	FLT2230-29LM7	\$1,910		
	22	30	28	103	14	FLV2230-29LM7		\$2,475	\$2,724

Features:

- use with other modular components, requires a modular top, see page 39
- hinged door compartment has one adjustable shelf

Options:

- must specify chassis grain direction on artisan veneer, see pages 13-15 for details
- locking doors available, specify and add \$153 list
- veneer door fronts in paint available, specify paint color and add \$372 list; see page 16 for details
- on laminate units, contrasting laminate door fronts available, no upcharge; specify laminate color, see page 16 for details
- ledge pulls standard; prism pulls available, specify and see page 9

	22	36	28	109	16	FLT2236-29LM8	\$1,981		
	22	36	28	109	16	FLV2236-29LM8		\$2,571	\$2,829
	22	30	28	99	14	FLT2230-29LM8	\$1,932		
	22	30	28	99	14	FLV2230-29LM8		\$2,508	\$2,759

Features:

- must be connected to another unit with a common top, this unit is not freestanding
- hinged door compartment has one adjustable shelf

Options:

- must specify chassis grain direction on artisan veneer, see pages 13-15 for details
- locking doors available, specify and add \$153 list
- veneer door fronts in paint available, specify paint color and add \$372 list; see page 16 for details
- on laminate units, contrasting laminate door fronts available, no upcharge; specify laminate color, see page 16 for details
- ledge pulls standard; prism pulls available, specify and see page 9

	22	36	28	99	16	FLT2236-29LM0	\$1,799		
	22	36	28	99	16	FLV2236-29LM0		\$2,335	\$2,570
	22	30	28	91	14	FLT2230-29LM0	\$1,756		
	22	30	28	91	14	FLV2230-29LM0		\$2,280	\$2,508

Features:

- use with other modular components, requires a modular top, see page 39
- open compartment with adjustable shelf

Options:

- must specify chassis grain direction on artisan veneer, see pages 13-15 for details

To Order, Specify:

① Laminate Model #	② Laminate Type	③ Laminate Selection	④ Metal Color	⑤ Other Product Options
Laminate (FLT)	HPL	See Laminate Selection	See Metal Finish Color Options	See list of options for each specific unit; Specify and add accordingly.
① Veneer Model #	② Wood Collection	③ Wood Finish	④ Metal Color	⑤ Other Product Options
Veneer (FLV)	Essentials	See Essentials Wood Finish Options	See Metal Finish Color Options	See list of options for each specific unit; Specify and add accordingly.
	Artisan	ⓐ Wood Finish See Artisan Wood Finish Options	ⓑ Chassis Grain Direction For Artisan Only: Vertical Horizontal	

Description	D	W	H	CTN WT	CU FT	① Model	HPL Laminate	Essentials Veneer	Artisan Veneer
Modular Credenza Wing End Support for Primary Height Units	22	18	28	43	9	FLT2218WEAR	\$657		
	22	18	28	43	9	FLV2218WEAR		\$983	\$1,080
	22	18	28	43	9	FLT2218WEAL	\$657		
	22	18	28	43	9	FLV2218WEAL		\$983	\$1,080
	22	15 $\frac{5}{8}$	28	40	8	FLT2216WEAR	\$646		
	22	15 $\frac{5}{8}$	28	40	8	FLV2216WEAR		\$970	\$1,067
	22	15 $\frac{5}{8}$	28	40	8	FLT2216WEAL	\$646		
	22	15 $\frac{5}{8}$	28	40	8	FLV2216WEAL		\$970	\$1,067



right shown



left

Features:

- use with other modular components, requires a modular top, see page 39

Options:

- must specify chassis grain direction on artisan veneer, see pages 13-15 for details

Modular Desk T-Support for Primary Height Units	33 $\frac{1}{4}$	11 $\frac{3}{8}$	28	48	9	FLT3428-MDTS	\$855		
	33 $\frac{1}{4}$	11 $\frac{3}{8}$	28	48	9	FLV3428-MDTS		\$1,111	\$1,220
	27 $\frac{1}{4}$	11 $\frac{3}{8}$	28	41	7	FLT2828-MDTS	\$742		
	27 $\frac{1}{4}$	11 $\frac{3}{8}$	28	41	7	FLV2828-MDTS		\$924	\$1,020
	21 $\frac{3}{4}$	11 $\frac{3}{8}$	28	31	6	FLT2228-MDTS	\$713		
	21 $\frac{3}{4}$	11 $\frac{3}{8}$	28	31	6	FLV2228-MDTS		\$924	\$1,020



Features:

- use with other modular components, requires a modular top, see page 39

Options:

- must specify chassis grain direction on artisan veneer, see pages 13-15 for details

Modular Desk T-Support for Secondary Height Units	33 $\frac{1}{4}$	11 $\frac{3}{8}$	6 $\frac{3}{8}$	19	3	FLT3407-MDTS	\$620		
	33 $\frac{1}{4}$	11 $\frac{3}{8}$	6 $\frac{3}{8}$	19	3	FLV3407-MDTS		\$803	\$882
	27 $\frac{1}{4}$	11 $\frac{3}{8}$	6 $\frac{3}{8}$	16	2	FLT2807-MDTS	\$594		
	27 $\frac{1}{4}$	11 $\frac{3}{8}$	6 $\frac{3}{8}$	16	2	FLV2807-MDTS		\$774	\$850
	21 $\frac{3}{4}$	11 $\frac{3}{8}$	6 $\frac{3}{8}$	12	2	FLT2207-MDTS	\$573		
	21 $\frac{3}{4}$	11 $\frac{3}{8}$	6 $\frac{3}{8}$	12	2	FLV2207-MDTS		\$744	\$818



Features:

- use with other modular components, requires a modular top, see page 39

Options:

- must specify chassis grain direction on artisan veneer, see pages 13-15 for details

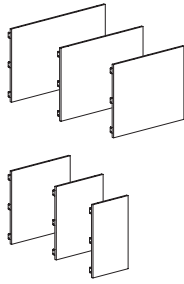
Description	D	W	H	CTN WT	CU FT	① Model	HPL Laminate	Essentials Veneer	Artisan Veneer
Modular Credenza Full Modesty Panel for Primary Height Modular Units 	¾	47 ⅞	28	35	3	FLT2848MCFA	\$448		
	¾	47 ⅞	28	35	3	FLV2848MCFA		\$668	\$735
	¾	41 ⅞	28	32	3	FLT2842MCFA	\$388		
	¾	41 ⅞	28	32	3	FLV2842MCFA		\$579	\$638
	¾	35 ⅞	28	28	2	FLT2836MCFA	\$360		
	¾	35 ⅞	28	28	2	FLV2836MCFA		\$537	\$592
	¾	29 ⅞	28	24	2	FLT2830MCFA	\$331		
	¾	29 ⅞	28	24	2	FLV2830MCFA		\$496	\$545
	¾	23 ⅞	28	20	2	FLT2824MCFA	\$324		
	¾	23 ⅞	28	20	2	FLV2824MCFA		\$481	\$532
	¾	17 ⅞	28	18	2	FLT2818MCFA	\$321		
	¾	17 ⅞	28	18	2	FLV2818MCFA		\$477	\$524

Features:

- use with other modular components, requires a modular top, see page 39

Options:

- must specify chassis grain direction on artisan veneer, see pages 13-15 for details

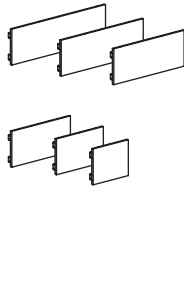
Description	D	W	H	CTN WT	CU FT	① Model	HPL Laminate	Essentials Veneer	Artisan Veneer
Modular Credenza Partial Modesty Panel for Primary Height Modular Units 	¾	47 ⅞	12	21	2	FLT2848MCPA	\$448		
	¾	47 ⅞	12	21	2	FLV2848MCPA		\$668	\$735
	¾	41 ⅞	12	19	2	FLT2842MCPA	\$388		
	¾	41 ⅞	12	19	2	FLV2842MCPA		\$579	\$638
	¾	35 ⅞	12	17	1	FLT2836MCPA	\$360		
	¾	35 ⅞	12	17	1	FLV2836MCPA		\$537	\$592
	¾	29 ⅞	12	15	1	FLT2830MCPA	\$331		
	¾	29 ⅞	12	15	1	FLV2830MCPA		\$496	\$545
	¾	23 ⅞	12	13	1	FLT2824MCPA	\$324		
	¾	23 ⅞	12	13	1	FLV2824MCPA		\$481	\$532
	¾	17 ⅞	12	11	1	FLT2818MCPA	\$321		
	¾	17 ⅞	12	11	1	FLV2818MCPA		\$477	\$524

Features:

- use with other modular components, requires a modular top, see page 39

Options:

- must specify chassis grain direction on artisan veneer, see pages 13-15 for details

To Order, Specify:

① Laminate Model #	② Laminate Type	③ Laminate Selection	④ Metal Color	⑤ Other Product Options
Laminate (FLT)	HPL	See Laminate Selection	See Metal Finish Color Options	See list of options for each specific unit; Specify and add accordingly.
① Veneer Model #	② Wood Collection	③ Wood Finish	④ Metal Color	⑤ Other Product Options
Veneer (FLV)	Essentials	See Essentials Wood Finish Options	See Metal Finish Color Options	See list of options for each specific unit; Specify and add accordingly.
	Artisan	ⓐ Wood Finish See Artisan Wood Finish Options	ⓑ Chassis Grain Direction For Artisan Only: Vertical Horizontal	

FLUX

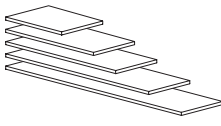
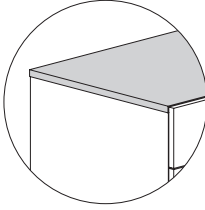
Description	D	W	H	CTN WT	CU FT	① Model	HPL Laminate	Essentials Veneer	Artisan Veneer
Modular Credenza Top for Secondary Height  	21 1/8	108	3/4	57	5	FLT21108MCT	\$716		
	21 1/8	108	3/4	57	5	FLV21108MCT		\$923	\$1,017
	21 1/8	102	3/4	54	4	FLT21102MCT	\$674		
	21 1/8	102	3/4	54	4	FLV21102MCT		\$874	\$961
	21 1/8	96	3/4	51	4	FLT2196MCT	\$637		
	21 1/8	96	3/4	51	4	FLV2196MCT		\$821	\$901
	21 1/8	90	3/4	48	4	FLT2190MCT	\$598		
	21 1/8	90	3/4	48	4	FLV2190MCT		\$769	\$848
	21 1/8	84	3/4	45	4	FLT2184MCT	\$558		
	21 1/8	84	3/4	45	4	FLV2184MCT		\$719	\$792
	21 1/8	78	3/4	43	3	FLT2178MCT	\$518		
	21 1/8	78	3/4	43	3	FLV2178MCT		\$668	\$735
	21 1/8	72	3/4	40	3	FLT2172MCT	\$477		
	21 1/8	72	3/4	40	3	FLV2172MCT		\$616	\$679
	21 1/8	66	3/4	37	3	FLT2166MCT	\$439		
	21 1/8	66	3/4	37	3	FLV2166MCT		\$567	\$622
	21 1/8	60	3/4	34	3	FLT2160MCT	\$397		
	21 1/8	60	3/4	34	3	FLV2160MCT		\$515	\$567
	21 1/8	54	3/4	31	3	FLT2154MCT	\$360		
	21 1/8	54	3/4	31	3	FLV2154MCT		\$466	\$512
	21 1/8	48	3/4	28	2	FLT2148MCT	\$321		
	21 1/8	48	3/4	28	2	FLV2148MCT		\$414	\$455
	21 1/8	42	3/4	25	2	FLT2142MCT	\$281		
	21 1/8	42	3/4	25	2	FLV2142MCT		\$362	\$397
	21 1/8	36	3/4	23	2	FLT2136MCT	\$240		
	21 1/8	36	3/4	23	2	FLV2136MCT		\$311	\$343
	21 1/8	30	3/4	20	2	FLT2130MCT	\$234		
	21 1/8	30	3/4	20	2	FLV2130MCT		\$301	\$329
21 1/8	18	3/4	14	1	FLT2118MCT	\$225			
21 1/8	18	3/4	14	1	FLV2118MCT		\$289	\$317	

Features:

- use with secondary height modular components; designed to fit behind drawer fronts and door fronts
- eased edge profile user side

FLUX

Description	D	W	H	CTN WT	CU FT	① Model	HPL Laminate	Essentials Veneer	Artisan Veneer
Modular Box/File Pedestal - Secondary Height	22	18	21	69	7	FLT2218-21FM5	\$911		
	22	18	21	69	7	FLV2218-21FM5		\$1,271	\$1,396



Options:

- must specify chassis grain direction on artisan veneer, see pages 13-15 for details
- veneer drawer fronts in paint available, specify paint color and add \$372 list; see page 16 for details
- on laminate units, contrasting fronts available, no upcharge; specify color, see page 16 for details
- ledge pulls standard; prism pulls available, specify and see page 9

Modular Single Door Storage Pedestal - Secondary Height	22	18	21	59	7	FLT2218-21FM7R	\$699		
	22	18	21	59	7	FLV2218-21FM7R		\$975	\$1,071
	22	18	21	59	7	FLT2218-21FM7L	\$699		
	22	18	21	59	7	FLV2218-21FM7L		\$975	\$1,071

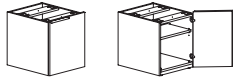

right shown

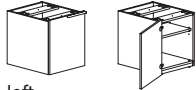

left

Features:

- use with other modular components, requires a modular top, see page 39
- hinged door compartment has one adjustable shelf

Options:

- must specify chassis grain direction on artisan veneer, see pages 13-15 for details
- locking door available, specify and add \$153 list
- veneer door fronts in paint available, specify paint color and add \$372 list; see page 16 for details
- on laminate units, contrasting laminate door fronts available, no upcharge; specify laminate color, see page 16 for details
- ledge pulls standard; prism pulls available, specify and see page 9

Modular Open Compartment	22	18	21	54	10	FLT2218-21FM0	\$624		
	22	18	21	54	10	FLV2218-21FM0		\$871	\$956



Features:

- use with other modular components, requires a modular top, see page 39
- open compartment with adjustable shelf

Options:

- must specify chassis grain direction on artisan veneer, see pages 13-15 for details

To Order, Specify:

① Laminate Model #	② Laminate Type	③ Laminate Selection	④ Metal Color	⑤ Other Product Options		
Laminate (FLT)	HPL	See Laminate Selection	See Metal Finish Color Options	See list of options for each specific unit; Specify and add accordingly.		
① Veneer Model #	② Wood Collection	③ Wood Finish	④ Metal Color	⑤ Other Product Options		
Veneer (FLV)	Essentials	See Essentials Wood Finish Options	See Metal Finish Color Options	See list of options for each specific unit; Specify and add accordingly.		
	Artisan	<table border="1"> <tr> <th>ⓐ Wood Finish</th> <th>ⓑ Chassis Grain Direction</th> </tr> <tr> <td>See Artisan Wood Finish Options</td> <td>For Artisan Only: Vertical Horizontal</td> </tr> </table>	ⓐ Wood Finish		ⓑ Chassis Grain Direction	See Artisan Wood Finish Options
ⓐ Wood Finish	ⓑ Chassis Grain Direction					
See Artisan Wood Finish Options	For Artisan Only: Vertical Horizontal					

Description	D	W	H	CTN WT	CU FT	① Model	HPL Laminate	Essentials Veneer	Artisan Veneer
Modular Box/Lateral File - Secondary Height	22	36	21	131	13	FLT2236-21FM6	\$1,179		
	22	36	21	131	13	FLV2236-21FM6		\$1,643	\$1,805
	22	30	21	116	11	FLT2230-21FM6	\$1,149		
	22	30	21	116	11	FLV2230-21FM6		\$1,602	\$1,762



Features:

- use with other modular components, requires a modular top, see page 39
- pedestal front locking

Options:

- must specify chassis grain direction on artisan veneer, see pages 13-15 for details
- veneer drawer fronts in paint available, specify paint color and add \$372 list; see page 16 for details
- on laminate units, contrasting fronts available, no upcharge; specify color, see page 16 for details
- ledge pulls standard; prism pulls available, specify and see page 9

Modular Hidden Drawer Pedestal - Secondary Height	22	36	21	134	13	FLT2236-21FMB	\$1,428		
	22	36	21	134	13	FLV2236-21FMB		\$1,992	\$2,190
	22	30	21	118	11	FLT2230-21FMB	\$1,392		
	22	30	21	118	11	FLV2230-21FMB		\$1,941	\$2,137



Features:

- use with other modular components, requires a modular top, see page 39
- pedestal front locking

Options:

- must specify chassis grain direction on artisan veneer, see pages 13-15 for details
- veneer drawer fronts in paint available, specify paint color and add \$372 list; see page 16 for details
- on laminate units, contrasting fronts available, no upcharge; specify color, see page 16 for details
- ledge pulls standard; prism pulls available, specify and see page 9

Modular Two Door Pedestal - Secondary Height	22	36	21	116	13	FLT2236-21FM7	\$1,196		
	22	36	21	116	13	FLV2236-21FM7		\$1,669	\$1,837
	22	30	21	105	11	FLT2230-21FM7	\$1,173		
	22	30	21	105	11	FLV2230-21FM7		\$1,636	\$1,798

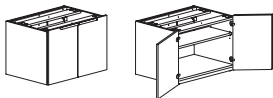

Features:

- use with other modular components, requires a modular top, see page 39
- hinged door compartment has one adjustable shelf

Options:

- must specify chassis grain direction on artisan veneer, see pages 13-15 for details
- locking doors available, specify and add \$153 list
- veneer door fronts in paint available, specify paint color and add \$372 list; see page 16 for details
- on laminate units, contrasting fronts available, no upcharge; specify color, see page 16 for details
- ledge pulls standard; prism pulls available, specify and see page 9

Modular Storage Pedestal with Open Center Shelf - Secondary Height	22	36	21	116	13	FLT2236-21FM8	\$1,226		
	22	36	21	116	13	FLV2236-21FM8		\$1,709	\$1,879
	22	30	21	105	11	FLT2230-21FM8	\$1,196		
	22	30	21	105	11	FLV2230-21FM8		\$1,668	\$1,836

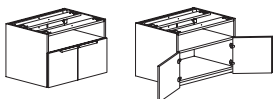

Features:

- use with other modular components, requires a modular top, see page 39

Options:

- must specify chassis grain direction on artisan veneer, see pages 13-15 for details
- locking doors available, specify and add \$153 list
- veneer door fronts in paint available, specify paint color and add \$372 list; see page 16 for details
- on laminate units, contrasting laminate door fronts available, no upcharge; specify laminate color, see page 16 for details
- ledge pulls standard; prism pulls available, specify and see page 9



Description	D	W	H	CTN WT	CU FT	① Model	HPL Laminate	Essentials Veneer	Artisan Veneer
	22	36	21	99	13	FLT2236-21FMO	\$1,081		
	22	36	21	99	13	FLV2236-21FMO		\$1,510	\$1,662
	22	30	21	90	11	FLT2230-21FMO	\$1,057		
	22	30	21	90	11	FLV2230-21FMO		\$1,475	\$1,623

Features:

- use with other modular components, requires a modular top, see page 39
- open compartment with adjustable shelf

Options:

- must specify chassis grain direction on artisan veneer, see pages 13-15 for details

Description	D	W	H	CTN WT	CU FT	① Model	HPL Laminate	Essentials Veneer	Artisan Veneer
 <p>*OE shown</p>  <p>*EO</p>	22	36	21	106	13	FLT2236-21FME0	\$1,521		
	22	36	21	106	13	FLV2236-21FME0		\$2,125	\$2,335
	22	36	21	106	13	FLT2236-21FMOE	\$1,521		
	22	36	21	106	13	FLV2236-21FMOE		\$2,125	\$2,335
	22	30	21	94	11	FLT2230-21FME0	\$1,485		
	22	30	21	94	11	FLV2230-21FME0		\$2,072	\$2,280
	22	30	21	94	11	FLT2230-21FMOE	\$1,485		
	22	30	21	94	11	FLV2230-21FMOE		\$2,072	\$2,280

Features:

- square edge on top
- electrical power unit - EC26 included, specify color
- open compartment with adjustable shelf
- shelf 12 1/2"d

Options:

- must specify chassis grain direction on artisan veneer, see pages 13-15 for details
- oval grommet in back panel can be eliminated upon request, no upcharge

Description	D	W	H	CTN WT	CU FT	① Model	List Price
	2	67	3/4	5	1	GP0267SB	\$121
	2	61	3/4	5	1	GP0261SB	\$108
	2	55	3/4	4	1	GP0255SB	\$101
	2	49	3/4	4	1	GP0249SB	\$92
	2	43	3/4	3	1	GP0243SB	\$87

- black metal
- includes screws for attachment to worksurfaces 1" thick and greater
- required when worksurfaces unsupported span is greater than 48"
- GP0267SB used when unsupported width span is 67" to 74"
- GP0261SB used when unsupported width span is 63" to 68"
- GP0255SB used when unsupported width span is 57" to 62"
- GP0249SB used when unsupported width span is 51" to 56"
- GP0243SB used when unsupported width span is 48" to 50"
- 30"d tops with unsupported span 63"-74" require 2 rails; 36"d & 42"d tops require 2 rails

To Order, Specify:

① Laminate Model #	② Laminate Type	③ Laminate Selection	④ Metal Color	⑤ Other Product Options
Laminate (FLT)	HPL	See Laminate Selection	See Metal Finish Color Options	See list of options for each specific unit; Specify and add accordingly.
① Veneer Model #	② Wood Collection	③ Wood Finish	④ Metal Color	⑤ Other Product Options
Veneer (FLV)	Essentials	See Essentials Wood Finish Options	See Metal Finish Color Options	See list of options for each specific unit; Specify and add accordingly.
	Artisan	ⓐ Wood Finish See Artisan Wood Finish Options	ⓑ Chassis Grain Direction For Artisan Only: Vertical Horizontal	

Description	D	W	H	CTN WT	CU FT	① Model	Laminate	Essentials Veneer	Artisan Veneer
Double Height Overhead Cabinet with Six Doors	15 7/8"	95 7/8"	52"	323	55	FLT1696-52S0	\$3,094		
	15 7/8"	95 7/8"	52"	323	55	FLV1696-52S0		\$5,237	\$5,763
	15 7/8"	89 7/8"	52"	306	52	FLT1690-52S0	\$2,906		
	15 7/8"	89 7/8"	52"	306	52	FLV1690-52S0		\$4,921	\$5,412
	15 7/8"	83 7/8"	52"	289	48	FLT1684-52S0	\$2,713		
	15 7/8"	83 7/8"	52"	289	48	FLV1684-52S0		\$4,595	\$5,055

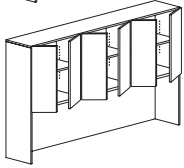
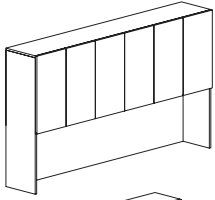

Features:

- use with primary height units, fastening hardware included
- backside of unit intended to go against wall, cabinet should be secured to wall as a safety precaution
- laminate grain direction runs horizontal on back panel of overhead cabinets
- 1/4" overhang at the bottom of the door allows access
- 22 3/4" vertical clearance between worksurface and bottom of door, excluding task light
- two 5/8" dia. holes in upper corners of back panel for task light wiring access
- exterior back panel unfinished
- adjustable shelves

Options:

- must specify chassis grain direction on artisan veneer, see pages 13-15 for details
- veneer door fronts in paint available, specify paint color and add \$372 list; see page 16 for details
- on laminate units, contrasting laminate door fronts available, no upcharge; specify laminate color, see page 16 for details
- white glass doors with aluminum trim available, specify and add \$4,949 list for 96"w, \$4,740 list for 90"w, \$4,562 list for 84"w; see page 33 for details
- markerboard laminate doors available, specify and add \$1,263 list; see page 33 for details
- locking doors available, specify and add \$459 list (not available on glass doors)
- tackboard or markerboard available, see pages 292-295
- tasklights available, see page 455

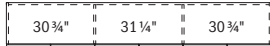

96" wide



90" wide

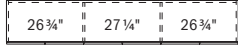

84" wide

FLUX

Description	D	W	H	CTN WT	CU FT	① Model	Laminate	Essentials Veneer	Artisan Veneer
Double Height Overhead Cabinet with Four Doors	15 7/8	77 7/8	52	264	45	FLT1678-52S0	\$2,530		
	15 7/8	77 7/8	52	264	45	FLV1678-52S0		\$4,144	\$4,559
	15 7/8	71 7/8	52	247	42	FLT1672-52S0	\$2,384		
	15 7/8	71 7/8	52	247	42	FLV1672-52S0		\$3,903	\$4,293
	15 7/8	65 7/8	52	235	38	FLT1666-52S0	\$2,253		
	15 7/8	65 7/8	52	235	38	FLV1666-52S0		\$3,689	\$4,057
	15 7/8	59 7/8	52	218	35	FLT1660-52S0	\$2,154		
	15 7/8	59 7/8	52	218	35	FLV1660-52S0		\$3,526	\$3,879

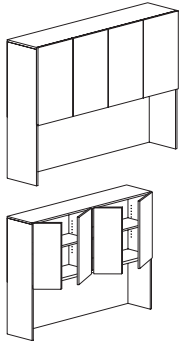

78" wide



72" wide



66" wide



60" wide

Features:

- use with primary height units, fastening hardware included
- backside of unit intended to go against wall, cabinet should be secured to wall as a safety precaution
- laminate grain direction runs horizontal on back panel of overhead cabinets
- 1/4" overhang at the bottom of the door allows access
- 22 3/4" vertical clearance between worksurface and bottom of door, excluding task light
- two 5/8" dia. holes in upper corners of back panel for task light wiring access
- exterior back panel unfinished
- adjustable shelves

Options:

- must specify chassis grain direction on artisan veneer, see pages 13-15 for details
- veneer door fronts in paint available, specify paint color and add \$372 list; see page 16 for details
- on laminate units, contrasting laminate door fronts available, no upcharge; specify laminate color, see page 16 for details
- white glass doors with aluminum trim available, specify and add \$3,790 list for 78"w, \$3,581 list for 72"w, \$3,372 list for 66"w, \$3,164 list for 60"w; see page 33 for details
- markerboard laminate doors available, specify and add \$843 list; see page 33 for details
- locking doors available, specify and add \$306 list (not available on glass doors)
- tackboard or markerboard available, see pages 292-295
- tasklights available, see page 455

To Order, Specify:

① Laminate Model #	② Laminate Selection	③ Metal Color	④ Other Product Options
Laminate (FLT)	See Laminate Selection	See Metal Finish Color Options	See list of options for each specific unit; Specify and add accordingly.

① Veneer Model #	② Wood Collection	③ Wood Finish	④ Metal Color	⑤ Other Product Options		
Veneer (FLV)	Essentials	See Essentials Wood Finish Options	See Metal Finish Color Options	See list of options for each specific unit; Specify and add accordingly.		
	Artisan	<table border="1"> <thead> <tr> <th>③a Wood Finish</th> <th>③b Chassis Grain Direction</th> </tr> </thead> <tbody> <tr> <td>See Artisan Wood Finish Options</td> <td>For Artisan Only: Vertical Horizontal</td> </tr> </tbody> </table>	③a Wood Finish		③b Chassis Grain Direction	See Artisan Wood Finish Options
③a Wood Finish	③b Chassis Grain Direction					
See Artisan Wood Finish Options	For Artisan Only: Vertical Horizontal					

Description	D	W	H	CTN WT	CU FT	① Model	Laminate	Essentials Veneer	Artisan Veneer
Double Height Overhead Cabinet with Three Doors	15 7/8	53 7/8	52	200	32	FLT1654-52SOR	\$2,107		
	15 7/8	53 7/8	52	200	32	FLV1654-52SOR		\$3,393	\$3,732
	15 7/8	53 7/8	52	200	32	FLT1654-52SOL	\$2,107		
	15 7/8	53 7/8	52	200	32	FLV1654-52SOL		\$3,393	\$3,732
	15 7/8	47 7/8	52	183	28	FLT1648-52SOR	\$2,035		
	15 7/8	47 7/8	52	183	28	FLV1648-52SOR		\$3,278	\$3,604
	15 7/8	47 7/8	52	183	28	FLT1648-52SOL	\$2,035		
	15 7/8	47 7/8	52	183	28	FLV1648-52SOL		\$3,278	\$3,604
	15 7/8	41 7/8	52	165	25	FLT1642-52SOR	\$1,969		
	15 7/8	41 7/8	52	165	25	FLV1642-52SOR		\$3,170	\$3,489
	15 7/8	41 7/8	52	165	25	FLT1642-52SOL	\$1,969		
	15 7/8	41 7/8	52	165	25	FLV1642-52SOL		\$3,170	\$3,489

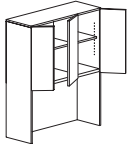
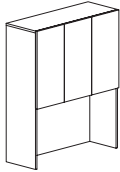

right shown

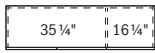

54" wide

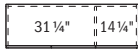

48" wide

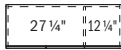

42" wide

Features:

- use with primary height units, fastening hardware included
- backside of unit intended to go against wall, cabinet should be secured to wall as a safety precaution
- laminate grain direction runs horizontal on back panel of overhead cabinets
- 1/4" overhang at the bottom of the door allows access
- 22 3/4" vertical clearance between worksurface and bottom of door, excluding task light
- two 5/8" dia. holes in upper corners of back panel for task light wiring access
- exterior back panel unfinished
- adjustable shelves

Options:

- must specify chassis grain direction on artisan veneer, see pages 13-15 for details
- veneer door fronts in paint available, specify paint color and add \$372 list; see page 16 for details
- on laminate units, contrasting laminate door fronts available, no upcharge; specify laminate color, see page 16 for details
- white glass doors with aluminum trim available, specify and add \$2,686 list for 54"w, \$2,477 list for 48"w, \$2,270 list for 42"w; see page 33 for details
- markerboard laminate doors available, specify and add \$634 list; see page 33 for details
- locking doors available, specify and add \$306 list (not available on glass doors)
- tackboard or markerboard available, see pages 292-295
- tasklights available, see page 455

Description	D	W	H	CTN WT	CU FT	① Model	Laminate	Essentials Veneer	Artisan Veneer
Double Height Overhead Cabinet with Two Doors	15 7/8	35 7/8	52	137	22	FLT1636-52S0	\$1,868		
	15 7/8	35 7/8	52	137	22	FLV1636-52S0		\$3,007	\$3,308
	15 7/8	29 7/8	52	120	18	FLT1630-52S0	\$1,790		
	15 7/8	29 7/8	52	120	18	FLV1630-52S0		\$2,881	\$3,169

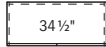
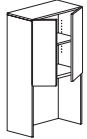
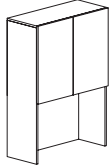

36" wide



30" wide

Features:

- use with primary height units, fastening hardware included
- backside of unit intended to go against wall, cabinet should be secured to wall as a safety precaution
- laminate grain direction runs horizontal on back panel of overhead cabinets
- 1/4" overhang at the bottom of the door allows access
- 22 3/4" vertical clearance between worksurface and bottom of door, excluding task light
- two 5/8" dia. holes in upper corners of back panel for task light wiring access
- exterior back panel unfinished
- adjustable shelf

Options:

- must specify chassis grain direction on artisan veneer, see pages 13-15 for details
- veneer door fronts in paint available, specify paint color and add \$372 list; see page 16 for details
- on laminate units, contrasting laminate door fronts available, no upcharge; specify laminate color, see page 16 for details
- white glass doors with aluminum trim available, specify and add \$1,794 list for 36"w, \$1,585 list for 30"w; see page 33 for details
- markerboard laminate doors available, specify and add \$426 list; see page 33 for details
- locking doors available, specify and add \$153 list (not available on glass doors)
- tackboard or markerboard available, see pages 292-295
- tasklights available, see page 455

To Order, Specify:

① Laminate Model #	② Laminate Selection	③ Metal Color	④ Other Product Options
Laminate (FLT)	See Laminate Selection	See Metal Finish Color Options	See list of options for each specific unit; Specify and add accordingly.

① Veneer Model #	② Wood Collection	③ Wood Finish	④ Metal Color	⑤ Other Product Options		
Veneer (FLV)	Essentials	See Essentials Wood Finish Options	See Metal Finish Color Options	See list of options for each specific unit; Specify and add accordingly.		
	Artisan	<table border="1"> <thead> <tr> <th>③a Wood Finish</th> <th>③b Chassis Grain Direction</th> </tr> </thead> <tbody> <tr> <td>See Artisan Wood Finish Options</td> <td>For Artisan Only: Vertical Horizontal</td> </tr> </tbody> </table>	③a Wood Finish		③b Chassis Grain Direction	See Artisan Wood Finish Options
③a Wood Finish	③b Chassis Grain Direction					
See Artisan Wood Finish Options	For Artisan Only: Vertical Horizontal					

Description	D	W	H	CTN WT	CU FT	Model	Laminate	Essentials Veneer	Artisan Veneer
Double Height Overhead Cabinet with Four Doors and Open Center	15 7/8"	95 7/8"	52"	303	55	FLT1696-52SMO	\$2,939		
	15 7/8"	95 7/8"	52"	303	55	FLV1696-52SMO		\$4,977	\$5,475
	15 7/8"	89 7/8"	52"	287	52	FLT1690-52SMO	\$2,761		
	15 7/8"	89 7/8"	52"	287	52	FLV1690-52SMO		\$4,675	\$5,142
	15 7/8"	83 7/8"	52"	271	48	FLT1684-52SMO	\$2,582		
	15 7/8"	83 7/8"	52"	271	48	FLV1684-52SMO		\$4,366	\$4,804

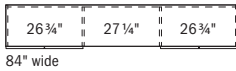
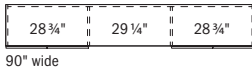
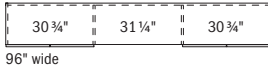
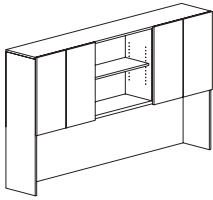

Features:

- use with primary height units, fastening hardware included
- backside of unit intended to go against wall, cabinet should be secured to wall as a safety precaution
- laminate grain direction runs horizontal on back panel of overhead cabinets
- 1/4" overhang at the bottom of the door allows access
- 22 3/4" vertical clearance between worksurface and bottom of door, excluding task light
- two 5/8" dia. holes in upper corners of back panel for task light wiring access
- exterior back panel unfinished
- adjustable shelves

Options:

- must specify chassis grain direction on artisan veneer, see pages 13-15 for details
- veneer door fronts in paint available, specify paint color and add \$372 list; see page 16 for details
- on laminate units, contrasting laminate door fronts available, no upcharge; specify laminate color, see page 16 for details
- white glass doors with aluminum trim available, specify and add \$3,303 list for 96"w, \$3,164 list for 90"w, \$3,026 list for 84"w; see page 33 for details
- markerboard laminate doors available, specify and add \$843 list; see page 33 for details
- locking doors available, specify and add \$306 list (not available on glass doors)
- tackboard or markerboard available, see pages 292-295
- tasklights available, see page 455

Double Height Overhead Cabinet with Two Doors and Open Compartment	15 7/8"	77 7/8"	52"	239	45	FLT1678-52SMOR	\$2,404		
	15 7/8"	77 7/8"	52"	239	45	FLV1678-52SMOR		\$3,938	\$4,330
	15 7/8"	77 7/8"	52"	239	45	FLT1678-52SMOL	\$2,404		
	15 7/8"	77 7/8"	52"	239	45	FLV1678-52SMOL		\$3,938	\$4,330
	15 7/8"	71 7/8"	52"	224	42	FLT1672-52SMOR	\$2,266		
	15 7/8"	71 7/8"	52"	224	42	FLV1672-52SMOR		\$3,712	\$4,082
	15 7/8"	71 7/8"	52"	224	42	FLT1672-52SMOL	\$2,266		
	15 7/8"	71 7/8"	52"	224	42	FLV1672-52SMOL		\$3,712	\$4,082
	15 7/8"	65 7/8"	52"	215	38	FLT1666-52SMOR	\$2,139		
	15 7/8"	65 7/8"	52"	215	38	FLV1666-52SMOR		\$3,505	\$3,857
	15 7/8"	65 7/8"	52"	215	38	FLT1666-52SMOL	\$2,139		
	15 7/8"	65 7/8"	52"	215	38	FLV1666-52SMOL		\$3,505	\$3,857
	15 7/8"	59 7/8"	52"	199	35	FLT1660-52SMOR	\$2,046		
	15 7/8"	59 7/8"	52"	199	35	FLV1660-52SMOR		\$3,351	\$3,687
	15 7/8"	59 7/8"	52"	199	35	FLT1660-52SMOL	\$2,046		
	15 7/8"	59 7/8"	52"	199	35	FLV1660-52SMOL		\$3,351	\$3,687

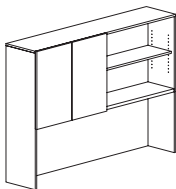

left shown

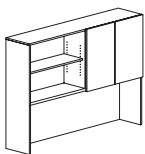

right

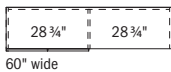
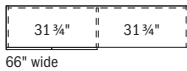
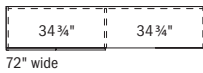
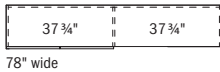

Features:

- use with primary height units, fastening hardware included
- backside of unit intended to go against wall, cabinet should be secured to wall as a safety precaution
- laminate grain direction runs horizontal on back panel of overhead cabinets
- 1/4" overhang at the bottom of the door allows access
- 22 3/4" vertical clearance between worksurface and bottom of door, excluding task light
- two 5/8" dia. holes in upper corners of back panel for task light wiring access
- exterior back panel unfinished
- adjustable shelves

Options:

- must specify chassis grain direction on artisan veneer, see pages 13-15 for details
- veneer door fronts in paint available, specify paint color and add \$372 list; see page 16 for details
- on laminate units, contrasting laminate door fronts available, no upcharge; specify laminate color, see page 16 for details
- white glass doors with aluminum trim available, specify and add \$1,897 list for 78"w, \$1,794 list for 72"w, \$1,689 list for 66"w, \$1,585 list for 60"w; see page 33 for details
- markerboard laminate doors available, specify and add \$426 list; see page 33 for details
- locking doors available, specify and add \$153 list (not available on glass doors)
- tackboard or markerboard available, see pages 292-295
- tasklights available, see page 455

Description	D	W	H	CTN WT	CU FT	① Model	Laminate	Essentials Veneer	Artisan Veneer
Double Height Overhead Cabinet with Two Doors and Open Center	15 7/8"	53 7/8"	52"	197	32	FLT1654-52SMO	\$2,002		
	15 7/8"	53 7/8"	52"	197	32	FLV1654-52SMO		\$3,226	\$3,546
	15 7/8"	47 7/8"	52"	181	28	FLT1648-52SMO	\$1,931		
	15 7/8"	47 7/8"	52"	181	28	FLV1648-52SMO		\$3,114	\$3,427
	15 7/8"	41 7/8"	52"	165	25	FLT1642-52SMO	\$1,873		
	15 7/8"	41 7/8"	52"	165	25	FLV1642-52SMO		\$3,014	\$3,316

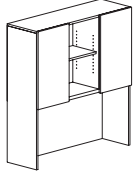

54" wide



48" wide



42" wide

Features:

- use with primary height units, fastening hardware included
- backside of unit intended to go against wall, cabinet should be secured to wall as a safety precaution
- laminate grain direction runs horizontal on back panel of overhead cabinets
- 1/4" overhang at the bottom of the door allows access
- 22 3/4" vertical clearance between worksurface and bottom of door, excluding task light
- two 5/8" dia. holes in upper corners of back panel for task light wiring access
- exterior back panel unfinished
- adjustable shelves

Options:

- must specify chassis grain direction on artisan veneer, see pages 13-15 for details
- veneer door fronts in paint available, specify paint color and add \$372 list; see page 16 for details
- on laminate units, contrasting laminate door fronts available, no upcharge; specify laminate color, see page 16 for details
- white glass doors with aluminum trim available, specify and add \$1,794 list for 54"w, \$1,931 list for 48"w, \$1,514 list for 42"w; see page 33 for details
- markerboard laminate doors available, specify and add \$426 list; see page 33 for details
- locking doors available, specify and add \$306 list (not available on glass doors)
- tackboard or markerboard available, see pages 292-295
- tasklights available, see page 455

To Order, Specify:

① Laminate Model #	② Laminate Selection	③ Metal Color	④ Other Product Options
Laminate (FLT)	See Laminate Selection	See Metal Finish Color Options	See list of options for each specific unit; Specify and add accordingly.

① Veneer Model #	② Wood Collection	③ Wood Finish	④ Metal Color	⑤ Other Product Options		
Veneer (FLV)	Essentials	See Essentials Wood Finish Options	See Metal Finish Color Options	See list of options for each specific unit; Specify and add accordingly.		
	Artisan	<table border="1"> <thead> <tr> <th>③a Wood Finish</th> <th>③b Chassis Grain Direction</th> </tr> </thead> <tbody> <tr> <td>See Artisan Wood Finish Options</td> <td>For Artisan Only: Vertical Horizontal</td> </tr> </tbody> </table>	③a Wood Finish		③b Chassis Grain Direction	See Artisan Wood Finish Options
③a Wood Finish	③b Chassis Grain Direction					
See Artisan Wood Finish Options	For Artisan Only: Vertical Horizontal					

Description	D	W	H	CTN WT	CU FT	① Model	Laminate	Essentials Veneer	Artisan Veneer
Double Height Storage Overhead Cabinet with Four Doors, Open Center and Cubbies	15 7/8"	95 7/8"	52"	313	55	FLT1696-52SMOCC	\$3,074		
	15 7/8"	95 7/8"	52"	313	55	FLV1696-52SMOCC		\$5,173	\$5,688
	15 7/8"	89 7/8"	52"	297	52	FLT1690-52SMOCC	\$2,897		
	15 7/8"	89 7/8"	52"	297	52	FLV1690-52SMOCC		\$4,868	\$5,357
	15 7/8"	83 7/8"	52"	280	48	FLT1684-52SMOCC	\$2,713		
	15 7/8"	83 7/8"	52"	280	48	FLV1684-52SMOCC		\$4,564	\$5,018

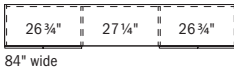
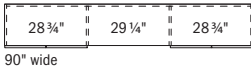
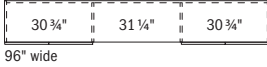
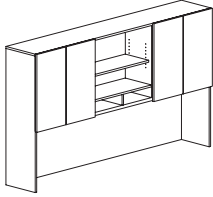

Features:

- use with primary height units, fastening hardware included
- backside of unit intended to go against wall, cabinet should be secured to wall as a safety precaution
- laminate grain direction runs horizontal on back panel of overhead cabinets
- 1/4" overhang at the bottom of the door allows access
- 22 3/4" vertical clearance between worksurface and bottom of door, excluding task light
- two 5/8" dia. holes in upper corners of back panel for task light wiring access
- exterior back panel unfinished
- adjustable shelves

Options:

- must specify chassis grain direction on artisan veneer, see pages 13-15 for details
- veneer door fronts in paint available, specify paint color and add \$372 list; see page 16 for details
- on laminate units, contrasting laminate door fronts available, no upcharge; specify laminate color, see page 16 for details
- white glass doors with aluminum trim available, specify and add \$3,303 list for 96"w, \$3,164 list for 90"w, \$3,026 list for 84"w; see page 33 for details
- markerboard laminate doors available, specify and add \$843 list; see page 33 for details
- locking doors available, specify and add \$306 list (not available on glass doors)
- tackboard or markerboard available, see pages 292-295
- tasklights available, see page 455

Double Height Storage Overhead Cabinet with Two Doors, Open Center and Cubbies	15 7/8"	77 7/8"	52"	260	45	FLT1678-52SMOCC	\$2,541		
	15 7/8"	77 7/8"	52"	260	45	FLV1678-52SMOCC		\$4,132	\$4,546
	15 7/8"	71 7/8"	52"	245	42	FLT1672-52SMOCC	\$2,402		
	15 7/8"	71 7/8"	52"	245	42	FLV1672-52SMOCC		\$3,905	\$4,294
	15 7/8"	65 7/8"	52"	233	38	FLT1666-52SMOCC	\$2,277		
	15 7/8"	65 7/8"	52"	233	38	FLV1666-52SMOCC		\$3,699	\$4,071
	15 7/8"	59 7/8"	52"	221	35	FLT1660-52SMOCC	\$2,182		
	15 7/8"	59 7/8"	52"	221	35	FLV1660-52SMOCC		\$3,546	\$3,901

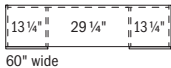
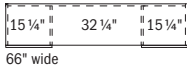
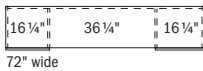
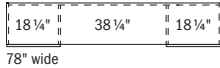
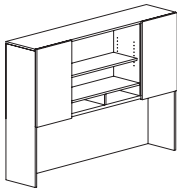

Features:

- use with primary height units, fastening hardware included
- backside of unit intended to go against wall, cabinet should be secured to wall as a safety precaution
- laminate grain direction runs horizontal on back panel of overhead cabinets
- 1/4" overhang at the bottom of the door allows access
- 22 3/4" vertical clearance between worksurface and bottom of door, excluding task light
- two 5/8" dia. holes in upper corners of back panel for task light wiring access
- exterior back panel unfinished
- adjustable shelves

Options:

- must specify chassis grain direction on artisan veneer, see pages 13-15 for details
- veneer door fronts in paint available, specify paint color and add \$372 list; see page 16 for details
- on laminate units, contrasting laminate door fronts available, no upcharge; specify laminate color, see page 16 for details
- white glass doors with aluminum trim available, specify and add \$1,897 list for 78"w, \$1,794 list for 72"w, \$1,689 list for 66"w, \$1,585 list for 60"w; see page 33 for details
- markerboard laminate doors available, specify and add \$426 list; see page 33 for details
- locking doors available, specify and add \$306 list (not available on glass doors)
- tackboard or markerboard available, see pages 292-295
- tasklights available, see page 455

Description	D	W	H	CTN WT	CU FT	① Model	Laminate	Essentials Veneer	Artisan Veneer
Double Height Overhead Cabinet with Two Doors, Open Center and Cubby	15 7/8	53 7/8	52	202	32	FLT1654-52SMOCC	\$2,137		
	15 7/8	53 7/8	52	202	32	FLV1654-52SMOCC		\$3,417	\$3,763
	15 7/8	47 7/8	52	186	28	FLT1648-52SMOCC	\$2,067		
	15 7/8	47 7/8	52	186	28	FLV1648-52SMOCC		\$3,311	\$3,642
	15 7/8	41 7/8	52	169	25	FLT1642-52SMOCC	\$2,007		
	15 7/8	41 7/8	52	169	25	FLV1642-52SMOCC		\$3,209	\$3,532

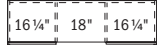
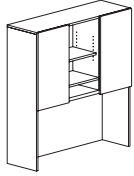

54" wide



48" wide



42" wide

Features:

- use with primary height units, fastening hardware included
- backside of unit intended to go against wall, cabinet should be secured to wall as a safety precaution
- laminate grain direction runs horizontal on back panel of overhead cabinets
- 1/4" overhang at the bottom of the door allows access
- 22 3/4" vertical clearance between worksurface and bottom of door, excluding task light
- two 5/8" dia. holes in upper corners of back panel for task light wiring access
- exterior back panel unfinished
- adjustable shelves

Options:

- must specify chassis grain direction on artisan veneer, see pages 13-15 for details
- veneer door fronts in paint available, specify paint color and add \$372 list; see page 16 for details
- on laminate units, contrasting laminate door fronts available, no upcharge; specify laminate color, see page 16 for details
- white glass doors with aluminum trim available, specify and add \$1,794 list for 54"w, \$1,931 list for 48"w, \$1,514 list for 42"w; see page 33 for details
- markerboard laminate doors available, specify and add \$426 list; see page 33 for details
- locking doors available, specify and add \$306 list (not available on glass doors)
- tackboard or markerboard available, see pages 292-295
- tasklights available, see page 455

To Order, Specify:

① Laminate Model #	② Laminate Selection	③ Metal Color	④ Other Product Options
Laminate (FLT)	See Laminate Selection	See Metal Finish Color Options	See list of options for each specific unit; Specify and add accordingly.

① Veneer Model #	② Wood Collection	③ Wood Finish	④ Metal Color	⑤ Other Product Options		
Veneer (FLV)	Essentials	See Essentials Wood Finish Options	See Metal Finish Color Options	See list of options for each specific unit; Specify and add accordingly.		
	Artisan	<table border="1"> <thead> <tr> <th>③a Wood Finish</th> <th>③b Chassis Grain Direction</th> </tr> </thead> <tbody> <tr> <td>See Artisan Wood Finish Options</td> <td>For Artisan Only: Vertical Horizontal</td> </tr> </tbody> </table>	③a Wood Finish		③b Chassis Grain Direction	See Artisan Wood Finish Options
③a Wood Finish	③b Chassis Grain Direction					
See Artisan Wood Finish Options	For Artisan Only: Vertical Horizontal					

Description	D	W	H	CTN WT	CU FT	① Model	Laminate	Essentials Veneer	Artisan Veneer
Double Height Storage Overhead Cabinet with Sliding Doors	15 15/16	95 7/8	52	311	55	FLT1696-52SD	\$3,475		
	15 15/16	95 7/8	52	311	55	FLV1696-52SD		\$5,694	\$6,263
	15 15/16	89 13/16	52	295	52	FLT1690-52SD	\$3,220		
	15 15/16	89 13/16	52	295	52	FLV1690-52SD		\$5,277	\$5,805
	15 15/16	83 7/8	52	279	49	FLT1684-52SD	\$2,965		
	15 15/16	83 7/8	52	279	49	FLV1684-52SD		\$4,857	\$5,343

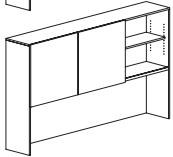
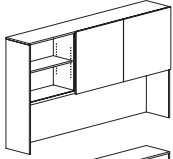
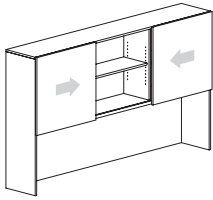

Features:

- use with primary height units, fastening hardware included
- backside of unit intended to go against wall, cabinet should be secured to wall as a safety precaution
- laminate grain direction runs horizontal on back panel of overhead cabinets
- 22 3/4" vertical clearance between worksurface and bottom of door, excluding task light
- two 5/8" dia. holes in upper corners of back panel for task light wiring access
- exterior back panel unfinished
- locking not available
- adjustable shelves

Options:

- must specify chassis grain direction on artisan veneer, see pages 13-15 for details
- veneer door fronts in paint available, specify paint color and add \$372 list; see page 16 for details
- on laminate units, contrasting laminate door fronts available, no upcharge; specify laminate color, see page 16 for details
- white glass doors with aluminum trim available, specify and add \$2,896 list for 96"w, \$2,755 list for 90"w, \$2,616 list for 84"w; see page 33 for details
- markerboard laminate doors available, specify and add \$628 list; see page 33 for details
- tackboard or markerboard available, see pages 292-295
- tasklights available, see page 455

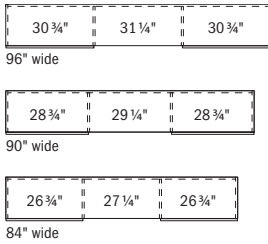

Double Height Storage Overhead Cabinet with Sliding Door	15 15/16	77 7/8	52	245	45	FLT1678-52SD	\$2,858		
	15 15/16	77 7/8	52	245	45	FLV1678-52SD		\$4,529	\$4,982
	15 15/16	71 7/8	52	224	42	FLT1672-52SD	\$2,696		
	15 15/16	71 7/8	52	224	42	FLV1672-52SD		\$4,274	\$4,701
	15 15/16	65 7/8	52	214	39	FLT1666-52SD	\$2,550		
	15 15/16	65 7/8	52	214	39	FLV1666-52SD		\$4,043	\$4,447
	15 15/16	59 7/8	52	193	35	FLT1660-52SD	\$2,440		
	15 15/16	59 7/8	52	193	35	FLV1660-52SD		\$3,871	\$4,258

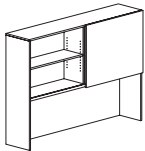
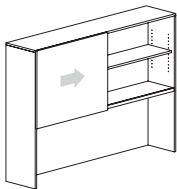

Features:

- use with primary height units, fastening hardware included
- backside of unit intended to go against wall, cabinet should be secured to wall as a safety precaution
- laminate grain direction runs horizontal on back panel of overhead cabinets
- 22 3/4" vertical clearance between worksurface and bottom of door, excluding task light
- two 5/8" dia. holes in upper corners of back panel for task light wiring access
- exterior back panel unfinished
- locking not available
- adjustable shelves

Options:

- must specify chassis grain direction on artisan veneer, see pages 13-15 for details
- veneer door fronts in paint available, specify paint color and add \$372 list; see page 16 for details
- on laminate units, contrasting laminate door fronts available, no upcharge; specify laminate color, see page 16 for details
- white glass doors with aluminum trim available, specify and add \$1,693 list for 78"w, \$1,590 list for 72"w, \$1,485 list for 66"w, \$1,380 list for 60"w; see page 33 for details
- markerboard laminate doors available, specify and add \$317 list; see page 33 for details
- tackboard or markerboard available, see pages 292-295
- tasklights available, see page 455

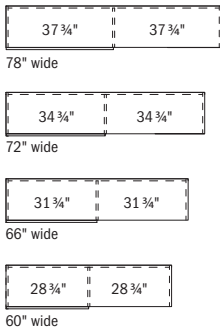

Description	D	W	H	CTN WT	CU FT	① Model	Laminate	Essentials Veneer	Artisan Veneer
Double Height Storage Overhead Cabinet with Sliding Door	15 15/16	53 7/8	52	183	32	FLT1654-52SD	\$2,388		
	15 15/16	53 7/8	52	183	32	FLV1654-52SD		\$3,725	\$4,098
	15 15/16	47 7/8	52	167	28	FLT1648-52SD	\$2,309		
	15 15/16	47 7/8	52	167	28	FLV1648-52SD		\$3,602	\$3,961
	15 15/16	41 7/8	52	152	25	FLT1642-52SD	\$2,239		
	15 15/16	41 7/8	52	152	25	FLV1642-52SD		\$3,491	\$3,840

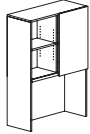
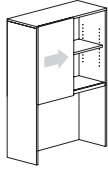

54" wide



48" wide

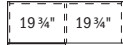

42" wide

Features:

- use with primary height units, fastening hardware included
- backside of unit intended to go against wall, cabinet should be secured to wall as a safety precaution
- laminate grain direction runs horizontal on back panel of overhead cabinets
- 22 3/4" vertical clearance between worksurface and bottom of door, excluding task light
- two 5/8" dia. holes in upper corners of back panel for task light wiring access
- exterior back panel unfinished
- locking not available
- adjustable shelves

Options:

- must specify chassis grain direction on artisan veneer, see pages 13-15 for details
- veneer door fronts in paint available, specify paint color and add \$372 list; see page 16 for details
- on laminate units, contrasting laminate door fronts available, no upcharge; specify laminate color, see page 16 for details
- white glass doors with aluminum trim available, specify and add \$1,275 list for 54"w, \$1,172 list for 48"w, \$1,068 list for 42"w; see page 33 for details
- markerboard laminate doors available, specify and add \$317 list; see page 33 for details
- tackboard or markerboard available, see pages 292-295
- tasklights available, see page 455

Double Height Storage Overhead Cabinet with Sliding Door	15 15/16	35 7/8	52	136	22	FLT1636-52SD	\$2,124		
	15 15/16	35 7/8	52	136	22	FLV1636-52SD		\$3,313	\$3,644
	15 15/16	29 7/8	52	121	18	FLT1630-52SD	\$2,039		
	15 15/16	29 7/8	52	121	18	FLV1630-52SD		\$3,179	\$3,498

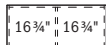
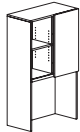
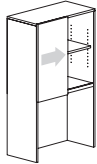

36" wide



30" wide

Features:

- use with primary height units, fastening hardware included
- backside of unit intended to go against wall, cabinet should be secured to wall as a safety precaution
- laminate grain direction runs horizontal on back panel of overhead cabinets
- 22 3/4" vertical clearance between worksurface and bottom of door, excluding task light
- two 5/8" dia. holes in upper corners of back panel for task light wiring access
- exterior back panel unfinished
- locking not available
- adjustable shelves

Options:

- must specify chassis grain direction on artisan veneer, see pages 13-15 for details
- veneer door fronts in paint available, specify paint color and add \$372 list; see page 16 for details
- on laminate units, contrasting laminate door fronts available, no upcharge; specify laminate color, see page 16 for details
- white glass doors with aluminum trim available, specify and add \$962 list for 36"w, \$858 list for 30"w; see page 33 for details
- markerboard laminate doors available, specify and add \$317 list; see page 33 for details
- tackboard or markerboard available, see pages 292-295
- tasklights available, see page 455

To Order, Specify:

① Laminate Model #	② Laminate Selection	③ Metal Color	④ Other Product Options
Laminate (FLT)	See Laminate Selection	See Metal Finish Color Options	See list of options for each specific unit; Specify and add accordingly.

① Veneer Model #	② Wood Collection	③ Wood Finish	④ Metal Color	⑤ Other Product Options		
Veneer (FLV)	Essentials	See Essentials Wood Finish Options	See Metal Finish Color Options	See list of options for each specific unit; Specify and add accordingly.		
	Artisan	<table border="1"> <thead> <tr> <th>ⓐ Wood Finish</th> <th>ⓑ Chassis Grain Direction</th> </tr> </thead> <tbody> <tr> <td>See Artisan Wood Finish Options</td> <td>For Artisan Only: Vertical Horizontal</td> </tr> </tbody> </table>	ⓐ Wood Finish		ⓑ Chassis Grain Direction	See Artisan Wood Finish Options
ⓐ Wood Finish	ⓑ Chassis Grain Direction					
See Artisan Wood Finish Options	For Artisan Only: Vertical Horizontal					

Description	D	W	H	CTN WT	CU FT	① Model	Laminate	Essentials Veneer	Artisan Veneer
Double Height Open Storage Overhead Cabinet	15	95 7/8"	52	257	52	FLT1596-5200	\$2,691		
	15	95 7/8"	52	257	52	FLV1596-5200		\$4,559	\$5,014
	15	89 13/16"	52	244	49	FLT1590-5200	\$2,528		
	15	89 13/16"	52	244	49	FLV1590-5200		\$4,282	\$4,711
	15	83 7/8"	52	231	46	FLT1584-5200	\$2,365		
	15	83 7/8"	52	231	46	FLV1584-5200		\$4,000	\$4,399

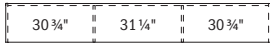
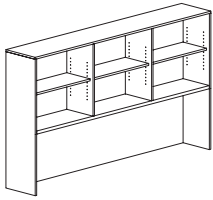

96" wide



90" wide

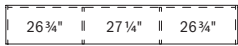

84" wide

Features:

- use with primary height units, fastening hardware included
- laminate grain direction runs horizontal on back panel of overhead cabinets
- backside of unit intended to go against wall, cabinet should be secured to wall as a safety precaution
- 23" vertical clearance between worksurface and bottom of cabinet, excluding task light
- two 5/8" dia. holes in upper corners of back panel for task light wiring access
- exterior back panel unfinished
- adjustable shelves

Options:

- must specify chassis grain direction on artisan veneer, see pages 13-15 for details
- tackboard or markerboard available, see pages 292-295
- tasklights available, see page 455

Description	D	W	H	CTN WT	CU FT	① Model	Laminate	Essentials Veneer	Artisan Veneer
Double Height Open Storage Overhead Cabinet	15	77 7/8"	52	210	43	FLT1578-5200	\$2,203		
	15	77 7/8"	52	210	43	FLV1578-5200		\$3,606	\$3,966
	15	71 7/8"	52	197	40	FLT1572-5200	\$2,076		
	15	71 7/8"	52	197	40	FLV1572-5200		\$3,399	\$3,737
	15	65 7/8"	52	189	37	FLT1566-5200	\$1,962		
	15	65 7/8"	52	189	37	FLV1566-5200		\$3,209	\$3,532
	15	59 7/8"	52	175	33	FLT1560-5200	\$1,875		
	15	59 7/8"	52	175	33	FLV1560-5200		\$3,071	\$3,378

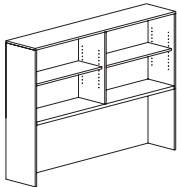

78" wide



72" wide

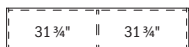

66" wide

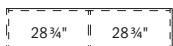

60" wide

Features:

- use with primary height units, fastening hardware included
- laminate grain direction runs horizontal on back panel of overhead cabinets
- backside of unit intended to go against wall, cabinet should be secured to wall as a safety precaution
- 23" vertical clearance between worksurface and bottom of cabinet, excluding task light
- two 5/8" dia. holes in upper corners of back panel for task light wiring access
- exterior back panel unfinished
- adjustable shelves

Options:

- must specify chassis grain direction on artisan veneer, see pages 13-15 for details
- tackboard or markerboard available, see pages 292-295
- tasklights available, see page 455

FLUX

Description	D	W	H	CTN WT	CU FT	① Model	Laminate	Essentials Veneer	Artisan Veneer
Double Height Open Storage Overhead Cabinet	15	53 7/8	52	162	30	FLT1554-5200	\$1,835		
	15	53 7/8	52	162	30	FLV1554-5200		\$2,953	\$3,248
	15	47 7/8	52	148	27	FLT1548-5200	\$1,770		
	15	47 7/8	52	148	27	FLV1548-5200		\$2,851	\$3,137
	15	41 7/8	52	134	24	FLT1542-5200	\$1,715		
	15	41 7/8	52	134	24	FLV1542-5200		\$2,759	\$3,037

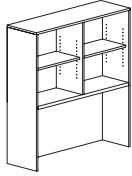

54" wide



48" wide

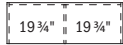

42" wide

Features:

- use with primary height units, fastening hardware included
- laminate grain direction runs horizontal on back panel of overhead cabinets
- backside of unit intended to go against wall, cabinet should be secured to wall as a safety precaution
- 23" vertical clearance between worksurface and bottom of cabinet, excluding task light
- two 5/8" dia. holes in upper corners of back panel for task light wiring access
- exterior back panel unfinished
- adjustable shelves

Options:

- must specify chassis grain direction on artisan veneer, see pages 13-15 for details
- tackboard or markerboard available, see pages 292-295
- tasklights available, see page 455

Double Height Open Storage Overhead Cabinet	15	35 7/8	52	110	21	FLT1536-5200	\$1,626		
	15	35 7/8	52	110	21	FLV1536-5200		\$2,616	\$2,879
	15	29 7/8	52	97	17	FLT1530-5200	\$1,558		
	15	29 7/8	52	97	17	FLV1530-5200		\$2,507	\$2,757

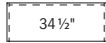
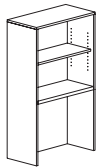

36" wide



30" wide

Features:

- use with primary height units, fastening hardware included
- laminate grain direction runs horizontal on back panel of overhead cabinets
- backside of unit intended to go against wall, cabinet should be secured to wall as a safety precaution
- 23" vertical clearance between worksurface and bottom of cabinet, excluding task light
- two 5/8" dia. holes in upper corners of back panel for task light wiring access
- exterior back panel unfinished
- adjustable shelves

Options:

- must specify chassis grain direction on artisan veneer, see pages 13-15 for details
- tackboard or markerboard available, see pages 292-295
- tasklights available, see page 455

To Order, Specify:

① Laminate Model #	② Laminate Selection	③ Metal Color	④ Other Product Options
Laminate (FLT)	See Laminate Selection	See Metal Finish Color Options	See list of options for each specific unit; Specify and add accordingly.

① Veneer Model #	② Wood Collection	③ Wood Finish	④ Metal Color	⑤ Other Product Options		
Veneer (FLV)	Essentials	See Essentials Wood Finish Options	See Metal Finish Color Options	See list of options for each specific unit; Specify and add accordingly.		
	Artisan	<table border="1"> <thead> <tr> <th>③a Wood Finish</th> <th>③b Chassis Grain Direction</th> </tr> </thead> <tbody> <tr> <td>See Artisan Wood Finish Options</td> <td>For Artisan Only: Vertical Horizontal</td> </tr> </tbody> </table>	③a Wood Finish		③b Chassis Grain Direction	See Artisan Wood Finish Options
③a Wood Finish	③b Chassis Grain Direction					
See Artisan Wood Finish Options	For Artisan Only: Vertical Horizontal					

Description	D	W	H	CTN WT	CU FT	① Model	Laminate	Essentials Veneer	Artisan Veneer
Storage Overhead Cabinet with Six Doors	15 $\frac{7}{8}$ "	95 $\frac{7}{8}$ "	40"	232	43	FLT1696-40SO	\$2,474		
	15 $\frac{7}{8}$ "	95 $\frac{7}{8}$ "	40"	232	43	FLV1696-40SO		\$4,192	\$4,609
	15 $\frac{7}{8}$ "	89 $\frac{7}{8}$ "	40"	220	40	FLT1690-40SO	\$2,325		
	15 $\frac{7}{8}$ "	89 $\frac{7}{8}$ "	40"	220	40	FLV1690-40SO		\$3,938	\$4,330
	15 $\frac{7}{8}$ "	83 $\frac{7}{8}$ "	40"	208	38	FLT1684-40SO	\$2,174		
	15 $\frac{7}{8}$ "	83 $\frac{7}{8}$ "	40"	208	38	FLV1684-40SO		\$3,677	\$4,044

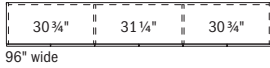
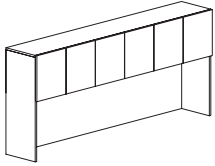

96" wide



90" wide

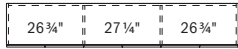

84" wide

Features:

- use with primary height units, fastening hardware included
- laminate grain direction runs horizontal on back panel of overhead cabinets
- 1/4" overhang at the bottom of the door allows access
- 22 3/4" vertical clearance between worksurface and bottom of door, excluding task light
- two 5/8" dia. holes in upper corners of back panel for task light wiring access
- exterior back panel unfinished

Options:

- must specify chassis grain direction on artisan veneer, see pages 13-15 for details
- veneer door fronts in paint available, specify paint color and add \$372 list; see page 16 for details
- on laminate units, contrasting laminate door fronts available, no upcharge; specify laminate color, see page 16 for details
- white glass doors with aluminum trim available, specify and add \$3,692 list; see page 33 for details
- markerboard laminate doors available, specify and add \$1,263 list; see page 33 for details
- locking doors available, specify and add \$459 list (not available on glass doors)
- tackboard or markerboard available, see pages 292-295
- tasklights available, see page 455

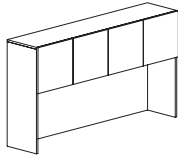
Description	D	W	H	CTN WT	CU FT	① Model	Laminate	Essentials Veneer	Artisan Veneer
Storage Overhead Cabinet with Four Doors 	15 7/8	77 7/8	40	192	35	FLT1678-40SO	\$2,023		
	15 7/8	77 7/8	40	192	35	FLV1678-40SO		\$3,316	\$3,648
	15 7/8	71 7/8	40	178	33	FLT1672-40SO	\$1,910		
	15 7/8	71 7/8	40	178	33	FLV1672-40SO		\$3,123	\$3,436
	15 7/8	65 7/8	40	172	30	FLT1666-40SO	\$1,801		
	15 7/8	65 7/8	40	172	30	FLV1666-40SO		\$2,952	\$3,246
	15 7/8	59 7/8	40	160	27	FLT1660-40SO	\$1,724		
	15 7/8	59 7/8	40	160	27	FLV1660-40SO		\$2,823	\$3,104



78" wide



72" wide



66" wide



60" wide

Features:

- use with primary height units, fastening hardware included
- laminate grain direction runs horizontal on back panel of overhead cabinets
- 1/4" overhang at the bottom of the door allows access
- 22 3/4" vertical clearance between worksurface and bottom of door, excluding task light
- two 5/8" dia. holes in upper corners of back panel for task light wiring access
- exterior back panel unfinished

Options:

- must specify chassis grain direction on artisan veneer, see pages 13-15 for details
- veneer door fronts in paint available, specify paint color and add \$372 list; see page 16 for details
- on laminate units, contrasting laminate door fronts available, no upcharge; specify laminate color, see page 16 for details
- white glass doors with aluminum trim available, specify and add \$2,683 list for 78"w, \$2,560 list for 72"w, \$2,464 list for 66"w or 60"w; see page 33 for details
- markerboard laminate doors available, specify and add \$843 list; see page 33 for details
- locking doors available, specify and add \$306 list (not available on glass doors)
- tackboard or markerboard available, see pages 292-295
- tasklights available, see page 455

To Order, Specify:

① Laminate Model #	② Laminate Selection	③ Metal Color	④ Other Product Options
Laminate (FLT)	See Laminate Selection	See Metal Finish Color Options	See list of options for each specific unit; Specify and add accordingly.

① Veneer Model #	② Wood Collection	③ Wood Finish	④ Metal Color	⑤ Other Product Options		
Veneer (FLV)	Essentials	See Essentials Wood Finish Options	See Metal Finish Color Options	See list of options for each specific unit; Specify and add accordingly.		
	Artisan	<table border="1"> <thead> <tr> <th>③a Wood Finish</th> <th>③b Chassis Grain Direction</th> </tr> </thead> <tbody> <tr> <td>See Artisan Wood Finish Options</td> <td>For Artisan Only: Vertical Horizontal</td> </tr> </tbody> </table>	③a Wood Finish		③b Chassis Grain Direction	See Artisan Wood Finish Options
③a Wood Finish	③b Chassis Grain Direction					
See Artisan Wood Finish Options	For Artisan Only: Vertical Horizontal					

Description	D	W	H	CTN WT	CU FT	① Model	Laminate	Essentials Veneer	Artisan Veneer
Storage Overhead Cabinet with Three Doors	15 7/8	53 7/8	40	147	25	FLT1654-40SOR	\$1,686		
	15 7/8	53 7/8	40	147	25	FLV1654-40SOR		\$2,712	\$2,985
	15 7/8	53 7/8	40	147	25	FLT1654-40SOL	\$1,686		
	15 7/8	53 7/8	40	147	25	FLV1654-40SOL		\$2,712	\$2,985
	15 7/8	47 7/8	40	134	22	FLT1648-40SOR	\$1,628		
	15 7/8	47 7/8	40	134	22	FLV1648-40SOR		\$2,620	\$2,883
	15 7/8	47 7/8	40	134	22	FLT1648-40SOL	\$1,628		
	15 7/8	47 7/8	40	134	22	FLV1648-40SOL		\$2,620	\$2,883
	15 7/8	41 7/8	40	122	20	FLT1642-40SOR	\$1,578		
	15 7/8	41 7/8	40	122	20	FLV1642-40SOR		\$2,540	\$2,791
	15 7/8	41 7/8	40	122	20	FLT1642-40SOL	\$1,578		
	15 7/8	41 7/8	40	122	20	FLV1642-40SOL		\$2,540	\$2,791

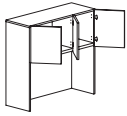
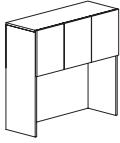

right shown

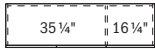

54" wide

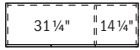

48" wide

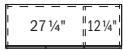

42" wide

Features:

- use with primary height units, fastening hardware included
- laminate grain direction runs horizontal on back panel of overhead cabinets
- 1/4" overhang at the bottom of the door allows access
- 22 3/4" vertical clearance between worksurface and bottom of door, excluding task light
- two 5/8" dia. holes in upper corners of back panel for task light wiring access
- exterior back panel unfinished

Options:

- must specify chassis grain direction on artisan veneer, see pages 13-15 for details
- veneer door fronts in paint available, specify paint color and add \$372 list; see page 16 for details
- on laminate units, contrasting laminate door fronts available, no upcharge; specify laminate color, see page 16 for details
- white glass doors with aluminum trim available, specify and add \$1,922 list for 54"w, \$1,847 list for 48"w or 42"w; see page 33 for details
- markerboard laminate doors available, specify and add \$634 list; see page 33 for details
- locking doors available, specify and add \$306 list (not available on glass doors)
- tackboard or markerboard available, see pages 292-295
- tasklights available, see page 455

Description	D	W	H	CTN WT	CU FT	① Model	Laminate	Essentials Veneer	Artisan Veneer
Storage Overhead Cabinet with Two Doors	15 7/8	35 7/8	40	102	17	FLT1636-40SO	\$1,497		
	15 7/8	35 7/8	40	102	17	FLV1636-40SO		\$2,406	\$2,645
	15 7/8	29 7/8	40	90	14	FLT1630-40SO	\$1,433		
	15 7/8	29 7/8	40	90	14	FLV1630-40SO		\$2,304	\$2,538

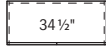
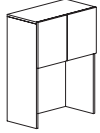

36" wide



30" wide

Features:

- use with primary height units, fastening hardware included
- laminate grain direction runs horizontal on back panel of overhead cabinets
- 1/4" overhang at the bottom of the door allows access
- 22 3/4" vertical clearance between worksurface and bottom of door, excluding task light
- two 5/8" dia. holes in upper corners of back panel for task light wiring access
- exterior back panel unfinished

Options:

- must specify chassis grain direction on artisan veneer, see pages 13-15 for details
- veneer door fronts in paint available, specify paint color and add \$372 list; see page 16 for details
- on laminate units, contrasting laminate door fronts available, no upcharge; specify laminate color, see page 16 for details
- white glass doors with aluminum trim available, specify and add \$1,284 list for 36"w, \$1,234 list for 30"w; see page 33 for details
- markerboard laminate doors available, specify and add \$426 list; see page 33 for details
- locking doors available, specify and add \$153 list (not available on glass doors)
- tackboard or markerboard available, see pages 292-295
- tasklights available, see page 455

To Order, Specify:

① Laminate Model #	② Laminate Selection	③ Metal Color	④ Other Product Options
Laminate (FLT)	See Laminate Selection	See Metal Finish Color Options	See list of options for each specific unit; Specify and add accordingly.

① Veneer Model #	② Wood Collection	③ Wood Finish	④ Metal Color	⑤ Other Product Options		
Veneer (FLV)	Essentials	See Essentials Wood Finish Options	See Metal Finish Color Options	See list of options for each specific unit; Specify and add accordingly.		
	Artisan	<table border="1"> <thead> <tr> <th>③a Wood Finish</th> <th>③b Chassis Grain Direction</th> </tr> </thead> <tbody> <tr> <td>See Artisan Wood Finish Options</td> <td>For Artisan Only: Vertical Horizontal</td> </tr> </tbody> </table>	③a Wood Finish		③b Chassis Grain Direction	See Artisan Wood Finish Options
③a Wood Finish	③b Chassis Grain Direction					
See Artisan Wood Finish Options	For Artisan Only: Vertical Horizontal					

Description	D	W	H	CTN WT	CU FT	① Model	Laminate	Essentials Veneer	Artisan Veneer
Storage Overhead Cabinet with Four Doors and Open Center	15 7/8"	95 7/8"	40"	221	43	FLT1696-40SMO	\$2,349		
	15 7/8"	95 7/8"	40"	221	43	FLV1696-40SMO		\$3,977	\$4,374
	15 7/8"	89 7/8"	40"	209	40	FLT1690-40SMO	\$2,175		
	15 7/8"	89 7/8"	40"	209	40	FLV1690-40SMO		\$3,680	\$4,047
	15 7/8"	83 7/8"	40"	198	38	FLT1684-40SMO	\$1,999		
	15 7/8"	83 7/8"	40"	198	38	FLV1684-40SMO		\$3,380	\$3,719

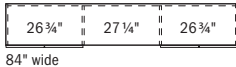
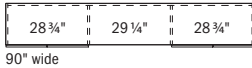
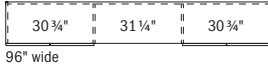
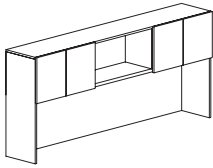

Features:

- use with primary height units, fastening hardware included
- laminate grain direction runs horizontal on back panel of overhead cabinets
- 1/4" overhang at the bottom of the door allows access
- 22 3/4" vertical clearance between worksurface and bottom of door, excluding task light
- two 5/8" dia. holes in upper corners of back panel for task light wiring access
- exterior back panel unfinished

Options:

- must specify chassis grain direction on artisan veneer, see pages 13-15 for details
- veneer door fronts in paint available, specify paint color and add \$372 list; see page 16 for details
- on laminate units, contrasting laminate door fronts available, no upcharge; specify laminate color, see page 16 for details
- white glass doors with aluminum trim available, specify and add \$2,464 list; see page 33 for details
- markerboard laminate doors available, specify and add \$843 list; see page 33 for details
- locking doors available, specify and add \$306 list (not available on glass doors)
- tackboard or markerboard available, see pages 292-295
- tasklights available, see page 455

Storage Overhead Cabinet with Two Doors and Open Compartment	15 7/8"	77 7/8"	40"	180	35	FLT1678-40SMOR	\$1,924		
	15 7/8"	77 7/8"	40"	180	35	FLV1678-40SMOR		\$3,150	\$3,462
	15 7/8"	77 7/8"	40"	180	35	FLT1678-40SMOL	\$1,924		
	15 7/8"	77 7/8"	40"	180	35	FLV1678-40SMOL		\$3,150	\$3,462
	15 7/8"	71 7/8"	40"	169	33	FLT1672-40SMOR	\$1,813		
	15 7/8"	71 7/8"	40"	169	33	FLV1672-40SMOR		\$2,968	\$3,266
	15 7/8"	71 7/8"	40"	169	33	FLT1672-40SMOL	\$1,813		
	15 7/8"	71 7/8"	40"	169	33	FLV1672-40SMOL		\$2,968	\$3,266
	15 7/8"	65 7/8"	40"	163	30	FLT1666-40SMOR	\$1,715		
	15 7/8"	65 7/8"	40"	163	30	FLV1666-40SMOR		\$2,806	\$3,086
	15 7/8"	65 7/8"	40"	163	30	FLT1666-40SMOL	\$1,715		
	15 7/8"	65 7/8"	40"	163	30	FLV1666-40SMOL		\$2,806	\$3,086
	15 7/8"	59 7/8"	40"	152	27	FLT1660-40SMOR	\$1,638		
	15 7/8"	59 7/8"	40"	152	27	FLV1660-40SMOR		\$2,681	\$2,951
	15 7/8"	59 7/8"	40"	152	27	FLT1660-40SMOL	\$1,638		
	15 7/8"	59 7/8"	40"	152	27	FLV1660-40SMOL		\$2,681	\$2,951

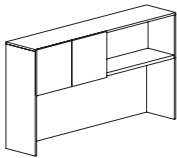

left shown

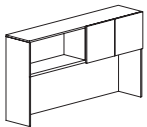

right

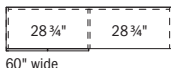
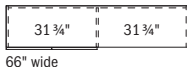
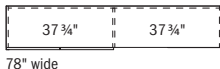

Features:

- use with primary height units, fastening hardware included
- laminate grain direction runs horizontal on back panel of overhead cabinets
- 1/4" overhang at the bottom of the door allows access
- 22 3/4" vertical clearance between worksurface and bottom of door, excluding task light
- two 5/8" dia. holes in upper corners of back panel for task light wiring access
- exterior back panel unfinished

Options:

- must specify chassis grain direction on artisan veneer, see pages 13-15 for details
- veneer door fronts in paint available, specify paint color and add \$372 list; see page 16 for details
- on laminate units, contrasting laminate door fronts available, no upcharge; specify laminate color, see page 16 for details
- white glass doors with aluminum trim available, specify and add \$1,343 list for 78"w, \$1,284 list for 72"w, \$1,234 list for 66"w or 60"w; see page 33 for details
- markerboard laminate doors available, specify and add \$426 list; see page 33 for details
- locking doors available, specify and add \$153 list (not available on glass doors)
- tackboard or markerboard available, see pages 292-295
- tasklights available, see page 455

Description	D	W	H	CTN WT	CU FT	① Model	Laminate	Essentials Veneer	Artisan Veneer
Storage Overhead Cabinet with Two Doors with Open Center	15 7/8	53 7/8	40	145	25	FLT1654-40SMO	\$1,602		
	15 7/8	53 7/8	40	145	25	FLV1654-40SMO		\$2,582	\$2,838
	15 7/8	47 7/8	40	133	22	FLT1648-40SMO	\$1,550		
	15 7/8	47 7/8	40	133	22	FLV1648-40SMO		\$2,492	\$2,743
	15 7/8	41 7/8	40	121	20	FLT1642-40SMO	\$1,499		
	15 7/8	41 7/8	40	121	20	FLV1642-40SMO		\$2,412	\$2,653

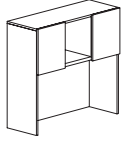

54" wide



48" wide



42" wide

Features:

- use with primary height units, fastening hardware included
- laminate grain direction runs horizontal on back panel of overhead cabinets
- 1/4" overhang at the bottom of the door allows access
- 22 3/4" vertical clearance between worksurface and bottom of door, excluding task light
- two 5/8" dia. holes in upper corners of back panel for task light wiring access
- exterior back panel unfinished

Options:

- must specify chassis grain direction on artisan veneer, see pages 13-15 for details
- veneer door fronts in paint available, specify paint color and add \$372 list; see page 16 for details
- on laminate units, contrasting laminate door fronts available, no upcharge; specify laminate color, see page 16 for details
- white glass doors with aluminum trim available, specify and add \$1,284 list for 54"w, \$1,234 list for 48"w or 42"w; see page 33 for details
- markerboard laminate doors available, specify and add \$426 list; see page 33 for details
- locking doors available, specify and add \$306 list (not available on glass doors)
- tackboard or markerboard available, see pages 292-295
- tasklights available, see page 455

To Order, Specify:

① Laminate Model #	② Laminate Selection	③ Metal Color	④ Other Product Options
Laminate (FLT)	See Laminate Selection	See Metal Finish Color Options	See list of options for each specific unit; Specify and add accordingly.

① Veneer Model #	② Wood Collection	③ Wood Finish	④ Metal Color	⑤ Other Product Options		
Veneer (FLV)	Essentials	See Essentials Wood Finish Options	See Metal Finish Color Options	See list of options for each specific unit; Specify and add accordingly.		
	Artisan	<table border="1"> <thead> <tr> <th>③a Wood Finish</th> <th>③b Chassis Grain Direction</th> </tr> </thead> <tbody> <tr> <td>See Artisan Wood Finish Options</td> <td>For Artisan Only: Vertical Horizontal</td> </tr> </tbody> </table>	③a Wood Finish		③b Chassis Grain Direction	See Artisan Wood Finish Options
③a Wood Finish	③b Chassis Grain Direction					
See Artisan Wood Finish Options	For Artisan Only: Vertical Horizontal					

Description	D	W	H	CTN WT	CU FT	① Model	Laminate	Essentials Veneer	Artisan Veneer
Storage Overhead Cabinet with Sliding Doors	15 15/16	95 7/8	40	232	43	FLT1696-40SD	\$2,782		
	15 15/16	95 7/8	40	232	43	FLV1696-40SD		\$4,557	\$5,013
	15 15/16	89 7/8	40	220	41	FLT1690-40SD	\$2,575		
	15 15/16	89 7/8	40	220	41	FLV1690-40SD		\$4,223	\$4,643
	15 15/16	83 7/8	40	209	38	FLT1684-40SD	\$2,372		
	15 15/16	83 7/8	40	209	38	FLV1684-40SD		\$3,885	\$4,274

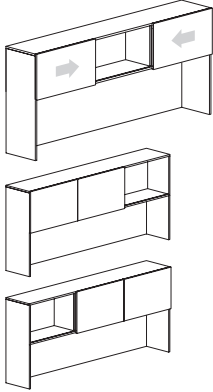

Features:

- use with primary height units, fastening hardware included
- laminate grain direction runs horizontal on back panel of overhead cabinets
- 22 3/4" vertical clearance between worksurface and bottom of door, excluding task light
- two 5/8" dia. holes in upper corners of back panel for task light wiring access
- exterior back panel unfinished
- locking not available

Options:

- must specify chassis grain direction on artisan veneer, see pages 13-15 for details
- veneer door fronts in paint available, specify paint color and add \$372 list; see page 16 for details
- on laminate units, contrasting laminate door fronts available, no upcharge; specify laminate color, see page 16 for details
- white glass doors with aluminum trim available, specify and add \$1,971 list for 96"w, \$1,890 list for 90"w, \$1,808 list for 84"w; see page 33 for details
- markerboard laminate doors available, specify and add \$628 list; see page 33 for details
- tackboard or markerboard available, see pages 292-295
- tasklights available, see page 455

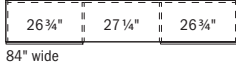
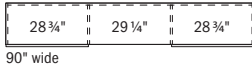
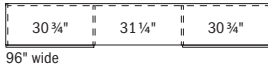

Storage Overhead Cabinet with Sliding Door	15 15/16	77 7/8	40	187	35	FLT1678-40SD	\$2,286		
	15 15/16	77 7/8	40	187	35	FLV1678-40SD		\$3,624	\$3,988
	15 15/16	71 7/8	40	175	33	FLT1672-40SD	\$2,156		
	15 15/16	71 7/8	40	175	33	FLV1672-40SD		\$3,417	\$3,763
	15 15/16	65 7/8	40	164	30	FLT1666-40SD	\$2,042		
	15 15/16	65 7/8	40	164	30	FLV1666-40SD		\$3,237	\$3,559
	15 15/16	59 7/8	40	153	27	FLT1660-40SD	\$1,955		
	15 15/16	59 7/8	40	153	27	FLV1660-40SD		\$3,096	\$3,406

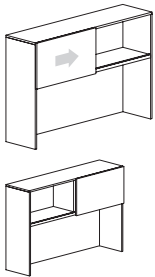

Features:

- use with primary height units, fastening hardware included
- laminate grain direction runs horizontal on back panel of overhead cabinets
- 22 3/4" vertical clearance between worksurface and bottom of door, excluding task light
- two 5/8" dia. holes in upper corners of back panel for task light wiring access
- exterior back panel unfinished
- locking not available

Options:

- must specify chassis grain direction on artisan veneer, see pages 13-15 for details
- veneer door fronts in paint available, specify paint color and add \$372 list; see page 16 for details
- on laminate units, contrasting laminate door fronts available, no upcharge; specify laminate color, see page 16 for details
- white glass doors with aluminum trim available, specify and add \$1,136 list for 78"w, \$1,071 list for 72"w, \$1,011 list for 66"w \$947 list for 60"w; see page 33 for details
- markerboard laminate doors available, specify and add \$317 list; see page 33 for details
- tackboard or markerboard available, see pages 292-295
- tasklights available, see page 455

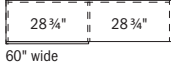
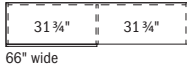

Description	D	W	H	CTN WT	CU FT	① Model	Laminate	Essentials Veneer	Artisan Veneer
Storage Overhead Cabinet with Sliding Door	15 15/16	53 7/8	40	141	25	FLT1654-40SD	\$1,911		
	15 15/16	53 7/8	40	141	25	FLV1654-40SD		\$2,980	\$3,279
	15 15/16	47 7/8	40	130	22	FLT1648-40SD	\$1,846		
	15 15/16	47 7/8	40	130	22	FLV1648-40SD		\$2,882	\$3,170
	15 15/16	41 7/8	40	119	20	FLT1642-40SD	\$1,791		
	15 15/16	41 7/8	40	119	20	FLV1642-40SD		\$2,792	\$3,074

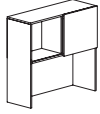
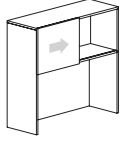

54" wide

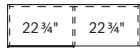

48" wide



42" wide

Features:

- use with primary height units, fastening hardware included
- laminate grain direction runs horizontal on back panel of overhead cabinets
- 22 3/4" vertical clearance between worksurface and bottom of door, excluding task light
- two 5/8" dia. holes in upper corners of back panel for task light wiring access
- exterior back panel unfinished
- locking not available

Options:

- must specify chassis grain direction on artisan veneer, see pages 13-15 for details
- veneer door fronts in paint available, specify paint color and add \$372 list; see page 16 for details
- on laminate units, contrasting laminate door fronts available, no upcharge; specify laminate color, see page 16 for details
- white glass doors with aluminum trim available, specify and add \$887 list for 54"w, \$858 list for 48"w, \$826 list for 42"w; see page 33 for details
- markerboard laminate doors available, specify and add \$317 list; see page 33 for details
- tackboard or markerboard available, see pages 292-295
- tasklights available, see page 455

Storage Overhead Cabinet with Sliding Door	15 15/16	35 7/8	40	107	17	FLT1636-40SD	\$1,700		
	15 15/16	35 7/8	40	107	17	FLV1636-40SD		\$2,652	\$2,917
	15 15/16	29 7/8	40	96	14	FLT1630-40SD	\$1,631		
	15 15/16	29 7/8	40	96	14	FLV1630-40SD		\$2,545	\$2,799

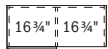
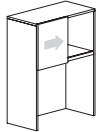

36" wide



30" wide

Features:

- use with primary height units, fastening hardware included
- laminate grain direction runs horizontal on back panel of overhead cabinets
- 22 3/4" vertical clearance between worksurface and bottom of door, excluding task light
- two 5/8" dia. holes in upper corners of back panel for task light wiring access
- exterior back panel unfinished
- locking not available

Options:

- must specify chassis grain direction on artisan veneer, see pages 13-15 for details
- veneer door fronts in paint available, specify paint color and add \$372 list; see page 16 for details
- on laminate units, contrasting laminate door fronts available, no upcharge; specify laminate color, see page 16 for details
- white glass doors with aluminum trim available, specify and add \$702 list for 36"w, \$670 list for 30"w; see page 33 for details
- markerboard laminate doors available, specify and add \$317 list; see page 33 for details
- tackboard or markerboard available, see pages 292-295
- tasklights available, see page 455

To Order, Specify:

① Laminate Model #	② Laminate Selection	③ Metal Color	④ Other Product Options
Laminate (FLT)	See Laminate Selection	See Metal Finish Color Options	See list of options for each specific unit; Specify and add accordingly.

① Veneer Model #	② Wood Collection	③ Wood Finish	④ Metal Color	⑤ Other Product Options		
Veneer (FLV)	Essentials	See Essentials Wood Finish Options	See Metal Finish Color Options	See list of options for each specific unit; Specify and add accordingly.		
	Artisan	<table border="1"> <thead> <tr> <th>③a Wood Finish</th> <th>③b Chassis Grain Direction</th> </tr> </thead> <tbody> <tr> <td>See Artisan Wood Finish Options</td> <td>For Artisan Only: Vertical Horizontal</td> </tr> </tbody> </table>	③a Wood Finish		③b Chassis Grain Direction	See Artisan Wood Finish Options
③a Wood Finish	③b Chassis Grain Direction					
See Artisan Wood Finish Options	For Artisan Only: Vertical Horizontal					

Description	D	W	H	CTN WT	CU FT	① Model	Laminate	Essentials Veneer	Artisan Veneer
Open Storage Overhead Cabinet	15	95%	40	199	41	FLT1596-4000	\$2,154		
	15	95%	40	199	41	FLV1596-4000		\$3,648	\$4,013
	15	89%	40	189	38	FLT1590-4000	\$2,023		
	15	89%	40	189	38	FLV1590-4000		\$3,427	\$3,768
	15	83%	40	179	36	FLT1584-4000	\$1,892		
	15	83%	40	179	36	FLV1584-4000		\$3,201	\$3,522

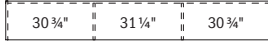
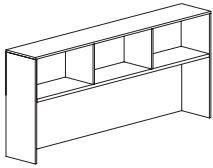

96" wide

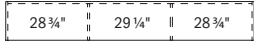

90" wide

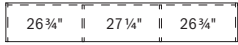

84" wide

Features:

- use with primary height units, fastening hardware included
- laminate grain direction runs horizontal on back panel of overhead cabinets
- 23" vertical clearance between worksurface and bottom of cabinet, excluding task light
- two 5/8" dia. holes in upper corners of back panel for task light wiring access
- exterior back panel unfinished

Options:

- must specify chassis grain direction on artisan veneer, see pages 13-15 for details
- tackboard or markerboard available, see pages 292-295
- tasklights available, see page 455

Open Storage Overhead Cabinet	15	77%	40	164	34	FLT1578-4000	\$1,762		
	15	77%	40	164	34	FLV1578-4000		\$2,884	\$3,174
	15	71%	40	154	31	FLT1572-4000	\$1,664		
	15	71%	40	154	31	FLV1572-4000		\$2,720	\$2,993
	15	65%	40	150	29	FLT1566-4000	\$1,570		
	15	65%	40	150	29	FLV1566-4000		\$2,569	\$2,827
	15	59%	40	139	26	FLT1560-4000	\$1,504		
	15	59%	40	139	26	FLV1560-4000		\$2,456	\$2,702

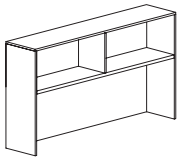

78" wide



72" wide



66" wide

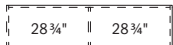

60" wide

Features:

- use with primary height units, fastening hardware included
- laminate grain direction runs horizontal on back panel of overhead cabinets
- 23" vertical clearance between worksurface and bottom of cabinet, excluding task light
- two 5/8" dia. holes in upper corners of back panel for task light wiring access
- exterior back panel unfinished

Options:

- must specify chassis grain direction on artisan veneer, see pages 13-15 for details
- tackboard or markerboard available, see pages 292-295
- tasklights available, see page 455

Description	D	W	H	CTN WT	CU FT	① Model	Laminate	Essentials Veneer	Artisan Veneer
Open Storage Overhead Cabinet	15	53 7/8	40	129	24	FLT1554-4000	\$1,467		
	15	53 7/8	40	129	24	FLV1554-4000		\$2,364	\$2,598
	15	47 7/8	40	118	21	FLT1548-4000	\$1,420		
	15	47 7/8	40	118	21	FLV1548-4000		\$2,282	\$2,510
	15	41 7/8	40	108	19	FLT1542-4000	\$1,374		
	15	41 7/8	40	108	19	FLV1542-4000		\$2,209	\$2,429

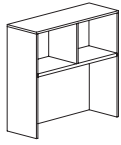

54" wide

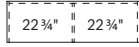

48" wide

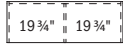

42" wide

Features:

- use with primary height units, fastening hardware included
- laminate grain direction runs horizontal on back panel of overhead cabinets
- 23" vertical clearance between worksurface and bottom of cabinet, excluding task light
- two 5/8" dia. holes in upper corners of back panel for task light wiring access
- exterior back panel unfinished

Options:

- must specify chassis grain direction on artisan veneer, see pages 13-15 for details
- tackboard or markerboard available, see pages 292-295
- tasklights available, see page 455

Open Storage Overhead Cabinet	15	35 7/8	40	90	16	FLT1536-4000	\$1,304		
	15	35 7/8	40	90	16	FLV1536-4000		\$2,092	\$2,302
	15	29 7/8	40	80	14	FLT1530-4000	\$1,248		
	15	29 7/8	40	80	14	FLV1530-4000		\$2,007	\$2,209

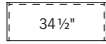
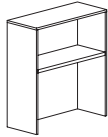

36" wide



30" wide

Features:

- use with primary height units, fastening hardware included
- laminate grain direction runs horizontal on back panel of overhead cabinets
- 23" vertical clearance between worksurface and bottom of cabinet, excluding task light
- two 5/8" dia. holes in upper corners of back panel for task light wiring access
- exterior back panel unfinished

Options:

- must specify chassis grain direction on artisan veneer, see pages 13-15 for details
- tackboard or markerboard available, see pages 292-295
- tasklights available, see page 455

To Order, Specify:

① Laminate Model #	② Laminate Selection	③ Metal Color	④ Other Product Options
Laminate (FLT)	See Laminate Selection	See Metal Finish Color Options	See list of options for each specific unit; Specify and add accordingly.

① Veneer Model #	② Wood Collection	③ Wood Finish	④ Metal Color	⑤ Other Product Options		
Veneer (FLV)	Essentials	See Essentials Wood Finish Options	See Metal Finish Color Options	See list of options for each specific unit; Specify and add accordingly.		
	Artisan	<table border="1"> <thead> <tr> <th>③a Wood Finish</th> <th>③b Chassis Grain Direction</th> </tr> </thead> <tbody> <tr> <td>See Artisan Wood Finish Options</td> <td>For Artisan Only: Vertical Horizontal</td> </tr> </tbody> </table>	③a Wood Finish		③b Chassis Grain Direction	See Artisan Wood Finish Options
③a Wood Finish	③b Chassis Grain Direction					
See Artisan Wood Finish Options	For Artisan Only: Vertical Horizontal					

Description	D	W	H	CTN WT	CU FT	① Model	List Price
Overhead Cabinet Markerboard Panel 	13/16	94 1/4	22	57	5	FLB9523CMB	\$1,446
	13/16	88 1/4	22	53	4	FLB8923CMB	\$1,356
	13/16	82 1/4	22	69	6	FLB8323CMB	\$1,265
	13/16	76 1/4	22	46	4	FLB7723CMB	\$1,172
	13/16	70 1/4	22	42	4	FLB7123CMB	\$1,080
	13/16	64 1/4	22	54	4	FLB6523CMB	\$987
	13/16	58 1/4	22	35	3	FLB5923CMB	\$897
	13/16	52 1/4	22	32	3	FLB5323CMB	\$805
	13/16	46 1/4	22	28	3	FLB4723CMB	\$714
	13/16	40 1/4	22	25	2	FLB4123CMB	\$621
	13/16	34 1/4	22	21	2	FLB3523CMB	\$529
13/16	28 1/4	22	18	2	FLB2923CMB	\$438	

Features:

- use with 40”h and 52”h overhead cabinets
- standard markerboard laminate with aluminum pvc edge
- attaches to cabinet interior, mounting hardware included

FLUX

Description	D	W	H	CTN WT	CU FT	① Model	List Price Per Grade	
96”w Tackboard for Overhead Cabinet 	13/16	94 1/4	22	25	4	FLB9522TK	COM \$823	
								A \$959
								B \$986
								C \$1,067
								D \$1,182
								E \$1,286
								F \$1,402
								G \$1,542
								H \$1,747
								I \$1,810
								J \$1,985

Features:

- for use with 96” wide storage overhead cabinet
- use with 40”h and 52”h overhead cabinets
- attaches to cabinet interior, mounting hardware included
- com ydg: 3

90”w Tackboard for Overhead Cabinet 	13/16	88 1/4	22	23	4	FLB8922TK	COM \$787	
								A \$912
								B \$938
								C \$1,012
								D \$1,116
								E \$1,211
								F \$1,319
								G \$1,447
								H \$1,635
								I \$1,692
								J \$1,854

Features:

- for use with 90”w storage overhead cabinet
- use with 40”h and 52”h overhead cabinets
- attaches to cabinet interior, mounting hardware included
- com ydg: 2 3/4

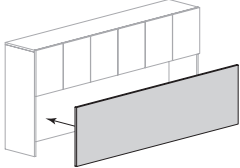
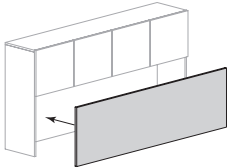
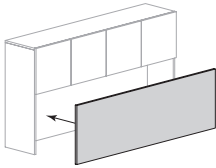
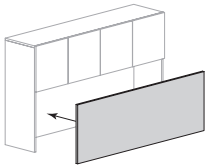
Description	D	W	H	CTN WT	CU FT	① Model	List Price Per Grade
84" w Tackboard for Overhead Cabinet 	13 1/16	82 1/4	22	22	4	FLB8322TK	COM \$752
							A \$866
78" w Tackboard for Overhead Cabinet 	13 1/16	76 1/4	22	20	4	FLB7722TK	COM \$716
							A \$829
72" w Tackboard for Overhead Cabinet 	13 1/16	70 1/4	22	19	3	FLB7122TK	COM \$681
							A \$784
66" w Tackboard for Overhead Cabinet 	13 1/16	64 1/4	22	17	3	FLB6522TK	COM \$645
							A \$735

Features:

- for use with 84" w storage overhead cabinet
- use with 40" h and 52" h overhead cabinets
- attaches to cabinet interior, mounting hardware included
- com ydg: 2 1/2

Features:

- for use with 78" w storage overhead cabinet
- use with 40" h and 52" h overhead cabinets
- attaches to cabinet interior, mounting hardware included
- com ydg: 2 1/2

Features:

- for use with 72" w storage overhead cabinet
- use with 40" h and 52" h overhead cabinets
- attaches to cabinet interior, mounting hardware included
- com ydg: 2 1/4

Features:

- for use with 66" w storage overhead cabinet
- use with 40" h and 52" h overhead cabinets
- attaches to cabinet interior, mounting hardware included
- com ydg: 2

To Order, Specify:

- ① Model Number
- ② Fabric Selection - vendor, pattern and color

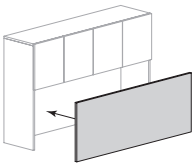
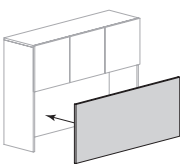
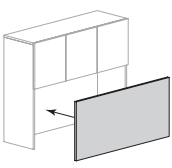
Description	D	W	H	CTN WT	CU FT	① Model	List Price Per Grade
60" w Tackboard for Overhead Cabinet 	13 1/6	58 1/4	22	15	3	FLB5922TK	COM \$609
							A \$701
Features: <ul style="list-style-type: none"> · for use with 60" w storage overhead cabinet · use with 40" h and 52" h overhead cabinets · attaches to cabinet interior, mounting hardware included · com ydg: 2 							
54" w Tackboard for Overhead Cabinet 	13 1/6	52 1/4	22	14	3	FLB5322TK	COM \$574
							A \$654
Features: <ul style="list-style-type: none"> · for use with 54" w storage overhead cabinet · use with 40" h and 52" h overhead cabinets · attaches to cabinet interior, mounting hardware included · com ydg: 1 3/4 							
48" w Tackboard for Overhead Cabinet 	13 1/6	46 1/4	22	12	2	FLB4722TK	COM \$537
							A \$605
Features: <ul style="list-style-type: none"> · for use with 48" w storage overhead cabinet · use with 40" h and 52" h overhead cabinets · attaches to cabinet interior, mounting hardware included · com ydg: 1 1/2 							

FLUX

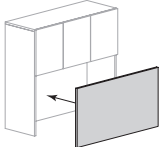
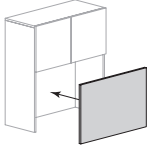
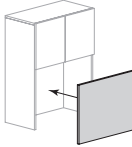
Description	D	W	H	CTN WT	CU FT	① Model	List Price Per Grade		
42" w Tackboard for Overhead Cabinet 	13/16	40 1/4	22	11	2	FLB4122TK	COM \$503 A \$572 B \$586 C \$626 D \$683 E \$735 F \$794 G \$864 H \$966 I \$999 J \$1,087		
	Features: <ul style="list-style-type: none"> · for use with 42" w storage overhead cabinet · use with 40" h and 52" h overhead cabinets · attaches to cabinet interior, mounting hardware included · com ydg: 1 1/2 								
	36" w Tackboard for Overhead Cabinet 	13/16	34 1/4	22	9	2	FLB3522TK	COM \$468 A \$524 B \$536 C \$570 D \$617 E \$660 F \$709 G \$767 H \$854 I \$880 J \$955	
		Features: <ul style="list-style-type: none"> · for use with 36" w storage overhead cabinet · use with 40" h and 52" h overhead cabinets · attaches to cabinet interior, mounting hardware included · com ydg: 1 1/4 							
		30" w Tackboard Overhead Cabinet 	13/16	28 1/4	22	8	2	FLB2922TK	COM \$431 A \$476 B \$486 C \$513 D \$551 E \$585 F \$624 G \$671 H \$741 I \$763 J \$823
			Features: <ul style="list-style-type: none"> · for use with 30" w storage overhead cabinet · use with 40" h and 52" h overhead cabinets · attaches to cabinet interior, mounting hardware included · com ydg: 1 						

FLUX

To Order, Specify:

- ① Model Number
- ② Fabric Selection - vendor, pattern and color

Description	D	W	H	CTN WT	CU FT	① Model	Laminate	Essentials Veneer	Artisan Veneer
Storage Overhead Cabinet with Four Doors	15 7/8"	95 7/8"	48"	254	51	FLT1696-48SO	\$2,561		
	15 7/8"	95 7/8"	48"	254	51	FLV1696-48SO		\$4,337	\$4,772
	15 7/8"	89 7/8"	48"	241	48	FLT1690-48SO	\$2,407		
	15 7/8"	89 7/8"	48"	241	48	FLV1690-48SO		\$4,076	\$4,483
	15 7/8"	83 7/8"	48"	228	45	FLT1684-48SO	\$2,249		
	15 7/8"	83 7/8"	48"	228	45	FLV1684-48SO		\$3,807	\$4,185

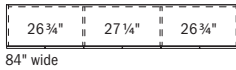
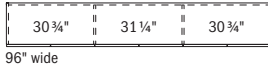
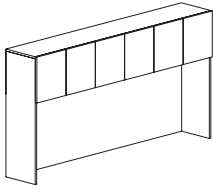

Features:

- use with secondary height units, fastening hardware included
- laminate grain direction runs horizontal on back panel of overhead cabinets
- 1/4" overhang at the bottom of the door allows access
- 30 3/4" vertical clearance between worksurface and bottom of door, excluding task light
- two 5/8" dia. holes in upper corners of back panel for task light wiring access
- exterior back panel unfinished

Options:

- must specify chassis grain direction on artisan veneer, see pages 13-15 for details
- veneer door fronts in paint available, specify paint color and add \$372 list; see page 16 for details
- on laminate units, contrasting laminate door fronts available, no upcharge; specify laminate color, see page 16 for details
- white glass doors with aluminum trim available, specify and add \$3,692 list; see page 33 for details
- markerboard laminate doors available, specify and add \$1,263 list; see page 33 for details
- locking doors available, specify and add \$459 list (not available on glass doors)
- tackboard or markerboard available, see pages 306-309
- tasklights available, see page 455

Description	D	W	H	CTN WT	CU FT	① Model	Laminate	Essentials Veneer	Artisan Veneer
Storage Overhead Cabinet with Four Doors	15 7/8	77 7/8	48	220	42	FLT1678-48SO	\$2,093		
	15 7/8	77 7/8	48	220	42	FLV1678-48SO		\$3,432	\$3,775
	15 7/8	71 7/8	48	197	39	FLT1672-48SO	\$1,973		
	15 7/8	71 7/8	48	197	39	FLV1672-48SO		\$3,234	\$3,557
	15 7/8	65 7/8	48	189	36	FLT1666-48SO	\$1,866		
	15 7/8	65 7/8	48	189	36	FLV1666-48SO		\$3,053	\$3,362
	15 7/8	59 7/8	48	175	33	FLT1660-48SO	\$1,785		
	15 7/8	59 7/8	48	175	33	FLV1660-48SO		\$2,919	\$3,210

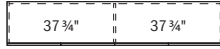
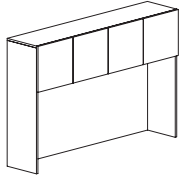

78" wide

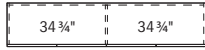

72" wide



66" wide



60" wide

Features:

- use with secondary height units, fastening hardware included
- laminate grain direction runs horizontal on back panel of overhead cabinets
- 1/4" overhang at the bottom of the door allows access
- 30 3/4" vertical clearance between worksurface and bottom of door, excluding task light
- two 5/8" dia. holes in upper corners of back panel for task light wiring access
- exterior back panel unfinished

Options:

- must specify chassis grain direction on artisan veneer, see pages 13-15 for details
- veneer door fronts in paint available, specify paint color and add \$372 list; see page 16 for details
- on laminate units, contrasting laminate door fronts available, no upcharge; specify laminate color, see page 16 for details
- white glass doors with aluminum trim available, specify and add \$2,683 list for 78"w, \$2,560 list for 72"w, \$2,464 list for 66"w or 60"w; see page 33 for details
- markerboard laminate doors available, specify and add \$843 list; see page 33 for details
- locking doors available, specify and add \$306 list (not available on glass doors)
- tackboard or markerboard available, see pages 306-309
- tasklights available, see page 455

To Order, Specify:

① Laminate Model #	② Laminate Selection	③ Metal Color	④ Other Product Options
Laminate (FLT)	See Laminate Selection	See Metal Finish Color Options	See list of options for each specific unit; Specify and add accordingly.

① Veneer Model #	② Wood Collection	③ Wood Finish	④ Metal Color	⑤ Other Product Options		
Veneer (FLV)	Essentials	See Essentials Wood Finish Options	See Metal Finish Color Options	See list of options for each specific unit; Specify and add accordingly.		
	Artisan	<table border="1"> <thead> <tr> <th>③a Wood Finish</th> <th>③b Chassis Grain Direction</th> </tr> </thead> <tbody> <tr> <td>See Artisan Wood Finish Options</td> <td>For Artisan Only: Vertical Horizontal</td> </tr> </tbody> </table>	③a Wood Finish		③b Chassis Grain Direction	See Artisan Wood Finish Options
③a Wood Finish	③b Chassis Grain Direction					
See Artisan Wood Finish Options	For Artisan Only: Vertical Horizontal					

Description	D	W	H	CTN WT	CU FT	① Model	Laminate	Essentials Veneer	Artisan Veneer
Storage Overhead Cabinet with Three Doors	15 $\frac{7}{8}$ "	53 $\frac{7}{8}$ "	48	162	29	FLT1654-48SOR	\$1,745		
	15 $\frac{7}{8}$ "	53 $\frac{7}{8}$ "	48	162	29	FLV1654-48SOR		\$2,810	\$3,092
	15 $\frac{7}{8}$ "	53 $\frac{7}{8}$ "	48	162	29	FLT1654-48SOL	\$1,745		
	15 $\frac{7}{8}$ "	53 $\frac{7}{8}$ "	48	162	29	FLV1654-48SOL		\$2,810	\$3,092
	15 $\frac{7}{8}$ "	47 $\frac{7}{8}$ "	48	148	26	FLT1648-48SOR	\$1,686		
	15 $\frac{7}{8}$ "	47 $\frac{7}{8}$ "	48	148	26	FLV1648-48SOR		\$2,712	\$2,985
	15 $\frac{7}{8}$ "	47 $\frac{7}{8}$ "	48	148	26	FLT1648-48SOL	\$1,686		
	15 $\frac{7}{8}$ "	47 $\frac{7}{8}$ "	48	148	26	FLV1648-48SOL		\$2,712	\$2,985
	15 $\frac{7}{8}$ "	41 $\frac{7}{8}$ "	48	134	23	FLT1642-48SOR	\$1,631		
	15 $\frac{7}{8}$ "	41 $\frac{7}{8}$ "	48	134	23	FLV1642-48SOR		\$2,630	\$2,891
	15 $\frac{7}{8}$ "	41 $\frac{7}{8}$ "	48	134	23	FLT1642-48SOL	\$1,631		
	15 $\frac{7}{8}$ "	41 $\frac{7}{8}$ "	48	134	23	FLV1642-48SOL		\$2,630	\$2,891

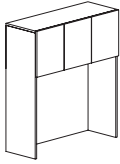

right shown

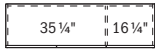

54" wide

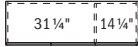

48" wide

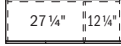

42" wide

Features:

- use with secondary height units, fastening hardware included
- laminate grain direction runs horizontal on back panel of overhead cabinets
- 1/4" overhang at the bottom of the door allows access
- 30 3/4" vertical clearance between worksurface and bottom of door, excluding task light
- two 5/8" dia. holes in upper corners of back panel for task light wiring access
- exterior back panel unfinished

Options:

- must specify chassis grain direction on artisan veneer, see pages 13-15 for details
- veneer door fronts in paint available, specify paint color and add \$372 list; see page 16 for details
- on laminate units, contrasting laminate door fronts available, no upcharge; specify laminate color, see page 16 for details
- white glass doors with aluminum trim available, specify and add \$1,922 list for 54"w, \$1,847 list for 48"w or 42"w; see page 33 for details
- markerboard laminate doors available, specify and add \$634 list; see page 33 for details
- locking doors available, specify and add \$306 list (not available on glass doors)
- tackboard or markerboard available, see pages 306-309
- tasklights available, see page 455

Description	D	W	H	CTN WT	CU FT	① Model	Laminate	Essentials Veneer	Artisan Veneer
Storage Overhead Cabinet with Two Doors	15 7/8	35 7/8	48	113	20	FLT1636-48SO	\$1,549		
	15 7/8	35 7/8	48	113	20	FLV1636-48SO		\$2,491	\$2,742
	15 7/8	29 7/8	48	100	17	FLT1630-48SO	\$1,483		
	15 7/8	29 7/8	48	100	17	FLV1630-48SO		\$2,387	\$2,622

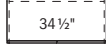
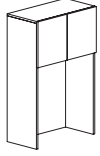

36" wide



30" wide

Features:

- use with secondary height units, fastening hardware included
- laminate grain direction runs horizontal on back panel of overhead cabinets
- 1/4" overhang at the bottom of the door allows access
- 30 3/4" vertical clearance between worksurface and bottom of door, excluding task light
- two 5/8" dia. holes in upper corners of back panel for task light wiring access
- exterior back panel unfinished

Options:

- must specify chassis grain direction on artisan veneer, see pages 13-15 for details
- veneer door fronts in paint available, specify paint color and add \$372 list; see page 16 for details
- on laminate units, contrasting laminate door fronts available, no upcharge; specify laminate color, see page 16 for details
- white glass doors with aluminum trim available, specify and add \$1,284 list for 36"w, \$1,234 list for 30"w; see page 33 for details
- markerboard laminate doors available, specify and add \$426 list; see page 33 for details
- locking doors available, specify and add \$153 list (not available on glass doors)
- tackboard or markerboard available, see pages 306-309
- tasklights available, see page 455

FLUX

To Order, Specify:

① Laminate Model #	② Laminate Selection	③ Metal Color	④ Other Product Options
Laminate (FLT)	See Laminate Selection	See Metal Finish Color Options	See list of options for each specific unit; Specify and add accordingly.

① Veneer Model #	② Wood Collection	③ Wood Finish	④ Metal Color	⑤ Other Product Options		
Veneer (FLV)	Essentials	See Essentials Wood Finish Options	See Metal Finish Color Options	See list of options for each specific unit; Specify and add accordingly.		
	Artisan	<table border="1"> <thead> <tr> <th>3a Wood Finish</th> <th>3b Chassis Grain Direction</th> </tr> </thead> <tbody> <tr> <td>See Artisan Wood Finish Options</td> <td>For Artisan Only: Vertical Horizontal</td> </tr> </tbody> </table>	3a Wood Finish		3b Chassis Grain Direction	See Artisan Wood Finish Options
3a Wood Finish	3b Chassis Grain Direction					
See Artisan Wood Finish Options	For Artisan Only: Vertical Horizontal					

Description	D	W	H	CTN WT	CU FT	Model	Laminate	Essentials Veneer	Artisan Veneer
Storage Overhead Cabinet with Four Doors with Open Center	15 7/8"	95 7/8"	48"	242	51	FLT1696-48SMO	\$2,435		
	15 7/8"	95 7/8"	48"	242	51	FLV1696-48SMO		\$4,126	\$4,536
	15 7/8"	89 7/8"	48"	230	48	FLT1690-48SMO	\$2,255		
	15 7/8"	89 7/8"	48"	230	48	FLV1690-48SMO		\$3,817	\$4,199
	15 7/8"	83 7/8"	48"	217	45	FLT1684-48SMO	\$2,075		
	15 7/8"	83 7/8"	48"	217	45	FLV1684-48SMO		\$3,510	\$3,861

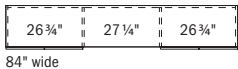
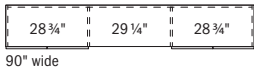
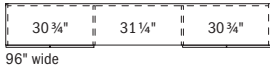
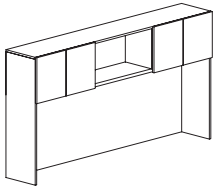

Features:

- use with secondary height units, fastening hardware included
- laminate grain direction runs horizontal on back panel of overhead cabinets
- 1/4" overhang at the bottom of the door allows access
- 30 3/4" vertical clearance between worksurface and bottom of door, excluding task light
- two 5/8" dia. holes in upper corners of back panel for task light wiring access
- exterior back panel unfinished

Options:

- must specify chassis grain direction on artisan veneer, see pages 13-15 for details
- veneer door fronts in paint available, specify paint color and add \$372 list; see page 16 for details
- on laminate units, contrasting laminate door fronts available, no upcharge; specify laminate color, see page 16 for details
- white glass doors with aluminum trim available, specify and add \$2,464 list; see page 33 for details
- markerboard laminate doors available, specify and add \$843 list; see page 33 for details
- locking doors available, specify and add \$306 list (not available on glass doors)
- tackboard or markerboard available, see pages 306-309
- tasklights available, see page 455

Storage Overhead Cabinet with Two Doors with Open Compartment	15 7/8"	77 7/8"	48"	196	42	FLT1678-48SMOR	\$1,995		
	15 7/8"	77 7/8"	48"	196	42	FLV1678-48SMOR		\$3,266	\$3,591
	15 7/8"	77 7/8"	48"	196	42	FLT1678-48SMOL	\$1,995		
	15 7/8"	77 7/8"	48"	196	42	FLV1678-48SMOL		\$3,266	\$3,591
	15 7/8"	71 7/8"	48"	184	39	FLT1672-48SMOR	\$1,879		
	15 7/8"	71 7/8"	48"	184	39	FLV1672-48SMOR		\$3,078	\$3,385
	15 7/8"	71 7/8"	48"	184	39	FLT1672-48SMOL	\$1,879		
	15 7/8"	71 7/8"	48"	184	39	FLV1672-48SMOL		\$3,078	\$3,385
	15 7/8"	65 7/8"	48"	177	36	FLT1666-48SMOR	\$1,778		
	15 7/8"	65 7/8"	48"	177	36	FLV1666-48SMOR		\$2,909	\$3,201
	15 7/8"	65 7/8"	48"	177	36	FLT1666-48SMOL	\$1,778		
	15 7/8"	65 7/8"	48"	177	36	FLV1666-48SMOL		\$2,909	\$3,201
	15 7/8"	59 7/8"	48"	164	33	FLT1660-48SMOR	\$1,698		
	15 7/8"	59 7/8"	48"	164	33	FLV1660-48SMOR		\$2,779	\$3,056
	15 7/8"	59 7/8"	48"	164	33	FLT1660-48SMOL	\$1,698		
	15 7/8"	59 7/8"	48"	164	33	FLV1660-48SMOL		\$2,779	\$3,056

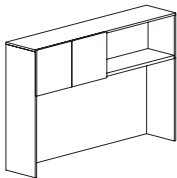

left shown

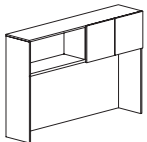

right

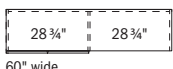
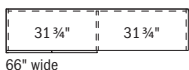
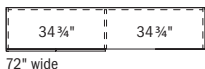
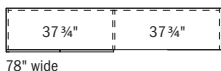

Features:

- use with secondary height units, fastening hardware included
- laminate grain direction runs horizontal on back panel of overhead cabinets
- 1/4" overhang at the bottom of the door allows access
- 30 3/4" vertical clearance between worksurface and bottom of door, excluding task light
- two 5/8" dia. holes in upper corners of back panel for task light wiring access
- exterior back panel unfinished

Options:

- must specify chassis grain direction on artisan veneer, see pages 13-15 for details
- veneer door fronts in paint available, specify paint color and add \$372 list; see page 16 for details
- on laminate units, contrasting laminate door fronts available, no upcharge; specify laminate color, see page 16 for details
- white glass doors with aluminum trim available, specify and add \$1,343 list for 78"w, \$1,284 list for 72"w, \$1,234 list for 66"w or 60"w; see page 33 for details
- markerboard laminate doors available, specify and add \$426 list; see page 33 for details
- locking doors available, specify and add \$153 list (not available on glass doors)
- tackboard or markerboard available, see pages 306-309
- tasklights available, see page 455

Description	D	W	H	CTN WT	CU FT	① Model	Laminate	Essentials Veneer	Artisan Veneer
Storage Overhead Cabinet with Two Doors with Open Center	15 7/8	53 7/8	48	159	29	FLT1654-48SMO	\$2,006		
	15 7/8	53 7/8	48	159	29	FLV1654-48SMO		\$3,038	\$3,338
	15 7/8	47 7/8	48	146	26	FLT1648-48SMO	\$1,939		
	15 7/8	47 7/8	48	146	26	FLV1648-48SMO		\$2,937	\$3,232
	15 7/8	41 7/8	48	133	23	FLT1642-48SMO	\$1,879		
	15 7/8	41 7/8	48	133	23	FLV1642-48SMO		\$2,845	\$3,129

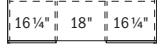
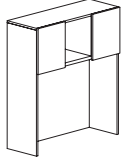

54" wide

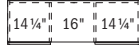

48" wide



42" wide

Features:

- use with secondary height units, fastening hardware included
- laminate grain direction runs horizontal on back panel of overhead cabinets
- 1/4" overhang at the bottom of the door allows access
- 30 3/4" vertical clearance between worksurface and bottom of door, excluding task light
- two 5/8" dia. holes in upper corners of back panel for task light wiring access
- exterior back panel unfinished

Options:

- must specify chassis grain direction on artisan veneer, see pages 13-15 for details
- veneer door fronts in paint available, specify paint color and add \$372 list; see page 16 for details
- on laminate units, contrasting laminate door fronts available, no upcharge; specify laminate color, see page 16 for details
- white glass doors with aluminum trim available, specify and add \$1,284 list for 54"w, \$1,234 list for 48"w or 42"w; see page 33 for details
- markerboard laminate doors available, specify and add \$426 list; see page 33 for details
- locking doors available, specify and add \$306 list (not available on glass doors)
- tackboard or markerboard available, see pages 306-309
- tasklights available, see page 455

To Order, Specify:

① Laminate Model #	② Laminate Selection	③ Metal Color	④ Other Product Options
Laminate (FLT)	See Laminate Selection	See Metal Finish Color Options	See list of options for each specific unit; Specify and add accordingly.

① Veneer Model #	② Wood Collection	③ Wood Finish	④ Metal Color	⑤ Other Product Options		
Veneer (FLV)	Essentials	See Essentials Wood Finish Options	See Metal Finish Color Options	See list of options for each specific unit; Specify and add accordingly.		
	Artisan	<table border="1"> <thead> <tr> <th>③a Wood Finish</th> <th>③b Chassis Grain Direction</th> </tr> </thead> <tbody> <tr> <td>See Artisan Wood Finish Options</td> <td>For Artisan Only: Vertical Horizontal</td> </tr> </tbody> </table>	③a Wood Finish		③b Chassis Grain Direction	See Artisan Wood Finish Options
③a Wood Finish	③b Chassis Grain Direction					
See Artisan Wood Finish Options	For Artisan Only: Vertical Horizontal					

Description	D	W	H	CTN WT	CU FT	① Model	Laminate	Essentials Veneer	Artisan Veneer
Storage Overhead Cabinet with Sliding Door	15 15/16	95 7/8	48	251	51	FLT1696-48SD	\$2,870		
	15 15/16	95 7/8	48	251	51	FLV1696-48SD		\$4,702	\$5,174
	15 15/16	89 7/8	48	239	48	FLT1690-48SD	\$2,661		
	15 15/16	89 7/8	48	239	48	FLV1690-48SD		\$4,360	\$4,797
	15 15/16	83 7/8	48	226	45	FLT1684-48SD	\$2,450		
	15 15/16	83 7/8	48	226	45	FLV1684-48SD		\$4,013	\$4,415

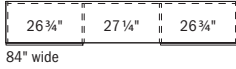
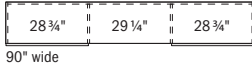
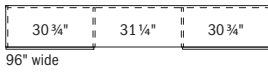
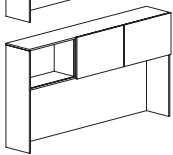
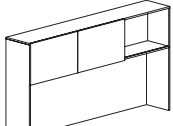
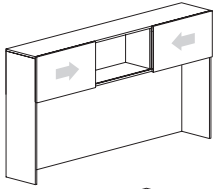

Features:

- use with secondary height units, fastening hardware included
- laminate grain direction runs horizontal on back panel of overhead cabinets
- 30 3/4" vertical clearance between worksurface and bottom of door, excluding task light
- two 5/8" dia. holes in upper corners of back panel for task light wiring access
- exterior back panel unfinished
- locking not available

Options:

- must specify chassis grain direction on artisan veneer, see pages 13-15 for details
- veneer door fronts in paint available, specify paint color and add \$372 list; see page 16 for details
- on laminate units, contrasting laminate door fronts available, no upcharge; specify laminate color, see page 16 for details
- white glass doors with aluminum trim available, specify and add \$1,971 list for 96"w, \$1,890 list for 90"w, \$1,808 list for 84"w; see page 33 for details
- markerboard laminate doors available, specify and add \$628 list; see page 33 for details
- tackboard or markerboard available, see pages 306-309
- tasklights available, see page 455

Storage Overhead Cabinet with Sliding Door	15 15/16	77 7/8	48	203	42	FLT1678-48SD	\$2,358		
	15 15/16	77 7/8	48	203	42	FLV1678-48SD		\$3,740	\$4,113
	15 15/16	71 7/8	48	190	39	FLT1672-48SD	\$2,223		
	15 15/16	71 7/8	48	190	39	FLV1672-48SD		\$3,531	\$3,881
	15 15/16	65 7/8	48	178	36	FLT1666-48SD	\$2,106		
	15 15/16	65 7/8	48	178	36	FLV1666-48SD		\$3,338	\$3,673
Storage Overhead Cabinet with Sliding Door	15 15/16	59 7/8	48	166	33	FLT1660-48SD	\$2,013		
	15 15/16	59 7/8	48	166	33	FLV1660-48SD		\$3,194	\$3,514

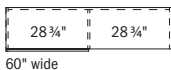
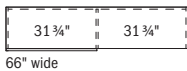
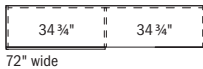
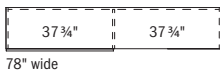
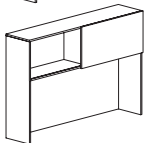
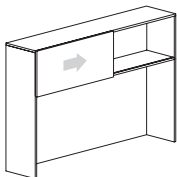

Features:

- use with secondary height units, fastening hardware included
- laminate grain direction runs horizontal on back panel of overhead cabinets
- 30 3/4" vertical clearance between worksurface and bottom of door, excluding task light
- two 5/8" dia. holes in upper corners of back panel for task light wiring access
- exterior back panel unfinished
- locking not available

Options:

- must specify chassis grain direction on artisan veneer, see pages 13-15 for details
- veneer door fronts in paint available, specify paint color and add \$372 list; see page 16 for details
- on laminate units, contrasting laminate door fronts available, no upcharge; specify laminate color, see page 16 for details
- white glass doors with aluminum trim available, specify and add \$1,136 list for 78"w, \$1,071 list for 72"w, \$1,011 list for 66"w \$947 list for 60"w; see page 33 for details
- markerboard laminate doors available, specify and add \$317 list; see page 33 for details
- tackboard or markerboard available, see pages 306-309
- tasklights available, see page 455

Description	D	W	H	CTN WT	CU FT	① Model	Laminate	Essentials Veneer	Artisan Veneer
Storage Overhead Cabinet with Sliding Door	15 15/16	53 7/8	48	153	30	FLT1654-48SD	\$1,969		
	15 15/16	53 7/8	48	153	30	FLV1654-48SD		\$3,077	\$3,383
	15 15/16	47 7/8	48	141	26	FLT1648-48SD	\$1,906		
	15 15/16	47 7/8	48	141	26	FLV1648-48SD		\$2,973	\$3,272
	15 15/16	41 7/8	48	128	23	FLT1642-48SD	\$1,845		
	15 15/16	41 7/8	48	128	23	FLV1642-48SD		\$2,883	\$3,171

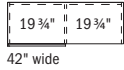
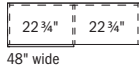
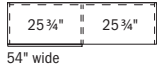
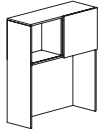
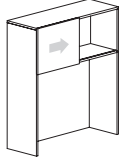

Features:

- use with secondary height units, fastening hardware included
- laminate grain direction runs horizontal on back panel of overhead cabinets
- 30 3/4" vertical clearance between worksurface and bottom of door, excluding task light
- two 5/8" dia. holes in upper corners of back panel for task light wiring access
- exterior back panel unfinished
- locking not available

Options:

- must specify chassis grain direction on artisan veneer, see pages 13-15 for details
- veneer door fronts in paint available, specify paint color and add \$372 list; see page 16 for details
- on laminate units, contrasting laminate door fronts available, no upcharge; specify laminate color, see page 16 for details
- white glass doors with aluminum trim available, specify and add \$887 list for 54"w, \$826 list for 48"w, \$858 list for 42"w; see page 33 for details
- markerboard laminate doors available, specify and add \$317 list; see page 33 for details
- tackboard or markerboard available, see pages 306-309
- tasklights available, see page 455

Storage Overhead Cabinet with Sliding Door	15 15/16	35 7/8	48	116	20	FLT1636-48SD	\$1,753		
	15 15/16	35 7/8	48	116	20	FLV1636-48SD		\$2,735	\$3,008
	15 15/16	29 7/8	48	104	17	FLT1630-48SD	\$1,683		
	15 15/16	29 7/8	48	104	17	FLV1630-48SD		\$2,622	\$2,885

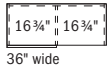
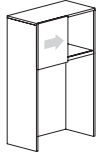

Features:

- use with secondary height units, fastening hardware included
- laminate grain direction runs horizontal on back panel of overhead cabinets
- 30 3/4" vertical clearance between worksurface and bottom of door, excluding task light
- two 5/8" dia. holes in upper corners of back panel for task light wiring access
- exterior back panel unfinished
- locking not available

Options:

- must specify chassis grain direction on artisan veneer, see pages 13-15 for details
- veneer door fronts in paint available, specify paint color and add \$372 list; see page 16 for details
- on laminate units, contrasting laminate door fronts available, no upcharge; specify laminate color, see page 16 for details
- white glass doors with aluminum trim available, specify and add \$702 list for 36"w, \$670 list for 30"w; see page 33 for details
- markerboard laminate doors available, specify and add \$317 list; see page 33 for details
- tackboard or markerboard available, see pages 306-309
- tasklights available, see page 455

To Order, Specify:

① Laminate Model #	② Laminate Selection	③ Metal Color	④ Other Product Options
Laminate (FLT)	See Laminate Selection	See Metal Finish Color Options	See list of options for each specific unit; Specify and add accordingly.

① Veneer Model #	② Wood Collection	③ Wood Finish	④ Metal Color	⑤ Other Product Options		
Veneer (FLV)	Essentials	See Essentials Wood Finish Options	See Metal Finish Color Options	See list of options for each specific unit; Specify and add accordingly.		
	Artisan	<table border="1"> <thead> <tr> <th>ⓐ Wood Finish</th> <th>ⓑ Chassis Grain Direction</th> </tr> </thead> <tbody> <tr> <td>See Artisan Wood Finish Options</td> <td>For Artisan Only: Vertical Horizontal</td> </tr> </tbody> </table>	ⓐ Wood Finish		ⓑ Chassis Grain Direction	See Artisan Wood Finish Options
ⓐ Wood Finish	ⓑ Chassis Grain Direction					
See Artisan Wood Finish Options	For Artisan Only: Vertical Horizontal					

Description	D	W	H	CTN WT	CU FT	① Model	Laminate	Essentials Veneer	Artisan Veneer
Open Storage Overhead Cabinet	15	95%	48	218	49	FLT1596-4800	\$2,242		
	15	95%	48	218	49	FLV1596-4800		\$3,793	\$4,174
	15	89%	48	207	46	FLT1590-4800	\$2,107		
	15	89%	48	207	46	FLV1590-4800		\$3,562	\$3,919
	15	83%	48	196	43	FLT1584-4800	\$1,968		
	15	83%	48	196	43	FLV1584-4800		\$3,328	\$3,661

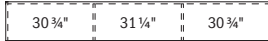
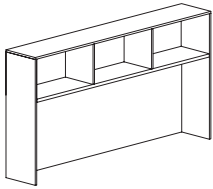

96" wide

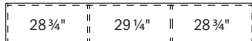

90" wide

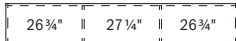

84" wide

Features:

- use with secondary height units, fastening hardware included
- laminate grain direction runs horizontal on back panel of overhead cabinets
- 31" vertical clearance between worksurface and bottom of cabinet, excluding task light
- two 5/8" dia. holes in upper corners of back panel for task light wiring access
- exterior back panel unfinished

Options:

- must specify chassis grain direction on artisan veneer, see pages 13-15 for details
- tackboard or markerboard available, see pages 306-309
- tasklights available, see page 455

Description	D	W	H	CTN WT	CU FT	① Model	Laminate	Essentials Veneer	Artisan Veneer
Open Storage Overhead Cabinet	15	77%	48	180	40	FLT1578-4800	\$1,835		
	15	77%	48	180	40	FLV1578-4800		\$2,999	\$3,301
	15	71%	48	169	37	FLT1572-4800	\$1,728		
	15	71%	48	169	37	FLV1572-4800		\$2,829	\$3,113
	15	65%	48	163	34	FLT1566-4800	\$1,632		
	15	65%	48	163	34	FLV1566-4800		\$2,674	\$2,942
	15	59%	48	152	31	FLT1560-4800	\$1,561		
	15	59%	48	152	31	FLV1560-4800		\$2,554	\$2,810

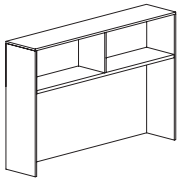

78" wide



72" wide



66" wide



60" wide

Features:

- use with secondary height units, fastening hardware included
- laminate grain direction runs horizontal on back panel of overhead cabinets
- 31" vertical clearance between worksurface and bottom of cabinet, excluding task light
- two 5/8" dia. holes in upper corners of back panel for task light wiring access
- exterior back panel unfinished

Options:

- must specify chassis grain direction on artisan veneer, see pages 13-15 for details
- tackboard or markerboard available, see pages 306-309
- tasklights available, see page 455

FLUX

Description	D	W	H	CTN WT	CU FT	① Model	Laminate	Essentials Veneer	Artisan Veneer
Open Storage Overhead Cabinet	15	53 7/8	48	140	28	FLT1554-4800	\$1,526		
	15	53 7/8	48	140	28	FLV1554-4800		\$2,459	\$2,703
	15	47 7/8	48	129	25	FLT1548-4800	\$1,476		
	15	47 7/8	48	129	25	FLV1548-4800		\$2,375	\$2,614
	15	41 7/8	48	117	22	FLT1542-4800	\$1,428		
	15	41 7/8	48	117	22	FLV1542-4800		\$2,299	\$2,528

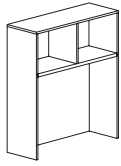

54" wide

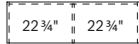

48" wide

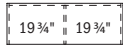

42" wide

Features:

- use with secondary height units, fastening hardware included
- laminate grain direction runs horizontal on back panel of overhead cabinets
- 31" vertical clearance between worksurface and bottom of cabinet, excluding task light
- two 5/8" dia. holes in upper corners of back panel for task light wiring access
- exterior back panel unfinished

Options:

- must specify chassis grain direction on artisan veneer, see pages 13-15 for details
- tackboard or markerboard available, see pages 306-309
- tasklights available, see page 455

Open Storage Overhead Cabinet	15	35 7/8	48	99	19	FLT1536-4800	\$1,354		
	15	35 7/8	48	99	19	FLV1536-4800		\$2,179	\$2,396
	15	29 7/8	48	88	16	FLT1530-4800	\$1,298		
	15	29 7/8	48	88	16	FLV1530-4800		\$2,087	\$2,297

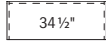
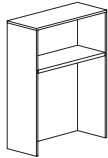

36" wide



30" wide

Features:

- use with secondary height units, fastening hardware included
- laminate grain direction runs horizontal on back panel of overhead cabinets
- 31" vertical clearance between worksurface and bottom of cabinet, excluding task light
- two 5/8" dia. holes in upper corners of back panel for task light wiring access
- exterior back panel unfinished

Options:

- must specify chassis grain direction on artisan veneer, see pages 13-15 for details
- tackboard or markerboard available, see pages 306-309
- tasklights available, see page 455

To Order, Specify:

① Laminate Model #	② Laminate Selection	③ Metal Color	④ Other Product Options
Laminate (FLT)	See Laminate Selection	See Metal Finish Color Options	See list of options for each specific unit; Specify and add accordingly.

① Veneer Model #	② Wood Collection	③ Wood Finish	④ Metal Color	⑤ Other Product Options		
Veneer (FLV)	Essentials	See Essentials Wood Finish Options	See Metal Finish Color Options	See list of options for each specific unit; Specify and add accordingly.		
	Artisan	<table border="1"> <thead> <tr> <th>③a Wood Finish</th> <th>③b Chassis Grain Direction</th> </tr> </thead> <tbody> <tr> <td>See Artisan Wood Finish Options</td> <td>For Artisan Only: Vertical Horizontal</td> </tr> </tbody> </table>	③a Wood Finish		③b Chassis Grain Direction	See Artisan Wood Finish Options
③a Wood Finish	③b Chassis Grain Direction					
See Artisan Wood Finish Options	For Artisan Only: Vertical Horizontal					

FLUX

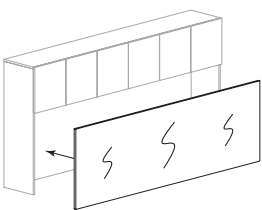
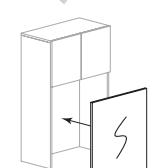
Description	D	W	H	CTN WT	CU FT	① Model	List Price
Overhead Cabinet Markerboard Panel  	13/16	94 1/4	30	76	6	FLB9531CMB	\$1,971
	13/16	88 1/4	30	71	6	FLB8931CMB	\$1,846
	13/16	82 1/4	30	67	5	FLB8331CMB	\$1,722
	13/16	76 1/4	30	62	5	FLB7731CMB	\$1,596
	13/16	70 1/4	30	57	5	FLB7131CMB	\$1,474
	13/16	64 1/4	30	52	4	FLB6531CMB	\$1,346
	13/16	58 1/4	30	47	4	FLB5931CMB	\$1,221
	13/16	52 1/4	30	43	4	FLB5331CMB	\$1,098
	13/16	46 1/4	30	38	3	FLB4731CMB	\$973
	13/16	40 1/4	30	33	3	FLB4131CMB	\$847
	13/16	34 1/4	30	28	3	FLB3531CMB	\$719
	13/16	28 1/4	30	24	2	FLB2931CMB	\$596

- Features:**
- use with 48”h overhead cabinets
 - standard markerboard laminate with aluminum pvc edge
 - attaches to cabinet interior, mounting hardware included

FLUX

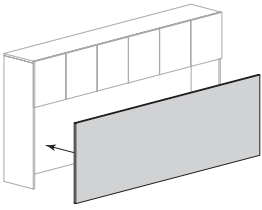
Description	D	W	H	CTN WT	CU FT	① Model	List Price Per Grade	
96”w Tackboard for Overhead Cabinet 	13/16	94 1/4	30	33	6	FLB9530TK	COM \$1,025	
								A \$1,162
								B \$1,190
								C \$1,271
								D \$1,384
								E \$1,488
								F \$1,606
								G \$1,746
								H \$1,951
								I \$2,015
								J \$2,193

- Features:**
- for use with 96” wide storage overhead cabinet
 - use with 48”h overhead cabinets
 - attaches to cabinet interior, mounting hardware included
 - com ydg: 3

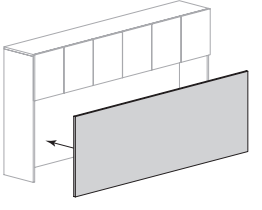
96”w Tackboard for Overhead Cabinet 	13/16	88 1/4	30	31	5	FLB8930TK	COM \$978	
								A \$1,103
								B \$1,128
								C \$1,203
								D \$1,307
								E \$1,402
								F \$1,509
								G \$1,637
								H \$1,827
								I \$1,886
								J \$2,049

- Features:**
- for use with 90”w storage overhead cabinet
 - use with 48”h overhead cabinets
 - attaches to cabinet interior, mounting hardware included
 - com ydg: 2 3/4

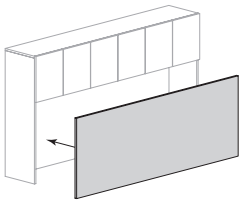
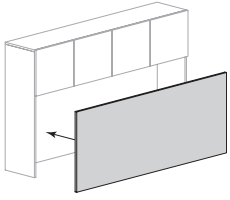
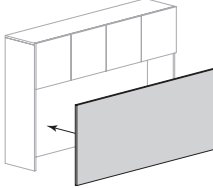
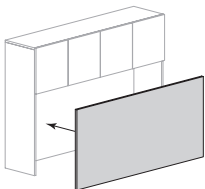
Description	D	W	H	CTN WT	CU FT	① Model	List Price Per Grade
84" w Tackboard for Overhead Cabinet 	13 1/16	82 1/4	30	29	5	FLB8330TK	COM \$931
							A \$1,044
78" w Tackboard for Overhead Cabinet 	13 1/16	76 1/4	30	27	5	FLB7730TK	COM \$879
							A \$994
72" w Tackboard for Overhead Cabinet 	13 1/16	70 1/4	30	25	4	FLB7130TK	COM \$832
							A \$935
66" w Tackboard for Overhead Cabinet 	13 1/16	64 1/4	30	23	4	FLB6530TK	COM \$784
							A \$875

Features:

- for use with 84" w storage overhead cabinet
- use with 48" h overhead cabinets
- attaches to cabinet interior, mounting hardware included
- com ydg: 2 1/2

Features:

- for use with 78" w storage overhead cabinet
- use with 48" h overhead cabinets
- attaches to cabinet interior, mounting hardware included
- com ydg: 2 1/2

Features:

- for use with 72" w storage overhead cabinet
- use with 48" h overhead cabinets
- attaches to cabinet interior, mounting hardware included
- com ydg: 2 1/4

Features:

- for use with 66" w storage overhead cabinet
- use with 48" h overhead cabinets
- attaches to cabinet interior, mounting hardware included
- com ydg: 2

To Order, Specify:

- ① Model Number
- ② Fabric Selection - vendor, pattern and color

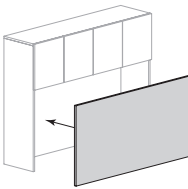
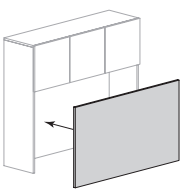
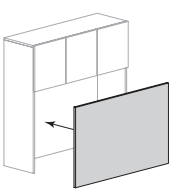
Description	D	W	H	CTN WT	CU FT	① Model	List Price Per Grade	
60" w Tackboard for Overhead Cabinet 	13/16	58 1/4	30	21	4	FLB5930TK	COM \$737	
	Features:							A \$827
	· for use with 60" w storage overhead cabinet							B \$846
	· use with 48" h overhead cabinets							C \$900
	· attaches to cabinet interior, mounting hardware included							D \$976
	· com ydg: 2							E \$1,045
								F \$1,123
								G \$1,216
								H \$1,355
								I \$1,398
							J \$1,516	
54" w Tackboard for Overhead Cabinet 	13/16	52 1/4	30	19	3	FLB5330TK	COM \$686	
	Features:							A \$765
	· for use with 54" w storage overhead cabinet							B \$782
	· use with 48" h overhead cabinets							C \$829
	· attaches to cabinet interior, mounting hardware included							D \$895
	· com ydg: 1 3/4							E \$956
								F \$1,024
								G \$1,105
								H \$1,227
								I \$1,265
							J \$1,369	
48" w Tackboard for Overhead Cabinet 	13/16	46 1/4	30	17	3	FLB4730TK	COM \$638	
	Features:							A \$706
	· for use with 48" w storage overhead cabinet							B \$721
	· use with 48" h overhead cabinets							C \$761
	· attaches to cabinet interior, mounting hardware included							D \$817
	· com ydg: 1 1/2							E \$870
								F \$929
								G \$998
								H \$1,103
								I \$1,136
							J \$1,225	

FLUX

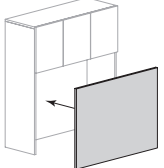
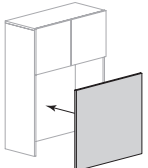
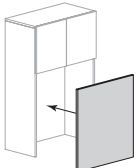
Description	D	W	H	CTN WT	CU FT	① Model	List Price Per Grade		
42" w Tackboard for Overhead Cabinet 	13/16	40 1/4	30	15	3	FLB4130TK	COM \$591 A \$659 B \$674 C \$713 D \$770 E \$823 F \$881 G \$951 H \$1,055 I \$1,087 J \$1,176		
	Features: <ul style="list-style-type: none"> · for use with 42" w storage overhead cabinet · use with 48" h overhead cabinets · attaches to cabinet interior, mounting hardware included · com ydg: 1 1/2 								
	36" w Tackboard for Overhead Cabinet 	13/16	34 1/4	30	12	2	FLB3530TK	COM \$540 A \$597 B \$608 C \$642 D \$689 E \$733 F \$782 G \$840 H \$928 I \$955 J \$1,029	
		Features: <ul style="list-style-type: none"> · for use with 36" w storage overhead cabinet · use with 48" h overhead cabinets · attaches to cabinet interior, mounting hardware included · com ydg: 1 1/4 							
		30" w Tackboard for Overhead Cabinet 	13/16	28 1/4	30	10	2	FLB2930TK	COM \$491 A \$536 B \$545 C \$573 D \$611 E \$645 F \$684 G \$730 H \$801 I \$824 J \$884
			Features: <ul style="list-style-type: none"> · for use with 30" w storage overhead cabinet · use with 48" h overhead cabinets · attaches to cabinet interior, mounting hardware included · com ydg: 1 						

FLUX

To Order, Specify:

- ① Model Number
- ② Fabric Selection - vendor, pattern and color

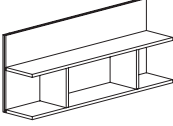
Description	D	W	H	CTN WT	CU FT	① Model	Laminate	Essentials Veneer	Artisan Veneer
	15	96	29	174	30	FLT1596-29WMS	\$1,664		
	15	96	29	174	30	FLV1596-29WMS		\$2,554	\$2,810
	15	90	29	164	29	FLT1590-29WMS	\$1,583		
	15	90	29	164	29	FLV1590-29WMS		\$2,432	\$2,678
	15	84	29	154	27	FLT1584-29WMS	\$1,520		
	15	84	29	154	27	FLV1584-29WMS		\$2,335	\$2,570
	15	78	29	144	25	FLT1578-29WMS	\$1,460		
	15	78	29	144	25	FLV1578-29WMS		\$2,243	\$2,467
	15	72	29	135	23	FLT1572-29WMS	\$1,196		
	15	72	29	135	23	FLV1572-29WMS		\$1,839	\$2,020
	15	66	29	125	21	FLT1566-29WMS	\$1,149		
	15	66	29	125	21	FLV1566-29WMS		\$1,763	\$1,939
	15	60	29	115	19	FLT1560-29WMS	\$1,102		
	15	60	29	115	19	FLV1560-29WMS		\$1,693	\$1,864
	15	54	29	105	18	FLT1554-29WMS	\$1,059		
	15	54	29	105	18	FLV1554-29WMS		\$1,627	\$1,791
	15	48	29	95	16	FLT1548-29WMS	\$1,019		
	15	48	29	95	16	FLV1548-29WMS		\$1,561	\$1,717
	15	42	29	85	14	FLT1542-29WMS	\$977		
	15	42	29	85	14	FLV1542-29WMS		\$1,502	\$1,649

Features:

- supported by wall cleat - hardware provided by installer
- laminate grain direction runs horizontal on back panel of shelf

Options:

- must specify chassis grain direction on artisan veneer, see pages 13-15 for details

FLUX

Description	D	W	H	CTN WT	CU FT	① Model	Laminate	Essentials Veneer	Artisan Veneer
Double Height Wall Mount Overhead Shelf	15	36	29	70	12	FLT1536-29WMS	\$872		
	15	36	29	70	12	FLV1536-29WMS		\$1,338	\$1,472
	15	30	29	60	10	FLT1530-29WMS	\$836		
	15	30	29	60	10	FLV1530-29WMS		\$1,286	\$1,415

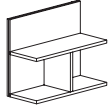

Features:

- supported by wall cleat - hardware provided by installer
- laminate grain direction runs horizontal on back panel of shelf

Options:

- must specify chassis grain direction on artisan veneer, see pages 13-15 for details

FLUX

To Order, Specify:

① Laminate Model #	② Laminate Selection	③ Metal Color	④ Other Product Options
Laminate (FLT)	See Laminate Selection	See Metal Finish Color Options	See list of options for each specific unit; Specify and add accordingly.

① Veneer Model #	② Wood Collection	③ Wood Finish	④ Metal Color	⑤ Other Product Options	
Veneer (FLV)	Essentials	See Essentials Wood Finish Options	See Metal Finish Color Options	See list of options for each specific unit; Specify and add accordingly.	
	Artisan	<table border="1"> <thead> <tr> <th>③a Wood Finish</th> <th>③b Chassis Grain Direction</th> </tr> </thead> <tbody> <tr> <td>See Artisan Wood Finish Options</td> <td>For Artisan Only: Vertical Horizontal</td> </tr> </tbody> </table>			③a Wood Finish
③a Wood Finish	③b Chassis Grain Direction				
See Artisan Wood Finish Options	For Artisan Only: Vertical Horizontal				

Description	D	W	H	CTN WT	CU FT	① Model	Laminate	Essentials Veneer	Artisan Veneer
Wall Mount Double Height Overhead with Six Doors	15 7/8	96	29 1/4	284	32	FLT1696-29WSO	\$2,638		
	15 7/8	96	29 1/4	284	32	FLV1696-29WSO		\$4,958	\$5,455
	15 7/8	90	29 1/4	269	30	FLT1690-29WSO	\$2,497		
	15 7/8	90	29 1/4	269	30	FLV1690-29WSO		\$4,650	\$5,116
	15 7/8	84	29 1/4	253	28	FLT1684-29WSO	\$2,365		
	15 7/8	84	29 1/4	253	28	FLV1684-29WSO		\$4,338	\$4,773

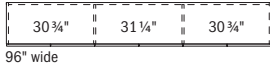
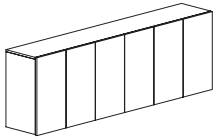

96" wide



90" wide

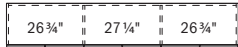

84" wide

Features:

- supported by wall cleat - hardware provided by installer
- secure wall attachment required; pilot holes provided in back panel
- laminate grain direction runs horizontal on back panel of overhead cabinets
- 1/4" overhang at the bottom of the door allows access
- adjustable shelves

Options:

- must specify chassis grain direction on artisan veneer, see pages 13-15 for details
- veneer door fronts in paint available, specify paint color and add \$372 list; see page 16 for details
- on laminate units, contrasting laminate door fronts available, no upcharge; specify laminate color, see page 16 for details
- white glass doors with aluminum trim available, specify and add \$4,949 list for 96"w, \$4,740 list for 90"w, \$4,562 list for 84"w; see page 33 for details
- markerboard laminate doors available, specify and add \$1,263 list; see page 33 for details
- locking doors available, specify and add \$459 list (not available on glass doors)

Wall Mount Double Height Overhead with Four Doors	15 7/8	78	29 1/4	230	26	FLT1678-29WSO	\$2,314		
	15 7/8	78	29 1/4	230	26	FLV1678-29WSO		\$4,031	\$4,436
	15 7/8	72	29 1/4	215	24	FLT1672-29WSO	\$2,190		
	15 7/8	72	29 1/4	215	24	FLV1672-29WSO		\$3,722	\$4,093
	15 7/8	66	29 1/4	199	22	FLT1666-29WSO	\$2,072		
	15 7/8	66	29 1/4	199	22	FLV1666-29WSO		\$3,558	\$3,915
	15 7/8	60	29 1/4	190	21	FLT1660-29WSO	\$1,978		
	15 7/8	60	29 1/4	190	21	FLV1660-29WSO		\$3,385	\$3,724

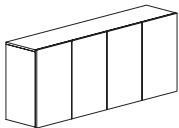

78" wide



72" wide

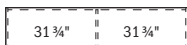

66" wide

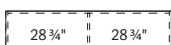



60" wide

Features:

- supported by wall cleat - hardware provided by installer
- secure wall attachment required; pilot holes provided in back panel
- laminate grain direction runs horizontal on back panel of overhead cabinets
- 1/4" overhang at the bottom of the door allows access
- adjustable shelves

Options:

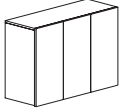
- must specify chassis grain direction on artisan veneer, see pages 13-15 for details
- veneer door fronts in paint available, specify paint color and add \$372 list; see page 16 for details
- on laminate units, contrasting laminate door fronts available, no upcharge; specify laminate color, see page 16 for details
- white glass doors with aluminum trim available, specify and add \$3,790 list for 78"w, \$3,581 list for 72"w, \$3,372 list for 66"w, \$3,164 list for 60"w; see page 33 for details
- markerboard laminate doors available, specify and add \$843 list; see page 33 for details
- locking doors available, specify and add \$306 list (not available on glass doors)

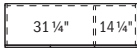
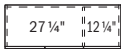

Description	D	W	H	CTN WT	CU FT	① Model	Laminate	Essentials Veneer	Artisan Veneer
Wall Mount Double Height Overhead with Three Doors   right shown  54" wide  48" wide  42" wide	15 7/8	54	29 1/4	173	19	FLT1654-29WSOR	\$1,859		
	15 7/8	54	29 1/4	173	19	FLV1654-29WSOR		\$3,052	\$3,359
	15 7/8	54	29 1/4	173	19	FLT1654-29WSOL	\$1,859		
	15 7/8	54	29 1/4	173	19	FLV1654-29WSOL		\$3,052	\$3,359
	15 7/8	48	29 1/4	157	17	FLT1648-29WSOR	\$1,594		
	15 7/8	48	29 1/4	157	17	FLV1648-29WSOR		\$2,674	\$2,942
	15 7/8	48	29 1/4	157	17	FLT1648-29WSOL	\$1,594		
	15 7/8	48	29 1/4	157	17	FLV1648-29WSOL		\$2,674	\$2,942
	15 7/8	42	29 1/4	141	15	FLT1642-29WSOR	\$1,514		
	15 7/8	42	29 1/4	141	15	FLV1642-29WSOR		\$2,453	\$2,699
	15 7/8	42	29 1/4	141	15	FLT1642-29WSOL	\$1,514		
	15 7/8	42	29 1/4	141	15	FLV1642-29WSOL		\$2,453	\$2,699

Features:

- supported by wall cleat - hardware provided by installer
- secure wall attachment required; pilot holes provided in back panel
- laminated grain direction runs horizontal on back panel of overhead cabinets
- 1/4" overhang at the bottom of the door allows access
- adjustable shelves

Options:

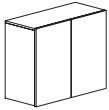
- must specify chassis grain direction on artisan veneer, see pages 13-15 for details
- veneer door fronts in paint available, specify paint color and add \$372 list; see page 16 for details
- on laminate units, contrasting laminate door fronts available, no upcharge; specify laminate color, see page 16 for details
- white glass doors with aluminum trim available, specify and add \$2,686 list for 54"w, \$2,477 list for 48"w, \$2,270 list for 42"w; see page 33 for details
- markerboard laminate doors available, specify and add \$634 list; see page 33 for details
- locking doors available, specify and add \$306 list (not available on glass doors)

Wall Mount Double Height Overhead with Two Doors   36" wide  30" wide	15 7/8	36	29 1/4	114	13	FLT1636-29WSO	\$1,317		
	15 7/8	36	29 1/4	114	13	FLV1636-29WSO		\$2,300	\$2,530
	15 7/8	30	29 1/4	99	11	FLT1630-29WSO	\$1,254		
	15 7/8	30	29 1/4	99	11	FLV1630-29WSO		\$2,191	\$2,412

Features:

- supported by wall cleat - hardware provided by installer
- secure wall attachment required; pilot holes provided in back panel
- laminated grain direction runs horizontal on back panel of overhead cabinets
- 1/4" overhang at the bottom of the door allows access
- adjustable shelves

Options:

- must specify chassis grain direction on artisan veneer, see pages 13-15 for details
- veneer door fronts in paint available, specify paint color and add \$372 list; see page 16 for details
- on laminate units, contrasting laminate door fronts available, no upcharge; specify laminate color, see page 16 for details
- white glass doors with aluminum trim available, specify and add \$1,794 list for 36"w, \$1,585 list for 30"w; see page 33 for details
- markerboard laminate doors available, specify and add \$426 list; see page 33 for details
- locking doors available, specify and add \$153 list (not available on glass doors)

To Order, Specify:

① Laminate Model #	② Laminate Selection	③ Metal Color	④ Other Product Options
Laminate (FLT)	See Laminate Selection	See Metal Finish Color Options	See list of options for each specific unit; Specify and add accordingly.

① Veneer Model #	② Wood Collection	③ Wood Finish	④ Metal Color	⑤ Other Product Options		
Veneer (FLV)	Essentials	See Essentials Wood Finish Options	See Metal Finish Color Options	See list of options for each specific unit; Specify and add accordingly.		
	Artisan	<table border="1"> <thead> <tr> <th>ⓐ Wood Finish</th> <th>ⓑ Chassis Grain Direction</th> </tr> </thead> <tbody> <tr> <td>See Artisan Wood Finish Options</td> <td>For Artisan Only: Vertical Horizontal</td> </tr> </tbody> </table>	ⓐ Wood Finish		ⓑ Chassis Grain Direction	See Artisan Wood Finish Options
ⓐ Wood Finish	ⓑ Chassis Grain Direction					
See Artisan Wood Finish Options	For Artisan Only: Vertical Horizontal					

FLUX

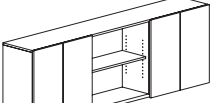
Description	D	W	H	CTN WT	CU FT	Model	Laminate	Essentials Veneer	Artisan Veneer
Wall Mount Double Height Overhead with Four Doors and Open Center 	15 7/8	96	29 1/4	264	32	FLT1696-29WSMO	\$2,615		
	15 7/8	96	29 1/4	264	32	FLV1696-29WSMO		\$4,281	\$4,708
	15 7/8	90	29 1/4	250	30	FLT1690-29WSMO	\$2,461		
	15 7/8	90	29 1/4	250	30	FLV1690-29WSMO		\$4,024	\$4,427
	15 7/8	84	29 1/4	236	28	FLT1684-29WSMO	\$2,300		
	15 7/8	84	29 1/4	236	28	FLV1684-29WSMO		\$3,767	\$4,144

Features:

- supported by wall cleat - hardware provided by installer
- secure wall attachment required; pilot holes provided in back panel
- laminate grain direction runs horizontal on back panel of overhead cabinets
- 1/4" overhang at the bottom of the door allows access
- adjustable shelves

Options:

- must specify chassis grain direction on artisan veneer, see pages 13-15 for details
- veneer door fronts in paint available, specify paint color and add \$372 list; see page 16 for details
- on laminate units, contrasting laminate door fronts available, no upcharge; specify laminate color, see page 16 for details
- white glass doors with aluminum trim available, specify and add \$3,303 list for 96"w, \$3,164 list for 90"w, \$3,026 list for 84"w; see page 33 for details
- markerboard laminate doors available, specify and add \$843 list; see page 33 for details
- locking doors available, specify and add \$306 list (not available on glass doors)

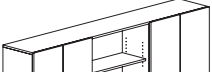
Wall Mount Double Height Overhead Cabinet with Four Doors, Open Center and Cubbies 	15 7/8	96	29 1/4	275	32	FLT1696-29WSMOCC	\$2,751		
	15 7/8	96	29 1/4	275	32	FLV1696-29WSMOCC		\$4,476	\$4,924
	15 7/8	90	29 1/4	260	30	FLT1690-29WSMOCC	\$2,595		
	15 7/8	90	29 1/4	260	30	FLV1690-29WSMOCC		\$4,223	\$4,643
	15 7/8	84	29 1/4	245	28	FLT1684-29WSMOCC	\$2,435		
	15 7/8	84	29 1/4	245	28	FLV1684-29WSMOCC		\$3,962	\$4,360

Features:

- supported by wall cleat - hardware provided by installer
- secure wall attachment required; pilot holes provided in back panel
- laminate grain direction runs horizontal on back panel of overhead cabinets
- 1/4" overhang at the bottom of the door allows access
- adjustable shelves

Options:

- must specify chassis grain direction on artisan veneer, see pages 13-15 for details
- veneer door fronts in paint available, specify paint color and add \$372 list; see page 16 for details
- on laminate units, contrasting laminate door fronts available, no upcharge; specify laminate color, see page 16 for details
- white glass doors with aluminum trim available, specify and add \$3,303 list for 96"w, \$3,164 list for 90"w, \$3,026 list for 84"w; see page 33 for details
- markerboard laminate doors available, specify and add \$843 list; see page 33 for details
- locking doors available, specify and add \$306 list (not available on glass doors)

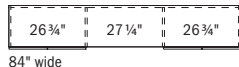
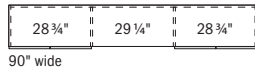
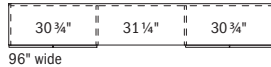
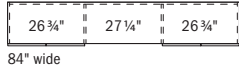
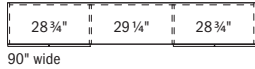
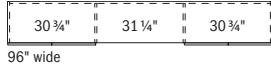

FLUX

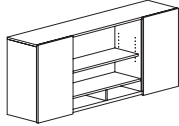
Description	D	W	H	CTN WT	CU FT	① Model	Laminate	Essentials Veneer	Artisan Veneer
Wall Mount Double Height Overhead Cabinet with Two Doors, Open Center and Cubbies	15 7/8	78	29 1/4	226	26	FLT1678-29WSMOCC	\$2,284		
	15 7/8	78	29 1/4	226	26	FLV1678-29WSMOCC		\$3,601	\$3,960
	15 7/8	72	29 1/4	211	24	FLT1672-29WSMOCC	\$2,160		
	15 7/8	72	29 1/4	211	24	FLV1672-29WSMOCC		\$3,408	\$3,748
	15 7/8	66	29 1/4	197	22	FLT1666-29WSMOCC	\$2,054		
	15 7/8	66	29 1/4	197	22	FLV1666-29WSMOCC		\$3,237	\$3,559
	15 7/8	60	29 1/4	187	21	FLT1660-29WSMOCC	\$1,972		
	15 7/8	60	29 1/4	187	21	FLV1660-29WSMOCC		\$3,110	\$3,417

Features:

- supported by wall cleat - hardware provided by installer
- secure wall attachment required; pilot holes provided in back panel
- laminate grain direction runs horizontal on back panel of overhead cabinets
- 1/4" overhang at the bottom of the door allows access
- adjustable shelves

Options:

- must specify chassis grain direction on artisan veneer, see pages 13-15 for details
- veneer door fronts in paint available, specify paint color and add \$372 list; see page 16 for details
- on laminate units, contrasting laminate door fronts available, no upcharge; specify laminate color, see page 16 for details
- white glass doors with aluminum trim available, specify and add \$1,897 list for 78"w, \$1,794 list for 72"w, \$1,689 list for 66"w, \$1,585 list for 60"w; see page 33 for details
- markerboard laminate doors available, specify and add \$426 list; see page 33 for details
- locking doors available, specify and add \$306 list (not available on glass doors)

Wall Mount Double Height Overhead Cabinet with 2 Doors, Open Center and Cubbies	15 7/8	54	29 1/4	174	19	FLT1654-29WSMOCC	\$1,931		
	15 7/8	54	29 1/4	174	19	FLV1654-29WSMOCC		\$2,997	\$3,296
	15 7/8	48	29 1/4	159	17	FLT1648-29WSMOCC	\$1,874		
	15 7/8	48	29 1/4	159	17	FLV1648-29WSMOCC		\$2,907	\$3,197
	15 7/8	42	29 1/4	143	15	FLT1642-29WSMOCC	\$1,818		
	15 7/8	42	29 1/4	143	15	FLV1642-29WSMOCC		\$2,823	\$3,104

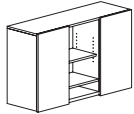

54" wide

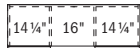

48" wide



42" wide

Features:

- supported by wall cleat - hardware provided by installer
- secure wall attachment required; pilot holes provided in back panel
- laminate grain direction runs horizontal on back panel of overhead cabinets
- 1/4" overhang at the bottom of the door allows access
- adjustable shelves

Options:

- must specify chassis grain direction on artisan veneer, see pages 13-15 for details
- veneer door fronts in paint available, specify paint color and add \$372 list; see page 16 for details
- on laminate units, contrasting laminate door fronts available, no upcharge; specify laminate color, see page 16 for details
- white glass doors with aluminum trim available, specify and add \$1,794 list for 54"w, \$1,653 list for 48"w, \$1,514 list for 42"w; see page 33 for details
- markerboard laminate doors available, specify and add \$426 list; see page 33 for details
- locking doors available, specify and add \$306 list (not available on glass doors)

To Order, Specify:

① Laminate Model #	② Laminate Selection	③ Metal Color	④ Other Product Options
Laminate (FLT)	See Laminate Selection	See Metal Finish Color Options	See list of options for each specific unit; Specify and add accordingly.

① Veneer Model #	② Wood Collection	③ Wood Finish	④ Metal Color	⑤ Other Product Options
Veneer (FLV)	Essentials	See Essentials Wood Finish Options	See Metal Finish Color Options	See list of options for each specific unit; Specify and add accordingly.
		<table border="1"> <thead> <tr> <th>ⓐ Wood Finish</th> <th>ⓑ Chassis Grain Direction</th> </tr> </thead> <tbody> <tr> <td>See Artisan Wood Finish Options</td> <td>For Artisan Only: Vertical Horizontal</td> </tr> </tbody> </table>		
ⓐ Wood Finish	ⓑ Chassis Grain Direction			
See Artisan Wood Finish Options	For Artisan Only: Vertical Horizontal			

Description	D	W	H	CTN WT	CU FT	① Model	Laminate	Essentials Veneer	Artisan Veneer
Wall Mount Double Height Overhead with Two Doors and Open Compartment	15 7/8	78	29 1/4	206	26	FLT1678-29WSMOR	\$2,149		
	15 7/8	78	29 1/4	206	26	FLV1678-29WSMOR		\$3,405	\$3,744
	15 7/8	78	29 1/4	206	26	FLT1678-29WSMOL	\$2,149		
	15 7/8	78	29 1/4	206	26	FLV1678-29WSMOL		\$3,405	\$3,744
	15 7/8	72	29 1/4	192	24	FLT1672-29WSMOR	\$2,025		
	15 7/8	72	29 1/4	192	24	FLV1672-29WSMOR		\$3,210	\$3,533
	15 7/8	72	29 1/4	192	24	FLT1672-29WSMOL	\$2,025		
	15 7/8	72	29 1/4	192	24	FLV1672-29WSMOL		\$3,210	\$3,533
	15 7/8	66	29 1/4	179	22	FLT1666-29WSMOR	\$1,919		
	15 7/8	66	29 1/4	179	22	FLV1666-29WSMOR		\$3,041	\$3,345
	15 7/8	66	29 1/4	179	22	FLT1666-29WSMOL	\$1,919		
	15 7/8	66	29 1/4	179	22	FLV1666-29WSMOL		\$3,041	\$3,345
	15 7/8	60	29 1/4	170	21	FLT1660-29WSMOR	\$1,839		
	15 7/8	60	29 1/4	170	21	FLV1660-29WSMOR		\$2,913	\$3,204
	15 7/8	60	29 1/4	170	21	FLT1660-29WSMOL	\$1,839		
	15 7/8	60	29 1/4	170	21	FLV1660-29WSMOL		\$2,913	\$3,204

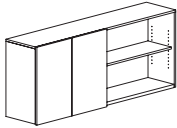

left shown

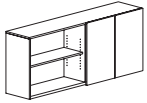

right



78" wide



72" wide



66" wide



60" wide

Features:

- supported by wall cleat - hardware provided by installer
- secure wall attachment required; pilot holes provided in back panel
- laminate grain direction runs horizontal on back panel of overhead cabinets
- 1/4" overhang at the bottom of the door allows access
- adjustable shelves

Options:

- must specify chassis grain direction on artisan veneer, see pages 13-15 for details
- veneer door fronts in paint available, specify paint color and add \$372 list; see page 16 for details
- on laminate units, contrasting laminate door fronts available, no upcharge; specify laminate color, see page 16 for details
- white glass doors with aluminum trim available, specify and add \$1,897 list for 78"w, \$1,794 list for 72"w, \$1,689 list for 66"w, \$1,585 list for 60"w; see page 33 for details
- markerboard laminate doors available, specify and add \$426 list; see page 33 for details
- locking doors available, specify and add \$153 list (not available on glass doors)

Description	D	W	H	CTN WT	CU FT	① Model	Laminate	Essentials Veneer	Artisan Veneer
Wall Mount Double Height Overhead with Two Doors and Open Center	15 7/8	54	29 1/4	169	19	FLT1654-29WSMO	\$1,796		
	15 7/8	54	29 1/4	169	19	FLV1654-29WSMO		\$2,801	\$3,082
	15 7/8	48	29 1/4	154	17	FLT1648-29WSMO	\$1,738		
	15 7/8	48	29 1/4	154	17	FLV1648-29WSMO		\$2,709	\$2,982
	15 7/8	42	29 1/4	139	15	FLT1642-29WSMO	\$1,683		
	15 7/8	42	29 1/4	139	15	FLV1642-29WSMO		\$2,629	\$2,888

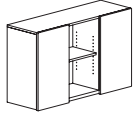

54" wide



48" wide



42" wide

Features:

- supported by wall cleat - hardware provided by installer
- secure wall attachment required; pilot holes provided in back panel
- laminate grain direction runs horizontal on back panel of overhead cabinets
- 1/4" overhang at the bottom of the door allows access
- adjustable shelves

Options:

- must specify chassis grain direction on artisan veneer, see pages 13-15 for details
- veneer door fronts in paint available, specify paint color and add \$372 list; see page 16 for details
- on laminate units, contrasting laminate door fronts available, no upcharge; specify laminate color, see page 16 for details
- white glass doors with aluminum trim available, specify and add \$2,686 list for 54"w, \$2,477 list for 48"w, \$2,270 list for 42"w; see page 33 for details
- markerboard laminate doors available, specify and add \$426 list; see page 33 for details
- locking doors available, specify and add \$306 list (not available on glass doors)

To Order, Specify:

① Laminate Model #	② Laminate Selection	③ Metal Color	④ Other Product Options
Laminate (FLT)	See Laminate Selection	See Metal Finish Color Options	See list of options for each specific unit; Specify and add accordingly.

① Veneer Model #	② Wood Collection	③ Wood Finish	④ Metal Color	⑤ Other Product Options		
Veneer (FLV)	Essentials	See Essentials Wood Finish Options	See Metal Finish Color Options	See list of options for each specific unit; Specify and add accordingly.		
	Artisan	<table border="1"> <thead> <tr> <th>③a Wood Finish</th> <th>③b Chassis Grain Direction</th> </tr> </thead> <tbody> <tr> <td>See Artisan Wood Finish Options</td> <td>For Artisan Only: Vertical Horizontal</td> </tr> </tbody> </table>	③a Wood Finish		③b Chassis Grain Direction	See Artisan Wood Finish Options
③a Wood Finish	③b Chassis Grain Direction					
See Artisan Wood Finish Options	For Artisan Only: Vertical Horizontal					

Description	D	W	H	CTN WT	CU FT	① Model	Laminate	Essentials Veneer	Artisan Veneer
Wall Mount Double Height Overhead Cabinet Sliding Door	15 15/16	96	29 1/4	276	32	FLT1696-29WSD	\$3,003		
	15 15/16	96	29 1/4	276	32	FLV1696-29WSD		\$4,920	\$5,410
	15 15/16	90	29 1/4	261	30	FLT1690-29WSD	\$2,826		
	15 15/16	90	29 1/4	261	30	FLV1690-29WSD		\$4,626	\$5,089
	15 15/16	84	29 1/4	246	28	FLT1684-29WSD	\$2,641		
	15 15/16	84	29 1/4	246	28	FLV1684-29WSD		\$4,328	\$4,762

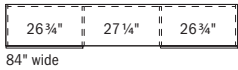
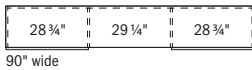
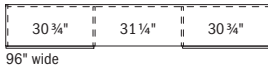
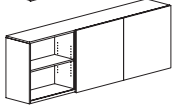
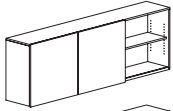
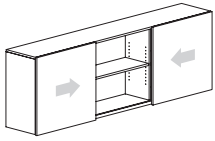

Features:

- supported by wall cleat - hardware provided by installer
- secure wall attachment required; pilot holes provided in back panel
- laminate grain direction runs horizontal on back panel of overhead cabinets
- locking not available
- adjustable shelves

Options:

- must specify chassis grain direction on artisan veneer, see pages 13-15 for details
- veneer door fronts in paint available, specify paint color and add \$372 list; see page 16 for details
- on laminate units, contrasting laminate door fronts available, no upcharge; specify laminate color, see page 16 for details
- white glass doors with aluminum trim available, specify and add \$2,896 list for 96" w, \$2,755 list for 90" w, \$2,616 list for 84" w; see page 33 for details
- markerboard laminate doors available, specify and add \$628 list; see page 33 for details

Wall Mount Double Height Overhead Cabinet Sliding Door	15 15/16	78	29 1/4	214	26	FLT1678-29WSD	\$2,468		
	15 15/16	78	29 1/4	214	26	FLV1678-29WSD		\$3,911	\$4,303
	15 15/16	72	29 1/4	200	25	FLT1672-29WSD	\$2,327		
	15 15/16	72	29 1/4	200	25	FLV1672-29WSD		\$3,690	\$4,060
	15 15/16	66	29 1/4	185	23	FLT1666-29WSD	\$2,203		
	15 15/16	66	29 1/4	185	23	FLV1666-29WSD		\$3,494	\$3,841
	15 15/16	60	29 1/4	178	21	FLT1660-29WSD	\$2,112		
	15 15/16	60	29 1/4	178	21	FLV1660-29WSD		\$3,345	\$3,681

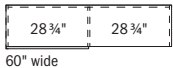
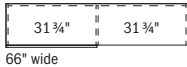
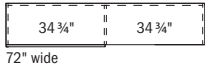
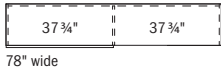
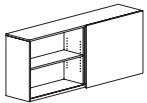
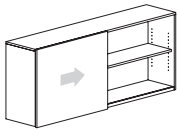

Features:

- supported by wall cleat - hardware provided by installer
- secure wall attachment required; pilot holes provided in back panel
- laminate grain direction runs horizontal on back panel of overhead cabinets
- locking not available
- adjustable shelves

Options:

- must specify chassis grain direction on artisan veneer, see pages 13-15 for details
- veneer door fronts in paint available, specify paint color and add \$372 list; see page 16 for details
- on laminate units, contrasting laminate door fronts available, no upcharge; specify laminate color, see page 16 for details
- white glass doors with aluminum trim available, specify and add \$1,693 list for 78" w, \$1,590 list for 72" w, \$1,485 list for 66" w, \$1,341 list for 60" w; see page 33 for details
- markerboard laminate doors available, specify and add \$317 list; see page 33 for details

Description	D	W	H	CTN WT	CU FT	① Model	Laminate	Essentials Veneer	Artisan Veneer
Wall Mount Double Height Overhead Cabinet Sliding Door	15 15/16	54	29 1/4	157	19	FLT1654-29WSD	\$2,063		
	15 15/16	54	29 1/4	157	19	FLV1654-29WSD		\$3,219	\$3,541
	15 15/16	48	29 1/4	143	17	FLT1648-29WSD	\$1,995		
	15 15/16	48	29 1/4	143	17	FLV1648-29WSD		\$3,116	\$3,428
	15 15/16	42	29 1/4	129	15	FLT1642-29WSD	\$1,931		
	15 15/16	42	29 1/4	129	15	FLV1642-29WSD		\$3,016	\$3,318

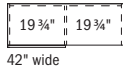
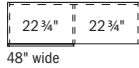
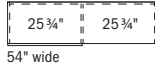
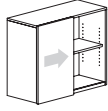

Features:

- supported by wall cleat - hardware provided by installer
- secure wall attachment required; pilot holes provided in back panel
- laminate grain direction runs horizontal on back panel of overhead cabinets
- locking not available
- adjustable shelves

Options:

- must specify chassis grain direction on artisan veneer, see pages 13-15 for details
- veneer door fronts in paint available, specify paint color and add \$372 list; see page 16 for details
- on laminate units, contrasting laminate door fronts available, no upcharge; specify laminate color, see page 16 for details
- white glass doors with aluminum trim available, specify and add \$1,275 list for 54" w, \$1,172 list for 48" w, \$1,068 list for 42" w; see page 33 for details
- markerboard laminate doors available, specify and add \$317 list; see page 33 for details

Wall Mount Double Height Overhead Cabinet Sliding Door	15 15/16	36	29 1/4	115	13	FLT1636-29WSD	\$1,837		
	15 15/16	36	29 1/4	115	13	FLV1636-29WSD		\$2,865	\$3,152
	15 15/16	30	29 1/4	101	11	FLT1630-29WSD	\$1,762		
	15 15/16	30	29 1/4	101	11	FLV1630-29WSD		\$2,750	\$3,026

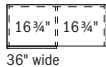
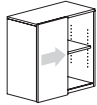

Features:

- supported by wall cleat - hardware provided by installer
- secure wall attachment required; pilot holes provided in back panel
- laminate grain direction runs horizontal on back panel of overhead cabinets
- locking not available
- adjustable shelves

Options:

- must specify chassis grain direction on artisan veneer, see pages 13-15 for details
- veneer door fronts in paint available, specify paint color and add \$372 list; see page 16 for details
- on laminate units, contrasting laminate door fronts available, no upcharge; specify laminate color, see page 16 for details
- white glass doors with aluminum trim available, specify and add \$702 list for 36" w, \$670 list for 30" w; see page 33 for details
- markerboard laminate doors available, specify and add \$317 list; see page 33 for details

To Order, Specify:

① Laminate Model #	② Laminate Selection	③ Metal Color	④ Other Product Options
Laminate (FLT)	See Laminate Selection	See Metal Finish Color Options	See list of options for each specific unit; Specify and add accordingly.

① Veneer Model #	② Wood Collection	③ Wood Finish	④ Metal Color	⑤ Other Product Options		
Veneer (FLV)	Essentials	See Essentials Wood Finish Options	See Metal Finish Color Options	See list of options for each specific unit; Specify and add accordingly.		
	Artisan	<table border="1"> <thead> <tr> <th>③a Wood Finish</th> <th>③b Chassis Grain Direction</th> </tr> </thead> <tbody> <tr> <td>See Artisan Wood Finish Options</td> <td>For Artisan Only: Vertical Horizontal</td> </tr> </tbody> </table>	③a Wood Finish		③b Chassis Grain Direction	See Artisan Wood Finish Options
③a Wood Finish	③b Chassis Grain Direction					
See Artisan Wood Finish Options	For Artisan Only: Vertical Horizontal					

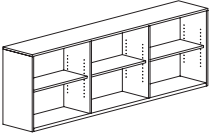
Description	D	W	H	CTN WT	CU FT	① Model	Laminate	Essentials Veneer	Artisan Veneer
Wall Mount Double Height Open Overhead 	15	96	29	222	30	FLT1596-29W00	\$2,296		
	15	96	29	222	30	FLV1596-29W00		\$4,316	\$4,746
	15	90	29	210	29	FLT1590-29W00	\$2,175		
	15	90	29	210	29	FLV1590-29W00		\$4,046	\$4,450
	15	84	29	198	27	FLT1584-29W00	\$2,060		
	15	84	29	198	27	FLV1584-29W00		\$3,776	\$4,155

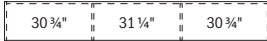

96" wide



90" wide

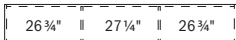

84" wide

Features:

- supported by wall cleat - hardware provided by installer
- secure wall attachment required; pilot holes provided in back panel
- laminate grain direction runs horizontal on back panel of overhead cabinets
- adjustable shelves

Options:

- must specify chassis grain direction on artisan veneer, see pages 13-15 for details

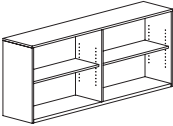
Wall Mount Double Height Open Overhead 	15	78	29	179	25	FLT1578-29W00	\$2,013		
	15	78	29	179	25	FLV1578-29W00		\$3,509	\$3,859
	15	72	29	167	23	FLT1572-29W00	\$1,908		
	15	72	29	167	23	FLV1572-29W00		\$3,238	\$3,561
	15	66	29	155	21	FLT1566-29W00	\$1,802		
	15	66	29	155	21	FLV1566-29W00		\$3,097	\$3,408
	15	60	29	148	19	FLT1560-29W00	\$1,720		
	15	60	29	148	19	FLV1560-29W00		\$2,948	\$3,241

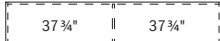

78" wide



72" wide



66" wide

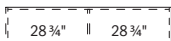

60" wide

Features:

- supported by wall cleat - hardware provided by installer
- secure wall attachment required; pilot holes provided in back panel
- laminate grain direction runs horizontal on back panel of overhead cabinets
- adjustable shelves

Options:

- must specify chassis grain direction on artisan veneer, see pages 13-15 for details

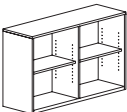
Wall Mount Double Height Open Overhead 	15	54	29	136	18	FLT1554-29W00	\$1,620		
	15	54	29	136	18	FLV1554-29W00		\$2,657	\$2,923
	15	48	29	124	16	FLT1548-29W00	\$1,388		
	15	48	29	124	16	FLV1548-29W00		\$2,327	\$2,560
	15	42	29	112	14	FLT1542-29W00	\$1,318		
	15	42	29	112	14	FLV1542-29W00		\$2,134	\$2,348



54" wide



48" wide

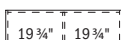

42" wide

Features:

- supported by wall cleat - hardware provided by installer
- secure wall attachment required; pilot holes provided in back panel
- laminate grain direction runs horizontal on back panel of overhead cabinets
- adjustable shelves

Options:

- must specify chassis grain direction on artisan veneer, see pages 13-15 for details

Description	D	W	H	CTN WT	CU FT	① Model	Laminate	Essentials Veneer	Artisan Veneer
Wall Mount Double Height Open Overhead 	15	36	29	89	12	FLT1536-29W00	\$1,147		
	15	36	29	89	12	FLV1536-29W00		\$2,003	\$2,203
	15	30	29	77	10	FLT1530-29W00	\$1,094		
	15	30	29	77	10	FLV1530-29W00		\$1,909	\$2,098

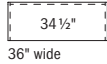

Features:

- supported by wall cleat - hardware provided by installer
- secure wall attachment required; pilot holes provided in back panel
- laminate grain direction runs horizontal on back panel of overhead cabinets
- adjustable shelf

Options:

- must specify chassis grain direction on artisan veneer, see pages 13-15 for details

Overhead Wall Mount Shelf	D	W	H	CTN WT	CU FT	① Model	Laminate	Essentials Veneer	Artisan Veneer
		15	96	17	92	19	FLT1596-17WMS	\$1,189	
15		96	17	92	19	FLV1596-17WMS		\$1,827	\$2,009
15		90	17	86	18	FLT1590-17WMS	\$1,136		
15		90	17	86	18	FLV1590-17WMS		\$1,740	\$1,915
15		84	17	81	17	FLT1584-17WMS	\$1,089		
15		84	17	81	17	FLV1584-17WMS		\$1,670	\$1,839
15		78	17	75	15	FLT1578-17WMS	\$1,045		
15		78	17	75	15	FLV1578-17WMS		\$1,603	\$1,763
15		72	17	69	14	FLT1572-17WMS	\$857		
15		72	17	69	14	FLV1572-17WMS		\$1,312	\$1,443
15		66	17	64	13	FLT1566-17WMS	\$823		
15		66	17	64	13	FLV1566-17WMS		\$1,263	\$1,386
15		60	17	58	12	FLT1560-17WMS	\$790		
15		60	17	58	12	FLV1560-17WMS		\$1,212	\$1,334
15		54	17	52	11	FLT1554-17WMS	\$759		
15		54	17	52	11	FLV1554-17WMS		\$1,163	\$1,281
15		48	17	47	10	FLT1548-17WMS	\$730		
15		48	17	47	10	FLV1548-17WMS		\$1,116	\$1,228
15		42	17	41	9	FLT1542-17WMS	\$699		
15		42	17	41	9	FLV1542-17WMS		\$1,071	\$1,180
15	36	17	36	8	FLT1536-17WMS	\$671			
15	36	17	36	8	FLV1536-17WMS		\$1,029	\$1,136	
15	30	17	31	6	FLT1530-17WMS	\$645			
15	30	17	31	6	FLV1530-17WMS		\$987	\$1,089	

Features:

- supported by wall cleat - hardware provided by installer
- laminate grain direction runs horizontal on back panel of shelf

Options:

- must specify chassis grain direction on artisan veneer, see pages 13-15 for details

To Order, Specify:

① Laminate Model #	② Laminate Selection	③ Metal Color	④ Other Product Options
Laminate (FLT)	See Laminate Selection	See Metal Finish Color Options	See list of options for each specific unit; Specify and add accordingly.

① Veneer Model #	② Wood Collection	③ Wood Finish	④ Metal Color	⑤ Other Product Options		
Veneer (FLV)	Essentials	See Essentials Wood Finish Options	See Metal Finish Color Options	See list of options for each specific unit; Specify and add accordingly.		
	Artisan	<table border="1"> <thead> <tr> <th>③a Wood Finish</th> <th>③b Chassis Grain Direction</th> </tr> </thead> <tbody> <tr> <td>See Artisan Wood Finish Options</td> <td>For Artisan Only: Vertical Horizontal</td> </tr> </tbody> </table>	③a Wood Finish		③b Chassis Grain Direction	See Artisan Wood Finish Options
③a Wood Finish	③b Chassis Grain Direction					
See Artisan Wood Finish Options	For Artisan Only: Vertical Horizontal					

Description	D	W	H	CTN WT	CU FT	① Model	Laminate	Essentials Veneer	Artisan Veneer
Wall Mount Overhead Cabinet with Six Doors	15 7/8	96	17 1/4	184	20	FLT1696-17WSO	\$2,130		
	15 7/8	96	17 1/4	184	20	FLV1696-17WSO		\$3,604	\$3,964
	15 7/8	90	17 1/4	173	19	FLT1690-17WSO	\$2,000		
	15 7/8	90	17 1/4	173	19	FLV1690-17WSO		\$3,386	\$3,726
	15 7/8	84	17 1/4	163	18	FLT1684-17WSO	\$1,869		
	15 7/8	84	17 1/4	163	18	FLV1684-17WSO		\$3,164	\$3,480

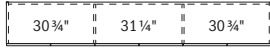
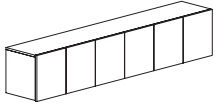

96" wide



90" wide

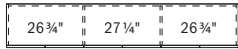

84" wide

Features:

- supported by wall cleat - hardware provided by installer
- secure wall attachment required; pilot holes provided in back panel
- laminate grain direction runs horizontal on back panel of overhead cabinets
- 1/4" overhang at the bottom of the door allows access

Options:

- must specify chassis grain direction on artisan veneer, see pages 13-15 for details
- veneer door fronts in paint available, specify paint color and add \$372 list; see page 16 for details
- on laminate units, contrasting laminate door fronts available, no upcharge; specify laminate color, see page 16 for details
- white glass doors with aluminum trim available, specify and add \$3,692 list; see page 33 for details
- markerboard laminate doors available, specify and add \$1,263 list; see page 33 for details
- locking doors available, specify and add \$306 list (not available on glass doors)

Wall Mount Overhead Cabinet with Four Doors	15 7/8	78	17 1/4	149	16	FLT1678-17WSO	\$1,742		
	15 7/8	78	17 1/4	149	16	FLV1678-17WSO		\$2,851	\$3,137
	15 7/8	72	17 1/4	139	15	FLT1672-17WSO	\$1,643		
	15 7/8	72	17 1/4	139	15	FLV1672-17WSO		\$2,686	\$2,957
	15 7/8	66	17 1/4	129	14	FLT1666-17WSO	\$1,552		
	15 7/8	66	17 1/4	129	14	FLV1666-17WSO		\$2,541	\$2,792
	15 7/8	60	17 1/4	124	13	FLT1660-17WSO	\$1,483		
	15 7/8	60	17 1/4	124	13	FLV1660-17WSO		\$2,428	\$2,673

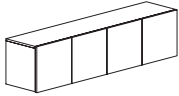

78" wide

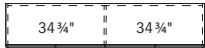

72" wide



66" wide

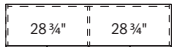

60" wide

Features:

- supported by wall cleat - hardware provided by installer
- secure wall attachment required; pilot holes provided in back panel
- laminate grain direction runs horizontal on back panel of overhead cabinets
- 1/4" overhang at the bottom of the door allows access

Options:

- must specify chassis grain direction on artisan veneer, see pages 13-15 for details
- veneer door fronts in paint available, specify paint color and add \$372 list; see page 16 for details
- on laminate units, contrasting laminate door fronts available, no upcharge; specify laminate color, see page 16 for details
- white glass doors with aluminum trim available, specify and add \$2,683 list for 78"w, \$2,560 list for 72"w, \$2,464 list for 66"w or 60"w; see page 33 for details
- markerboard laminate doors available, specify and add \$843 list; see page 33 for details
- locking doors available, specify and add \$306 list (not available on glass doors)

FLUX

Description	D	W	H	CTN WT	CU FT	① Model	Laminate	Essentials Veneer	Artisan Veneer
Wall Mount Overhead Cabinet with Three Doors	15 7/8	54	17 1/4	115	12	FLT1654-17WSOR	\$1,452		
	15 7/8	54	17 1/4	115	12	FLV1654-17WSOR		\$2,335	\$2,570
	15 7/8	54	17 1/4	115	12	FLT1654-17WSOL	\$1,452		
	15 7/8	54	17 1/4	115	12	FLV1654-17WSOL		\$2,335	\$2,570
	15 7/8	48	17 1/4	103	10	FLT1648-17WSOR	\$1,401		
	15 7/8	48	17 1/4	103	10	FLV1648-17WSOR		\$2,255	\$2,480
	15 7/8	48	17 1/4	103	10	FLT1648-17WSOL	\$1,401		
	15 7/8	48	17 1/4	103	10	FLV1648-17WSOL		\$2,255	\$2,480
	15 7/8	42	17 1/4	93	9	FLT1642-17WSOR	\$1,356		
	15 7/8	42	17 1/4	93	9	FLV1642-17WSOR		\$2,183	\$2,402
	15 7/8	42	17 1/4	93	9	FLT1642-17WSOL	\$1,356		
	15 7/8	42	17 1/4	93	9	FLV1642-17WSOL		\$2,183	\$2,402

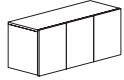

right shown

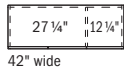
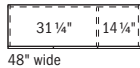
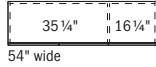

Features:

- supported by wall cleat - hardware provided by installer
- secure wall attachment required; pilot holes provided in back panel
- laminate grain direction runs horizontal on back panel of overhead cabinets
- 1/4" overhang at the bottom of the door allows access

Options:

- must specify chassis grain direction on artisan veneer, see pages 13-15 for details
- veneer door fronts in paint available, specify paint color and add \$372 list; see page 16 for details
- on laminate units, contrasting laminate door fronts available, no upcharge; specify laminate color, see page 16 for details
- white glass doors with aluminum trim available, specify and add \$1,922 list for 54" w, \$1,847 list for 48" w or 42" w; see page 33 for details
- markerboard laminate doors available, specify and add \$634 list; see page 33 for details
- locking doors available, specify and add \$306 list (not available on glass doors)

Wall Mount Overhead Cabinet with Two Doors	15 7/8	36	17 1/4	75	8	FLT1636-17WSO	\$1,287		
	15 7/8	36	17 1/4	75	8	FLV1636-17WSO		\$2,070	\$2,278
	15 7/8	30	17 1/4	65	7	FLT1630-17WSO	\$1,234		
	15 7/8	30	17 1/4	65	7	FLV1630-17WSO		\$1,984	\$2,186

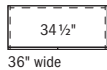
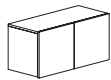

Features:

- supported by wall cleat - hardware provided by installer
- secure wall attachment required; pilot holes provided in back panel
- laminate grain direction runs horizontal on back panel of overhead cabinets
- 1/4" overhang at the bottom of the door allows access

Options:

- must specify chassis grain direction on artisan veneer, see pages 13-15 for details
- veneer door fronts in paint available, specify paint color and add \$372 list; see page 16 for details
- on laminate units, contrasting laminate door fronts available, no upcharge; specify laminate color, see page 16 for details
- white glass doors with aluminum trim available, specify and add \$1,222 list for 36" w, \$1,175 list for 30" w; see page 33 for details
- locking doors available, specify and add \$153 list (not available on glass doors)

To Order, Specify:

① Laminate Model #	② Laminate Selection	③ Metal Color	④ Other Product Options
Laminate (FLT)	See Laminate Selection	See Metal Finish Color Options	See list of options for each specific unit; Specify and add accordingly.

① Veneer Model #	② Wood Collection	③ Wood Finish	④ Metal Color	⑤ Other Product Options
Veneer (FLV)	Essentials	See Essentials Wood Finish Options	See Metal Finish Color Options	See list of options for each specific unit; Specify and add accordingly.
		<table border="1"> <thead> <tr> <th>ⓐ Wood Finish</th> <th>ⓑ Chassis Grain Direction</th> </tr> </thead> <tbody> <tr> <td>See Artisan Wood Finish Options</td> <td>For Artisan Only: Vertical Horizontal</td> </tr> </tbody> </table>		
ⓐ Wood Finish	ⓑ Chassis Grain Direction			
See Artisan Wood Finish Options	For Artisan Only: Vertical Horizontal			

FLUX

Description	D	W	H	CTN WT	CU FT	Model	Laminate	Essentials Veneer	Artisan Veneer
Wall Mount Overhead Cabinet with Four Doors and Open Center	15 7/8	96	17 1/4	172	20	FLT1696-17WSMO	\$2,065		
	15 7/8	96	17 1/4	172	20	FLV1696-17WSMO		\$3,497	\$3,848
	15 7/8	90	17 1/4	162	19	FLT1690-17WSMO	\$1,941		
	15 7/8	90	17 1/4	162	19	FLV1690-17WSMO		\$3,285	\$3,614
	15 7/8	84	17 1/4	153	18	FLT1684-17WSMO	\$1,813		
	15 7/8	84	17 1/4	153	18	FLV1684-17WSMO		\$3,071	\$3,378

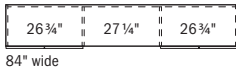
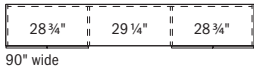
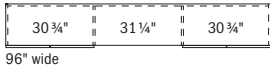
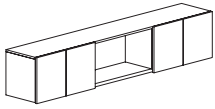

Features:

- supported by wall cleat - hardware provided by installer
- secure wall attachment required; pilot holes provided in back panel
- laminate grain direction runs horizontal on back panel of overhead cabinets
- 1/4" overhang at the bottom of the door allows access

Options:

- must specify chassis grain direction on artisan veneer, see pages 13-15 for details
- veneer door fronts in paint available, specify paint color and add \$372 list; see page 16 for details
- on laminate units, contrasting laminate door fronts available, no upcharge; specify laminate color, see page 16 for details
- white glass doors with aluminum trim available, specify and add \$2,464 list; see page 33 for details
- markerboard laminate doors available, specify and add \$843 list; see page 33 for details
- locking doors available, specify and add \$306 list (not available on glass doors)

Description	D	W	H	CTN WT	CU FT	Model	Laminate	Essentials Veneer	Artisan Veneer
Wall Mount Overhead Cabinet with Two Doors and Open Compartment	15 7/8	78	17 1/4	135	16	FLT1678-17WSMOR	\$1,692		
	15 7/8	78	17 1/4	135	16	FLV1678-17WSMOR		\$2,767	\$3,045
	15 7/8	78	17 1/4	135	16	FLT1678-17WSMOL	\$1,692		
	15 7/8	78	17 1/4	135	16	FLV1678-17WSMOL		\$2,767	\$3,045
	15 7/8	72	17 1/4	126	15	FLT1672-17WSMOR	\$1,594		
	15 7/8	72	17 1/4	126	15	FLV1672-17WSMOR		\$2,609	\$2,871
	15 7/8	72	17 1/4	126	15	FLT1672-17WSMOL	\$1,594		
	15 7/8	72	17 1/4	126	15	FLV1672-17WSMOL		\$2,609	\$2,871
	15 7/8	66	17 1/4	117	14	FLT1666-17WSMOR	\$1,506		
	15 7/8	66	17 1/4	117	14	FLV1666-17WSMOR		\$2,464	\$2,709
	15 7/8	66	17 1/4	117	14	FLT1666-17WSMOL	\$1,506		
	15 7/8	66	17 1/4	117	14	FLV1666-17WSMOL		\$2,464	\$2,709
	15 7/8	60	17 1/4	113	13	FLT1660-17WSMOR	\$1,440		
	15 7/8	60	17 1/4	113	13	FLV1660-17WSMOR		\$2,356	\$2,593
	15 7/8	60	17 1/4	113	13	FLT1660-17WSMOL	\$1,440		
	15 7/8	60	17 1/4	113	13	FLV1660-17WSMOL		\$2,356	\$2,593

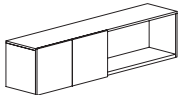

left shown

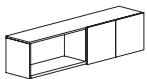

right

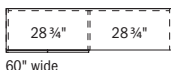
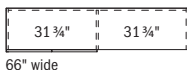
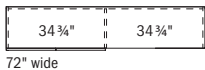
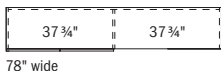

Features:

- supported by wall cleat - hardware provided by installer
- secure wall attachment required; pilot holes provided in back panel
- laminate grain direction runs horizontal on back panel of overhead cabinets
- 1/4" overhang at the bottom of the door allows access

Options:

- must specify chassis grain direction on artisan veneer, see pages 13-15 for details
- veneer door fronts in paint available, specify paint color and add \$372 list; see page 16 for details
- on laminate units, contrasting laminate door fronts available, no upcharge; specify laminate color, see page 16 for details
- white glass doors with aluminum trim available, specify and add \$1,343 list for 78"w, \$1,284 list for 72"w, \$1,234 list for 66"w or 60"w; see page 33 for details
- markerboard laminate doors available, specify and add \$426 list; see page 33 for details
- locking doors available, specify and add \$153 list (not available on glass doors)

FLUX

Description	D	W	H	CTN WT	CU FT	① Model	Laminate	Essentials Veneer	Artisan Veneer
Wall Mount Overhead Cabinet with Two Doors and Open Center	15 7/8	54	17 1/4	111	12	FLT1654-17WSMO	\$1,410		
	15 7/8	54	17 1/4	111	12	FLV1654-17WSMO		\$2,267	\$2,494
	15 7/8	48	17 1/4	102	10	FLT1648-17WSMO	\$1,360		
	15 7/8	48	17 1/4	102	10	FLV1648-17WSMO		\$2,190	\$2,411
	15 7/8	42	17 1/4	92	9	FLT1642-17WSMO	\$1,317		
	15 7/8	42	17 1/4	92	9	FLV1642-17WSMO		\$2,117	\$2,330

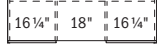
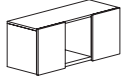

54" wide

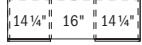

48" wide



42" wide

Features:

- supported by wall cleat - hardware provided by installer
- secure wall attachment required; pilot holes provided in back panel
- laminate grain direction runs horizontal on back panel of overhead cabinets
- 1/4" overhang at the bottom of the door allows access

Options:

- must specify chassis grain direction on artisan veneer, see pages 13-15 for details
- veneer door fronts in paint available, specify paint color and add \$372 list; see page 16 for details
- on laminate units, contrasting laminate door fronts available, no upcharge; specify laminate color, see page 16 for details
- white glass doors with aluminum trim available, specify and add \$1,284 list for 54"w, \$1,234 list for 48"w or 42"w; see page 33 for details
- markerboard laminate doors available, specify and add \$426 list; see page 33 for details
- locking doors available, specify and add \$306 list (not available on glass doors)

To Order, Specify:

① Laminate Model #	② Laminate Selection	③ Metal Color	④ Other Product Options
Laminate (FLT)	See Laminate Selection	See Metal Finish Color Options	See list of options for each specific unit; Specify and add accordingly.

① Veneer Model #	② Wood Collection	③ Wood Finish	④ Metal Color	⑤ Other Product Options		
Veneer (FLV)	Essentials	See Essentials Wood Finish Options	See Metal Finish Color Options	See list of options for each specific unit; Specify and add accordingly.		
	Artisan	<table border="1"> <thead> <tr> <th>③a Wood Finish</th> <th>③b Chassis Grain Direction</th> </tr> </thead> <tbody> <tr> <td>See Artisan Wood Finish Options</td> <td>For Artisan Only: Vertical Horizontal</td> </tr> </tbody> </table>	③a Wood Finish		③b Chassis Grain Direction	See Artisan Wood Finish Options
③a Wood Finish	③b Chassis Grain Direction					
See Artisan Wood Finish Options	For Artisan Only: Vertical Horizontal					

Description	D	W	H	CTN WT	CU FT	Model	Laminate	Essentials Veneer	Artisan Veneer
Wall Mount Overhead Cabinet with Sliding Doors	15 15/16	96	17 1/4	177	20	FLT1696-17WSD	\$2,403		
	15 15/16	96	17 1/4	177	20	FLV1696-17WSD		\$3,934	\$4,326
	15 15/16	90	17 1/4	167	19	FLT1690-17WSD	\$2,261		
	15 15/16	90	17 1/4	167	19	FLV1690-17WSD		\$3,699	\$4,071
	15 15/16	84	17 1/4	158	18	FLT1684-17WSD	\$2,115		
	15 15/16	84	17 1/4	158	18	FLV1684-17WSD		\$3,461	\$3,810

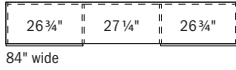
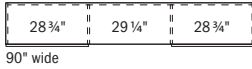
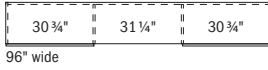
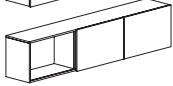
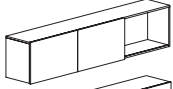
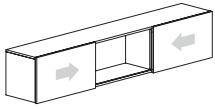

Features:

- supported by wall cleat - hardware provided by installer
- secure wall attachment required; pilot holes provided in back panel
- laminate grain direction runs horizontal on back panel of overhead cabinets
- locking not available

Options:

- must specify chassis grain direction on artisan veneer, see pages 13-15 for details
- veneer door fronts in paint available, specify paint color and add \$372 list; see page 16 for details
- on laminate units, contrasting laminate door fronts available, no upcharge; specify laminate color, see page 16 for details
- white glass doors with aluminum trim available, specify and add \$1,971 list for 96"w, \$1,890 list for 90"w, \$1,808 list for 84"w; see page 33 for details
- markerboard laminate doors available, specify and add \$628 list; see page 33 for details

Wall Mount Overhead Cabinet with Sliding Door	15 15/16	78	17 1/4	138	16	FLT1678-17WSD	\$1,973		
	15 15/16	78	17 1/4	138	16	FLV1678-17WSD		\$3,128	\$3,443
	15 15/16	72	17 1/4	129	15	FLT1672-17WSD	\$1,864		
	15 15/16	72	17 1/4	129	15	FLV1672-17WSD		\$2,953	\$3,248
	15 15/16	66	17 1/4	120	14	FLT1666-17WSD	\$1,763		
	15 15/16	66	17 1/4	120	14	FLV1666-17WSD		\$2,795	\$3,077
	15 15/16	60	17 1/4	111	13	FLT1660-17WSD	\$1,689		
	15 15/16	60	17 1/4	111	13	FLV1660-17WSD		\$2,678	\$2,947

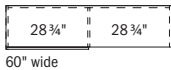
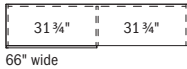
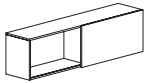
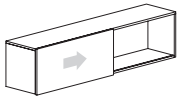

Features:

- supported by wall cleat - hardware provided by installer
- secure wall attachment required; pilot holes provided in back panel
- laminate grain direction runs horizontal on back panel of overhead cabinets
- locking not available

Options:

- must specify chassis grain direction on artisan veneer, see pages 13-15 for details
- veneer door fronts in paint available, specify paint color and add \$372 list; see page 16 for details
- on laminate units, contrasting laminate door fronts available, no upcharge; specify laminate color, see page 16 for details
- white glass doors with aluminum trim available, specify and add \$1,136 list for 78"w, \$1,071 list for 72"w, \$1,011 list for 66"w \$947 list for 60"w; see page 33 for details
- markerboard laminate doors available, specify and add \$317 list; see page 33 for details

FLUX

Description	D	W	H	CTN WT	CU FT	① Model	Laminate	Essentials Veneer	Artisan Veneer
Wall Mount Overhead Cabinet with Sliding Door	15 15/16	54	17 1/4	102	12	FLT1654-17WSD	\$1,650		
	15 15/16	54	17 1/4	102	12	FLV1654-17WSD		\$2,574	\$2,833
	15 15/16	48	17 1/4	92	10	FLT1648-17WSD	\$1,598		
	15 15/16	48	17 1/4	92	10	FLV1648-17WSD		\$2,492	\$2,743
	15 15/16	42	17 1/4	83	9	FLT1642-17WSD	\$1,549		
	15 15/16	42	17 1/4	83	9	FLV1642-17WSD		\$2,413	\$2,654

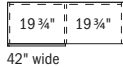
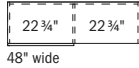
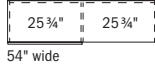
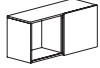
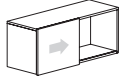

Features:

- supported by wall cleat - hardware provided by installer
- secure wall attachment required; pilot holes provided in back panel
- laminates grain direction runs horizontal on back panel of overhead cabinets
- locking not available

Options:

- must specify chassis grain direction on artisan veneer, see pages 13-15 for details
- veneer door fronts in paint available, specify paint color and add \$372 list; see page 16 for details
- on laminate units, contrasting laminate door fronts available, no upcharge; specify laminate color, see page 16 for details
- white glass doors with aluminum trim available, specify and add \$887 list for 54"w, \$858 list for 48"w, \$826 list for 42"w; see page 33 for details
- markerboard laminate doors available, specify and add \$317 list; see page 33 for details

Wall Mount Overhead Cabinet with Sliding Door	15 15/16	36	17 1/4	74	8	FLT1636-17WSD	\$1,468		
	15 15/16	36	17 1/4	74	8	FLV1636-17WSD		\$2,292	\$2,524
	15 15/16	30	17 1/4	65	7	FLT1630-17WSD	\$1,414		
	15 15/16	30	17 1/4	65	7	FLV1630-17WSD		\$2,200	\$2,421

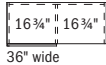

Features:

- supported by wall cleat - hardware provided by installer
- secure wall attachment required; pilot holes provided in back panel
- laminates grain direction runs horizontal on back panel of overhead cabinets
- locking not available

Options:

- must specify chassis grain direction on artisan veneer, see pages 13-15 for details
- veneer door fronts in paint available, specify paint color and add \$372 list; see page 16 for details
- on laminate units, contrasting laminate door fronts available, no upcharge; specify laminate color, see page 16 for details
- white glass doors with aluminum trim available, specify and add \$702 list for 36"w, \$670 list for 30"w; see page 33 for details
- markerboard laminate doors available, specify and add \$317 list; see page 33 for details

To Order, Specify:

① Laminate Model #	② Laminate Selection	③ Metal Color	④ Other Product Options
Laminate (FLT)	See Laminate Selection	See Metal Finish Color Options	See list of options for each specific unit; Specify and add accordingly.

① Veneer Model #	② Wood Collection	③ Wood Finish	④ Metal Color	⑤ Other Product Options
Veneer (FLV)	Essentials	See Essentials Wood Finish Options	See Metal Finish Color Options	See list of options for each specific unit; Specify and add accordingly.
	Artisan	ⓐ Wood Finish See Artisan Wood Finish Options	ⓑ Chassis Grain Direction For Artisan Only: Vertical Horizontal	

Description	D	W	H	CTN WT	CU FT	① Model	Laminate	Essentials Veneer	Artisan Veneer
Wall Mount Open Overhead	15	96	17	145	19	FLT1596-17W00	\$1,852		
	15	96	17	145	19	FLV1596-17W00		\$3,137	\$3,452
	15	90	17	137	18	FLT1590-17W00	\$1,741		
	15	90	17	137	18	FLV1590-17W00		\$2,948	\$3,241
	15	84	17	130	17	FLT1584-17W00	\$1,627		
	15	84	17	130	17	FLV1584-17W00		\$2,754	\$3,030

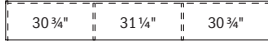
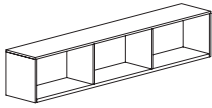

96" wide

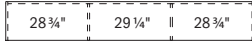

90" wide

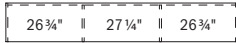

84" wide

Features:

- supported by wall cleat - hardware provided by installer
- secure wall attachment required; pilot holes provided in back panel
- laminate grain direction runs horizontal on back panel of overhead cabinets

Options:

- must specify chassis grain direction on artisan veneer, see pages 13-15 for details

Wall Mount Open Overhead	15	78	17	117	15	FLT1578-17W00	\$1,516		
	15	78	17	117	15	FLV1578-17W00		\$2,483	\$2,732
	15	72	17	109	14	FLT1572-17W00	\$1,430		
	15	72	17	109	14	FLV1572-17W00		\$2,341	\$2,572
	15	66	17	101	13	FLT1566-17W00	\$1,352		
	15	66	17	101	13	FLV1566-17W00		\$2,210	\$2,430
Wall Mount Open Overhead	15	60	17	98	12	FLT1560-17W00	\$1,294		
	15	60	17	98	12	FLV1560-17W00		\$2,114	\$2,325

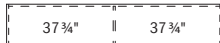
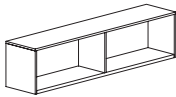

78" wide

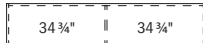

72" wide



66" wide

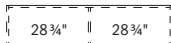

60" wide



Features:

- supported by wall cleat - hardware provided by installer
- secure wall attachment required; pilot holes provided in back panel
- laminate grain direction runs horizontal on back panel of overhead cabinets

Options:

- must specify chassis grain direction on artisan veneer, see pages 13-15 for details

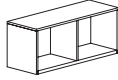
FLUX

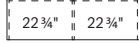
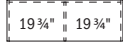

Description	D	W	H	CTN WT	CU FT	① Model	Laminate	Essentials Veneer	Artisan Veneer
Wall Mount Open Overhead   54" wide  48" wide  42" wide	15	54	17	90	11	FLT1554-17W00	\$1,265		
	15	54	17	90	11	FLV1554-17W00		\$2,035	\$2,239
	15	48	17	82	10	FLT1548-17W00	\$1,221		
	15	48	17	82	10	FLV1548-17W00		\$1,966	\$2,160
	15	42	17	74	9	FLT1542-17W00	\$1,183		
	15	42	17	74	9	FLV1542-17W00		\$1,902	\$2,091

Features:

- supported by wall cleat - hardware provided by installer
- secure wall attachment required; pilot holes provided in back panel
- laminated grain direction runs horizontal on back panel of overhead cabinets

Options:

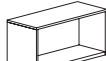
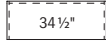
- must specify chassis grain direction on artisan veneer, see pages 13-15 for details

Wall Mount Open Overhead   36" wide  30" wide	15	36	17	57	8	FLT1536-17W00	\$1,120		
	15	36	17	57	8	FLV1536-17W00		\$1,801	\$1,983
	15	30	17	49	6	FLT1530-17W00	\$1,075		
	15	30	17	49	6	FLV1530-17W00		\$1,728	\$1,902

Features:

- supported by wall cleat - hardware provided by installer
- secure wall attachment required; pilot holes provided in back panel
- laminated grain direction runs horizontal on back panel of overhead cabinets

Options:

- must specify chassis grain direction on artisan veneer, see pages 13-15 for details

To Order, Specify:

① Laminate Model #	② Laminate Selection	③ Metal Color	④ Other Product Options
Laminate (FLT)	See Laminate Selection	See Metal Finish Color Options	See list of options for each specific unit; Specify and add accordingly.

① Veneer Model #	② Wood Collection	③ Wood Finish	④ Metal Color	⑤ Other Product Options		
Veneer (FLV)	Essentials	See Essentials Wood Finish Options	See Metal Finish Color Options	See list of options for each specific unit; Specify and add accordingly.		
	Artisan	<table border="1"> <thead> <tr> <th>③a Wood Finish</th> <th>③b Chassis Grain Direction</th> </tr> </thead> <tbody> <tr> <td>See Artisan Wood Finish Options</td> <td>For Artisan Only: Vertical Horizontal</td> </tr> </tbody> </table>	③a Wood Finish		③b Chassis Grain Direction	See Artisan Wood Finish Options
③a Wood Finish	③b Chassis Grain Direction					
See Artisan Wood Finish Options	For Artisan Only: Vertical Horizontal					

Description	D	W	H	CTN WT	CU FT	① Model	Laminate	Essentials Veneer	Artisan Veneer
Wall Mount Cubby with Open Vertical Storage Compartment	15	96	17	100	19	FLT1596WCUOR	\$2,181		
	15	96	17	100	19	FLV1596WCUOR		\$3,358	\$3,691
	15	96	17	100	19	FLT1596WCUOL	\$2,181		
	15	96	17	100	19	FLV1596WCUOL		\$3,358	\$3,691
	15	90	17	96	18	FLT1590WCUOR	\$2,053		
	15	90	17	96	18	FLV1590WCUOR		\$3,052	\$3,359
	15	90	17	96	18	FLT1590WCUOL	\$2,053		
	15	90	17	96	18	FLV1590WCUOL		\$3,052	\$3,359
	15	84	17	91	17	FLT1584WCUOR	\$2,016		
	15	84	17	91	17	FLV1584WCUOR		\$2,834	\$3,118
	15	84	17	91	17	FLT1584WCUOL	\$2,016		
	15	84	17	91	17	FLV1584WCUOL		\$2,834	\$3,118

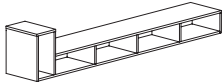

left shown

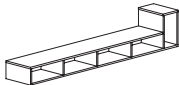

right

Features:

- supported by wall cleat - hardware provided by installer
- laminate grain direction runs horizontal on back panel of cubbies

Options:

- must specify chassis grain direction on artisan veneer, see pages 13-15 for details

Wall Mount Cubby with Open Vertical Storage Compartment	15	78	17	85	15	FLT1578WCUOR	\$1,794		
	15	78	17	85	15	FLV1578WCUOR		\$2,743	\$3,016
	15	78	17	85	15	FLT1578WCUOL	\$1,794		
	15	78	17	85	15	FLV1578WCUOL		\$2,743	\$3,016
	15	72	17	80	14	FLT1572WCUOR	\$1,684		
	15	72	17	80	14	FLV1572WCUOR		\$2,567	\$2,826
	15	72	17	80	14	FLT1572WCUOL	\$1,684		
	15	72	17	80	14	FLV1572WCUOL		\$2,567	\$2,826
	15	66	17	75	13	FLT1566WCUOR	\$1,574		
	15	66	17	75	13	FLV1566WCUOR		\$2,391	\$2,632
	15	66	17	75	13	FLT1566WCUOL	\$1,574		
	15	66	17	75	13	FLV1566WCUOL		\$2,391	\$2,632
	15	60	17	70	12	FLT1560WCUOR	\$1,476		
	15	60	17	70	12	FLV1560WCUOR		\$2,235	\$2,461
	15	60	17	70	12	FLT1560WCUOL	\$1,476		
	15	60	17	70	12	FLV1560WCUOL		\$2,235	\$2,461

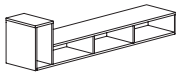

left shown

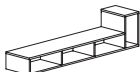

right

Features:

- supported by wall cleat - hardware provided by installer
- laminate grain direction runs horizontal on back panel of cubbies

Options:

- must specify chassis grain direction on artisan veneer, see pages 13-15 for details

FLUX

Description	D	W	H	CTN WT	CU FT	① Model	Laminate	Essentials Veneer	Artisan Veneer
Wall Mount Cubby with Open Vertical Storage Compartment	15	54	17	64	11	FLT1554WCUOR	\$1,385		
	15	54	17	64	11	FLV1554WCUOR		\$2,094	\$2,304
	15	54	17	64	11	FLT1554WCUOL	\$1,385		
	15	54	17	64	11	FLV1554WCUOL		\$2,094	\$2,304
	15	48	17	59	10	FLT1548WCUOR	\$1,307		
	15	48	17	59	10	FLV1548WCUOR		\$1,969	\$2,165
	15	48	17	59	10	FLT1548WCUOL	\$1,307		
	15	48	17	59	10	FLV1548WCUOL		\$1,969	\$2,165
	15	42	17	54	9	FLT1542WCUOR	\$1,226		
	15	42	17	54	9	FLV1542WCUOR		\$1,842	\$2,026
	15	42	17	54	9	FLT1542WCUOL	\$1,226		
	15	42	17	54	9	FLV1542WCUOL		\$1,842	\$2,026

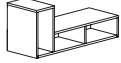

left shown

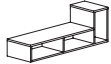

right

Features:

- supported by wall cleat - hardware provided by installer
- laminate grain direction runs horizontal on back panel of cubbies

Options:

- must specify chassis grain direction on artisan veneer, see pages 13-15 for details

Wall Mount Cubby with Open Vertical Storage Compartment	15	36	17	49	8	FLT1536WCUOR	\$1,153		
	15	36	17	49	8	FLV1536WCUOR		\$1,727	\$1,900
	15	36	17	49	8	FLT1536WCUOL	\$1,153		
	15	36	17	49	8	FLV1536WCUOL		\$1,727	\$1,900
	15	30	17	44	6	FLT1530WCUOR	\$1,090		
	15	30	17	44	6	FLV1530WCUOR		\$1,626	\$1,790
	15	30	17	44	6	FLT1530WCUOL	\$1,090		
	15	30	17	44	6	FLV1530WCUOL		\$1,626	\$1,790

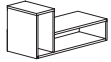

left shown



right

Features:

- supported by wall cleat - hardware provided by installer
- laminate grain direction runs horizontal on back panel of cubbies



Options:

- must specify chassis grain direction on artisan veneer, see pages 13-15 for details

To Order, Specify:

① Laminate Model #	② Laminate Selection	③ Metal Color	④ Other Product Options
Laminate (FLT)	See Laminate Selection	See Metal Finish Color Options	See list of options for each specific unit; Specify and add accordingly.

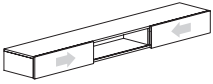
① Veneer Model #	② Wood Collection	③ Wood Finish	④ Metal Color	⑤ Other Product Options		
Veneer (FLV)	Essentials	See Essentials Wood Finish Options	See Metal Finish Color Options	See list of options for each specific unit; Specify and add accordingly.		
	Artisan	<table border="1"> <thead> <tr> <th>③a Wood Finish</th> <th>③b Chassis Grain Direction</th> </tr> </thead> <tbody> <tr> <td>See Artisan Wood Finish Options</td> <td>For Artisan Only: Vertical Horizontal</td> </tr> </tbody> </table>	③a Wood Finish		③b Chassis Grain Direction	See Artisan Wood Finish Options
③a Wood Finish	③b Chassis Grain Direction					
See Artisan Wood Finish Options	For Artisan Only: Vertical Horizontal					

Description	D	W	H	CTN WT	CU FT	① Model	Laminate	Essentials Veneer	Artisan Veneer
Wall Mount Cubby with Sliding Doors   	15 15/16	96	8 1/4	111	11	FLT1696WSDCU	\$2,210		
	15 15/16	96	8 1/4	111	11	FLV1696WSDCU		\$3,621	\$3,984
	15 15/16	90	8 1/4	100	11	FLT1690WSDCU	\$2,081		
	15 15/16	90	8 1/4	100	11	FLV1690WSDCU		\$3,406	\$3,745
	15 15/16	84	8 1/4	89	10	FLT1684WSDCU	\$1,947		
	15 15/16	84	8 1/4	89	10	FLV1684WSDCU		\$3,187	\$3,505

Features:

- supported by wall cleat - hardware provided by installer
- laminate grain direction runs horizontal on back panel of cubbies
- locking not available

Options:

- must specify chassis grain direction on artisan veneer, see pages 13-15 for details
- veneer door fronts in paint available, specify paint color and add \$372 list; see page 16 for details
- on laminate units, contrasting laminate door fronts available, no upcharge; specify laminate color, see page 16 for details
- white glass doors with aluminum trim available, specify and add \$1,808 list for 96" w, \$1,730 list for 90" w, \$1,696 list for 84" w; see page 33 for details
- markerboard laminate doors available, specify and add \$628 list; see page 33 for details

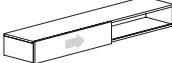
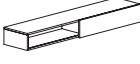
Wall Mount Cubby with Sliding Door  	15 15/16	78	8 1/4	79	9	FLT1678WSDCU	\$1,818		
	15 15/16	78	8 1/4	79	9	FLV1678WSDCU		\$2,880	\$3,167
	15 15/16	72	8 1/4	74	9	FLT1672WSDCU	\$1,714		
	15 15/16	72	8 1/4	74	9	FLV1672WSDCU		\$2,718	\$2,991
	15 15/16	66	8 1/4	69	8	FLT1666WSDCU	\$1,625		
	15 15/16	66	8 1/4	69	8	FLV1666WSDCU		\$2,571	\$2,829
	15 15/16	60	8 1/4	63	7	FLT1660WSDCU	\$1,556		
	15 15/16	60	8 1/4	63	7	FLV1660WSDCU		\$2,464	\$2,709

Features:

- supported by wall cleat - hardware provided by installer
- laminate grain direction runs horizontal on back panel of cubbies
- locking not available

Options:

- must specify chassis grain direction on artisan veneer, see pages 13-15 for details
- veneer door fronts in paint available, specify paint color and add \$372 list; see page 16 for details
- on laminate units, contrasting laminate door fronts available, no upcharge; specify laminate color, see page 16 for details
- white glass doors with aluminum trim available, specify and add \$908 list for 78" w, \$868 list for 72" w, \$852 list for 66" w or 60" w; see page 33 for details
- markerboard laminate doors available, specify and add \$317 list; see page 33 for details

FLUX

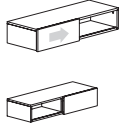
Description	D	W	H	CTN WT	CU FT	① Model	Laminate	Essentials Veneer	Artisan Veneer
Wall Mount Cubby with Sliding Door 	15 15/16	54	8 1/4	58	7	FLT1654WSDCU	\$1,520		
	15 15/16	54	8 1/4	58	7	FLV1654WSDCU		\$2,370	\$2,609
	15 15/16	48	8 1/4	53	6	FLT1648WSDCU	\$1,472		
	15 15/16	48	8 1/4	53	6	FLV1648WSDCU		\$2,292	\$2,524
	15 15/16	42	8 1/4	48	5	FLT1642WSDCU	\$1,424		
	15 15/16	42	8 1/4	48	5	FLV1642WSDCU		\$2,221	\$2,444
	15 15/16	36	8 1/4	43	5	FLT1636WSDCU	\$1,353		
	15 15/16	36	8 1/4	43	5	FLV1636WSDCU		\$2,109	\$2,322
	15 15/16	30	8 1/4	38	4	FLT1630WSDCU	\$1,298		
	15 15/16	30	8 1/4	38	4	FLV1630WSDCU		\$2,023	\$2,226

Features:

- supported by wall cleat - hardware provided by installer
- laminate grain direction runs horizontal on back panel of cubbies
- locking not available

Options:

- must specify chassis grain direction on artisan veneer, see pages 13-15 for details
- veneer door fronts in paint available, specify paint color and add \$372 list; see page 16 for details
- on laminate units, contrasting laminate door fronts available, no upcharge; specify laminate color, see page 16 for details
- white glass doors with aluminum trim available, specify and add \$852 list; see page 33 for details
- markerboard laminate doors available, specify and add \$317 list; see page 33 for details

FLUX

To Order, Specify:

① Laminate Model #	② Laminate Selection	③ Metal Color	④ Other Product Options
Laminate (FLT)	See Laminate Selection	See Metal Finish Color Options	See list of options for each specific unit; Specify and add accordingly.

① Veneer Model #	② Wood Collection	③ Wood Finish	④ Metal Color	⑤ Other Product Options	
Veneer (FLV)	Essentials	See Essentials Wood Finish Options	See Metal Finish Color Options	See list of options for each specific unit; Specify and add accordingly.	
	Artisan	<table border="1"> <thead> <tr> <th>③a Wood Finish</th> <th>③b Chassis Grain Direction</th> </tr> </thead> <tbody> <tr> <td>See Artisan Wood Finish Options</td> <td>For Artisan Only: Vertical Horizontal</td> </tr> </tbody> </table>			③a Wood Finish
③a Wood Finish	③b Chassis Grain Direction				
See Artisan Wood Finish Options	For Artisan Only: Vertical Horizontal				

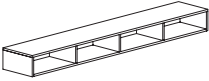
Description	D	W	H	CTN WT	CU FT	① Model	Laminate	Essentials Veneer	Artisan Veneer
15"d Wall Mount Cubby 	15	96	8	90	11	FLT1596WCU	\$1,866		
	15	96	8	90	11	FLV1596WCU		\$2,871	\$3,158
	15	90	8	86	10	FLT1590WCU	\$1,755		
	15	90	8	86	10	FLV1590WCU		\$2,611	\$2,873
	15	84	8	81	9	FLT1584WCU	\$1,726		
	15	84	8	81	9	FLV1584WCU		\$2,424	\$2,666

Features:

- supported by wall cleat - hardware provided by installer
- laminate grain direction runs horizontal on back panel of cubbies

Options:

- must specify chassis grain direction on artisan veneer, see pages 13-15 for details

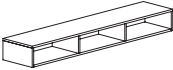
Description	D	W	H	CTN WT	CU FT	① Model	Laminate	Essentials Veneer	Artisan Veneer
15"d Wall Mount Cubby 	15	78	8	75	9	FLT1578WCU	\$1,533		
	15	78	8	75	9	FLV1578WCU		\$2,345	\$2,577
	15	72	8	70	8	FLT1572WCU	\$1,440		
	15	72	8	70	8	FLV1572WCU		\$2,196	\$2,414
	15	66	8	65	8	FLT1566WCU	\$1,344		
	15	66	8	65	8	FLV1566WCU		\$2,045	\$2,250
	15	60	8	60	7	FLT1560WCU	\$1,264		
	15	60	8	60	7	FLV1560WCU		\$1,913	\$2,104

Features:

- supported by wall cleat - hardware provided by installer
- laminate grain direction runs horizontal on back panel of cubbies

Options:

- must specify chassis grain direction on artisan veneer, see pages 13-15 for details

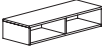
Description	D	W	H	CTN WT	CU FT	① Model	Laminate	Essentials Veneer	Artisan Veneer
15"d Wall Mount Cubby 	15	54	8	54	6	FLT1554WCU	\$1,185		
	15	54	8	54	6	FLV1554WCU		\$1,792	\$1,970
	15	48	8	49	6	FLT1548WCU	\$1,116		
	15	48	8	49	6	FLV1548WCU		\$1,684	\$1,851
	15	42	8	44	5	FLT1542WCU	\$1,047		
	15	42	8	44	5	FLV1542WCU		\$1,577	\$1,731
	15	36	8	39	4	FLT1536WCU	\$987		
	15	36	8	39	4	FLV1536WCU		\$1,477	\$1,625
	15	30	8	34	4	FLT1530WCU	\$933		
	15	30	8	34	4	FLV1530WCU		\$1,389	\$1,527

Features:

- supported by wall cleat - hardware provided by installer
- laminate grain direction runs horizontal on back panel of cubbies

Options:

- must specify chassis grain direction on artisan veneer, see pages 13-15 for details

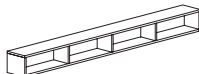
Description	D	W	H	CTN WT	CU FT	① Model	Laminate	Essentials Veneer	Artisan Veneer
9"d Wall Mount Cubby 	9	96	8	68	7	FLT0996WCU	\$1,666		
	9	96	8	68	7	FLV0996WCU		\$2,562	\$2,822
	9	90	8	64	7	FLT0990WCU	\$1,569		
	9	90	8	64	7	FLV0990WCU		\$2,331	\$2,566
	9	84	8	60	6	FLT0984WCU	\$1,541		
	9	84	8	60	6	FLV0984WCU		\$2,163	\$2,381

Features:

- supported by wall cleat - hardware provided by installer
- laminate grain direction runs horizontal on back panel of cubbies

Options:

- must specify chassis grain direction on artisan veneer, see pages 13-15 for details

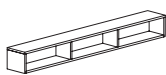
9"d Wall Mount Cubby 	9	78	8	55	6	FLT0978WCU	\$1,370		
	9	78	8	55	6	FLV0978WCU		\$2,092	\$2,302
	9	72	8	51	5	FLT0972WCU	\$1,287		
	9	72	8	51	5	FLV0972WCU		\$1,961	\$2,156
	9	66	8	49	5	FLT0966WCU	\$1,203		
	9	66	8	49	5	FLV0966WCU		\$1,827	\$2,009
	9	60	8	43	5	FLT0960WCU	\$1,127		
	9	60	8	43	5	FLV0960WCU		\$1,708	\$1,878

Features:

- supported by wall cleat - hardware provided by installer
- laminate grain direction runs horizontal on back panel of cubbies

Options:

- must specify chassis grain direction on artisan veneer, see pages 13-15 for details

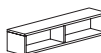
9"d Wall Mount Cubby 	9	54	8	39	4	FLT0954WCU	\$1,058		
	9	54	8	39	4	FLV0954WCU		\$1,601	\$1,761
	9	48	8	35	4	FLT0948WCU	\$1,000		
	9	48	8	35	4	FLV0948WCU		\$1,505	\$1,653
	9	42	8	31	3	FLT0942WCU	\$936		
	9	42	8	31	3	FLV0942WCU		\$1,406	\$1,548
	9	36	8	27	3	FLT0936WCU	\$882		
	9	36	8	27	3	FLV0936WCU		\$1,318	\$1,452
	9	30	8	23	3	FLT0930WCU	\$833		
9	30	8	23	3	FLV0930WCU		\$1,241	\$1,364	

Features:

- supported by wall cleat - hardware provided by installer
- laminate grain direction runs horizontal on back panel of cubbies

Options:

- must specify chassis grain direction on artisan veneer, see pages 13-15 for details

To Order, Specify:

① Laminate Model #	② Laminate Selection	③ Metal Color	④ Other Product Options
Laminate (FLT)	See Laminate Selection	See Metal Finish Color Options	See list of options for each specific unit; Specify and add accordingly.

① Veneer Model #	② Wood Collection	③ Wood Finish	④ Metal Color	⑤ Other Product Options
Veneer (FLV)	Essentials	See Essentials Wood Finish Options	See Metal Finish Color Options	See list of options for each specific unit; Specify and add accordingly.
	Artisan	③a Wood Finish See Artisan Wood Finish Options	③b Chassis Grain Direction For Artisan Only: Vertical Horizontal	

Description	D	W	H	CTN WT	CU FT	Model	Laminate	Essentials Veneer	Artisan Veneer
Wall Mount Panel 	1 1/16	48	40 13/16	53	5	FLT4841WMP	\$1,217		
	1 1/16	48	40 13/16	53	5	FLV4841WMP		\$1,915	\$2,107
	1 1/16	42	40 13/16	48	4	FLT4241WMP	\$1,194		
	1 1/16	42	40 13/16	48	4	FLV4241WMP		\$1,877	\$2,064
	1 1/16	39	40 13/16	45	4	FLT3941WMP	\$1,164		
	1 1/16	39	40 13/16	45	4	FLV3941WMP		\$1,836	\$2,018
	1 1/16	36	40 13/16	42	4	FLT3641WMP	\$1,139		
	1 1/16	36	40 13/16	42	4	FLV3641WMP		\$1,794	\$1,971
	1 1/16	33	40 13/16	38	4	FLT3341WMP	\$1,109		
	1 1/16	33	40 13/16	38	4	FLV3341WMP		\$1,753	\$1,926
	1 1/16	30	40 13/16	36	3	FLT3041WMP	\$1,081		
	1 1/16	30	40 13/16	36	3	FLV3041WMP		\$1,714	\$1,885
	1 1/16	24	40 13/16	29	3	FLT2441WMP	\$1,061		
	1 1/16	24	40 13/16	29	3	FLV2441WMP		\$1,678	\$1,845
	1 1/16	18	40 13/16	23	2	FLT1841WMP	\$1,039		
1 1/16	18	40 13/16	23	2	FLV1841WMP		\$1,643	\$1,805	

Features:

- pair with primary height units to achieve 69" overall height
- supported by wall cleat - hardware provided by installer
- grain direction runs vertical on essentials veneer, horizontal on laminate
- spacing of attachment cleats allows wire management

Options:

- must specify chassis grain direction on artisan veneer, see pages 13-15 for details

Description	D	W	H	CTN WT	CU FT	Model	List Price
Wall Mount Markerboard 	1 1/16	48	40 13/16	53	5	FLB4841WMMB	\$1,434
	1 1/16	42	40 13/16	48	4	FLB4241WMMB	\$1,407
	1 1/16	39	40 13/16	45	4	FLB3941WMMB	\$1,376
	1 1/16	36	40 13/16	42	4	FLB3641WMMB	\$1,341
	1 1/16	33	40 13/16	38	4	FLB3341WMMB	\$1,308
	1 1/16	30	40 13/16	36	3	FLB3041WMMB	\$1,275
	1 1/16	24	40 13/16	29	3	FLB2441WMMB	\$1,249
	1 1/16	18	40 13/16	23	2	FLB1841WMMB	\$1,226

Features:

- pair with primary height units to achieve 69" overall height
- supported by wall cleat - hardware provided by installer
- standard markerboard laminate with aluminum pvc edge
- spacing of attachment cleats allows wire management

FLUX

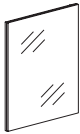
Description	D	W	H	CTN WT	CU FT	① Model	List Price
 Wall Mount Glass Markerboard	1 9/16	48	40 13/16	75	4	FLB4841WMMBG	\$3,713
	1 9/16	42	40 13/16	65	4	FLB4241WMMBG	\$3,171
	1 9/16	39	40 13/16	61	4	FLB3941WMMBG	\$3,016
	1 9/16	36	40 13/16	56	3	FLB3641WMMBG	\$2,863
	1 9/16	33	40 13/16	51	3	FLB3341WMMBG	\$2,706
	1 9/16	30	40 13/16	47	3	FLB3041WMMBG	\$2,550
	1 9/16	24	40 13/16	38	2	FLB2441WMMBG	\$2,241
	1 9/16	18	40 13/16	28	2	FLB1841WMMBG	\$1,931

Features:



- pair with primary height units to achieve 69" overall height
- supported by wall cleat - hardware provided by installer
- white back painted glass with an aluminum profile frame
- spacing of attachment cleats allows wire management

FLUX





To Order, Specify:

① Laminate Model #	② Laminate Selection	③ Metal Color	④ Other Product Options
Laminate (FLT)	See Laminate Selection	See Metal Finish Color Options	See list of options for each specific unit; Specify and add accordingly.

① Veneer Model #	② Wood Collection	③ Wood Finish	④ Metal Color	⑤ Other Product Options	
Veneer (FLV)	Essentials	See Essentials Wood Finish Options	See Metal Finish Color Options	See list of options for each specific unit; Specify and add accordingly.	
	Artisan	<table border="1"> <thead> <tr> <th>③a Wood Finish</th> <th>③b Chassis Grain Direction</th> </tr> </thead> <tbody> <tr> <td>See Artisan Wood Finish Options</td> <td>For Artisan Only: Vertical Horizontal</td> </tr> </tbody> </table>			③a Wood Finish
③a Wood Finish	③b Chassis Grain Direction				
See Artisan Wood Finish Options	For Artisan Only: Vertical Horizontal				

Description	D	W	H	CTN WT	CU FT	① Model	List Price Per Grade			
 <p>48\"w Wall Mount Tack Panel</p> <p>Features:</p> <ul style="list-style-type: none"> · pair with primary height units to achieve 69\"overall height · supported by wall cleat - hardware provided by installer · com ydg: 1 ½ 	1 ⅞	48	40 ¾	34	5	FLB4841WT	COM \$1,022 A \$1,090 B \$1,104 C \$1,145 D \$1,202 E \$1,253 F \$1,312 G \$1,382 H \$1,489 I \$1,526 J \$1,619			
	 <p>42\"w Wall Mount Tack Panel</p> <p>Features:</p> <ul style="list-style-type: none"> · pair with primary height units to achieve 69\"overall height · supported by wall cleat - hardware provided by installer · com ydg: 1 ½ 	1 ⅞	42	40 ¾	32	4	FLB4241WT	COM \$957 A \$1,025 B \$1,039 C \$1,080 D \$1,137 E \$1,188 F \$1,247 G \$1,317 H \$1,424 I \$1,460 J \$1,552		
		 <p>39\"w Wall Mount Tack Panel</p> <p>Features:</p> <ul style="list-style-type: none"> · pair with primary height units to achieve 69\"overall height · supported by wall cleat - hardware provided by installer · com ydg: 1 ¼ 	1 ⅞	39	40 ¾	31	4	FLB3941WT	COM \$923 A \$980 B \$993 C \$1,026 D \$1,074 E \$1,117 F \$1,166 G \$1,224 H \$1,314 I \$1,344 J \$1,423	
			 <p>36\"w Wall Mount Tack Panel</p> <p>Features:</p> <ul style="list-style-type: none"> · pair with primary height units to achieve 69\"overall height · supported by wall cleat - hardware provided by installer · com ydg: 1 ¼ 	1 ⅞	36	40 ¾	30	4	FLB3641WT	COM \$890 A \$947 B \$958 C \$992 D \$1,039 E \$1,083 F \$1,131 G \$1,189 H \$1,279 I \$1,310 J \$1,388

FLUX

Description	D	W	H	CTN WT	CU FT	① Model	List Price Per Grade
33"w Wall Mount Tack Panel	1 9/16	33	40 3/4	29	4	FLB3341WT	COM \$857 A \$914 B \$927 C \$960 D \$1,007 E \$1,050 F \$1,100 G \$1,158 H \$1,248 I \$1,277 J \$1,355
	Features: <ul style="list-style-type: none"> · pair with primary height units to achieve 69" overall height · supported by wall cleat - hardware provided by installer · com ydg: 1 1/4 						
30"w Wall Mount Tack Panel	1 9/16	30	40 3/4	28	3	FLB3041WT	COM \$825 A \$870 B \$879 C \$907 D \$944 E \$979 F \$1,018 G \$1,064 H \$1,138 I \$1,163 J \$1,226
	Features: <ul style="list-style-type: none"> · pair with primary height units to achieve 69" overall height · supported by wall cleat - hardware provided by installer · com ydg: 1 						
24"w Wall Mount Tack Panel	1 9/16	24	40 3/4	23	3	FLB2441WT	COM \$759 A \$804 B \$813 C \$840 D \$878 E \$913 F \$952 G \$998 H \$1,070 I \$1,096 J \$1,159
	Features: <ul style="list-style-type: none"> · pair with primary height units to achieve 69" overall height · supported by wall cleat - hardware provided by installer · com ydg: 1 						
18"w Wall Mount Tack Panel	1 9/16	18	40 3/4	18	2	FLB1841WT	COM \$692 A \$738 B \$747 C \$774 D \$812 E \$847 F \$886 G \$932 H \$1,004 I \$1,028 J \$1,090
	Features: <ul style="list-style-type: none"> · pair with primary height units to achieve 69" overall height · supported by wall cleat - hardware provided by installer · com ydg: 1 						

FLUX

To Order, Specify:

- ① Model Number
- ② Fabric Selection - vendor, pattern and color

Description	D	W	H	CTN WT	CU FT	① Model	Laminate	Essentials Veneer	Artisan Veneer
Wall Mount Panel 	1 1/16	48	23 1/2	33	3	FLT4824WMP	\$1,008		
	1 1/16	48	23 1/2	33	3	FLV4824WMP		\$1,586	\$1,746
	1 1/16	42	23 1/2	30	3	FLT4224WMP	\$990		
	1 1/16	42	23 1/2	30	3	FLV4224WMP		\$1,557	\$1,713
	1 1/16	39	23 1/2	28	3	FLT3924WMP	\$964		
	1 1/16	39	23 1/2	28	3	FLV3924WMP		\$1,520	\$1,671
	1 1/16	36	23 1/2	26	3	FLT3624WMP	\$942		
	1 1/16	36	23 1/2	26	3	FLV3624WMP		\$1,486	\$1,636
	1 1/16	33	23 1/2	24	2	FLT3324WMP	\$920		
	1 1/16	33	23 1/2	24	2	FLV3324WMP		\$1,455	\$1,600
	1 1/16	30	23 1/2	22	2	FLT3024WMP	\$897		
	1 1/16	30	23 1/2	22	2	FLV3024WMP		\$1,421	\$1,561
	1 1/16	24	23 1/2	18	2	FLT2424WMP	\$879		
	1 1/16	24	23 1/2	18	2	FLV2424WMP		\$1,390	\$1,528
	1 1/16	18	23 1/2	14	2	FLT1824WMP	\$863		
	1 1/16	18	23 1/2	14	2	FLV1824WMP		\$1,361	\$1,499

Features:

- pair with primary height units and overhead cabinets or shelves to achieve 69" overall height
- supported by wall cleat - hardware provided by installer
- grain direction runs vertical on essentials veneer, horizontal on laminate
- spacing of attachment cleats allows wire management

Options:

- must specify chassis grain direction on artisan veneer, see pages 13-15 for details

Description	D	W	H	CTN WT	CU FT	① Model	List Price
Wall Mount Markerboard 	1 1/16	48	23 1/2	36	3	FLB4824WMMB	\$1,189
	1 1/16	42	23 1/2	30	3	FLB4224WMMB	\$1,166
	1 1/16	39	23 1/2	28	3	FLB3924WMMB	\$1,140
	1 1/16	36	23 1/2	26	3	FLB3624WMMB	\$1,111
	1 1/16	33	23 1/2	24	2	FLB3324WMMB	\$1,083
	1 1/16	30	23 1/2	21	2	FLB3024WMMB	\$1,058
	1 1/16	24	23 1/2	18	2	FLB2424WMMB	\$1,034
	1 1/16	18	23 1/2	14	2	FLB1824WMMB	\$1,017

Features:

- pair with primary height units and overhead cabinets or shelves to achieve 69" overall height
- supported by wall cleat - hardware provided by installer
- standard markerboard laminate with aluminum pvc edge
- spacing of attachment cleats allows wire management

FLUX

Description	D	W	H	CTN WT	CU FT	① Model	List Price
 Wall Mount Glass Markerboard	1 1/16	48	23 1/2	43	3	FLB4824WMMBG	\$2,430
	1 1/16	42	23 1/2	38	2	FLB4224WMMBG	\$2,253
	1 1/16	39	23 1/2	35	2	FLB3924WMMBG	\$2,161
	1 1/16	36	23 1/2	33	2	FLB3624WMMBG	\$2,076
	1 1/16	33	23 1/2	30	2	FLB3324WMMBG	\$1,988
	1 1/16	30	23 1/2	27	2	FLB3024WMMBG	\$1,897
	1 1/16	24	23 1/2	22	2	FLB2424WMMBG	\$1,717
	1 1/16	18	23 1/2	17	1	FLB1824WMMBG	\$1,541

Features:





- pair with primary height units and overhead cabinets or shelves to achieve 69" overall height
- supported by wall cleat - hardware provided by installer
- white back painted glass with an aluminum profile frame
- spacing of attachment cleats allows wire management

FLUX

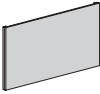

To Order, Specify:

① Laminate Model #	② Laminate Selection	③ Metal Color	④ Other Product Options
Laminate (FLT)	See Laminate Selection	See Metal Finish Color Options	See list of options for each specific unit; Specify and add accordingly.

① Veneer Model #	② Wood Collection	③ Wood Finish	④ Metal Color	⑤ Other Product Options	
Veneer (FLV)	Essentials	See Essentials Wood Finish Options	See Metal Finish Color Options	See list of options for each specific unit; Specify and add accordingly.	
	Artisan	<table border="1"> <thead> <tr> <th>③a Wood Finish</th> <th>③b Chassis Grain Direction</th> </tr> </thead> <tbody> <tr> <td>See Artisan Wood Finish Options</td> <td>For Artisan Only: Vertical Horizontal</td> </tr> </tbody> </table>			③a Wood Finish
③a Wood Finish	③b Chassis Grain Direction				
See Artisan Wood Finish Options	For Artisan Only: Vertical Horizontal				

Description	D	W	H	CTN WT	CU FT	① Model	List Price Per Grade
48" w Wall Mount Tack Panel 	1 9/16	48	23 1/2	20	3	FLB4824WT	COM \$800 A \$868 B \$881 C \$921 D \$979 E \$1,031 F \$1,089 G \$1,159 H \$1,265 I \$1,299 J \$1,391
	Features: <ul style="list-style-type: none"> · pair with primary height units and overhead cabinets or shelves to achieve 69" overall height · supported by wall cleat - hardware provided by installer · com ydg: 1 1/2 						
42" w Wall Mount Tack Panel 	1 9/16	42	23 1/2	18	3	FLB4224WT	COM \$760 A \$828 B \$842 C \$882 D \$939 E \$991 F \$1,049 G \$1,120 H \$1,225 I \$1,259 J \$1,350
	Features: <ul style="list-style-type: none"> · pair with primary height units and overhead cabinets or shelves to achieve 69" overall height · supported by wall cleat - hardware provided by installer · com ydg: 1 1/2 						
39" w Wall Mount Tack Panel 	1 9/16	39	23 1/2	18	3	FLB3924WT	COM \$741 A \$797 B \$809 C \$843 D \$890 E \$934 F \$982 G \$1,041 H \$1,129 I \$1,159 J \$1,235
	Features: <ul style="list-style-type: none"> · pair with primary height units and overhead cabinets or shelves to achieve 69" overall height · supported by wall cleat - hardware provided by installer · com ydg: 1 1/4 						
36" w Wall Mount Tack Panel 	1 9/16	36	23 1/2	17	2	FLB3624WT	COM \$722 A \$779 B \$790 C \$825 D \$872 E \$915 F \$963 G \$1,022 H \$1,110 I \$1,140 J \$1,216
	Features: <ul style="list-style-type: none"> · pair with primary height units and overhead cabinets or shelves to achieve 69" overall height · supported by wall cleat - hardware provided by installer · com ydg: 1 1/4 						

FLUX

Description	D	W	H	CTN WT	CU FT	① Model	List Price Per Grade
 33" w Wall Mount Tack Panel	1 9/16	33	23 1/2	17	2	FLB3324WT	COM \$704 A \$762 B \$773 C \$807 D \$854 E \$897 F \$947 G \$1,004 H \$1,092 I \$1,122 J \$1,197
Features: <ul style="list-style-type: none"> · pair with primary height units and overhead cabinets or shelves to achieve 69" overall height · supported by wall cleat - hardware provided by installer · com ydg: 1 1/4 							
 30" w Wall Mount Tack Panel	1 9/16	30	23 1/2	16	2	FLB3024WT	COM \$683 A \$729 B \$739 C \$765 D \$803 E \$837 F \$877 G \$923 H \$995 I \$1,019 J \$1,081
Features: <ul style="list-style-type: none"> · pair with primary height units and overhead cabinets or shelves to achieve 69" overall height · supported by wall cleat - hardware provided by installer · com ydg: 1 							
 24" w Wall Mount Tack Panel	1 9/16	24	23 1/2	14	2	FLB2424WT	COM \$646 A \$691 B \$701 C \$728 D \$766 E \$801 F \$839 G \$886 H \$957 I \$981 J \$1,043
Features: <ul style="list-style-type: none"> · pair with primary height units and overhead cabinets or shelves to achieve 69" overall height · supported by wall cleat - hardware provided by installer · com ydg: 1 							
 18" w Wall Mount Tack Panel	1 9/16	18	23 1/2	11	2	FLB1824WT	COM \$609 A \$655 B \$664 C \$691 D \$729 E \$764 F \$803 G \$850 H \$920 I \$944 J \$1,005
Features: <ul style="list-style-type: none"> · pair with primary height units and overhead cabinets or shelves to achieve 69" overall height · supported by wall cleat - hardware provided by installer · com ydg: 1 							

To Order, Specify:

- ① Model Number
- ② Fabric Selection - vendor, pattern and color

FLUX

Description	D	W	H	CTN WT	CU FT	① Model	Laminate	Essentials Veneer	Artisan Veneer
Wall Mount Panel 	1 1/16	48	31 1/2	42	4	FLT4832WMP	\$1,078		
	1 1/16	48	31 1/2	42	4	FLV4832WMP		\$1,695	\$1,865
	1 1/16	42	31 1/2	38	4	FLT4232WMP	\$1,057		
	1 1/16	42	31 1/2	38	4	FLV4232WMP		\$1,662	\$1,829
	1 1/16	39	31 1/2	36	3	FLT3932WMP	\$1,031		
	1 1/16	39	31 1/2	36	3	FLV3932WMP		\$1,625	\$1,789
	1 1/16	36	31 1/2	33	3	FLT3632WMP	\$1,007		
	1 1/16	36	31 1/2	33	3	FLV3632WMP		\$1,588	\$1,748
	1 1/16	33	31 1/2	31	3	FLT3332WMP	\$983		
	1 1/16	33	31 1/2	31	3	FLV3332WMP		\$1,552	\$1,708
	1 1/16	30	31 1/2	28	3	FLT3032WMP	\$958		
	1 1/16	30	31 1/2	28	3	FLV3032WMP		\$1,516	\$1,669
	1 1/16	24	31 1/2	23	2	FLT2432WMP	\$939		
	1 1/16	24	31 1/2	23	2	FLV2432WMP		\$1,486	\$1,636
	1 1/16	18	31 1/2	18	2	FLT1832WMP	\$921		
1 1/16	18	31 1/2	18	2	FLV1832WMP		\$1,455	\$1,600	

Features:

- pair with secondary height units and overhead cabinets or shelves to achieve 69" overall height
- supported by wall cleat - hardware provided by installer
- grain direction runs vertical on essentials veneer, horizontal on laminate
- spacing of attachment cleats allows wire management

Options:

- must specify chassis grain direction on artisan veneer, see pages 13-15 for details

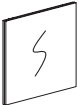
Description	D	W	H	CTN WT	CU FT	① Model	List Price
Wall Mount Markerboard 	1 1/16	48	31 1/2	42	4	FLB4832WMMB	\$1,228
	1 1/16	42	31 1/2	38	4	FLB4232WMMB	\$1,203
	1 1/16	39	31 1/2	36	3	FLB3932WMMB	\$1,174
	1 1/16	36	31 1/2	33	3	FLB3632WMMB	\$1,146
	1 1/16	33	31 1/2	31	3	FLB3332WMMB	\$1,117
	1 1/16	30	31 1/2	28	3	FLB3032WMMB	\$1,092
	1 1/16	24	31 1/2	23	2	FLB2432WMMB	\$1,069
	1 1/16	18	31 1/2	18	2	FLB1832WMMB	\$1,047

Features:

- pair with secondary height units and overhead cabinets or shelves to achieve 69" overall height
- supported by wall cleat - hardware provided by installer
- standard markerboard laminate with aluminum pvc edge
- spacing of attachment cleats allows wire management

Description	D	W	H	CTN WT	CU FT	① Model	List Price
 Wall Mount Glass Markerboard	1 9/16	48	31 1/2	58	3	FLB4832WMMBG	\$3,097
	1 9/16	42	31 1/2	51	3	FLB4232WMMBG	\$2,679
	1 9/16	39	31 1/2	47	3	FLB3932WMMBG	\$2,558
	1 9/16	36	31 1/2	43	3	FLB3632WMMBG	\$2,438
	1 9/16	33	31 1/2	40	3	FLB3332WMMBG	\$2,321
	1 9/16	30	31 1/2	36	2	FLB3032WMMBG	\$2,200
	1 9/16	24	31 1/2	29	2	FLB2432WMMBG	\$1,962
	1 9/16	18	31 1/2	22	2	FLB1832WMMBG	\$1,722

Features:

- pair with secondary height units and overhead cabinets or shelves to achieve 69" overall height
- supported by wall cleat - hardware provided by installer
- white back painted glass with an aluminum profile frame
- spacing of attachment cleats allows wire management

FLUX



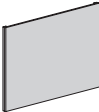
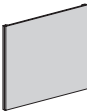
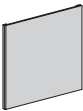
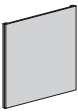

To Order, Specify:

① Laminate Model #	② Laminate Selection	③ Metal Color	④ Other Product Options
Laminate (FLT)	See Laminate Selection	See Metal Finish Color Options	See list of options for each specific unit; Specify and add accordingly.

① Veneer Model #	② Wood Collection	③ Wood Finish	④ Metal Color	⑤ Other Product Options	
Veneer (FLV)	Essentials	See Essentials Wood Finish Options	See Metal Finish Color Options	See list of options for each specific unit; Specify and add accordingly.	
	Artisan	<table border="1"> <thead> <tr> <th>③a Wood Finish</th> <th>③b Chassis Grain Direction</th> </tr> </thead> <tbody> <tr> <td>See Artisan Wood Finish Options</td> <td>For Artisan Only: Vertical Horizontal</td> </tr> </tbody> </table>			③a Wood Finish
③a Wood Finish	③b Chassis Grain Direction				
See Artisan Wood Finish Options	For Artisan Only: Vertical Horizontal				

Description	D	W	H	CTN WT	CU FT	① Model	List Price Per Grade
48" w Wall Mount Tack Panel 	1 5/16	48	31 1/2	27	4	FLB4832WT	COM \$900 A \$969 B \$983 C \$1,023 D \$1,080 E \$1,132 F \$1,191 G \$1,260 H \$1,368 I \$1,402 J \$1,495
	Features: <ul style="list-style-type: none"> · pair with secondary height units and overhead cabinets or shelves to achieve 69" overall height · supported by wall cleat - hardware provided by installer · com ydg: 1 1/2 						
42" w Wall Mount Tack Panel 	1 5/16	42	31 1/2	25	3	FLB4232WT	COM \$852 A \$920 B \$934 C \$975 D \$1,032 E \$1,084 F \$1,142 G \$1,212 H \$1,318 I \$1,353 J \$1,444
	Features: <ul style="list-style-type: none"> · pair with secondary height units and overhead cabinets or shelves to achieve 69" overall height · supported by wall cleat - hardware provided by installer · com ydg: 1 1/2 						
39" w Wall Mount Tack Panel 	1 5/16	39	31 1/2	24	3	FLB3932WT	COM \$826 A \$882 B \$894 C \$928 D \$975 E \$1,019 F \$1,067 G \$1,126 H \$1,215 I \$1,245 J \$1,322
	Features: <ul style="list-style-type: none"> · pair with secondary height units and overhead cabinets or shelves to achieve 69" overall height · supported by wall cleat - hardware provided by installer · com ydg: 1 1/4 						
36" w Wall Mount Tack Panel 	1 5/16	36	31 1/2	23	3	FLB3632WT	COM \$802 A \$858 B \$870 C \$903 D \$951 E \$995 F \$1,043 G \$1,101 H \$1,191 I \$1,221 J \$1,297
	Features: <ul style="list-style-type: none"> · pair with secondary height units and overhead cabinets or shelves to achieve 69" overall height · supported by wall cleat - hardware provided by installer · com ydg: 1 1/4 						

FLUX

Description	D	W	H	CTN WT	CU FT	① Model	List Price Per Grade
 33" w Wall Mount Tack Panel	1 9/16	33	31 1/2	22	3	FLB3332WT	COM \$776 A \$833 B \$845 C \$878 D \$926 E \$969 F \$1,018 G \$1,076 H \$1,165 I \$1,194 J \$1,271
Features: <ul style="list-style-type: none"> · pair with secondary height units and overhead cabinets or shelves to achieve 69" overall height · supported by wall cleat - hardware provided by installer · com ydg: 1 1/4 							
 30" w Wall Mount Tack Panel	1 9/16	30	31 1/2	21	3	FLB3032WT	COM \$749 A \$795 B \$805 C \$831 D \$869 E \$903 F \$943 G \$990 H \$1,062 I \$1,086 J \$1,149
Features: <ul style="list-style-type: none"> · pair with secondary height units and overhead cabinets or shelves to achieve 69" overall height · supported by wall cleat - hardware provided by installer · com ydg: 1 							
 24" w Wall Mount Tack Panel	1 9/16	24	31 1/2	18	2	FLB2432WT	COM \$697 A \$742 B \$751 C \$779 D \$816 E \$851 F \$890 G \$937 H \$1,008 I \$1,033 J \$1,095
Features: <ul style="list-style-type: none"> · pair with secondary height units and overhead cabinets or shelves to achieve 69" overall height · supported by wall cleat - hardware provided by installer · com ydg: 1 							
 18" w Wall Mount Tack Panel	1 9/16	18	31 1/2	14	2	FLB1832WT	COM \$648 A \$693 B \$703 C \$730 D \$768 E \$803 F \$842 G \$888 H \$960 I \$983 J \$1,045
Features: <ul style="list-style-type: none"> · pair with secondary height units and overhead cabinets or shelves to achieve 69" overall height · supported by wall cleat - hardware provided by installer · com ydg: 1 							

To Order, Specify:

- ① Model Number
- ② Fabric Selection - vendor, pattern and color

FLUX

Description	D	W	H	CTN WT	CU FT	① Model	Laminate	Essentials Veneer	Artisan Veneer
Wall Mount Panel 	1 1/16	48	48 13/16	63	6	FLT4849WMP	\$1,327		
	1 1/16	48	48 13/16	63	6	FLV4849WMP		\$2,086	\$2,302
	1 1/16	42	48 13/16	56	5	FLT4249WMP	\$1,299		
	1 1/16	42	48 13/16	56	5	FLV4249WMP		\$2,045	\$2,250
	1 1/16	39	48 13/16	53	5	FLT3949WMP	\$1,270		
	1 1/16	39	48 13/16	53	5	FLV3949WMP		\$2,000	\$2,200
	1 1/16	36	48 13/16	49	4	FLT3649WMP	\$1,238		
	1 1/16	36	48 13/16	49	4	FLV3649WMP		\$1,956	\$2,150
	1 1/16	33	48 13/16	45	4	FLT3349WMP	\$1,208		
	1 1/16	33	48 13/16	45	4	FLV3349WMP		\$1,911	\$2,103
	1 1/16	30	48 13/16	42	4	FLT3049WMP	\$1,180		
	1 1/16	30	48 13/16	42	4	FLV3049WMP		\$1,867	\$2,053
	1 1/16	24	48 13/16	35	3	FLT2449WMP	\$1,155		
	1 1/16	24	48 13/16	35	3	FLV2449WMP		\$1,830	\$2,012
	1 1/16	18	48 13/16	27	3	FLT1849WMP	\$1,136		
	1 1/16	18	48 13/16	27	3	FLV1849WMP		\$1,791	\$1,969

Features:

- pair with secondary height units to achieve 69" overall height
- supported by wall cleat - hardware provided by installer
- grain direction runs vertical on essentials veneer, horizontal on laminate
- spacing of attachment cleats allows wire management

Options:

- must specify chassis grain direction on artisan veneer, see pages 13-15 for details

Description	D	W	H	CTN WT	CU FT	① Model	List Price
Wall Mount Markerboard 	1 1/16	48	48 13/16	63	6	FLB4849WMMB	\$1,563
	1 1/16	42	48 13/16	56	5	FLB4249WMMB	\$1,533
	1 1/16	39	48 13/16	53	5	FLB3949WMMB	\$1,499
	1 1/16	36	48 13/16	49	4	FLB3649WMMB	\$1,461
	1 1/16	33	48 13/16	45	4	FLB3349WMMB	\$1,425
	1 1/16	30	48 13/16	42	4	FLB3049WMMB	\$1,389
	1 1/16	24	48 13/16	35	3	FLB2449WMMB	\$1,362
	1 1/16	18	48 13/16	27	3	FLB1849WMMB	\$1,337

Features:

- pair with secondary height units to achieve 69" overall height
- supported by wall cleat - hardware provided by installer
- standard markerboard laminate with aluminum pvc edge
- spacing of attachment cleats allows wire management

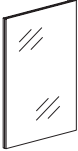
Description	D	W	H	CTN WT	CU FT	① Model	List Price
 Wall Mount Glass Markerboard	1 9/16	48	48 13/16	89	5	FLB4849WMMBG	\$4,239
	1 9/16	42	48 13/16	78	4	FLB4249WMMBG	\$3,834
	1 9/16	39	48 13/16	73	4	FLB3949WMMBG	\$3,631
	1 9/16	36	48 13/16	67	4	FLB3649WMMBG	\$3,432
	1 9/16	33	48 13/16	61	4	FLB3349WMMBG	\$3,231
	1 9/16	30	48 13/16	56	3	FLB3049WMMBG	\$3,027
	1 9/16	24	48 13/16	45	3	FLB2449WMMBG	\$2,620
	1 9/16	18	48 13/16	34	2	FLB1849WMMBG	\$2,114

Features:





- pair with secondary height units to achieve 69" overall height
- supported by wall cleat - hardware provided by installer
- white back painted glass with an aluminum profile frame
- spacing of attachment cleats allows wire management

FLUX



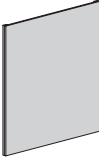

To Order, Specify:

① Laminate Model #	② Laminate Selection	③ Metal Color	④ Other Product Options
Laminate (FLT)	See Laminate Selection	See Metal Finish Color Options	See list of options for each specific unit; Specify and add accordingly.

① Veneer Model #	② Wood Collection	③ Wood Finish	④ Metal Color	⑤ Other Product Options	
Veneer (FLV)	Essentials	See Essentials Wood Finish Options	See Metal Finish Color Options	See list of options for each specific unit; Specify and add accordingly.	
	Artisan	<table border="1"> <thead> <tr> <th>③a Wood Finish</th> <th>③b Chassis Grain Direction</th> </tr> </thead> <tbody> <tr> <td>See Artisan Wood Finish Options</td> <td>For Artisan Only: Vertical Horizontal</td> </tr> </tbody> </table>			③a Wood Finish
③a Wood Finish	③b Chassis Grain Direction				
See Artisan Wood Finish Options	For Artisan Only: Vertical Horizontal				

Description	D	W	H	CTN WT	CU FT	① Model	List Price Per Grade			
 <p>48\"w Wall Mount Tack Panel</p> <p>Features:</p> <ul style="list-style-type: none"> · pair with secondary height units to achieve 69\" overall height · supported by wall cleat - hardware provided by installer · com ydg: 1 ½ 	1 ⅞	48	48 ¾	41	6	FLB4849WT	COM \$1,125 A \$1,193 B \$1,208 C \$1,248 D \$1,305 E \$1,357 F \$1,416 G \$1,485 H \$1,594 I \$1,631 J \$1,725			
	 <p>42\"w Wall Mount Tack Panel</p> <p>Features:</p> <ul style="list-style-type: none"> · pair with secondary height units to achieve 69\" overall height · supported by wall cleat - hardware provided by installer · com ydg: 1 ½ 	1 ⅞	42	48 ¾	38	5	FLB4249WT	COM \$1,046 A \$1,115 B \$1,128 C \$1,169 D \$1,226 E \$1,277 F \$1,336 G \$1,406 H \$1,515 I \$1,550 J \$1,644		
		 <p>39\"w Wall Mount Tack Panel</p> <p>Features:</p> <ul style="list-style-type: none"> · pair with secondary height units to achieve 69\" overall height · supported by wall cleat - hardware provided by installer · com ydg: 1 ¼ 	1 ⅞	39	48 ¾	37	5	FLB3949WT	COM \$1,007 A \$1,064 B \$1,076 C \$1,109 D \$1,158 E \$1,201 F \$1,249 G \$1,308 H \$1,399 I \$1,431 J \$1,508	
			 <p>36\"w Wall Mount Tack Panel</p> <p>Features:</p> <ul style="list-style-type: none"> · pair with secondary height units to achieve 69\" overall height · supported by wall cleat - hardware provided by installer · com ydg: 1 ¼ 	1 ⅞	36	48 ¾	36	4	FLB3649WT	COM \$968 A \$1,024 B \$1,037 C \$1,070 D \$1,118 E \$1,161 F \$1,210 G \$1,268 H \$1,359 I \$1,390 J \$1,468

FLUX

Description	D	W	H	CTN WT	CU FT	① Model	List Price Per Grade
33" w Wall Mount Tack Panel	1 9/16	33	48 3/4	34	4	FLB3349WT	COM \$929 A \$985 B \$997 C \$1,031 D \$1,078 E \$1,121 F \$1,170 G \$1,228 H \$1,318 I \$1,350 J \$1,427
 <p>Features:</p> <ul style="list-style-type: none"> · pair with secondary height units to achieve 69" overall height · supported by wall cleat - hardware provided by installer · com ydg: 1 1/4 							
30" w Wall Mount Tack Panel	1 9/16	30	48 3/4	33	4	FLB3049WT	COM \$888 A \$933 B \$942 C \$970 D \$1,007 E \$1,042 F \$1,081 G \$1,127 H \$1,201 I \$1,227 J \$1,291
 <p>Features:</p> <ul style="list-style-type: none"> · pair with secondary height units to achieve 69" overall height · supported by wall cleat - hardware provided by installer · com ydg: 1 							
24" w Wall Mount Tack Panel	1 9/16	24	48 3/4	28	3	FLB2449WT	COM \$809 A \$854 B \$864 C \$891 D \$929 E \$963 F \$1,002 G \$1,049 H \$1,122 I \$1,147 J \$1,210
 <p>Features:</p> <ul style="list-style-type: none"> · pair with secondary height units to achieve 69" overall height · supported by wall cleat - hardware provided by installer · com ydg: 1 							
18" w Wall Mount Tack Panel	1 9/16	18	48 3/4	22	3	FLB1849WT	COM \$733 A \$779 B \$788 C \$815 D \$853 E \$888 F \$927 G \$973 H \$1,045 I \$1,069 J \$1,132
 <p>Features:</p> <ul style="list-style-type: none"> · pair with secondary height units to achieve 69" overall height · supported by wall cleat - hardware provided by installer · com ydg: 1 							

To Order, Specify:

- ① Model Number
- ② Fabric Selection - vendor, pattern and color

FLUX

Description	D	W	H	CTN WT	CU FT	① Model	Laminate	Essentials Veneer	Artisan Veneer
 Workwall Panel with Mini Shelf	8 1/2	48	23 1/2	50	13	FLT4824WPMS	\$1,165		
	8 1/2	48	23 1/2	50	13	FLV4824WPMS		\$1,823	\$2,006
	8 1/2	42	23 1/2	36	8	FLT4224WPMS	\$1,043		
	8 1/2	42	23 1/2	36	8	FLV4224WPMS		\$1,637	\$1,799
	8 1/2	39	23 1/2	34	7	FLT3924WPMS	\$1,017		
	8 1/2	39	23 1/2	34	7	FLV3924WPMS		\$1,601	\$1,761
	8 1/2	36	23 1/2	31	7	FLT3624WPMS	\$991		
	8 1/2	36	23 1/2	31	7	FLV3624WPMS		\$1,563	\$1,720
	8 1/2	33	23 1/2	28	6	FLT3324WPMS	\$968		
	8 1/2	33	23 1/2	28	6	FLV3324WPMS		\$1,527	\$1,683
	8 1/2	30	23 1/2	26	6	FLT3024WPMS	\$943		
	8 1/2	30	23 1/2	26	6	FLV3024WPMS		\$1,497	\$1,644
	8 1/2	24	23 1/2	29	7	FLT2424WPMS	\$998		
8 1/2	24	23 1/2	29	7	FLV2424WPMS		\$1,586	\$1,747	

Features:

- pair with primary height units and overhead cabinets or shelves to achieve 69" overall height
- supported by wall cleat - hardware provided by installer
- grain direction runs vertical on essentials veneer, horizontal on laminate
- spacing of attachment cleats allows wire management

Options:

- must specify chassis grain direction on artisan veneer, see pages 13-15 for details
- tackboard or markerboard available for above the shelf, see pages 360-361

 Workwall Panel with File Shelf	8 1/2	48	23 1/2	38	13	FLT4824WPFF	\$1,248		
	8 1/2	48	23 1/2	38	13	FLV4824WPFF		\$1,829	\$2,012
	8 1/2	42	23 1/2	36	8	FLT4224WPFF	\$1,283		
	8 1/2	42	23 1/2	36	8	FLV4224WPFF		\$1,877	\$2,064
	8 1/2	39	23 1/2	34	7	FLT3924WPFF	\$1,257		
	8 1/2	39	23 1/2	34	7	FLV3924WPFF		\$1,841	\$2,025
	8 1/2	36	23 1/2	31	7	FLT3624WPFF	\$1,232		
	8 1/2	36	23 1/2	31	7	FLV3624WPFF		\$1,802	\$1,984
	8 1/2	33	23 1/2	28	6	FLT3324WPFF	\$1,208		
	8 1/2	33	23 1/2	28	6	FLV3324WPFF		\$1,770	\$1,948
	8 1/2	30	23 1/2	26	6	FLT3024WPFF	\$1,185		
	8 1/2	30	23 1/2	26	6	FLV3024WPFF		\$1,734	\$1,910

Features:

- pair with primary height units and overhead cabinets or shelves to achieve 69" overall height
- supported by wall cleat - hardware provided by installer
- grain direction runs vertical on essentials veneer, horizontal on laminate
- file brackets for letter hanging file folders
- spacing of attachment cleats allows wire management

Options:

- must specify chassis grain direction on artisan veneer, see pages 13-15 for details
- tackboard or markerboard available for above the shelf, see pages 360-361

 Workwall Panel with File Shelf	8 1/2	24	23 1/2	26	7	FLT2424WPF	\$1,105		
	8 1/2	24	23 1/2	26	7	FLV2424WPF		\$1,621	\$1,781

Features:

- pair with primary height units and overhead cabinets or shelves to achieve 69" overall height
- supported by wall cleat - hardware provided by installer
- grain direction runs vertical on essentials veneer, horizontal on laminate
- file brackets for letter hanging file folders
- spacing of attachment cleats allows wire management

Options:

- must specify chassis grain direction on artisan veneer, see pages 13-15 for details
- tackboard or markerboard available for above the shelf, see pages 360-361

Description	D	W	H	CTN WT	CU FT	① Model	Laminate	Essentials Veneer	Artisan Veneer
 Workwall Panel with Accessory File Shelf	8 1/2	48	23 1/2	45	13	FLT4824WPCDF	\$1,248		
	8 1/2	48	23 1/2	45	13	FLV4824WPCDF		\$1,829	\$2,012
	8 1/2	42	23 1/2	37	8	FLT4224WPCDF	\$1,283		
	8 1/2	42	23 1/2	37	8	FLV4224WPCDF		\$1,877	\$2,064
	8 1/2	39	23 1/2	35	7	FLT3924WPCDF	\$1,257		
	8 1/2	39	23 1/2	35	7	FLV3924WPCDF		\$1,841	\$2,025
	8 1/2	36	23 1/2	33	7	FLT3624WPCDF	\$1,232		
	8 1/2	36	23 1/2	33	7	FLV3624WPCDF		\$1,802	\$1,984
	8 1/2	33	23 1/2	30	6	FLT3324WPCDF	\$1,208		
	8 1/2	33	23 1/2	30	6	FLV3324WPCDF		\$1,770	\$1,948
	8 1/2	30	23 1/2	27	6	FLT3024WPCDF	\$1,185		
	8 1/2	30	23 1/2	27	6	FLV3024WPCDF		\$1,734	\$1,910

Features:

- pair with primary height units and overhead cabinets or shelves to achieve 69" overall height
- supported by wall cleat - hardware provided by installer
- grain direction runs vertical on essentials veneer, horizontal on laminate
- file brackets for letter hanging file folders
- includes plastic tool accessories; pencil cup and paper clip dish
- spacing of attachment cleats allows wire management

Options:

- must specify grain direction on artisan veneer, see pages 13-15 for details
- tackboard or markerboard available for above the shelf, see pages 360-361

Description	D	W	H	CTN WT	CU FT	① Model	Laminate	Essentials Veneer	Artisan Veneer
 Workwall Panel with Accessory File Shelf	8 1/2	48	23 1/2	48	13	FLT4824WPFCD	\$1,248		
	8 1/2	48	23 1/2	48	13	FLV4824WPFCD		\$1,829	\$2,012
	8 1/2	42	23 1/2	38	8	FLT4224WPFCD	\$1,283		
	8 1/2	42	23 1/2	38	8	FLV4224WPFCD		\$1,877	\$2,064
	8 1/2	39	23 1/2	36	7	FLT3924WPFCD	\$1,257		
	8 1/2	39	23 1/2	36	7	FLV3924WPFCD		\$1,841	\$2,025
	8 1/2	36	23 1/2	34	7	FLT3624WPFCD	\$1,232		
	8 1/2	36	23 1/2	34	7	FLV3624WPFCD		\$1,802	\$1,984
	8 1/2	33	23 1/2	30	6	FLT3324WPFCD	\$1,208		
	8 1/2	33	23 1/2	30	6	FLV3324WPFCD		\$1,770	\$1,948
	8 1/2	30	23 1/2	28	6	FLT3024WPFCD	\$1,185		
	8 1/2	30	23 1/2	28	6	FLV3024WPFCD		\$1,734	\$1,910

Features:

- pair with primary height units and overhead cabinets or shelves to achieve 69" overall height
- supported by wall cleat - hardware provided by installer
- grain direction runs vertical on essentials veneer, horizontal on laminate
- file brackets for letter hanging file folders
- includes plastic tool accessories; pencil cup and paper clip dish
- spacing of attachment cleats allows wire management

Options:

- must specify grain direction on artisan veneer, see pages 13-15 for details
- tackboard or markerboard available for above the shelf, see pages 360-361

To Order, Specify:

① Laminate Model #	② Laminate Selection	③ Metal Color	④ Other Product Options
Laminate (FLT)	See Laminate Selection	See Metal Finish Color Options	See list of options for each specific unit; Specify and add accordingly.

① Veneer Model #	② Wood Collection	③ Wood Finish	④ Metal Color	⑤ Other Product Options		
Veneer (FLV)	Essentials	See Essentials Wood Finish Options	See Metal Finish Color Options	See list of options for each specific unit; Specify and add accordingly.		
	Artisan	<table border="1"> <thead> <tr> <th>ⓐ Wood Finish</th> <th>ⓑ Chassis Grain Direction</th> </tr> </thead> <tbody> <tr> <td>See Artisan Wood Finish Options</td> <td>For Artisan Only: Vertical Horizontal</td> </tr> </tbody> </table>	ⓐ Wood Finish		ⓑ Chassis Grain Direction	See Artisan Wood Finish Options
ⓐ Wood Finish	ⓑ Chassis Grain Direction					
See Artisan Wood Finish Options	For Artisan Only: Vertical Horizontal					

Description	D	W	H	CTN WT	CU FT	① Model	Laminate	Essentials Veneer	Artisan Veneer
Workwall Panel with Accessory Shelf 	8 1/2	48	23 1/2	47	13	FLT4824WPCDT	\$1,248		
	8 1/2	48	23 1/2	47	13	FLV4824WPCDT		\$1,829	\$2,012
	8 1/2	42	23 1/2	38	8	FLT4224WPCDT	\$1,283		
	8 1/2	42	23 1/2	38	8	FLV4224WPCDT		\$1,877	\$2,064
	8 1/2	39	23 1/2	36	7	FLT3924WPCDT	\$1,257		
	8 1/2	39	23 1/2	36	7	FLV3924WPCDT		\$1,841	\$2,025
	8 1/2	36	23 1/2	34	7	FLT3624WPCDT	\$1,232		
	8 1/2	36	23 1/2	34	7	FLV3624WPCDT		\$1,802	\$1,984
	8 1/2	33	23 1/2	30	6	FLT3324WPCDT	\$1,208		
	8 1/2	33	23 1/2	30	6	FLV3324WPCDT		\$1,770	\$1,948
	8 1/2	30	23 1/2	28	6	FLT3024WPCDT	\$1,185		
	8 1/2	30	23 1/2	28	6	FLV3024WPCDT		\$1,734	\$1,910
	8 1/2	24	23 1/2	27	7	FLT2424WPCDT	\$1,108		
	8 1/2	24	23 1/2	27	7	FLV2424WPCDT		\$1,621	\$1,781

Features:

- pair with primary height units and overhead cabinets or shelves to achieve 69" overall height
- supported by wall cleat - hardware provided by installer
- grain direction runs vertical on essentials veneer, horizontal on laminate
- file brackets for letter hanging file folders
- includes plastic tool accessories; pencil cup, paper clip dish and utility tray

Options:

- spacing of attachment cleats allows wire management
- must specify grain direction on artisan veneer, see pages 13-15 for details

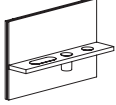
Description	D	W	H	CTN WT	CU FT	① Model	Laminate	Essentials Veneer	Artisan Veneer
Workwall Panel with Accessory Shelf 	8 1/2	48	23 1/2	50	13	FLT4824WPTCD	\$1,248		
	8 1/2	48	23 1/2	50	13	FLV4824WPTCD		\$1,829	\$2,012
	8 1/2	42	23 1/2	38	8	FLT4224WPTCD	\$1,283		
	8 1/2	42	23 1/2	38	8	FLV4224WPTCD		\$1,877	\$2,064
	8 1/2	39	23 1/2	36	7	FLT3924WPTCD	\$1,257		
	8 1/2	39	23 1/2	36	7	FLV3924WPTCD		\$1,841	\$2,025
	8 1/2	36	23 1/2	34	7	FLT3624WPTCD	\$1,232		
	8 1/2	36	23 1/2	34	7	FLV3624WPTCD		\$1,802	\$1,984
	8 1/2	33	23 1/2	30	6	FLT3324WPTCD	\$1,208		
	8 1/2	33	23 1/2	30	6	FLV3324WPTCD		\$1,770	\$1,948
	8 1/2	30	23 1/2	28	6	FLT3024WPTCD	\$1,185		
	8 1/2	30	23 1/2	28	6	FLV3024WPTCD		\$1,734	\$1,910
	8 1/2	24	23 1/2	27	7	FLT2424WPTCD	\$1,108		
	8 1/2	24	23 1/2	27	7	FLV2424WPTCD		\$1,621	\$1,781

Features:

- pair with primary height units and overhead cabinets or shelves to achieve 69" overall height
- supported by wall cleat - hardware provided by installer
- grain direction runs vertical on essentials veneer, horizontal on laminate
- includes black plastic tool accessories; pencil cup, paper clip dish and utility tray
- spacing of attachment cleats allows wire management

Options:

- must specify grain direction on artisan veneer, see pages 13-15 for details
- tackboard or markerboard available for above the shelf, see pages 360-361

To Order, Specify:

① Laminate Model #	② Laminate Selection	③ Metal Color	④ Other Product Options
Laminate (FLT)	See Laminate Selection	See Metal Finish Color Options	See list of options for each specific unit; Specify and add accordingly.

① Veneer Model #	② Wood Collection	③ Wood Finish	④ Metal Color	⑤ Other Product Options		
Veneer (FLV)	Essentials	See Essentials Wood Finish Options	See Metal Finish Color Options	See list of options for each specific unit; Specify and add accordingly.		
	Artisan	<table border="1"> <thead> <tr> <th>③a Wood Finish</th> <th>③b Chassis Grain Direction</th> </tr> </thead> <tbody> <tr> <td>See Artisan Wood Finish Options</td> <td>For Artisan Only: Vertical Horizontal</td> </tr> </tbody> </table>	③a Wood Finish		③b Chassis Grain Direction	See Artisan Wood Finish Options
③a Wood Finish	③b Chassis Grain Direction					
See Artisan Wood Finish Options	For Artisan Only: Vertical Horizontal					

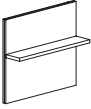
Description	D	W	H	CTN WT	CU FT	① Model	Laminate	Essentials Veneer	Artisan Veneer
 Workwall Panel with Mini Shelf	8 1/2	48	31 1/2	58	17	FLT4832WPMS	\$1,158		
	8 1/2	48	31 1/2	58	17	FLV4832WPMS		\$1,820	\$2,003
	8 1/2	42	31 1/2	44	10	FLT4232WPMS	\$1,186		
	8 1/2	42	31 1/2	44	10	FLV4232WPMS		\$1,866	\$2,051
	8 1/2	39	31 1/2	41	9	FLT3932WPMS	\$1,157		
	8 1/2	39	31 1/2	41	9	FLV3932WPMS		\$1,824	\$2,005
	8 1/2	36	31 1/2	38	9	FLT3632WPMS	\$1,130		
	8 1/2	36	31 1/2	38	9	FLV3632WPMS		\$1,784	\$1,962
	8 1/2	33	31 1/2	35	8	FLT3332WPMS	\$1,102		
	8 1/2	33	31 1/2	35	8	FLV3332WPMS		\$1,742	\$1,917
	8 1/2	30	31 1/2	32	7	FLT3032WPMS	\$1,075		
	8 1/2	30	31 1/2	32	7	FLV3032WPMS		\$1,705	\$1,874
	8 1/2	24	31 1/2	34	9	FLT2432WPMS	\$983		
	8 1/2	24	31 1/2	34	9	FLV2432WPMS		\$1,586	\$1,747

Features:

- pair with secondary height units and overhead cabinets or shelves to achieve 69" overall height
- supported by wall cleat - hardware provided by installer
- grain direction runs vertical on essentials veneer, horizontal on laminate
- spacing of attachment cleats allows wire management

Options:

- must specify grain direction on artisan veneer, see pages 13-15 for details
- tackboard or markerboard available for above the shelf, see pages 360-361

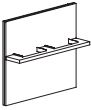
 Workwall Panel with File Shelf	8 1/2	48	31 1/2	51	17	FLT4832WPFF	\$1,389		
	8 1/2	48	31 1/2	51	17	FLV4832WPFF		\$2,047	\$2,252
	8 1/2	42	31 1/2	44	10	FLT4232WPFF	\$1,428		
	8 1/2	42	31 1/2	44	10	FLV4232WPFF		\$2,107	\$2,320
	8 1/2	39	31 1/2	41	9	FLT3932WPFF	\$1,397		
	8 1/2	39	31 1/2	41	9	FLV3932WPFF		\$2,064	\$2,271
	8 1/2	36	31 1/2	38	9	FLT3632WPFF	\$1,370		
	8 1/2	36	31 1/2	38	9	FLV3632WPFF		\$2,022	\$2,224
	8 1/2	33	31 1/2	35	8	FLT3332WPFF	\$1,342		
	8 1/2	33	31 1/2	35	8	FLV3332WPFF		\$1,982	\$2,181
	8 1/2	30	31 1/2	32	7	FLT3032WPFF	\$1,316		
	8 1/2	30	31 1/2	32	7	FLV3032WPFF		\$1,943	\$2,138

Features:

- pair with secondary height units and overhead cabinets or shelves to achieve 69" overall height
- supported by wall cleat - hardware provided by installer
- grain direction runs vertical on essentials veneer, horizontal on laminate
- file brackets for letter hanging file folders

Options:

- must specify grain direction on artisan veneer, see pages 13-15 for details
- tackboard or markerboard available for above the shelf, see pages 360-361

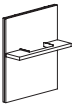
 Workwall Panel with File Shelf	8 1/2	24	31 1/2	31	9	FLT2432WPF	\$1,227		
	8 1/2	24	31 1/2	31	9	FLV2432WPF		\$2,011	\$2,212

Features:

- pair with secondary height units and overhead cabinets or shelves to achieve 69" overall height
- supported by wall cleat - hardware provided by installer
- grain direction runs vertical on essentials veneer, horizontal on laminate
- file brackets for letter hanging file folders

Options:

- must specify grain direction on artisan veneer, see pages 13-15 for details
- tackboard or markerboard available for above the shelf, see pages 360-361

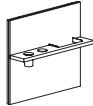
Description	D	W	H	CTN WT	CU FT	① Model	Laminate	Essentials Veneer	Artisan Veneer
 Workwall Panel with Accessory File Shelf	8 1/2	48	31 1/2	55	17	FLT4832WPCDF	\$1,389		
	8 1/2	48	31 1/2	55	17	FLV4832WPCDF		\$2,047	\$2,252
	8 1/2	42	31 1/2	46	10	FLT4232WPCDF	\$1,428		
	8 1/2	42	31 1/2	46	10	FLV4232WPCDF		\$2,107	\$2,320
	8 1/2	39	31 1/2	43	9	FLT3932WPCDF	\$1,397		
	8 1/2	39	31 1/2	43	9	FLV3932WPCDF		\$2,064	\$2,271
	8 1/2	36	31 1/2	40	9	FLT3632WPCDF	\$1,370		
	8 1/2	36	31 1/2	40	9	FLV3632WPCDF		\$2,022	\$2,224
	8 1/2	33	31 1/2	36	8	FLT3332WPCDF	\$1,342		
	8 1/2	33	31 1/2	36	8	FLV3332WPCDF		\$1,982	\$2,181
	8 1/2	30	31 1/2	33	7	FLT3032WPCDF	\$1,316		
	8 1/2	30	31 1/2	33	7	FLV3032WPCDF		\$1,943	\$2,138

Features:

- pair with secondary height units and overhead cabinets or shelves to achieve 69" overall height
- supported by wall cleat - hardware provided by installer
- grain direction runs vertical on essentials veneer, horizontal on laminate
- file brackets for letter hanging file folders
- includes plastic tool accessories; pencil cup and paper clip dish
- spacing of attachment cleats allows wire management

Options:

- must specify grain direction on artisan veneer, see pages 13-15 for details
- tackboard or markerboard available for above the shelf, see pages 360-361

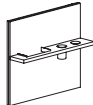
Description	D	W	H	CTN WT	CU FT	① Model	Laminate	Essentials Veneer	Artisan Veneer
 Workwall Panel with Accessory File Shelf	8 1/2	48	31 1/2	58	17	FLT4832WPFCD	\$1,389		
	8 1/2	48	31 1/2	58	17	FLV4832WPFCD		\$2,047	\$2,252
	8 1/2	42	31 1/2	46	10	FLT4232WPFCD	\$1,428		
	8 1/2	42	31 1/2	46	10	FLV4232WPFCD		\$2,107	\$2,320
	8 1/2	39	31 1/2	43	9	FLT3932WPFCD	\$1,397		
	8 1/2	39	31 1/2	43	9	FLV3932WPFCD		\$2,064	\$2,271
	8 1/2	36	31 1/2	40	9	FLT3632WPFCD	\$1,370		
	8 1/2	36	31 1/2	40	9	FLV3632WPFCD		\$2,022	\$2,224
	8 1/2	33	31 1/2	36	8	FLT3332WPFCD	\$1,342		
	8 1/2	33	31 1/2	36	8	FLV3332WPFCD		\$1,982	\$2,181
	8 1/2	33	31 1/2	33	7	FLT3032WPFCD	\$1,316		
	8 1/2	33	31 1/2	33	7	FLV3032WPFCD		\$1,943	\$2,138

Features:

- pair with secondary height units and overhead cabinets or shelves to achieve 69" overall height
- supported by wall cleat - hardware provided by installer
- grain direction runs vertical on essentials veneer, horizontal on laminate
- file brackets for letter hanging file folders
- includes plastic tool accessories; pencil cup and paper clip dish
- spacing of attachment cleats allows wire management

Options:

- must specify chassis grain direction on artisan veneer, see pages 13-15 for details

To Order, Specify:

① Laminate Model #	② Laminate Selection	③ Metal Color	④ Other Product Options
Laminate (FLT)	See Laminate Selection	See Metal Finish Color Options	See list of options for each specific unit; Specify and add accordingly.

① Veneer Model #	② Wood Collection	③ Wood Finish	④ Metal Color	⑤ Other Product Options
Veneer (FLV)	Essentials	See Essentials Wood Finish Options	See Metal Finish Color Options	See list of options for each specific unit; Specify and add accordingly.
		<table border="1"> <thead> <tr> <th>③a Wood Finish</th> <th>③b Chassis Grain Direction</th> </tr> </thead> <tbody> <tr> <td>See Artisan Wood Finish Options</td> <td>For Artisan Only: Vertical Horizontal</td> </tr> </tbody> </table>		
③a Wood Finish	③b Chassis Grain Direction			
See Artisan Wood Finish Options	For Artisan Only: Vertical Horizontal			

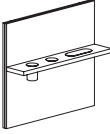
Description	D	W	H	CTN WT	CU FT	① Model	Laminate	Essentials Veneer	Artisan Veneer
Workwall Panel with Accessory Shelf 	8 1/2	48	31 1/2	56	17	FLT4832WPCDT	\$1,389		
	8 1/2	48	31 1/2	56	17	FLV4832WPCDT		\$2,047	\$2,252
	8 1/2	42	31 1/2	47	10	FLT4232WPCDT	\$1,428		
	8 1/2	42	31 1/2	47	10	FLV4232WPCDT		\$2,107	\$2,320
	8 1/2	39	31 1/2	44	9	FLT3932WPCDT	\$1,397		
	8 1/2	39	31 1/2	44	9	FLV3932WPCDT		\$2,064	\$2,271
	8 1/2	36	31 1/2	41	9	FLT3632WPCDT	\$1,370		
	8 1/2	36	31 1/2	41	9	FLV3632WPCDT		\$2,022	\$2,224
	8 1/2	33	31 1/2	37	8	FLT3332WPCDT	\$1,342		
	8 1/2	33	31 1/2	37	8	FLV3332WPCDT		\$1,982	\$2,181
	8 1/2	30	31 1/2	34	7	FLT3032WPCDT	\$1,316		
	8 1/2	30	31 1/2	34	7	FLV3032WPCDT		\$1,943	\$2,138
	8 1/2	24	31 1/2	31	9	FLT2432WPCDT	\$1,227		
	8 1/2	24	31 1/2	31	9	FLV2432WPCDT		\$2,011	\$2,212

Features:

- pair with secondary height units and overhead cabinets or shelves to achieve 69" overall height
- supported by wall cleat - hardware provided by installer
- grain direction runs vertical on essentials veneer, horizontal on laminate
- includes plastic tool accessories; pencil cup, paper clip dish and utility tray
- spacing of attachment cleats allows wire management

Options:

- must specify grain direction on artisan veneer, see pages 13-15 for details
- tackboard or markerboard available for above the shelf, see pages 360-361

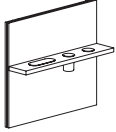
Description	D	W	H	CTN WT	CU FT	① Model	Laminate	Essentials Veneer	Artisan Veneer
Workwall Panel with Accessory Shelf 	8 1/2	48	31 1/2	59	17	FLT4832WPTCD	\$1,389		
	8 1/2	48	31 1/2	59	17	FLV4832WPTCD		\$2,047	\$2,252
	8 1/2	42	31 1/2	47	10	FLT4232WPTCD	\$1,428		
	8 1/2	42	31 1/2	47	10	FLV4232WPTCD		\$2,107	\$2,320
	8 1/2	39	31 1/2	44	9	FLT3932WPTCD	\$1,397		
	8 1/2	39	31 1/2	44	9	FLV3932WPTCD		\$2,064	\$2,271
	8 1/2	36	31 1/2	41	9	FLT3632WPTCD	\$1,370		
	8 1/2	36	31 1/2	41	9	FLV3632WPTCD		\$2,022	\$2,224
	8 1/2	33	31 1/2	37	8	FLT3332WPTCD	\$1,342		
	8 1/2	33	31 1/2	37	8	FLV3332WPTCD		\$1,982	\$2,181
	8 1/2	30	31 1/2	34	7	FLT3032WPTCD	\$1,316		
	8 1/2	30	31 1/2	34	7	FLV3032WPTCD		\$1,943	\$2,138
	8 1/2	24	31 1/2	34	9	FLT2432WPTCD	\$1,227		
	8 1/2	24	31 1/2	34	9	FLV2432WPTCD		\$2,011	\$2,212

Features:

- pair with secondary height units and overhead cabinets or shelves to achieve 69" overall height
- supported by wall cleat - hardware provided by installer
- grain direction runs vertical on essentials veneer, horizontal on laminate
- includes black plastic tool accessories; pencil cup, paper clip dish and utility tray
- spacing of attachment cleats allows wire management

Options:

- must specify grain direction on artisan veneer, see pages 13-15 for details
- tackboard or markerboard available for above the shelf, see pages 360-361

Description	D	W	H	CTN WT	CU FT	① Model	List Price
Work Tool Set	3	2	6	2	1	FLBWTOOLS	\$76

Features:

- work tool accessory set - utility cup, dish, and tray
- black plastic

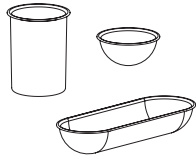

To Order, Specify:

① Laminate Model #	② Laminate Selection	③ Metal Color	④ Other Product Options
Laminate (FLT)	See Laminate Selection	See Metal Finish Color Options	See list of options for each specific unit; Specify and add accordingly.

① Veneer Model #	② Wood Collection	③ Wood Finish	④ Metal Color	⑤ Other Product Options
Veneer (FLV)	Essentials	See Essentials Wood Finish Options	See Metal Finish Color Options	See list of options for each specific unit; Specify and add accordingly.
		<table border="1"> <thead> <tr> <th>③a Wood Finish</th> <th>③b Chassis Grain Direction</th> </tr> </thead> <tbody> <tr> <td>See Artisan Wood Finish Options</td> <td>For Artisan Only: Vertical Horizontal</td> </tr> </tbody> </table>		
③a Wood Finish	③b Chassis Grain Direction			
See Artisan Wood Finish Options	For Artisan Only: Vertical Horizontal			

Description	D	W	H	CTN WT	CU FT	① Model	List Price
Workwall Panels	1 1/16	48	12 11/16	15	2	FLB4813MBA	\$377
Markerboard Add	1 1/16	42	12 11/16	15	2	FLB4213MBA	\$345
	1 1/16	39	12 11/16	14	2	FLB3913MBA	\$313
	1 1/16	36	12 11/16	13	1	FLB3613MBA	\$286
	1 1/16	33	12 11/16	12	1	FLB3313MBA	\$260
	1 1/16	30	12 11/16	11	1	FLB3013MBA	\$237
	1 1/16	24	12 11/16	11	1	FLB2413MBA	\$215

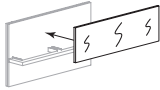

- Features:**
- mounts with magnets above the shelf - template included
 - standard markerboard laminate with aluminum pvc edge

Description	D	W	H	CTN WT	CU FT	① Model	List Price Per Grade
48" w Insert Tackboard	3/4	48	12 1/2	5	2	FLB4813WTK	COM \$408

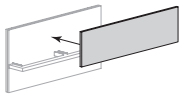

- Features:**
- attaches to cabinet interior, mounting hardware included
 - com ydg: 1 3/4

- A \$488
- B \$503
- C \$551
- D \$617
- E \$678
- F \$746
- G \$828
- H \$947
- I \$982
- J \$1,084

42" w Insert Tackboard	1 1/16	42	12 11/16	4	2	FLB4213WTK	COM \$407
------------------------	--------	----	----------	---	---	------------	-----------

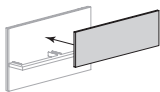

- Features:**
- attaches to cabinet interior, mounting hardware included
 - com ydg: 1 1/2

- A \$464
- B \$475
- C \$509
- D \$556
- E \$600
- F \$648
- G \$707
- H \$792
- I \$819
- J \$893

39" w Insert Tackboard	1 1/16	39	12 11/16	4	2	FLB3913WTK	COM \$395
------------------------	--------	----	----------	---	---	------------	-----------

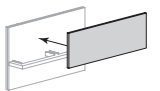

- Features:**
- attaches to cabinet interior, mounting hardware included
 - com ydg: 1 1/4

- A \$453
- B \$465
- C \$498
- D \$545
- E \$588
- F \$638
- G \$696
- H \$782
- I \$808
- J \$881

FLUX

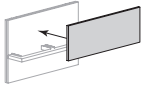
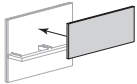
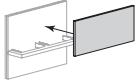
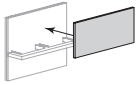
Description	D	W	H	CTN WT	CU FT	① Model	List Price Per Grade
36" w Insert Tackboard 	1 9/16	36	12 11/16	4	2	FLB3613WTK	COM \$386 A \$443 B \$454 C \$488 D \$535 E \$579 F \$627 G \$686 H \$771 I \$797 J \$871
Features: · attaches to cabinet interior, mounting hardware included · com ydg: 1 1/4							
33" w Insert Tackboard 	1 9/16	33	12 11/16	3	2	FLB3313WTK	COM \$375 A \$433 B \$445 C \$478 D \$525 E \$569 F \$618 G \$676 H \$762 I \$788 J \$861
Features: · attaches to cabinet interior, mounting hardware included · com ydg: 1 1/4							
30" w Insert Tackboard 	1 9/16	30	12 11/16	3	2	FLB3013WTK	COM \$368 A \$413 B \$423 C \$450 D \$488 E \$522 F \$561 G \$608 H \$677 I \$699 J \$758
Features: · attaches to cabinet interior, mounting hardware included · com ydg: 1							
24" w Insert Tackboard 	3/4	24	12 1/2	2	2	FLB2413WTK	COM \$343 A \$388 B \$397 C \$425 D \$462 E \$497 F \$536 G \$583 H \$651 I \$672 J \$732
Features: · attaches to cabinet interior, mounting hardware included · com ydg: 1							

To Order, Specify:

- ① Model Number
- ② Fabric Selection - vendor, pattern and color

FLUX

Description	D	W	H	CTN WT	CU FT	① Model	Laminate	Essentials Veneer	Artisan Veneer
52" h Two Door Storage Tower	15 $\frac{1}{8}$ "	35 $\frac{7}{8}$ "	52	183	22	FLT1636-52STD	\$2,138		
	15 $\frac{1}{8}$ "	35 $\frac{7}{8}$ "	52	183	22	FLV1636-52STD		\$3,288	\$3,615
	15 $\frac{1}{8}$ "	29 $\frac{7}{8}$ "	52	169	19	FLT1630-52STD	\$1,770		
	15 $\frac{1}{8}$ "	29 $\frac{7}{8}$ "	52	169	19	FLV1630-52STD		\$2,720	\$2,993

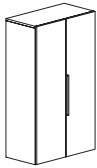

Features:

- use with primary height units, fastening hardware included
- laminate grain direction runs vertical on back panel of storage towers
- four adjustable shelves

Options:

- must specify chassis grain direction on artisan veneer, see pages 13-15 for details
- veneer door fronts in paint available, specify paint color and add \$372 list; see page 16 for details
- on laminate units, contrasting laminate door fronts available, no upcharge; specify laminate color, see page 16 for details
- white glass doors with aluminum trim available, specify and add \$2,810 list for 36" w, \$2,440 list for 30" w; see page 33 for details
- markerboard laminate doors available, specify and add \$489 list; see page 33 for details
- ledge pull standard on the right hinge door, prism pull available, specify and see page 9
- locking doors available, specify and add \$153 list (not available on glass doors)

52" h Sliding Door Storage Tower	15 $\frac{1}{8}$ "	35 $\frac{7}{8}$ "	52	182	22	FLT1636-52STSD	\$2,394		
	15 $\frac{1}{8}$ "	35 $\frac{7}{8}$ "	52	182	22	FLV1636-52STSD		\$3,681	\$4,048
	15 $\frac{1}{8}$ "	29 $\frac{7}{8}$ "	52	167	18	FLT1630-52STSD	\$1,982		
	15 $\frac{1}{8}$ "	29 $\frac{7}{8}$ "	52	167	18	FLV1630-52STSD		\$3,045	\$3,351

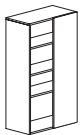
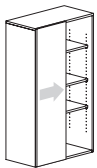

Features:

- use with primary height units, fastening hardware included
- laminate grain direction runs vertical on back panel of storage towers
- four adjustable shelves
- locking not available

Options:

- must specify chassis grain direction on artisan veneer, see pages 13-15 for details
- veneer door fronts in paint available, specify paint color and add \$372 list; see page 16 for details
- on laminate units, contrasting laminate door fronts available, no upcharge; specify laminate color, see page 16 for details
- white glass doors with aluminum trim available, specify and add \$1,454 list for 36" w, \$1,267 list for 30" w; see page 33 for details
- markerboard laminate doors available, specify and add \$317 list; see page 33 for details

52" h Open Storage Tower	15	35 $\frac{7}{8}$ "	52	136	21	FLT1536-52STO	\$1,456		
	15	35 $\frac{7}{8}$ "	52	136	21	FLV1536-52STO		\$2,235	\$2,461
	15	29 $\frac{7}{8}$ "	52	123	18	FLT1530-52STO	\$1,327		
	15	29 $\frac{7}{8}$ "	52	123	18	FLV1530-52STO		\$2,040	\$2,243

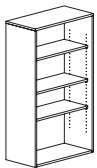

Features:

- use with primary height units, fastening hardware included
- laminate grain direction runs vertical on back panel of storage towers
- four adjustable shelves

Options:

- must specify chassis grain direction on artisan veneer, see pages 13-15 for details

52" h Side Wardrobe with Open Shelf	15 $\frac{1}{8}$ "	35 $\frac{7}{8}$ "	52	138	22	FLT1636-52STSWR	\$1,651		
	15 $\frac{1}{8}$ "	35 $\frac{7}{8}$ "	52	138	22	FLV1636-52STSWR		\$2,541	\$2,792
	15 $\frac{1}{8}$ "	35 $\frac{7}{8}$ "	52	137	22	FLT1636-52STSWL	\$1,651		
	15 $\frac{1}{8}$ "	35 $\frac{7}{8}$ "	52	137	22	FLV1636-52STSWL		\$2,541	\$2,792
	15 $\frac{1}{8}$ "	29 $\frac{7}{8}$ "	52	130	18	FLT1630-52STSWR	\$1,582		
	15 $\frac{1}{8}$ "	29 $\frac{7}{8}$ "	52	130	18	FLV1630-52STSWR		\$2,430	\$2,676
	15 $\frac{1}{8}$ "	29 $\frac{7}{8}$ "	52	129	18	FLT1630-52STSWL	\$1,582		
	15 $\frac{1}{8}$ "	29 $\frac{7}{8}$ "	52	129	18	FLV1630-52STSWL		\$2,430	\$2,676

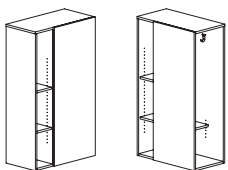

right shown

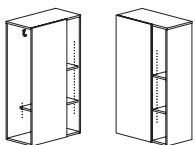

left

Features:

- use with primary height units, fastening hardware included
- side entry wardrobe with two coat hooks
- 8 $\frac{1}{4}$ " w open compartment with three adjustable shelves

Options:

- must specify chassis grain direction on artisan veneer, see pages 13-15 for details

Description	D	W	H	CTN WT	CU FT	① Model	Laminate	Essentials Veneer	Artisan Veneer
52" h Storage Tower	15 $\frac{7}{8}$	17 $\frac{7}{8}$	52	126	12	FLT1618-52STDR	\$1,395		
	15 $\frac{7}{8}$	17 $\frac{7}{8}$	52	126	12	FLV1618-52STDR		\$2,144	\$2,359
	15 $\frac{7}{8}$	17 $\frac{7}{8}$	52	126	12	FLT1618-52STD L	\$1,395		
	15 $\frac{7}{8}$	17 $\frac{7}{8}$	52	126	12	FLV1618-52STD L		\$2,144	\$2,359

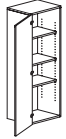

left shown

Features:

- use with primary height units, fastening hardware included
- laminate grain direction runs vertical on back panel of storage towers
- four adjustable shelves

Options:

- must specify chassis grain direction on artisan veneer, see pages 13-15 for details
- veneer door fronts in paint available, specify paint color and add \$372 list; see page 16 for details
- on laminate units, contrasting laminate door fronts available, no upcharge; specify laminate color, see page 16 for details
- white glass doors with aluminum trim available, specify and add \$1,407 list; see page 33 for details
- markerboard laminate doors available, specify and add \$317 list; see page 33 for details
- ledge pulls standard; prism pulls available, specify and see page 9
- locking door available, specify and add \$153 list (not available on glass door)

52" h Open Storage Tower	15	17 $\frac{7}{8}$	52	108	11	FLT1518-52STO	\$1,327		
	15	17 $\frac{7}{8}$	52	108	11	FLV1518-52STO		\$2,040	\$2,243

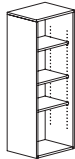

Features:

- use with primary height units, fastening hardware included
- laminate grain direction runs vertical on back panel of storage towers
- three adjustable shelves

Options:

- must specify chassis grain direction on artisan veneer, see pages 13-15 for details

To Order, Specify:

① Laminate Model #	② Laminate Selection	③ Metal Color	④ Other Product Options
Laminate (FLT)	See Laminate Selection	See Metal Finish Color Options	See list of options for each specific unit; Specify and add accordingly.

① Veneer Model #	② Wood Collection	③ Wood Finish	④ Metal Color	⑤ Other Product Options		
Veneer (FLV)	Essentials	See Essentials Wood Finish Options	See Metal Finish Color Options	See list of options for each specific unit; Specify and add accordingly.		
	Artisan	<table border="1"> <thead> <tr> <th>③a Wood Finish</th> <th>③b Chassis Grain Direction</th> </tr> </thead> <tbody> <tr> <td>See Artisan Wood Finish Options</td> <td>For Artisan Only: Vertical Horizontal</td> </tr> </tbody> </table>	③a Wood Finish		③b Chassis Grain Direction	See Artisan Wood Finish Options
③a Wood Finish	③b Chassis Grain Direction					
See Artisan Wood Finish Options	For Artisan Only: Vertical Horizontal					

Description	D	W	H	CTN WT	CU FT	Model	Laminate	Essentials Veneer	Artisan Veneer
40" h Two Door Storage Tower	15 $\frac{1}{8}$ "	35 $\frac{7}{8}$ "	40	130	17	FLT1636-40STD	\$1,727		
	15 $\frac{1}{8}$ "	35 $\frac{7}{8}$ "	40	130	17	FLV1636-40STD		\$2,654	\$2,919
	15 $\frac{1}{8}$ "	29 $\frac{7}{8}$ "	40	115	14	FLT1630-40STD	\$1,430		
	15 $\frac{1}{8}$ "	29 $\frac{7}{8}$ "	40	115	14	FLV1630-40STD		\$2,197	\$2,415

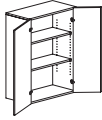
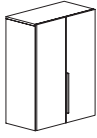

Features:

- use with primary height units, fastening hardware included
- laminate grain direction runs vertical on back panel of storage towers
- two adjustable shelves

Options:

- must specify chassis grain direction on artisan veneer, see pages 13-15 for details
- veneer door fronts in paint available, specify paint color and add \$372 list; see page 16 for details
- on laminate units, contrasting laminate door fronts available, no upcharge; specify laminate color, see page 16 for details
- white glass doors with aluminum trim available, specify and add \$2,243 list for 36" w, \$1,958 list for 30" w; see page 33 for details
- markerboard laminate doors available, specify and add \$489 list; see page 33 for details
- ledge pull standard on the right hinge door, prism pull available, specify and see page 9
- locking doors available, specify and add \$153 list (not available on glass doors)

40" h Sliding Door Storage Tower	15 $\frac{1}{8}$ "	35 $\frac{7}{8}$ "	40	129	17	FLT1636-40STSD	\$1,932		
	15 $\frac{1}{8}$ "	35 $\frac{7}{8}$ "	40	129	17	FLV1636-40STSD		\$2,971	\$3,270
	15 $\frac{1}{8}$ "	29 $\frac{7}{8}$ "	40	115	14	FLT1630-40STSD	\$1,601		
	15 $\frac{1}{8}$ "	29 $\frac{7}{8}$ "	40	115	14	FLV1630-40STSD		\$2,461	\$2,705

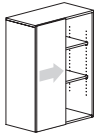

Features:

- use with primary height units, fastening hardware included
- laminate grain direction runs vertical on back panel of storage towers
- two adjustable shelves
- locking not available

Options:

- must specify chassis grain direction on artisan veneer, see pages 13-15 for details
- veneer door fronts in paint available, specify paint color and add \$372 list; see page 16 for details
- on laminate units, contrasting laminate door fronts available, no upcharge; specify laminate color, see page 16 for details
- white glass doors with aluminum trim available, specify and add \$1,193 list for 36" w, \$1,066 list for 30" w; see page 33 for details
- markerboard laminate doors available, specify and add \$317 list; see page 33 for details

40" h Open Storage Tower	15	35 $\frac{7}{8}$ "	40	103	16	FLT1536-40STO	\$1,174		
	15	35 $\frac{7}{8}$ "	40	103	16	FLV1536-40STO		\$1,804	\$1,988
	15	29 $\frac{7}{8}$ "	40	95	14	FLT1530-40STO	\$1,071		
	15	29 $\frac{7}{8}$ "	40	95	14	FLV1530-40STO		\$1,647	\$1,812

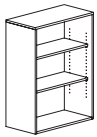

Features:

- use with primary height units, fastening hardware included
- laminate grain direction runs vertical on back panel of storage towers
- two adjustable shelves

Options:

- must specify chassis grain direction on artisan veneer, see pages 13-15 for details

40" h Side Wardrobe with Open Shelf	15 $\frac{1}{8}$ "	35 $\frac{7}{8}$ "	40	115	17	FLT1636-40STSWR	\$1,588		
	15 $\frac{1}{8}$ "	35 $\frac{7}{8}$ "	40	115	17	FLV1636-40STSWR		\$2,440	\$2,684
	15 $\frac{1}{8}$ "	35 $\frac{7}{8}$ "	40	115	17	FLT1636-40STSWL	\$1,588		
	15 $\frac{1}{8}$ "	35 $\frac{7}{8}$ "	40	115	17	FLV1636-40STSWL		\$2,440	\$2,684
	15 $\frac{1}{8}$ "	29 $\frac{7}{8}$ "	40	109	14	FLT1630-40STSWR	\$1,520		
	15 $\frac{1}{8}$ "	29 $\frac{7}{8}$ "	40	109	14	FLV1630-40STSWR		\$2,334	\$2,569
	15 $\frac{1}{8}$ "	29 $\frac{7}{8}$ "	40	109	14	FLT1630-40STSWL	\$1,520		
	15 $\frac{1}{8}$ "	29 $\frac{7}{8}$ "	40	109	14	FLV1630-40STSWL		\$2,334	\$2,569

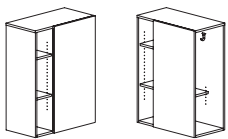

right shown

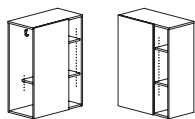

left

Features:

- use with primary height units, fastening hardware included
- side entry wardrobe with two coat hooks
- 8 $\frac{1}{4}$ " w open compartment with two adjustable shelves

Options:

- must specify chassis grain direction on artisan veneer, see pages 13-15 for details

Description	D	W	H	CTN WT	CU FT	① Model	Laminate	Essentials Veneer	Artisan Veneer
40" h Storage Tower	15 $\frac{7}{8}$	17 $\frac{7}{8}$	40	91	10	FLT1618-40STDR	\$1,127		
	15 $\frac{7}{8}$	17 $\frac{7}{8}$	40	91	10	FLV1618-40STDR		\$1,731	\$1,908
	15 $\frac{7}{8}$	17 $\frac{7}{8}$	40	91	10	FLT1618-40STDL	\$1,127		
	15 $\frac{7}{8}$	17 $\frac{7}{8}$	40	91	10	FLV1618-40STDL		\$1,731	\$1,908

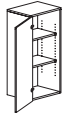
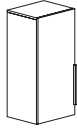

left shown

Features:

- use with primary height units, fastening hardware included
- laminate grain direction runs vertical on back panel of storage towers
- two adjustable shelves

Options:

- must specify chassis grain direction on artisan veneer, see pages 13-15 for details
- veneer door fronts in paint available, specify paint color and add \$372 list; see page 16 for details
- on laminate units, contrasting laminate door fronts available, no upcharge; specify laminate color, see page 16 for details
- white glass doors with aluminum trim available, specify and add \$1,124 list; see page 33 for details
- markerboard laminate doors available, specify and add \$317 list; see page 33 for details
- ledge pulls standard; prism pulls available, specify and see page 9
- locking door available, specify and add \$153 list (not available on glass door)

40" h Open Storage Tower	15	17 $\frac{7}{8}$	40	83	9	FLT1518-40STO	\$1,071		
	15	17 $\frac{7}{8}$	40	83	9	FLV1518-40STO		\$1,647	\$1,812

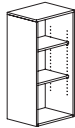

Features:

- use with primary height units, fastening hardware included
- laminate grain direction runs vertical on back panel of storage towers
- two adjustable shelves

Options:

- must specify chassis grain direction on artisan veneer, see pages 13-15 for details

To Order, Specify:

① Laminate Model #	② Laminate Selection	③ Metal Color	④ Other Product Options
Laminate (FLT)	See Laminate Selection	See Metal Finish Color Options	See list of options for each specific unit; Specify and add accordingly.

① Veneer Model #	② Wood Collection	③ Wood Finish	④ Metal Color	⑤ Other Product Options		
Veneer (FLV)	Essentials	See Essentials Wood Finish Options	See Metal Finish Color Options	See list of options for each specific unit; Specify and add accordingly.		
	Artisan	<table border="1"> <thead> <tr> <th>③a Wood Finish</th> <th>③b Chassis Grain Direction</th> </tr> </thead> <tbody> <tr> <td>See Artisan Wood Finish Options</td> <td>For Artisan Only: Vertical Horizontal</td> </tr> </tbody> </table>	③a Wood Finish		③b Chassis Grain Direction	See Artisan Wood Finish Options
③a Wood Finish	③b Chassis Grain Direction					
See Artisan Wood Finish Options	For Artisan Only: Vertical Horizontal					

Description	D	W	H	CTN WT	CU FT	① Model	Laminate	Essentials Veneer	Artisan Veneer
48" h Two Door Storage Tower	15 $\frac{1}{8}$ "	35 $\frac{7}{8}$ "	48	151	20	FLT1636-48STD	\$2,039		
	15 $\frac{1}{8}$ "	35 $\frac{7}{8}$ "	48	151	20	FLV1636-48STD		\$3,129	\$3,446
	15 $\frac{1}{8}$ "	29 $\frac{7}{8}$ "	48	137	17	FLT1630-48STD	\$1,686		
	15 $\frac{1}{8}$ "	29 $\frac{7}{8}$ "	48	137	17	FLV1630-48STD		\$2,592	\$2,848

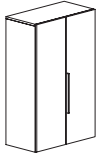

Features:

- use with secondary height units, fastening hardware included
- laminate grain direction runs vertical on back panel of storage towers
- three adjustable shelves

Options:

- must specify chassis grain direction on artisan veneer, see pages 13-15 for details
- veneer door fronts in paint available, specify paint color and add \$372 list; see page 16 for details
- on laminate units, contrasting laminate door fronts available, no upcharge; specify laminate color, see page 16 for details
- white glass doors with aluminum trim available, specify and add \$2,641 list for 36" w, \$2,301 list for 30" w; see page 33 for details
- markerboard laminate doors available, specify and add \$489 list; see page 33 for details
- ledge pull standard on the right hinge door, prism pull available, specify and see page 9
- locking doors available, specify and add \$153 list (not available on glass doors)

48" h Sliding Door Storage Tower	15 $\frac{1}{8}$ "	35 $\frac{7}{8}$ "	48	150	20	FLT1636-48STSD	\$2,281		
	15 $\frac{1}{8}$ "	35 $\frac{7}{8}$ "	48	150	20	FLV1636-48STSD		\$3,506	\$3,858
	15 $\frac{1}{8}$ "	29 $\frac{7}{8}$ "	48	136	17	FLT1630-48STSD	\$1,887		
	15 $\frac{1}{8}$ "	29 $\frac{7}{8}$ "	48	136	17	FLV1630-48STSD		\$2,903	\$3,191

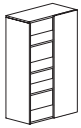
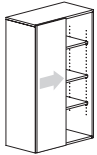

Features:

- use with secondary height units, fastening hardware included
- laminate grain direction runs vertical on back panel of storage towers
- three adjustable shelves
- locking not available

Options:

- must specify chassis grain direction on artisan veneer, see pages 13-15 for details
- veneer door fronts in paint available, specify paint color and add \$372 list; see page 16 for details
- on laminate units, contrasting laminate door fronts available, no upcharge; specify laminate color, see page 16 for details
- white glass doors with aluminum trim available, specify and add \$1,367 list for 36" w, \$1,196 list for 30" w; see page 33 for details
- markerboard laminate doors available, specify and add \$317 list; see page 33 for details

48" h Open Storage Tower	15	35 $\frac{7}{8}$ "	48	114	19	FLT1536-48STO	\$1,385		
	15	35 $\frac{7}{8}$ "	48	114	19	FLV1536-48STO		\$2,130	\$2,344
	15	29 $\frac{7}{8}$ "	48	104	16	FLT1530-48STO	\$1,265		
	15	29 $\frac{7}{8}$ "	48	104	16	FLV1530-48STO		\$1,941	\$2,137

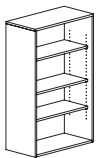

Features:

- use with secondary height units, fastening hardware included
- laminate grain direction runs vertical on back panel of storage towers
- three adjustable shelves

Options:

- must specify chassis grain direction on artisan veneer, see pages 13-15 for details

48" h Side Wardrobe with Open Shelf	15 $\frac{1}{8}$ "	35 $\frac{7}{8}$ "	48	121	20	FLT1636-48STSWR	\$1,622		
	15 $\frac{1}{8}$ "	35 $\frac{7}{8}$ "	48	121	20	FLV1636-48STSWR		\$2,490	\$2,738
	15 $\frac{1}{8}$ "	35 $\frac{7}{8}$ "	48	121	20	FLT1636-48STSWL	\$1,622		
	15 $\frac{1}{8}$ "	35 $\frac{7}{8}$ "	48	121	20	FLV1636-48STSWL		\$2,490	\$2,738
	15 $\frac{1}{8}$ "	29 $\frac{7}{8}$ "	48	114	17	FLT1630-48STSWR	\$1,551		
	15 $\frac{1}{8}$ "	29 $\frac{7}{8}$ "	48	114	17	FLV1630-48STSWR		\$2,382	\$2,620
	15 $\frac{1}{8}$ "	29 $\frac{7}{8}$ "	48	114	17	FLT1630-48STSWL	\$1,551		
	15 $\frac{1}{8}$ "	29 $\frac{7}{8}$ "	48	114	17	FLV1630-48STSWL		\$2,382	\$2,620

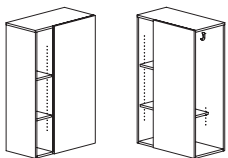

right shown

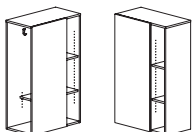

left

Features:

- use with secondary height units, fastening hardware included
- side entry wardrobe with two coat hooks
- 8 $\frac{1}{4}$ " w open compartment with three adjustable shelves

Options:

- must specify chassis grain direction on artisan veneer, see pages 13-15 for details

Description	D	W	H	CTN WT	CU FT	① Model	Laminate	Essentials Veneer	Artisan Veneer
48" h Storage Tower	15 ⁷ / ₈	17 ⁷ / ₈	48	105	11	FLT1618-48STDR	\$1,330		
	15 ⁷ / ₈	17 ⁷ / ₈	48	105	11	FLV1618-48STDR		\$2,043	\$2,249
	15 ⁷ / ₈	17 ⁷ / ₈	48	105	11	FLT1618-48STDL	\$1,330		
	15 ⁷ / ₈	17 ⁷ / ₈	48	105	11	FLV1618-48STDL		\$2,043	\$2,249

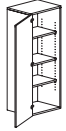
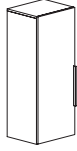

left shown

Features:

- use with secondary height units, fastening hardware included
- laminate grain direction runs vertical on back panel of storage towers
- three adjustable shelves

Options:

- must specify chassis grain direction on artisan veneer, see pages 13-15 for details
- veneer door fronts in paint available, specify paint color and add \$372 list; see page 16 for details
- on laminate units, contrasting laminate door fronts available, no upcharge; specify laminate color, see page 16 for details
- white glass doors with aluminum trim available, specify and add \$1,321 list; see page 33 for details
- markerboard laminate doors available, specify and add \$317 list; see page 33 for details
- ledge pulls standard; prism pulls available, specify and see page 9
- locking door available, specify and add \$153 list (not available on glass door)

48" h Open Storage Tower	15	17 ⁷ / ₈	48	92	10	FLT1518-48STO	\$1,265		
	15	17 ⁷ / ₈	48	92	10	FLV1518-48STO		\$1,941	\$2,137

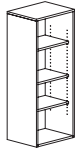

Features:

- use with secondary height units, fastening hardware included
- laminate grain direction runs vertical on back panel of storage towers
- three adjustable shelves

Options:

- must specify chassis grain direction on artisan veneer, see pages 13-15 for details

To Order, Specify:

① Laminate Model #	② Laminate Selection	③ Metal Color	④ Other Product Options
Laminate (FLT)	See Laminate Selection	See Metal Finish Color Options	See list of options for each specific unit; Specify and add accordingly.

① Veneer Model #	② Wood Collection	③ Wood Finish	④ Metal Color	⑤ Other Product Options		
Veneer (FLV)	Essentials	See Essentials Wood Finish Options	See Metal Finish Color Options	See list of options for each specific unit; Specify and add accordingly.		
	Artisan	<table border="1"> <thead> <tr> <th>③a Wood Finish</th> <th>③b Chassis Grain Direction</th> </tr> </thead> <tbody> <tr> <td>See Artisan Wood Finish Options</td> <td>For Artisan Only: Vertical Horizontal</td> </tr> </tbody> </table>	③a Wood Finish		③b Chassis Grain Direction	See Artisan Wood Finish Options
③a Wood Finish	③b Chassis Grain Direction					
See Artisan Wood Finish Options	For Artisan Only: Vertical Horizontal					

Description	D	W	H	CTN WT	CU FT	① Model	Laminate	Essentials Veneer	Artisan Veneer
Monitor Cabinet with Dual Shelf Storage	15 ¹⁵ / ₁₆	95 ⁷ / ₈	40	255	43	FLT1696-40STVS	\$4,002		
	15 ¹⁵ / ₁₆	95 ⁷ / ₈	40	255	43	FLV1696-40STVS		\$6,555	\$7,213
	15 ¹⁵ / ₁₆	89 ⁷ / ₈	40	243	41	FLT1690-40STVS	\$3,885		
	15 ¹⁵ / ₁₆	89 ⁷ / ₈	40	243	41	FLV1690-40STVS		\$6,367	\$7,001
	15 ¹⁵ / ₁₆	83 ⁷ / ₈	40	231	38	FLT1684-40STVS	\$3,771		
	15 ¹⁵ / ₁₆	83 ⁷ / ₈	40	231	38	FLV1684-40STVS		\$6,180	\$6,798

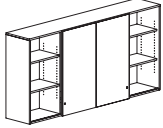
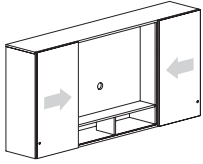

Features:

- use with primary height credenzas
- two adjustable shelves in storage section
- flat screen monitor may be mounted in media section
- divided shelf with oval grommet in back panel
- lock is standard on storage section only
- extreme back panel allows for monitor bracket mounting and wire pass through
- 95⁷/₈"w cabinet = 48" media section; monitor not to exceed 45" w x 29" h
- 89⁷/₈"w cabinet = 45" media section; monitor not to exceed 42" w x 29" h
- 83⁷/₈"w cabinet = 42" media section; monitor not to exceed 39" w x 29" h

Options:

- must specify chassis grain direction on artisan veneer, see pages 13-15 for details
- veneer door fronts in paint available, specify paint color and add \$372 list; see page 16 for details
- on laminate units, contrasting laminate door fronts available, no upcharge; specify laminate color, see page 16 for details
- white glass doors with aluminum trim available, specify and add \$2,949 list for 96" w, \$2,806 list for 90" w, \$2,663 list for 84" w; see page 33 for details
- markerboard laminate doors available, specify and add \$628 list; see page 33 for details

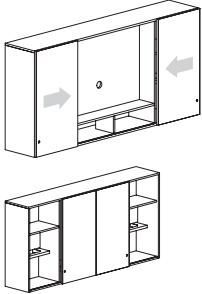
Description	Model	COM	List Price Per Tackboard Fabric Grade										
			A	B	C	D	E	F	G	H	I	J	
Monitor Cabinet with Dual Work-in-Process Storage 	FLT1696-40PTVP Laminate	\$4,811	\$4,960	\$4,990	\$5,079	\$5,203	\$5,318	\$5,446	\$5,599	\$5,858	\$5,958	\$6,183	
	FLV1696-40PTVP Artisan	Essentials	\$7,424	\$7,573	\$7,604	\$7,692	\$7,817	\$7,930	\$8,059	\$8,211	\$8,494	\$8,616	\$8,862
			\$8,033	\$8,182	\$8,213	\$8,301	\$8,426	\$8,539	\$8,668	\$8,820	\$9,103	\$9,225	\$9,471
	D - 15 1/8" W - 95 7/8" H - 40" CTN WT - 265 CU FT - 43												
		COM	A	B	C	D	E	F	G	H	I	J	
	FLT1690-40PTVP Laminate	\$4,682	\$4,832	\$4,863	\$4,951	\$5,075	\$5,190	\$5,318	\$5,471	\$5,729	\$5,828	\$6,052	
	FLV1690-40PTVP Artisan	Essentials	\$7,216	\$7,365	\$7,396	\$7,485	\$7,609	\$7,723	\$7,851	\$8,005	\$8,285	\$8,405	\$8,649
			\$7,809	\$7,958	\$7,989	\$8,078	\$8,202	\$8,316	\$8,445	\$8,598	\$8,878	\$8,998	\$9,243
D - 15 1/8" W - 89 7/8" H - 40" CTN WT - 252 CU FT - 41													
		COM	A	B	C	D	E	F	G	H	I	J	
	FLT1684-40PTVP Laminate	\$4,555	\$4,706	\$4,736	\$4,824	\$4,949	\$5,063	\$5,192	\$5,344	\$5,601	\$5,699	\$5,921	
	FLV1684-40PTVP Artisan	Essentials	\$7,019	\$7,169	\$7,199	\$7,287	\$7,412	\$7,526	\$7,655	\$7,807	\$8,087	\$8,205	\$8,448
			\$7,596	\$7,746	\$7,777	\$7,865	\$7,990	\$8,103	\$8,232	\$8,385	\$8,664	\$8,783	\$9,025
D - 15 1/8" W - 83 7/8" H - 40" CTN WT - 239 CU FT - 38													

Features:

- use with primary height credenzas
- sliding doors
- locking is standard on sliding doors in closed storage position
- work sections contain lower letter size file opening shelf, tackboard, and fixed upper shelf
- flat screen monitor may be mounted in center section
- divided shelf with oval grommet in back panel
- extreme back panel allows for monitor bracket mounting and wire pass through
- 95 7/8" w cabinet = 48" w media section; monitor not to exceed 45" w x 29" h
- 89 7/8" w cabinet = 45" w media section; monitor not to exceed 42" w x 29" h
- 83 7/8" w cabinet = 42" w media section; monitor not to exceed 39" w x 29" h

Options:

- must specify chassis grain direction on artisan veneer, see pages 13-15 for details
- veneer door fronts in paint available, specify paint color and add \$372 list; see page 16 for details
- on laminate units, contrasting door fronts available, no upcharge; specify color, see page 16 for details
- white glass doors with aluminum trim available, specify and add \$2,949 list for 96" w, \$2,806 list for 90" w, \$2,663 list for 84" w; see page 33 for details
- markerboard laminate doors available, specify and add \$628 list; see page 33 for details
- tackboard included in work-in-process section
- com ydg: 95 7/8" w cabinet = 3; 89 7/8" w cabinet = 3; 83 7/8" w cabinet = 3

To Order, Specify:

1 Model Number	2 Fabric Selection
	Vendor Pattern Color Visit www.jsifurniture.com/finishes-and-materials/textiles for our textiles program. See selection of standard and graded in manufacturers and patterns.

To Order, Specify:

1 Laminate Model #	2 Laminate Selection	3 Metal Color	4 Other Product Options
Laminate (FLT)	See Laminate Selection	See Metal Finish Color Options	See list of options for each specific unit; Specify and add accordingly.

1 Veneer Model #	2 Wood Collection	3 Wood Finish	4 Metal Color	5 Other Product Options
Veneer (FLV)	Essentials	See Essentials Wood Finish Options	See Metal Finish Color Options	See list of options for each specific unit; Specify and add accordingly.
	Artisan	See Artisan Wood Finish Options	4b Chassis Grain Direction For Artisan Only: Vertical Horizontal	

Description	Model	List Price Per Tackboard Fabric Grade												
		COM	A	B	C	D	E	F	G	H	I	J		
Center Monitor Cabinet with Side Storage and Side Work-in-Process Storage	FLT1696-40STVP	Laminate	\$4,449	\$4,598	\$4,630	\$4,718	\$4,842	\$4,956	\$5,085	\$5,238	\$5,494	\$5,591	\$5,812	
	FLV1696-40STVP	Essentials	\$7,063	\$7,212	\$7,242	\$7,332	\$7,455	\$7,570	\$7,698	\$7,851	\$8,130	\$8,249	\$8,492	
		Artisan	\$7,675	\$7,824	\$7,854	\$7,944	\$8,068	\$8,182	\$8,310	\$8,463	\$8,742	\$8,861	\$9,104	
	FLT1696-40PTVS	Laminate	\$4,449	\$4,598	\$4,630	\$4,718	\$4,842	\$4,956	\$5,085	\$5,238	\$5,494	\$5,591	\$5,812	
	FLV1696-40PTVS	Essentials	\$7,063	\$7,212	\$7,242	\$7,332	\$7,455	\$7,570	\$7,698	\$7,851	\$8,130	\$8,249	\$8,492	
		Artisan	\$7,675	\$7,824	\$7,854	\$7,944	\$8,068	\$8,182	\$8,310	\$8,463	\$8,742	\$8,861	\$9,104	
	D - 15 1/16 W - 95 7/8 H - 40 CTN WT - 260 CU FT - 43													
				COM	A	B	C	D	E	F	G	H	I	J
	*STVP shown	FLT1690-40STVP	Laminate	\$4,328	\$4,477	\$4,507	\$4,596	\$4,720	\$4,835	\$4,963	\$5,116	\$5,370	\$5,467	\$5,687
		FLV1690-40STVP	Essentials	\$6,861	\$7,010	\$7,041	\$7,129	\$7,254	\$7,368	\$7,496	\$7,650	\$7,927	\$8,043	\$8,285
Artisan			\$7,454	\$7,604	\$7,634	\$7,722	\$7,847	\$7,962	\$8,090	\$8,243	\$8,520	\$8,637	\$8,878	
FLT1690-40PTVS		Laminate	\$4,328	\$4,477	\$4,507	\$4,596	\$4,720	\$4,835	\$4,963	\$5,116	\$5,370	\$5,467	\$5,687	
FLV1690-40PTVS		Essentials	\$6,861	\$7,010	\$7,041	\$7,129	\$7,254	\$7,368	\$7,496	\$7,650	\$7,927	\$8,043	\$8,285	
		Artisan	\$7,454	\$7,604	\$7,634	\$7,722	\$7,847	\$7,962	\$8,090	\$8,243	\$8,520	\$8,637	\$8,878	
D - 15 1/16 W - 89 7/8 H - 40 CTN WT - 247 CU FT - 41														

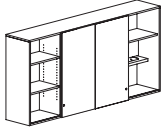
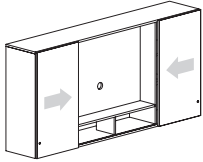

*STVP shown

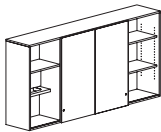

*PTVS

Features:

- use with primary height credenzas
- sliding doors
- locking is standard on sliding doors in closed storage position
- one side, shelf section - two adjustable shelves
- flat screen monitor may be mounted in center section
- divided shelf with oval grommet in back panel
- extreme back panel allows for monitor bracket mounting and wire pass through
- 95 7/8" w cabinet = 48" w media section; monitor not to exceed 45" w x 29" h
- 89 7/8" w cabinet = 45" w media section; monitor not to exceed 42" w x 29" h

Options:

- must specify chassis grain direction on artisan veneer, see pages 13-15 for details
- veneer door fronts in paint available, specify paint color and add \$372 list; see page 16 for details
- on laminate units, contrasting door fronts available, no upcharge; specify color, see page 16 for details
- white glass doors with aluminum trim available, specify and add \$2,949 list for 96" w, \$2,806 list for 90" w; see page 33 for details
- markerboard laminate doors available, specify and add \$628 list; see page 33 for details
- tackboard included in work-in-process section
- com ydg: 95 7/8" w cabinet = 3; 89 7/8" w cabinet = 3

Description	① Model		List Price Per Tackboard Fabric Grade										
			COM	A	B	C	D	E	F	G	H	I	J
Center Monitor Cabinet with Side Storage and Side Work-in-Process Storage	FLT1684-40STVP	Laminate	\$4,205	\$4,254	\$4,265	\$4,294	\$4,335	\$4,374	\$4,416	\$4,467	\$4,576	\$4,632	\$4,728
		Essentials	\$6,668	\$6,717	\$6,728	\$6,757	\$6,798	\$6,837	\$6,879	\$6,930	\$7,062	\$7,137	\$7,254
	FLV1684-40STVP	Artisan	\$7,244	\$7,294	\$7,304	\$7,334	\$7,375	\$7,413	\$7,455	\$7,507	\$7,638	\$7,714	\$7,830
		Laminate	\$4,205	\$4,254	\$4,265	\$4,294	\$4,335	\$4,374	\$4,416	\$4,467	\$4,576	\$4,632	\$4,728
	FLT1684-40PTVS	Essentials	\$6,668	\$6,717	\$6,728	\$6,757	\$6,798	\$6,837	\$6,879	\$6,930	\$7,062	\$7,137	\$7,254
		Artisan	\$7,244	\$7,294	\$7,304	\$7,334	\$7,375	\$7,413	\$7,455	\$7,507	\$7,638	\$7,714	\$7,830
	D - 15 15/16 W - 83 7/8 H - 40 CTN WT - 234 CU FT - 38												

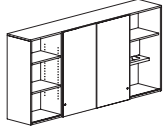
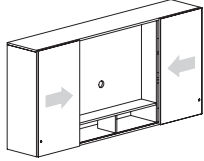

*STVP shown

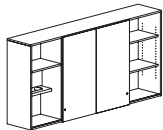

*PTVS

Features:

- use with primary height credenzas
- sliding doors
- locking is standard on sliding doors in closed storage position
- one side, shelf section - two adjustable shelves
- flat screen monitor may be mounted in center section
- divided shelf with oval grommet in back panel
- extreme back panel allows for monitor bracket mounting and wire pass through
- 42" w media section; monitor not to exceed 39" w x 29" h

Options:

- must specify chassis grain direction on artisan veneer, see pages 13-15 for details
- veneer door fronts in paint available, specify paint color and add \$372 list; see page 16 for details
- on laminate units, contrasting door fronts available, no upcharge; specify color, see page 16 for details
- white glass doors with aluminum trim available, specify and add \$2,663 list; see page 33 for details
- markerboard laminate doors available, specify and add \$628 list; see page 33 for details
- tackboard included in work-in-process section
- com ydg: 1

To Order, Specify:

① Model Number	② Fabric Selection	
	Vendor Pattern Color	Visit www.jsifurniture.com/finishes-and-materials/textiles for our textiles program. See selection of standard and graded in manufacturers and patterns.

To Order, Specify:

① Laminate Model #	② Laminate Selection	③ Metal Color	④ Other Product Options
Laminate (FLT)	See Laminate Selection	See Metal Finish Color Options	See list of options for each specific unit; Specify and add accordingly.

① Veneer Model #	② Wood Collection	③ Wood Finish	④ Metal Color	⑤ Other Product Options
Veneer (FLV)	Essentials	See Essentials Wood Finish Options	See Metal Finish Color Options	See list of options for each specific unit; Specify and add accordingly.
		<table border="1"> <thead> <tr> <th>ⓐ Wood Finish</th> <th>ⓑ Chassis Grain Direction</th> </tr> </thead> <tbody> <tr> <td>See Artisan Wood Finish Options</td> <td>For Artisan Only: Vertical Horizontal</td> </tr> </tbody> </table>		
ⓐ Wood Finish	ⓑ Chassis Grain Direction			
See Artisan Wood Finish Options	For Artisan Only: Vertical Horizontal			

Description	Model	List Price Per Tackboard Fabric Grade											
		COM	A	B	C	D	E	F	G	H	I	J	
Monitor Cabinet with Work-in-Process Storage *PTV shown *TVP	FLT1696-40PTV	Laminate	\$4,472	\$4,547	\$4,563	\$4,607	\$4,669	\$4,725	\$4,791	\$4,866	\$5,014	\$5,081	\$5,211
	FLV1696-40PTV	Essentials	\$7,046	\$7,121	\$7,135	\$7,180	\$7,242	\$7,299	\$7,363	\$7,440	\$7,611	\$7,699	\$7,849
		Artisan	\$7,648	\$7,722	\$7,737	\$7,782	\$7,844	\$7,901	\$7,965	\$8,041	\$8,213	\$8,301	\$8,451
	FLT1696-40TVP	Laminate	\$4,472	\$4,547	\$4,563	\$4,607	\$4,669	\$4,725	\$4,791	\$4,866	\$5,014	\$5,081	\$5,211
		Essentials	\$7,046	\$7,121	\$7,135	\$7,180	\$7,242	\$7,299	\$7,363	\$7,440	\$7,611	\$7,699	\$7,849
	Artisan	\$7,648	\$7,722	\$7,737	\$7,782	\$7,844	\$7,901	\$7,965	\$8,041	\$8,213	\$8,301	\$8,451	
D - 15 1/16 W - 95 7/8 H - 40 CTN WT - 257 CU FT - 43													
			COM	A	B	C	D	E	F	G	H	I	J
FLT1690-40PTV	Laminate	\$4,344	\$4,419	\$4,435	\$4,479	\$4,541	\$4,598	\$4,662	\$4,738	\$4,885	\$4,951	\$5,079	
	Essentials	\$6,844	\$6,919	\$6,934	\$6,978	\$7,041	\$7,097	\$7,161	\$7,238	\$7,407	\$7,494	\$7,642	
FLV1690-40PTV	Artisan	\$7,427	\$7,502	\$7,516	\$7,560	\$7,623	\$7,680	\$7,744	\$7,821	\$7,990	\$8,077	\$8,225	
	Laminate	\$4,344	\$4,419	\$4,435	\$4,479	\$4,541	\$4,598	\$4,662	\$4,738	\$4,885	\$4,951	\$5,079	
FLT1690-40TVP	Essentials	\$6,844	\$6,919	\$6,934	\$6,978	\$7,041	\$7,097	\$7,161	\$7,238	\$7,407	\$7,494	\$7,642	
	Artisan	\$7,438	\$7,512	\$7,527	\$7,571	\$7,634	\$7,691	\$7,755	\$7,831	\$8,000	\$8,088	\$8,236	
D - 15 1/16 W - 89 7/8 H - 40 CTN WT - 243 CU FT - 41													
			COM	A	B	C	D	E	F	G	H	I	J
FLT1684-40PTV	Laminate	\$4,223	\$4,297	\$4,313	\$4,357	\$4,419	\$4,476	\$4,541	\$4,616	\$4,762	\$4,827	\$4,954	
	Essentials	\$6,646	\$6,720	\$6,736	\$6,780	\$6,842	\$6,899	\$6,964	\$7,040	\$7,208	\$7,293	\$7,440	
FLV1684-40PTV	Artisan	\$7,213	\$7,287	\$7,303	\$7,347	\$7,409	\$7,466	\$7,531	\$7,607	\$7,775	\$7,860	\$8,007	
	Laminate	\$4,223	\$4,297	\$4,313	\$4,357	\$4,419	\$4,476	\$4,541	\$4,616	\$4,762	\$4,827	\$4,954	
FLT1684-40TVP	Essentials	\$6,646	\$6,720	\$6,736	\$6,780	\$6,842	\$6,899	\$6,964	\$7,040	\$7,208	\$7,293	\$7,440	
	Artisan	\$7,213	\$7,287	\$7,303	\$7,347	\$7,409	\$7,466	\$7,531	\$7,607	\$7,775	\$7,860	\$8,007	
D - 15 1/16 W - 83 7/8 H - 40 CTN WT - 231 CU FT - 38													
			COM	A	B	C	D	E	F	G	H	I	J
FLT1678-40PTV	Laminate	\$4,100	\$4,162	\$4,174	\$4,211	\$4,263	\$4,311	\$4,364	\$4,427	\$4,554	\$4,613	\$4,724	
	Essentials	\$6,454	\$6,516	\$6,529	\$6,566	\$6,618	\$6,665	\$6,718	\$6,782	\$6,929	\$7,008	\$7,138	
FLV1678-40PTV	Artisan	\$7,007	\$7,069	\$7,083	\$7,119	\$7,171	\$7,218	\$7,272	\$7,336	\$7,483	\$7,562	\$7,692	
	Laminate	\$4,100	\$4,162	\$4,174	\$4,211	\$4,263	\$4,311	\$4,364	\$4,427	\$4,554	\$4,613	\$4,724	
FLT1678-40TVP	Essentials	\$6,454	\$6,516	\$6,529	\$6,566	\$6,618	\$6,665	\$6,718	\$6,782	\$6,929	\$7,008	\$7,138	
	Artisan	\$7,007	\$7,069	\$7,083	\$7,119	\$7,171	\$7,218	\$7,272	\$7,336	\$7,483	\$7,562	\$7,692	
D - 15 1/16 W - 77 7/8 H - 40 CTN WT - 218 CU FT - 35													

Features:

- use with primary height credenzas
- sliding door
- locking is standard on sliding doors in closed storage position
- work section - dual hanging letter size file pocket shelf with tackable surface above; upper fixed shelf
- flat screen monitor may be mounted in media section
- divided shelf with oval grommet in back panel
- extreme back panel allows for monitor bracket mounting and wire pass through
- 95 7/8" w cabinet = 48" w media section; monitor not to exceed 45" w x 29" h
- 89 7/8" w cabinet = 45" w media section; monitor not to exceed 42" w x 29" h
- 83 7/8" w cabinet = 42" w media section; monitor not to exceed 39" w x 29" h
- 77 7/8" w cabinet = 39" w media section; monitor not to exceed 36" w x 29" h

Options:

- must specify chassis grain direction on artisan veneer, see pages 13-15 for details
- veneer door fronts in paint available, specify paint color and add \$372 list; see page 16 for details
- on laminate units, contrasting door fronts available, no upcharge; specify color, see page 16 for details
- white glass doors with aluminum trim available, specify and add \$2,734 list for 96" w, \$2,354 list for 90" w, \$2,218 list for 84" w, \$2,083 list for 78" w; see page 33 for details
- markerboard laminate doors available, specify and add \$546 list; see page 33 for details
- tackboard included in work-in-process section
- com ydg: 95 7/8" w cabinet = 1 1/2; 89 7/8" w cabinet = 1 1/2; 83 7/8" w cabinet = 1 1/2; 77 7/8" w cabinet = 1 1/4

To Order, Specify:

1 Model Number	2 Fabric Selection
Vendor Pattern Color	Visit www.jsifurniture.com/finishes-and-materials/textiles for our textiles program. See selection of standard and graded in manufacturers and patterns.

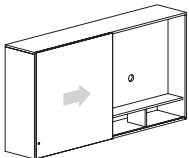
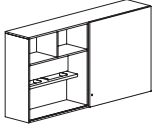
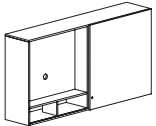
Description	Model	COM	List Price Per Tackboard Fabric Grade									
			A	B	C	D	E	F	G	H	I	J
Monitor Cabinet with Work-in-Process Storage   *PTV shown  *TVP	FLT1672-40PTV Laminates FLV1672-40PTV Essentials Artisan FLT1672-40TVP Laminates FLV1672-40TVP Essentials Artisan D - 15 15/16 W - 71 7/8 H - 40 CTN WT - 205 CU FT - 33	\$4,052	\$4,114	\$4,127	\$4,164	\$4,216	\$4,263	\$4,317	\$4,381	\$4,507	\$4,566	\$4,676
	\$6,386	\$6,447	\$6,460	\$6,497	\$6,549	\$6,597	\$6,650	\$6,713	\$6,860	\$6,939	\$7,068	
	\$6,930	\$6,992	\$7,005	\$7,042	\$7,094	\$7,142	\$7,195	\$7,258	\$7,405	\$7,484	\$7,613	
	\$4,052	\$4,114	\$4,127	\$4,164	\$4,216	\$4,263	\$4,317	\$4,381	\$4,507	\$4,566	\$4,676	
	\$6,386	\$6,447	\$6,460	\$6,497	\$6,549	\$6,597	\$6,650	\$6,713	\$6,860	\$6,939	\$7,068	
	\$6,930	\$6,992	\$7,005	\$7,042	\$7,094	\$7,142	\$7,195	\$7,258	\$7,405	\$7,484	\$7,613	
	COM	A	B	C	D	E	F	G	H	I	J	
	\$4,005	\$4,067	\$4,080	\$4,116	\$4,169	\$4,216	\$4,270	\$4,334	\$4,460	\$4,518	\$4,628	
	\$6,314	\$6,376	\$6,389	\$6,425	\$6,478	\$6,525	\$6,579	\$6,643	\$6,789	\$6,866	\$6,995	
	\$6,853	\$6,915	\$6,927	\$6,964	\$7,017	\$7,064	\$7,117	\$7,181	\$7,327	\$7,405	\$7,533	
	\$4,005	\$4,067	\$4,080	\$4,116	\$4,169	\$4,216	\$4,270	\$4,334	\$4,460	\$4,518	\$4,628	
	\$6,314	\$6,376	\$6,389	\$6,425	\$6,478	\$6,525	\$6,579	\$6,643	\$6,789	\$6,866	\$6,995	
\$6,853	\$6,915	\$6,927	\$6,964	\$7,017	\$7,064	\$7,117	\$7,181	\$7,327	\$7,405	\$7,533		
D - 15 15/16 W - 65 7/8 H - 40 CTN WT - 191 CU FT - 30	COM	A	B	C	D	E	F	G	H	I	J	
\$3,959	\$4,009	\$4,019	\$4,048	\$4,090	\$4,128	\$4,171	\$4,221	\$4,330	\$4,382	\$4,477		
\$6,245	\$6,295	\$6,305	\$6,334	\$6,376	\$6,414	\$6,457	\$6,507	\$6,635	\$6,707	\$6,820		
\$7,830	\$7,881	\$7,890	\$7,920	\$7,962	\$7,999	\$8,042	\$8,093	\$8,221	\$8,292	\$8,406		
\$3,959	\$4,009	\$4,019	\$4,048	\$4,090	\$4,128	\$4,171	\$4,221	\$4,330	\$4,382	\$4,477		
\$6,245	\$6,295	\$6,305	\$6,334	\$6,376	\$6,414	\$6,457	\$6,507	\$6,635	\$6,707	\$6,820		
\$6,780	\$6,831	\$6,840	\$6,870	\$6,912	\$6,949	\$6,992	\$7,043	\$7,171	\$7,242	\$7,356		
D - 15 15/16 W - 59 7/8 H - 40 CTN WT - 180 CU FT - 27	COM	A	B	C	D	E	F	G	H	I	J	
\$3,959	\$4,009	\$4,019	\$4,048	\$4,090	\$4,128	\$4,171	\$4,221	\$4,330	\$4,382	\$4,477		
\$6,245	\$6,295	\$6,305	\$6,334	\$6,376	\$6,414	\$6,457	\$6,507	\$6,635	\$6,707	\$6,820		
\$7,830	\$7,881	\$7,890	\$7,920	\$7,962	\$7,999	\$8,042	\$8,093	\$8,221	\$8,292	\$8,406		
\$3,959	\$4,009	\$4,019	\$4,048	\$4,090	\$4,128	\$4,171	\$4,221	\$4,330	\$4,382	\$4,477		
\$6,245	\$6,295	\$6,305	\$6,334	\$6,376	\$6,414	\$6,457	\$6,507	\$6,635	\$6,707	\$6,820		
\$6,780	\$6,831	\$6,840	\$6,870	\$6,912	\$6,949	\$6,992	\$7,043	\$7,171	\$7,242	\$7,356		

Features:

- use with primary height credenzas
- sliding door
- locking is standard on sliding doors in closed storage position
- work section - lower file shelf with full height tackboard; fixed upper shelf
- flat screen monitor may be mounted in media section
- divided shelf with oval grommet in back panel
- extreme back panel allows for monitor bracket mounting and wire pass through
- 71 7/8" w cabinet = 36" w media section; monitor not to exceed 33" w x 29" h
- 65 7/8" w cabinet = 33" w media section; monitor not to exceed 30" w x 29" h
- 59 7/8" w cabinet = 30" w media section; monitor not to exceed 27" w x 29" h

Options:

- must specify chassis grain direction on artisan veneer, see pages 13-15 for details
- veneer door fronts in paint available, specify paint color and add \$372 list; see page 16 for details
- on laminate units, contrasting door fronts available, no upcharge; specify color, see page 16 for details
- white glass doors with aluminum trim available, specify and add \$2,045 list for 72" w, \$1,903 list for 66" w, \$1,761 list for 60" w; see page 33 for details
- markerboard laminate doors available, specify and add \$546 list; see page 33 for details
- tackboard included in work-in-process section
- com ydg: 71 7/8" w cabinet = 1 1/4; 65 7/8" w cabinet = 1 1/4; 59 7/8" w cabinet = 1

To Order, Specify:

1 Laminate Model # Laminate (FLT)		2 Laminate Selection See Laminate Selection		3 Metal Color See Metal Finish Color Options	4 Other Product Options See list of options for each specific unit; Specify and add accordingly.
1 Veneer Model # Veneer (FLV)	2 Wood Collection Essentials	3 Wood Finish See Essentials Wood Finish Options		4 Metal Color See Metal Finish Color Options	5 Other Product Options See list of options for each specific unit; Specify and add accordingly.
	Artisan	3a Wood Finish See Artisan Wood Finish Options	3b Chassis Grain Direction For Artisan Only: Vertical Horizontal		

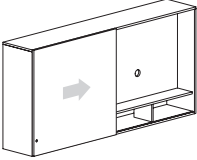
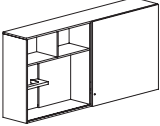
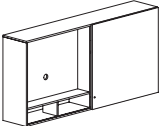
Description	Model	List Price Per Tackboard Fabric Grade											
		COM	A	B	C	D	E	F	G	H	I	J	
Monitor Cabinet with Side Work-in-Process Storage   *PTTV shown  *TVPT	FLT1696-40PTTV Laminate	\$4,488	\$4,538	\$4,548	\$4,577	\$4,619	\$4,657	\$4,700	\$4,751	\$4,863	\$4,920	\$5,018	
	FLV1696-40PTTV	Essentials	\$7,062	\$7,111	\$7,122	\$7,151	\$7,192	\$7,231	\$7,273	\$7,324	\$7,459	\$7,537	\$7,657
		Artisan	\$7,661	\$7,711	\$7,721	\$7,751	\$7,791	\$7,830	\$7,872	\$7,924	\$8,058	\$8,137	\$8,257
	FLT1696-40TVPT Laminate	\$4,488	\$4,538	\$4,548	\$4,577	\$4,619	\$4,657	\$4,700	\$4,751	\$4,863	\$4,920	\$5,018	
	FLV1696-40TVPT	Essentials	\$7,062	\$7,111	\$7,122	\$7,151	\$7,192	\$7,231	\$7,273	\$7,324	\$7,459	\$7,537	\$7,657
		Artisan	\$7,661	\$7,711	\$7,721	\$7,751	\$7,791	\$7,830	\$7,872	\$7,924	\$8,058	\$8,137	\$8,257
	D - 15 1/16 W - 95 7/8 H - 40 CTN WT - 252 CU FT - 43												
	FLT1690-40PTTV Laminate	\$4,357	\$4,406	\$4,417	\$4,446	\$4,487	\$4,526	\$4,568	\$4,619	\$4,730	\$4,786	\$4,884	
	FLV1690-40PTTV	Essentials	\$6,856	\$6,905	\$6,916	\$6,945	\$6,987	\$7,025	\$7,068	\$7,118	\$7,252	\$7,328	\$7,447
		Artisan	\$7,158	\$7,208	\$7,218	\$7,248	\$7,290	\$7,327	\$7,370	\$7,421	\$7,554	\$7,631	\$7,749
	FLT1690-40TVPT Laminate	\$4,357	\$4,406	\$4,417	\$4,446	\$4,487	\$4,526	\$4,568	\$4,619	\$4,730	\$4,786	\$4,884	
	FLV1690-40TVPT	Essentials	\$6,856	\$6,905	\$6,916	\$6,945	\$6,987	\$7,025	\$7,068	\$7,118	\$7,252	\$7,328	\$7,447
Artisan		\$7,442	\$7,491	\$7,502	\$7,531	\$7,573	\$7,611	\$7,654	\$7,704	\$7,838	\$7,914	\$8,033	
D - 15 1/16 W - 89 7/8 H - 40 CTN WT - 238 CU FT - 41													
FLT1684-40PTTV Laminate	\$4,232	\$4,282	\$4,292	\$4,321	\$4,363	\$4,401	\$4,444	\$4,494	\$4,605	\$4,659	\$4,756		
FLV1684-40PTTV	Essentials	\$6,657	\$6,708	\$6,718	\$6,748	\$6,789	\$6,827	\$6,870	\$6,921	\$7,052	\$7,127	\$7,243	
	Artisan	\$7,227	\$7,277	\$7,287	\$7,317	\$7,358	\$7,396	\$7,439	\$7,490	\$7,621	\$7,696	\$7,812	
FLT1684-40TVPT Laminate	\$4,232	\$4,282	\$4,292	\$4,321	\$4,363	\$4,401	\$4,444	\$4,494	\$4,605	\$4,659	\$4,756		
FLV1684-40TVPT	Essentials	\$6,657	\$6,708	\$6,718	\$6,748	\$6,789	\$6,827	\$6,870	\$6,921	\$7,052	\$7,127	\$7,243	
	Artisan	\$7,227	\$7,277	\$7,287	\$7,317	\$7,358	\$7,396	\$7,439	\$7,490	\$7,621	\$7,696	\$7,812	
D - 15 1/16 W - 83 7/8 H - 40 CTN WT - 226 CU FT - 38													

Features:

- use with primary height credenzas
- sliding door
- locking is standard on sliding doors in closed storage position
- work section - one hanging letter size file pocket shelf with full height tackable surface; upper fixed shelf
- flat screen monitor may be mounted in media section
- divided shelf with oval grommet in back panel
- extreme back panel allows for monitor bracket mounting and wire pass through
- 95 7/8" w cabinet = 48" w media section; monitor not to exceed 45" w x 29" h
- 89 7/8" w cabinet = 45" w media section; monitor not to exceed 42" w x 29" h
- 83 7/8" w cabinet = 42" w media section; monitor not to exceed 39" w x 29" h

Options:

- must specify chassis grain direction on artisan veneer, see pages 13-15 for details
- veneer door fronts in paint available, specify paint color and add \$372 list; see page 16 for details
- on laminate units, contrasting door fronts available, no upcharge; specify color, see page 16 for details
- white glass doors with aluminum trim available, specify and add \$2,871 list for 96" w, \$2,472 list for 90" w, \$2,329 list for 84" w; see page 33 for details
- markerboard laminate doors available, specify and add \$546 list; see page 33 for details
- tackboard included in work-in-process section
- com ydg: 95 7/8" w cabinet = 1; 89 7/8" w cabinet = 1; 83 7/8" w cabinet = 1

To Order, Specify:

1 Model Number	2 Fabric Selection
Vendor Pattern Color	Visit www.jsifurniture.com/finishes-and-materials/textiles for our textiles program. See selection of standard and graded in manufacturers and patterns.

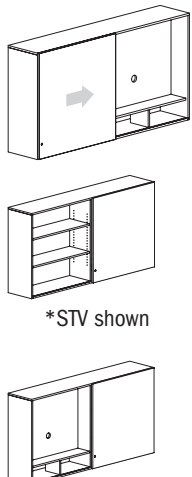
Description	D	W	H	CTN WT	CU FT	① Model	Laminate	Essentials Veneer	Artisan Veneer
 <p>*STV shown</p> <p>*TVS</p>	15 15/16	77 7/8	40	207	35	FLT1678-40STV	\$3,593		
	15 15/16	77 7/8	40	207	35	FLV1678-40STV		\$5,887	\$6,474
	15 15/16	77 7/8	40	207	35	FLT1678-40TVS	\$3,593		
	15 15/16	77 7/8	40	207	35	FLV1678-40TVS		\$5,887	\$6,474
	15 15/16	71 7/8	40	209	33	FLT1672-40STV	\$3,557		
	15 15/16	71 7/8	40	209	33	FLV1672-40STV		\$5,827	\$6,409
	15 15/16	71 7/8	40	209	33	FLT1672-40TVS	\$3,557		
	15 15/16	71 7/8	40	209	33	FLV1672-40TVS		\$5,827	\$6,409
	15 15/16	65 7/8	40	195	30	FLT1666-40STV	\$3,521		
	15 15/16	65 7/8	40	195	30	FLV1666-40STV		\$5,768	\$6,345
	15 15/16	65 7/8	40	195	30	FLT1666-40TVS	\$3,521		
	15 15/16	65 7/8	40	195	30	FLV1666-40TVS		\$5,768	\$6,345
	15 15/16	59 7/8	40	184	27	FLT1660-40STV	\$3,486		
	15 15/16	59 7/8	40	184	27	FLV1660-40STV		\$5,710	\$6,279
	15 15/16	59 7/8	40	184	27	FLT1660-40TVS	\$3,486		
	15 15/16	59 7/8	40	184	27	FLV1660-40TVS		\$5,710	\$6,279

Features:

- use with primary height credenzas
- two adjustable shelves in storage section
- flat screen monitor may be mounted in media section
- divided shelf with oval grommet in back panel
- lock is standard on storage section only
- extreme back panel allows for monitor bracket mounting and wire pass through
- 77 7/8" w cabinet = 39" w media section; monitor not to exceed 36" w x 29" h
- 71 7/8" w cabinet = 36" w media section; monitor not to exceed 33" w x 29" h
- 65 7/8" w cabinet = 33" w media section; monitor not to exceed 30" w x 29" h
- 59 7/8" w cabinet = 30" w media section; monitor not to exceed 27" w x 29" h

Options:

- must specify chassis grain direction on artisan veneer, see pages 13-15 for details
- veneer door fronts in paint available, specify paint color and add \$372 list; see page 16 for details
- on laminate units, contrasting laminate door fronts available, no upcharge; specify laminate color, see page 16 for details
- white glass doors with aluminum trim available, specify and add \$2,188 list for 78" w, \$2,045 list for 72" w, \$1,903 list for 66" w, \$1,761 list for 60" w; see page 33 for details
- markerboard laminate doors available, specify and add \$546 list; see page 33 for details

To Order, Specify:

① Laminate Model #	② Laminate Selection	③ Metal Color	④ Other Product Options
Laminate (FLT)	See Laminate Selection	See Metal Finish Color Options	See list of options for each specific unit; Specify and add accordingly.

① Veneer Model #	② Wood Collection	③ Wood Finish	④ Metal Color	⑤ Other Product Options		
Veneer (FLV)	Essentials	See Essentials Wood Finish Options	See Metal Finish Color Options	See list of options for each specific unit; Specify and add accordingly.		
	Artisan	<table border="1"> <thead> <tr> <th>ⓐ Wood Finish</th> <th>ⓑ Chassis Grain Direction</th> </tr> </thead> <tbody> <tr> <td>See Artisan Wood Finish Options</td> <td>For Artisan Only: Vertical Horizontal</td> </tr> </tbody> </table>	ⓐ Wood Finish		ⓑ Chassis Grain Direction	See Artisan Wood Finish Options
ⓐ Wood Finish	ⓑ Chassis Grain Direction					
See Artisan Wood Finish Options	For Artisan Only: Vertical Horizontal					

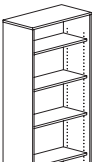
Description	D	W	H	CTN WT	CU FT	① Model	Laminate	Essentials Veneer	Artisan Veneer
	15	36	81	181	32	FLT1536-81FBC	\$1,717		
	15	36	81	181	32	FLV1536-81FBC		\$3,026	\$3,326
	15	30	81	169	27	FLT1530-81FBC	\$1,590		
	15	30	81	169	27	FLV1530-81FBC		\$2,840	\$3,125
	15	24	81	156	22	FLT1524-81FBC	\$1,466		
	15	24	81	156	22	FLV1524-81FBC		\$2,678	\$2,947

Features:

- square edge on top
- five adjustable shelves

Options:

- must specify chassis grain direction on artisan veneer, see pages 13-15 for details

	15	36	69	155	27	FLT1536-69FBC	\$1,636		
	15	36	69	155	27	FLV1536-69FBC		\$2,549	\$2,804
	15	30	69	142	23	FLT1530-69FBC	\$1,510		
	15	30	69	142	23	FLV1530-69FBC		\$2,461	\$2,705
	15	24	69	130	19	FLT1524-69FBC	\$1,390		
	15	24	69	130	19	FLV1524-69FBC		\$2,368	\$2,606

Features:

- square edge on top
- four adjustable shelves

Options:

- must specify chassis grain direction on artisan veneer, see pages 13-15 for details

FLUX

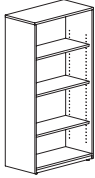
Description	D	W	H	CTN WT	CU FT	① Model	Laminate	Essentials Veneer	Artisan Veneer
	15	36	55 3/8	115	22	FLT1536-55FBC	\$1,474		
	15	36	55 3/8	115	22	FLV1536-55FBC		\$2,296	\$2,526
	15	30	55 3/8	108	19	FLT1530-55FBC	\$1,360		
	15	30	55 3/8	108	19	FLV1530-55FBC		\$2,213	\$2,435
	15	24	55 3/8	101	15	FLT1524-55FBC	\$1,252		
	15	24	55 3/8	101	15	FLV1524-55FBC		\$2,132	\$2,346

Features:

- square edge on top
- three adjustable shelves

Options:

- must specify chassis grain direction on artisan veneer, see pages 13-15 for details

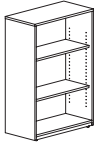
Description	D	W	H	CTN WT	CU FT	① Model	Laminate	Essentials Veneer	Artisan Veneer
	15	36	41 1/16	81	17	FLT1536-42FBC	\$1,209		
	15	36	41 1/16	81	17	FLV1536-42FBC		\$1,886	\$2,076
	15	30	41 1/16	76	14	FLT1530-42FBC	\$1,112		
	15	30	41 1/16	76	14	FLV1530-42FBC		\$1,821	\$2,003
	15	24	41 1/16	71	12	FLT1524-42FBC	\$1,034		
	15	24	41 1/16	71	12	FLV1524-42FBC		\$1,753	\$1,926

Features:

- square edge on top
- two adjustable shelves

Options:

- must specify chassis grain direction on artisan veneer, see pages 13-15 for details

To Order, Specify:

① Laminate Model # Laminate (FLT)		② Laminate Selection See Laminate Selection		③ Metal Color See Metal Finish Color Options	④ Other Product Options See list of options for each specific unit; Specify and add accordingly.
① Veneer Model # Veneer (FLV)	② Wood Collection Essentials	③ Wood Finish See Essentials Wood Finish Options		④ Metal Color See Metal Finish Color Options	⑤ Other Product Options See list of options for each specific unit; Specify and add accordingly.
	Artisan	③a Wood Finish See Artisan Wood Finish Options	③b Chassis Grain Direction For Artisan Only: Vertical Horizontal		

Description	D	W	H	CTN WT	CU FT	① Model	Laminate	Essentials Veneer	Artisan Veneer
Four Drawer Lateral File with Open Compartment	22	36	69	322	38	FLT2236-69F4LF0	\$3,489		
	22	36	69	322	38	FLV2236-69F4LF0		\$4,706	\$5,177
	22	30	69	305	32	FLT2230-69F4LF0	\$3,339		
	22	30	69	305	32	FLV2230-69F4LF0		\$4,468	\$4,920



Features:

- square edge on top
- four drawers with open upper storage
- anti-tip interlock mechanism
- pedestal front locking

Options:

- must specify chassis grain direction on artisan veneer, see pages 13-15 for details
- veneer drawer fronts in paint available, specify paint color and add \$372 list; see page 16 for details
- on laminate units, contrasting drawer fronts available, no upcharge; specify color, see page 16 for details
- ledge pulls standard; prism pulls available, specify and see page 9

Four Drawer Lateral File with Hinge Door Storage Compartment	22	36	69	338	38	FLT2236-69F4LFD	\$3,691		
	22	36	69	338	38	FLV2236-69F4LFD		\$5,002	\$5,501
	22	30	69	321	32	FLT2230-69F4LFD	\$3,531		
	22	30	69	321	32	FLV2230-69F4LFD		\$4,766	\$5,242



Features:

- square edge on top
- four drawers with hinged door upper compartment
- anti-tip interlock mechanism
- pedestal front locking

Options:

- must specify chassis grain direction on artisan veneer, see pages 13-15 for details
- veneer door and drawer fronts in paint available, specify paint color and add \$372 list; see page 16 for details
- on laminate units, contrasting door and drawer fronts available, no upcharge; specify color, see page 16 for details
- locking door available, specify and add \$153 list
- ledge pulls standard; prism pulls available, specify and see page 9

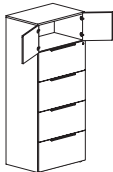

FLUX

Description	D	W	H	CTN WT	CU FT	① Model	Laminate	Essentials Veneer	Artisan Veneer
Four Drawer Lateral File	22	36	55 3/8	287	31	FLT2236-55F4LF	\$2,768		
	22	36	55 3/8	287	31	FLV2236-55F4LF		\$3,735	\$4,108
	22	30	55 3/8	270	26	FLT2230-55F4LF	\$2,654		
	22	30	55 3/8	270	26	FLV2230-55F4LF		\$3,547	\$3,903



Features:

- four drawers
- anti-tip interlock mechanism
- pedestal front locking

Options:

- must specify chassis grain direction on artisan veneer, see pages 13-15 for details
- veneer drawer fronts in paint available, specify paint color and add \$372 list; see page 16 for details
- on laminate units, contrasting drawer fronts available, no upcharge; specify color, see page 16 for details
- ledge pulls standard; prism pulls available, specify and see page 9

Description	D	W	H	CTN WT	CU FT	① Model	Laminate	Essentials Veneer	Artisan Veneer
Three Drawer Lateral File	22	36	41 1/16	232	26	FLT2236-41F3LF	\$2,667		
	22	36	41 1/16	232	26	FLV2236-41F3LF		\$3,216	\$3,537
	22	30	41 1/16	218	20	FLT2230-41F3LF	\$2,510		
	22	30	41 1/16	218	20	FLV2230-41F3LF		\$3,030	\$3,333

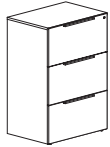

Features:

- three drawers
- anti-tip interlock mechanism
- pedestal front locking

Options:

- must specify chassis grain direction on artisan veneer, see pages 13-15 for details
- veneer drawer fronts in paint available, specify paint color and add \$372 list; see page 16 for details
- on laminate units, contrasting drawer fronts available, no upcharge; specify color, see page 16 for details
- ledge pulls standard; prism pulls available, specify and see page 9

To Order, Specify:

① Laminate Model #		② Laminate Selection		③ Metal Color	④ Other Product Options
Laminate (FLT)		See Laminate Selection		See Metal Finish Color Options	See list of options for each specific unit; Specify and add accordingly.
① Veneer Model #	② Wood Collection	③ Wood Finish		④ Metal Color	⑤ Other Product Options
Veneer (FLV)	Essentials	See Essentials Wood Finish Options		See Metal Finish Color Options	See list of options for each specific unit; Specify and add accordingly.
	Artisan	③a Wood Finish See Artisan Wood Finish Options	③b Chassis Grain Direction For Artisan Only: Vertical Horizontal		

FLUX

Description	D	W	H	CTN WT	CU FT	① Model	Laminate	Essentials Veneer	Artisan Veneer
81" h Wardrobe	22	18	81	168	24	FLT2218-81FDWR	\$2,023		
	22	18	81	168	24	FLV2218-81FDWR		\$3,590	\$3,952
	22	18	81	168	24	FLT2218-81FDWL	\$2,023		
	22	18	81	168	24	FLV2218-81FDWL		\$3,590	\$3,952

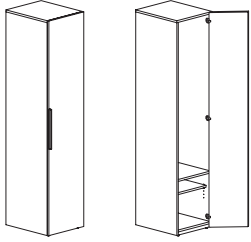

right shown

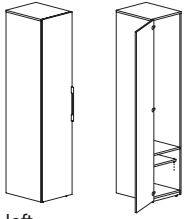

left

Features:

- lower adjustable shelf
- installed coat hooks

Options:

- must specify chassis grain direction on artisan veneer, see pages 13-15 for details
- veneer door front in paint available, specify paint color and add \$372 list; see page 16 for details
- on laminate units, contrasting doors fronts available, no upcharge; specify color, see page 16 for details
- locking door available, specify and add \$153 list
- ledge pulls standard, mounted vertical; prism pulls available, specify and see page 9
- vanity mirror available, specify and add \$157 list

81" h Storage Cabinet	22	18	81	188	24	FLT2218-81FDR	\$2,014		
	22	18	81	188	24	FLV2218-81FDR		\$3,581	\$3,940
	22	18	81	188	24	FLT2218-81FDL	\$2,014		
	22	18	81	188	24	FLV2218-81FDL		\$3,581	\$3,940

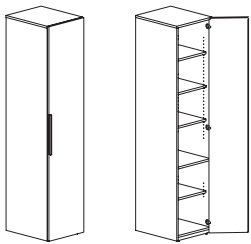

right shown

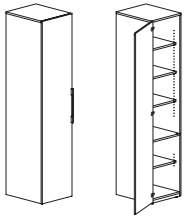

left

Features:

- five adjustable shelves

Options:

- must specify chassis grain direction on artisan veneer, see pages 13-15 for details
- veneer door front in paint available, specify paint color and add \$372 list; see page 16 for details
- on laminate units, contrasting doors fronts available, no upcharge; specify color, see page 16 for details
- locking door available, specify and add \$153 list
- ledge pulls standard, mounted vertical; prism pulls available, specify and see page 9
- vanity mirror available, specify and add \$157 list

FLUX

Description	D	W	H	CTN WT	CU FT	① Model	Laminate	Essentials Veneer	Artisan Veneer
69" h Wardrobe	22	18	69	149	20	FLT2218-69FDWR	\$1,813		
	22	18	69	149	20	FLV2218-69FDWR		\$3,288	\$3,615
	22	18	69	149	20	FLT2218-69FDWL	\$1,813		
	22	18	69	149	20	FLV2218-69FDWL		\$3,288	\$3,615

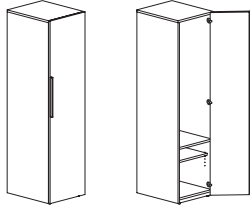

right shown

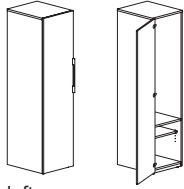

left

Features:

- lower adjustable shelf
- installed coat hooks

Options:

- must specify chassis grain direction on artisan veneer, see pages 13-15 for details
- veneer door front in paint available, specify paint color and add \$372 list; see page 16 for details
- on laminate units, contrasting doors fronts available, no upcharge; specify color, see page 16 for details
- locking door available, specify and add \$153 list
- ledge pulls standard, mounted vertical; prism pulls available, specify and see page 9
- vanity mirror available, specify and add \$157 list

69" h Storage Cabinet	22	18	69	168	20	FLT2218-69FDR	\$1,801		
	22	18	69	168	20	FLV2218-69FDR		\$3,279	\$3,606
	22	18	69	168	20	FLT2218-69FDL	\$1,801		
	22	18	69	168	20	FLV2218-69FDL		\$3,279	\$3,606

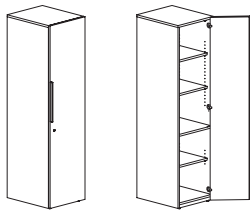

right shown

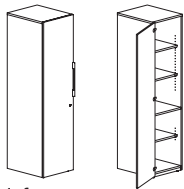

left

Features:

- four adjustable shelves

Options:

- must specify chassis grain direction on artisan veneer, see pages 13-15 for details
- veneer door front in paint available, specify paint color and add \$372 list; see page 16 for details
- on laminate units, contrasting doors fronts available, no upcharge; specify color, see page 16 for details
- locking door available, specify and add \$153 list
- ledge pulls standard, mounted vertical; prism pulls available, specify and see page 9
- vanity mirror available, specify and add \$157 list

To Order, Specify:

① Laminate Model #		② Laminate Selection		③ Metal Color	④ Other Product Options
Laminate (FLT)		See Laminate Selection		See Metal Finish Color Options	See list of options for each specific unit; Specify and add accordingly.
① Veneer Model #	② Wood Collection	③ Wood Finish		④ Metal Color	⑤ Other Product Options
Veneer (FLV)	Essentials	See Essentials Wood Finish Options		See Metal Finish Color Options	See list of options for each specific unit; Specify and add accordingly.
	Artisan	③a Wood Finish See Artisan Wood Finish Options	③b Chassis Grain Direction For Artisan Only: Vertical Horizontal		

FLUX

Description	D	W	H	CTN WT	CU FT	① Model	Laminate	Essentials Veneer	Artisan Veneer
81" h File/File, Storage Cabinet with Side Wardrobe	22	24	81	274	30	FLT2224-81F2DWR	\$3,523		
	22	24	81	274	30	FLV2224-81F2DWR		\$5,564	\$6,120
	22	24	81	274	30	FLT2224-81F2DWL	\$3,523		
	22	24	81	274	30	FLV2224-81F2DWL		\$5,564	\$6,120

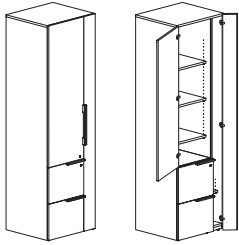

right shown

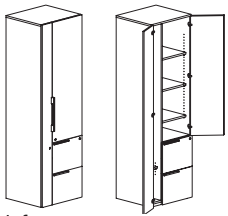

left

Features:

- aligns with primary height units
- pedestal front locking
- upper compartment has three adjustable shelves
- installed coat hook in wardrobe compartment

Options:

- must specify chassis grain direction on artisan veneer, see pages 13-15 for details
- veneer door and drawer front in paint available, specify paint color and add \$372; see page 16 for details
- on laminate units, contrasting door and drawer fronts available, no upcharge; specify color, see page 16 for details
- locking doors available, specify and add \$306 list
- ledge pulls standard; prism pulls available, specify and see page 9
- vanity mirror available, specify and add \$157 list

81" h Box/Box/File, Storage Cabinet with Side Wardrobe	22	24	81	276	30	FLT2224-81F1DWR	\$3,533		
	22	24	81	276	30	FLV2224-81F1DWR		\$5,572	\$6,129
	22	24	81	276	30	FLT2224-81F1DWL	\$3,533		
	22	24	81	276	30	FLV2224-81F1DWL		\$5,572	\$6,129

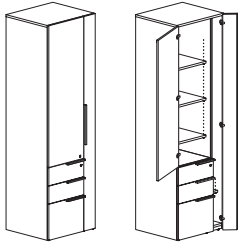

right shown

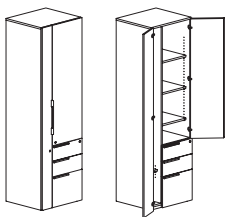

left

Features:

- aligns with primary height units
- pedestal front locking
- upper compartment has three adjustable shelves
- installed coat hook in wardrobe compartment

Options:

- must specify chassis grain direction on artisan veneer, see pages 13-15 for details
- veneer door and drawer front in paint available, specify paint color and add \$372; see page 16 for details
- on laminate units, contrasting door and drawer fronts available, no upcharge; specify color, see page 16 for details
- locking doors available, specify and add \$306 list
- ledge pulls standard; prism pulls available, specify and see page 9
- vanity mirror available, specify and add \$157 list

Description	D	W	H	CTN WT	CU FT	① Model	Laminate	Essentials Veneer	Artisan Veneer
81" h File/File, Open Storage Cabinet with Side Wardrobe	22	24	81	253	30	FLT2224-81F20WR	\$3,405		
	22	24	81	253	30	FLV2224-81F20WR		\$5,390	\$5,929
	22	24	81	253	30	FLT2224-81F20WL	\$3,405		
	22	24	81	253	30	FLV2224-81F20WL		\$5,390	\$5,929

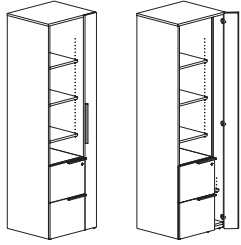

right shown

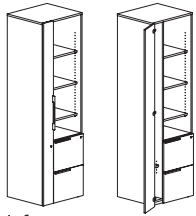

left

Features:

- aligns with primary height units
- pedestal front locking
- upper compartment has three adjustable shelves
- installed coat hook in wardrobe compartment

Options:

- must specify chassis grain direction on artisan veneer, see pages 13-15 for details
- veneer door and drawer front in paint available, specify paint color and add \$372; see page 16 for details
- on laminate units, contrasting door and drawer fronts available, no upcharge; specify color, see page 16 for details
- locking side door available, specify and add \$153 list
- ledge pulls standard; prism pulls available, specify and see page 9

81" h Box/Box/File, Open Storage Cabinet with Side Wardrobe	22	24	81	254	30	FLT2224-81F10WR	\$3,411		
	22	24	81	254	30	FLV2224-81F10WR		\$5,400	\$5,939
	22	24	81	254	30	FLT2224-81F10WL	\$3,411		
	22	24	81	254	30	FLV2224-81F10WL		\$5,400	\$5,939

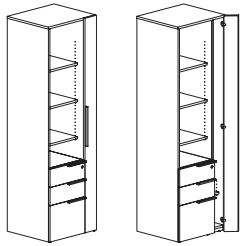

right shown

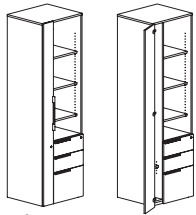

left

Features:

- aligns with primary height units
- pedestal front locking
- upper compartment has three adjustable shelves
- installed coat hook in wardrobe compartment

Options:

- must specify chassis grain direction on artisan veneer, see pages 13-15 for details
- veneer door and drawer front in paint available, specify paint color and add \$372; see page 16 for details
- on laminate units, contrasting door and drawer fronts available, no upcharge; specify color, see page 16 for details
- locking side door available, specify and add \$153 list
- ledge pulls standard; prism pulls available, specify and see page 9

To Order, Specify:

① Laminate Model #		② Laminate Selection		③ Metal Color	④ Other Product Options
Laminate (FLT)		See Laminate Selection		See Metal Finish Color Options	See list of options for each specific unit; Specify and add accordingly.
① Veneer Model #	② Wood Collection	③ Wood Finish		④ Metal Color	⑤ Other Product Options
Veneer (FLV)	Essentials	See Essentials Wood Finish Options		See Metal Finish Color Options	
	Artisan	ⓐ Wood Finish See Artisan Wood Finish Options	ⓑ Chassis Grain Direction For Artisan Only: Vertical Horizontal		

Description	D	W	H	CTN WT	CU FT	① Model	Laminate	Essentials Veneer	Artisan Veneer
81" h Lower and Upper Hinge Door Storage Cabinet with Side Wardrobe	22	24	81	254	30	FLT2224-81F7DWR	\$2,744		
	22	24	81	254	30	FLV2224-81F7DWR		\$4,704	\$5,175
	22	24	81	254	30	FLT2224-81F7DWL	\$2,744		
	22	24	81	254	30	FLV2224-81F7DWL		\$4,704	\$5,175

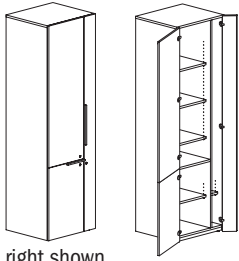

right shown

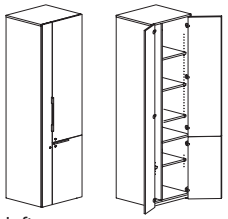

left

Features:

- aligns with primary height units
- upper compartment has three adjustable shelves, lower compartment has one adjustable shelf
- installed coat hook in wardrobe compartment

Options:

- must specify chassis grain direction on artisan veneer, see pages 13-15 for details
- veneer door fronts in paint available, specify paint color and add \$372 list; see page 16 for detail
- on laminate units, contrasting doors fronts available, no upcharge; specify color, see page 16 for details
- locking doors available, specify and add \$459 list
- ledge pulls standard; prism pulls available, specify and see page 9
- pull out trash can available, specify and add \$503 list; see page 38 for details

81" h Lower Hinge Door, Open Storage Cabinet with Side Wardrobe	22	24	81	232	30	FLT2224-81F70WR	\$2,622		
	22	24	81	232	30	FLV2224-81F70WR		\$4,532	\$4,987
	22	24	81	232	30	FLT2224-81F70WL	\$2,622		
	22	24	81	232	30	FLV2224-81F70WL		\$4,532	\$4,987

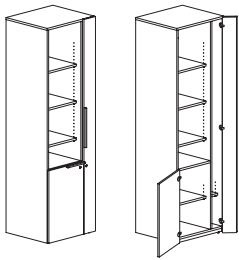

right shown

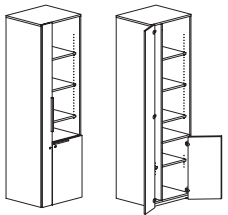

left

Features:

- aligns with primary height units
- upper compartment has three adjustable shelves, lower compartment has one adjustable shelf
- installed coat hook in wardrobe compartment

Options:

- must specify chassis grain direction on artisan veneer, see pages 13-15 for details
- veneer door fronts in paint available, specify paint color and add \$372 list; see page 16 for detail
- on laminate units, contrasting doors fronts available, no upcharge; specify color, see page 16 for details
- locking doors available, specify and add \$459 list
- ledge pulls standard; prism pulls available, specify and see page 9
- pull out trash can available, specify and add \$503 list; see page 38 for details

Description	D	W	H	CTN WT	CU FT	① Model	Laminate	Essentials Veneer	Artisan Veneer
69" h File/File, Storage Cabinet with Side Wardrobe	22	24	69	239	26	FLT2224-69F2DWR	\$3,313		
	22	24	69	239	26	FLV2224-69F2DWR		\$5,261	\$5,786
	22	24	69	239	26	FLT2224-69F2DWL	\$3,313		
	22	24	69	239	26	FLV2224-69F2DWL		\$5,261	\$5,786

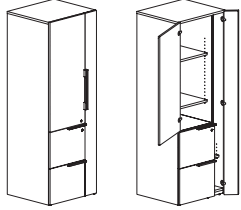

right shown

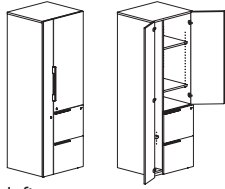

left

Features

- aligns with primary height units
- pedestal front locking
- upper compartment has two adjustable shelves
- installed coat hook in wardrobe compartment

Options:

- must specify chassis grain direction on artisan veneer, see pages 13-15 for details
- veneer door and drawer front in paint available, specify paint color and add \$372; see page 16 for details
- on laminate units, contrasting door and drawer fronts available, no upcharge; specify color, see page 16 for details
- locking doors available, specify and add \$306 list
- ledge pulls standard, mounted vertical; prism pulls available, specify and see page 9

69" h Box/Box/File, Storage Cabinet with Side Wardrobe	22	24	69	241	26	FLT2224-69F1DWR	\$3,320		
	22	24	69	241	26	FLV2224-69F1DWR		\$5,267	\$5,794
	22	24	69	241	26	FLT2224-69F1DWL	\$3,320		
	22	24	69	241	26	FLV2224-69F1DWL		\$5,267	\$5,794

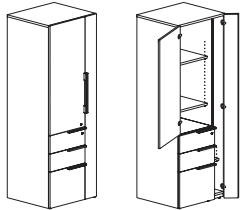

right shown

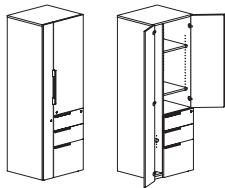

left

Features:

- aligns with primary height units
- pedestal front locking
- upper compartment has two adjustable shelves
- installed coat hook in wardrobe compartment

Options:

- must specify chassis grain direction on artisan veneer, see pages 13-15 for details
- veneer door and drawer front in paint available, specify paint color and add \$372; see page 16 for details
- on laminate units, contrasting door and drawer fronts available, no upcharge; specify color, see page 16 for details
- locking doors available, specify and add \$306 list
- ledge pulls standard, mounted vertical; prism pulls available, specify and see page 9

To Order, Specify:

① Laminate Model #		② Laminate Selection		③ Metal Color	④ Other Product Options
Laminate (FLT)		See Laminate Selection		See Metal Finish Color Options	See list of options for each specific unit; Specify and add accordingly.
① Veneer Model #	② Wood Collection	③ Wood Finish		④ Metal Color	⑤ Other Product Options
Veneer (FLV)	Essentials	See Essentials Wood Finish Options		See Metal Finish Color Options	
	Artisan	ⓐ Wood Finish	ⓑ Chassis Grain Direction		
		See Artisan Wood Finish Options	For Artisan Only: Vertical Horizontal		

Description	D	W	H	CTN WT	CU FT	① Model	Laminate	Essentials Veneer	Artisan Veneer
69" h File/File, Open Storage Cabinet with Side Wardrobe	22	24	69	222	26	FLT2224-69F20WR	\$3,216		
	22	24	69	222	26	FLV2224-69F20WR		\$5,124	\$5,636
	22	24	69	222	26	FLT2224-69F20WL	\$3,216		
	22	24	69	222	26	FLV2224-69F20WL		\$5,124	\$5,636

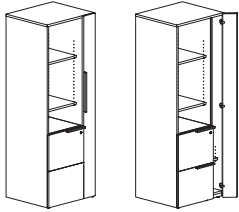

right shown

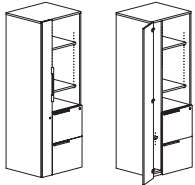

left

Features:

- aligns with primary height units
- pedestal front locking
- upper compartment has two adjustable shelves
- installed coat hook in wardrobe compartment

Options:

- must specify chassis grain direction on artisan veneer, see pages 13-15 for details
- veneer door and drawer front in paint available, specify paint color and add \$372; see page 16 for details
- on laminate units, contrasting door and drawer fronts available, no upcharge; specify color, see page 16 for details
- locking side door available, specify and add \$153 list
- ledge pulls standard, mounted vertical; prism pulls available, specify and see page 9

69" h Box/Box/File, Open Storage Cabinet with Side Wardrobe	22	24	69	224	26	FLT2224-69F10WR	\$3,226		
	22	24	69	224	26	FLV2224-69F10WR		\$5,132	\$5,643
	22	24	69	224	26	FLT2224-69F10WL	\$3,226		
	22	24	69	224	26	FLV2224-69F10WL		\$5,132	\$5,643

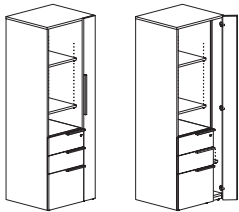

right shown

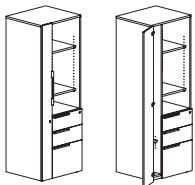

left

Features:

- aligns with primary height units
- pedestal front locking
- upper compartment has two adjustable shelves
- installed coat hook in wardrobe compartment

Options:

- must specify chassis grain direction on artisan veneer, see pages 13-15 for details
- veneer door and drawer front in paint available, specify paint color and add \$372; see page 16 for details
- on laminate units, contrasting door and drawer fronts available, no upcharge; specify color, see page 16 for details
- locking side door available, specify and add \$153 list
- ledge pulls standard, mounted vertical; prism pulls available, specify and see page 9

FLUX

Description	D	W	H	CTN WT	CU FT	① Model	Laminate	Essentials Veneer	Artisan Veneer
69" h Lower and Upper Hinge Door Storage Cabinet with Side Wardrobe	22	24	69	218	26	FLT2224-69F7DWR	\$2,531		
	22	24	69	218	26	FLV2224-69F7DWR		\$4,402	\$4,844
	22	24	69	218	26	FLT2224-69F7DWL	\$2,531		
	22	24	69	218	26	FLV2224-69F7DWL		\$4,402	\$4,844

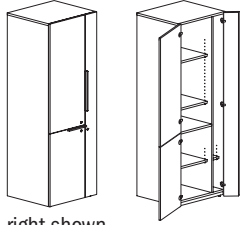

right shown

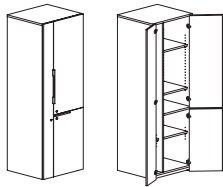

left

Features:

- aligns with primary height units
- upper compartment has two adjustable shelves, lower compartment has one adjustable shelf
- installed coat hook in wardrobe compartment

Options:

- must specify chassis grain direction on artisan veneer, see pages 13-15 for details
- veneer door fronts in paint available, specify paint color and add \$372 list; see page 16 for detail
- on laminate units, contrasting doors fronts available, no upcharge; specify color, see page 16 for details
- locking doors available, specify and add \$459 list
- ledge pulls standard, mounted vertical; prism pulls available, specify and see page 9
- pull out trash can available, specify and add \$503 list; see page 38 for details
- vanity mirror available, specify and add \$157 list

69" h Lower Hinge Door, Open Storage Cabinet with Side Wardrobe	22	24	69	201	26	FLT2224-69F7OWR	\$2,435		
	22	24	69	201	26	FLV2224-69F7OWR		\$4,265	\$4,690
	22	24	69	201	26	FLT2224-69F7OWL	\$2,435		
	22	24	69	201	26	FLV2224-69F7OWL		\$4,265	\$4,690

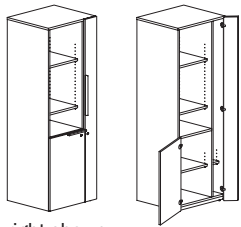

right shown

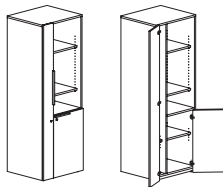

left

Features:

- aligns with primary height units
- upper compartment has two adjustable shelves, lower compartment has one adjustable shelf
- installed coat hook in wardrobe compartment

Options:

- must specify chassis grain direction on artisan veneer, see pages 13-15 for details
- veneer door fronts in paint available, specify paint color and add \$372 list; see page 16 for detail
- on laminate units, contrasting doors fronts available, no upcharge; specify color, see page 16 for details
- locking doors available, specify and add \$306 list
- ledge pulls standard, mounted vertical; prism pulls available, specify and see page 9
- pull out trash can available, specify and add \$503 list; see page 38 for details

To Order, Specify:

① Laminate Model #	② Laminate Selection	③ Metal Color	④ Other Product Options			
Laminate (FLT)	See Laminate Selection	See Metal Finish Color Options	See list of options for each specific unit; Specify and add accordingly.			
① Veneer Model #	② Wood Collection	③ Wood Finish	④ Metal Color	⑤ Other Product Options		
Veneer (FLV)	Essentials	See Essentials Wood Finish Options	See Metal Finish Color Options	See list of options for each specific unit; Specify and add accordingly.		
	Artisan	<table border="1"> <tr> <th>Ⓐ Wood Finish</th> <th>Ⓑ Chassis Grain Direction</th> </tr> <tr> <td>See Artisan Wood Finish Options</td> <td>For Artisan Only: Vertical Horizontal</td> </tr> </table>	Ⓐ Wood Finish		Ⓑ Chassis Grain Direction	See Artisan Wood Finish Options
Ⓐ Wood Finish	Ⓑ Chassis Grain Direction					
See Artisan Wood Finish Options	For Artisan Only: Vertical Horizontal					

Description	D	W	H	CTN WT	CU FT	① Model	Laminate	Essentials Veneer	Artisan Veneer
81" h Side Access Wardrobe with Open Shelves	15 $\frac{7}{8}$ "	36	81	211	32	FLT1636-81FSWR	\$2,636		
	15 $\frac{7}{8}$ "	36	81	211	32	FLV1636-81FSWR		\$4,211	\$4,635
	15 $\frac{7}{8}$ "	36	81	211	32	FLT1636-81FSWL	\$2,636		
	15 $\frac{7}{8}$ "	36	81	211	32	FLV1636-81FSWL		\$4,211	\$4,635
	15 $\frac{7}{8}$ "	30	81	185	27	FLT1630-81FSWR	\$2,430		
	15 $\frac{7}{8}$ "	30	81	185	27	FLV1630-81FSWR		\$3,887	\$4,275
	15 $\frac{7}{8}$ "	30	81	185	27	FLT1630-81FSWL	\$2,430		
	15 $\frac{7}{8}$ "	30	81	185	27	FLV1630-81FSWL		\$3,887	\$4,275

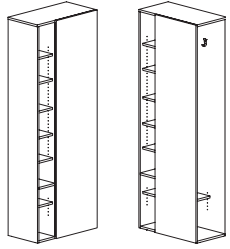

right shown

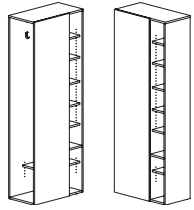

left

Features:

- attaching hardware included
- side entry wardrobe with two installed coat hooks and one lower adjustable shelf
- 8 $\frac{1}{4}$ " w open compartment with five adjustable shelves

Options:

- must specify chassis grain direction on artisan veneer, see pages 13-15 for details

Description	D	W	H	CTN WT	CU FT	① Model	Laminate	Essentials Veneer	Artisan Veneer
69" h Side Access Wardrobe with Open Shelves	15 7/8	36	69	184	27	FLT1636-69FSWR	\$2,425		
	15 7/8	36	69	184	27	FLV1636-69FSWR		\$3,909	\$4,299
	15 7/8	36	69	184	27	FLT1636-69FSWL	\$2,425		
	15 7/8	36	69	184	27	FLV1636-69FSWL		\$3,909	\$4,299
	15 7/8	30	69	160	23	FLT1630-69FSWR	\$2,235		
	15 7/8	30	69	160	23	FLV1630-69FSWR		\$3,601	\$3,960
	15 7/8	30	69	160	23	FLT1630-69FSWL	\$2,235		
	15 7/8	30	69	160	23	FLV1630-69FSWL		\$3,601	\$3,960

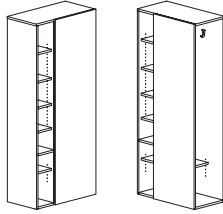

right shown

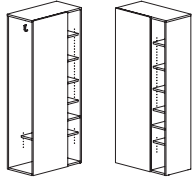

left

Features:

- attaching hardware included
- side entry wardrobe with two installed coat hooks and one lower adjustable shelf
- 8 1/4" w open compartment with four adjustable shelves

Options:

- must specify chassis grain direction on artisan veneer, see pages 13-15 for details

To Order, Specify:

① Laminate Model #	② Laminate Selection	③ Metal Color	④ Other Product Options			
Laminate (FLT)	See Laminate Selection	See Metal Finish Color Options	See list of options for each specific unit; Specify and add accordingly.			
① Veneer Model #	② Wood Collection	③ Wood Finish	④ Metal Color	⑤ Other Product Options		
Veneer (FLV)	Essentials	See Essentials Wood Finish Options	See Metal Finish Color Options	See list of options for each specific unit; Specify and add accordingly.		
	Artisan	<table border="1"> <tr> <th>③a Wood Finish</th> <th>③b Chassis Grain Direction</th> </tr> <tr> <td>See Artisan Wood Finish Options</td> <td>For Artisan Only: Vertical Horizontal</td> </tr> </table>	③a Wood Finish		③b Chassis Grain Direction	See Artisan Wood Finish Options
③a Wood Finish	③b Chassis Grain Direction					
See Artisan Wood Finish Options	For Artisan Only: Vertical Horizontal					

Description	D	W	H	CTN WT	CU FT	① Model	Laminate	Essentials Veneer	Artisan Veneer
81" h File/File Lateral, Storage Cabinet	22	36	81	326	44	FLT2236-81F4D	\$3,741		
	22	36	81	326	44	FLV2236-81F4D		\$5,912	\$6,503
	22	30	81	281	37	FLT2230-81F4D	\$3,542		
	22	30	81	281	37	FLV2230-81F4D		\$5,651	\$6,218

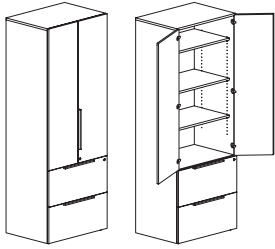

Features:

- aligns with primary height units
- pedestal front locking
- upper compartment has three adjustable shelves

Options:

- must specify chassis grain direction on artisan veneer, see pages 13-15 for details
- veneer door and drawer front in paint available, specify paint color and add \$372; see page 16 for details
- on laminate units, contrasting door and drawer fronts available, no upcharge; specify color, see page 16 for details
- locking upper doors available, specify and add \$153 list
- ledge pulls standard; prism pulls available, specify and see page 9

81" h Box/Box File Lateral, Storage Cabinet	22	36	81	326	44	FLT2236-81F3D	\$3,755		
	22	36	81	326	44	FLV2236-81F3D		\$5,926	\$6,517
	22	30	81	281	37	FLT2230-81F3D	\$3,554		
	22	30	81	281	37	FLV2230-81F3D		\$5,664	\$6,229

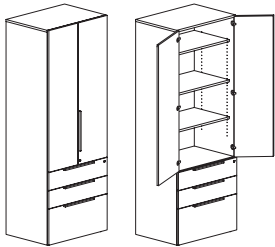

Features:

- aligns with primary height units
- pedestal front locking
- upper compartment has three adjustable shelves

Options:

- must specify chassis grain direction on artisan veneer, see pages 13-15 for details
- veneer door and drawer front in paint available, specify paint color and add \$372; see page 16 for details
- on laminate units, contrasting door and drawer fronts available, no upcharge; specify color, see page 16 for details
- locking upper doors available, specify and add \$153 list
- ledge pulls standard; prism pulls available, specify and see page 9

81" h Lower and Upper Hinge Door Storage Cabinet	22	36	81	310	44	FLT2236-81F7D	\$3,007		
	22	36	81	310	44	FLV2236-81F7D		\$5,136	\$5,649
	22	30	81	270	37	FLT2230-81F7D	\$2,823		
	22	30	81	270	37	FLV2230-81F7D		\$4,901	\$5,390

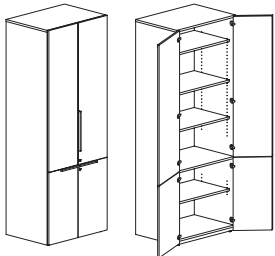

Features:

- aligns with primary height units
- upper compartment has three adjustable shelves, lower compartment has one adjustable shelf

Options:

- must specify chassis grain direction on artisan veneer, see pages 13-15 for details
- veneer door fronts in paint available, specify paint color and add \$372 list; see page 16 for details
- on laminate units, contrasting doors fronts available, no upcharge; specify color, see page 16 for details
- locking doors available, specify and add \$306 list
- ledge pulls standard, mounted vertical; prism pulls available, specify and see page 9

FLUX

Description	D	W	H	CTN WT	CU FT	① Model	Laminate	Essentials Veneer	Artisan Veneer
81" h File/File Lateral, Open Storage Cabinet	22	36	81	282	44	FLT2236-81F40	\$3,522		
	22	36	81	282	44	FLV2236-81F40		\$5,622	\$6,184
	22	30	81	255	37	FLT2230-81F40	\$3,337		
	22	30	81	255	37	FLV2230-81F40		\$5,383	\$5,919

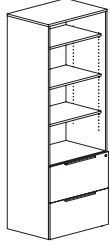

Features:

- aligns with primary height units
- pedestal front locking
- upper compartment has three adjustable shelves

Options:

- must specify chassis grain direction on artisan veneer, see pages 13-15 for details
- veneer drawer fronts in paint available, specify paint color and add \$372 list; see page 16 for details
- on laminate units, contrasting drawer fronts available, no upcharge; specify color, see page 16 for details
- ledge pulls standard; prism pulls available, specify and see page 9

81" h Box/Box/File Lateral, Open Storage Cabinet	22	36	81	282	44	FLT2236-81F30	\$3,535		
	22	36	81	282	44	FLV2236-81F30		\$5,637	\$6,201
	22	30	81	255	37	FLT2230-81F30	\$3,352		
	22	30	81	255	37	FLV2230-81F30		\$5,393	\$5,931

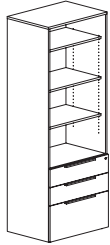

Features:

- aligns with primary height units
- pedestal front locking
- upper compartment has three adjustable shelves

Options:

- must specify chassis grain direction on artisan veneer, see pages 13-15 for details
- veneer drawer fronts in paint available, specify paint color and add \$372 list; see page 16 for details
- on laminate units, contrasting drawer fronts available, no upcharge; specify color, see page 16 for details
- ledge pulls standard; prism pulls available, specify and see page 9

81" h Lower Hinge Doors, Open Storage Cabinet	22	36	81	261	44	FLT2236-81F70	\$2,787		
	22	36	81	261	44	FLV2236-81F70		\$4,849	\$5,333
	22	30	81	233	37	FLT2230-81F70	\$2,617		
	22	30	81	233	37	FLV2230-81F70		\$4,630	\$5,093

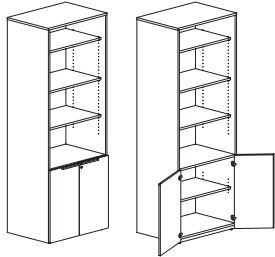

Features:

- aligns with primary height units
- upper compartment has three adjustable shelves, lower compartment has one adjustable shelf

Options:

- must specify chassis grain direction on artisan veneer, see pages 13-15 for details
- veneer door fronts in paint available, specify paint color and add \$372 list; see page 16 for details
- on laminate units, contrasting doors fronts available, no upcharge; specify color, see page 16 for details
- locking lower doors available specify and add \$153 list
- ledge pulls standard; prism pulls available, specify and see page 9

To Order, Specify:

① Laminate Model #	② Laminate Selection	③ Metal Color	④ Other Product Options
Laminate (FLT)	See Laminate Selection	See Metal Finish Color Options	See list of options for each specific unit; Specify and add accordingly.

① Veneer Model #	② Wood Collection	③ Wood Finish	④ Metal Color	⑤ Other Product Options		
Veneer (FLV)	Essentials	See Essentials Wood Finish Options	See Metal Finish Color Options	See list of options for each specific unit; Specify and add accordingly.		
	Artisan	<table border="1"> <thead> <tr> <th>Ⓐ Wood Finish</th> <th>Ⓑ Chassis Grain Direction</th> </tr> </thead> <tbody> <tr> <td>See Artisan Wood Finish Options</td> <td>For Artisan Only: Vertical Horizontal</td> </tr> </tbody> </table>	Ⓐ Wood Finish		Ⓑ Chassis Grain Direction	See Artisan Wood Finish Options
Ⓐ Wood Finish	Ⓑ Chassis Grain Direction					
See Artisan Wood Finish Options	For Artisan Only: Vertical Horizontal					

Description	D	W	H	CTN WT	CU FT	① Model	Laminate	Essentials Veneer	Artisan Veneer
69" h File/File Lateral, Storage Cabinet	22	36	69	305	38	FLT2236-69F4D	\$3,413		
	22	36	69	305	38	FLV2236-69F4D		\$5,444	\$5,987
	22	30	69	262	32	FLT2230-69F4D	\$3,246		
	22	30	69	262	32	FLV2230-69F4D		\$5,225	\$5,748

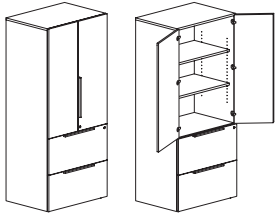

Features:

- aligns with primary height units
- upper compartment has two adjustable shelves

Options:

- must specify chassis grain direction on artisan veneer, see pages 13-15 for details
- veneer door and drawer front in paint available, specify paint color and add \$372; see page 16 for details
- on laminate units, contrasting door and drawer fronts available, no upcharge; specify color, see page 16 for details
- locking upper doors available, specify and add \$153 list
- ledge pulls standard; prism pulls available, specify and see page 9

69" h Box/Box/File Lateral, Storage Cabinet	22	36	69	303	38	FLT2236-69F3D	\$3,428		
	22	36	69	303	38	FLV2236-69F3D		\$5,458	\$6,004
	22	30	69	265	32	FLT2230-69F3D	\$3,259		
	22	30	69	265	32	FLV2230-69F3D		\$5,238	\$5,764

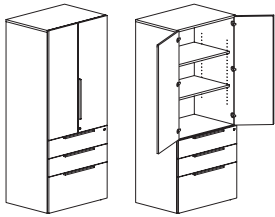

Features:

- aligns with primary height units
- pedestal front locking
- upper compartment has two adjustable shelves

Options:

- must specify chassis grain direction on artisan veneer, see pages 13-15 for details
- veneer door and drawer front in paint available, specify paint color and add \$372; see page 16 for details
- on laminate units, contrasting door and drawer fronts available, no upcharge; specify color, see page 16 for details
- locking upper doors available, specify and add \$153 list
- ledge pulls standard; prism pulls available, specify and see page 9

69" h Lower and Upper Hinge Door Storage Cabinet	22	36	69	267	38	FLT2236-69F7D	\$2,679		
	22	36	69	267	38	FLV2236-69F7D		\$4,669	\$5,136
	22	30	69	232	32	FLT2230-69F7D	\$2,526		
	22	30	69	232	32	FLV2230-69F7D		\$4,475	\$4,923

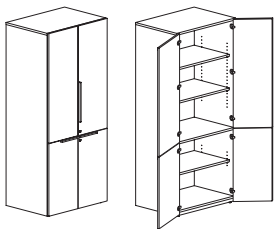

Features:

- aligns with primary height units
- upper compartment has two adjustable shelves, lower compartment has one adjustable shelf

Options:

- must specify chassis grain direction on artisan veneer, see pages 13-15 for details
- veneer door fronts in paint available, specify paint color and add \$372 list; see page 16 for details
- on laminate units, contrasting doors fronts available, no upcharge; specify color, see page 16 for details
- locking doors available, specify and add \$306 list
- ledge pulls standard; prism pulls available, specify and see page 9

FLUX

Description	D	W	H	CTN WT	CU FT	① Model	Laminate	Essentials Veneer	Artisan Veneer
69" h File/File Lateral, Open Storage Cabinet	22	36	69	262	37	FLT2236-69F40	\$3,234		
	22	36	69	262	37	FLV2236-69F40		\$5,212	\$5,732
	22	30	69	225	32	FLT2230-69F40	\$3,077		
	22	30	69	225	32	FLV2230-69F40		\$5,212	\$5,732

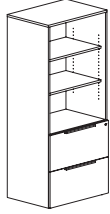

Features:

- aligns with primary height units
- pedestal front locking
- upper compartment has two adjustable shelves

Options:

- must specify chassis grain direction on artisan veneer, see pages 13-15 for details
- veneer drawer fronts in paint available, specify paint color and add \$372 list; see page 16 for details
- on laminate units, contrasting drawer fronts available, no upcharge; specify color, see page 16 for details
- ledge pulls standard; prism pulls available, specify and see page 9

69" h Box/Box/File Lateral, Open Storage Cabinet	22	36	69	261	37	FLT2236-69F30	\$3,246		
	22	36	69	261	37	FLV2236-69F30		\$5,222	\$5,747
	22	30	69	228	32	FLT2230-69F30	\$3,090		
	22	30	69	228	32	FLV2230-69F30		\$5,017	\$5,523

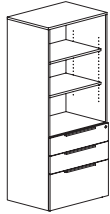

Features:

- aligns with primary height units
- pedestal front locking
- upper compartment has two adjustable shelves

Options:

- must specify chassis grain direction on artisan veneer, see pages 13-15 for details
- veneer drawer fronts in paint available, specify paint color and add \$372 list; see page 16 for details
- on laminate units, contrasting drawer fronts available, no upcharge; specify color, see page 16 for details
- ledge pulls standard; prism pulls available, specify and see page 9

69" h Lower Hinge Doors, Open Storage Cabinet	22	36	69	266	38	FLT2236-69F70	\$2,497		
	22	36	69	266	38	FLV2236-69F70		\$4,437	\$4,879
	22	30	69	204	32	FLT2230-69F70	\$2,355		
	22	30	69	204	32	FLV2230-69F70		\$4,253	\$4,682

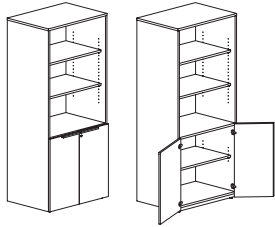

Features:

- aligns with primary height units
- upper compartment has two adjustable shelves, lower compartment has one adjustable shelf

Options:

- must specify chassis grain direction on artisan veneer, see pages 13-15 for details
- veneer door fronts in paint available, specify paint color and add \$372 list; see page 16 for details
- on laminate units, contrasting doors fronts available, no upcharge; specify color, see page 16 for details
- locking lower doors available specify and add \$153 list
- ledge pulls standard; prism pulls available, specify and see page 9

To Order, Specify:

① Laminate Model #		② Laminate Selection		③ Metal Color	④ Other Product Options
Laminate (FLT)		See Laminate Selection		See Metal Finish Color Options	See list of options for each specific unit; Specify and add accordingly.
① Veneer Model #	② Wood Collection	③ Wood Finish		④ Metal Color	⑤ Other Product Options
Veneer (FLV)	Essentials	See Essentials Wood Finish Options		See Metal Finish Color Options	See list of options for each specific unit; Specify and add accordingly.
	Artisan	Ⓐ Wood Finish See Artisan Wood Finish Options	Ⓑ Chassis Grain Direction For Artisan Only: Vertical Horizontal		

FLUX

Description	D	W	H	CTN WT	CU FT	① Model	Laminate	Essentials Veneer	Artisan Veneer
81" h File/File, Storage Cabinet	22	18	81	209	24	FLT2218-81F2DR	\$2,790		
	22	18	81	209	24	FLV2218-81F2DR		\$4,381	\$4,819
	22	18	81	209	24	FLT2218-81F2DL	\$2,790		
	22	18	81	209	24	FLV2218-81F2DL		\$4,381	\$4,819

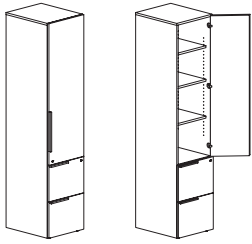

right shown

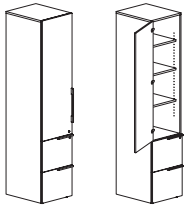

left

Features:

- aligns with primary height units
- pedestal front locking
- upper compartment has three adjustable shelves

Options:

- must specify chassis grain direction on artisan veneer, see pages 13-15 for details
- veneer door and drawer front in paint available, specify paint color and add \$372; see page 16 for details
- on laminate units, contrasting door and drawer fronts available, no upcharge; specify color, see page 16 for details
- locking upper door available, specify and add \$153 list
- ledge pulls standard; prism pulls available, specify and see page 9
- vanity mirror available, specify and add \$157 list

81" h Box/Box/File, Storage Cabinet	22	18	81	210	24	FLT2218-81F1DR	\$2,800		
	22	18	81	210	24	FLV2218-81F1DR		\$4,392	\$4,828
	22	18	81	210	24	FLT2218-81F1DL	\$2,800		
	22	18	81	210	24	FLV2218-81F1DL		\$4,392	\$4,828

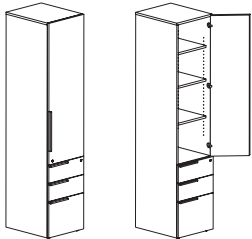

right shown

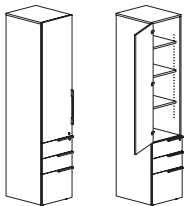

left

Features:

- aligns with primary height units
- pedestal front locking
- upper compartment has three adjustable shelves

Options:

- must specify chassis grain direction on artisan veneer, see pages 13-15 for details
- veneer door and drawer front in paint available, specify paint color and add \$372; see page 16 for details
- on laminate units, contrasting door and drawer fronts available, no upcharge; specify color, see page 16 for details
- locking upper door available, specify and add \$153 list
- ledge pulls standard; prism pulls available, specify and see page 9
- vanity mirror available, specify and add \$157 list

Description	D	W	H	CTN WT	CU FT	① Model	Laminate	Essentials Veneer	Artisan Veneer
81" h File/File, Open Storage Cabinet	22	18	81	187	24	FLT2218-81F20	\$2,673		
	22	18	81	187	24	FLV2218-81F20		\$4,208	\$4,629

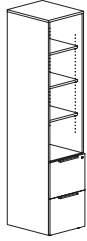

Features:

- aligns with primary height units
- pedestal front locking
- upper compartment has three adjustable shelves

Options:

- must specify chassis grain direction on artisan veneer, see pages 13-15 for details
- veneer drawer fronts in paint available, specify paint color and add \$372 list; see page 16 for details
- on laminate units, contrasting drawer fronts available, no upcharge; specify color, see page 16 for details
- ledge pulls standard; prism pulls available, specify and see page 9

81" h Box/Box/File, Open Storage Cabinet	22	18	81	187	24	FLT2218-81F10	\$2,680		
	22	18	81	187	24	FLV2218-81F10		\$4,218	\$4,639

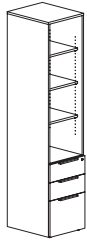

Features:

- aligns with primary height units
- pedestal front locking
- upper compartment has three adjustable shelves

Options:

- must specify chassis grain direction on artisan veneer, see pages 13-15 for details
- veneer drawer fronts in paint available, specify paint color and add \$372 list; see page 16 for details
- on laminate units, contrasting drawer fronts available, no upcharge; specify color, see page 16 for details
- ledge pulls standard; prism pulls available, specify and see page 9

FLUX

To Order, Specify:

① Laminate Model #		② Laminate Selection		③ Metal Color	④ Other Product Options
Laminate (FLT)		See Laminate Selection		See Metal Finish Color Options	See list of options for each specific unit; Specify and add accordingly.
① Veneer Model #	② Wood Collection	③ Wood Finish		④ Metal Color	⑤ Other Product Options
Veneer (FLV)	Essentials	See Essentials Wood Finish Options		See Metal Finish Color Options	See list of options for each specific unit; Specify and add accordingly.
	Artisan	Ⓒa Wood Finish See Artisan Wood Finish Options	Ⓒb Chassis Grain Direction For Artisan Only: Vertical Horizontal		

Description	D	W	H	CTN WT	CU FT	① Model	Laminate	Essentials Veneer	Artisan Veneer
69" h File/File, Storage Cabinet	22	18	69	192	20	FLT2218-69F2DR	\$2,577		
	22	18	69	192	20	FLV2218-69F2DR		\$4,079	\$4,487
	22	18	69	192	20	FLT2218-69F2DL	\$2,577		
	22	18	69	192	20	FLV2218-69F2DL		\$4,079	\$4,487

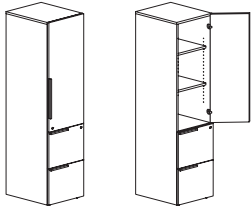

right shown

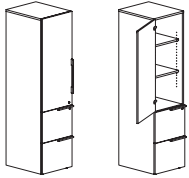

left

Features:

- aligns with primary height units
- pedestal front locking
- upper compartment has two adjustable shelves

Options:

- must specify chassis grain direction on artisan veneer, see pages 13-15 for details
- veneer door and drawer front in paint available, specify paint color and add \$372; see page 16 for details
- on laminate units, contrasting door and drawer fronts available, no upcharge; specify color, see page 16 for details
- locking upper door available, specify and add \$153 list
- ledge pulls standard; prism pulls available, specify and see page 9
- vanity mirror available, specify and add \$157 list

69" h Box/Box/File, Storage Cabinet	22	18	69	192	20	FLT2218-69F1DR	\$2,589		
	22	18	69	192	20	FLV2218-69F1DR		\$4,087	\$4,496
	22	18	69	192	20	FLT2218-69F1DL	\$2,589		
	22	18	69	192	20	FLV2218-69F1DL		\$4,087	\$4,496

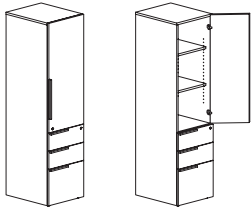

right shown

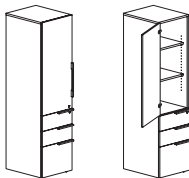

left

Features:

- aligns with primary height units
- pedestal front locking
- upper compartment has two adjustable shelves

Options:

- must specify chassis grain direction on artisan veneer, see pages 13-15 for details
- veneer door and drawer front in paint available, specify paint color and add \$372; see page 16 for details
- on laminate units, contrasting door and drawer fronts available, no upcharge; specify color, see page 16 for details
- locking upper door available, specify and add \$153 list
- ledge pulls standard; prism pulls available, specify and see page 9
- vanity mirror available, specify and add \$157 list

FLUX

Description	D	W	H	CTN WT	CU FT	① Model	Laminate	Essentials Veneer	Artisan Veneer
69" h File/File, Open Storage Cabinet	22	18	69	166	20	FLT2218-69F20	\$2,484		
	22	18	69	166	20	FLV2218-69F20		\$3,941	\$4,336

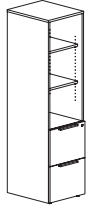

Features:

- aligns with primary height units
- pedestal front locking
- upper compartment has two adjustable shelves

Options:

- must specify chassis grain direction on artisan veneer, see pages 13-15 for details
- veneer drawer fronts in paint available, specify paint color and add \$372 list; see page 16 for details
- on laminate units, contrasting drawer fronts available, no upcharge; specify color, see page 16 for details
- ledge pulls standard; prism pulls available, specify and see page 9

69" h Box/Box/File, Open Storage Cabinet	22	18	69	166	20	FLT2218-69F10	\$2,492		
	22	18	69	166	20	FLV2218-69F10		\$3,952	\$4,346

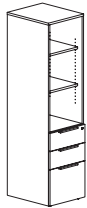

Features:

- aligns with primary height units
- pedestal front locking
- upper compartment has two adjustable shelves

Options:

- must specify chassis grain direction on artisan veneer, see pages 13-15 for details
- veneer drawer fronts in paint available, specify paint color and add \$372 list; see page 16 for details
- on laminate units, contrasting drawer fronts available, no upcharge; specify color, see page 16 for details
- ledge pulls standard; prism pulls available, specify and see page 9

FLUX

To Order, Specify:

① Laminate Model #		② Laminate Selection		③ Metal Color	④ Other Product Options
Laminate (FLT)		See Laminate Selection		See Metal Finish Color Options	See list of options for each specific unit; Specify and add accordingly.
① Veneer Model #	② Wood Collection	③ Wood Finish		④ Metal Color	⑤ Other Product Options
Veneer (FLV)	Essentials	See Essentials Wood Finish Options		See Metal Finish Color Options	See list of options for each specific unit; Specify and add accordingly.
	Artisan	See Artisan Wood Finish Options	ⓐ Chassis Grain Direction For Artisan Only: Vertical Horizontal		

Description	D	W	H	CTN WT	CU FT	① Model	Laminate	Essentials Veneer	Artisan Veneer
81" h Lower and Upper Hinge Storage Cabinet	22	18	81	188	24	FLT2218-81F7DR	\$2,107		
	22	18	81	188	24	FLV2218-81F7DR		\$3,660	\$4,027
	22	18	81	188	24	FLT2218-81F7DL	\$2,107		
	22	18	81	188	24	FLV2218-81F7DL		\$3,660	\$4,027

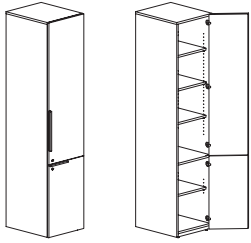

right shown

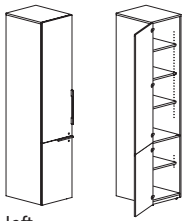

left

Features:

- aligns with primary height units
- upper compartment has three adjustable shelves, lower compartment has one adjustable shelf

Options:

- must specify chassis grain direction on artisan veneer, see pages 13-15 for details
- veneer door front in paint available, specify paint color and add \$372 list; see page 16 for details
- on laminate units, contrasting doors fronts available, no upcharge; specify color, see page 16 for details
- locking doors available, specify and add \$306 list
- ledge pulls standard, mounted vertical; prism pulls available, specify and see page 9
- pull out trash can available, specify and add \$503 list; see page 38 for details
- vanity mirror available, specify and add \$157 list

81" h Lower Hinge Door, Open Storage Cabinet	22	18	81	166	24	FLT2218-81F70R	\$1,989		
	22	18	81	166	24	FLV2218-81F70R		\$3,488	\$3,836
	22	18	81	166	24	FLT2218-81F70L	\$1,989		
	22	18	81	166	24	FLV2218-81F70L		\$3,488	\$3,836

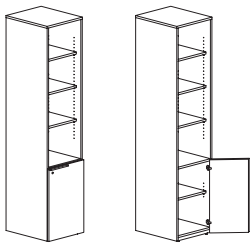

right shown

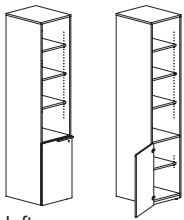

left

Features:

- aligns with primary height units
- upper compartment has three adjustable shelves, lower compartment has one adjustable shelf

Options:

- must specify chassis grain direction on artisan veneer, see pages 13-15 for details
- veneer door front in paint available, specify paint color and add \$372 list; see page 16 for details
- on laminate units, contrasting doors fronts available, no upcharge; specify color, see page 16 for details
- locking lower door available, specify and add \$153 list
- ledge pulls standard; prism pulls available, specify and see page 9
- pull out trash can available, specify and add \$503 list; see page 38 for details

FLUX

Description	D	W	H	CTN WT	CU FT	① Model	Laminate	Essentials Veneer	Artisan Veneer
69" h Lower and Upper Hinge Door Storage Cabinet	22	18	69	163	20	FLT2218-69F7DR	\$1,896		
	22	18	69	163	20	FLV2218-69F7DR		\$3,359	\$3,693
	22	18	69	163	20	FLT2218-69F7DL	\$1,896		
	22	18	69	163	20	FLV2218-69F7DL		\$3,359	\$3,693

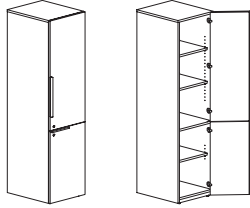

right shown

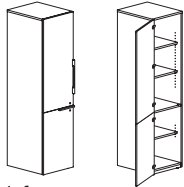

left

Features:

- aligns with primary height units
- upper compartment has two adjustable shelves, lower compartment has one adjustable shelf

Options:

- must specify chassis grain direction on artisan veneer, see pages 13-15 for details
- veneer door front in paint available, specify paint color and add \$372 list; see page 16 for details
- on laminate units, contrasting doors fronts available, no upcharge; specify color, see page 16 for details
- locking doors available, specify and add \$306 list
- ledge pulls standard, mounted vertical; prism pulls available, specify and see page 9
- pull out trash can available, specify and add \$503 list; see page 38 for details
- vanity mirror available, specify and add \$157 list

69" h Lower Hinge Door, Open Storage Cabinet	22	18	69	145	20	FLT2218-69F70R	\$1,798		
	22	18	69	145	20	FLV2218-69F70R		\$3,220	\$3,542
	22	18	69	145	20	FLT2218-69F70L	\$1,798		
	22	18	69	145	20	FLV2218-69F70L		\$3,220	\$3,542

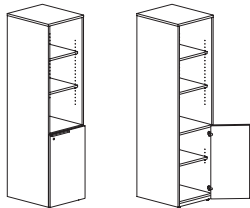

right shown

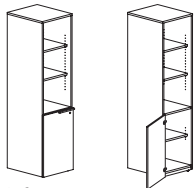

left

Features:

- aligns with primary height units
- upper compartment has two adjustable shelves

Options:

- must specify chassis grain direction on artisan veneer, see pages 13-15 for details
- veneer door front in paint available, specify paint color and add \$372 list; see page 16 for details
- on laminate units, contrasting doors fronts available, no upcharge; specify color, see page 16 for details
- locking lower door available, specify and add \$153 list
- ledge pulls standard; prism pulls available, specify and see page 9
- pull out trash can available, specify and add \$503 list; see page 38 for details

To Order, Specify:

① Laminate Model #	② Laminate Selection	③ Metal Color	④ Other Product Options
Laminate (FLT)	See Laminate Selection	See Metal Finish Color Options	See list of options for each specific unit; Specify and add accordingly.

① Veneer Model #	② Wood Collection	③ Wood Finish	④ Metal Color	⑤ Other Product Options		
Veneer (FLV)	Essentials	See Essentials Wood Finish Options	See Metal Finish Color Options	See list of options for each specific unit; Specify and add accordingly.		
	Artisan	<table border="1"> <thead> <tr> <th>Ⓐ Wood Finish</th> <th>Ⓑ Chassis Grain Direction</th> </tr> </thead> <tbody> <tr> <td>See Artisan Wood Finish Options</td> <td>For Artisan Only: Vertical Horizontal</td> </tr> </tbody> </table>	Ⓐ Wood Finish		Ⓑ Chassis Grain Direction	See Artisan Wood Finish Options
Ⓐ Wood Finish	Ⓑ Chassis Grain Direction					
See Artisan Wood Finish Options	For Artisan Only: Vertical Horizontal					

Description	D	W	H	CTN WT	CU FT	① Model	Laminate	Essentials Veneer	Artisan Veneer
81" h Pantry Drawer, Storage Cabinet	22	18	81	227	24	FLT2218-81FADR	\$2,949		
	22	18	81	227	24	FLV2218-81FADR		\$4,538	\$4,992
	22	18	81	227	24	FLT2218-81FADL	\$2,949		
	22	18	81	227	24	FLV2218-81FADL		\$4,538	\$4,992

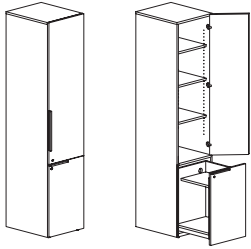

right shown

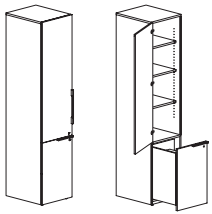

left

Features:

- aligns with primary height units
- concealed caster under drawer for added support
- upper compartment has three adjustable shelves
- oval back panel grommet standard with installed power unit
- pantry drawer front locking

Options:

- must specify chassis grain direction on artisan veneer, see pages 13-15 for details
- veneer door and drawer front in paint available, specify paint color and add \$372; see page 16 for details
- on laminate units, contrasting door and drawer fronts available, no upcharge; specify color, see page 16 for details
- locking door available, specify and add \$153 list
- ledge pulls standard; prism pulls available, specify and see page 9
- power unit (2 simplex and 2 USB charging ports) available, specify and add \$1,008 list; see page 38 for details
- vanity mirror available, specify and add \$157 list

81" h Pantry Drawer, Open Storage Cabinet	22	18	81	196	24	FLT2218-81FA0R	\$2,829		
	22	18	81	196	24	FLV2218-81FA0R		\$4,328	\$4,762
	22	18	81	196	24	FLT2218-81FA0L	\$2,829		
	22	18	81	196	24	FLV2218-81FA0L		\$4,328	\$4,762

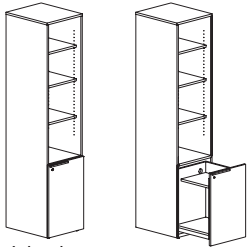

right shown

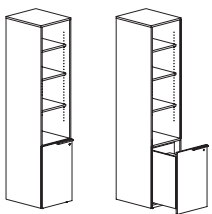

left

Features:

- aligns with primary height units
- concealed caster under drawer for added support
- upper compartment has three adjustable shelves
- oval back panel grommet standard with installed power unit
- pantry drawer front locking

Options:

- must specify chassis grain direction on artisan veneer, see pages 13-15 for details
- veneer drawer fronts in paint available, specify paint color and add \$372 list; see page 16 for details
- on laminate units, contrasting door front available, no upcharge; specify color, see page 16 for details
- ledge pulls standard; prism pulls available, specify and see page 9
- power unit (2 simplex and 2 USB charging ports) available, specify and add \$1,008 list; see page 38 for details

Description	D	W	H	CTN WT	CU FT	① Model	Laminate	Essentials Veneer	Artisan Veneer
69" h Pantry Drawer, Storage Cabinet	22	18	69	192	20	FLT2218-69FADR	\$2,737		
	22	18	69	192	20	FLV2218-69FADR		\$4,236	\$4,659
	22	18	69	192	20	FLT2218-69FADL	\$2,737		
	22	18	69	192	20	FLV2218-69FADL		\$4,236	\$4,659

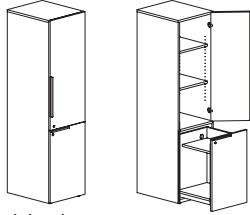

right shown

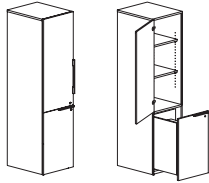

left

Features:

- aligns with primary height units
- concealed caster under drawer for added support
- upper compartment has two adjustable shelves
- oval back panel grommet standard with installed power unit
- pantry drawer front locking

Options:

- must specify chassis grain direction on artisan veneer, see pages 13-15 for details
- veneer door and drawer front in paint available, specify paint color and add \$372; see page 16 for details
- on laminate units, contrasting door and drawer fronts available, no upcharge; specify color, see page 16 for details
- locking door available, specify and add \$153 list
- ledge pulls standard, mounted vertical; prism pulls available, specify and see page 9
- power unit (2 simplex and 2 USB charging ports) available, specify and add \$1,008 list; see page 38 for details
- vanity mirror available, specify and add \$157 list

69" h Pantry Drawer, Open Storage Cabinet	22	18	69	173	20	FLT2218-69FA0R	\$2,639		
	22	18	69	173	20	FLV2218-69FA0R		\$4,099	\$4,509
	22	18	69	173	20	FLT2218-69FA0L	\$2,639		
	22	18	69	173	20	FLV2218-69FA0L		\$4,099	\$4,509

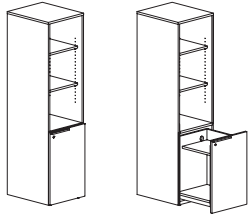

right shown

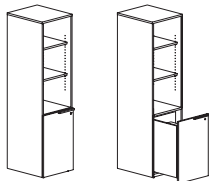

left

Features:

- aligns with primary height units
- concealed caster under drawer for added support
- upper compartment has two adjustable shelves
- oval back panel grommet standard with installed power unit
- pantry drawer front locking

Options:

- must specify chassis grain direction on artisan veneer, see pages 13-15 for details
- veneer drawer fronts in paint available, specify paint color and add \$372 list; see page 16 for details
- on laminate units, contrasting door front available, no upcharge; specify color, see page 16 for details
- ledge pulls standard; prism pulls available, specify and see page 9
- power unit (2 simplex and 2 USB charging ports) available, specify and add \$1,008 list; see page 38 for details

To Order, Specify:

① Laminate Model #	② Laminate Selection		③ Metal Color	④ Other Product Options	
Laminate (FLT)	See Laminate Selection		See Metal Finish Color Options	See list of options for each specific unit; Specify and add accordingly.	
① Veneer Model #	② Wood Collection	③ Wood Finish		④ Metal Color	⑤ Other Product Options
Veneer (FLV)	Essentials	See Essentials Wood Finish Options		See Metal Finish Color Options	See list of options for each specific unit; Specify and add accordingly.
	Artisan	See Artisan Wood Finish Options	③b Chassis Grain Direction		
				For Artisan Only: Vertical Horizontal	

Description	D	W	H	CTN WT	CU FT	① Model	Laminate	Essentials Veneer	Artisan Veneer
81" h Box/File, Storage Cabinet with Side Wardrobe	22	24	81	275	30	FLT2224-81F5DWR	\$3,421		
	22	24	81	275	30	FLV2224-81F5DWR		\$5,463	\$6,010
	22	24	81	275	30	FLT2224-81F5DWL	\$3,421		
	22	24	81	275	30	FLV2224-81F5DWL		\$5,463	\$6,010

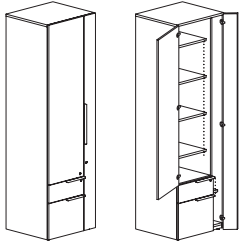

right shown

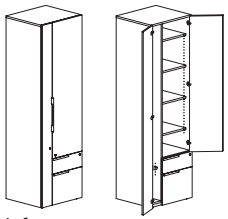

left

Features:

- aligns with secondary height units
- pedestal front locking
- upper compartment has four adjustable shelves
- installed coat hook in wardrobe compartment

Options:

- must specify chassis grain direction on artisan veneer, see pages 13-15 for details
- veneer door and drawer front in paint available, specify paint color and add \$372; see page 16 for details
- on laminate units, contrasting door and drawer fronts available, no upcharge; specify color, see page 16 for details
- locking doors available, specify and add \$306 list
- ledge pulls standard; prism pulls available, specify and see page 9

81" h Box/File, Open Storage Cabinet with Side Wardrobe	22	24	81	250	30	FLT2224-81F50WR	\$3,305		
	22	24	81	250	30	FLV2224-81F50WR		\$5,289	\$5,819
	22	24	81	250	30	FLT2224-81F50WL	\$3,305		
	22	24	81	250	30	FLV2224-81F50WL		\$5,289	\$5,819

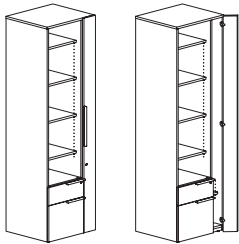

right shown

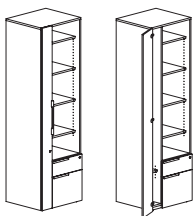

left

Features:

- aligns with secondary height units
- pedestal front locking
- upper compartment has four adjustable shelves
- installed coat hook in wardrobe compartment

Options:

- must specify chassis grain direction on artisan veneer, see pages 13-15 for details
- veneer door and drawer front in paint available, specify paint color and add \$372; see page 16 for details
- on laminate units, contrasting door and drawer fronts available, no upcharge; specify color, see page 16 for details
- locking door available, specify and add \$153 list
- ledge pulls standard; prism pulls available, specify and see page 9

Description	D	W	H	CTN WT	CU FT	① Model	Laminate	Essentials Veneer	Artisan Veneer
81" h Lower and Upper Hinge Door Storage Cabinet with Side Wardrobe	22	24	81	260	30	FLT2224-81F8DWR	\$2,744		
	22	24	81	260	30	FLV2224-81F8DWR		\$4,704	\$5,175
	22	24	81	260	30	FLT2224-81F8DWL	\$2,744		
	22	24	81	260	30	FLV2224-81F8DWL		\$4,704	\$5,175

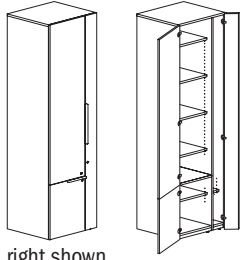

right shown

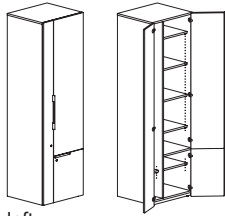

left

Features:

- aligns with secondary height units
- upper compartment has three adjustable shelves, lower compartment has one adjustable shelf
- installed coat hook in wardrobe compartment

Options:

- must specify chassis grain direction on artisan veneer, see pages 13-15 for details
- veneer door fronts in paint available, specify paint color and add \$372 list; see page 16 for detail
- on laminate units, contrasting doors fronts available, no upcharge; specify color, see page 16 for details
- locking doors available, specify and add \$459 list
- ledge pulls standard; prism pulls available, specify and see page 9
- vanity mirror available, specify and add \$157 list

81" h Lower Hinge Door, Open Storage Cabinet with Side Wardrobe	22	24	81	236	30	FLT2224-81F80WR	\$2,622		
	22	24	81	236	30	FLV2224-81F80WR		\$4,532	\$4,987
	22	24	81	236	30	FLT2224-81F80WL	\$2,622		
	22	24	81	236	30	FLV2224-81F80WL		\$4,532	\$4,987

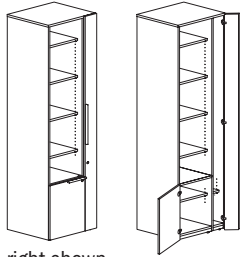

right shown

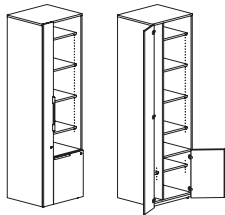

left

Features:

- aligns with secondary height units
- upper compartment has four adjustable shelves
- installed coat hook in wardrobe compartment

Options:

- must specify chassis grain direction on artisan veneer, see pages 13-15 for details
- veneer door fronts in paint available, specify paint color and add \$372 list; see page 16 for detail
- on laminate units, contrasting doors fronts available, no upcharge; specify color, see page 16 for details
- locking doors available, specify and add \$306 list
- ledge pulls standard; prism pulls available, specify and see page 9

To Order, Specify:

① Laminate Model #	② Laminate Type	③ Laminate Selection	④ Metal Color	⑤ Other Product Options
Laminate (FLT)	HPL	See Laminate Selection	See Metal Finish Color Options	See list of options for each specific unit; Specify and add accordingly.

① Veneer Model #	② Wood Collection	③ Wood Finish - Finishes with an asterisk (*) have a coordinating laminate available	④ Metal Color	⑤ Other Product Options		
Veneer (FLV)	Essentials	See Essentials Wood Finish Options	See Metal Finish Color Options	See list of options for each specific unit; Specify and add accordingly.		
	Artisan	<table border="1"> <thead> <tr> <th>③a Wood Finish</th> <th>③b Chassis Grain Direction</th> </tr> </thead> <tbody> <tr> <td>See Artisan Wood Finish Options</td> <td>For Artisan Only: Vertical Horizontal</td> </tr> </tbody> </table>	③a Wood Finish		③b Chassis Grain Direction	See Artisan Wood Finish Options
③a Wood Finish	③b Chassis Grain Direction					
See Artisan Wood Finish Options	For Artisan Only: Vertical Horizontal					

Description	D	W	H	CTN WT	CU FT	① Model	Laminate	Essentials Veneer	Artisan Veneer
69" h Box/File, Storage Cabinet with Side Wardrobe	22	24	69	233	26	FLT2224-69F5DWR	\$3,209		
	22	24	69	233	26	FLV2224-69F5DWR		\$5,160	\$5,676
	22	24	69	233	26	FLT2224-69F5DWL	\$3,209		
	22	24	69	233	26	FLV2224-69F5DWL		\$5,160	\$5,676

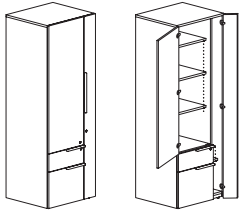

right shown

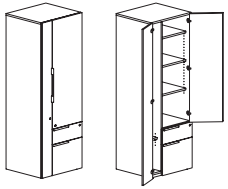

left

Features:

- aligns with secondary height units
- pedestal front locking
- upper compartment has three adjustable shelves
- installed coat hook in wardrobe compartment

Options:

- must specify chassis grain direction on artisan veneer, see pages 13-15 for details
- veneer door and drawer front in paint available, specify paint color and add \$372; see page 16 for details
- on laminate units, contrasting door and drawer fronts available, no upcharge; specify color, see page 16 for details
- locking doors available, specify and add \$306 list
- ledge pulls standard; prism pulls available, specify and see page 9
- vanity mirror available, specify and add \$157 list

69" h Box/File, Open Storage Cabinet with Side Wardrobe	22	24	69	214	26	FLT2224-69F50WR	\$3,116		
	22	24	69	214	26	FLV2224-69F50WR		\$5,023	\$5,527
	22	24	69	214	26	FLT2224-69F50WL	\$3,116		
	22	24	69	214	26	FLV2224-69F50WL		\$5,023	\$5,527

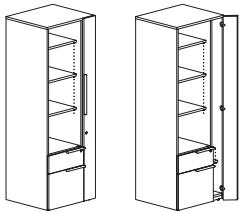

right shown

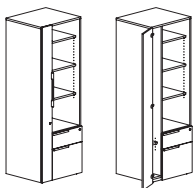

left

Features:

- aligns with secondary height units
- pedestal front locking
- upper compartment has three adjustable shelves
- installed coat hook in wardrobe compartment

Options:

- must specify chassis grain direction on artisan veneer, see pages 13-15 for details
- veneer door and drawer front in paint available, specify paint color and add \$372; see page 16 for details
- on laminate units, contrasting door and drawer fronts available, no upcharge; specify color, see page 16 for details
- locking side door available, specify and add \$153 list
- ledge pulls standard; prism pulls available, specify and see page 9

Description	D	W	H	CTN WT	CU FT	① Model	Laminate	Essentials Veneer	Artisan Veneer
69" h Lower and Upper Hinge Door Storage Cabinet with Side Wardrobe	22	24	69	219	26	FLT2224-69F8DWR	\$2,531		
	22	24	69	219	26	FLV2224-69F8DWR		\$4,402	\$4,844
	22	24	69	219	26	FLT2224-69F8DWL	\$2,531		
	22	24	69	219	26	FLV2224-69F8DWL		\$4,402	\$4,844

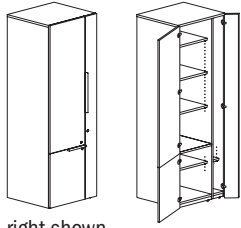

right shown

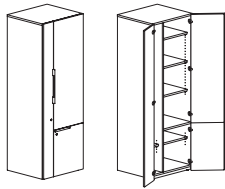

left

Features:

- aligns with secondary height units
- upper compartment has three adjustable shelves, lower compartment has one adjustable shelf
- installed coat hook in wardrobe compartment

Options:

- must specify chassis grain direction on artisan veneer, see pages 13-15 for details
- veneer door fronts in paint available, specify paint color and add \$372 list; see page 16 for detail
- on laminate units, contrasting door and drawer fronts available, no upcharge; specify color, see page 16 for details
- locking doors available, specify and add \$459 list
- ledge pulls standard; prism pulls available, specify and see page 9
- vanity mirror available, specify and add \$157 list

69" h Lower Hinge Door, Open Storage Cabinet with Side Wardrobe	22	24	69	199	26	FLT2224-69F8OWR	\$2,435		
	22	24	69	199	26	FLV2224-69F8OWR		\$4,265	\$4,690
	22	24	69	199	26	FLT2224-69F8OWL	\$2,435		
	22	24	69	199	26	FLV2224-69F8OWL		\$4,265	\$4,690

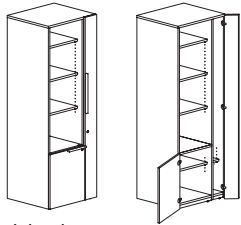

right shown

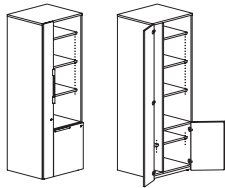

left

Features:

- aligns with secondary height units
- upper compartment has three adjustable shelves, lower compartment has one adjustable shelf
- installed coat hook in wardrobe compartment

Options:

- must specify chassis grain direction on artisan veneer, see pages 13-15 for details
- veneer door fronts in paint available, specify paint color and add \$372 list; see page 16 for detail
- on laminate units, contrasting doors fronts available, no upcharge; specify color, see page 16 for details
- locking doors available, specify and add \$306 list
- ledge pulls standard; prism pulls available, specify and see page 9

To Order, Specify:

① Laminate Model #		② Laminate Selection		③ Metal Color	④ Other Product Options
Laminate (FLT)		See Laminate Selection		See Metal Finish Color Options	See list of options for each specific unit; Specify and add accordingly.
① Veneer Model #	② Wood Collection	③ Wood Finish		④ Metal Color	⑤ Other Product Options
Veneer (FLV)	Essentials	See Essentials Wood Finish Options		See Metal Finish Color Options	See list of options for each specific unit; Specify and add accordingly.
	Artisan	3a Wood Finish See Artisan Wood Finish Options	3b Chassis Grain Direction For Artisan Only: Vertical Horizontal		

Description	D	W	H	CTN WT	CU FT	① Model	Laminate	Essentials Veneer	Artisan Veneer
81" h Box/ File Lateral, Storage Cabinet	22	36	81	342	44	FLT2236-81F6D	\$3,627		
	22	36	81	342	44	FLV2236-81F6D		\$5,798	\$6,378
	22	30	81	296	37	FLT2230-81F6D	\$3,428		
	22	30	81	296	37	FLV2230-81F6D		\$5,538	\$6,089

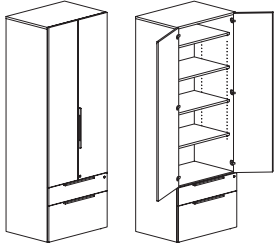

Features:

- aligns with secondary height units
- pedestal front locking
- upper compartment has four adjustable shelves

Options:

- must specify chassis grain direction on artisan veneer, see pages 13-15 for details
- veneer door and drawer front in paint available, specify paint color and add \$372; see page 16 for details
- on laminate units, contrasting door and drawer fronts available, no upcharge; specify color, see page 16 for details
- locking door available, specify and add \$153 list
- ledge pulls standard; prism pulls available, specify and see page 9

81" h Box/ File Lateral, Open Storage Cabinet	22	36	81	293	44	FLT2236-81F60	\$3,408		
	22	36	81	293	44	FLV2236-81F60		\$5,508	\$6,061
	22	30	81	255	37	FLT2230-81F60	\$3,226		
	22	30	81	255	37	FLV2230-81F60		\$5,265	\$5,792

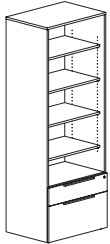

Features:

- aligns with secondary height units
- pedestal front locking
- upper compartment has four adjustable shelves

Options:

- must specify chassis grain direction on artisan veneer, see pages 13-15 for details
- veneer drawer fronts in paint available, specify paint color and add \$372 list; see page 16 for details
- on laminate units, contrasting drawer fronts available, no upcharge; specify color, see page 16 for details
- locking door available, specify and add \$153 list
- ledge pulls standard; prism pulls available, specify and see page 9

FLUX

Description	D	W	H	CTN WT	CU FT	① Model	Laminate	Essentials Veneer	Artisan Veneer
81" h Lower and Upper Hinge Door Storage Cabinet	22	36	81	324	44	FLT2236-81F8D	\$3,007		
	22	36	81	324	44	FLV2236-81F8D		\$5,136	\$5,649
	22	30	81	281	37	FLT2230-81F8D	\$2,823		
	22	30	81	281	37	FLV2230-81F8D		\$4,901	\$5,390

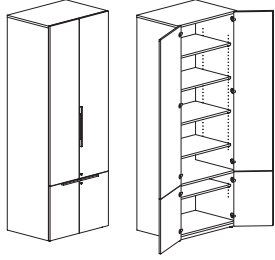

Features:

- aligns with secondary height units
- upper compartment has four adjustable shelves, lower compartment has one adjustable shelf

Options:

- must specify chassis grain direction on artisan veneer, see pages 13-15 for details
- veneer door fronts in paint available, specify paint color and add \$372 list; see page 16 for details
- on laminate units, contrasting doors fronts available, no upcharge; specify color, see page 16 for details
- locking doors available, specify and add \$306 list
- ledge pulls standard, mounted vertical; prism pulls available, specify and see page 9

81" h Lower Hinge Doors, Open Storage Cabinet	22	36	81	275	44	FLT2236-81F80	\$2,787		
	22	36	81	275	44	FLV2236-81F80		\$4,849	\$5,333
	22	30	81	240	37	FLT2230-81F80	\$2,617		
	22	30	81	240	37	FLV2230-81F80		\$4,630	\$5,093

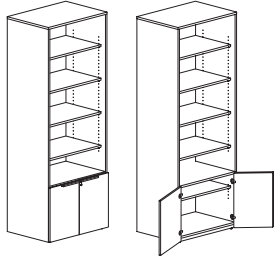

Features:

- aligns with secondary height units
- upper compartment has four adjustable shelves, lower compartment has one adjustable shelf

Options:

- must specify chassis grain direction on artisan veneer, see pages 13-15 for details
- veneer door fronts in paint available, specify paint color and add \$372 list; see page 16 for details
- on laminate units, contrasting doors fronts available, no upcharge; specify color, see page 16 for details
- locking doors available, specify and add \$153 list
- ledge pulls standard; prism pulls available, specify and see page 9

To Order, Specify:

① Laminate Model #		② Laminate Selection		③ Metal Color	④ Other Product Options
Laminate (FLT)		See Laminate Selection		See Metal Finish Color Options	See list of options for each specific unit; Specify and add accordingly.
① Veneer Model #	② Wood Collection	③ Wood Finish		④ Metal Color	⑤ Other Product Options
Veneer (FLV)	Essentials	See Essentials Wood Finish Options		See Metal Finish Color Options	See list of options for each specific unit; Specify and add accordingly.
	Artisan	③a Wood Finish See Artisan Wood Finish Options	③b Chassis Grain Direction For Artisan Only: Vertical Horizontal		

FLUX

Description	D	W	H	CTN WT	CU FT	① Model	Laminate	Essentials Veneer	Artisan Veneer
69"h Box/File Lateral, Storage Cabinet	22	36	69	292	38	FLT2236-69F6D	\$3,301		
	22	36	69	292	38	FLV2236-69F6D		\$5,331	\$5,862
	22	30	69	205	32	FLT2230-69F6D	\$3,132		
	22	30	69	205	32	FLV2230-69F6D		\$5,112	\$5,622

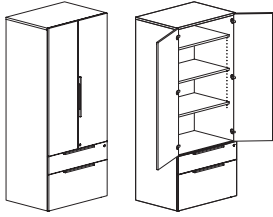

Features:

- aligns with secondary height units
- pedestal front locking
- upper compartment has three adjustable shelves

Options:

- must specify chassis grain direction on artisan veneer, see pages 13-15 for details
- veneer door and drawer front in paint available, specify paint color and add \$372; see page 16 for details
- on laminate units, contrasting door and drawer fronts available, no upcharge; specify color, see page 16 for details
- locking upper doors available, specify and add \$153 list
- ledge pulls standard; prism pulls available, specify and see page 9

69"h Box/File Lateral, Open Storage Cabinet	22	36	69	261	38	FLT2236-69F60	\$3,119		
	22	36	69	261	38	FLV2236-69F60		\$5,096	\$5,606
	22	30	69	235	32	FLT2230-69F60	\$2,961		
	22	36	69	235	32	FLV2230-69F60		\$4,892	\$5,383

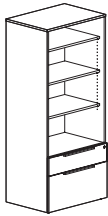

Features:

- aligns with secondary height units
- pedestal front locking
- upper compartment has three adjustable shelves

Options:

- must specify chassis grain direction on artisan veneer, see pages 13-15 for details
- veneer drawer fronts in paint available, specify paint color and add \$372 list; see page 16 for details
- on laminate units, contrasting drawer fronts available, no upcharge; specify color, see page 16 for details
- ledge pulls standard; prism pulls available, specify and see page 9

FLUX

Description	D	W	H	CTN WT	CU FT	① Model	Laminate	Essentials Veneer	Artisan Veneer
69" h Lower and Upper Hinge Door Storage Cabinet	22	36	69	235	38	FLT2236-69F8D	\$2,679		
	22	36	69	235	38	FLV2236-69F8D		\$4,669	\$5,136
	22	30	69	232	32	FLT2230-69F8D	\$2,526		
	22	30	69	232	32	FLV2230-69F8D		\$4,475	\$4,923

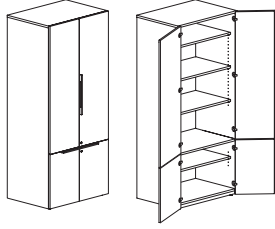

Features:

- aligns with secondary height units
- upper compartment has three adjustable shelves, lower compartment has one adjustable shelf

Options:

- must specify chassis grain direction on artisan veneer, see pages 13-15 for details
- veneer door fronts in paint available, specify paint color and add \$372 list; see page 16 for details
- on laminate units, contrasting doors fronts available, no upcharge; specify color, see page 16 for details
- locking doors available, specify and add \$306 list
- ledge pulls standard; prism pulls available, specify and see page 9

69" h Lower Hinge Doors, Open Storage Cabinet	22	36	69	216	38	FLT2236-69F80	\$2,497		
	22	36	69	216	38	FLV2236-69F80		\$4,437	\$4,879
	22	30	69	199	32	FLT2230-69F80	\$2,355		
	22	30	69	199	32	FLV2230-69F80		\$4,253	\$4,682

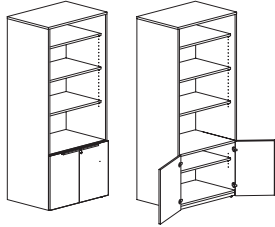

Features:

- aligns with secondary height units
- upper compartment has three adjustable shelves, lower compartment has one adjustable shelf

Options:

- must specify chassis grain direction on artisan veneer, see pages 13-15 for details
- veneer door fronts in paint available, specify paint color and add \$372 list; see page 16 for details
- on laminate units, contrasting doors fronts available, no upcharge; specify color, see page 16 for details
- locking lower doors available specify and add \$153 list
- ledge pulls standard; prism pulls available, specify and see page 9

To Order, Specify:

① Laminate Model #		② Laminate Selection		③ Metal Color	④ Other Product Options
Laminate (FLT)		See Laminate Selection		See Metal Finish Color Options	See list of options for each specific unit; Specify and add accordingly.
① Veneer Model #	② Wood Collection	③ Wood Finish		④ Metal Color	⑤ Other Product Options
Veneer (FLV)	Essentials	See Essentials Wood Finish Options		See Metal Finish Color Options	
	Artisan	③a Wood Finish	③b Chassis Grain Direction		
		See Artisan Wood Finish Options	For Artisan Only: Vertical Horizontal		

Description	D	W	H	CTN WT	CU FT	① Model	Laminate	Essentials Veneer	Artisan Veneer
81" h Box/File, Storage Cabinet	22	18	81	210	24	FLT2218-81F5DR	\$2,691		
	22	18	81	210	24	FLV2218-81F5DR		\$4,282	\$4,711
	22	18	81	210	24	FLT2218-81F5DL	\$2,691		
	22	18	81	210	24	FLV2218-81F5DL		\$4,282	\$4,711

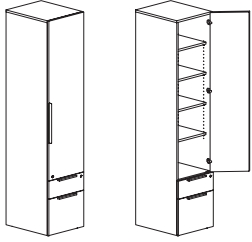

right shown

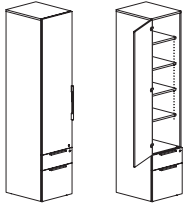

left

Features:

- aligns with secondary height units
- pedestal front locking
- upper compartment has four adjustable shelves

Options:

- must specify chassis grain direction on artisan veneer, see pages 13-15 for details
- veneer door and drawer front in paint available, specify paint color and add \$372; see page 16 for details
- on laminate units, contrasting door and drawer fronts available, no upcharge; specify color, see page 16 for details
- locking door available, specify and add \$153 list
- ledge pulls standard; prism pulls available, specify and see page 9
- vanity mirror available, specify and add \$157 list

81" h Box/File, Open Storage Cabinet	22	18	81	185	24	FLT2218-81F50	\$2,571		
	22	18	81	185	24	FLV2218-81F50		\$4,108	\$4,520

Features:

- aligns with secondary height units
- pedestal front locking
- upper compartment has four adjustable shelves

Options:

- must specify chassis grain direction on artisan veneer, see pages 13-15 for details
- veneer drawer fronts in paint available, specify paint color and add \$372 list; see page 16 for details
- on laminate units, contrasting drawer fronts available, no upcharge; specify color, see page 16 for details
- ledge pulls standard; prism pulls available, specify and see page 9

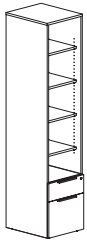

FLUX

Description	D	W	H	CTN WT	CU FT	① Model	Laminate	Essentials Veneer	Artisan Veneer
81" h Lower and Upper Hinge Door Storage Cabinet	22	18	81	188	24	FLT2218-81F8DR	\$2,107		
	22	18	81	188	24	FLV2218-81F8DR		\$3,660	\$4,027
	22	18	81	188	24	FLT2218-81F8DL	\$2,107		
	22	18	81	188	24	FLV2218-81F8DL		\$3,660	\$4,027

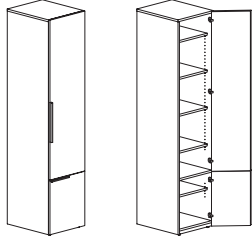

right shown

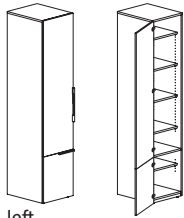

left

Features:

- aligns with secondary height units
- upper compartment has four adjustable shelves, lower compartment has one adjustable shelf

Options:

- must specify chassis grain direction on artisan veneer, see pages 13-15 for details
- veneer door fronts in paint available, specify paint color and add \$372 list; see page 16 for details
- on laminate units, contrasting doors fronts available, no upcharge; specify color, see page 16 for details
- locking doors available, specify and add \$306 list
- ledge pulls standard, mounted vertical; prism pulls available, specify and see page 9
- vanity mirror available, specify and add \$157 list

81" h Lower Hinge Door, Open Storage Cabinet	22	18	81	170	24	FLT2218-81F80R	\$1,989		
	22	18	81	170	24	FLV2218-81F80R		\$3,488	\$3,836
	22	18	81	170	24	FLT2218-81F80L	\$1,989		
	22	18	81	170	24	FLV2218-81F80L		\$3,488	\$3,836

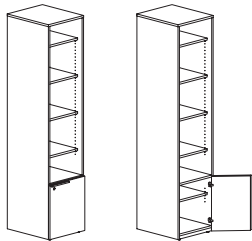

right shown

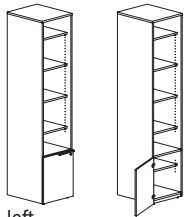

left

Features:

- aligns with secondary height units
- upper compartment has four adjustable shelves

Options:

- must specify chassis grain direction on artisan veneer, see pages 13-15 for details
- veneer door front in paint available, specify paint color and add \$372 list; see page 16 for details
- on laminate units, contrasting doors fronts available, no upcharge; specify color, see page 16 for details
- locking lower door available, specify and add \$153 list
- ledge pulls standard; prism pulls available, specify and see page 9

To Order, Specify:

① Laminate Model #		② Laminate Selection		③ Metal Color	④ Other Product Options
Laminate (FLT)		See Laminate Selection		See Metal Finish Color Options	See list of options for each specific unit; Specify and add accordingly.
① Veneer Model #	② Wood Collection	③ Wood Finish		④ Metal Color	⑤ Other Product Options
Veneer (FLV)	Essentials	See Essentials Wood Finish Options		See Metal Finish Color Options	
	Artisan	ⓐ Wood Finish	ⓑ Chassis Grain Direction		
		See Artisan Wood Finish Options	For Artisan Only: Vertical Horizontal		

Description	D	W	H	CTN WT	CU FT	① Model	Laminate	Essentials Veneer	Artisan Veneer
69"h Box/File, Storage Cabinet	22	18	69	183	20	FLT2218-69F5DR	\$2,478		
	22	18	69	183	20	FLV2218-69F5DR		\$3,978	\$4,376
	22	18	69	183	20	FLT2218-69F5DL	\$2,478		
	22	18	69	183	20	FLV2218-69F5DL		\$3,978	\$4,376

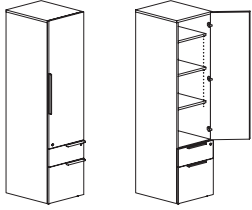

right shown

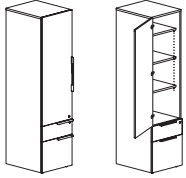

left

Features:

- aligns with secondary height units
- pedestal front locking
- upper compartment has three adjustable shelves

Options:

- must specify chassis grain direction on artisan veneer, see pages 13-15 for details
- veneer door and drawer front in paint available, specify paint color and add \$372; see page 16 for details
- on laminate units, contrasting door and drawer fronts available, no upcharge; specify color, see page 16 for details
- locking upper door available, specify and add \$153 list
- ledge pulls standard; prism pulls available, specify and see page 9
- vanity mirror available, specify and add \$157 list

69"h Box/File, Open Storage Cabinet	22	18	69	163	20	FLT2218-69F50	\$2,384		
	22	18	69	163	20	FLV2218-69F50		\$3,840	\$4,226

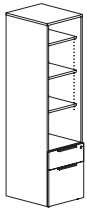

Features:

- aligns with secondary height units
- pedestal front locking
- upper compartment has three adjustable shelves

Options:

- must specify chassis grain direction on artisan veneer, see pages 13-15 for details
- veneer drawer fronts in paint available, specify paint color and add \$372 list; see page 16 for details
- on laminate units, contrasting drawer fronts available, no upcharge; specify color, see page 16 for details
- ledge pulls standard; prism pulls available, specify and see page 9

FLUX

Description	D	W	H	CTN WT	CU FT	① Model	Laminate	Essentials Veneer	Artisan Veneer
69" h Lower and Upper Hinge Door Storage Cabinet	22	18	69	168	20	FLT2218-69F8DR	\$1,896		
	22	18	69	168	20	FLV2218-69F8DR		\$3,359	\$3,693
	22	18	69	168	20	FLT2218-69F8DL	\$1,896		
	22	18	69	168	20	FLV2218-69F8DL		\$3,359	\$3,693

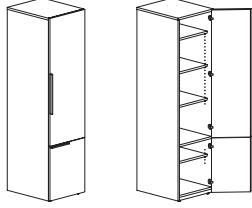

right shown

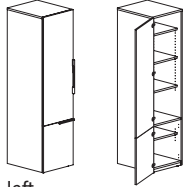

left

Features:

- aligns with secondary height units
- upper compartment has three adjustable shelves, lower compartment has one adjustable shelf

Options:

- must specify chassis grain direction on artisan veneer, see pages 13-15 for details
- veneer door fronts in paint available, specify paint color and add \$372 list; see page 16 for details
- on laminate units, contrasting doors fronts available, no upcharge; specify color, see page 16 for details
- locking doors available, specify and add \$306 list
- ledge pulls standard; prism pulls available, specify and see page 9

69" h Lower Hinge Door, Open Storage Cabinet	22	18	69	148	20	FLT2218-69F8OR	\$1,798		
	22	18	69	148	20	FLV2218-69F8OR		\$3,220	\$3,542
	22	18	69	148	20	FLT2218-69F8OL	\$1,798		
	22	18	69	148	20	FLV2218-69F8OL		\$3,220	\$3,542

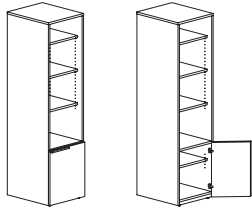

right shown

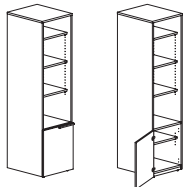

left

Features:

- aligns with secondary height units
- upper compartment has three adjustable shelves

Options:

- must specify chassis grain direction on artisan veneer, see pages 13-15 for details
- veneer door front in paint available, specify paint color and add \$372 list; see page 16 for details
- on laminate units, contrasting doors fronts available, no upcharge; specify color, see page 16 for details
- locking door available, specify and add \$153 list
- ledge pulls standard; prism pulls available, specify and see page 9

To Order, Specify:

① Laminate Model #		② Laminate Selection		③ Metal Color	④ Other Product Options
Laminate (FLT)		See Laminate Selection		See Metal Finish Color Options	See list of options for each specific unit; Specify and add accordingly.
① Veneer Model #	② Wood Collection	③ Wood Finish		④ Metal Color	⑤ Other Product Options
Veneer (FLV)	Essentials	See Essentials Wood Finish Options		See Metal Finish Color Options	
	Artisan	ⓐ Wood Finish	ⓑ Chassis Grain Direction		
		See Artisan Wood Finish Options	For Artisan Only: Vertical Horizontal		

Description	D	W	H	CTN WT	CU FT	① Model	Laminate	Essentials Veneer	Artisan Veneer
81" h Wardrobe	22	18	81	161	24	FLT2218-81LDWR	\$2,776		
	22	18	81	161	24	FLV2218-81LDWR		\$3,847	\$4,228
	22	18	81	161	24	FLT2218-81LDWL	\$2,776		
	22	18	81	161	24	FLV2218-81LDWL		\$3,847	\$4,228

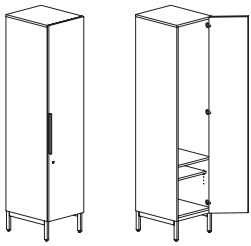

right shown



left

Features:

- lower adjustable shelf
- installed coat hooks

Options:

- must specify chassis grain direction on artisan veneer, see pages 13-15 for details
- veneer door front in paint available, specify paint color and add \$372 list; see page 16 for details
- on laminate units, contrasting doors fronts available, no upcharge; specify color, see page 16 for details
- locking door available, specify and add \$153 list
- ledge pulls standard, mounted vertical; prism pulls available, specify and see page 9
- vanity mirror available, specify and add \$157 list

81" h Storage Cabinet	22	18	81	187	24	FLT2218-81LDR	\$2,765		
	22	18	81	187	24	FLV2218-81LDR		\$3,835	\$4,220
	22	18	81	187	24	FLT2218-81LDL	\$2,765		
	22	18	81	187	24	FLV2218-81LDL		\$3,835	\$4,220

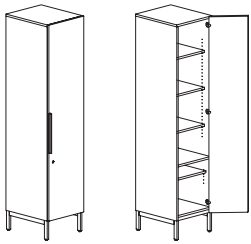

right shown

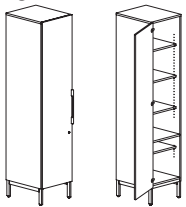

left

Features:

- five adjustable shelves

Options:

- must specify chassis grain direction on artisan veneer, see pages 13-15 for details
- veneer door fronts in paint available, specify paint color and add \$372 list; see page 16 for details
- on laminate units, contrasting doors fronts available, no upcharge; specify color, see page 16 for details
- locking door available, specify and add \$153 list
- ledge pulls standard, mounted vertical; prism pulls available, specify and see page 9
- vanity mirror available, specify and add \$157 list

Description	D	W	H	CTN WT	CU FT	① Model	Laminate	Essentials Veneer	Artisan Veneer
69" h Wardrobe	22	18	69	147	20	FLT2218-69LDWR	\$2,562		
	22	18	69	147	20	FLV2218-69LDWR		\$3,541	\$3,895
	22	18	69	147	20	FLT2218-69LDWL	\$2,562		
	22	18	69	147	20	FLV2218-69LDWL		\$3,541	\$3,895

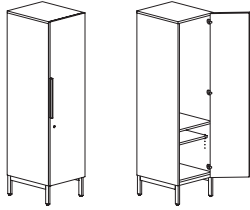

right shown

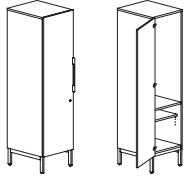

left

Features:

- lower adjustable shelf
- installed coat hooks

Options:

- must specify chassis grain direction on artisan veneer, see pages 13-15 for details
- veneer door front in paint available, specify paint color and add \$372 list; see page 16 for details
- on laminate units, contrasting doors fronts available, no upcharge; specify color, see page 16 for details
- locking door available, specify and add \$153 list
- ledge pulls standard, mounted vertical; prism pulls available, specify and see page 9
- vanity mirror available, specify and add \$157 list

69" h Storage Cabinet	22	18	69	159	20	FLT2218-69LDR	\$2,554		
	22	18	69	159	20	FLV2218-69LDR		\$3,533	\$3,887
	22	18	69	159	20	FLT2218-69LDL	\$2,554		
	22	18	69	159	20	FLV2218-69LDL		\$3,533	\$3,887

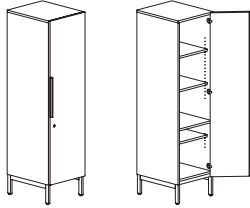

right shown

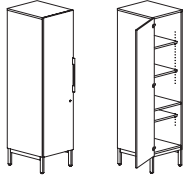

left

Features:

- four adjustable shelves

Options:

- must specify chassis grain direction on artisan veneer, see pages 13-15 for details
- veneer door front in paint available, specify paint color and add \$372 list; see page 16 for details
- on laminate units, contrasting doors fronts available, no upcharge; specify color, see page 16 for details
- locking door available, specify and add \$153 list
- ledge pulls standard, mounted vertical; prism pulls available, specify and see page 9
- vanity mirror available, specify and add \$157 list

To Order, Specify:

① Laminate Model #	② Laminate Selection	③ Metal Color	④ Other Product Options			
Laminate (FLT)	See Laminate Selection	See Metal Finish Color Options	See list of options for each specific unit; Specify and add accordingly.			
① Veneer Model #	② Wood Collection	③ Wood Finish	④ Metal Color	⑤ Other Product Options		
Veneer (FLV)	Essentials	See Essentials Wood Finish Options	See Metal Finish Color Options	See list of options for each specific unit; Specify and add accordingly.		
	Artisan	<table border="1"> <thead> <tr> <th>③a Wood Finish</th> <th>③b Chassis Grain Direction</th> </tr> </thead> <tbody> <tr> <td>See Artisan Wood Finish Options</td> <td>For Artisan Only: Vertical Horizontal</td> </tr> </tbody> </table>	③a Wood Finish		③b Chassis Grain Direction	See Artisan Wood Finish Options
③a Wood Finish	③b Chassis Grain Direction					
See Artisan Wood Finish Options	For Artisan Only: Vertical Horizontal					

Description	D	W	H	CTN WT	CU FT	① Model	Laminate	Essentials Veneer	Artisan Veneer
81" h Box/File, Storage Cabinet with Side Wardrobe	22	24	81	260	30	FLT2224-81L5DWR	\$4,194		
	22	24	81	260	30	FLV2224-81L5DWR		\$5,740	\$6,313
	22	24	81	260	30	FLT2224-81L5DWL	\$4,194		
	22	24	81	260	30	FLV2224-81L5DWL		\$5,740	\$6,313

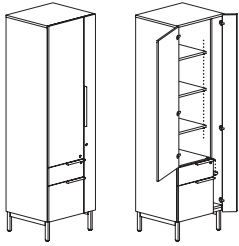

right shown

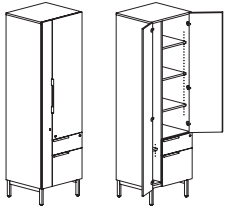

left

Features:

- aligns with primary height units
- pedestal front locking
- upper compartment has three adjustable shelves
- installed coat hook in wardrobe compartment

Options:

- must specify chassis grain direction on artisan veneer, see pages 13-15 for details
- veneer door and drawer front in paint available, specify paint color and add \$372; see page 16 for details
- on laminate units, contrasting door and drawer fronts available, no upcharge; specify color, see page 16 for details
- locking doors available, specify and add \$306 list
- ledge pulls standard; prism pulls available, specify and see page 9
- vanity mirror available, specify and add \$157 list

81" h Box/File, Open Storage Cabinet with Side Wardrobe	22	24	81	241	30	FLT2224-81L50WR	\$4,074		
	22	24	81	241	30	FLV2224-81L50WR		\$5,567	\$6,123
	22	24	81	241	30	FLT2224-81L50WL	\$4,074		
	22	24	81	241	30	FLV2224-81L50WL		\$5,567	\$6,123

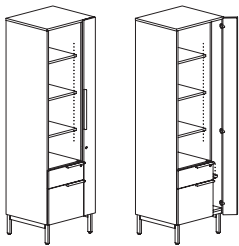

right shown

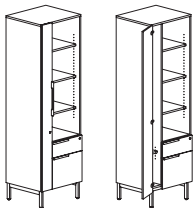

left

Features:

- aligns with primary height units
- pedestal front locking
- upper compartment has three adjustable shelves
- installed coat hook in wardrobe compartment

Options:

- must specify chassis grain direction on artisan veneer, see pages 13-15 for details
- veneer door and drawer front in paint available, specify paint color and add \$372; see page 16 for details
- on laminate units, contrasting door and drawer fronts available, no upcharge; specify color, see page 16 for details
- locking door available, specify and add \$153 list
- ledge pulls standard; prism pulls available, specify and see page 9

Description	D	W	H	CTN WT	CU FT	① Model	Laminate	Essentials Veneer	Artisan Veneer
81" Lower and Upper Hinge Door Storage Cabinet with Side Wardrobe	22	24	81	253	30	FLT2224-81L8DWR	\$3,512		
	22	24	81	253	30	FLV2224-81L8DWR		\$4,981	\$5,480
	22	24	81	253	30	FLT2224-81L8DWL	\$3,512		
	22	24	81	253	30	FLV2224-81L8DWL		\$4,981	\$5,480

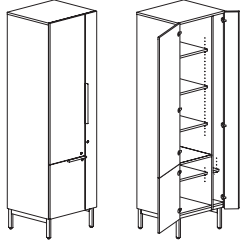

right shown

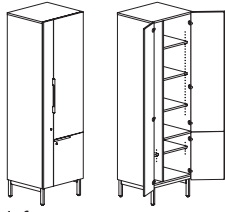

left

Features:

- aligns with primary height units
- upper compartment has three adjustable shelves, lower compartment has one adjustable shelf
- installed coat hook in wardrobe compartment

Options:

- must specify chassis grain direction on artisan veneer, see pages 13-15 for details
- veneer door fronts in paint available, specify paint color and add \$372 list; see page 16 for detail
- on laminate units, contrasting doors fronts available, no upcharge; specify color, see page 16 for details
- locking doors available, specify and add \$459 list
- ledge pulls standard; prism pulls available, specify and see page 9
- vanity mirror available, specify and add \$157 list

81" h Lower Hinge Door, Open Storage Cabinet with Side Wardrobe	22	24	81	226	30	FLT2224-81L80WR	\$3,394		
	22	24	81	226	30	FLV2224-81L80WR		\$4,807	\$5,288
	22	24	81	226	30	FLT2224-81L80WL	\$3,394		
	22	24	81	226	30	FLV2224-81L80WL		\$4,807	\$5,288

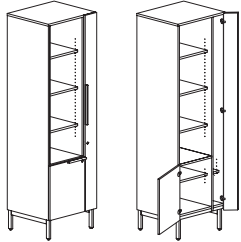

right shown

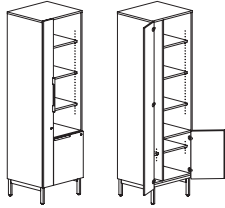

left

Features:

- aligns with primary height units
- upper compartment has two adjustable shelves, lower compartment has one adjustable shelf
- installed coat hook in wardrobe compartment

Options:

- must specify chassis grain direction on artisan veneer, see pages 13-15 for details
- veneer door fronts in paint available, specify paint color and add \$372 list; see page 16 for detail
- on laminate units, contrasting doors fronts available, no upcharge; specify color, see page 16 for details
- locking doors available, specify and add \$306 list
- ledge pulls standard; prism pulls available, specify and see page 9

To Order, Specify:

① Laminate Model #	② Laminate Type	③ Laminate Selection	④ Metal Color	⑤ Other Product Options
Laminate (FLT)	HPL	See Laminate Selection	See Metal Finish Color Options	See list of options for each specific unit; Specify and add accordingly.

① Veneer Model #	② Wood Collection	③ Wood Finish - Finishes with an asterisk (*) have a coordinating laminate available	④ Metal Color	⑤ Other Product Options		
Veneer (FLV)	Essentials	See Essentials Wood Finish Options	See Metal Finish Color Options	See list of options for each specific unit; Specify and add accordingly.		
	Artisan	<table border="1"> <thead> <tr> <th>③a Wood Finish</th> <th>③b Chassis Grain Direction</th> </tr> </thead> <tbody> <tr> <td>See Artisan Wood Finish Options</td> <td>For Artisan Only: Vertical Horizontal</td> </tr> </tbody> </table>	③a Wood Finish		③b Chassis Grain Direction	See Artisan Wood Finish Options
③a Wood Finish	③b Chassis Grain Direction					
See Artisan Wood Finish Options	For Artisan Only: Vertical Horizontal					

Description	D	W	H	CTN WT	CU FT	① Model	Laminate	Essentials Veneer	Artisan Veneer
69"h Box/File, Storage Cabinet with Side Wardrobe	22	24	69	236	26	FLT2224-69L5DWR	\$3,979		
	22	24	69	236	26	FLV2224-69L5DWR		\$5,435	\$5,980
	22	24	69	236	26	FLT2224-69L5DWL	\$3,979		
	22	24	69	236	26	FLV2224-69L5DWL		\$5,435	\$5,980

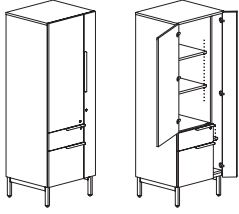

right shown

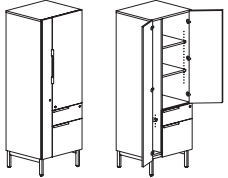

left

Features:

- aligns with primary height units
- pedestal front locking
- upper compartment has two adjustable shelves
- installed coat hook in wardrobe compartment

Options:

- must specify chassis grain direction on artisan veneer, see pages 13-15 for details
- veneer door and drawer front in paint available, specify paint color and add \$372; see page 16 for details
- on laminate units, contrasting door and drawer fronts available, no upcharge; specify color, see page 16 for details
- locking doors available, specify and add \$306 list
- ledge pulls standard; prism pulls available, specify and see page 9
- vanity mirror available, specify and add \$157 list

69"h Box/File, Open Storage Cabinet with Side Wardrobe	22	24	69	208	26	FLT2224-69L50WR	\$3,885		
	22	24	69	208	26	FLV2224-69L50WR		\$5,300	\$5,830
	22	24	69	208	26	FLT2224-69L50WL	\$3,885		
	22	24	69	208	26	FLV2224-69L50WL		\$5,300	\$5,830

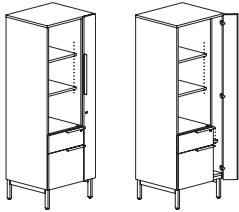

right shown

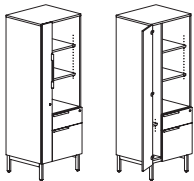

left

Features:

- aligns with primary height units
- pedestal front locking
- upper compartment has two adjustable shelves
- installed coat hook in wardrobe compartment

Options:

- must specify chassis grain direction on artisan veneer, see pages 13-15 for details
- veneer door and drawer front in paint available, specify paint color and add \$372; see page 16 for details
- on laminate units, contrasting door and drawer fronts available, no upcharge; specify color, see page 16 for details
- locking door available, specify and add \$153 list
- ledge pulls standard; prism pulls available, specify and see page 9

FLUX

Description	D	W	H	CTN WT	CU FT	① Model	Laminate	Essentials Veneer	Artisan Veneer
69" h Lower and Upper Hinge Door Storage Cabinet with Side Wardrobe	22	24	69	224	26	FLT2224-69L8DWR	\$3,301		
	22	24	69	224	26	FLV2224-69L8DWR		\$4,679	\$5,144
	22	24	69	224	26	FLT2224-69L8DWL	\$3,301		
	22	24	69	224	26	FLV2224-69L8DWL		\$4,679	\$5,144

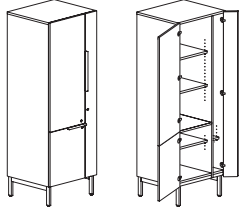

right shown

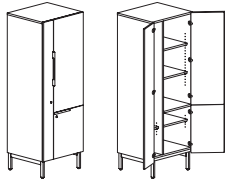

left

Features:

- aligns with primary height units
- upper compartment has two adjustable shelves, lower compartment has one adjustable shelf
- installed coat hook in wardrobe compartment

Options:

- must specify chassis grain direction on artisan veneer, see pages 13-15 for details
- veneer door fronts in paint available, specify paint color and add \$372 list; see page 16 for detail
- on laminate units, contrasting doors fronts available, no upcharge; specify color, see page 16 for details
- locking doors available, specify and add \$459 list
- ledge pulls standard; prism pulls available, specify and see page 9
- vanity mirror available, specify and add \$157 list

69" h Lower Hinge Door, Open Storage Cabinet with Side Wardrobe	22	24	69	202	26	FLT2224-69L80WR	\$3,204		
	22	24	69	202	26	FLV2224-69L80WR		\$4,539	\$4,993
	22	24	69	202	26	FLT2224-69L80WL	\$3,204		
	22	24	69	202	26	FLV2224-69L80WL		\$4,539	\$4,993

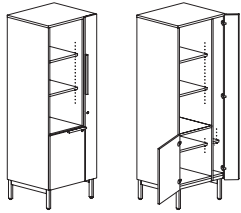

right shown

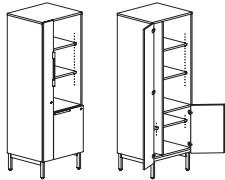

left

Features:

- aligns with primary height units
- upper compartment has two adjustable shelves, lower compartment has one adjustable shelf
- installed coat hook in wardrobe compartment

Options:

- must specify chassis grain direction on artisan veneer, see pages 13-15 for details
- veneer door fronts in paint available, specify paint color and add \$372 list; see page 16 for detail
- on laminate units, contrasting doors fronts available, no upcharge; specify color, see page 16 for details
- locking doors available, specify and add \$306 list
- ledge pulls standard; prism pulls available, specify and see page 9

To Order, Specify:

① Laminate Model #	② Laminate Selection	③ Metal Color	④ Other Product Options
Laminate (FLT)	See Laminate Selection	See Metal Finish Color Options	See list of options for each specific unit; Specify and add accordingly.

① Veneer Model #	② Wood Collection	③ Wood Finish	④ Metal Color	⑤ Other Product Options		
Veneer (FLV)	Essentials	See Essentials Wood Finish Options	See Metal Finish Color Options	See list of options for each specific unit; Specify and add accordingly.		
	Artisan	<table border="1"> <thead> <tr> <th>③a Wood Finish</th> <th>③b Chassis Grain Direction</th> </tr> </thead> <tbody> <tr> <td>See Artisan Wood Finish Options</td> <td>For Artisan Only: Vertical Horizontal</td> </tr> </tbody> </table>	③a Wood Finish		③b Chassis Grain Direction	See Artisan Wood Finish Options
③a Wood Finish	③b Chassis Grain Direction					
See Artisan Wood Finish Options	For Artisan Only: Vertical Horizontal					

Description	D	W	H	CTN WT	CU FT	① Model	Laminate	Essentials Veneer	Artisan Veneer
81" h Side Access Wardrobe with Open Shelves	15 7/8	36	81	203	32	FLT1636-81LSWR	\$3,009		
	15 7/8	36	81	203	32	FLV1636-81LSWR		\$4,601	\$5,060
	15 7/8	36	81	203	32	FLT1636-81LSWL	\$3,009		
	15 7/8	36	81	203	32	FLV1636-81LSWL		\$4,601	\$5,060
	15 7/8	30	81	178	27	FLT1630-81LSWR	\$2,803		
	15 7/8	30	81	178	27	FLV1630-81LSWR		\$4,258	\$4,685
	15 7/8	30	81	178	27	FLT1630-81LSWL	\$2,803		
	15 7/8	30	81	178	27	FLV1630-81LSWL		\$4,258	\$4,685

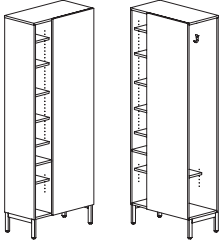

right shown

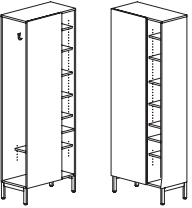

left

Features:

- side entry wardrobe with two installed coat hooks and one lower adjustable shelf
- 8 1/4" w open compartment with five adjustable shelves

Options:

- must specify chassis grain direction on artisan veneer, see pages 13-15 for details

Description	D	W	H	CTN WT	CU FT	① Model	Laminate	Essentials Veneer	Artisan Veneer
69" h Side Access Wardrobe with Open Shelves	15 7/8	36	69	172	27	FLT1636-69LSWR	\$2,798		
	15 7/8	36	69	172	27	FLV1636-69LSWR		\$4,295	\$4,728
	15 7/8	36	69	172	27	FLT1636-69LSWL	\$2,798		
	15 7/8	36	69	172	27	FLV1636-69LSWL		\$4,295	\$4,728
	15 7/8	30	69	147	23	FLT1630-69LSWR	\$2,609		
	15 7/8	30	69	147	23	FLV1630-69LSWR		\$3,973	\$4,371
	15 7/8	30	69	147	23	FLT1630-69LSWL	\$2,609		
	15 7/8	30	69	147	23	FLV1630-69LSWL		\$3,973	\$4,371

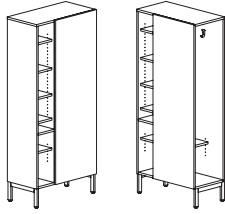

right shown

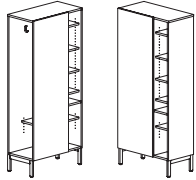

left

Features:

- side entry wardrobe with two installed coat hooks and one lower adjustable shelf
- 8 1/4" w open compartment with four adjustable shelves

Options:

- must specify chassis grain direction on artisan veneer, see pages 13-15 for details

To Order, Specify:

① Laminate Model #	② Laminate Selection		③ Metal Color	④ Other Product Options	
Laminate (FLT)	See Laminate Selection		See Metal Finish Color Options	See list of options for each specific unit; Specify and add accordingly.	
① Veneer Model #	② Wood Collection	③ Wood Finish		④ Metal Color	⑤ Other Product Options
Veneer (FLV)	Essentials	See Essentials Wood Finish Options		See Metal Finish Color Options	See list of options for each specific unit; Specify and add accordingly.
	Artisan	③a Wood Finish See Artisan Wood Finish Options	③b Chassis Grain Direction For Artisan Only: Vertical Horizontal		

FLUX

Description	D	W	H	CTN WT	CU FT	① Model	Laminate	Essentials Veneer	Artisan Veneer
81" h Box/File Lateral, Storage Cabinet	22	36	81	305	44	FLT2236-81L6D	\$4,397		
	22	36	81	305	44	FLV2236-81L6D		\$6,075	\$6,681
	22	30	81	284	37	FLT2230-81L6D	\$4,197		
	22	30	81	284	37	FLV2230-81L6D		\$5,813	\$6,394

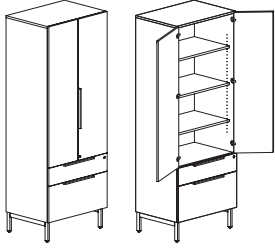

Features:

- aligns with primary height units
- pedestal front locking
- upper compartment has three adjustable shelves

Options:

- must specify chassis grain direction on artisan veneer, see pages 13-15 for details
- veneer door and drawer front in paint available, specify paint color and add \$372; see page 16 for details
- on laminate units, contrasting door and drawer fronts available, no upcharge; specify color, see page 16 for details
- locking door available, specify and add \$153 list
- ledge pulls standard; prism pulls available, specify and see page 9

81" h Box/File Lateral, Open Storage Cabinet	22	36	81	270	44	FLT2236-81L60	\$4,177		
	22	36	81	270	44	FLV2236-81L60		\$5,786	\$6,367
	22	30	81	247	37	FLT2230-81L60	\$3,995		
	22	30	81	247	37	FLV2230-81L60		\$5,543	\$6,098

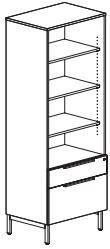

Features:

- aligns with primary height units
- pedestal front locking
- upper compartment has three adjustable shelves

Options:

- must specify chassis grain direction on artisan veneer, see pages 13-15 for details
- veneer drawer fronts in paint available, specify paint color and add \$372 list; see page 16 for details
- on laminate units, contrasting drawer fronts available, no upcharge; specify color, see page 16 for details
- ledge pulls standard; prism pulls available, specify and see page 9

FLUX

Description	D	W	H	CTN WT	CU FT	① Model	Laminate	Essentials Veneer	Artisan Veneer
81" h Lower and Upper Hinge Door Storage Cabinet	22	36	81	265	44	FLT2236-81L8D	\$3,775		
	22	36	81	265	44	FLV2236-81L8D		\$5,413	\$5,956
	22	30	81	248	37	FLT2230-81L8D	\$3,590		
	22	30	81	248	37	FLV2230-81L8D		\$5,177	\$5,694

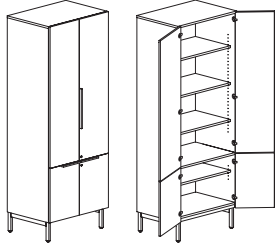

Features:

- aligns with primary height units
- upper compartment has three adjustable shelves, lower compartment has one adjustable shelf

Options:

- must specify chassis grain direction on artisan veneer, see pages 13-15 for details
- veneer door fronts in paint available, specify paint color and add \$372 list; see page 16 for details
- on laminate units, contrasting doors fronts available, no upcharge; specify color, see page 16 for details
- locking doors available, specify and add \$306 list
- ledge pulls standard; prism pulls available, specify and see page 9

81" h Lower Hinge Doors, Open Storage Cabinet	22	36	81	241	44	FLT2236-81L80	\$3,556		
	22	36	81	241	44	FLV2236-81L80		\$5,126	\$5,637
	22	30	81	224	37	FLT2230-81L80	\$3,386		
	22	30	81	224	37	FLV2230-81L80		\$4,905	\$5,399

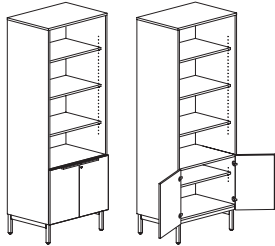

Features:

- aligns with primary height units
- upper compartment has three adjustable shelves, lower compartment has one adjustable shelf

Options:

- must specify chassis grain direction on artisan veneer, see pages 13-15 for details
- veneer door fronts in paint available, specify paint color and add \$372 list; see page 16 for details
- on laminate units, contrasting doors fronts available, no upcharge; specify color, see page 16 for details
- locking door available, specify and add \$153 list
- ledge pulls standard; prism pulls available, specify and see page 9

To Order, Specify:

① Laminate Model #		② Laminate Selection		③ Metal Color	④ Other Product Options
Laminate (FLT)		See Laminate Selection		See Metal Finish Color Options	See list of options for each specific unit; Specify and add accordingly.
① Veneer Model #	② Wood Collection	③ Wood Finish		④ Metal Color	⑤ Other Product Options
Veneer (FLV)	Essentials	See Essentials Wood Finish Options		See Metal Finish Color Options	See list of options for each specific unit; Specify and add accordingly.
	Artisan	③a Wood Finish See Artisan Wood Finish Options	③b Chassis Grain Direction For Artisan Only: Vertical Horizontal		

FLUX

Description	D	W	H	CTN WT	CU FT	① Model	Laminate	Essentials Veneer	Artisan Veneer
69" h Box/ File Lateral, Storage Cabinet	22	36	69	261	38	FLT2236-69L6D	\$4,071		
	22	36	69	261	38	FLV2236-69L6D		\$5,606	\$6,168
	22	30	69	239	32	FLT2230-69L6D	\$3,899		
	22	30	69	239	32	FLV2230-69L6D		\$5,388	\$5,927

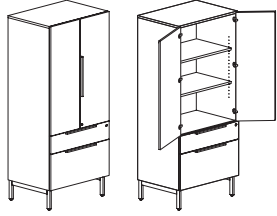

Features:

- aligns with primary height units
- pedestal front locking
- upper compartment has two adjustable shelves

Options:

- must specify chassis grain direction on artisan veneer, see pages 13-15 for details
- veneer door and drawer front in paint available, specify paint color and add \$372; see page 16 for details
- on laminate units, contrasting door and drawer fronts available, no upcharge; specify color, see page 16 for details
- locking door available, specify and add \$153 list
- ledge pulls standard; prism pulls available, specify and see page 9

69" h Box/ File Lateral, Open Storage Cabinet	22	36	69	241	38	FLT2236-69L60	\$3,889		
	22	36	69	241	38	FLV2236-69L60		\$5,374	\$5,912
	22	30	69	219	32	FLT2230-69L60	\$3,730		
	22	30	69	219	32	FLV2230-69L60		\$5,168	\$5,685

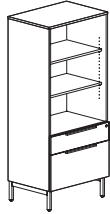

Features:

- aligns with primary height units
- pedestal front locking
- upper compartment has two adjustable shelves

Options:

- must specify chassis grain direction on artisan veneer, see pages 13-15 for details
- veneer drawer fronts in paint available, specify paint color and add \$372 list; see page 16 for details
- on laminate units, contrasting drawer fronts available, no upcharge; specify color, see page 16 for details
- ledge pulls standard; prism pulls available, specify and see page 9

FLUX

Description	D	W	H	CTN WT	CU FT	① Model	Laminate	Essentials Veneer	Artisan Veneer
69" h Lower and Upper Hinge Door Storage Cabinet	22	36	69	240	37	FLT2236-69L8D	\$3,450		
	22	36	69	240	37	FLV2236-69L8D		\$4,945	\$5,438
	22	30	69	223	32	FLT2230-69L8D	\$3,293		
	22	30	69	223	32	FLV2230-69L8D		\$4,754	\$5,226

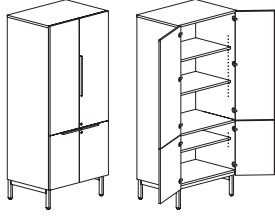

Features:

- aligns with primary height units
- upper compartment has two adjustable shelves, lower compartment has one adjustable shelf

Options:

- must specify chassis grain direction on artisan veneer, see pages 13-15 for details
- veneer door fronts in paint available, specify paint color and add \$372 list; see page 16 for details
- on laminate units, contrasting doors fronts available, no upcharge; specify color, see page 16 for details
- locking doors available, specify and add \$306 list
- ledge pulls standard; prism pulls available, specify and see page 9

69" h Lower Hinge Doors, Open Storage Cabinet	22	36	69	221	38	FLT2236-69L80	\$3,269		
	22	36	69	221	38	FLV2236-69L80		\$4,714	\$5,184
	22	30	69	204	32	FLT2230-69L80	\$3,123		
	22	30	69	204	32	FLV2230-69L80		\$4,532	\$4,987

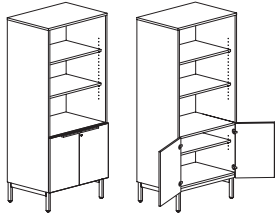

Features:

- aligns with primary height units
- upper compartment has two adjustable shelves, lower compartment has one adjustable shelf

Options:

- must specify chassis grain direction on artisan veneer, see pages 13-15 for details
- veneer door fronts in paint available, specify paint color and add \$372 list; see page 16 for details
- on laminate units, contrasting doors fronts available, no upcharge; specify color, see page 16 for details
- locking door available, specify and add \$153 list
- ledge pulls standard; prism pulls available, specify and see page 9

To Order, Specify:

① Laminate Model #		② Laminate Selection		③ Metal Color	④ Other Product Options
Laminate (FLT)		See Laminate Selection		See Metal Finish Color Options	See list of options for each specific unit; Specify and add accordingly.
① Veneer Model #	② Wood Collection	③ Wood Finish		④ Metal Color	⑤ Other Product Options
Veneer (FLV)	Essentials	See Essentials Wood Finish Options		See Metal Finish Color Options	See list of options for each specific unit; Specify and add accordingly.
	Artisan	ⓐ Wood Finish See Artisan Wood Finish Options	ⓑ Chassis Grain Direction For Artisan Only: Vertical Horizontal		

Description	D	W	H	CTN WT	CU FT	① Model	Laminate	Essentials Veneer	Artisan Veneer
81" h Box/File, Storage Cabinet	22	18	81	209	24	FLT2218-81L5DR	\$3,442		
	22	18	81	209	24	FLV2218-81L5DR		\$4,535	\$4,990
	22	18	81	209	24	FLT2218-81L5DL	\$3,442		
	22	18	81	209	24	FLV2218-81L5DL		\$4,535	\$4,990

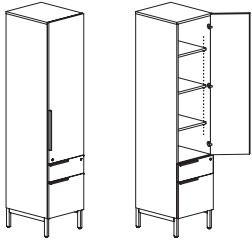

right shown



left

Features:

- aligns with primary height units
- pedestal front locking
- upper compartment has three adjustable shelves

Options:

- must specify chassis grain direction on artisan veneer, see pages 13-15 for details
- veneer door and drawer front in paint available, specify paint color and add \$372; see page 16 for details
- on laminate units, contrasting door and drawer fronts available, no upcharge; specify color, see page 16 for details
- locking door available, specify and add \$153 list
- ledge pulls standard; prism pulls available, specify and see page 9
- vanity mirror available, specify and add \$157 list

81" h Box/File, Open Storage Cabinet	22	18	81	182	24	FLT2218-81L50	\$3,322		
	22	18	81	182	24	FLV2218-81L50		\$4,363	\$4,800

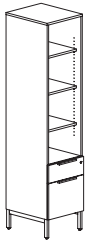

Features:

- aligns with primary height units
- pedestal front locking
- upper compartment has three adjustable shelves

Options:

- must specify chassis grain direction on artisan veneer, see pages 13-15 for details
- veneer drawer fronts in paint available, specify paint color and add \$372 list; see page 16 for details
- on laminate units, contrasting drawer fronts available, no upcharge; specify color, see page 16 for details
- ledge pulls standard; prism pulls available, specify and see page 9

FLUX

Description	D	W	H	CTN WT	CU FT	① Model	Laminate	Essentials Veneer	Artisan Veneer
81" h Lower and Upper Hinge Door Storage Cabinet	22	18	81	187	24	FLT2218-81L8DR	\$2,856		
	22	18	81	187	24	FLV2218-81L8DR		\$3,915	\$4,305
	22	18	81	187	24	FLT2218-81L8DL	\$2,856		
	22	18	81	187	24	FLV2218-81L8DL		\$3,915	\$4,305

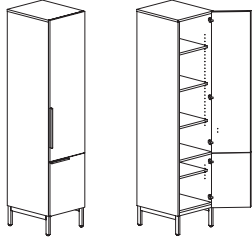

right shown

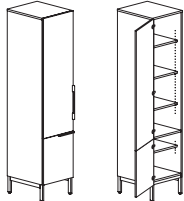

left

Features:

- aligns with primary height units
- upper compartment has two adjustable shelves, lower compartment has one adjustable shelf

Options:

- must specify chassis grain direction on artisan veneer, see pages 13-15 for details
- veneer door fronts in paint available, specify paint color and add \$372 list; see page 16 for details
- on laminate units, contrasting doors fronts available, no upcharge; specify color, see page 16 for details
- locking doors available, specify and add \$306 list
- ledge pulls standard; prism pulls available, specify and see page 9
- vanity mirror available, specify and add \$157 list

81" h Lower Hinge Door, Open Storage Cabinet	22	18	81	165	24	FLT2218-81L8OR	\$2,738		
	22	18	81	165	24	FLV2218-81L8OR		\$3,741	\$4,114
	22	18	81	165	24	FLT2218-81L8OL	\$2,738		
	22	18	81	165	24	FLV2218-81L8OL		\$3,741	\$4,114

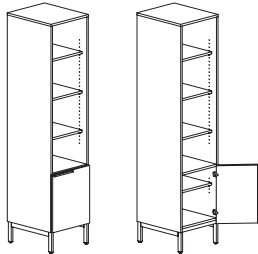

right shown

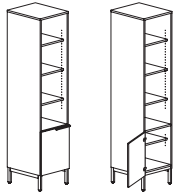

left

Features:

- aligns with primary height units
- upper compartment has three adjustable shelves, lower compartment has one adjustable shelf

Options:

- must specify chassis grain direction on artisan veneer, see pages 13-15 for details
- veneer door front in paint available, specify paint color and add \$372 list; see page 16 for details
- on laminate units, contrasting doors fronts available, no upcharge; specify color, see page 16 for details
- locking door available, specify and add \$153 list
- ledge pulls standard; prism pulls available, specify and see page 9

To Order, Specify:

① Laminate Model #		② Laminate Selection		③ Metal Color	④ Other Product Options
Laminate (FLT)		See Laminate Selection		See Metal Finish Color Options	See list of options for each specific unit; Specify and add accordingly.
① Veneer Model #	② Wood Collection	③ Wood Finish		④ Metal Color	⑤ Other Product Options
Veneer (FLV)	Essentials	See Essentials Wood Finish Options		See Metal Finish Color Options	
	Artisan	ⓐ Wood Finish	ⓑ Chassis Grain Direction		
		See Artisan Wood Finish Options	For Artisan Only: Vertical Horizontal		

FLUX

Description	D	W	H	CTN WT	CU FT	① Model	Laminate	Essentials Veneer	Artisan Veneer
69" h Box/File, Storage Cabinet	22	18	69	181	20	FLT2218-69L5DR	\$3,231		
	22	18	69	181	20	FLV2218-69L5DR		\$4,233	\$4,656
	22	18	69	181	20	FLT2218-69L5DL	\$3,231		
	22	18	69	181	20	FLV2218-69L5DL		\$4,233	\$4,656

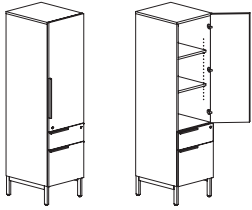

right shown

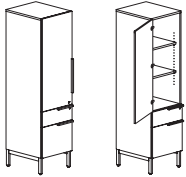

left

Features:

- aligns with primary height units
- pedestal front locking
- upper compartment has two adjustable shelves

Options:

- must specify chassis grain direction on artisan veneer, see pages 13-15 for details
- veneer door and drawer front in paint available, specify paint color and add \$372; see page 16 for details
- on laminate units, contrasting door and drawer fronts available, no upcharge; specify color, see page 16 for details
- locking door available, specify and add \$153 list
- ledge pulls standard; prism pulls available, specify and see page 9
- vanity mirror available, specify and add \$157 list

69" h Box/File, Open Storage Cabinet	22	18	69	160	20	FLT2218-69L50	\$3,134		
	22	18	69	160	20	FLV2218-69L50		\$4,097	\$4,507

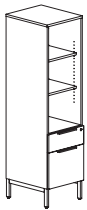

Features:

- aligns with primary height units
- pedestal front locking
- upper compartment has two adjustable shelves

Options:

- must specify chassis grain direction on artisan veneer, see pages 13-15 for details
- veneer drawer fronts in paint available, specify paint color and add \$372 list; see page 16 for details
- on laminate units, contrasting drawer fronts available, no upcharge; specify color, see page 16 for details
- ledge pulls standard; prism pulls available, specify and see page 9

Description	D	W	H	CTN WT	CU FT	① Model	Laminate	Essentials Veneer	Artisan Veneer
69" Lower and Upper Hinge Door Storage Cabinet	22	18	69	161	20	FLT2218-69L8DR	\$2,643		
	22	18	69	161	20	FLV2218-69L8DR		\$3,610	\$3,973
	22	18	69	161	20	FLT2218-69L8DL	\$2,643		
	22	18	69	161	20	FLV2218-69L8DL		\$3,610	\$3,973

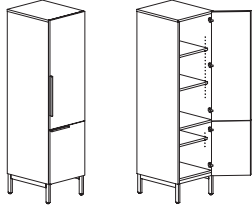

right shown



left

Features:

- aligns with primary height units
- upper compartment has two adjustable shelves, lower compartment has one adjustable shelf

Options:

- must specify chassis grain direction on artisan veneer, see pages 13-15 for details
- veneer door fronts in paint available, specify paint color and add \$372 list; see page 16 for details
- on laminate units, contrasting doors fronts available, no upcharge; specify color, see page 16 for details
- locking doors available, specify and add \$306 list
- ledge pulls standard; prism pulls available, specify and see page 9
- vanity mirror available, specify and add \$157 list

69" Lower Hinge Door, Open Storage Cabinet	22	18	69	144	20	FLT2218-69L8OR	\$2,549		
	22	18	69	144	20	FLV2218-69L8OR		\$3,474	\$3,820
	22	18	69	144	20	FLT2218-69L8OL	\$2,549		
	22	18	69	144	20	FLV2218-69L8OL		\$3,474	\$3,820

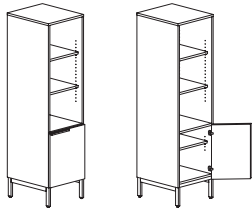

right shown

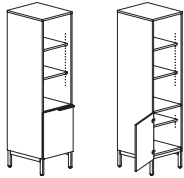

left

Features:

- aligns with primary height units
- upper compartment has two adjustable shelves, lower compartment has one adjustable shelf

Options:

- must specify chassis grain direction on artisan veneer, see pages 13-15 for details
- veneer door front in paint available, specify paint color and add \$372 list; see page 16 for details
- on laminate units, contrasting doors fronts available, no upcharge; specify color, see page 16 for details
- locking door available, specify and add \$153 list
- ledge pulls standard; prism pulls available, specify and see page 9

To Order, Specify:

① Laminate Model #		② Laminate Selection		③ Metal Color	④ Other Product Options
Laminate (FLT)		See Laminate Selection		See Metal Finish Color Options	See list of options for each specific unit; Specify and add accordingly.
① Veneer Model #	② Wood Collection	③ Wood Finish		④ Metal Color	⑤ Other Product Options
Veneer (FLV)	Essentials	See Essentials Wood Finish Options		See Metal Finish Color Options	
	Artisan	ⓐ Wood Finish	ⓑ Chassis Grain Direction		
		See Artisan Wood Finish Options	For Artisan Only: Vertical Horizontal		

Description	D	W	H	CTN WT	CU FT	① Model	Laminate	Essentials Veneer	Artisan Veneer
81" h File Drawer, Storage Cabinet with Side Wardrobe	22	24	81	260	30	FLT2224-81SL5DWR	\$4,083		
	22	24	81	260	30	FLV2224-81SL5DWR		\$5,631	\$6,192
	22	24	81	260	30	FLT2224-81SL5DWL	\$4,083		
	22	24	81	260	30	FLV2224-81SL5DWL		\$5,631	\$6,192

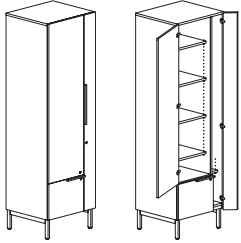

right shown



left

Features:

- aligns with secondary height units
- pedestal front locking
- upper compartment has four adjustable shelves
- installed coat hook in wardrobe compartment

Options:

- must specify chassis grain direction on artisan veneer, see pages 13-15 for details
- veneer door and drawer front in paint available, specify paint color and add \$372; see page 16 for details
- on laminate units, contrasting door and drawer fronts available, no upcharge; specify color, see page 16 for details
- locking doors available, specify and add \$306 list
- ledge pulls standard; prism pulls available, specify and see page 9
- vanity mirror available, specify and add \$157 list

81" h File Drawer, Open Storage Cabinet with Side Wardrobe	22	24	81	230	30	FLT2224-81SL50WR	\$3,963		
	22	24	81	230	30	FLV2224-81SL50WR		\$5,458	\$6,004
	22	24	81	230	30	FLT2224-81SL50WL	\$3,963		
	22	24	81	230	30	FLV2224-81SL50WL		\$5,458	\$6,004

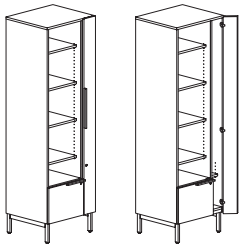

right shown

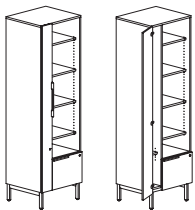

left

Features:

- aligns with secondary height units
- pedestal front locking
- upper compartment has four adjustable shelves
- installed coat hook in wardrobe compartment

Options:

- must specify chassis grain direction on artisan veneer, see pages 13-15 for details
- veneer door and drawer front in paint available, specify paint color and add \$372; see page 16 for details
- on laminate units, contrasting door and drawer fronts available, no upcharge; specify color, see page 16 for details
- locking door available, specify and add \$153 list
- ledge pulls standard; prism pulls available, specify and see page 9

Description	D	W	H	CTN WT	CU FT	① Model	Laminate	Essentials Veneer	Artisan Veneer
81" h Upper and Lower Hinge Door Storage Cabinet with Side Wardrobe	22	24	81	249	30	FLT2224-81SL8DWR	\$3,512		
	22	24	81	246	30	FLV2224-81SL8DWR		\$4,981	\$5,480
	22	24	81	246	30	FLT2224-81SL8DWL	\$3,512		
	22	24	81	246	30	FLV2224-81SL8DWL		\$4,981	\$5,480

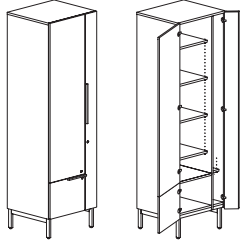

right shown

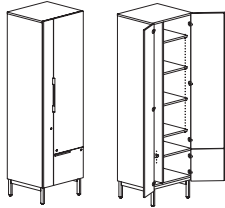

left

Features:

- aligns with secondary height units
- upper compartment has four adjustable shelves
- installed coat hook in wardrobe compartment

Options:

- must specify chassis grain direction on artisan veneer, see pages 13-15 for details
- veneer door fronts in paint available, specify paint color and add \$372 list; see page 16 for details
- on laminate units, contrasting doors fronts available, no upcharge; specify color, see page 16 for details
- locking doors available, specify and add \$306 list
- ledge pulls standard; prism pulls available, specify and see page 9
- vanity mirror available, specify and add \$157 list

81" h Lower Hinge Door, Open Storage Cabinet with Side Wardrobe	22	24	81	217	30	FLT2224-81SL80WR	\$3,394		
	22	24	81	217	30	FLV2224-81SL80WR		\$4,807	\$5,288
	22	24	81	217	30	FLT2224-81SL80WL	\$3,394		
	22	24	81	217	30	FLV2224-81SL80WL		\$4,807	\$5,288

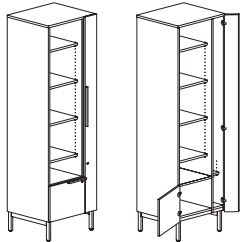

right shown

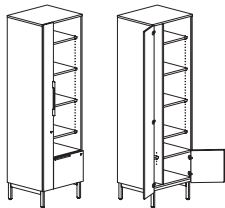

left

Features:

- aligns with secondary height units
- upper compartment has four adjustable shelves
- installed coat hook in wardrobe compartment

Options:

- must specify chassis grain direction on artisan veneer, see pages 13-15 for details
- veneer door fronts in paint available, specify paint color and add \$372 list; see page 16 for detail
- on laminate units, contrasting doors fronts available, no upcharge; specify color, see page 16 for details
- locking doors available, specify and add \$306 list
- ledge pulls standard; prism pulls available, specify and see page 9

To Order, Specify:

① Laminate Model #	② Laminate Type	③ Laminate Selection	④ Metal Color	⑤ Other Product Options
Laminate (FLT)	HPL	See Laminate Selection	See Metal Finish Color Options	See list of options for each specific unit; Specify and add accordingly.

① Veneer Model #	② Wood Collection	③ Wood Finish - Finishes with an asterisk (*) have a coordinating laminate available	④ Metal Color	⑤ Other Product Options		
Veneer (FLV)	Essentials	See Essentials Wood Finish Options	See Metal Finish Color Options	See list of options for each specific unit; Specify and add accordingly.		
	Artisan	<table border="1"> <thead> <tr> <th>③a Wood Finish</th> <th>③b Chassis Grain Direction</th> </tr> </thead> <tbody> <tr> <td>See Artisan Wood Finish Options</td> <td>For Artisan Only: Vertical Horizontal</td> </tr> </tbody> </table>	③a Wood Finish		③b Chassis Grain Direction	See Artisan Wood Finish Options
③a Wood Finish	③b Chassis Grain Direction					
See Artisan Wood Finish Options	For Artisan Only: Vertical Horizontal					

Description	D	W	H	CTN WT	CU FT	① Model	Laminate	Essentials Veneer	Artisan Veneer
69" h File Drawer, Upper Hinge	22	24	69	229	26	FLT2224-69SL5DWR	\$3,871		
Door Storage Cabinet with Side Wardrobe	22	24	69	229	26	FLV2224-69SL5DWR		\$5,328	\$5,859
	22	24	69	229	26	FLT2224-69SL5DWL	\$3,871		
	22	24	69	229	26	FLV2224-69SL5DWL		\$5,328	\$5,859

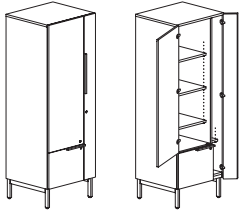

right shown

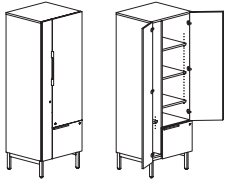

left

Features:

- aligns with secondary height units
- pedestal front locking
- upper compartment has three adjustable shelves
- installed coat hook in wardrobe compartment

Options:

- must specify chassis grain direction on artisan veneer, see pages 13-15 for details
- veneer door and drawer front in paint available, specify paint color and add \$372; see page 16 for details
- on laminate units, contrasting door and drawer fronts available, no upcharge; specify color, see page 16 for details
- locking doors available, specify and add \$306 list
- ledge pulls standard; prism pulls available, specify and see page 9
- vanity mirror available, specify and add \$157 list

69" h File Drawer, Open Storage Cabinet with Side Wardrobe	22	24	69	204	26	FLT2224-69SL50WR	\$3,775		
	22	24	69	204	26	FLV2224-69SL50WR		\$5,190	\$5,709
	22	24	69	204	26	FLT2224-69SL50WL	\$3,775		
	22	24	69	204	26	FLV2224-69SL50WL		\$5,190	\$5,709

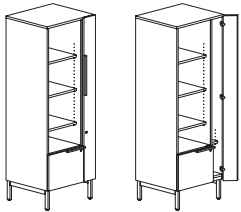

right shown

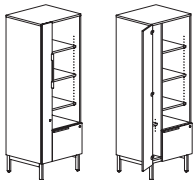

left

Features:

- aligns with secondary height units
- pedestal front locking
- upper compartment has three adjustable shelves
- installed coat hook in wardrobe compartment

Options:

- must specify chassis grain direction on artisan veneer, see pages 13-15 for details
- veneer door and drawer front in paint available, specify paint color and add \$372; see page 16 for details
- on laminate units, contrasting door and drawer fronts available, no upcharge; specify color, see page 16 for details
- locking door available, specify and add \$153 list
- ledge pulls standard; prism pulls available, specify and see page 9

FLUX

Description	D	W	H	CTN WT	CU FT	① Model	Laminate	Essentials Veneer	Artisan Veneer
69" h Lower and Upper Hinge Door Storage Cabinet with Side Wardrobe	22	24	69	215	26	FLT2224-69SL8DWR	\$3,301		
	22	24	69	215	26	FLV2224-69SL8DWR		\$4,679	\$5,144
	22	24	69	215	26	FLT2224-69SL8DWL	\$3,301		
	22	24	69	215	26	FLV2224-69SL8DWL		\$4,679	\$5,144

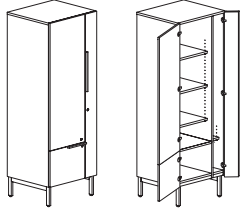

right shown

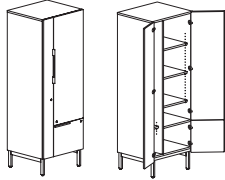

left

Features:

- aligns with secondary height units
- upper compartment has three adjustable shelves
- installed coat hook in wardrobe compartment

Options:

- must specify chassis grain direction on artisan veneer, see pages 13-15 for details
- veneer door fronts in paint available, specify paint color and add \$372 list; see page 16 for detail
- on laminate units, contrasting doors fronts available, no upcharge; specify color, see page 16 for details
- locking doors available, specify and add \$459 list
- ledge pulls standard; prism pulls available, specify and see page 9
- vanity mirror available, specify and add \$157 list

69" h Lower Hinge Door, Open Storage Cabinet with Side Wardrobe	22	24	69	191	26	FLT2224-69SL80WR	\$3,204		
	22	24	69	191	26	FLV2224-69SL80WR		\$4,539	\$4,993
	22	24	69	191	26	FLT2224-69SL80WL	\$3,204		
	22	24	69	191	26	FLV2224-69SL80WL		\$4,539	\$4,993

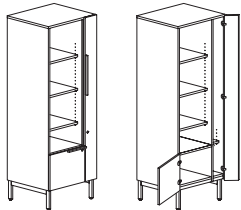

right shown

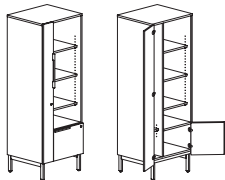

left

Features:

- aligns with secondary height units
- upper compartment has three adjustable shelves
- installed coat hook in wardrobe compartment

Options:

- must specify chassis grain direction on artisan veneer, see pages 13-15 for details
- veneer door fronts in paint available, specify paint color and add \$372 list; see page 16 for detail
- on laminate units, contrasting doors fronts available, no upcharge; specify color, see page 16 for details
- locking doors available, specify and add \$306 list
- ledge pulls standard; prism pulls available, specify and see page 9

To Order, Specify:

① Laminate Model #	② Laminate Selection	③ Metal Color	④ Other Product Options	
Laminate (FLT)	See Laminate Selection	See Metal Finish Color Options	See list of options for each specific unit; Specify and add accordingly.	
① Veneer Model #	② Wood Collection	③ Wood Finish	④ Metal Color	⑤ Other Product Options
Veneer (FLV)	Essentials	See Essentials Wood Finish Options	See Metal Finish Color Options	See list of options for each specific unit; Specify and add accordingly.
	Artisan	3a Wood Finish See Artisan Wood Finish Options	3b Chassis Grain Direction For Artisan Only: Vertical Horizontal	

FLUX

Description	D	W	H	CTN WT	CU FT	① Model	Laminate	Essentials Veneer	Artisan Veneer
81" h File Drawer, Storage Cabinet	22	36	81	259	44	FLT2236-81SL6D	\$4,272		
	22	36	81	259	44	FLV2236-81SL6D		\$5,948	\$6,542
	22	30	81	237	37	FLT2230-81SL6D	\$4,071		
	22	30	81	237	37	FLV2230-81SL6D		\$5,686	\$6,255

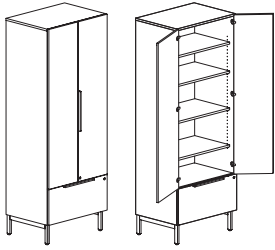

Features:

- aligns with secondary height units
- pedestal front locking
- upper compartment has four adjustable shelves

Options:

- must specify chassis grain direction on artisan veneer, see pages 13-15 for details
- veneer door and drawer front in paint available, specify paint color and add \$372; see page 16 for details
- on laminate units, contrasting door and drawer fronts available, no upcharge; specify color, see page 16 for details
- locking door available, specify and add \$153 list
- ledge pulls standard, mounted vertical; prism pulls available, specify and see page 9

81" h Lateral File Drawer, Open Storage Cabinet	22	36	81	239	44	FLT2236-81SL60	\$4,051		
	22	36	81	239	44	FLV2236-81SL60		\$5,660	\$6,225
	22	30	81	217	37	FLT2230-81SL60	\$3,866		
	22	30	81	217	37	FLV2230-81SL60		\$5,416	\$5,958

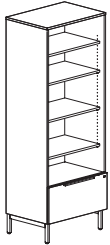

Features:

- aligns with secondary height units
- pedestal front locking
- upper compartment has four adjustable shelves

Options:

- must specify chassis grain direction on artisan veneer, see pages 13-15 for details
- veneer drawer fronts in paint available, specify paint color and add \$372 list; see page 16 for details
- on laminate units, contrasting door front available, no upcharge; specify color, see page 16 for details
- ledge pulls standard; prism pulls available, specify and see page 9

FLUX

Description	D	W	H	CTN WT	CU FT	① Model	Laminate	Essentials Veneer	Artisan Veneer
81" Lower and Upper Hinge Door Storage Cabinet	22	36	81	240	44	FLT2236-81SL8D	\$3,648		
	22	36	81	240	44	FLV2236-81SL8D		\$5,285	\$5,814
	22	30	81	223	37	FLT2230-81SL8D	\$3,461		
	22	30	81	223	37	FLV2230-81SL8D		\$5,049	\$5,553

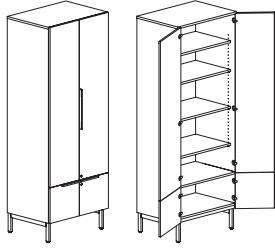

Features:

- aligns with secondary height units
- upper compartment has four adjustable shelves

Options:

- must specify chassis grain direction on artisan veneer, see pages 13-15 for details
- veneer door fronts in paint available, specify paint color and add \$372 list; see page 16 for details
- on laminate units, contrasting doors fronts available, no upcharge; specify color, see page 16 for details
- locking doors available, specify and add \$306 list
- ledge pulls standard; prism pulls available, specify and see page 9

81" Lower Hinge Doors, Open Storage Cabinet	22	36	81	219	44	FLT2236-81SL80	\$3,429		
	22	36	81	219	44	FLV2236-81SL80		\$4,997	\$5,497
	22	30	81	202	37	FLT2230-81SL80	\$3,260		
	22	30	81	202	37	FLV2230-81SL80		\$4,778	\$5,258

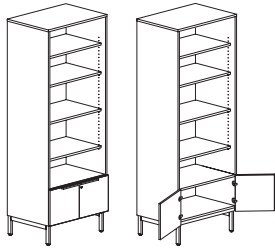

Features:

- aligns with secondary height units
- upper compartment has four adjustable shelves

Options:

- must specify chassis grain direction on artisan veneer, see pages 13-15 for details
- veneer door fronts in paint available, specify paint color and add \$372 list; see page 16 for details
- on laminate units, contrasting doors fronts available, no upcharge; specify color, see page 16 for details
- locking door available, specify and add \$153 list
- ledge pulls standard; prism pulls available, specify and see page 9

To Order, Specify:

① Laminate Model #		② Laminate Selection		③ Metal Color	④ Other Product Options
Laminate (FLT)		See Laminate Selection		See Metal Finish Color Options	See list of options for each specific unit; Specify and add accordingly.
① Veneer Model #	② Wood Collection	③ Wood Finish		④ Metal Color	⑤ Other Product Options
Veneer (FLV)	Essentials	See Essentials Wood Finish Options		See Metal Finish Color Options	See list of options for each specific unit; Specify and add accordingly.
	Artisan	③a Wood Finish See Artisan Wood Finish Options	③b Chassis Grain Direction For Artisan Only: Vertical Horizontal		

FLUX

Description	D	W	H	CTN WT	CU FT	① Model	Laminate	Essentials Veneer	Artisan Veneer
69" h Lateral File Drawer, Storage Cabinet	22	36	69	259	38	FLT2236-69SL6D	\$3,942		
	22	36	69	259	38	FLV2236-69SL6D		\$5,480	\$6,027
	22	30	69	237	32	FLT2230-69SL6D	\$3,774		
	22	30	69	237	32	FLV2230-69SL6D		\$5,261	\$5,786

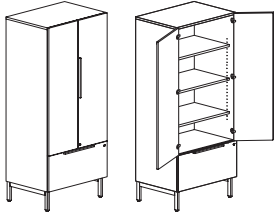

Features:

- aligns with secondary height units
- pedestal front locking
- upper compartment has three adjustable shelves

Options:

- must specify chassis grain direction on artisan veneer, see pages 13-15 for details
- veneer door and drawer front in paint available, specify paint color and add \$372; see page 16 for details
- on laminate units, contrasting door and drawer fronts available, no upcharge; specify color, see page 16 for details
- locking door available, specify and add \$153 list
- ledge pulls standard; prism pulls available, specify and see page 9

Description	D	W	H	CTN WT	CU FT	① Model	Laminate	Essentials Veneer	Artisan Veneer
69" h Lateral File Drawer, Open Storage Cabinet	22	36	69	239	38	FLT2236-69SL60	\$3,763		
	22	36	69	239	38	FLV2236-69SL60		\$5,250	\$5,770
	22	30	69	217	32	FLT2230-69SL60	\$3,603		
	22	30	69	217	32	FLV2230-69SL60		\$5,042	\$5,546

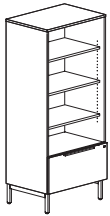

Features:

- aligns with secondary height units
- pedestal front locking
- upper compartment has three adjustable shelves

Options:

- must specify chassis grain direction on artisan veneer, see pages 13-15 for details
- veneer drawer fronts in paint available, specify paint color and add \$372 list; see page 16 for details
- on laminate units, contrasting door front available, no upcharge; specify color, see page 16 for details
- ledge pulls standard; prism pulls available, specify and see page 9

FLUX

Description	D	W	H	CTN WT	CU FT	① Model	Laminate	Essentials Veneer	Artisan Veneer
69" Lower and Upper Hinge Door Storage Cabinet	22	36	69	240	38	FLT2236-69SL8D	\$3,450		
	22	36	69	240	38	FLV2236-69SL8D		\$4,945	\$5,438
	22	30	69	223	32	FLT2230-69SL8D	\$3,293		
	22	30	69	223	32	FLV2230-69SL8D		\$4,754	\$5,226

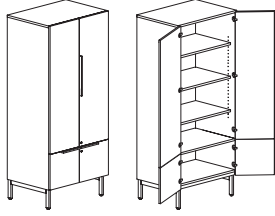

Features:

- aligns with secondary height units
- upper compartment has three adjustable shelves

Options:

- must specify chassis grain direction on artisan veneer, see pages 13-15 for details
- veneer door fronts in paint available, specify paint color and add \$372 list; see page 16 for details
- on laminate units, contrasting doors fronts available, no upcharge; specify color, see page 16 for details
- locking doors available, specify and add \$306 list
- ledge pulls standard; prism pulls available, specify and see page 9

69" Lower Hinge Doors, Open Storage Cabinet	22	36	69	219	38	FLT2236-69SL80	\$3,269		
	22	36	69	219	38	FLV2236-69SL80		\$4,714	\$5,184
	22	30	69	202	32	FLT2230-69SL80	\$3,123		
	22	30	69	202	32	FLV2230-69SL80		\$4,532	\$4,987

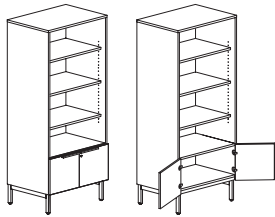

Features:

- aligns with secondary height units
- upper compartment has three adjustable shelves

Options:

- must specify chassis grain direction on artisan veneer, see pages 13-15 for details
- veneer door fronts in paint available, specify paint color and add \$372 list; see page 16 for details
- on laminate units, contrasting doors fronts available, no upcharge; specify color, see page 16 for details
- locking door available, specify and add \$153 list
- ledge pulls standard; prism pulls available, specify and see page 9

To Order, Specify:

① Laminate Model #		② Laminate Selection		③ Metal Color	④ Other Product Options
Laminate (FLT)		See Laminate Selection		See Metal Finish Color Options	See list of options for each specific unit; Specify and add accordingly.
① Veneer Model #	② Wood Collection	③ Wood Finish		④ Metal Color	⑤ Other Product Options
Veneer (FLV)	Essentials	See Essentials Wood Finish Options		See Metal Finish Color Options	See list of options for each specific unit; Specify and add accordingly.
	Artisan	③a Wood Finish See Artisan Wood Finish Options	③b Chassis Grain Direction For Artisan Only: Vertical Horizontal		

Description	D	W	H	CTN WT	CU FT	① Model	Laminate	Essentials Veneer	Artisan Veneer
81" h File Drawer, Storage Cabinet	22	18	81	201	24	FLT2218-81SL5DR	\$3,330		
	22	18	81	201	24	FLV2218-81SL5DR		\$4,425	\$4,868
	22	18	81	201	24	FLT2218-81SL5DL	\$3,330		
	22	18	81	201	24	FLV2218-81SL5DL		\$4,425	\$4,868

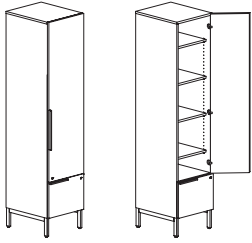

right shown

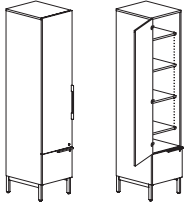

left

Features:

- aligns with secondary height units
- upper compartment has four adjustable shelves

Options:

- must specify chassis grain direction on artisan veneer, see pages 13-15 for details
- veneer door and drawer front in paint available, specify paint color and add \$372; see page 16 for details
- on laminate units, contrasting door and drawer fronts available, no upcharge; specify color, see page 16 for details
- locking door available, specify and add \$153 list
- ledge pulls standard; prism pulls available, specify and see page 9
- vanity mirror available, specify and add \$157 list

81" h File Drawer, Open Storage Cabinet	22	18	81	176	23	FLT2218-81SL50	\$3,210		
	22	18	81	176	23	FLV2218-81SL50		\$4,252	\$5,226

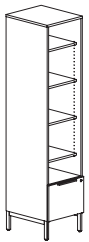

Features:

- aligns with secondary height units
- pedestal front locking
- upper compartment has four adjustable shelves

Options:

- must specify chassis grain direction on artisan veneer, see pages 13-15 for details
- veneer drawer fronts in paint available, specify paint color and add \$372 list; see page 16 for details
- on laminate units, contrasting door front available, no upcharge; specify color, see page 16 for details
- ledge pulls standard; prism pulls available, specify and see page 9

Description	D	W	H	CTN WT	CU FT	① Model	Laminate	Essentials Veneer	Artisan Veneer
81" h Lower and Upper Hinge Door Storage Cabinet	22	18	81	187	24	FLT2218-81SL8DR	\$2,856		
	22	18	81	187	24	FLV2218-81SL8DR		\$3,915	\$4,305
	22	18	81	187	24	FLT2218-81SL8DL	\$2,856		
	22	18	81	187	24	FLV2218-81SL8DL		\$3,915	\$4,305

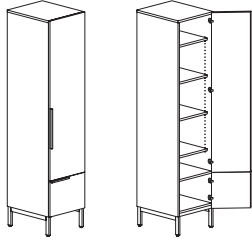

right shown

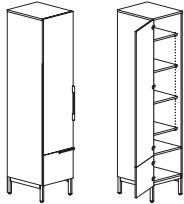

left

Features:

- aligns with secondary height units
- upper compartment has four adjustable shelves

Options:

- must specify chassis grain direction on artisan veneer, see pages 13-15 for details
- veneer door fronts in paint available, specify paint color and add \$372 list; see page 16 for details
- on laminate units, contrasting doors fronts available, no upcharge; specify color, see page 16 for details
- locking doors available, specify and add \$306 list
- ledge pulls standard; prism pulls available, specify and see page 9
- vanity mirror available, specify and add \$157 list

81" h Lower Hinge Door, Open Storage Cabinet	22	18	81	163	24	FLT2218-81SL80R	\$2,738		
	22	18	81	163	24	FLV2218-81SL80R		\$3,741	\$4,114
	22	18	81	163	24	FLT2218-81SL80L	\$2,738		
	22	18	81	163	24	FLV2218-81SL80L		\$3,741	\$4,114

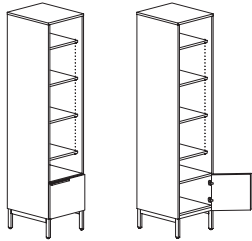

right shown

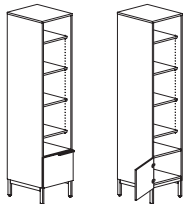

left

Features:

- aligns with secondary height units
- upper compartment has four adjustable shelves

Options:

- must specify chassis grain direction on artisan veneer, see pages 13-15 for details
- veneer door front in paint available, specify paint color and add \$372 list; see page 16 for details
- on laminate units, contrasting doors fronts available, no upcharge; specify color, see page 16 for details
- locking lower door available, specify and add \$153 list
- ledge pulls standard; prism pulls available, specify and see page 9

To Order, Specify:

① Laminate Model #		② Laminate Selection		③ Metal Color	④ Other Product Options
Laminate (FLT)		See Laminate Selection		See Metal Finish Color Options	See list of options for each specific unit; Specify and add accordingly.
① Veneer Model #	② Wood Collection	③ Wood Finish		④ Metal Color	⑤ Other Product Options
Veneer (FLV)	Essentials	See Essentials Wood Finish Options		See Metal Finish Color Options	
	Artisan	ⓐ Wood Finish	ⓑ Chassis Grain Direction		
		See Artisan Wood Finish Options	For Artisan Only: Vertical Horizontal		

Description	D	W	H	CTN WT	CU FT	① Model	Laminate	Essentials Veneer	Artisan Veneer
69" h File Drawer, Storage Cabinet	22	18	69	179	20	FLT2218-69SL5DR	\$3,330		
	22	18	69	179	20	FLV2218-69SL5DR		\$4,425	\$4,868
	22	18	69	179	20	FLT2218-69SL5DL	\$3,330		
	22	18	69	179	20	FLV2218-69SL5DL		\$4,425	\$4,868

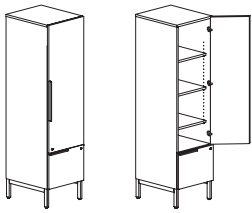

right shown

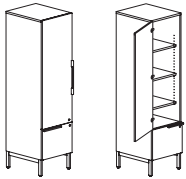

left

Features:

- aligns with secondary height units
- pedestal front locking
- upper compartment has three adjustable shelves

Options:

- must specify chassis grain direction on artisan veneer, see pages 13-15 for details
- veneer door and drawer front in paint available, specify paint color and add \$372; see page 16 for details
- on laminate units, contrasting door and drawer fronts available, no upcharge; specify color, see page 16 for details
- locking door available, specify and add \$153 list
- ledge pulls standard; prism pulls available, specify and see page 9
- vanity mirror available, specify and add \$157 list

69" h File Drawer, Open Storage Cabinet	22	18	69	154	20	FLT2218-69SL50	\$3,210		
	22	18	69	154	20	FLV2218-69SL50		\$4,252	\$4,680



Features:

- aligns with secondary height units
- pedestal front locking
- upper compartment has three adjustable shelves

Options:

- must specify chassis grain direction on artisan veneer, see pages 13-15 for details
- veneer drawer fronts in paint available, specify paint color and add \$372 list; see page 16 for details
- on laminate units, contrasting door front available, no upcharge; specify color, see page 16 for details
- ledge pulls standard; prism pulls available, specify and see page 9

FLUX

Description	D	W	H	CTN WT	CU FT	① Model	Laminate	Essentials Veneer	Artisan Veneer
69" h Lower and Upper Hinge Door Storage Cabinet	22	18	69	166	20	FLT2218-69SL8DR	\$2,856		
	22	18	69	166	20	FLV2218-69SL8DR		\$3,915	\$4,305
	22	18	69	166	20	FLT2218-69SL8DL	\$2,856		
	22	18	69	166	20	FLV2218-69SL8DL		\$3,915	\$4,305

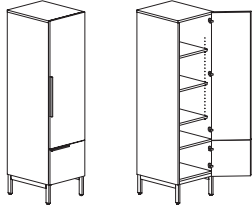

right shown

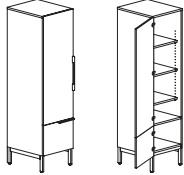

left

Features:

- aligns with secondary height units
- upper compartment has three adjustable shelves, lower compartment has one adjustable shelf

Options:

- must specify chassis grain direction on artisan veneer, see pages 13-15 for details
- veneer door fronts in paint available, specify paint color and add \$372 list; see page 16 for details
- on laminate units, contrasting doors fronts available, no upcharge; specify color, see page 16 for details
- locking doors available, specify and add \$306 list
- ledge pulls standard; prism pulls available, specify and see page 9
- vanity mirror available, specify and add \$157 list

69" h Lower Hinge Door, Open Storage Cabinet	22	18	69	141	20	FLT2218-69SL80R	\$2,738		
	22	18	69	141	20	FLV2218-69SL80R		\$3,741	\$4,114
	22	18	69	141	20	FLT2218-69SL80L	\$2,738		
	22	18	69	141	20	FLV2218-69SL80L		\$3,741	\$4,114

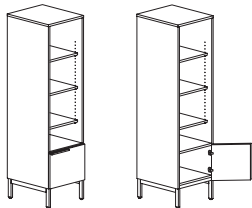

right shown

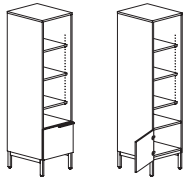

left

Features:

- aligns with secondary height units
- upper compartment has three adjustable shelves, lower compartment has one adjustable shelf

Options:

- must specify chassis grain direction on artisan veneer, see pages 13-15 for details
- veneer drawer fronts in paint available, specify paint color and add \$372 list; see page 16 for details
- on laminate units, contrasting door front available, no upcharge; specify color, see page 16 for details
- locking door available, specify and add \$153 list
- ledge pulls standard; prism pulls available, specify and see page 9

To Order, Specify:

① Laminate Model #		② Laminate Selection		③ Metal Color	④ Other Product Options
Laminate (FLT)		See Laminate Selection		See Metal Finish Color Options	See list of options for each specific unit; Specify and add accordingly.
① Veneer Model #	② Wood Collection	③ Wood Finish		④ Metal Color	⑤ Other Product Options
Veneer (FLV)	Essentials	See Essentials Wood Finish Options		See Metal Finish Color Options	
	Artisan	ⓐ Wood Finish	ⓑ Chassis Grain Direction		
		See Artisan Wood Finish Options	For Artisan Only: Vertical Horizontal		

Description	D	W	H	CTN WT	CU FT	① Model	Laminate	Essentials Veneer	Artisan Veneer
48" h Pantry Drawer with Filing and Wardrobe, Single User	30	18	48	254	23	FLT3018-48PTAR	\$3,027		
	30	18	48	254	23	FLV3018-48PTAR		\$3,894	\$4,266
	30	18	48	254	23	FLT3018-48PTAL	\$3,027		
	30	18	48	254	23	FLV3018-48PTAL		\$3,894	\$4,266

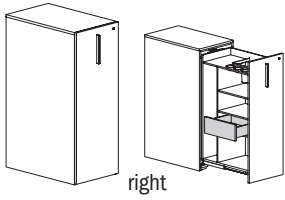

right

Features:

- filing brackets, accessory trays, fixed shelf, box drawer and wardrobe coat hook
- may not be used with Mid Support bracket to support Bench or Table Surfaces
- drawer extends 26"

Options:

- must specify drawer interior color, Designer White or Slate Grey
- must specify chassis grain direction on artisan veneer, see pages 13-15 for details
- veneer door and drawer fronts available in contrasting paint color, specify paint color and add \$372 list; see pages 16 for details
- laminate door and drawer fronts available in contrasting color, no upcharge, specify color; see pages 16 for details
- ledge pulls standard; prism pulls available, specify and see page 9
- locking door available, specify and add \$153 list
- wire pass-thru grommets available, specify and add \$126 list
- markerboard available on drawer back panel, specify and add \$563 list
- power jumper available; specify and add \$51 list (wire pass-thru grommet option must also be specified)

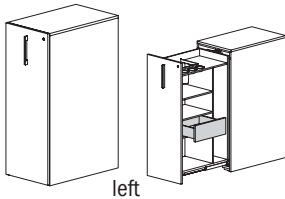

left

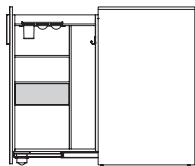

side view

48" h Pantry Drawer with Paper Sorter and Wardrobe, Single User	30	18	48	234	23	FLT3018-48PTBR	\$2,891		
	30	18	48	234	23	FLV3018-48PTBR		\$3,759	\$4,116
	30	18	48	234	23	FLT3018-48PTBL	\$2,891		
	30	18	48	234	23	FLV3018-48PTBL		\$3,759	\$4,116
	24	18	48	169	18	FLT2418-48PTBR	\$2,813		
	24	18	48	169	18	FLV2418-48PTBR		\$3,657	\$3,968
	24	18	48	169	18	FLT2418-48PTBL	\$2,813		
	24	18	48	169	18	FLV2418-48PTBL		\$3,657	\$3,968

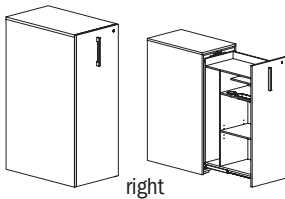

right

Features:

- paper shelves, accessory trays, fixed shelves and wardrobe coat hook
- may not be used with Mid Support bracket to support Bench or Table Surfaces
- drawer extends 26" on 30"d units, 20" on 24"d units

Options:

- must specify drawer interior color, Designer White or Slate Grey
- must specify chassis grain direction on artisan veneer, see pages 13-15 for details
- veneer door and drawer fronts available in contrasting paint color, specify paint color and add \$372 list; see pages 16 for details
- laminate door and drawer fronts available in contrasting color, no upcharge, specify color; see pages 16 for details
- ledge pulls standard; prism pulls available, specify and see page 9
- locking door available, specify and add \$153 list
- wire pass-thru grommets available, specify and add \$126 list
- markerboard available on drawer back panel, specify and add \$563 list
- power jumper available; specify and add \$51 list (wire pass-thru grommet option must also be specified)

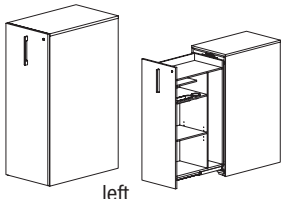

left

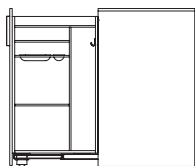

side view

Description	D	W	H	CTN WT	CU FT	① Model	Laminate	Essentials Veneer	Artisan Veneer
48" h Pantry Drawer with Filing, Single User	30	18	48	218	23	FLT3018-48PTCR	\$2,930		
	30	18	48	218	23	FLV3018-48PTCR		\$3,813	\$4,175
	30	18	48	218	23	FLT3018-48PTCL	\$2,930		
	30	18	48	218	23	FLV3018-48PTCL		\$3,813	\$4,175
	24	18	48	192	18	FLT2418-48PTCR	\$2,854		
	24	18	48	192	18	FLV2418-48PTCR		\$3,712	\$4,027
	24	18	48	192	18	FLT2418-48PTCL	\$2,854		
	24	18	48	192	18	FLV2418-48PTCL		\$3,712	\$4,027

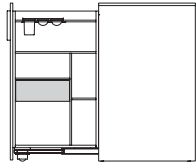
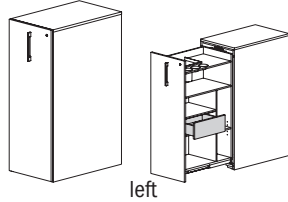
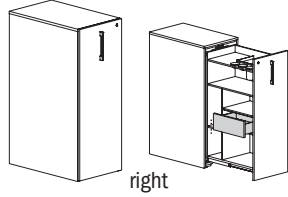

Features:

- filing brackets, accessory trays, fixed shelves and box drawer
- may not be used with Mid Support bracket to support Bench or Table Surfaces
- drawer extends 26" on 30"d units, 20" on 24"d units

Options:

- must specify drawer interior color, Designer White or Slate Grey
- must specify chassis grain direction on artisan veneer, see pages 13-15 for details
- veneer door and drawer fronts available in contrasting paint color, specify paint color and add \$372 list; see page 16 for details
- laminate door and drawer fronts available in contrasting color, no upcharge, specify color; see page 16 for details
- ledge pulls standard; prism pulls available, specify and see page 9
- locking door available, specify and add \$153 list
- wire pass-thru grommets available, specify and add \$126 list
- markerboard available on drawer back panel, specify and add \$563 list
- power jumper available; specify and add \$51 list (wire pass-thru grommet option must also be specified)

To Order, Specify:

① Laminate Model #	② Laminate Selection	③ Metal Color	④ Other Product Options			
Laminate (FLT)	See Laminate Selection	See Metal Finish Color Options	See list of options for each specific unit; Specify and add accordingly.			
① Veneer Model #	② Wood Collection	③ Wood Finish	④ Metal Color	⑤ Other Product Options		
Veneer (FLV)	Essentials	See Essentials Wood Finish Options	See Metal Finish Color Options	See list of options for each specific unit; Specify and add accordingly.		
	Artisan	<table border="1"> <thead> <tr> <th>③a Wood Finish</th> <th>③b Chassis Grain Direction</th> </tr> </thead> <tbody> <tr> <td>See Artisan Wood Finish Options</td> <td>For Artisan Only: Vertical Horizontal</td> </tr> </tbody> </table>	③a Wood Finish		③b Chassis Grain Direction	See Artisan Wood Finish Options
③a Wood Finish	③b Chassis Grain Direction					
See Artisan Wood Finish Options	For Artisan Only: Vertical Horizontal					

Description	D	W	H	CTN WT	CU FT	① Model	Laminate	Essentials Veneer	Artisan Veneer
48" h Pantry Drawer with Paper Sorter, Single User	30	18	48	209	23	FLT3018-48PTDR	\$2,863		
	30	18	48	209	23	FLV3018-48PTDR		\$3,724	\$4,079
	30	18	48	209	23	FLT3018-48PTDL	\$2,863		
	30	18	48	209	23	FLV3018-48PTDL		\$3,724	\$4,079
	24	18	48	163	18	FLT2418-48PTDR	\$2,788		
	24	18	48	163	18	FLV2418-48PTDR		\$3,623	\$3,933
	24	18	48	163	18	FLT2418-48PTDL	\$2,788		
	24	18	48	163	18	FLV2418-48PTDL		\$3,623	\$3,933

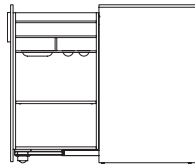
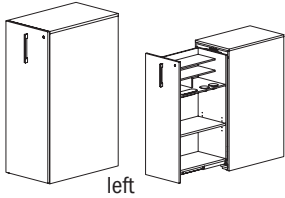
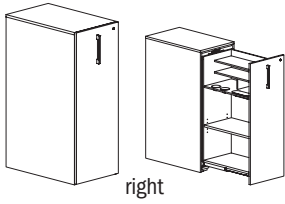

Features:

- paper shelves, accessory trays and fixed shelves
- may not be used with Mid Support bracket to support Bench or Table Surfaces
- drawer extends 26" on 30"d units, 20" on 24"d units

Options:

- must specify drawer interior color, Designer White or Slate Grey
- must specify chassis grain direction on artisan veneer, see pages 13-15 for details
- veneer door and drawer fronts available in contrasting paint color, specify paint color and add \$372 list; see pages 16 for details
- laminate door and drawer fronts available in contrasting color, no upcharge, specify color; see pages 16 for details
- ledge pulls standard; prism pulls available, specify and see page 9
- locking door available, specify and add \$153 list
- wire pass-thru grommets available, specify and add \$126 list
- markerboard available on drawer back panel, specify and add \$563 list
- power jumper available; specify and add \$51 list (wire pass-thru grommet option must also be specified)

48" h Pantry Drawer, Dual User	30	18	48	225	23	FLT3018-48PTE	\$3,069		
	30	18	48	225	23	FLV3018-48PTE		\$3,996	\$4,375
	24	18	48	184	18	FLT2418-48PTE	\$2,989		
	24	18	48	184	18	FLV2418-48PTE		\$3,887	\$4,256

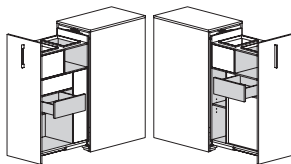
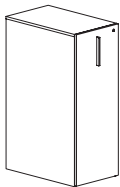

Features:

- filing brackets, fixed shelves and box drawer for each side
- may not be used with Mid Support bracket to support Bench or Table Surfaces
- drawer extends 26" on 30"d units, 20" on 24"d units

Options:

- must specify drawer interior color, Designer White or Slate Grey
- must specify chassis grain direction on artisan veneer, see pages 13-15 for details
- veneer door and drawer fronts available in contrasting paint color, specify paint color and add \$372 list; see pages 16 for details
- laminate door and drawer fronts available in contrasting color, no upcharge, specify color; see pages 16 for details
- ledge pulls standard; prism pulls available, specify and see page 9
- locking door available, specify and add \$153 list
- wire pass-thru grommets available, specify and add \$126 list
- power jumper available; specify and add \$51 list (wire pass-thru grommet option must also be specified)

Description	D	W	H	CTN WT	CU FT	① Model	List Price
Tack Panel	½	28⅞	17½	13	2	FLB30-18B1-FTK	\$203
	½	23⅞	17½	12	2	FLB24-18B1-FTK	\$166

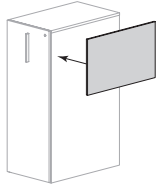

Features:

- mounts to sides of 48”h Storage Cabinets
- sizes coordinate with depth of Storage Cabinets

Options:

- select color, ash grey or silver grey

FLUX

To Order, Specify:

① Laminate Model #	② Laminate Type	③ Laminate Selection	④ Metal Color	⑤ Other Product Options
Laminate (FLT)	HPL	See Laminate Selection	See Metal Finish Color Options	See list of options for each specific unit; Specify and add accordingly.

① Veneer Model #	② Wood Collection	③ Wood Finish - Finishes with an asterisk (*) have a coordinating laminate available	④ Metal Color	⑤ Other Product Options		
Veneer (FLV)	Essentials	See Essentials Wood Finish Options	See Metal Finish Color Options	See list of options for each specific unit; Specify and add accordingly.		
	Artisan	<table border="1"> <thead> <tr> <th>③a Wood Finish</th> <th>③b Chassis Grain Direction</th> </tr> </thead> <tbody> <tr> <td>See Artisan Wood Finish Options</td> <td>For Artisan Only: Vertical Horizontal</td> </tr> </tbody> </table>	③a Wood Finish		③b Chassis Grain Direction	See Artisan Wood Finish Options
③a Wood Finish	③b Chassis Grain Direction					
See Artisan Wood Finish Options	For Artisan Only: Vertical Horizontal					

Description	D	W	H	CTN WT	CU FT	① Model	List Price
42" h Locker - Open Shelves	22	12	42	77	11	FLT2212-42FLK-E	\$1,184
	18	12	42	65	9	FLT1812-42FLK-E	\$1,118

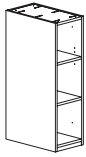

Features:

- must be connected to another locker with a common top, this unit is not freestanding; see pages 450-452 for modular tops
- one adjustable shelf and one fixed shelf (lower)
- unfinished back; modular common top & finished back panels available

42" h Locker - Storage Cabinet	22	12	42	98	11	FLT2212-42FLK-EDR	\$1,402
	22	12	42	98	11	FLT2212-42FLK-EDL	\$1,402
	18	12	42	86	9	FLT1812-42FLK-EDR	\$1,329
	18	12	42	86	9	FLT1812-42FLK-EDL	\$1,329

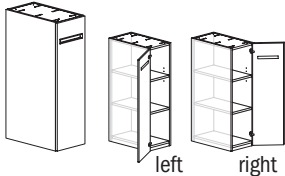

Features:

- must be connected to another locker with a common top, this unit is not freestanding; see pages 450-452 for modular tops
- one adjustable shelf and one fixed shelf (lower)
- unfinished back; modular common top & finished back panels available

Options:

- laminate door fronts available in contrasting color, no upcharge, specify color
- specify pull; see page 10
- locking options available; see page 455 for details and upcharge
- number plate available, order separately; see page 455

42" h Locker - Storage Cabinet with Wardrobe Hooks	22	12	42	96	11	FLT2212-42FLK-BDR	\$1,461
	22	12	42	96	11	FLT2212-42FLK-BDL	\$1,461
	18	12	42	85	9	FLT1812-42FLK-BDR	\$1,388
	18	12	42	85	9	FLT1812-42FLK-BDL	\$1,388

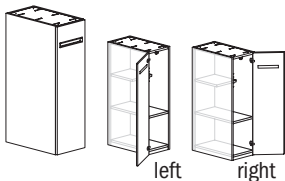

Features:

- must be connected to another locker with a common top, this unit is not freestanding; see pages 450-452 for modular tops
- one full depth fixed shelf, one shallow adjustable shelf and two coat hooks
- unfinished back; modular common top & finished back panels available

Options:

- laminate door fronts available in contrasting color, no upcharge, specify color
- specify pull; see page 10
- locking options available; see page 455 for details and upcharge
- number plate available, order separately; see page 455

42" h Locker - Wardrobe	22	12	42	89	11	FLT2212-42FLK-CDR	\$1,396
	22	12	42	89	11	FLT2212-42FLK-CDL	\$1,396
	18	12	42	79	9	FLT1812-42FLK-CDR	\$1,323
	18	12	42	79	9	FLT1812-42FLK-CDL	\$1,323

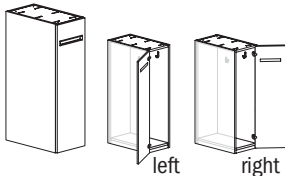

Features:

- must be connected to another locker with a common top, this unit is not freestanding; see pages 450-452 for modular tops
- one wardrobe bar in 22" d units; two coat hooks in 18" d units
- unfinished back; modular common top & finished back panels available

Options:

- laminate door fronts available in contrasting color, no upcharge, specify color
- specify pull; see page 10
- locking options available; see page 455 for details and upcharge
- number plate available, order separately; see page 455

FLUX

Description	D	W	H	CTN WT	CU FT	① Model	List Price
48" h Locker - Open Shelves	22	12	48	84	13	FLT2212-48FLK-E	\$1,239
	18	12	48	65	11	FLT1812-48FLK-E	\$1,172

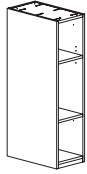

Features:

- must be connected to another locker with a common top, this unit is not freestanding; see pages 450-452 for modular tops
- one adjustable shelf and one fixed shelf (lower)
- unfinished back; modular common top & finished back panels available

48" h Locker - Storage Cabinet	22	12	48	107	13	FLT2212-48FLK-EDR	\$1,467
	22	12	48	107	13	FLT2212-48FLK-EDL	\$1,467
	18	12	48	86	11	FLT1812-48FLK-EDR	\$1,390
	18	12	48	86	11	FLT1812-48FLK-EDL	\$1,390

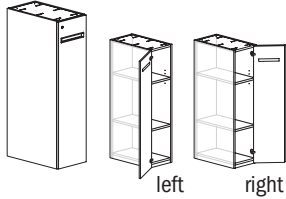

Features:

- must be connected to another locker with a common top, this unit is not freestanding; see pages 450-452 for modular tops
- one adjustable shelf and one fixed shelf (lower)
- unfinished back; modular common top & finished back panels available

Options:

- laminate door fronts available in contrasting color, no upcharge, specify color
- specify pull; see page 10
- locking options available; see page 455 for details and upcharge
- number plate available, order separately; see page 455

48" h Locker - Storage Cabinet with Wardrobe Hooks	22	12	48	106	13	FLT2212-48FLK-BDR	\$1,525
	22	12	48	106	13	FLT2212-48FLK-BDL	\$1,525
	18	12	48	94	11	FLT1812-48FLK-BDR	\$1,449
	18	12	48	94	11	FLT1812-48FLK-BDL	\$1,449

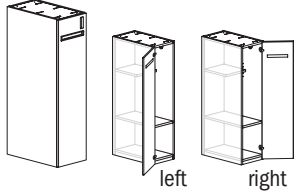

Features:

- must be connected to another locker with a common top, this unit is not freestanding; see pages 450-452 for modular tops
- one full depth fixed shelf, one shallow adjustable shelf and two coat hooks
- unfinished back; modular common top & finished back panels available

Options:

- laminate door fronts available in contrasting color, no upcharge, specify color
- specify pull; see page 10
- locking options available; see page 455 for details and upcharge
- number plate available, order separately; see page 455

To Order, Specify:

① Laminate Model #	② Laminate Type	③ Laminate Selection	④ Metal Color	⑤ Other Product Options
Laminate (FLT)	HPL	See Laminate Selection	See Metal Finish Color Options	See list of options for each specific unit; Specify and add accordingly.

Description	D	W	H	CTN WT	CU FT	① Model	List Price
48" h Locker - Wardrobe	22	12	48	99	13	FLT2212-48FLK-CDR	\$1,463
	22	12	48	99	13	FLT2212-48FLK-CDL	\$1,463
	18	12	48	88	11	FLT1812-48FLK-CDR	\$1,388
	18	12	48	88	11	FLT1812-48FLK-CDL	\$1,388

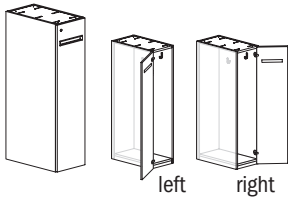

Features:

- must be connected to another locker with a common top, this unit is not freestanding; see pages 450-452 for modular tops
- one wardrobe bar in 22" d units; two coat hooks in 18" d units
- unfinished back; modular common top & finished back panels available

Options:

- laminate door fronts available in contrasting color, no upcharge, specify color
- specify pull; see page 10
- locking options available; see page 455 for details and upcharge
- number plate available, order separately; see page 455

69" h Locker - Open Shelves	22	12	69	116	13	FLT2212-69FLK-F	\$1,386
	18	12	69	98	11	FLT1812-69FLK-F	\$1,311

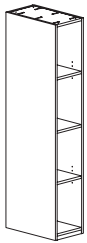

Features:

- must be connected to another locker with a common top, this unit is not freestanding; see pages 450-452 for modular tops
- two adjustable shelves and one fixed shelf (center)
- unfinished back; modular common top & finished back panels available

69" h Locker - Storage Cabinet	22	12	69	150	18	FLT2212-69FLK-FDR	\$1,644
	22	12	69	150	18	FLT2212-69FLK-FDL	\$1,644
	18	12	69	133	15	FLT1812-69FLK-FDR	\$1,558
	18	12	69	133	15	FLT1812-69FLK-FDL	\$1,558

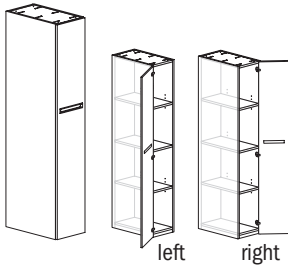

Features:

- must be connected to another locker with a common top, this unit is not freestanding; see pages 450-452 for modular tops
- two adjustable shelves and one fixed shelf (center)
- unfinished back; modular common top & finished back panels available

Options:

- laminate door fronts available in contrasting color, no upcharge, specify color
- specify pull; see page 10
- locking options available; see page 455 for details and upcharge
- number plate available, order separately; see page 455

69" h Locker - Storage Cabinet with Wardrobe Hooks	22	12	69	146	18	FLT2212-69FLK-GDR	\$1,708
	22	12	69	146	18	FLT2212-69FLK-GDL	\$1,708
	18	12	69	130	15	FLT1812-69FLK-GDR	\$1,624
	18	12	69	130	15	FLT1812-69FLK-GDL	\$1,624

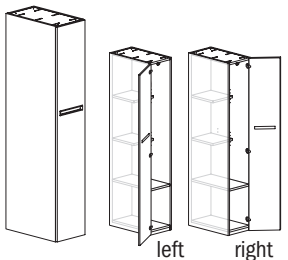

Features:

- must be connected to another locker with a common top, this unit is not freestanding; see pages 450-452 for modular tops
- one full depth fixed shelf, two shallow adjustable shelves and two coat hooks
- unfinished back; modular common top & finished back panels available

Options:

- laminate door fronts available in contrasting color, no upcharge, specify color
- specify pull; see page 452
- locking options available; see page 452 for details and upcharge
- number plate available, order separately; see page 455

Description	D	W	H	CTN WT	CU FT	① Model	List Price
69" h Locker - Wardrobe	22	12	69	141	18	FLT2212-69FLK-HDR	\$1,666
	22	12	69	141	18	FLT2212-69FLK-HDL	\$1,666
	18	12	69	125	15	FLT1812-69FLK-HDR	\$1,581
	18	12	69	125	15	FLT1812-69FLK-HDL	\$1,581

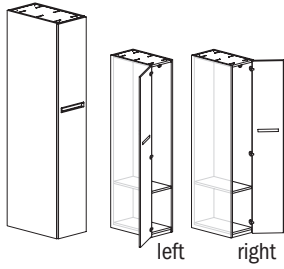

Features:

- must be connected to another locker with a common top, this unit is not freestanding; see pages 450-452 for modular tops
- one full depth fixed shelf and one wardrobe bar in 22" d units; two coat hooks in 18" d units
- unfinished back; modular common top & finished back panels available

Options:

- laminate door fronts available in contrasting color, no upcharge, specify color
- specify pull; see page 10
- locking options available; see page 455 for details and upcharge
- number plate available, order separately; see page 455

69" h Dual Locker - Storage Cabinet	22	12	69	151	18	FLT2212-69FLK-F2DR	\$1,689
	22	12	69	151	18	FLT2212-69FLK-F2DL	\$1,689
	18	12	69	133	15	FLT1812-69FLK-F2DR	\$1,602
	18	12	69	133	15	FLT1812-69FLK-F2DL	\$1,602

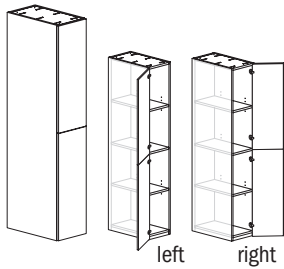

Features:

- must be connected to another locker with a common top, this unit is not freestanding; see pages 450-452 for modular tops
- one adjustable shelf per compartment
- unfinished back; modular common top & finished back panels available

Options:

- laminate door fronts available in contrasting color, no upcharge, specify color
- specify pull; see page 10
- locking options available; see page 455 for details and upcharge
- number plate available, order separately; see page 455

69" h Triple Locker - Storage Cabinet	22	12	69	160	18	FLT2212-69FLK-J3DR	\$1,731
	22	12	69	160	18	FLT2212-69FLK-J3DL	\$1,731
	18	12	69	140	15	FLT1812-69FLK-J3DR	\$1,646
	18	12	69	140	15	FLT1812-69FLK-J3DL	\$1,646

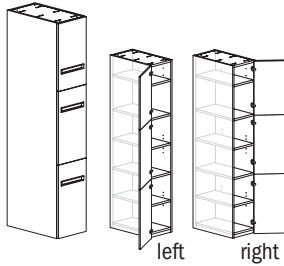

Features:

- must be connected to another locker with a common top, this unit is not freestanding; see pages 450-452 for modular tops
- one adjustable shelf per compartment
- unfinished back; modular common top & finished back panels available

Options:

- laminate door fronts available in contrasting color, no upcharge, specify color
- specify pull; see page 10
- locking options available; see page 455 for details and upcharge
- number plate available, order separately; see page 455

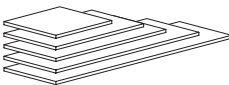
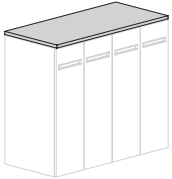

To Order, Specify:

① Laminate Model #	② Laminate Type	③ Laminate Selection	④ Metal Color	⑤ Other Product Options
Laminate (FLT)	HPL	See Laminate Selection	See Metal Finish Color Options	See list of options for each specific unit; Specify and add accordingly.

Description	D	W	H	CTN WT	CU FT	Model	List Price
Modular Top - Single Depth Locker   in application	22	96 1/8	1 3/16	78	5	FLT2296LKMT	\$844
	22	84 1/8	1 3/16	69	5	FLT2284LKMT	\$740
	22	72 1/8	1 3/16	60	4	FLT2272LKMT	\$634
	22	60 1/8	1 3/16	50	4	FLT2260LKMT	\$529
	22	48 1/8	1 3/16	42	3	FLT2248LKMT	\$426
	22	36 1/8	1 3/16	33	2	FLT2236LKMT	\$320
	22	24 1/8	1 3/16	24	2	FLT2224LKMT	\$250
	18	96 1/8	1 3/16	65	5	FLT1896LKMT	\$828
	18	84 1/8	1 3/16	56	4	FLT1884LKMT	\$723
	18	72 1/8	1 3/16	50	4	FLT1872LKMT	\$621
	18	60 1/8	1 3/16	44	3	FLT1860LKMT	\$518
	18	48 1/8	1 3/16	35	3	FLT1848LKMT	\$416
	18	36 1/8	1 3/16	28	2	FLT1836LKMT	\$312
	18	24 1/8	1 3/16	20	2	FLT1824LKMT	\$245

Features:

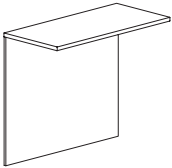
- use with modular Locker Storage Cabinets
- eased edge profile user side

42" h Modular Top & Common Back - Single Depth Locker   in application	22 3/4	60 1/8	42	105	44	FLT2360-42LKMTB	\$1,259
	22 3/4	48 1/8	42	85	36	FLT2348-42LKMTB	\$1,008
	22 3/4	36 1/8	42	65	28	FLT2336-42LKMTB	\$759
	22 3/4	24 1/8	42	45	20	FLT2324-42LKMTB	\$593
	18 3/4	60 1/8	42	97	38	FLT1960-42LKMTB	\$1,249
	18 3/4	48 1/8	42	85	31	FLT1948-42LKMTB	\$1,001
	18 3/4	36 1/8	42	60	24	FLT1936-42LKMTB	\$752
	18 3/4	24 1/8	42	42	17	FLT1924-42LKMTB	\$588

Features:

- use with modular Locker Storage Cabinets to create a finished back
- eased edge profile user side

FLUX

Description	D	W	H	CTN WT	CU FT	① Model	List Price
48" h Modular Top & Common Back - Single Depth Locker	22 3/4	60 1/8	48	113	50	FLT2360-48LKMTB	\$1,363
	22 3/4	48 1/8	48	91	41	FLT2348-48LKMTB	\$1,094
	22 3/4	36 1/8	48	69	32	FLT2336-48LKMTB	\$823
	22 3/4	24 1/8	48	49	23	FLT2324-48LKMTB	\$643
	18 3/4	60 1/8	48	104	43	FLT1960-48LKMTB	\$1,355
	18 3/4	48 1/8	48	85	35	FLT1948-48LKMTB	\$1,083
	18 3/4	36 1/8	48	65	27	FLT1936-48LKMTB	\$814
	18 3/4	24 1/8	48	45	19	FLT1924-48LKMTB	\$638

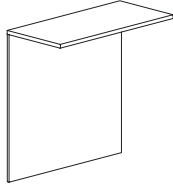

in application

Features:

- use with modular Locker Storage Cabinets to create a finished back
- eased edge profile user side

Description	D	W	H	CTN WT	CU FT	① Model	List Price
69" h Modular Top & Common Back - Single Depth Locker	22 3/4	60 1/8	69	140	71	FLT2360-69LKMTB	\$1,728
	22 3/4	48 1/8	69	113	58	FLT2348-69LKMTB	\$1,384
	22 3/4	36 1/8	69	80	45	FLT2336-69LKMTB	\$1,043
	22 3/4	24 1/8	69	59	31	FLT2324-69LKMTB	\$813
	18 3/4	60 1/8	69	132	60	FLT1960-69LKMTB	\$1,720
	18 3/4	48 1/8	69	107	49	FLT1948-69LKMTB	\$1,377
	18 3/4	36 1/8	69	80	38	FLT1936-69LKMTB	\$1,033
	18 3/4	24 1/8	69	56	27	FLT1924-69LKMTB	\$809

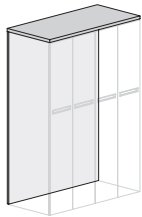
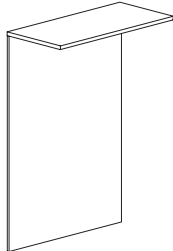

Features:

- use with modular Locker Storage Cabinets to create a finished back
- eased edge profile user side

To Order, Specify:

① Laminate Model #	② Laminate Type	③ Laminate Selection	④ Metal Color	⑤ Other Product Options
Laminate (FLT)	HPL	See Laminate Selection	See Metal Finish Color Options	See list of options for each specific unit; Specify and add accordingly.

FLUX

Description	D	W	H	CTN WT	CU FT	① Model	List Price
Modular Top - Back to Back Lockers	44	96½	1¾	150	9	FLT4496LKMT	\$1,671
	44	84½	1¾	133	8	FLT4484LKMT	\$1,465
	44	72½	1¾	114	7	FLT4472LKMT	\$1,259
	44	60½	1¾	96	6	FLT4460LKMT	\$1,043
	44	48½	1¾	78	5	FLT4448LKMT	\$741
	44	36½	1¾	60	4	FLT4436LKMT	\$636
	44	24½	1¾	42	3	FLT4424LKMT	\$382
	36	96½	1¾	124	8	FLT3696LKMT	\$1,374
	36	84½	1¾	109	7	FLT3684LKMT	\$1,205
	36	72½	1¾	95	6	FLT3672LKMT	\$1,033
in application	36	61½	1¾	80	5	FLT3660LKMT	\$864
	36	48½	1¾	65	4	FLT3648LKMT	\$697
	36	36½	1¾	35	3	FLT3636LKMT	\$537
	36	24½	1¾	35	3	FLT3624LKMT	\$327

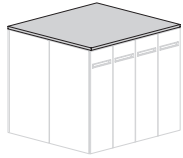
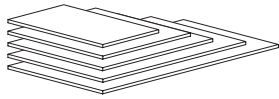

in application

Features:

- use with modular Locker Storage Cabinets to span back-to-back units
- eased edge profile user side

Description	D	W	H	CTN WT	CU FT	① Model	List Price
Locker Number Plate	1/8	1	1	1	1	FLB-NUMPLT	\$41

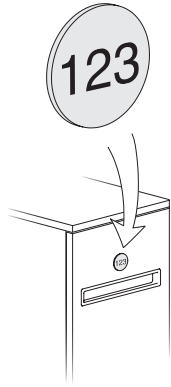

Features:

- helvetica font, 1-3 character

Options:

- select silver with black numerals or black with silver numerals

Lock & Key				1	1	FLB-LOCKCORE-A	\$34
------------	--	--	--	---	---	----------------	------

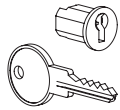

Features:

- key #'s start at 100

Options:

- select key #'s
- select Silver or Black

Digital Lock Master Key				1	1	FLB-MASTKEY-B	\$109
-------------------------	--	--	--	---	---	---------------	-------

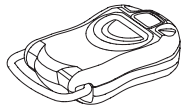

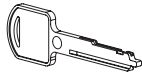

Keyless Radial Lock Master Key				1	1	FLB-MASTKEY-C	\$109
--------------------------------	--	--	--	---	---	---------------	-------

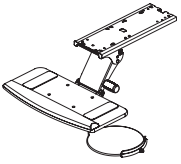
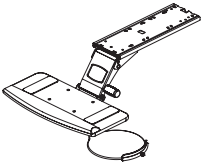
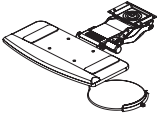
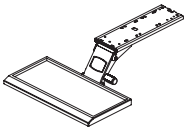

To Order, Specify:

① Laminate Model #	② Laminate Type	③ Laminate Selection	④ Metal Color	⑤ Other Product Options
Laminate (FLT)	HPL	See Laminate Selection	See Metal Finish Color Options	See list of options for each specific unit; Specify and add accordingly.

Description	D	W	H	CTN WT	CU FT	① Model	List Price
 <p>Articulating Keyboard Tray</p> <ul style="list-style-type: none"> · articulating keyboard tray - black color · mouse tray included · 16" glide track · easy one-handed adjustment; vertical range of motion of 5.1" below glide track · tray tilt range +10 degree to -20 degree · unit swivels side-to-side · tray size is 19.4" wide x 9.4" deep · tray includes palm rest · tray is made with recyclable high density polyethylene 	13	24	7	14	2	AK2	\$558
 <p>Articulating Keyboard Tray</p> <ul style="list-style-type: none"> · articulating keyboard tray - black color · mouse tray included · 17" glide track · easy one-handed adjustment; vertical range of motion of 8.9"; (6.5" below the glide track and an additional 2.38" above) · tray tilt range +10 degree to -20 degree · unit swivels side-to-side · tray size is 19.4" wide x 9.4" deep · tray includes palm rest · tray is made with recyclable high density polyethylene 	13	24	7	12	2	AK3	\$590
 <p>Articulating Keyboard Tray</p> <ul style="list-style-type: none"> · articulating keyboard tray - wood finish tray with black mechanism · mouse tray included · use when depth under work surface for mounting is limited; minimum of 9.38" depth recommended · easy one-handed adjustment; vertical range of motion of 5.73 · tray tilt range +10 degree to -20 degree · unit swivels side-to-side · tray size is 21.75" wide x 11" deep · wood tray requires finish selection; see component finishes for the selection 	11	23	3	11	2	AK5	\$575
 <p>Articulating Keyboard Tray</p> <ul style="list-style-type: none"> · trackless articulating keyboard tray - black color · mouse tray included · use when depth under work surface for mounting is limited; minimum of 9.38" depth recommended · easy one-handed adjustment; vertical range of motion of 5.73 · tray tilt range +10 degree to -15 degree · unit swivels side-to-side · tray size is 19.4" wide x 9.4" deep · tray includes palm rest · tray is made with recyclable high density polyethylene 	14	23	7	15	2	AK4	\$622
 <p>Keyboard Tray Mouse Pad</p> <ul style="list-style-type: none"> · adjusts for user comfort · 8" x 8" · for left or right hand operation · compatible with AK4 Keyboard Drawer only 	8	8	1/4	2		MT4	\$210

FLUX

Description	D	W	H	CTN WT	CU FT	① Model	List Price
Monitor Support Arm	12	6	17	9		AMA3B	\$693

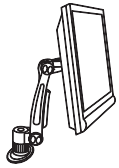

- 360 degree swivel
- adjusts height, tilt and distance of monitor screen to user
- integrated cable management
- grommet and edge clamp mount included
- black finish
- monitor not included
- will fit monitors made to the VESA standard of 75 mm or 100 mm hole spacing in a square configuration

Monitor Arm - Edge Mount				9	1	GP5901MA	\$738
--------------------------	--	--	--	---	---	----------	-------

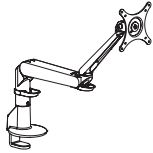

- mounts to edge of worksurface
- silver or black

Dual Monitor Arm - Edge Mount				18	2	GP5902MA	\$1,329
-------------------------------	--	--	--	----	---	----------	---------

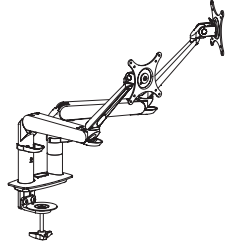

- mounts to edge of worksurface
- supports two monitors
- silver or black

Monitor Arm				9	1	GP5905MA	\$823
-------------	--	--	--	---	---	----------	-------

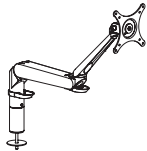

- mounts through hole in worksurface
- field drilled and field installed
- supports up to 12 lbs and/or 27" monitor
- silver or black

LED Tasklight	1/2	60	3/4	3	1	TL60LEDF	\$362
	1/2	45	3/4	3	1	TL45LEDF	\$311
	1/2	39	3/4	3	1	TL39LEDF	\$276
	1/2	27	3/4	3	1	TL27LEDF	\$241

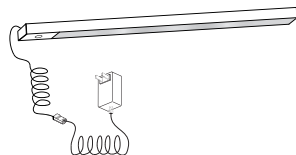

- low profile LED tasklight
- 4000K cool white
- touch on/off switch
- touch and hold dimming
- 13ft cord
- recommended tasklight length for each cabinet size; see chart on page 33

To Order, Specify:

① Model Number

Description	D	W	H	CTN WT	CU FT	① Model	List Price
Wide Pencil Drawer	19 1/4	22	1 7/8	5	1	GP2219CD	\$135

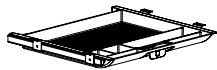

· plastic

Pencil Drawer	19 1/4	16 1/8	2 3/8	4	1	GP1619CD	\$124
---------------	--------	--------	-------	---	---	----------	-------



· plastic

Center Nook Drawer	8 1/4	15 1/4	2	2	1	GP1509CD	\$119
--------------------	-------	--------	---	---	---	----------	-------

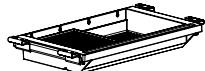

· plastic

Worksurface Power	2 5/8	6 3/8	3	3	1	EC26	\$486
-------------------	-------	-------	---	---	---	------	-------

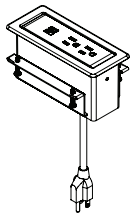

- two (2) AC 15 amp 120 volt power outlets
- one (1) 2.4A reversible USB-A charging port & one (1) 60-watt USB-C power delivery port
- 120" power cord with molded plug
- UL Listed
- meets UL spill requirements
- White (W) or Black (B) finish available, specify when ordering

Edge Mount Power	3 1/2	5 1/2	7 1/2	3	1	EC28	\$429
------------------	-------	-------	-------	---	---	------	-------

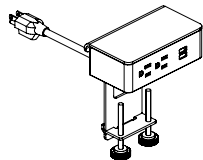

- two (2) AC 15 amp 120 volt power outlets
- one (1) 2.4A reversible USB-A charging port & one (1) 60-watt USB-C power delivery port
- 120" power cord with molded plug
- UL Listed
- White (W) or Black (B) finish available, specify when ordering

FLUX

Description	D	W	H	CTN WT	CU FT	① Model	List Price
Wireless Charging Unit	3½	3½	1	3	1	EC33	\$362

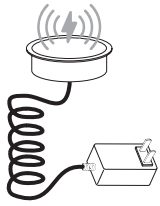

- wireless charging for use with Q enabled devices
- 72" power cord
- black
- UL Listed
- CE / FCC certified

Under Surface Convenience Power Unit	3½	7½	2½	3	1	EC34	\$316
---	----	----	----	---	---	------	-------

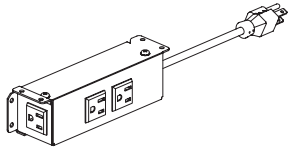

- three outlets
- 120" power cord
- black
- ETL Listed for US

FLUX

To Order, Specify:

① Model Number

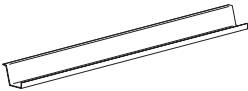
Description	D	W	H	CTN WT	CU FT	① Model	List Price
Metal Wire Manager 	3 1/16	80	2 13/16	10	6	FLB0480MWM	\$603
	3 1/16	74	2 13/16	9	6	FLB0474MWM	\$591
	3 1/16	68	2 13/16	9	5	FLB0468MWM	\$539
	3 1/16	62	2 13/16	8	4	FLB0462MWM	\$523
	3 1/16	56	2 13/16	7	4	FLB0456MWM	\$496
	3 1/16	50	2 13/16	7	4	FLB0450MWM	\$438
	3 1/16	44	2 13/16	6	4	FLB0444MWM	\$416
	3 1/16	38	2 13/16	5	3	FLB0438MWM	\$408
	3 1/16	32	2 13/16	4	2	FLB0432MWM	\$401

- to be used with peninsula and runoff desks; see chart on pages 50-51 for appropriate size to be used
- 3 gauge steel mounting plate

Flexible Wire Manager - Surface to Surface	1	2	30	4	1	GP230VWM	\$211
---	---	---	----	---	---	----------	-------



- 30" flexible vertical wire manager with one vertical mounting bracket and one magnetic attachment bracket
- black with silver accents

Flexible Wire Manager - Surface to Surface	1	2	40	4	1	GP240VWM	\$271
---	---	---	----	---	---	----------	-------



- 40" flexible vertical wire manager with one vertical mounting bracket and one magnetic attachment bracket
- black with silver accents

Flexible Wire Manager - Surface to Floor	1	2	50	12	1	GP250VWM	\$325
---	---	---	----	----	---	----------	-------



- 50" flexible vertical wire manager with one vertical mounting bracket and one counter weight base
- black with silver accents

Description	D	W	H	CTN WT	CU FT	❶ Model	List Price
Portable Slide on Screen	1	24	21 ½	10	2	GPB2422PDP	\$891

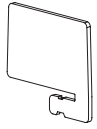

- works with any surface material
- works in any location, with the exception of where tilt release paddle is located on tilting tables
- specify Ash Grey (ASH) or Silver Grey (SIL)

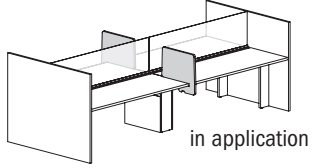

FLUX

To Order, Specify:

❶ Model Number	
-----------------------	--