

Forge - Overview

Base Cabinets

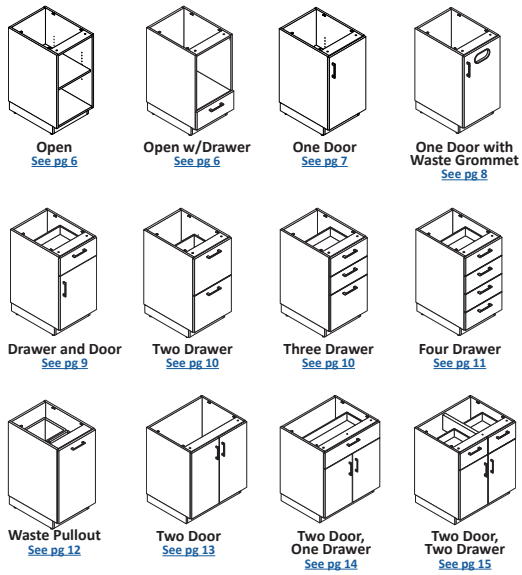

Base Sink Cabinets

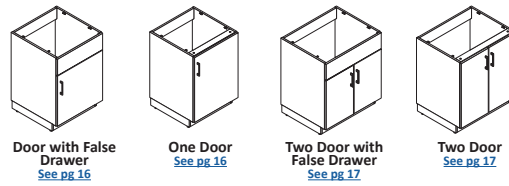

Base Filler & End Panels

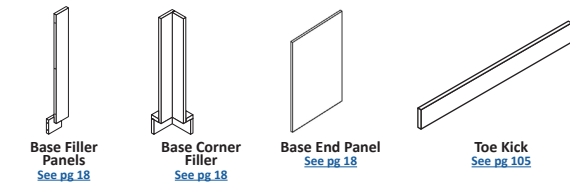

Wall Hanging Base Cabinets

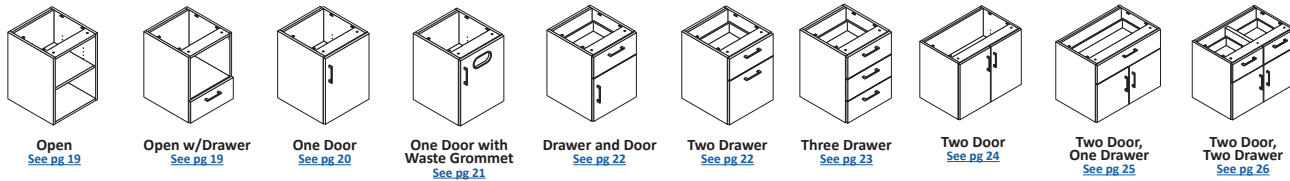

Wall Hanging Sink Cabinets

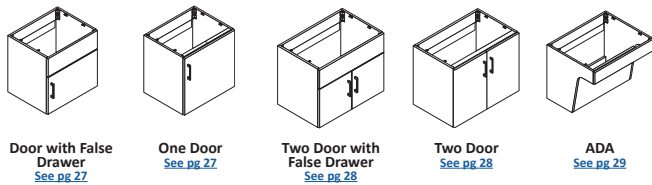

Wall Filler Panels

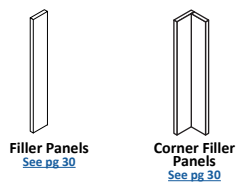

HPL Worksurfaces



Forge - Overview

Solid Surface Worksurfaces

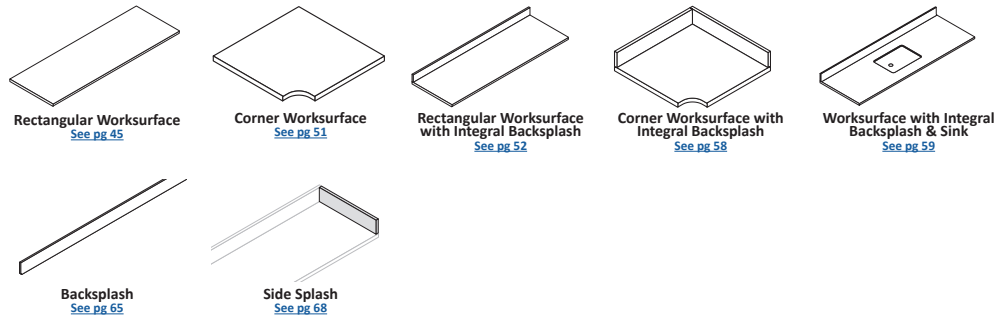

Accessories

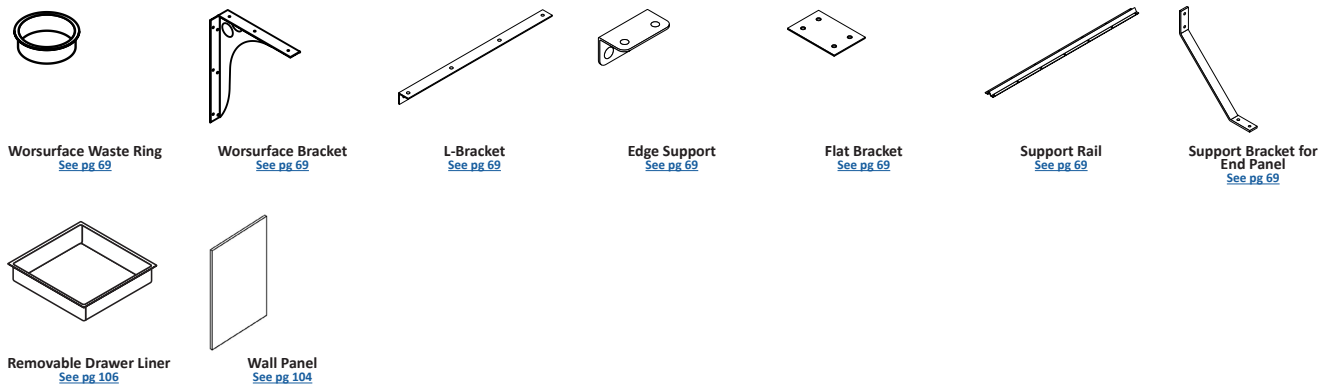

Upper Cabinets

Flat Top

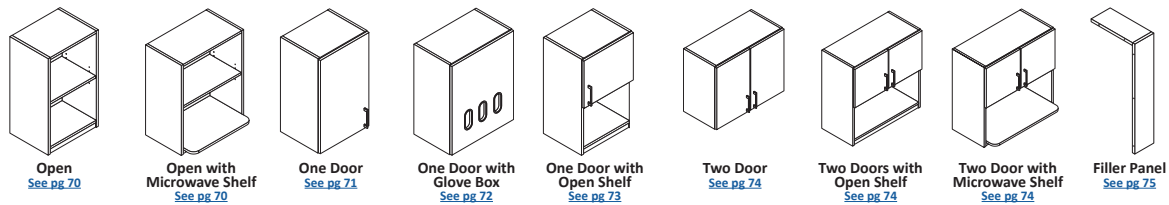

Sloped Top

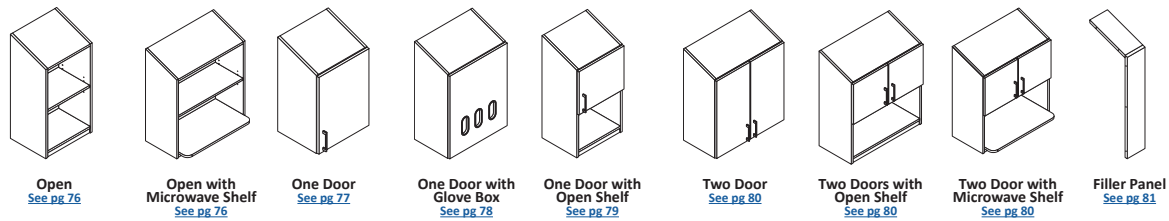

Forge - Overview

Storage Cabinets

Flat Top

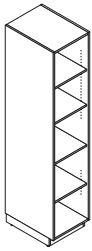

Open
See pg 82

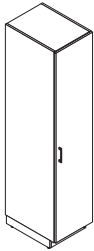

One Door
See pg 83

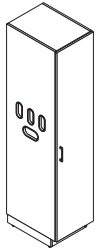

One Door with
Glove Box
See pg 85

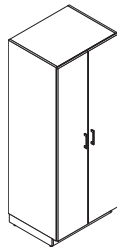

Two Door
See pg 87

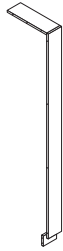

Filler Panels
See pg 88

Sloped Top

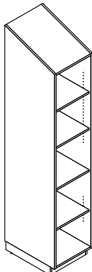

Open
See pg 89

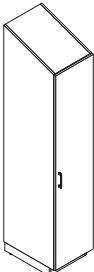

One Door
See pg 90

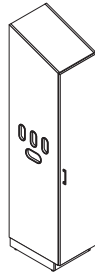

One Door with
Glove Box
See pg 92

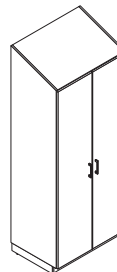

Two Door
See pg 94



Filler Panels
See pg 95

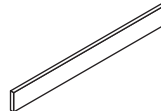

Toe Kick
See pg 105

Lockers

Flat Top

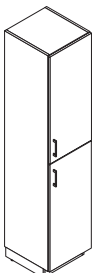

Two Door
See pg 96

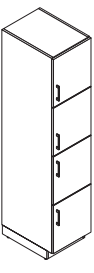

Four Door
See pg 98

Sloped Top

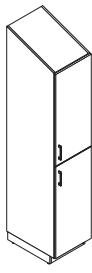

Two Door
See pg 100

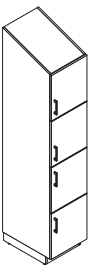

Four Door
See pg 102

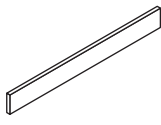

Toe Kick
See pg 105

Forge Product Information

NOTE: Forge storage must be anchored to a wall (hardware not included); not intended for freestanding use. [Reference Installation Instructions for more details.](#)

WorkSurfaces

Forge offers worksurfaces in both HPL Laminate and Solid Surfaces. Laminate worksurfaces have a 3-ply balanced construction. Tops are 1 3/16" thick with coordinating PVC edges. Worksurfaces feature 3mm eased (PVC) edge on the front; sides and back have coordinating 1mm PVC edge band.

Forge worksurfaces are available in all JSI standard HPL's, consisting of 19 wood grain patterns and 7 solid colors. Each has a coordinating PVC edge color that is automatically used with the standard laminates. The wood grain laminate features an embossed grain to hide finger prints and light scratches. The solid laminate is smooth to the touch with a semi-matte finish.

The chart below lists the laminates available on the Forge product.

TFL - HPL Wood Grain Pattern Laminates

BEL Belair	MIN Mineral
BRK Brickdust	MCH Mocha
CSK Cask	OBK Outback
CLY Clay	PIL Pilsner
EGR Egret	PIN Pinnacle Walnut
FAW Fawn	UMB Umber
FLN Flint	VAL Valley
FLO Florence Walnut	WLH Walnut Heights
LOF Loft	WEA Weathered Ash
MES Mesa	

TFL - HPL Solid Laminates

ALB Alabaster	SHD Shadow
BLK Black	SLG Slate Grey
BBL Bridal Blanco	ZEN Zen Grey
DWH Designer White	

In addition, an extensive list of HPL laminates from Wilsonart and Formica are available at the Tier 2 price, [see pages 107-108](#). Selecting from the Tier 2 laminates will require a PVC banding to be specified from the standard list.

Solid surface worksurfaces are 1" thick and have a moisture-resistant core. Front edge features a 3mm radius eased edge, sides and back have finished flat edge. Worksurfaces are available in 4 standard JSI colors.

DWH Designer White	ONX Black Onyx Mirage
HST Hot Stone	SOG Soothing Grey

Additional Wilsonart and Corian finishes are available in 4 pricing tiers, [see pages 109-110](#).

Cabinet Construction

Forge Laminate features TFL (thermally fused laminate) chassis with standard banding. Worksurfaces are available in a HPL (high pressure laminate) with standard banding.

Thermally fused laminate (TFL) with all edges fully banded. Interior material matches exterior. 3/4" thick side panels. Adjustable glides on base cabinets, storage cabinets and lockers; they provide 1" adjustment. Must use toe kick or cove molding to finish off base cabinets.

Grain direction runs vertically on all door/drawer fronts. Door and drawer fronts are banded with a 2mm banding.

Drawers

The unidirectional V- Fold drawer box is a durable miter-fold drawer structure which is glued and doweled. The 1/2" thick drawer sides are wrapped in a high grade white vinyl, with an attached front. The drawer front is attached to the four sided box.

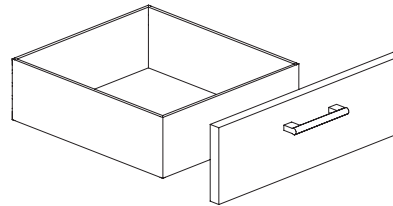

Drawer Suspension

High quality soft close, silver drawer suspension carries a lifetime warranty. Drawers have 100% full extension with over travel. Slides feature steel ball bearings for longer wear and positive, cushioned in/out stops.

Drawer Liner

Seamless, one-piece, white drawer liner available for 18" and 24" wide drawers.

Hinges

Concealed Euro soft close hinges with 110° opening and four adjustment points.

Locking

Cabinets offer locking to provide maximum security and flexibility in configuration. Up-charge applies. Locks are available as a standard keyed lock or a digital keyless lock.

When standard locks are ordered, units are shipped randomly keyed. Key alike units are available upon request for no additional charges. Removable cores for in-field re-keying are standard. Lock face color is available in Arctic Silver or Matte Black.

Digital Keyless Locks come pre-programmed for shared use, but can be field programmed for dedicated use. To lock, enter a 4 to 8 digit code and press the lock button. To unlock reenter the previous 4 to 8 digit code and press the unlock button. User guide ships with cabinet. Keyless lock will be oriented vertically on drawer units and horizontally on doors. Lock face is available in a black finish.



Wall Panels

3/4" thick with standard TFL 1/2" banding.

Forge Product Information

Top Edge Profile

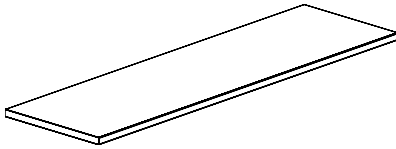

Tops feature a 3mm radius front edge, sides and back are flat

Pull and Color Options



Bar

MBK Matte Black
PNK Polished Nickel



Sweep

MBK Matte Black
MNK Matte Nickel



Delve



Prospect

Metal Finish Standard

ABZ Aged Bronze	MBK Matte Black
ASL Arctic Silver	PEW Pewter
BWH Bright White	SBZ Soft Bronze
GLD Gold	SNK Soft Nickel

Metal Finish Upcharge - add \$52

ANL Antique Linen	EBL Electric Blue	POW Porcelain White
BLJ Blue Jean	EMC Emerald City	SPA Space Cadet
CAP Candy Apple	EVP Evergreen Pine	SPP Sparkling Peach
CAB Cashmere Beige	GOH Golden Honey	SPR Spiced Raisin
CDU Copper Dust	MWH Midnight Whisper	SMK Stormy Sky
DST Desert Stone	MUS Mustard Seed	TFB Toffee Brown
DUP Dusty Petal	OLV Olive Fog	VMA Vintage Mahogany

Bar, Sweep and Delve are ADA compliant.

Pull Alignment

Bar, Sweep and Delve pulls are mounted on the front of drawer/door. Prospect pull overlays the top of the drawer and door front. Bar and Sweep pulls are standard in one length for every application. Delve and Prospect pulls offer an enhanced aesthetic on 30"- 36" wide drawer cabinets with an elongated version. In these cases, the longer pull is used in appropriate applications- user need not specify.

Boring Dimensions

24" wide or smaller

Sweep, Delve and Bar- 128mm

Prospect- 216mm

30" & 36" wide

Delve- 320mm

Prospect- 419mm

Integral Sink

Sink is always Designer White independent of selection of worksurface. Sink location is available in 1" increments from left side of worksurface to centerline of sink with minimum of 12" to centerline from either edge of surface. Sink should always be centered over sink cabinet. Drain hole is nominally 1 3/4" diameter and accepts standard drain hardware (not included).

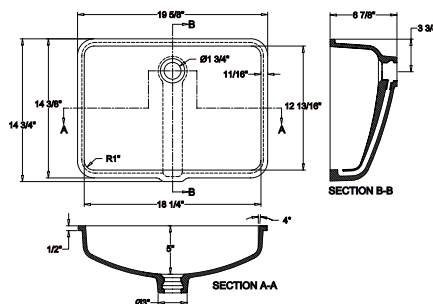
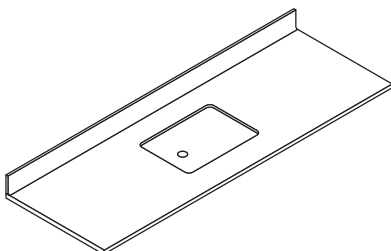

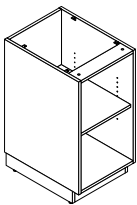
Description	D	W	H	CTN WT	CU FT	Model	List
Open Base Cabinet 	23 1/2	36	35	97	21	40C243635BCT	\$1,185
	23 1/2	30	35	87	18	40C243035BCT	\$1,142
	23 1/2	24	35	76	15	40C242435BCT	\$1,093
	23 1/2	21	35	70	13	40C242135BCT	\$1,051
	23 1/2	18	35	65	11	40C241835BCT	\$1,008
	23 1/2	15	35	59	10	40C241535BCT	\$965
	23 1/2	12	35	54	8	40C241235BCT	\$917
	23 1/2	36	32 1/2	93	20	40C243633BCT	\$1,051
	23 1/2	30	32 1/2	82	17	40C243033BCT	\$1,029
	23 1/2	24	32 1/2	72	14	40C242433BCT	\$1,008
	23 1/2	21	32 1/2	66	12	40C242133BCT	\$981
	23 1/2	18	32 1/2	61	11	40C241833BCT	\$954
	23 1/2	15	32 1/2	56	9	40C241533BCT	\$927
	23 1/2	12	32 1/2	51	8	40C241233BCT	\$901

• one adjustable shelf

Specify: Model | Chassis Laminate

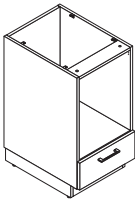
Description	D	W	H	CTN WT	CU FT	Model	List
Open Base Cabinet with Drawer 	24 1/4	36	35	90	22	40C243635BC1T	\$2,009
	24 1/4	30	35	81	18	40C243035BC1T	\$1,940
	24 1/4	24	35	71	15	40C242435BC1T	\$1,875
	24 1/4	21	35	66	13	40C242135BC1T	\$1,811
	24 1/4	18	35	62	12	40C241835BC1T	\$1,747
	24 1/4	15	35	57	10	40C241535BC1T	\$1,682
	24 1/4	12	35	52	8	40C241235BC1T	\$1,619
	24 1/4	36	32 1/2	89	20	40C243633BC1T	\$1,897
	24 1/4	30	32 1/2	80	17	40C243033BC1T	\$1,828
	24 1/4	24	32 1/2	71	14	40C242433BC1T	\$1,760
	24 1/4	21	32 1/2	66	13	40C242133BC1T	\$1,693
	24 1/4	18	32 1/2	61	11	40C241833BC1T	\$1,625
	24 1/4	15	32 1/2	57	9	40C241533BC1T	\$1,558
	24 1/4	12	32 1/2	52	8	40C241233BC1T	\$1,490

Specify: Model | Chassis Laminate | Drawer Laminate | Pull | Lock

Model	Chassis Laminate	Drawer Laminate	Pull	Lock
	see Forge Laminate Finishes	see Forge Laminate Finishes	P001 Bar see Bar Pull Color P005 Delve see Delve Pull Color P011 Prospect see Prospect Pull Color P003 Sweep see Sweep Pull Color	NLK No Lock KLK Standard - add \$85 ASL Arctic Silver MBK Matte Black DLK Keyless Lock - add \$250

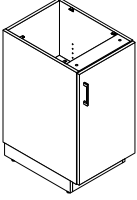
Description	D	W	H	CTN WT	CU FT	Model	List
One Door Base - Right Hinged Cabinet 	24 ¼	24	35	91	15	40C242435BCDRT	\$1,228
	24 ¼	21	35	84	13	40C242135BCDRT	\$1,215
	24 ¼	18	35	76	12	40C241835BCDRT	\$1,200
	24 ¼	15	35	69	10	40C241535BCDRT	\$1,160
	24 ¼	12	35	62	8	40C241235BCDRT	\$1,138
	24 ¼	24	32 ½	86	14	40C242433BCDRT	\$1,129
	24 ¼	21	32 ½	79	13	40C242133BCDRT	\$1,120
	24 ¼	18	32 ½	72	11	40C241833BCDRT	\$1,112
	24 ¼	15	32 ½	65	9	40C241533BCDRT	\$1,104
	24 ¼	12	32 ½	58	8	40C241233BCDRT	\$1,094

• one adjustable shelf

Specify: Model | Chassis Laminate | Door Laminate | Pull | Lock

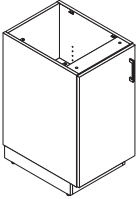
One Door Base - Left Hinged Cabinet 	24 ¼	24	35	91	15	40C242435BCDLT	\$1,228
	24 ¼	21	35	84	13	40C242135BCDLT	\$1,215
	24 ¼	18	35	76	12	40C241835BCDLT	\$1,200
	24 ¼	15	35	69	10	40C241535BCDLT	\$1,160
	24 ¼	12	35	62	8	40C241235BCDLT	\$1,138
	24 ¼	24	32 ½	86	14	40C242433BCDLT	\$1,129
	24 ¼	21	32 ½	79	13	40C242133BCDLT	\$1,120
	24 ¼	18	32 ½	72	11	40C241833BCDLT	\$1,112
	24 ¼	15	32 ½	65	9	40C241533BCDLT	\$1,104
	24 ¼	12	32 ½	58	8	40C241233BCDLT	\$1,094

• one adjustable shelf

Specify: Model | Chassis Laminate | Door Laminate | Pull | Lock

Model	Chassis Laminate	Door Laminate	Pull	Lock
	see Forge Laminate Finishes	see Forge Laminate Finishes	P001 Bar see Bar Pull Color P005 Delve see Delve Pull Color P011 Prospect see Prospect Pull Color P003 Sweep see Sweep Pull Color	NLK No Lock KLK Standard - add \$85 ASL Arctic Silver MBK Matte Black DLK Keyless Lock - add \$250

Description	D	W	H	CTN WT	CU FT	Model	List
One Door Base - Right Hinged Cabinet, Waste Grommet	24 ¼	24	35	91	15	40C242435BCDRTGT	\$1,255
	24 ¼	21	35	84	13	40C242135BCDRTGT	\$1,242
	24 ¼	18	35	76	12	40C241835BCDRTGT	\$1,227
	24 ¼	15	35	69	10	40C241535BCDRTGT	\$1,217
	24 ¼	12	35	62	8	40C241235BCDRTGT	\$1,192
	24 ¼	24	32 ½	86	14	40C242433BCDRTGT	\$1,177
	24 ¼	21	32 ½	79	13	40C242133BCDRTGT	\$1,162
	24 ¼	18	32 ½	72	11	40C241833BCDRTGT	\$1,147
	24 ¼	15	32 ½	65	9	40C241533BCDRTGT	\$1,132
	24 ¼	12	32 ½	58	8	40C241233BCDRTGT	\$1,117

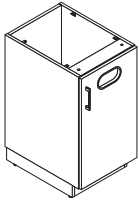

• waste grommet size 7 ½" x 4" x 1 ¼" - zinc oval grommet

Specify: Model | Chassis Laminate | Door Laminate | Pull | Lock | Waste Grommet Color

One Door Base - Left Hinged Cabinet, Waste Grommet	24 ¼	24	35	91	15	40C242435BCDLTGT	\$1,255
	24 ¼	21	35	84	13	40C242135BCDLTGT	\$1,242
	24 ¼	18	35	76	12	40C241835BCDLTGT	\$1,227
	24 ¼	15	35	69	10	40C241535BCDLTGT	\$1,217
	24 ¼	12	35	62	8	40C241235BCDLTGT	\$1,192
	24 ¼	24	32 ½	86	14	40C242433BCDLTGT	\$1,177
	24 ¼	21	32 ½	79	13	40C242133BCDLTGT	\$1,162
	24 ¼	18	32 ½	72	11	40C241833BCDLTGT	\$1,147
	24 ¼	15	32 ½	65	9	40C241533BCDLTGT	\$1,132
	24 ¼	12	32 ½	58	8	40C241233BCDLTGT	\$1,117

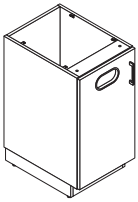

• waste grommet size 7 ½" x 4" x 1 ¼" - zinc oval grommet

Specify: Model | Chassis Laminate | Door Laminate | Pull | Lock | Waste Grommet Color

Model	Chassis Laminate	Door Laminate	Pull	Lock	Waste Grommet Color
	see Forge Laminate Finishes	see Forge Laminate Finishes	P001 Bar see Bar Pull Color P005 Delve see Delve Pull Color P011 Prospect see Prospect Pull Color P003 Sweep see Sweep Pull Color	NLK No Lock KLK Standard - add \$85 ASL Arctic Silver MBK Matte Black	MBK Matte Black SNK Soft Nickel

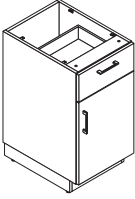
Description	D	W	H	CTN WT	CU FT	Model	List
 <p>One Door - Right Hinged, One Drawer Base Cabinet</p>	24 ¼	24	35	97	15	40C242435BCDDRT	\$1,731
	24 ¼	21	35	90	13	40C242135BCDDRT	\$1,705
	24 ¼	18	35	82	12	40C241835BCDDRT	\$1,593
	24 ¼	15	35	74	10	40C241535BCDDRT	\$1,576
	24 ¼	12	35	67	8	40C241235BCDDRT	\$1,560
	24 ¼	24	32 ½	92	14	40C242433BCDDRT	\$1,542
	24 ¼	21	32 ½	85	13	40C242133BCDDRT	\$1,525
	24 ¼	18	32 ½	77	11	40C241833BCDDRT	\$1,508
	24 ¼	15	32 ½	70	9	40C241533BCDDRT	\$1,491
	24 ¼	12	32 ½	63	8	40C241233BCDDRT	\$1,473

• plastic drawer liner available on top drawer for 18" and 24" wide cabinets, see page 106 for pricing
 - 18" 40CDBL184
 - 24" 40CDBL244
Note: when locking is specified, only top drawer locks

Specify: Model | Chassis Laminate | Door/Drawer Laminate | Pull | Lock

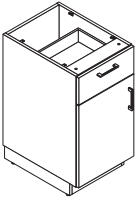
Description	D	W	H	CTN WT	CU FT	Model	List
 <p>One Door - Left Hinged, One Drawer Base Cabinet</p>	24 ¼	24	35	97	15	40C242435BCDDLTL	\$1,731
	24 ¼	21	35	90	13	40C242135BCDDLTL	\$1,705
	24 ¼	18	35	82	12	40C241835BCDDLTL	\$1,593
	24 ¼	15	35	74	10	40C241535BCDDLTL	\$1,576
	24 ¼	12	35	67	8	40C241235BCDDLTL	\$1,560
	24 ¼	24	32 ½	92	14	40C242433BCDDLTL	\$1,542
	24 ¼	21	32 ½	85	13	40C242133BCDDLTL	\$1,525
	24 ¼	18	32 ½	77	11	40C241833BCDDLTL	\$1,508
	24 ¼	15	32 ½	70	9	40C241533BCDDLTL	\$1,491
	24 ¼	12	32 ½	63	8	40C241233BCDDLTL	\$1,473

• plastic drawer liner available on top drawer for 18" and 24" wide cabinets, see page 106 for pricing
 - 18" 40CDBL184
 - 24" 40CDBL244
Note: when locking is specified, only top drawer locks

Specify: Model | Chassis Laminate | Door/Drawer Laminate | Pull | Lock

Model	Chassis Laminate	Door/Drawer Laminate	Pull	Lock
	see Forge Laminate Finishes	see Forge Laminate Finishes	P001 Bar see Bar Pull Color P005 Delve see Delve Pull Color P011 Prospect see Prospect Pull Color P003 Sweep see Sweep Pull Color	NLK No Lock KLK Standard - add \$85 ASL Arctic Silver MBK Matte Black DLK Keyless Lock - add \$250

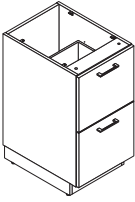
Description	D	W	H	CTN WT	CU FT	Model	List
 <p>Two Drawer Base Cabinet</p>	24 ¼	36	35	129	22	40C243635BC2T	\$1,902
	24 ¼	30	35	114	18	40C243035BC2T	\$1,886
	24 ¼	24	35	99	15	40C242435BC2T	\$1,870
	24 ¼	21	35	92	13	40C242135BC2T	\$1,854
	24 ¼	18	35	84	12	40C241835BC2T	\$1,838
	24 ¼	15	35	77	10	40C241535BC2T	\$1,822
	24 ¼	12	35	70	8	40C241235BC2T	\$1,806
	24 ¼	36	32 ½	122	20	40C243633BC2T	\$1,790
	24 ¼	30	32 ½	108	17	40C243033BC2T	\$1,774
	24 ¼	24	32 ½	94	14	40C242433BC2T	\$1,758
	24 ¼	21	32 ½	87	13	40C242133BC2T	\$1,706
	24 ¼	18	32 ½	80	11	40C241833BC2T	\$1,656
	24 ¼	15	32 ½	73	9	40C241533BC2T	\$1,604
	24 ¼	12	32 ½	66	8	40C241233BC2T	\$1,554

Note: when locking is specified, only top drawer locks

Specify: Model | Chassis Laminate | Drawer Laminate | Pull | Lock

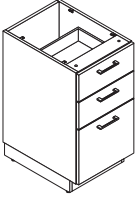
 <p>Three Drawer Base Cabinet</p>	24 ¼	36	35	127	22	40C243635BC3T	\$2,004
	24 ¼	30	35	113	18	40C243035BC3T	\$1,988
	24 ¼	24	35	99	15	40C242435BC3T	\$1,972
	24 ¼	21	35	92	13	40C242135BC3T	\$1,955
	24 ¼	18	35	85	12	40C241835BC3T	\$1,940
	24 ¼	15	35	78	10	40C241535BC3T	\$1,924
	24 ¼	12	35	71	8	40C241235BC3T	\$1,908
	24 ¼	36	32 ½	121	20	40C243633BC3T	\$1,892
	24 ¼	30	32 ½	108	17	40C243033BC3T	\$1,875
	24 ¼	24	32 ½	94	14	40C242433BC3T	\$1,860
	24 ¼	21	32 ½	87	13	40C242133BC3T	\$1,843
	24 ¼	18	32 ½	80	11	40C241833BC3T	\$1,828
	24 ¼	15	32 ½	73	9	40C241533BC3T	\$1,811
	24 ¼	12	32 ½	67	8	40C241233BC3T	\$1,795

• plastic drawer liner available on top two drawers for 18" and 24" wide cabinets, see page 106 for pricing
 - 18" 40CDBL184
 - 24" 40CDBL244

Note: when locking is specified, only top drawer locks

Model	Chassis Laminate	Drawer Laminate	Pull	Lock
	see Forge Laminate Finishes	see Forge Laminate Finishes	P001 Bar see Bar Pull Color P005 Delve see Delve Pull Color P011 Prospect see Prospect Pull Color P003 Sweep see Sweep Pull Color	NLK No Lock KLK Standard - add \$85 ASL Arctic Silver MBK Matte Black DLK Keyless Lock - add \$250

Description	D	W	H	CTN WT	CU FT	① Model	List
 <p>Four Drawer Base Cabinet</p>	24 ¼	36	35	134	22	40C243635BC4T	\$2,551
	24 ¼	30	35	120	18	40C243035BC4T	\$2,452
	24 ¼	24	35	105	15	40C242435BC4T	\$2,353
	24 ¼	21	35	98	13	40C242135BC4T	\$2,255
	24 ¼	18	35	90	12	40C241835BC4T	\$2,156
	24 ¼	15	35	83	10	40C241535BC4T	\$2,057
	24 ¼	12	35	76	8	40C241235BC4T	\$1,960
	24 ¼	36	32 ½	128	20	40C243633BC4T	\$2,366
	24 ¼	30	32 ½	114	17	40C243033BC4T	\$2,276
	24 ¼	24	32 ½	100	14	40C242433BC4T	\$2,186
	24 ¼	21	32 ½	93	13	40C242133BC4T	\$2,099
	24 ¼	18	32 ½	86	11	40C241833BC4T	\$2,008
	24 ¼	15	32 ½	78	9	40C241533BC4T	\$1,918
	24 ¼	12	32 ½	72	8	40C241233BC4T	\$1,829

- plastic drawer liner available on 18" and 24" wide cabinets, see page 106 for pricing
 - 18" 40CDBL184
 - 24" 40CDBL244

Note: when locking is specified, only top drawer locks

Specify: Model | Chassis Laminate | Drawer Laminate | Pull | Lock

Model	Chassis Laminate	Drawer Laminate	Pull	Lock
	see Forge Laminate Finishes	see Forge Laminate Finishes	P001 Bar see Bar Pull Color P005 Delve see Delve Pull Color P011 Prospect see Prospect Pull Color P003 Sweep see Sweep Pull Color	NLK No Lock KLK Standard - add \$85 ASL Arctic Silver MBK Matte Black DLK Keyless Lock - add \$250

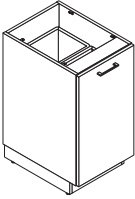
Description	D	W	H	CTN WT	CU FT	Model	List
 <p>Waste Pullout Drawer Base Cabinet</p>	24 ¼	24	35	93	15	40C242435BCWPT	\$1,918
	24 ¼	21	35	85	13	40C242135BCWPT	\$1,868
	24 ¼	18	35	77	12	40C241835BCWPT	\$1,816
	24 ¼	15	35	72	10	40C241535BCWPT	\$1,797
	24 ¼	24	32 ½	88	14	40C242433BCWPT	\$1,776
	24 ¼	21	32 ½	81	13	40C242133BCWPT	\$1,741
	24 ¼	18	32 ½	73	11	40C241833BCWPT	\$1,708
	24 ¼	15	32 ½	68	9	40C241533BCWPT	\$1,675

- one trash can included in 15" w models
- two trash cans included in 18"-24" w models

Specify: Model | Chassis Laminate | Drawer Laminate | Pull

Model	Chassis Laminate	Drawer Laminate	Pull
	see Forge Laminate Finishes	see Forge Laminate Finishes	P001 Bar see Bar Pull Color P005 Delve see Delve Pull Color P011 Prospect see Prospect Pull Color P003 Sweep see Sweep Pull Color

Description	D	W	H	CTN WT	CU FT	Model	List
Two Door Base Cabinet	24 ¼	36	35	121	22	40C243635BCDT	\$1,613
	24 ¼	30	35	106	18	40C243035BCDT	\$1,554
	24 ¼	36	32 ½	115	20	40C243633BCDT	\$1,527
	24 ¼	30	32 ½	100	17	40C243033BCDT	\$1,468

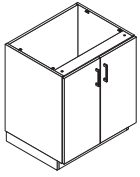

- one adjustable shelf

Specify: Model | Chassis Laminate | Door Laminate | Pull | Lock

Model	Chassis Laminate	Door Laminate	Pull	Lock
	see Forge Laminate Finishes	see Forge Laminate Finishes	P001 Bar see Bar Pull Color P005 Delve see Delve Pull Color P011 Prospect see Prospect Pull Color P003 Sweep see Sweep Pull Color	NLK No Lock KLK Standard - add \$85 ASL Arctic Silver MBK Matte Black DLK Keyless Lock - add \$276

Description	D	W	H	CTN WT	CU FT	Model	List
Two Door, One Drawer Base Cabinet	24 ¼	36	35	129	22	40C243635BCDD1T	\$1,977
	24 ¼	30	35	113	18	40C243035BCDD1T	\$1,918
	24 ¼	36	32 ½	122	20	40C243633BCDD1T	\$1,892
	24 ¼	30	32 ½	107	17	40C243033BCDD1T	\$1,833

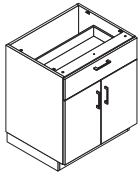

• one adjustable shelf
Note: when locking is specified, only top drawer locks

Specify: Model | Chassis Laminate | Drawer/Door Laminate | Pull | Lock

Model	Chassis Laminate	Door/Drawer Laminate	Pull	Lock
	see Forge Laminate Finishes	see Forge Laminate Finishes	P001 Bar see Bar Pull Color P005 Delve see Delve Pull Color P011 Prospect see Prospect Pull Color P003 Sweep see Sweep Pull Color	NLK No Lock KLK Standard - add \$85 ASL Arctic Silver MBK Matte Black DLK Keyless Lock - add \$250

Description	D	W	H	CTN WT	CU FT	Model	List
Two Door, Two Drawer Base Cabinet	24 ¼	36	35	132	22	40C243635BCDD2T	\$2,213
	24 ¼	30	35	116	18	40C243035BCDD2T	\$2,154
	24 ¼	36	32 ½	125	20	40C243633BCDD2T	\$2,127
	24 ¼	30	32 ½	110	17	40C243033BCDD2T	\$2,069

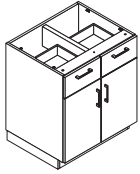

- one adjustable shelf
 - 18" plastic drawer liner available for model 40C243635BCDD2T and 40C243633BCDD2T, [see page 106](#)
- Note:** when locking is specified, only top drawer locks

Specify: Model | Chassis Laminate | Door/Drawer Laminate | Pull | Lock

Model	Chassis Laminate	Door/Drawer Laminate	Pull	Lock
	see Forge Laminate Finishes	see Forge Laminate Finishes	P001 Bar see Bar Pull Color P005 Delve see Delve Pull Color P011 Prospect see Prospect Pull Color P003 Sweep see Sweep Pull Color	NLK No Lock KLK Standard - add \$168 ASL Arctic Silver MBK Matte Black DLK Keyless Lock - add \$498

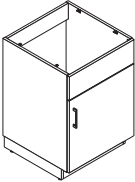
Description	D	W	H	CTN WT	CU FT	Model	List
 <p>One Door, False Front Sink Base Cabinet</p> <p>right shown</p>	Hinged Right						
	24 ¼	24	35	79	15	40C242435BSCDRFT	\$1,431
	24 ¼	24	32 ½	75	14	40C242433BSCDRFT	\$1,356
	Hinged Left						
	24 ¼	24	35	79	15	40C242435BSCDLFT	\$1,431
	24 ¼	24	32 ½	75	14	40C242433BSCDLFT	\$1,356

Specify: Model | Chassis Laminate | Door Laminate | Pull | Lock

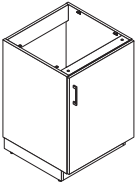
 <p>One Door Sink Base Cabinet</p> <p>right shown</p>	Hinged Right						
	24 ¼	24	35	79	15	40C242435BSCDRT	\$1,415
	24 ¼	24	32 ½	75	14	40C242433BSCDRT	\$1,339
	Hinged Left						
	24 ¼	24	35	79	15	40C242435BSCDLT	\$1,415
	24 ¼	24	32 ½	75	14	40C242433BSCDLT	\$1,339

Specify: Model | Chassis Laminate | Door Laminate | Pull | Lock

Model	Chassis Laminate	Door Laminate	Pull	Lock
	see Forge Laminate Finishes	see Forge Laminate Finishes	P001 Bar see Bar Pull Color P005 Delve see Delve Pull Color P011 Prospect see Prospect Pull Color P003 Sweep see Sweep Pull Color	NLK No Lock KLK Standard - add \$85 ASL Arctic Silver MBK Matte Black DLK Keyless Lock - add \$250

Description	D	W	H	CTN WT	CU FT	Model	List
Two Door, False Front Sink Base Cabinet	24 ¼	36	35	105	22	40C243635BSCDFT	\$1,587
	24 ¼	30	35	93	18	40C243035BSCDFT	\$1,527
	24 ¼	36	32 ½	98	20	40C243633BSCDFT	\$1,500
	24 ¼	30	32 ½	87	17	40C243033BSCDFT	\$1,441

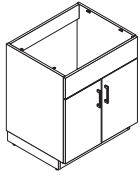

Specify: Model | Chassis Laminate | Door Laminate | Pull | Lock

Two Door Sink Base Cabinet	24 ¼	36	35	105	22	40C243635BSCDT	\$1,575
	24 ¼	30	35	93	18	40C243035BSCDT	\$1,517
	24 ¼	36	32 ½	98	20	40C243633BSCDT	\$1,490
	24 ¼	30	32 ½	87	17	40C243033BSCDT	\$1,431

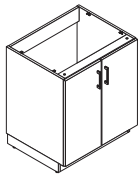

Specify: Model | Chassis Laminate | Door Laminate | Pull | Lock

Model	Chassis Laminate	Door Laminate	Pull	Lock
	see Forge Laminate Finishes	see Forge Laminate Finishes	P001 Bar see Bar Pull Color P005 Delve see Delve Pull Color P011 Prospect see Prospect Pull Color P003 Sweep see Sweep Pull Color	NLK No Lock KLK Standard - add \$85 ASL Arctic Silver MBK Matte Black DLK Keyless Lock - add \$276

Description	D	W	H	CTN WT	CU FT	① Model	List
Base Filler 	2	6	35	4	1	40C6235BFT	\$161
	2	6	32½	3	1	40C6233BFT	\$156
<ul style="list-style-type: none"> • includes brackets to attach to cabinet • may be field scribed as needed <p>Specify: Model Chassis Laminate</p>							

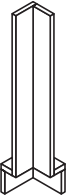
Base Corner Filler 	7	7	35	7	2	40C7735BFT	\$322
	7	7	33	6	2	40C7733BFT	\$312
<ul style="list-style-type: none"> • use with corner surfaces • includes brackets to attach to cabinets <p>Specify: Model Chassis Laminate</p>							

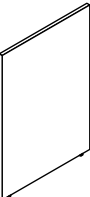
Base End Panel 	23 ½	¾	35	17	2	40C24135BET	\$242
	23 ½	¾	32 ½	16	2	40C24133BET	\$221
<ul style="list-style-type: none"> • can be used for support in place of a base cabinet • brackets must be specified separately, see page 69 <p>Specify: Model Chassis Laminate</p>							

Model	Chassis Laminate
	see Forge Laminate Finishes

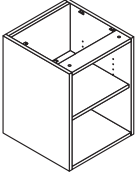
Description	D	W	H	CTN WT	CU FT	Model	List
Open Wall Hanging Base Cabinet 	18 1/2	36	23 1/2	65	12	40C193624WHBCT	\$1,056
	18 1/2	30	23 1/2	57	10	40C193024WHBCT	\$991
	18 1/2	24	23 1/2	49	8	40C192424WHBCT	\$933
	18 1/2	21	23 1/2	45	7	40C192124WHBCT	\$869
	18 1/2	18	23 1/2	41	7	40C191824WHBCT	\$804
	18 1/2	15	23 1/2	37	6	40C191524WHBCT	\$740
	18 1/2	12	23 1/2	33	5	40C191224WHBCT	\$740

- one adjustable shelf

Specify: Model | Chassis Laminate

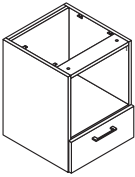
Description	D	W	H	CTN WT	CU FT	Model	List
Open Wall Hanging Base Cabinet with One Drawer 	19 1/4	36	23 1/2	74	12	40C193624WHBC1T	\$1,447
	19 1/4	30	23 1/2	65	10	40C193024WHBC1T	\$1,366
	19 1/4	24	23 1/2	51	9	40C192424WHBC1T	\$1,286
	19 1/4	21	23 1/2	47	8	40C192124WHBC1T	\$1,206
	19 1/4	18	23 1/2	43	7	40C191824WHBC1T	\$1,125
	19 1/4	15	23 1/2	40	6	40C191524WHBC1T	\$1,045
	19 1/4	12	23 1/2	36	5	40C191224WHBC1T	\$965

- one adjustable shelf
- plastic drawer liner available for 18" and 24" wide cabinets, [see page 106](#) for pricing
 18" 40CDBL184
 24" 40CDBL244

Specify: Model | Chassis Laminate | Drawer Laminate | Pull | Lock

Model	Chassis Laminate	Drawer Laminate	Pull	Lock
	see Forge Laminate Finishes	see Forge Laminate Finishes	P001 Bar see Bar Pull Color P005 Delve see Delve Pull Color P011 Prospect see Prospect Pull Color P003 Sweep see Sweep Pull Color	NLK No Lock KLK Standard - add \$85 ASL Arctic Silver MBK Matte Black DLK Keyless Lock - add \$250

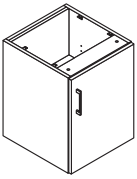
Description	D	W	H	CTN WT	CU FT	① Model	List
Door Wall Hanging Base Cabinet  right shown	Hinged Right						
	19 ¼	24	23 ½	61	9	40C192424WHBCDRT	\$981
	19 ¼	21	23 ½	55	8	40C192124WHBCDRT	\$954
	19 ¼	18	23 ½	50	7	40C191824WHBCDRT	\$906
	19 ¼	15	23 ½	44	6	40C191524WHBCDRT	\$891
	19 ¼	12	23 ½	39	5	40C191224WHBCDRT	\$877
	Hinged Left						
	19 ¼	24	23 ½	61	9	40C192424WHBCDLT	\$981
	19 ¼	21	23 ½	55	8	40C192124WHBCDLT	\$954
	19 ¼	18	23 ½	50	7	40C191824WHBCDLT	\$906
	19 ¼	15	23 ½	44	6	40C191524WHBCDLT	\$891
19 ¼	12	23 ½	39	5	40C191224WHBCDLT	\$877	

• one adjustable shelf

Specify: Model | Chassis Laminate | Door Laminate | Pull | Lock

Model	Chassis Laminate	Door Laminate	Pull	Lock
	see Forge Laminate Finishes	see Forge Laminate Finishes	P001 Bar see Bar Pull Color P005 Delve see Delve Pull Color P011 Prospect see Prospect Pull Color P003 Sweep see Sweep Pull Color	NLK No Lock KLK Standard - add \$85 ASL Arctic Silver MBK Matte Black DLK Keyless Lock - add \$250

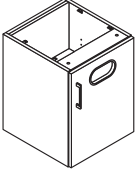
Description	D	W	H	CTN WT	CU FT	Model	List
 <p>right shown</p>	Hinged Right						
	19 ¼	24	23 ½	61	9	40C192424WHBCDRTGT	\$1,024
	19 ¼	21	23 ½	55	8	40C192124WHBCDRTGT	\$998
	19 ¼	18	23 ½	50	7	40C191824WHBCDRTGT	\$951
	19 ¼	15	23 ½	44	6	40C191524WHBCDRTGT	\$924
	19 ¼	12	23 ½	39	5	40C191224WHBCDRTGT	\$917
	Hinged Left						
	19 ¼	24	23 ½	61	9	40C192424WHBCDLTGT	\$1,024
	19 ¼	21	23 ½	55	8	40C192124WHBCDLTGT	\$998
	19 ¼	18	23 ½	50	7	40C191824WHBCDLTGT	\$951
19 ¼	15	23 ½	44	6	40C191524WHBCDLTGT	\$924	
19 ¼	12	23 ½	39	5	40C191224WHBCDLTGT	\$917	

• waste grommet size 7 ½" x 4" x 1 ¼" - zinc oval grommet

Specify: Model | Chassis Laminate | Door Laminate | Pull | Lock | Waste Grommet Color

Model	Chassis Laminate	Door Laminate	Pull	Lock	Waste Grommet Color
	see Forge Laminate Finishes	see Forge Laminate Finishes	P001 Bar see Bar Pull Color P005 Delve see Delve Pull Color P011 Prospect see Prospect Pull Color P003 Sweep see Sweep Pull Color	NLK No Lock KLK Standard - add \$85 ASL Arctic Silver MBK Matte Black	MBK Matte Black SNK Soft Nickel

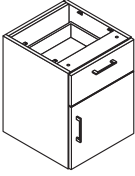
Description	D	W	H	CTN WT	CU FT	Model	List
 <p>One Door, One Drawer Wall Hanging Base Cabinet</p> <p>right shown</p>	Hinged Right						
	19 ¼	24	23 ½	67	9	40C192424WHBCDDRT	\$1,267
	19 ¼	21	23 ½	61	8	40C192124WHBCDDRT	\$1,231
	19 ¼	18	23 ½	55	7	40C191824WHBCDDRT	\$1,195
	19 ¼	15	23 ½	49	6	40C191524WHBCDDRT	\$1,159
	19 ¼	12	23 ½	44	5	40C191224WHBCDDRT	\$1,122
	Hinged Left						
	19 ¼	24	23 ½	67	9	40C192424WHBCDDL	\$1,267
	19 ¼	21	23 ½	61	8	40C192124WHBCDDL	\$1,231
	19 ¼	18	23 ½	55	7	40C191824WHBCDDL	\$1,195
19 ¼	15	23 ½	49	6	40C191524WHBCDDL	\$1,159	
19 ¼	12	23 ½	44	5	40C191224WHBCDDL	\$1,122	

• plastic drawer liner available on drawer for 18" and 24" wide cabinets, see page 106 for pricing
 18" 40CDBL184
 24" 40CDBL244

Note: when locking is specified, only drawer locks

Specify: Model | Chassis Laminate | Door/Drawer Laminate | Pull | Lock

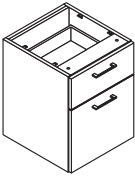
 <p>Two Drawer Wall Hanging Base Cabinet</p>	19 ¼	36	23 ½	98	12	40C193624WHBC2T	\$1,460
	19 ¼	30	23 ½	86	10	40C193024WHBC2T	\$1,428
	19 ¼	24	23 ½	68	9	40C192424WHBC2T	\$1,396
	19 ¼	21	23 ½	63	8	40C192124WHBC2T	\$1,363
	19 ¼	18	23 ½	57	7	40C191824WHBC2T	\$1,331
	19 ¼	15	23 ½	52	6	40C191524WHBC2T	\$1,299
	19 ¼	12	23 ½	46	5	40C191224WHBC2T	\$1,267

• plastic drawer liner available on top drawer for 18" and 24" wide cabinets, see page 106 for pricing
 18" 40CDBL184
 24" 40CDBL244

Note: when locking is specified, only top drawer locks

Specify: Model | Chassis Laminate | Drawer Laminate | Pull | Lock

Model	Chassis Laminate	Door/Drawer Laminate	Pull	Lock
	see Forge Laminate Finishes	see Forge Laminate Finishes	P001 Bar see Bar Pull Color P005 Delve see Delve Pull Color P011 Prospect see Prospect Pull Color P003 Sweep see Sweep Pull Color	NLK No Lock KLK Standard - add \$85 ASL Arctic Silver MBK Matte Black DLK Keyless Lock - add \$250

Description	D	W	H	CTN WT	CU FT	Model	List
 <p>Three Drawer Wall Hanging Base Cabinet</p>	19 ¼	36	23 ½	101	12	40C193624WHBC3T	\$1,607
	19 ¼	30	23 ½	89	10	40C193024WHBC3T	\$1,543
	19 ¼	24	23 ½	71	9	40C192424WHBC3T	\$1,480
	19 ¼	21	23 ½	66	8	40C192124WHBC3T	\$1,415
	19 ¼	18	23 ½	60	7	40C191824WHBC3T	\$1,351
	19 ¼	15	23 ½	54	6	40C191524WHBC3T	\$1,286
	19 ¼	12	23 ½	49	5	40C191224WHBC3T	\$1,222

- plastic drawer liner available for 18" and 24" wide cabinets, [see page 106](#) for pricing
 18" 40CDBL184
 24" 40CDBL244

Note: when locking is specified, only top drawer locks

Specify: Model | Chassis Laminate | Drawer Laminate | Pull | Lock

Model	Chassis Laminate	Drawer Laminate	Pull	Lock
	see Forge Laminate Finishes	see Forge Laminate Finishes	P001 Bar see Bar Pull Color P005 Delve see Delve Pull Color P011 Prospect see Prospect Pull Color P003 Sweep see Sweep Pull Color	NLK No Lock KLK Standard - add \$85 ASL Arctic Silver MBK Matte Black DLK Keyless Lock - add \$250

Description	D	W	H	CTN WT	CU FT	Model	List
Two Door Wall Hanging Base Cabinet	19 ¼	36	23 ½	93	12	40C193624WHBCDT	\$1,239
	19 ¼	30	23 ½	82	10	40C193024WHBCDT	\$1,179

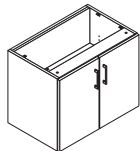

- one adjustable shelf

Specify: Model | Chassis Laminate | Door Laminate | Pull | Lock

Model	Chassis Laminate	Door Laminate	Pull	Lock
	see Forge Laminate Finishes	see Forge Laminate Finishes	P001 Bar see Bar Pull Color P005 Delve see Delve Pull Color P011 Prospect see Prospect Pull Color P003 Sweep see Sweep Pull Color	NLK No Lock KLK Standard - add \$85 ASL Arctic Silver MBK Matte Black DLK Keyless Lock - add \$276

Description	D	W	H	CTN WT	CU FT	Model	List
Two Door, One Drawer Wall Hanging Base Cabinet	19 ¼	36	23 ½	100	12	40C193624WHBCDDT	\$1,473
	19 ¼	30	23 ½	89	10	40C193024WHBCDDT	\$1,351

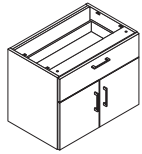

• one adjustable shelf

Note: when locking is specified, only drawer locks

Specify: Model | Chassis Laminate | Door/Drawer Laminate | Pull | Lock

Model	Chassis Laminate	Door/Drawer Laminate	Pull	Lock
	see Forge Laminate Finishes	see Forge Laminate Finishes	P001 Bar see Bar Pull Color P005 Delve see Delve Pull Color P011 Prospect see Prospect Pull Color P003 Sweep see Sweep Pull Color	NLK No Lock KLK Standard - add \$85 ASL Arctic Silver MBK Matte Black DLK Keyless Lock - add \$250

Description	D	W	H	CTN WT	CU FT	Model	List
Two Door, Two Drawer Wall Hanging Base Cabinet	19 ¼	36	23 ½	104	12	40C193624WHBCDD2T	\$1,554
	19 ¼	30	23 ½	92	10	40C193024WHBCDD2T	\$1,431

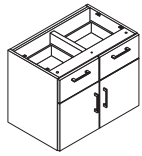

- one adjustable shelf
- 18" plastic drawer liner available for model 40C193624WHBCDD2T, see page 106 for pricing - 18" 40CDBL184

Note: when locking is specified, only drawer locks

Specify: Model | Chassis Laminate | Door/Drawer Laminate | Pull | Lock

Model	Chassis Laminate	Door/Drawer Laminate	Pull	Lock
	see Forge Laminate Finishes	see Forge Laminate Finishes	P001 Bar see Bar Pull Color P005 Delve see Delve Pull Color P011 Prospect see Prospect Pull Color P003 Sweep see Sweep Pull Color	NLK No Lock KLK Standard - add \$168 ASL Arctic Silver MBK Matte Black DLK Keyless Lock - add \$498

Description	D	W	H	CTN WT	CU FT	Model	List
One Door, False Drawer Front Wall Hanging Sink Cabinet	Hinged Right						
	19 ¼	24	23 ½	53	9	40C192424WHSCDRFT	\$959

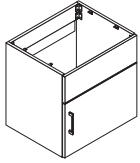

right shown

	Hinged Left						
	19 ¼	24	23 ½	53	9	40C192424WHSCDLFT	\$959

Specify: Model | Chassis Laminate | Door Laminate | Pull | Lock

One Door Wall Hanging Sink Cabinet	Hinged Right						
	19 ¼	24	23 ½	53	9	40C192424WHSCDRT	\$954

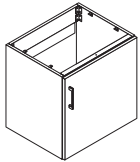

right shown

	Hinged Left						
	19 ¼	24	23 ½	53	9	40C192424WHSCDLT	\$954

Specify: Model | Chassis Laminate | Door Laminate | Pull | Lock

Model	Chassis Laminate	Door Laminate	Pull	Lock
	see Forge Laminate Finishes	see Forge Laminate Finishes	P001 Bar see Bar Pull Color P005 Delve see Delve Pull Color P011 Prospect see Prospect Pull Color P003 Sweep see Sweep Pull Color	NLK No Lock KLK Standard - add \$85 ASL Arctic Silver MBK Matte Black DLK Keyless Lock - add \$250

Description	D	W	H	CTN WT	CU FT	Model	List
Two Door False Front Wall Hanging Sink Cabinet	19 ¼	36	23 ½	70	12	40C193624WHSCDFT	\$1,120
	19 ¼	30	23 ½	62	10	40C193024WHSCDFT	\$1,061

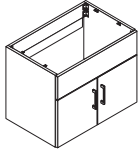

Specify: Model | Chassis Laminate | Door Laminate | Pull | Lock

Two Door Wall Hanging Sink Cabinet	19 ¼	36	23 ½	70	12	40C193624WHSCDT	\$1,120
	19 ¼	30	23 ½	62	10	40C193024WHSCDT	\$1,061

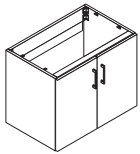

Specify: Model | Chassis Laminate | Door Laminate | Pull | Lock

Model	Chassis Laminate	Door Laminate	Pull	Lock
	see Forge Laminate Finishes	see Forge Laminate Finishes	P001 Bar see Bar Pull Color P005 Delve see Delve Pull Color P011 Prospect see Prospect Pull Color P003 Sweep see Sweep Pull Color	NLK No Lock KLK Standard - add \$85 ASL Arctic Silver MBK Matte Black DLK Keyless Lock - add \$276

Description	D	W	H	CTN WT	CU FT	Model	List
ADA Wall Hanging Sink Cabinet 	24 ¼	36	23 ½	47	15	40C243624ADAT	\$1,339
	24 ¼	30	23 ½	47	15	40C243024ADAT	\$1,281
	19 ¼	36	23 ½	39	12	40C193624ADAT	\$1,217
	19 ¼	30	23 ½	34	10	40C193024ADAT	\$1,158

- removable front panel

Specify: Model | Chassis Laminate | False Front Laminate

Model	Chassis Laminate	False Front Laminate
	see Forge Laminate Finishes	see Forge Laminate Finishes

Description	D	W	H	CTN WT	CU FT	① Model	List
Wall Hanging Filler	6	¾	23 ½	3	1	40C6124WHFT	\$147

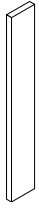

- includes brackets to attach to cabinet
- may be field scribed as needed

Specify: Model | Chassis Laminate

Wall Hanging Corner Filler	4 ¼	4 ¼	23 ½	5	1	40C4424WHFT	\$292
----------------------------	-----	-----	------	---	---	-------------	-------



- includes brackets to attach to cabinet

Specify: Model | Chassis Laminate

Model	Chassis Laminate
	see Forge Laminate Finishes

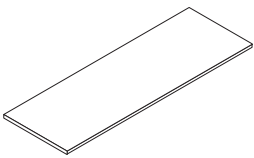
Description	D	W	H	CTN WT	CU FT	① Model	Tier 1	Tier 2
24½" d HPL Worksurfaces 	24½	120	1⅜	104	7	40C25120TH	\$1,055	\$1,109
	24½	119	1⅜	103	7	40C25119TH	\$1,050	\$1,103
	24½	118	1⅜	102	7	40C25118TH	\$1,044	\$1,096
	24½	117	1⅜	101	7	40C25117TH	\$1,038	\$1,090
	24½	116	1⅜	101	6	40C25116TH	\$1,032	\$1,084
	24½	115	1⅜	100	6	40C25115TH	\$1,025	\$1,077
	24½	114	1⅜	99	6	40C25114TH	\$1,018	\$1,070
	24½	113	1⅜	98	6	40C25113TH	\$1,012	\$1,063
	24½	112	1⅜	97	6	40C25112TH	\$1,006	\$1,056
	24½	111	1⅜	96	6	40C25111TH	\$1,000	\$1,050
	24½	110	1⅜	95	6	40C25110TH	\$993	\$1,043
	24½	109	1⅜	95	6	40C25109TH	\$986	\$1,036
	24½	108	1⅜	94	6	40C25108TH	\$980	\$1,029
	24½	107	1⅜	93	6	40C25107TH	\$972	\$1,021
	24½	106	1⅜	92	6	40C25106TH	\$963	\$1,011
	24½	105	1⅜	91	6	40C25105TH	\$954	\$1,003
	24½	104	1⅜	90	6	40C25104TH	\$946	\$994
	24½	103	1⅜	89	6	40C25103TH	\$938	\$985
	24½	102	1⅜	88	6	40C25102TH	\$929	\$976
	24½	101	1⅜	88	6	40C25101TH	\$919	\$965
	24½	100	1⅜	87	6	40C25100TH	\$909	\$955
	24½	99	1⅜	86	6	40C2599TH	\$900	\$945
	24½	98	1⅜	85	6	40C2598TH	\$890	\$935
	24½	97	1⅜	84	6	40C2597TH	\$880	\$925
	24½	96	1⅜	83	5	40C2596TH	\$871	\$915
	24½	95	1⅜	82	5	40C2595TH	\$860	\$903
	24½	94	1⅜	82	5	40C2594TH	\$847	\$890
	24½	93	1⅜	81	5	40C2593TH	\$836	\$877
	24½	92	1⅜	80	5	40C2592TH	\$823	\$866
	24½	91	1⅜	79	5	40C2591TH	\$812	\$852
	24½	90	1⅜	78	5	40C2590TH	\$800	\$841
	24½	89	1⅜	77	5	40C2589TH	\$788	\$828
24½	88	1⅜	76	5	40C2588TH	\$776	\$816	
24½	87	1⅜	75	5	40C2587TH	\$765	\$803	
24½	86	1⅜	75	5	40C2586TH	\$753	\$792	
24½	85	1⅜	74	5	40C2585TH	\$741	\$779	

• 3mm front edge, 1mm side and back edges

Specify: Model | Worksurface Laminate | Edge Finish

Model	Worksurface Laminate	Edge Finish
	see Forge Laminate Finishes	see Forge Edge Finishes (when applicable)

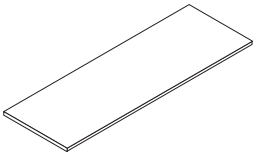
Description	D	W	H	CTN WT	CU FT	① Model	Tier 1	Tier 2
24½" d HPL Worksurfaces (continued) 	24½	84	1¾	73	5	40C2584TH	\$730	\$766
	24½	83	1¾	72	5	40C2583TH	\$720	\$758
	24½	82	1¾	71	5	40C2582TH	\$712	\$748
	24½	81	1¾	70	5	40C2581TH	\$704	\$739
	24½	80	1¾	69	5	40C2580TH	\$695	\$731
	24½	79	1¾	69	5	40C2579TH	\$686	\$720
	24½	78	1¾	68	5	40C2578TH	\$678	\$712
	24½	77	1¾	67	5	40C2577TH	\$669	\$704
	24½	76	1¾	66	4	40C2576TH	\$661	\$694
	24½	75	1¾	65	4	40C2575TH	\$652	\$685
	24½	74	1¾	64	4	40C2574TH	\$643	\$676
	24½	73	1¾	63	4	40C2573TH	\$635	\$667
	24½	72	1¾	62	4	40C2572TH	\$627	\$659
	24½	71	1¾	62	4	40C2571TH	\$616	\$648
	24½	70	1¾	61	4	40C2570TH	\$608	\$639
	24½	69	1¾	60	4	40C2569TH	\$600	\$630
	24½	68	1¾	59	4	40C2568TH	\$592	\$622
	24½	67	1¾	58	4	40C2567TH	\$582	\$612
	24½	66	1¾	57	4	40C2566TH	\$574	\$603
	24½	65	1¾	56	4	40C2565TH	\$566	\$595
	24½	64	1¾	56	4	40C2564TH	\$557	\$585
	24½	63	1¾	55	4	40C2563TH	\$548	\$576
	24½	62	1¾	54	4	40C2562TH	\$540	\$568
	24½	61	1¾	53	4	40C2561TH	\$531	\$558
	24½	60	1¾	52	4	40C2560TH	\$523	\$549
	24½	59	1¾	51	4	40C2559TH	\$515	\$541
	24½	58	1¾	50	4	40C2558TH	\$507	\$533
	24½	57	1¾	49	3	40C2557TH	\$499	\$525
	24½	56	1¾	49	3	40C2556TH	\$491	\$515
	24½	55	1¾	48	3	40C2555TH	\$482	\$506
	24½	54	1¾	47	3	40C2554TH	\$472	\$496
	24½	53	1¾	46	3	40C2553TH	\$465	\$489
24½	52	1¾	45	3	40C2552TH	\$459	\$482	
24½	51	1¾	44	3	40C2551TH	\$452	\$475	
24½	50	1¾	43	3	40C2550TH	\$445	\$468	
24½	49	1¾	43	3	40C2549TH	\$439	\$462	

• 3mm front edge, 1mm side and back edges

Specify: Model | Worksurface Laminate | Edge Finish

Model	Worksurface Laminate	Edge Finish
	see Forge Laminate Finishes	see Forge Edge Finishes (when applicable)

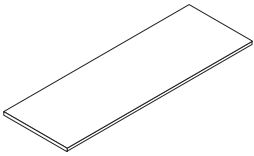
Description	D	W	H	CTN WT	CU FT	① Model	Tier 1	Tier 2
24½" d HPL Worksurfaces (continued) 	24½	48	1¾	42	3	40C2548TH	\$433	\$455
	24½	47	1¾	41	3	40C2547TH	\$431	\$453
	24½	46	1¾	40	3	40C2546TH	\$429	\$451
	24½	45	1¾	39	3	40C2545TH	\$427	\$449
	24½	44	1¾	38	3	40C2544TH	\$425	\$446
	24½	43	1¾	37	3	40C2543TH	\$423	\$444
	24½	42	1¾	36	3	40C2542TH	\$422	\$443
	24½	41	1¾	36	3	40C2541TH	\$420	\$441
	24½	40	1¾	35	3	40C2540TH	\$419	\$440
	24½	39	1¾	34	3	40C2539TH	\$417	\$438
	24½	38	1¾	33	3	40C2538TH	\$415	\$436
	24½	37	1¾	32	2	40C2537TH	\$414	\$435
	24½	36	1¾	31	2	40C2536TH	\$411	\$433
	24½	35	1¾	30	2	40C2535TH	\$407	\$427
	24½	34	1¾	30	2	40C2534TH	\$404	\$424
	24½	33	1¾	29	2	40C2533TH	\$400	\$421
	24½	32	1¾	28	2	40C2532TH	\$397	\$418
	24½	31	1¾	27	2	40C2531TH	\$394	\$415
	24½	30	1¾	26	2	40C2530TH	\$391	\$411
	24½	29	1¾	25	2	40C2529TH	\$388	\$408
	24½	28	1¾	24	2	40C2528TH	\$385	\$404
	24½	27	1¾	23	2	40C2527TH	\$383	\$401
	24½	26	1¾	23	2	40C2526TH	\$380	\$398
	24½	25	1¾	22	2	40C2525TH	\$377	\$396
	24½	24	1¾	21	2	40C2524TH	\$374	\$394
	24½	23	1¾	20	2	40C2523TH	\$371	\$391
	24½	22	1¾	19	2	40C2522TH	\$368	\$388
	24½	21	1¾	18	2	40C2521TH	\$365	\$384
	24½	20	1¾	17	2	40C2520TH	\$362	\$381
	24½	19	1¾	17	2	40C2519TH	\$360	\$379
	24½	18	1¾	16	2	40C2518TH	\$358	\$375
	24½	17	1¾	15	1	40C2517TH	\$355	\$372
	24½	16	1¾	14	1	40C2516TH	\$353	\$370
24½	15	1¾	13	1	40C2515TH	\$349	\$367	
24½	14	1¾	12	1	40C2514TH	\$347	\$365	
24½	13	1¾	11	1	40C2513TH	\$343	\$361	
24½	12	1¾	10	1	40C2512TH	\$341	\$359	

• 3mm front edge, 1mm side and back edges

Specify: Model | Worksurface Laminate | Edge Finish

Model	Worksurface Laminate	Edge Finish
	see Forge Laminate Finishes	see Forge Edge Finishes (when applicable)

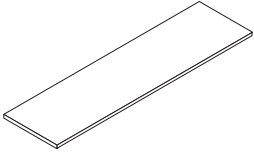
Description	D	W	H	CTN WT	CU FT	① Model	Tier 1	Tier 2
19½" d HPL Worksurfaces 	19½	120	1⅜	84	5	40C20120TH	\$879	\$923
	19½	119	1⅜	83	5	40C20119TH	\$874	\$918
	19½	118	1⅜	83	5	40C20118TH	\$869	\$913
	19½	117	1⅜	82	5	40C20117TH	\$864	\$907
	19½	116	1⅜	81	5	40C20116TH	\$857	\$901
	19½	115	1⅜	81	5	40C20115TH	\$853	\$897
	19½	114	1⅜	80	5	40C20114TH	\$849	\$892
	19½	113	1⅜	79	5	40C20113TH	\$845	\$888
	19½	112	1⅜	78	5	40C20112TH	\$841	\$883
	19½	111	1⅜	78	5	40C20111TH	\$837	\$878
	19½	110	1⅜	77	5	40C20110TH	\$833	\$874
	19½	109	1⅜	76	5	40C20109TH	\$828	\$870
	19½	108	1⅜	76	5	40C20108TH	\$823	\$866
	19½	107	1⅜	75	5	40C20107TH	\$818	\$861
	19½	106	1⅜	74	5	40C20106TH	\$813	\$853
	19½	105	1⅜	74	5	40C20105TH	\$808	\$848
	19½	104	1⅜	73	5	40C20104TH	\$801	\$842
	19½	103	1⅜	72	5	40C20103TH	\$795	\$836
	19½	102	1⅜	71	5	40C20102TH	\$788	\$828
	19½	101	1⅜	71	5	40C20101TH	\$780	\$819
	19½	100	1⅜	70	5	40C20100TH	\$773	\$813
	19½	99	1⅜	69	5	40C2099TH	\$767	\$806
	19½	98	1⅜	69	4	40C2098TH	\$761	\$799
	19½	97	1⅜	68	4	40C2097TH	\$754	\$793
	19½	96	1⅜	67	4	40C2096TH	\$747	\$785
	19½	95	1⅜	67	4	40C2095TH	\$737	\$774
	19½	94	1⅜	66	4	40C2094TH	\$727	\$763
	19½	93	1⅜	65	4	40C2093TH	\$715	\$752
	19½	92	1⅜	64	4	40C2092TH	\$706	\$741
	19½	91	1⅜	64	4	40C2091TH	\$696	\$732
	19½	90	1⅜	63	4	40C2090TH	\$689	\$724
	19½	89	1⅜	62	4	40C2089TH	\$679	\$713
19½	88	1⅜	62	4	40C2088TH	\$669	\$704	
19½	87	1⅜	61	4	40C2087TH	\$660	\$693	
19½	86	1⅜	60	4	40C2086TH	\$650	\$683	
19½	85	1⅜	60	4	40C2085TH	\$640	\$673	

• 3mm front edge, 1mm side and back edges

Specify: Model | Worksurface Laminate | Edge Finish

Model	Worksurface Laminate	Edge Finish
	see Forge Laminate Finishes	see Forge Edge Finishes (when applicable)

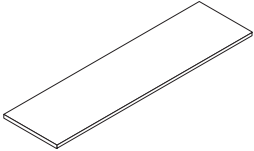
Description	D	W	H	CTN WT	CU FT	① Model	Tier 1	Tier 2
19½" d HPL Worksurfaces (continued) 	19½	84	1¾	59	4	40C2084TH	\$631	\$663
	19½	83	1¾	58	4	40C2083TH	\$625	\$657
	19½	82	1¾	57	4	40C2082TH	\$618	\$649
	19½	81	1¾	57	4	40C2081TH	\$612	\$643
	19½	80	1¾	56	4	40C2080TH	\$607	\$638
	19½	79	1¾	55	4	40C2079TH	\$602	\$633
	19½	78	1¾	55	4	40C2078TH	\$597	\$627
	19½	77	1¾	54	4	40C2077TH	\$592	\$622
	19½	76	1¾	53	4	40C2076TH	\$585	\$614
	19½	75	1¾	53	4	40C2075TH	\$578	\$607
	19½	74	1¾	52	4	40C2074TH	\$571	\$600
	19½	73	1¾	51	3	40C2073TH	\$562	\$592
	19½	72	1¾	50	3	40C2072TH	\$556	\$583
	19½	71	1¾	50	3	40C2071TH	\$551	\$578
	19½	70	1¾	49	3	40C2070TH	\$546	\$574
	19½	69	1¾	48	3	40C2069TH	\$541	\$569
	19½	68	1¾	48	3	40C2068TH	\$535	\$562
	19½	67	1¾	47	3	40C2067TH	\$529	\$556
	19½	66	1¾	46	3	40C2066TH	\$522	\$548
	19½	65	1¾	46	3	40C2065TH	\$515	\$541
	19½	64	1¾	45	3	40C2064TH	\$506	\$532
	19½	63	1¾	44	3	40C2063TH	\$500	\$526
	19½	62	1¾	43	3	40C2062TH	\$493	\$518
	19½	61	1¾	43	3	40C2061TH	\$486	\$509
	19½	60	1¾	42	3	40C2060TH	\$478	\$503
	19½	59	1¾	41	3	40C2059TH	\$471	\$495
	19½	58	1¾	41	3	40C2058TH	\$464	\$488
	19½	57	1¾	40	3	40C2057TH	\$456	\$479
	19½	56	1¾	39	3	40C2056TH	\$450	\$472
	19½	55	1¾	39	3	40C2055TH	\$442	\$465
	19½	54	1¾	38	3	40C2054TH	\$435	\$458
	19½	53	1¾	37	3	40C2053TH	\$432	\$454
	19½	52	1¾	36	3	40C2052TH	\$428	\$450
19½	51	1¾	36	3	40C2051TH	\$425	\$446	
19½	50	1¾	35	3	40C2050TH	\$422	\$443	
19½	49	1¾	34	3	40C2049TH	\$419	\$440	

• 3mm front edge, 1mm side and back edges

Specify: Model | Worksurface Laminate | Edge Finish

Model	Worksurface Laminate	Edge Finish
	see Forge Laminate Finishes	see Forge Edge Finishes (when applicable)

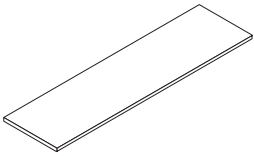
Description	D	W	H	CTN WT	CU FT	① Model	Tier 1	Tier 2
19½" d HPL Worksurfaces (continued) 	19½	48	1¾	34	2	40C2048TH	\$416	\$437
	19½	47	1¾	33	2	40C2047TH	\$412	\$434
	19½	46	1¾	32	2	40C2046TH	\$410	\$432
	19½	45	1¾	32	2	40C2045TH	\$407	\$427
	19½	44	1¾	31	2	40C2044TH	\$405	\$425
	19½	43	1¾	30	2	40C2043TH	\$402	\$423
	19½	42	1¾	29	2	40C2042TH	\$400	\$421
	19½	41	1¾	29	2	40C2041TH	\$396	\$417
	19½	40	1¾	28	2	40C2040TH	\$393	\$414
	19½	39	1¾	27	2	40C2039TH	\$389	\$409
	19½	38	1¾	27	2	40C2038TH	\$386	\$405
	19½	37	1¾	26	2	40C2037TH	\$383	\$401
	19½	36	1¾	25	2	40C2036TH	\$380	\$398
	19½	35	1¾	25	2	40C2035TH	\$375	\$395
	19½	34	1¾	24	2	40C2034TH	\$372	\$392
	19½	33	1¾	23	2	40C2033TH	\$369	\$389
	19½	32	1¾	22	2	40C2032TH	\$366	\$386
	19½	31	1¾	22	2	40C2031TH	\$363	\$382
	19½	30	1¾	21	2	40C2030TH	\$360	\$379
	19½	29	1¾	20	2	40C2029TH	\$357	\$374
	19½	28	1¾	20	2	40C2028TH	\$353	\$370
	19½	27	1¾	19	2	40C2027TH	\$348	\$366
	19½	26	1¾	18	2	40C2026TH	\$345	\$363
	19½	25	1¾	18	2	40C2025TH	\$341	\$359
	19½	24	1¾	17	2	40C2024TH	\$338	\$356
	19½	23	1¾	16	1	40C2023TH	\$335	\$353
	19½	22	1¾	15	1	40C2022TH	\$332	\$349
	19½	21	1¾	15	1	40C2021TH	\$330	\$347
	19½	20	1¾	14	1	40C2020TH	\$327	\$343
	19½	19	1¾	13	1	40C2019TH	\$325	\$341
	19½	18	1¾	13	1	40C2018TH	\$322	\$338
	19½	17	1¾	12	1	40C2017TH	\$319	\$335
	19½	16	1¾	11	1	40C2016TH	\$316	\$332
19½	15	1¾	11	1	40C2015TH	\$312	\$328	
19½	14	1¾	10	1	40C2014TH	\$308	\$325	
19½	13	1¾	9	1	40C2013TH	\$305	\$321	
19½	12	1¾	8	1	40C2012TH	\$301	\$316	

• 3mm front edge, 1mm side and back edges

Specify: Model | Worksurface Laminate | Edge Finish

Model	Worksurface Laminate	Edge Finish
	see Forge Laminate Finishes	see Forge Edge Finishes (when applicable)

Description	D	W	H	CTN WT	CU FT	① Model	Tier 1	Tier 2
HPL Corner Worksurfaces	24 1/2	29	1 3/16	35	2	40C2929CTWH	\$622	\$652
	24 1/2	24	1 3/16	24	2	40C2424CTWH	\$585	\$614

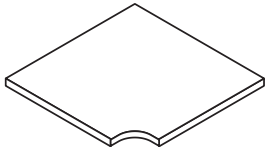

- 3mm front edge, 1mm side and back edges
- brackets must be specified separately, [see page 69](#)

Specify: Model | Worksurface Laminate | Edge Finish

Model	Worksurface Laminate	Edge Finish
	see Forge Laminate Finishes	see Forge Edge Finishes (when applicable)

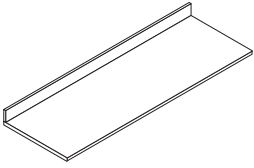
Description	D	W	H	CTN WT	CU FT	① Model	Tier 1	Tier 2
24½" d HPL Worksurfaces with Backsplash 	24½	120	5 ⅜	116	14	40C25120TWBH	\$1,212	\$1,273
	24½	119	5 ⅜	115	14	40C25119TWBH	\$1,200	\$1,261
	24½	118	5 ⅜	114	14	40C25118TWBH	\$1,190	\$1,250
	24½	117	5 ⅜	113	14	40C25117TWBH	\$1,179	\$1,239
	24½	116	5 ⅜	112	14	40C25116TWBH	\$1,175	\$1,234
	24½	115	5 ⅜	111	14	40C25115TWBH	\$1,171	\$1,229
	24½	114	5 ⅜	110	14	40C25114TWBH	\$1,166	\$1,225
	24½	113	5 ⅜	109	14	40C25113TWBH	\$1,163	\$1,222
	24½	112	5 ⅜	108	14	40C25112TWBH	\$1,160	\$1,219
	24½	111	5 ⅜	107	13	40C25111TWBH	\$1,154	\$1,212
	24½	110	5 ⅜	106	13	40C25110TWBH	\$1,147	\$1,205
	24½	109	5 ⅜	105	13	40C25109TWBH	\$1,141	\$1,198
	24½	108	5 ⅜	104	13	40C25108TWBH	\$1,135	\$1,191
	24½	107	5 ⅜	103	13	40C25107TWBH	\$1,120	\$1,177
	24½	106	5 ⅜	102	13	40C25106TWBH	\$1,113	\$1,169
	24½	105	5 ⅜	101	13	40C25105TWBH	\$1,106	\$1,161
	24½	104	5 ⅜	100	13	40C25104TWBH	\$1,097	\$1,154
	24½	103	5 ⅜	99	13	40C25103TWBH	\$1,090	\$1,145
	24½	102	5 ⅜	98	12	40C25102TWBH	\$1,083	\$1,138
	24½	101	5 ⅜	97	12	40C25101TWBH	\$1,078	\$1,132
	24½	100	5 ⅜	97	12	40C25100TWBH	\$1,071	\$1,124
	24½	99	5 ⅜	96	12	40C2599TWBH	\$1,064	\$1,118
	24½	98	5 ⅜	95	12	40C2598TWBH	\$1,058	\$1,112
	24½	97	5 ⅜	94	12	40C2597TWBH	\$1,052	\$1,106
	24½	96	5 ⅜	93	12	40C2596TWBH	\$1,045	\$1,097
	24½	95	5 ⅜	92	12	40C2595TWBH	\$1,035	\$1,087
	24½	94	5 ⅜	91	11	40C2594TWBH	\$1,033	\$1,085
	24½	93	5 ⅜	90	11	40C2593TWBH	\$1,017	\$1,069
	24½	92	5 ⅜	89	11	40C2592TWBH	\$1,003	\$1,053
	24½	91	5 ⅜	88	11	40C2591TWBH	\$987	\$1,038
	24½	90	5 ⅜	87	11	40C2590TWBH	\$973	\$1,022
	24½	89	5 ⅜	86	11	40C2589TWBH	\$993	\$1,043
24½	88	5 ⅜	85	11	40C2588TWBH	\$978	\$1,027	
24½	87	5 ⅜	84	11	40C2587TWBH	\$963	\$1,011	
24½	86	5 ⅜	83	11	40C2586TWBH	\$948	\$997	
24½	85	5 ⅜	82	10	40C2585TWBH	\$933	\$980	

- 3mm front edge, 1mm side and back edges
- requires backsplash seams to be sealed in the field

Specify: Model | Worksurface Laminate | Edge Finish

Model	Worksurface Laminate	Edge Finish
	see Forge Laminate Finishes	see Forge Edge Finishes (when applicable)

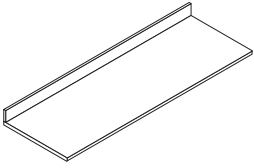
Description	D	W	H	CTN WT	CU FT	① Model	Tier 1	Tier 2
24½" d HPL Worksurfaces with Backsplash (continued) 	24½	84	5 ⅜	81	10	40C2584TWBH	\$918	\$964
	24½	83	5 ⅜	80	10	40C2583TWBH	\$982	\$1,032
	24½	82	5 ⅜	79	10	40C2582TWBH	\$968	\$1,016
	24½	81	5 ⅜	78	10	40C2581TWBH	\$952	\$1,001
	24½	80	5 ⅜	77	10	40C2580TWBH	\$938	\$985
	24½	79	5 ⅜	76	10	40C2579TWBH	\$923	\$971
	24½	78	5 ⅜	75	10	40C2578TWBH	\$909	\$955
	24½	77	5 ⅜	74	10	40C2577TWBH	\$895	\$940
	24½	76	5 ⅜	73	9	40C2576TWBH	\$879	\$923
	24½	75	5 ⅜	72	9	40C2575TWBH	\$846	\$889
	24½	74	5 ⅜	71	9	40C2574TWBH	\$843	\$886
	24½	73	5 ⅜	70	9	40C2573TWBH	\$840	\$882
	24½	72	5 ⅜	69	9	40C2572TWBH	\$837	\$878
	24½	71	5 ⅜	68	9	40C2571TWBH	\$868	\$911
	24½	70	5 ⅜	68	9	40C2570TWBH	\$856	\$900
	24½	69	5 ⅜	67	9	40C2569TWBH	\$846	\$889
	24½	68	5 ⅜	66	9	40C2568TWBH	\$836	\$877
	24½	67	5 ⅜	65	8	40C2567TWBH	\$824	\$867
	24½	66	5 ⅜	64	8	40C2566TWBH	\$814	\$854
	24½	65	5 ⅜	63	8	40C2565TWBH	\$802	\$843
	24½	64	5 ⅜	62	8	40C2564TWBH	\$792	\$831
	24½	63	5 ⅜	61	8	40C2563TWBH	\$781	\$820
	24½	62	5 ⅜	60	8	40C2562TWBH	\$769	\$808
	24½	61	5 ⅜	59	8	40C2561TWBH	\$759	\$797
	24½	60	5 ⅜	58	8	40C2560TWBH	\$747	\$785
	24½	59	5 ⅜	57	7	40C2559TWBH	\$770	\$809
	24½	58	5 ⅜	56	7	40C2558TWBH	\$761	\$799
	24½	57	5 ⅜	55	7	40C2557TWBH	\$750	\$788
	24½	56	5 ⅜	54	7	40C2556TWBH	\$740	\$777
	24½	55	5 ⅜	53	7	40C2555TWBH	\$731	\$768
	24½	54	5 ⅜	52	7	40C2554TWBH	\$720	\$758
	24½	53	5 ⅜	51	7	40C2553TWBH	\$713	\$749
24½	52	5 ⅜	50	7	40C2552TWBH	\$705	\$740	
24½	51	5 ⅜	49	7	40C2551TWBH	\$696	\$732	
24½	50	5 ⅜	48	6	40C2550TWBH	\$688	\$723	
24½	49	5 ⅜	47	6	40C2549TWBH	\$679	\$713	

- 3mm front edge, 1mm side and back edges
- requires backsplash seams to be sealed in the field

Specify: Model | Worksurface Laminate | Edge Finish

Model	Worksurface Laminate	Edge Finish
	see Forge Laminate Finishes	see Forge Edge Finishes (when applicable)

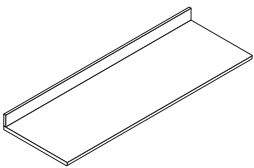
Description	D	W	H	CTN WT	CU FT	① Model	Tier 1	Tier 2
24½" d HPL Worksurfaces with Backsplash (continued) 	24½	48	5 ⅜	46	6	40C2548TWBH	\$670	\$705
	24½	47	5 ⅜	45	6	40C2547TWBH	\$631	\$663
	24½	46	5 ⅜	44	6	40C2546TWBH	\$629	\$661
	24½	45	5 ⅜	43	6	40C2545TWBH	\$628	\$660
	24½	44	5 ⅜	42	6	40C2544TWBH	\$627	\$659
	24½	43	5 ⅜	41	6	40C2543TWBH	\$625	\$657
	24½	42	5 ⅜	40	6	40C2542TWBH	\$623	\$654
	24½	41	5 ⅜	39	5	40C2541TWBH	\$569	\$598
	24½	40	5 ⅜	39	5	40C2540TWBH	\$566	\$595
	24½	39	5 ⅜	38	5	40C2539TWBH	\$562	\$592
	24½	38	5 ⅜	37	5	40C2538TWBH	\$559	\$588
	24½	37	5 ⅜	36	5	40C2537TWBH	\$556	\$583
	24½	36	5 ⅜	35	5	40C2536TWBH	\$553	\$580
	24½	35	5 ⅜	34	5	40C2535TWBH	\$549	\$577
	24½	34	5 ⅜	33	5	40C2534TWBH	\$546	\$574
	24½	33	5 ⅜	32	4	40C2533TWBH	\$543	\$571
	24½	32	5 ⅜	31	4	40C2532TWBH	\$517	\$543
	24½	31	5 ⅜	30	4	40C2531TWBH	\$513	\$539
	24½	30	5 ⅜	29	4	40C2530TWBH	\$509	\$535
	24½	29	5 ⅜	28	4	40C2529TWBH	\$506	\$532
	24½	28	5 ⅜	27	4	40C2528TWBH	\$503	\$529
	24½	27	5 ⅜	26	4	40C2527TWBH	\$500	\$526
	24½	26	5 ⅜	25	4	40C2526TWBH	\$497	\$523
	24½	25	5 ⅜	24	4	40C2525TWBH	\$494	\$519
	24½	24	5 ⅜	23	3	40C2524TWBH	\$491	\$515
	24½	23	5 ⅜	22	3	40C2523TWBH	\$453	\$476
	24½	22	5 ⅜	21	3	40C2522TWBH	\$450	\$472
	24½	21	5 ⅜	20	3	40C2521TWBH	\$446	\$469
	24½	20	5 ⅜	19	3	40C2520TWBH	\$443	\$466
	24½	19	5 ⅜	18	3	40C2519TWBH	\$440	\$463
	24½	18	5 ⅜	17	3	40C2518TWBH	\$437	\$460
	24½	17	5 ⅜	16	3	40C2517TWBH	\$420	\$441
24½	16	5 ⅜	15	3	40C2516TWBH	\$417	\$438	
24½	15	5 ⅜	14	2	40C2515TWBH	\$414	\$435	
24½	14	5 ⅜	13	2	40C2514TWBH	\$410	\$432	
24½	13	5 ⅜	12	2	40C2513TWBH	\$407	\$427	
24½	12	5 ⅜	11	2	40C2512TWBH	\$404	\$424	

- 3mm front edge, 1mm side and back edges
- requires backsplash seams to be sealed in the field

Specify: Model | Worksurface Laminate | Edge Finish

Model	Worksurface Laminate	Edge Finish
	see Forge Laminate Finishes	see Forge Edge Finishes (when applicable)

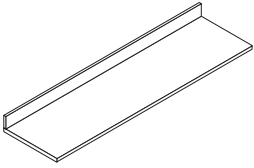
Description	D	W	H	CTN WT	CU FT	① Model	Tier 1	Tier 2
19½" d HPL Worksurfaces with Backsplash 	19½	120	5 ¾	96	11	40C20120TWBH	\$1,049	\$1,102
	19½	119	5 ¾	95	11	40C20119TWBH	\$1,012	\$1,063
	19½	118	5 ¾	94	11	40C20118TWBH	\$1,004	\$1,054
	19½	117	5 ¾	93	11	40C20117TWBH	\$995	\$1,045
	19½	116	5 ¾	93	11	40C20116TWBH	\$991	\$1,042
	19½	115	5 ¾	92	11	40C20115TWBH	\$988	\$1,039
	19½	114	5 ¾	91	11	40C20114TWBH	\$985	\$1,035
	19½	113	5 ¾	90	11	40C20113TWBH	\$982	\$1,032
	19½	112	5 ¾	89	11	40C20112TWBH	\$980	\$1,029
	19½	111	5 ¾	89	11	40C20111TWBH	\$978	\$1,027
	19½	110	5 ¾	88	11	40C20110TWBH	\$975	\$1,024
	19½	109	5 ¾	87	10	40C20109TWBH	\$973	\$1,022
	19½	108	5 ¾	86	10	40C20108TWBH	\$971	\$1,020
	19½	107	5 ¾	85	10	40C20107TWBH	\$973	\$1,022
	19½	106	5 ¾	85	10	40C20106TWBH	\$964	\$1,012
	19½	105	5 ¾	84	10	40C20105TWBH	\$954	\$1,003
	19½	104	5 ¾	83	10	40C20104TWBH	\$946	\$994
	19½	103	5 ¾	82	10	40C20103TWBH	\$936	\$983
	19½	102	5 ¾	81	10	40C20102TWBH	\$927	\$975
	19½	101	5 ¾	81	10	40C20101TWBH	\$915	\$960
	19½	100	5 ¾	80	10	40C20100TWBH	\$906	\$952
	19½	99	5 ¾	79	10	40C2099TWBH	\$907	\$953
	19½	98	5 ¾	78	9	40C2098TWBH	\$899	\$944
	19½	97	5 ¾	77	9	40C2097TWBH	\$890	\$935
	19½	96	5 ¾	77	9	40C2096TWBH	\$881	\$926
	19½	95	5 ¾	76	9	40C2095TWBH	\$883	\$929
	19½	94	5 ¾	75	9	40C2094TWBH	\$875	\$919
	19½	93	5 ¾	74	9	40C2093TWBH	\$867	\$910
	19½	92	5 ¾	73	9	40C2092TWBH	\$857	\$901
	19½	91	5 ¾	73	9	40C2091TWBH	\$849	\$892
	19½	90	5 ¾	72	9	40C2090TWBH	\$841	\$883
	19½	89	5 ¾	71	9	40C2089TWBH	\$834	\$875
	19½	88	5 ¾	70	9	40C2088TWBH	\$824	\$867
19½	87	5 ¾	69	8	40C2087TWBH	\$816	\$857	
19½	86	5 ¾	69	8	40C2086TWBH	\$809	\$849	
19½	85	5 ¾	68	8	40C2085TWBH	\$800	\$841	

- 3mm front edge, 1mm side and back edges
- requires backsplash seams to be sealed in the field

Specify: Model | Worksurface Laminate | Edge Finish

Model	Worksurface Laminate	Edge Finish
	see Forge Laminate Finishes	see Forge Edge Finishes (when applicable)

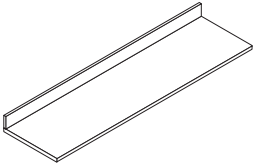
Description	D	W	H	CTN WT	CU FT	① Model	Tier 1	Tier 2
19½" d HPL Worksurfaces with Backsplash (continued) 	19½	84	5 ⅜	67	8	40C2084TWBH	\$792	\$831
	19½	83	5 ⅜	66	8	40C2083TWBH	\$786	\$826
	19½	82	5 ⅜	65	8	40C2082TWBH	\$780	\$819
	19½	81	5 ⅜	65	8	40C2081TWBH	\$773	\$813
	19½	80	5 ⅜	64	8	40C2080TWBH	\$767	\$806
	19½	79	5 ⅜	63	8	40C2079TWBH	\$761	\$799
	19½	78	5 ⅜	62	8	40C2078TWBH	\$754	\$793
	19½	77	5 ⅜	61	8	40C2077TWBH	\$750	\$788
	19½	76	5 ⅜	61	7	40C2076TWBH	\$741	\$779
	19½	75	5 ⅜	60	7	40C2075TWBH	\$732	\$769
	19½	74	5 ⅜	59	7	40C2074TWBH	\$721	\$759
	19½	73	5 ⅜	58	7	40C2073TWBH	\$712	\$748
	19½	72	5 ⅜	57	7	40C2072TWBH	\$703	\$738
	19½	71	5 ⅜	57	7	40C2071TWBH	\$732	\$769
	19½	70	5 ⅜	56	7	40C2070TWBH	\$720	\$758
	19½	69	5 ⅜	55	7	40C2069TWBH	\$710	\$746
	19½	68	5 ⅜	54	7	40C2068TWBH	\$700	\$735
	19½	67	5 ⅜	53	7	40C2067TWBH	\$689	\$724
	19½	66	5 ⅜	53	7	40C2066TWBH	\$678	\$712
	19½	65	5 ⅜	52	6	40C2065TWBH	\$667	\$702
	19½	64	5 ⅜	51	6	40C2064TWBH	\$657	\$690
	19½	63	5 ⅜	50	6	40C2063TWBH	\$646	\$679
	19½	62	5 ⅜	49	6	40C2062TWBH	\$635	\$667
	19½	61	5 ⅜	49	6	40C2061TWBH	\$629	\$661
	19½	60	5 ⅜	48	6	40C2060TWBH	\$624	\$656
	19½	59	5 ⅜	47	6	40C2059TWBH	\$618	\$649
	19½	58	5 ⅜	46	6	40C2058TWBH	\$611	\$642
	19½	57	5 ⅜	45	6	40C2057TWBH	\$606	\$637
	19½	56	5 ⅜	45	6	40C2056TWBH	\$601	\$631
	19½	55	5 ⅜	44	6	40C2055TWBH	\$593	\$623
	19½	54	5 ⅜	43	6	40C2054TWBH	\$585	\$614
	19½	53	5 ⅜	42	5	40C2053TWBH	\$579	\$608
19½	52	5 ⅜	41	5	40C2052TWBH	\$574	\$603	
19½	51	5 ⅜	41	5	40C2051TWBH	\$570	\$599	
19½	50	5 ⅜	40	5	40C2050TWBH	\$566	\$595	
19½	49	5 ⅜	39	5	40C2049TWBH	\$560	\$589	

- 3mm front edge, 1mm side and back edges
- requires backsplash seams to be sealed in the field

Specify: Model | Worksurface Laminate | Edge Finish

Model	Worksurface Laminate	Edge Finish
	see Forge Laminate Finishes	see Forge Edge Finishes (when applicable)

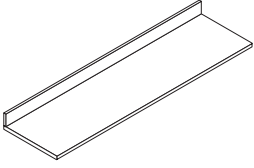
Description	D	W	H	CTN WT	CU FT	① Model	Tier 1	Tier 2
19½" d HPL Worksurfaces with Backsplash (continued) 	19½	48	5 ⅜	38	5	40C2048TWBH	\$555	\$582
	19½	47	5 ⅜	37	5	40C2047TWBH	\$553	\$580
	19½	46	5 ⅜	37	5	40C2046TWBH	\$549	\$577
	19½	45	5 ⅜	36	5	40C2045TWBH	\$546	\$574
	19½	44	5 ⅜	35	5	40C2044TWBH	\$544	\$572
	19½	43	5 ⅜	34	5	40C2043TWBH	\$541	\$569
	19½	42	5 ⅜	33	4	40C2042TWBH	\$538	\$566
	19½	41	5 ⅜	33	4	40C2041TWBH	\$532	\$559
	19½	40	5 ⅜	32	4	40C2040TWBH	\$528	\$555
	19½	39	5 ⅜	31	4	40C2039TWBH	\$524	\$551
	19½	38	5 ⅜	30	4	40C2038TWBH	\$520	\$546
	19½	37	5 ⅜	29	4	40C2037TWBH	\$515	\$541
	19½	36	5 ⅜	29	4	40C2036TWBH	\$511	\$536
	19½	35	5 ⅜	28	4	40C2035TWBH	\$505	\$531
	19½	34	5 ⅜	27	4	40C2034TWBH	\$501	\$527
	19½	33	5 ⅜	26	4	40C2033TWBH	\$497	\$523
	19½	32	5 ⅜	25	4	40C2032TWBH	\$493	\$518
	19½	31	5 ⅜	25	3	40C2031TWBH	\$489	\$513
	19½	30	5 ⅜	24	3	40C2030TWBH	\$485	\$508
	19½	29	5 ⅜	23	3	40C2029TWBH	\$477	\$502
	19½	28	5 ⅜	22	3	40C2028TWBH	\$472	\$496
	19½	27	5 ⅜	21	3	40C2027TWBH	\$467	\$491
	19½	26	5 ⅜	21	3	40C2026TWBH	\$462	\$486
	19½	25	5 ⅜	20	3	40C2025TWBH	\$456	\$479
	19½	24	5 ⅜	19	3	40C2024TWBH	\$451	\$473
	19½	23	5 ⅜	18	3	40C2023TWBH	\$442	\$465
	19½	22	5 ⅜	17	3	40C2022TWBH	\$434	\$456
	19½	21	5 ⅜	17	3	40C2021TWBH	\$425	\$446
	19½	20	5 ⅜	16	2	40C2020TWBH	\$417	\$438
	19½	19	5 ⅜	15	2	40C2019TWBH	\$408	\$428
19½	18	5 ⅜	14	2	40C2018TWBH	\$399	\$420	
19½	17	5 ⅜	13	2	40C2017TWBH	\$395	\$416	
19½	16	5 ⅜	13	2	40C2016TWBH	\$391	\$411	
19½	15	5 ⅜	12	2	40C2015TWBH	\$387	\$406	
19½	14	5 ⅜	11	2	40C2014TWBH	\$382	\$400	
19½	13	5 ⅜	10	2	40C2013TWBH	\$377	\$396	
19½	12	5 ⅜	9	2	40C2012TWBH	\$372	\$392	

- 3mm front edge, 1mm side and back edges
- requires backsplash seams to be sealed in the field

Specify: Model | Worksurface Laminate | Edge Finish

Model	Worksurface Laminate	Edge Finish
	see Forge Laminate Finishes	see Forge Edge Finishes (when applicable)

Description	D	W	H	CTN WT	CU FT	① Model	Tier 1	Tier 2
HPL Corner Worksurface with Backsplash	24 1/2	29	5 3/16	42	4	40C2929CTWHBS	\$740	\$777
	19 1/2	24	5 3/16	30	3	40C2424CTWHBS	\$697	\$733

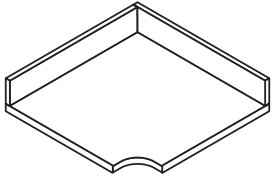

- requires backsplash seams to be sealed in the field
- brackets must be specified separately, [see page 69](#)

Specify: Model | Worksurface Laminate | Edge Finish

HPL Side Splash	3/4	23 3/8	4	2	1	40C123SSH	\$107	\$113
	3/4	18 3/8	4	2	1	40C118SSH	\$105	\$111

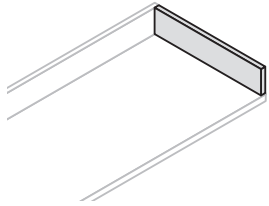

Specify: Model | Worksurface Laminate

HPL Side Splash Flush with Storage Cabinets	3/4	22 1/2	4	2	1	40C123SSFH	\$101	\$107
	3/4	17 1/2	4	2	1	40C118SSFH	\$99	\$105

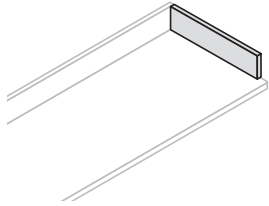

- aligns flush with storage cabinet chassis

Specify: Model | Worksurface Laminate

Model	Worksurface Laminate	Edge Finish
	see Forge Laminate Finishes	see Forge Edge Finishes (when applicable)

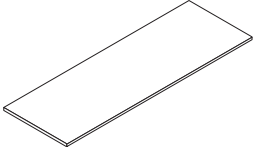
Description	D	W	H	CTN WT	CU FT	① Model	Tier 1	Tier 2	Tier 3	Tier 4
24½" d Solid Surface Worksurfaces 	24½	120	1	137	6	40C25120TS	\$4,287	\$4,759	\$5,574	\$6,859
	24½	119	1	136	6	40C25119TS	\$4,254	\$4,722	\$5,531	\$6,807
	24½	118	1	135	6	40C25118TS	\$4,223	\$4,687	\$5,489	\$6,756
	24½	117	1	134	6	40C25117TS	\$4,192	\$4,652	\$5,448	\$6,706
	24½	116	1	132	6	40C25116TS	\$4,160	\$4,616	\$5,406	\$6,653
	24½	115	1	131	6	40C25115TS	\$4,129	\$4,582	\$5,366	\$6,604
	24½	114	1	130	6	40C25114TS	\$4,097	\$4,548	\$5,326	\$6,554
	24½	113	1	129	6	40C25113TS	\$4,049	\$4,493	\$5,263	\$6,477
	24½	112	1	128	6	40C25112TS	\$4,000	\$4,439	\$5,199	\$6,398
	24½	111	1	127	6	40C25111TS	\$3,972	\$4,409	\$5,163	\$6,355
	24½	110	1	126	6	40C25110TS	\$3,945	\$4,378	\$5,128	\$6,310
	24½	109	1	125	6	40C25109TS	\$3,919	\$4,349	\$5,093	\$6,267
	24½	108	1	123	6	40C25108TS	\$3,892	\$4,319	\$5,058	\$6,226
	24½	107	1	122	6	40C25107TS	\$3,865	\$4,289	\$5,023	\$6,182
	24½	106	1	121	5	40C25106TS	\$3,838	\$4,259	\$4,989	\$6,139
	24½	105	1	120	5	40C25105TS	\$3,811	\$4,230	\$4,954	\$6,097
	24½	104	1	119	5	40C25104TS	\$3,785	\$4,200	\$4,919	\$6,053
	24½	103	1	118	5	40C25103TS	\$3,725	\$4,134	\$4,841	\$5,959
	24½	102	1	117	5	40C25102TS	\$3,664	\$4,068	\$4,763	\$5,862
	24½	101	1	116	5	40C25101TS	\$3,604	\$4,001	\$4,685	\$5,766
	24½	100	1	114	5	40C25100TS	\$3,545	\$3,934	\$4,607	\$5,671
	24½	99	1	113	5	40C2599TS	\$3,514	\$3,900	\$4,568	\$5,620
	24½	98	1	112	5	40C2598TS	\$3,484	\$3,866	\$4,528	\$5,573
	24½	97	1	111	5	40C2597TS	\$3,453	\$3,833	\$4,488	\$5,524
	24½	96	1	110	5	40C2596TS	\$3,423	\$3,799	\$4,450	\$5,477
	24½	95	1	109	5	40C2595TS	\$3,383	\$3,755	\$4,397	\$5,410
	24½	94	1	108	5	40C2594TS	\$3,343	\$3,711	\$4,345	\$5,347
	24½	93	1	106	5	40C2593TS	\$3,304	\$3,666	\$4,295	\$5,284
	24½	92	1	105	5	40C2592TS	\$3,264	\$3,623	\$4,242	\$5,221
	24½	91	1	104	5	40C2591TS	\$3,224	\$3,578	\$4,191	\$5,158
	24½	90	1	103	5	40C2590TS	\$3,184	\$3,534	\$4,139	\$5,095
	24½	89	1	102	5	40C2589TS	\$3,144	\$3,489	\$4,087	\$5,029
24½	88	1	101	5	40C2588TS	\$3,104	\$3,445	\$4,034	\$4,965	
24½	87	1	100	5	40C2587TS	\$3,065	\$3,402	\$3,984	\$4,903	
24½	86	1	99	5	40C2586TS	\$3,025	\$3,357	\$3,931	\$4,838	
24½	85	1	97	4	40C2585TS	\$2,985	\$3,313	\$3,879	\$4,776	

• 3mm radius front edge, sides and back are flat

Specify: Model | Worksurface Solid Surface

Model	Worksurface Solid Surface
	see Forge Solid Surface Finishes

Description	D	W	H	CTN WT	CU FT	① Model	Tier 1	Tier 2	Tier 3	Tier 4
24½" d Solid Surface Worksurfaces (continued)	24½	84	1	96	4	40C2584TS	\$2,945	\$3,270	\$3,829	\$4,712
	24½	83	1	95	4	40C2583TS	\$2,905	\$3,224	\$3,775	\$4,647
	24½	82	1	94	4	40C2582TS	\$2,865	\$3,180	\$3,725	\$4,584
	24½	81	1	93	4	40C2581TS	\$2,825	\$3,136	\$3,672	\$4,518
	24½	80	1	92	4	40C2580TS	\$2,785	\$3,090	\$3,620	\$4,455
	24½	79	1	91	4	40C2579TS	\$2,745	\$3,046	\$3,568	\$4,390
	24½	78	1	90	4	40C2578TS	\$2,705	\$3,004	\$3,517	\$4,329
	24½	77	1	88	4	40C2577TS	\$2,665	\$2,958	\$3,463	\$4,263
	24½	76	1	87	4	40C2576TS	\$2,625	\$2,913	\$3,412	\$4,199
	24½	75	1	86	4	40C2575TS	\$2,586	\$2,870	\$3,361	\$4,136
	24½	74	1	85	4	40C2574TS	\$2,545	\$2,825	\$3,308	\$4,070
	24½	73	1	84	4	40C2573TS	\$2,505	\$2,780	\$3,256	\$4,007
	24½	72	1	83	4	40C2572TS	\$2,466	\$2,737	\$3,205	\$3,944
	24½	71	1	82	4	40C2571TS	\$2,435	\$2,703	\$3,167	\$3,897
	24½	70	1	80	4	40C2570TS	\$2,405	\$2,669	\$3,126	\$3,847
	24½	69	1	79	4	40C2569TS	\$2,374	\$2,635	\$3,086	\$3,797
	24½	68	1	78	4	40C2568TS	\$2,343	\$2,600	\$3,045	\$3,748
	24½	67	1	77	4	40C2567TS	\$2,312	\$2,565	\$3,005	\$3,698
	24½	66	1	76	4	40C2566TS	\$2,281	\$2,532	\$2,965	\$3,649
	24½	65	1	75	4	40C2565TS	\$2,254	\$2,501	\$2,929	\$3,604
	24½	64	1	74	4	40C2564TS	\$2,226	\$2,470	\$2,892	\$3,559
	24½	63	1	73	3	40C2563TS	\$2,199	\$2,441	\$2,857	\$3,516
	24½	62	1	71	3	40C2562TS	\$2,170	\$2,408	\$2,821	\$3,471
	24½	61	1	70	3	40C2561TS	\$2,142	\$2,377	\$2,784	\$3,426
	24½	60	1	69	3	40C2560TS	\$2,114	\$2,347	\$2,749	\$3,382
	24½	59	1	68	3	40C2559TS	\$2,086	\$2,316	\$2,711	\$3,337
	24½	58	1	67	3	40C2558TS	\$2,058	\$2,285	\$2,675	\$3,292
	24½	57	1	66	3	40C2557TS	\$2,023	\$2,246	\$2,630	\$3,236
	24½	56	1	65	3	40C2556TS	\$1,989	\$2,208	\$2,585	\$3,181
	24½	55	1	64	3	40C2555TS	\$1,954	\$2,169	\$2,540	\$3,127
	24½	54	1	62	3	40C2554TS	\$1,920	\$2,132	\$2,496	\$3,072
	24½	53	1	61	3	40C2553TS	\$1,893	\$2,101	\$2,460	\$3,029
24½	52	1	60	3	40C2552TS	\$1,865	\$2,070	\$2,424	\$2,983	
24½	51	1	59	3	40C2551TS	\$1,838	\$2,041	\$2,390	\$2,940	
24½	50	1	58	3	40C2550TS	\$1,810	\$2,009	\$2,353	\$2,896	
24½	49	1	57	3	40C2549TS	\$1,783	\$1,979	\$2,318	\$2,853	

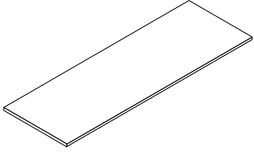

• 3mm radius front edge, sides and back are flat

Specify: Model | Worksurface Solid Surface

Model	Worksurface Solid Surface
	see Forge Solid Surface Finishes

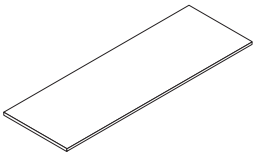
Description	D	W	H	CTN WT	CU FT	① Model	Tier 1	Tier 2	Tier 3	Tier 4
24½" d Solid Surface Worksurfaces (continued) 	24½	48	1	56	3	40C2548TS	\$1,757	\$1,950	\$2,284	\$2,810
	24½	47	1	55	3	40C2547TS	\$1,743	\$1,934	\$2,264	\$2,788
	24½	46	1	53	3	40C2546TS	\$1,729	\$1,918	\$2,246	\$2,765
	24½	45	1	52	3	40C2545TS	\$1,714	\$1,904	\$2,229	\$2,743
	24½	44	1	51	3	40C2544TS	\$1,701	\$1,887	\$2,210	\$2,720
	24½	43	1	50	3	40C2543TS	\$1,687	\$1,872	\$2,192	\$2,698
	24½	42	1	49	3	40C2542TS	\$1,673	\$1,858	\$2,175	\$2,675
	24½	41	1	48	2	40C2541TS	\$1,632	\$1,811	\$2,121	\$2,611
	24½	40	1	47	2	40C2540TS	\$1,593	\$1,767	\$2,070	\$2,548
	24½	39	1	45	2	40C2539TS	\$1,552	\$1,723	\$2,017	\$2,482
	24½	38	1	44	2	40C2538TS	\$1,513	\$1,678	\$1,966	\$2,419
	24½	37	1	43	2	40C2537TS	\$1,471	\$1,632	\$1,912	\$2,353
	24½	36	1	42	2	40C2536TS	\$1,432	\$1,590	\$1,862	\$2,290
	24½	35	1	41	2	40C2535TS	\$1,382	\$1,533	\$1,795	\$2,210
	24½	34	1	40	2	40C2534TS	\$1,331	\$1,478	\$1,730	\$2,128
	24½	33	1	39	2	40C2533TS	\$1,282	\$1,424	\$1,667	\$2,050
	24½	32	1	38	2	40C2532TS	\$1,231	\$1,366	\$1,600	\$1,970
	24½	31	1	36	2	40C2531TS	\$1,183	\$1,312	\$1,536	\$1,891
	24½	30	1	35	2	40C2530TS	\$1,133	\$1,257	\$1,472	\$1,812
	24½	29	1	34	2	40C2529TS	\$1,108	\$1,229	\$1,439	\$1,772
	24½	28	1	33	2	40C2528TS	\$1,084	\$1,203	\$1,409	\$1,734
	24½	27	1	32	2	40C2527TS	\$1,059	\$1,176	\$1,378	\$1,695
	24½	26	1	31	2	40C2526TS	\$1,036	\$1,149	\$1,347	\$1,657
	24½	25	1	30	2	40C2525TS	\$1,011	\$1,122	\$1,315	\$1,618
	24½	24	1	29	2	40C2524TS	\$987	\$1,096	\$1,284	\$1,579
	24½	23	1	27	2	40C2523TS	\$977	\$1,084	\$1,269	\$1,563
	24½	22	1	26	2	40C2522TS	\$967	\$1,072	\$1,255	\$1,544
	24½	21	1	25	2	40C2521TS	\$947	\$1,051	\$1,230	\$1,514
	24½	20	1	24	2	40C2520TS	\$927	\$1,029	\$1,205	\$1,483
	24½	19	1	23	1	40C2519TS	\$908	\$1,008	\$1,179	\$1,452
	24½	18	1	22	1	40C2518TS	\$889	\$986	\$1,156	\$1,422
	24½	17	1	21	1	40C2517TS	\$882	\$980	\$1,147	\$1,412
24½	16	1	19	1	40C2516TS	\$877	\$974	\$1,140	\$1,403	
24½	15	1	18	1	40C2515TS	\$872	\$969	\$1,133	\$1,395	
24½	14	1	17	1	40C2514TS	\$867	\$961	\$1,125	\$1,386	
24½	13	1	16	1	40C2513TS	\$862	\$955	\$1,119	\$1,378	
24½	12	1	15	1	40C2512TS	\$855	\$950	\$1,112	\$1,369	

• 3mm radius front edge, sides and back are flat

Specify: Model | Worksurface Solid Surface

Model	Worksurface Solid Surface
	see Forge Solid Surface Finishes

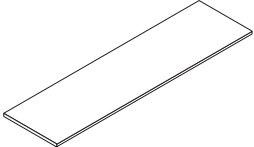
Description	D	W	H	CTN WT	CU FT	① Model	Tier 1	Tier 2	Tier 3	Tier 4
19½" d Solid Surface Worksurfaces 	19½	120	1	109	5	40C20120TS	\$3,356	\$3,726	\$4,363	\$5,370
	19½	119	1	108	5	40C20119TS	\$3,326	\$3,691	\$4,323	\$5,320
	19½	118	1	107	5	40C20118TS	\$3,298	\$3,659	\$4,284	\$5,273
	19½	117	1	107	5	40C20117TS	\$3,268	\$3,627	\$4,248	\$5,229
	19½	116	1	106	5	40C20116TS	\$3,238	\$3,594	\$4,209	\$5,179
	19½	115	1	105	5	40C20115TS	\$3,209	\$3,561	\$4,171	\$5,133
	19½	114	1	104	5	40C20114TS	\$3,180	\$3,529	\$4,134	\$5,087
	19½	113	1	103	5	40C20113TS	\$3,131	\$3,475	\$4,070	\$5,008
	19½	112	1	102	5	40C20112TS	\$3,082	\$3,420	\$4,006	\$4,931
	19½	111	1	101	5	40C20111TS	\$3,052	\$3,389	\$3,969	\$4,885
	19½	110	1	100	5	40C20110TS	\$3,026	\$3,359	\$3,933	\$4,840
	19½	109	1	99	5	40C20109TS	\$2,999	\$3,329	\$3,899	\$4,798
	19½	108	1	98	5	40C20108TS	\$2,972	\$3,301	\$3,865	\$4,756
	19½	107	1	98	5	40C20107TS	\$2,944	\$3,268	\$3,827	\$4,711
	19½	106	1	97	5	40C20106TS	\$2,917	\$3,239	\$3,793	\$4,668
	19½	105	1	96	4	40C20105TS	\$2,891	\$3,209	\$3,759	\$4,625
	19½	104	1	95	4	40C20104TS	\$2,863	\$3,178	\$3,722	\$4,580
	19½	103	1	94	4	40C20103TS	\$2,828	\$3,139	\$3,676	\$4,523
	19½	102	1	93	4	40C20102TS	\$2,794	\$3,101	\$3,631	\$4,469
	19½	101	1	92	4	40C20101TS	\$2,759	\$3,063	\$3,586	\$4,413
	19½	100	1	91	4	40C20100TS	\$2,725	\$3,024	\$3,542	\$4,358
	19½	99	1	90	4	40C2099TS	\$2,710	\$3,009	\$3,523	\$4,336
	19½	98	1	89	4	40C2098TS	\$2,695	\$2,992	\$3,504	\$4,311
	19½	97	1	89	4	40C2097TS	\$2,681	\$2,975	\$3,484	\$4,288
	19½	96	1	88	4	40C2096TS	\$2,665	\$2,959	\$3,465	\$4,265
	19½	95	1	87	4	40C2095TS	\$2,637	\$2,927	\$3,427	\$4,218
	19½	94	1	86	4	40C2094TS	\$2,608	\$2,895	\$3,390	\$4,172
	19½	93	1	85	4	40C2093TS	\$2,580	\$2,863	\$3,353	\$4,127
	19½	92	1	84	4	40C2092TS	\$2,551	\$2,830	\$3,314	\$4,079
	19½	91	1	83	4	40C2091TS	\$2,522	\$2,798	\$3,277	\$4,033
	19½	90	1	82	4	40C2090TS	\$2,493	\$2,767	\$3,240	\$3,987
	19½	89	1	81	4	40C2089TS	\$2,463	\$2,734	\$3,202	\$3,941
19½	88	1	80	4	40C2088TS	\$2,434	\$2,701	\$3,165	\$3,894	
19½	87	1	80	4	40C2087TS	\$2,406	\$2,670	\$3,127	\$3,849	
19½	86	1	79	4	40C2086TS	\$2,377	\$2,637	\$3,089	\$3,801	
19½	85	1	78	4	40C2085TS	\$2,348	\$2,605	\$3,051	\$3,756	

• 3mm radius front edge, sides and back are flat

Specify: Model | Worksurface Solid Surface

Model	Worksurface Solid Surface
	see Forge Solid Surface Finishes

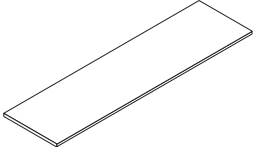
Description	D	W	H	CTN WT	CU FT	① Model	Tier 1	Tier 2	Tier 3	Tier 4
19½" d Solid Surface Worksurfaces (continued) 	19½	84	1	77	4	40C2084TS	\$2,319	\$2,574	\$3,014	\$3,710
	19½	83	1	76	4	40C2083TS	\$2,291	\$2,543	\$2,978	\$3,665
	19½	82	1	75	4	40C2082TS	\$2,264	\$2,513	\$2,943	\$3,623
	19½	81	1	74	4	40C2081TS	\$2,237	\$2,483	\$2,908	\$3,579
	19½	80	1	73	4	40C2080TS	\$2,210	\$2,453	\$2,873	\$3,534
	19½	79	1	72	4	40C2079TS	\$2,183	\$2,423	\$2,837	\$3,492
	19½	78	1	71	3	40C2078TS	\$2,156	\$2,394	\$2,803	\$3,450
	19½	77	1	71	3	40C2077TS	\$2,130	\$2,364	\$2,768	\$3,407
	19½	76	1	70	3	40C2076TS	\$2,103	\$2,334	\$2,734	\$3,363
	19½	75	1	69	3	40C2075TS	\$2,076	\$2,306	\$2,699	\$3,321
	19½	74	1	68	3	40C2074TS	\$2,049	\$2,274	\$2,664	\$3,278
	19½	73	1	67	3	40C2073TS	\$2,022	\$2,245	\$2,629	\$3,235
	19½	72	1	66	3	40C2072TS	\$1,996	\$2,215	\$2,594	\$3,193
	19½	71	1	65	3	40C2071TS	\$1,975	\$2,192	\$2,567	\$3,160
	19½	70	1	64	3	40C2070TS	\$1,953	\$2,169	\$2,539	\$3,126
	19½	69	1	63	3	40C2069TS	\$1,933	\$2,146	\$2,512	\$3,092
	19½	68	1	62	3	40C2068TS	\$1,911	\$2,121	\$2,484	\$3,058
	19½	67	1	62	3	40C2067TS	\$1,890	\$2,098	\$2,456	\$3,023
	19½	66	1	61	3	40C2066TS	\$1,868	\$2,074	\$2,428	\$2,989
	19½	65	1	60	3	40C2065TS	\$1,846	\$2,050	\$2,400	\$2,955
	19½	64	1	59	3	40C2064TS	\$1,826	\$2,025	\$2,373	\$2,920
	19½	63	1	58	3	40C2063TS	\$1,804	\$2,003	\$2,345	\$2,886
	19½	62	1	57	3	40C2062TS	\$1,782	\$1,978	\$2,317	\$2,852
	19½	61	1	56	3	40C2061TS	\$1,762	\$1,955	\$2,290	\$2,819
	19½	60	1	55	3	40C2060TS	\$1,740	\$1,933	\$2,263	\$2,785
	19½	59	1	54	3	40C2059TS	\$1,720	\$1,908	\$2,235	\$2,750
	19½	58	1	53	3	40C2058TS	\$1,698	\$1,884	\$2,207	\$2,716
	19½	57	1	53	3	40C2057TS	\$1,680	\$1,866	\$2,185	\$2,689
	19½	56	1	52	3	40C2056TS	\$1,665	\$1,847	\$2,163	\$2,663
	19½	55	1	51	3	40C2055TS	\$1,648	\$1,830	\$2,142	\$2,637
	19½	54	1	50	3	40C2054TS	\$1,631	\$1,811	\$2,121	\$2,611
	19½	53	1	49	3	40C2053TS	\$1,611	\$1,788	\$2,094	\$2,578
19½	52	1	48	3	40C2052TS	\$1,592	\$1,766	\$2,070	\$2,547	
19½	51	1	47	2	40C2051TS	\$1,571	\$1,745	\$2,043	\$2,514	
19½	50	1	46	2	40C2050TS	\$1,552	\$1,723	\$2,017	\$2,483	
19½	49	1	45	2	40C2049TS	\$1,532	\$1,700	\$1,991	\$2,450	

• 3mm radius front edge, sides and back are flat

Specify: Model | Worksurface Solid Surface

Model	Worksurface Solid Surface
	see Forge Solid Surface Finishes

Description	D	W	H	CTN WT	CU FT	① Model	Tier 1	Tier 2	Tier 3	Tier 4
19½" d Solid Surface Worksurfaces (continued)	19½	48	1	44	2	40C2048TS	\$1,513	\$1,679	\$1,967	\$2,420
	19½	47	1	44	2	40C2047TS	\$1,455	\$1,615	\$1,890	\$2,325
	19½	46	1	43	2	40C2046TS	\$1,398	\$1,551	\$1,816	\$2,236
	19½	45	1	42	2	40C2045TS	\$1,342	\$1,489	\$1,743	\$2,145
	19½	44	1	41	2	40C2044TS	\$1,284	\$1,425	\$1,669	\$2,053
	19½	43	1	40	2	40C2043TS	\$1,227	\$1,361	\$1,595	\$1,963
	19½	42	1	39	2	40C2042TS	\$1,171	\$1,299	\$1,521	\$1,872
	19½	41	1	38	2	40C2041TS	\$1,158	\$1,285	\$1,505	\$1,852
	19½	40	1	37	2	40C2040TS	\$1,146	\$1,273	\$1,490	\$1,833
	19½	39	1	36	2	40C2039TS	\$1,135	\$1,259	\$1,475	\$1,814
	19½	38	1	35	2	40C2038TS	\$1,121	\$1,245	\$1,458	\$1,794
	19½	37	1	35	2	40C2037TS	\$1,110	\$1,231	\$1,442	\$1,775
	19½	36	1	34	2	40C2036TS	\$1,096	\$1,218	\$1,426	\$1,755
	19½	35	1	33	2	40C2035TS	\$1,071	\$1,189	\$1,392	\$1,712
	19½	34	1	32	2	40C2034TS	\$1,047	\$1,161	\$1,360	\$1,674
	19½	33	1	31	2	40C2033TS	\$1,022	\$1,135	\$1,328	\$1,634
	19½	32	1	30	2	40C2032TS	\$998	\$1,107	\$1,296	\$1,595
	19½	31	1	29	2	40C2031TS	\$973	\$1,080	\$1,264	\$1,556
	19½	30	1	28	2	40C2030TS	\$948	\$1,053	\$1,232	\$1,517
	19½	29	1	27	2	40C2029TS	\$942	\$1,045	\$1,223	\$1,506
	19½	28	1	26	2	40C2028TS	\$936	\$1,039	\$1,217	\$1,497
	19½	27	1	26	2	40C2027TS	\$931	\$1,034	\$1,211	\$1,489
	19½	26	1	25	2	40C2026TS	\$925	\$1,027	\$1,203	\$1,481
	19½	25	1	24	2	40C2025TS	\$920	\$1,021	\$1,195	\$1,471
	19½	24	1	23	1	40C2024TS	\$915	\$1,015	\$1,189	\$1,463
	19½	23	1	22	1	40C2023TS	\$881	\$978	\$1,146	\$1,410
	19½	22	1	21	1	40C2022TS	\$848	\$942	\$1,103	\$1,357
	19½	21	1	20	1	40C2021TS	\$843	\$936	\$1,095	\$1,349
	19½	20	1	19	1	40C2020TS	\$838	\$930	\$1,088	\$1,339
	19½	19	1	18	1	40C2019TS	\$833	\$923	\$1,082	\$1,331
	19½	18	1	17	1	40C2018TS	\$827	\$918	\$1,075	\$1,322
	19½	17	1	17	1	40C2017TS	\$824	\$916	\$1,072	\$1,319
	19½	16	1	16	1	40C2016TS	\$822	\$913	\$1,069	\$1,316
19½	15	1	15	1	40C2015TS	\$820	\$911	\$1,067	\$1,321	
19½	14	1	14	1	40C2014TS	\$818	\$908	\$1,063	\$1,309	
19½	13	1	13	1	40C2013TS	\$816	\$906	\$1,060	\$1,306	
19½	12	1	12	1	40C2012TS	\$814	\$903	\$1,058	\$1,301	

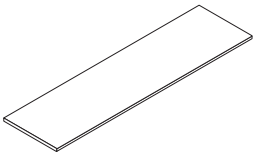

• 3mm radius front edge, sides and back are flat

Specify: Model | Worksurface Solid Surface

Model	Worksurface Solid Surface
	see Forge Solid Surface Finishes

Description	D	W	H	CTN WT	CU FT	① Model	Tier 1	Tier 2	Tier 3	Tier 4
Solid Surface Corner Worksurfaces	29	29	1 3/16	35	2	40C2929CTS	\$1,660	\$1,916	\$2,245	\$2,763
	24	24	1 3/16	24	2	40C2424CTS	\$1,368	\$1,578	\$1,850	\$2,276

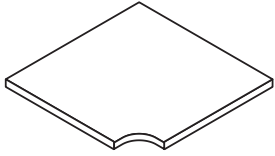

- 3mm radius front edge, sides and back are flat
- brackets must be specified separately, [see page 69](#)

Specify: Model | Worksurface Solid Surface

Model	Worksurface Solid Surface
	see Forge Solid Surface Finishes

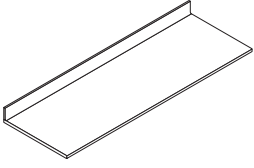
Description	D	W	H	CTN WT	CU FT	① Model	Tier 1	Tier 2	Tier 3	Tier 4
24½" d Solid Surface Worksurfaces with Integral Backsplash 	24½	120	5	153	14	40C25120TWBS	\$4,825	\$5,355	\$6,272	\$7,719
	24½	119	5	152	13	40C25119TWBS	\$4,785	\$5,311	\$6,221	\$7,655
	24½	118	5	151	13	40C25118TWBS	\$4,745	\$5,266	\$6,167	\$7,591
	24½	117	5	149	13	40C25117TWBS	\$4,703	\$5,221	\$6,115	\$7,525
	24½	116	5	148	13	40C25116TWBS	\$4,663	\$5,176	\$6,062	\$7,460
	24½	115	5	147	13	40C25115TWBS	\$4,622	\$5,131	\$6,008	\$7,395
	24½	114	5	146	13	40C25114TWBS	\$4,582	\$5,086	\$5,956	\$7,330
	24½	113	5	144	13	40C25113TWBS	\$4,541	\$5,040	\$5,902	\$7,265
	24½	112	5	143	13	40C25112TWBS	\$4,500	\$4,995	\$5,850	\$7,199
	24½	111	5	142	13	40C25111TWBS	\$4,459	\$4,950	\$5,797	\$7,135
	24½	110	5	141	13	40C25110TWBS	\$4,418	\$4,905	\$5,744	\$7,068
	24½	109	5	139	12	40C25109TWBS	\$4,378	\$4,859	\$5,691	\$7,004
	24½	108	5	138	12	40C25108TWBS	\$4,337	\$4,815	\$5,639	\$6,940
	24½	107	5	137	12	40C25107TWBS	\$4,298	\$4,770	\$5,586	\$6,876
	24½	106	5	136	12	40C25106TWBS	\$4,256	\$4,725	\$5,534	\$6,811
	24½	105	5	134	12	40C25105TWBS	\$4,216	\$4,680	\$5,481	\$6,745
	24½	104	5	133	12	40C25104TWBS	\$4,175	\$4,635	\$5,428	\$6,680
	24½	103	5	132	12	40C25103TWBS	\$4,135	\$4,589	\$5,375	\$6,614
	24½	102	5	130	12	40C25102TWBS	\$4,094	\$4,545	\$5,323	\$6,550
	24½	101	5	129	12	40C25101TWBS	\$4,054	\$4,499	\$5,269	\$6,485
	24½	100	5	128	11	40C25100TWBS	\$4,012	\$4,454	\$5,216	\$6,419
	24½	99	5	127	11	40C2599TWBS	\$3,972	\$4,409	\$5,164	\$6,356
	24½	98	5	125	11	40C2598TWBS	\$3,931	\$4,364	\$5,110	\$6,289
	24½	97	5	124	11	40C2597TWBS	\$3,891	\$4,318	\$5,057	\$6,225
	24½	96	5	123	11	40C2596TWBS	\$3,850	\$4,274	\$5,004	\$6,159
	24½	95	5	122	11	40C2595TWBS	\$3,805	\$4,222	\$4,946	\$6,087
	24½	94	5	120	11	40C2594TWBS	\$3,760	\$4,172	\$4,887	\$6,015
	24½	93	5	119	11	40C2593TWBS	\$3,716	\$4,124	\$4,830	\$5,944
	24½	92	5	118	11	40C2592TWBS	\$3,671	\$4,074	\$4,771	\$5,873
	24½	91	5	117	10	40C2591TWBS	\$3,626	\$4,025	\$4,713	\$5,800
24½	90	5	115	10	40C2590TWBS	\$3,582	\$3,976	\$4,656	\$5,729	
24½	89	5	114	10	40C2589TWBS	\$3,538	\$3,926	\$4,597	\$5,658	
24½	88	5	113	10	40C2588TWBS	\$3,492	\$3,875	\$4,539	\$5,586	
24½	87	5	111	10	40C2587TWBS	\$3,448	\$3,827	\$4,482	\$5,515	
24½	86	5	110	10	40C2586TWBS	\$3,404	\$3,776	\$4,423	\$5,444	
24½	85	5	109	10	40C2585TWBS	\$3,358	\$3,727	\$4,365	\$5,372	

- 3mm radius front edge, sides and back are flat
- 4" h backsplash

Specify: Model | Worksurface Solid Surface

Model	Worksurface Solid Surface
	see Forge Solid Surface Finishes

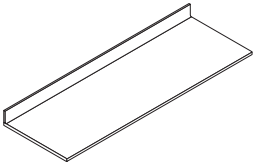
Description	D	W	H	CTN WT	CU FT	① Model	Tier 1	Tier 2	Tier 3	Tier 4
24½" d Solid Surface Worksurfaces with Integral Backsplash (continued) 	24½	84	5	108	10	40C2584TWBS	\$3,314	\$3,679	\$4,308	\$5,301
	24½	83	5	106	10	40C2583TWBS	\$3,270	\$3,628	\$4,249	\$5,230
	24½	82	5	105	10	40C2582TWBS	\$3,224	\$3,578	\$4,191	\$5,158
	24½	81	5	104	9	40C2581TWBS	\$3,179	\$3,528	\$4,133	\$5,086
	24½	80	5	103	9	40C2580TWBS	\$3,134	\$3,478	\$4,074	\$5,014
	24½	79	5	101	9	40C2579TWBS	\$3,089	\$3,428	\$4,014	\$4,941
	24½	78	5	100	9	40C2578TWBS	\$3,044	\$3,379	\$3,957	\$4,869
	24½	77	5	99	9	40C2577TWBS	\$3,003	\$3,333	\$3,903	\$4,803
	24½	76	5	98	9	40C2576TWBS	\$2,962	\$3,287	\$3,850	\$4,737
	24½	75	5	96	9	40C2575TWBS	\$2,920	\$3,241	\$3,796	\$4,672
	24½	74	5	95	9	40C2574TWBS	\$2,879	\$3,197	\$3,742	\$4,606
	24½	73	5	94	9	40C2573TWBS	\$2,837	\$3,149	\$3,688	\$4,540
	24½	72	5	92	8	40C2572TWBS	\$2,797	\$3,105	\$3,635	\$4,475
	24½	71	5	91	8	40C2571TWBS	\$2,761	\$3,064	\$3,587	\$4,415
	24½	70	5	90	8	40C2570TWBS	\$2,725	\$3,024	\$3,542	\$4,358
	24½	69	5	89	8	40C2569TWBS	\$2,690	\$2,985	\$3,496	\$4,303
	24½	68	5	87	8	40C2568TWBS	\$2,655	\$2,945	\$3,449	\$4,245
	24½	67	5	86	8	40C2567TWBS	\$2,619	\$2,906	\$3,405	\$4,190
	24½	66	5	85	8	40C2566TWBS	\$2,584	\$2,868	\$3,358	\$4,133
	24½	65	5	84	8	40C2565TWBS	\$2,549	\$2,828	\$3,312	\$4,076
	24½	64	5	82	8	40C2564TWBS	\$2,513	\$2,789	\$3,266	\$4,020
	24½	63	5	81	7	40C2563TWBS	\$2,478	\$2,750	\$3,220	\$3,963
	24½	62	5	80	7	40C2562TWBS	\$2,443	\$2,710	\$3,174	\$3,906
	24½	61	5	79	7	40C2561TWBS	\$2,407	\$2,671	\$3,128	\$3,850
	24½	60	5	77	7	40C2560TWBS	\$2,372	\$2,632	\$3,083	\$3,793
	24½	59	5	76	7	40C2559TWBS	\$2,337	\$2,592	\$3,036	\$3,736
	24½	58	5	75	7	40C2558TWBS	\$2,300	\$2,554	\$2,990	\$3,680
	24½	57	5	73	7	40C2557TWBS	\$2,265	\$2,514	\$2,944	\$3,624
	24½	56	5	72	7	40C2556TWBS	\$2,235	\$2,480	\$2,905	\$3,575
	24½	55	5	71	7	40C2555TWBS	\$2,203	\$2,445	\$2,863	\$3,523
24½	54	5	70	7	40C2554TWBS	\$2,170	\$2,409	\$2,822	\$3,472	
24½	53	5	68	6	40C2553TWBS	\$2,138	\$2,373	\$2,779	\$3,420	
24½	52	5	67	6	40C2552TWBS	\$2,106	\$2,338	\$2,738	\$3,369	
24½	51	5	66	6	40C2551TWBS	\$2,075	\$2,303	\$2,697	\$3,319	
24½	50	5	65	6	40C2550TWBS	\$2,043	\$2,268	\$2,656	\$3,268	
24½	49	5	63	6	40C2549TWBS	\$2,011	\$2,231	\$2,614	\$3,217	

• 3mm radius front edge, sides and back are flat

Specify: Model | Worksurface Solid Surface

Model	Worksurface Solid Surface
	see Forge Solid Surface Finishes

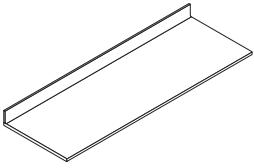
Description	D	W	H	CTN WT	CU FT	① Model	Tier 1	Tier 2	Tier 3	Tier 4
24½" d Solid Surface Worksurfaces with Integral Backsplash (continued) 	24½	48	5	62	6	40C2548TWBS	\$1,978	\$2,196	\$2,571	\$3,166
	24½	47	5	61	6	40C2547TWBS	\$1,970	\$2,163	\$2,534	\$3,118
	24½	46	5	60	6	40C2546TWBS	\$1,941	\$2,132	\$2,497	\$3,072
	24½	45	5	58	6	40C2545TWBS	\$1,912	\$2,101	\$2,459	\$3,026
	24½	44	5	57	5	40C2544TWBS	\$1,883	\$2,068	\$2,421	\$2,980
	24½	43	5	56	5	40C2543TWBS	\$1,854	\$2,035	\$2,383	\$2,934
	24½	42	5	54	5	40C2542TWBS	\$1,826	\$2,004	\$2,347	\$2,888
	24½	41	5	53	5	40C2541TWBS	\$1,797	\$1,971	\$2,309	\$2,841
	24½	40	5	52	5	40C2540TWBS	\$1,767	\$1,939	\$2,271	\$2,795
	24½	39	5	51	5	40C2539TWBS	\$1,738	\$1,908	\$2,234	\$2,749
	24½	38	5	49	5	40C2538TWBS	\$1,709	\$1,874	\$2,195	\$2,702
	24½	37	5	48	5	40C2537TWBS	\$1,680	\$1,842	\$2,158	\$2,656
	24½	36	5	47	5	40C2536TWBS	\$1,631	\$1,811	\$2,121	\$2,611
	24½	35	5	46	4	40C2535TWBS	\$1,566	\$1,738	\$2,035	\$2,505
	24½	34	5	44	4	40C2534TWBS	\$1,500	\$1,666	\$1,950	\$2,400
	24½	33	5	43	4	40C2533TWBS	\$1,435	\$1,594	\$1,866	\$2,296
	24½	32	5	42	4	40C2532TWBS	\$1,379	\$1,531	\$1,792	\$2,206
	24½	31	5	41	4	40C2531TWBS	\$1,323	\$1,468	\$1,721	\$2,116
	24½	30	5	39	4	40C2530TWBS	\$1,269	\$1,409	\$1,650	\$2,030
	24½	29	5	38	4	40C2529TWBS	\$1,241	\$1,377	\$1,612	\$1,982
	24½	28	5	37	4	40C2528TWBS	\$1,214	\$1,347	\$1,576	\$1,940
	24½	27	5	35	4	40C2527TWBS	\$1,187	\$1,318	\$1,542	\$1,898
	24½	26	5	34	4	40C2526TWBS	\$1,160	\$1,286	\$1,507	\$1,854
	24½	25	5	33	3	40C2525TWBS	\$1,133	\$1,257	\$1,471	\$1,811
	24½	24	5	32	3	40C2524TWBS	\$1,107	\$1,227	\$1,437	\$1,770
	24½	23	5	30	3	40C2523TWBS	\$1,089	\$1,210	\$1,416	\$1,743
	24½	22	5	29	3	40C2522TWBS	\$1,075	\$1,193	\$1,397	\$1,720
	24½	21	5	28	3	40C2521TWBS	\$1,060	\$1,177	\$1,378	\$1,696
	24½	20	5	27	3	40C2520TWBS	\$1,038	\$1,151	\$1,349	\$1,660
	24½	19	5	25	3	40C2519TWBS	\$1,016	\$1,128	\$1,321	\$1,626
	24½	18	5	24	3	40C2518TWBS	\$995	\$1,105	\$1,294	\$1,592
	24½	17	5	23	3	40C2517TWBS	\$989	\$1,097	\$1,285	\$1,583
24½	16	5	22	2	40C2516TWBS	\$983	\$1,090	\$1,278	\$1,571	
24½	15	5	20	2	40C2515TWBS	\$977	\$1,084	\$1,269	\$1,562	
24½	14	5	19	2	40C2514TWBS	\$971	\$1,077	\$1,261	\$1,551	
24½	13	5	18	2	40C2513TWBS	\$964	\$1,069	\$1,252	\$1,541	
24½	12	5	16	2	40C2512TWBS	\$957	\$1,062	\$1,244	\$1,531	

• 3mm radius front edge, sides and back are flat

Specify: Model | Worksurface Solid Surface

Model	Worksurface Solid Surface
	see Forge Solid Surface Finishes

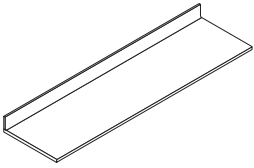
Description	D	W	H	CTN WT	CU FT	① Model	Tier 1	Tier 2	Tier 3	Tier 4
1 1/2" d Solid Surface Worksurfaces with Integral Backsplash 	19 1/2	120	5	125	11	40C20120TWBS	\$3,773	\$4,190	\$4,906	\$6,038
	19 1/2	119	5	124	11	40C20119TWBS	\$3,741	\$4,153	\$4,863	\$5,985
	19 1/2	118	5	123	11	40C20118TWBS	\$3,710	\$4,116	\$4,821	\$5,933
	19 1/2	117	5	122	11	40C20117TWBS	\$3,678	\$4,081	\$4,780	\$5,883
	19 1/2	116	5	121	11	40C20116TWBS	\$3,645	\$4,044	\$4,736	\$5,830
	19 1/2	115	5	120	11	40C20115TWBS	\$3,612	\$4,009	\$4,695	\$5,779
	19 1/2	114	5	119	11	40C20114TWBS	\$3,579	\$3,973	\$4,652	\$5,725
	19 1/2	113	5	118	11	40C20113TWBS	\$3,542	\$3,931	\$4,604	\$5,665
	19 1/2	112	5	117	10	40C20112TWBS	\$3,504	\$3,890	\$4,555	\$5,606
	19 1/2	111	5	116	10	40C20111TWBS	\$3,466	\$3,848	\$4,507	\$5,546
	19 1/2	110	5	115	10	40C20110TWBS	\$3,428	\$3,806	\$4,457	\$5,485
	19 1/2	109	5	114	10	40C20109TWBS	\$3,391	\$3,764	\$4,409	\$5,426
	19 1/2	108	5	113	10	40C20108TWBS	\$3,354	\$3,723	\$4,359	\$5,366
	19 1/2	107	5	112	10	40C20107TWBS	\$3,308	\$3,671	\$4,299	\$5,291
	19 1/2	106	5	111	10	40C20106TWBS	\$3,264	\$3,623	\$4,242	\$5,221
	19 1/2	105	5	110	10	40C20105TWBS	\$3,220	\$3,574	\$4,185	\$5,152
	19 1/2	104	5	109	10	40C20104TWBS	\$3,176	\$3,524	\$4,129	\$5,080
	19 1/2	103	5	108	10	40C20103TWBS	\$3,132	\$3,476	\$4,070	\$5,010
	19 1/2	102	5	107	10	40C20102TWBS	\$3,088	\$3,427	\$4,013	\$4,940
	19 1/2	101	5	106	9	40C20101TWBS	\$3,067	\$3,404	\$3,986	\$4,905
	19 1/2	100	5	104	9	40C20100TWBS	\$3,044	\$3,379	\$3,957	\$4,869
	19 1/2	99	5	103	9	40C2099TWBS	\$3,033	\$3,366	\$3,942	\$4,852
	19 1/2	98	5	102	9	40C2098TWBS	\$3,021	\$3,354	\$3,927	\$4,833
	19 1/2	97	5	101	9	40C2097TWBS	\$3,010	\$3,340	\$3,912	\$4,815
	19 1/2	96	5	100	9	40C2096TWBS	\$2,999	\$3,329	\$3,899	\$4,798
	19 1/2	95	5	99	9	40C2095TWBS	\$2,965	\$3,290	\$3,853	\$4,743
	19 1/2	94	5	98	9	40C2094TWBS	\$2,932	\$3,253	\$3,810	\$4,690
	19 1/2	93	5	97	9	40C2093TWBS	\$2,899	\$3,217	\$3,767	\$4,638
	19 1/2	92	5	96	9	40C2092TWBS	\$2,864	\$3,178	\$3,722	\$4,582
	19 1/2	91	5	95	9	40C2091TWBS	\$2,832	\$3,143	\$3,681	\$4,530
19 1/2	90	5	94	9	40C2090TWBS	\$2,801	\$3,109	\$3,641	\$4,481	
19 1/2	89	5	93	8	40C2089TWBS	\$2,769	\$3,073	\$3,599	\$4,429	
19 1/2	88	5	92	8	40C2088TWBS	\$2,738	\$3,038	\$3,558	\$4,379	
19 1/2	87	5	91	8	40C2087TWBS	\$2,705	\$3,004	\$3,517	\$4,329	
19 1/2	86	5	90	8	40C2086TWBS	\$2,674	\$2,968	\$3,476	\$4,278	
19 1/2	85	5	89	8	40C2085TWBS	\$2,642	\$2,933	\$3,435	\$4,227	

• 3mm radius front edge, sides and back are flat

Specify: Model | Worksurface Solid Surface

Model	Worksurface Solid Surface
	see Forge Solid Surface Finishes

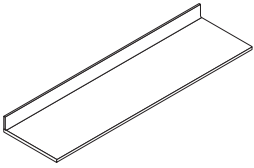
Description	D	W	H	CTN WT	CU FT	① Model	Tier 1	Tier 2	Tier 3	Tier 4
19½" d Solid Surface Worksurfaces with Integral Backsplash (continued) 	19½	84	5	88	8	40C2084TWBS	\$2,612	\$2,899	\$3,394	\$4,177
	19½	83	5	87	8	40C2083TWBS	\$2,584	\$2,868	\$3,358	\$4,134
	19½	82	5	86	8	40C2082TWBS	\$2,557	\$2,837	\$3,324	\$4,091
	19½	81	5	85	8	40C2081TWBS	\$2,529	\$2,807	\$3,287	\$4,046
	19½	80	5	84	8	40C2080TWBS	\$2,502	\$2,777	\$3,253	\$4,003
	19½	79	5	83	8	40C2079TWBS	\$2,475	\$2,746	\$3,217	\$3,958
	19½	78	5	82	7	40C2078TWBS	\$2,448	\$2,718	\$3,182	\$3,917
	19½	77	5	81	7	40C2077TWBS	\$2,414	\$2,677	\$3,137	\$3,860
	19½	76	5	80	7	40C2076TWBS	\$2,380	\$2,641	\$3,094	\$3,807
	19½	75	5	79	7	40C2075TWBS	\$2,347	\$2,605	\$3,050	\$3,755
	19½	74	5	78	7	40C2074TWBS	\$2,314	\$2,567	\$3,007	\$3,701
	19½	73	5	77	7	40C2073TWBS	\$2,281	\$2,531	\$2,964	\$3,648
	19½	72	5	76	7	40C2072TWBS	\$2,247	\$2,495	\$2,922	\$3,595
	19½	71	5	75	7	40C2071TWBS	\$2,222	\$2,467	\$2,889	\$3,555
	19½	70	5	73	7	40C2070TWBS	\$2,200	\$2,442	\$2,859	\$3,518
	19½	69	5	72	7	40C2069TWBS	\$2,176	\$2,416	\$2,828	\$3,480
	19½	68	5	71	7	40C2068TWBS	\$2,152	\$2,389	\$2,797	\$3,443
	19½	67	5	70	7	40C2067TWBS	\$2,128	\$2,362	\$2,767	\$3,406
	19½	66	5	69	6	40C2066TWBS	\$2,105	\$2,338	\$2,737	\$3,368
	19½	65	5	68	6	40C2065TWBS	\$2,081	\$2,311	\$2,705	\$3,329
	19½	64	5	67	6	40C2064TWBS	\$2,057	\$2,284	\$2,674	\$3,291
	19½	63	5	66	6	40C2063TWBS	\$2,034	\$2,258	\$2,645	\$3,254
	19½	62	5	65	6	40C2062TWBS	\$2,011	\$2,231	\$2,614	\$3,217
	19½	61	5	64	6	40C2061TWBS	\$1,989	\$2,208	\$2,585	\$3,181
	19½	60	5	63	6	40C2060TWBS	\$1,969	\$2,185	\$2,559	\$3,149
	19½	59	5	62	6	40C2059TWBS	\$1,948	\$2,161	\$2,532	\$3,116
	19½	58	5	61	6	40C2058TWBS	\$1,927	\$2,138	\$2,504	\$3,082
	19½	57	5	60	6	40C2057TWBS	\$1,907	\$2,116	\$2,479	\$3,049
	19½	56	5	59	6	40C2056TWBS	\$1,886	\$2,093	\$2,451	\$3,016
	19½	55	5	58	5	40C2055TWBS	\$1,861	\$2,066	\$2,419	\$2,977
19½	54	5	57	5	40C2054TWBS	\$1,835	\$2,038	\$2,386	\$2,936	
19½	53	5	56	5	40C2053TWBS	\$1,813	\$2,013	\$2,357	\$2,901	
19½	52	5	55	5	40C2052TWBS	\$1,791	\$1,988	\$2,327	\$2,865	
19½	51	5	54	5	40C2051TWBS	\$1,768	\$1,964	\$2,298	\$2,829	
19½	50	5	53	5	40C2050TWBS	\$1,747	\$1,939	\$2,271	\$2,795	
19½	49	5	52	5	40C2049TWBS	\$1,725	\$1,914	\$2,242	\$2,758	

• 3mm radius front edge, sides and back are flat

Specify: Model | Worksurface Solid Surface

Model	Worksurface Solid Surface
	see Forge Solid Surface Finishes

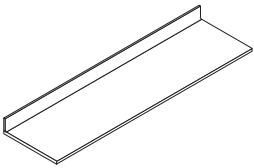
Description	D	W	H	CTN WT	CU FT	① Model	Tier 1	Tier 2	Tier 3	Tier 4
19½" d Solid Surface Worksurfaces with Integral Backsplash (continued) 	19½	48	5	51	5	40C2048TWBS	\$1,702	\$1,890	\$2,213	\$2,723
	19½	47	5	50	5	40C2047TWBS	\$1,638	\$1,817	\$2,128	\$2,619
	19½	46	5	49	5	40C2046TWBS	\$1,573	\$1,746	\$2,045	\$2,516
	19½	45	5	48	5	40C2045TWBS	\$1,509	\$1,675	\$1,962	\$2,414
	19½	44	5	47	5	40C2044TWBS	\$1,446	\$1,604	\$1,879	\$2,313
	19½	43	5	46	4	40C2043TWBS	\$1,382	\$1,533	\$1,795	\$2,210
	19½	42	5	45	4	40C2042TWBS	\$1,319	\$1,463	\$1,713	\$2,109
	19½	41	5	44	4	40C2041TWBS	\$1,297	\$1,439	\$1,685	\$2,074
	19½	40	5	42	4	40C2040TWBS	\$1,277	\$1,416	\$1,659	\$2,042
	19½	39	5	41	4	40C2039TWBS	\$1,255	\$1,393	\$1,631	\$2,007
	19½	38	5	40	4	40C2038TWBS	\$1,235	\$1,370	\$1,604	\$1,974
	19½	37	5	39	4	40C2037TWBS	\$1,214	\$1,347	\$1,576	\$1,940
	19½	36	5	38	4	40C2036TWBS	\$1,193	\$1,324	\$1,551	\$1,908
	19½	35	5	37	4	40C2035TWBS	\$1,172	\$1,300	\$1,522	\$1,873
	19½	34	5	36	4	40C2034TWBS	\$1,151	\$1,278	\$1,496	\$1,841
	19½	33	5	35	4	40C2033TWBS	\$1,131	\$1,255	\$1,469	\$1,809
	19½	32	5	34	3	40C2032TWBS	\$1,111	\$1,231	\$1,442	\$1,776
	19½	31	5	33	3	40C2031TWBS	\$1,090	\$1,210	\$1,416	\$1,743
	19½	30	5	32	3	40C2030TWBS	\$1,070	\$1,188	\$1,390	\$1,710
	19½	29	5	31	3	40C2029TWBS	\$1,062	\$1,179	\$1,381	\$1,700
	19½	28	5	30	3	40C2028TWBS	\$1,056	\$1,172	\$1,373	\$1,690
	19½	27	5	29	3	40C2027TWBS	\$1,050	\$1,165	\$1,364	\$1,679
	19½	26	5	28	3	40C2026TWBS	\$1,043	\$1,158	\$1,356	\$1,669
	19½	25	5	27	3	40C2025TWBS	\$1,037	\$1,150	\$1,348	\$1,658
	19½	24	5	26	3	40C2024TWBS	\$1,030	\$1,144	\$1,339	\$1,648
	19½	23	5	25	3	40C2023TWBS	\$1,013	\$1,124	\$1,318	\$1,621
	19½	22	5	24	3	40C2022TWBS	\$997	\$1,106	\$1,295	\$1,593
	19½	21	5	23	2	40C2021TWBS	\$979	\$1,087	\$1,273	\$1,566
	19½	20	5	22	2	40C2020TWBS	\$961	\$1,068	\$1,250	\$1,538
	19½	19	5	21	2	40C2019TWBS	\$945	\$1,049	\$1,227	\$1,512
19½	18	5	20	2	40C2018TWBS	\$927	\$1,030	\$1,206	\$1,484	
19½	17	5	19	2	40C2017TWBS	\$922	\$1,023	\$1,197	\$1,473	
19½	16	5	18	2	40C2016TWBS	\$917	\$1,016	\$1,191	\$1,465	
19½	15	5	17	2	40C2015TWBS	\$911	\$1,011	\$1,185	\$1,458	
19½	14	5	16	2	40C2014TWBS	\$905	\$1,005	\$1,176	\$1,447	
19½	13	5	15	2	40C2013TWBS	\$900	\$999	\$1,170	\$1,438	
19½	12	5	14	2	40C2012TWBS	\$895	\$993	\$1,162	\$1,430	

• 3mm radius front edge, sides and back are flat

Specify: Model | Worksurface Solid Surface

Model	Worksurface Solid Surface
	see Forge Solid Surface Finishes

Description	D	W	H	CTN WT	CU FT	① Model	Tier 1	Tier 2	Tier 3	Tier 4
Solid Surface Corner	29	29	5	42	4	40C2929CTSBS	\$1,893	\$2,101	\$2,460	\$3,029
Worksurface with Integral Backsplash	24	24	5	30	3	40C2424CTSBS	\$1,592	\$1,766	\$2,070	\$2,547

- 3mm radius front edge, sides and back are flat
- brackets must be specified separately, [see page 69](#)

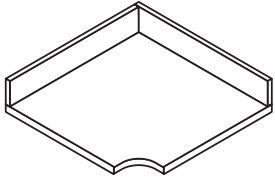

Specify: Model | Worksurface Solid Surface

Model	Worksurface Solid Surface
	see Forge Solid Surface Finishes

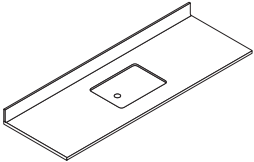
Description	D	W	H	CTN WT	CU FT	① Model	Tier 1	Tier 2	Tier 3	Tier 4
24½" d Solid Surface Worksurfaces with Integral Backsplash & Sink 	24½	120	5	173	26	40C25120TWBSSS	\$6,966	\$7,350	\$8,012	\$9,056
	24½	119	5	172	26	40C25119TWBSSS	\$6,929	\$7,831	\$9,147	\$10,394
	24½	118	5	171	25	40C25118TWBSSS	\$6,893	\$7,789	\$9,098	\$10,340
	24½	117	5	169	25	40C25117TWBSSS	\$6,856	\$7,234	\$7,885	\$8,913
	24½	116	5	168	25	40C25116TWBSSS	\$6,820	\$7,707	\$9,004	\$10,229
	24½	115	5	167	25	40C25115TWBSSS	\$6,784	\$7,667	\$8,955	\$10,175
	24½	114	5	166	25	40C25114TWBSSS	\$6,747	\$7,119	\$7,759	\$8,772
	24½	113	5	164	24	40C25113TWBSSS	\$6,690	\$7,561	\$8,832	\$10,036
	24½	112	5	163	24	40C25112TWBSSS	\$6,634	\$7,496	\$8,757	\$9,950
	24½	111	5	162	24	40C25111TWBSSS	\$6,602	\$6,965	\$7,593	\$8,582
	24½	110	5	161	24	40C25110TWBSSS	\$6,571	\$7,426	\$8,673	\$9,856
	24½	109	5	159	23	40C25109TWBSSS	\$6,540	\$7,390	\$8,633	\$9,809
	24½	108	5	158	23	40C25108TWBSSS	\$6,508	\$6,868	\$7,486	\$8,461
	24½	107	5	157	23	40C25107TWBSSS	\$6,477	\$7,320	\$8,551	\$9,715
	24½	106	5	156	23	40C25106TWBSSS	\$6,445	\$7,284	\$8,508	\$9,667
	24½	105	5	154	23	40C25105TWBSSS	\$6,414	\$6,768	\$7,377	\$8,339
	24½	104	5	153	22	40C25104TWBSSS	\$6,383	\$7,214	\$8,426	\$9,574
	24½	103	5	152	22	40C25103TWBSSS	\$6,330	\$7,154	\$8,355	\$9,494
	24½	102	5	150	22	40C25102TWBSSS	\$6,278	\$6,624	\$7,220	\$8,161
	24½	101	5	149	22	40C25101TWBSSS	\$6,227	\$7,036	\$8,219	\$9,340
	24½	100	5	148	22	40C25100TWBSSS	\$6,175	\$6,979	\$8,152	\$9,262
	24½	99	5	147	21	40C2599TWBSSS	\$6,124	\$6,462	\$7,043	\$7,961
	24½	98	5	145	21	40C2598TWBSSS	\$6,072	\$6,862	\$8,016	\$9,109
	24½	97	5	144	21	40C2597TWBSSS	\$6,021	\$6,805	\$7,948	\$9,032
	24½	96	5	143	21	40C2596TWBSSS	\$5,969	\$6,299	\$6,865	\$7,761
	24½	95	5	142	21	40C2595TWBSSS	\$5,926	\$6,698	\$7,822	\$8,888
	24½	94	5	140	20	40C2594TWBSSS	\$5,880	\$6,645	\$7,762	\$8,819
	24½	93	5	139	20	40C2593TWBSSS	\$5,833	\$6,155	\$6,709	\$7,584
	24½	92	5	138	20	40C2592TWBSSS	\$5,788	\$6,541	\$7,640	\$8,681
	24½	91	5	137	20	40C2591TWBSSS	\$5,742	\$6,488	\$7,578	\$8,612
24½	90	5	135	20	40C2590TWBSSS	\$5,695	\$6,010	\$6,550	\$7,404	
24½	89	5	134	19	40C2589TWBSSS	\$5,649	\$6,384	\$7,458	\$8,474	
24½	88	5	133	19	40C2588TWBSSS	\$5,604	\$6,332	\$7,397	\$8,404	
24½	87	5	131	19	40C2587TWBSSS	\$5,557	\$5,863	\$6,392	\$7,225	
24½	86	5	130	19	40C2586TWBSSS	\$5,511	\$6,228	\$7,275	\$8,266	
24½	85	5	129	19	40C2585TWBSSS	\$5,466	\$6,176	\$7,215	\$8,198	

- 3mm radius front edge, sides and back are flat
- Integral Sink is always Designer White

Specify: Model | Worksurface Solid Surface | Sink Location

Model	Worksurface Solid Surface	Sink Location
	see Forge Solid Surface Finishes	Sink location is available in 1" increments from left side of worksurface to centerline of sink with minimum of 12" to centerline from either edge of surface. Sink should always be centered over sink cabinet

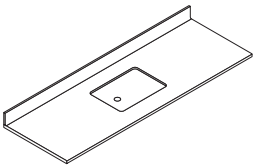
Description	D	W	H	CTN WT	CU FT	① Model	Tier 1	Tier 2	Tier 3	Tier 4
24½" d Solid Surface Worksurfaces with Integral Backsplash & Sink (continued) 	24½	84	5	128	18	40C2584TWBSSS	\$5,419	\$5,718	\$6,232	\$7,046
	24½	83	5	126	18	40C2583TWBSSS	\$5,370	\$6,068	\$7,088	\$8,054
	24½	82	5	125	18	40C2582TWBSSS	\$5,321	\$6,014	\$7,025	\$7,983
	24½	81	5	124	18	40C2581TWBSSS	\$5,272	\$5,562	\$6,064	\$6,854
	24½	80	5	123	17	40C2580TWBSSS	\$5,225	\$5,903	\$6,896	\$7,836
	24½	79	5	121	17	40C2579TWBSSS	\$5,175	\$5,848	\$6,831	\$7,762
	24½	78	5	120	17	40C2578TWBSSS	\$5,127	\$5,409	\$5,896	\$6,665
	24½	77	5	119	17	40C2577TWBSSS	\$5,078	\$5,740	\$6,704	\$7,617
	24½	76	5	118	17	40C2576TWBSSS	\$5,030	\$5,685	\$6,640	\$7,545
	24½	75	5	116	16	40C2575TWBSSS	\$5,001	\$5,276	\$5,752	\$6,502
	24½	74	5	115	16	40C2574TWBSSS	\$4,971	\$5,618	\$6,562	\$7,457
	24½	73	5	114	16	40C2573TWBSSS	\$4,942	\$5,585	\$6,525	\$7,413
	24½	72	5	112	16	40C2572TWBSSS	\$4,913	\$5,183	\$5,649	\$6,386
	24½	71	5	111	16	40C2571TWBSSS	\$4,868	\$5,502	\$6,427	\$7,302
	24½	70	5	110	15	40C2570TWBSSS	\$4,824	\$5,451	\$6,367	\$7,235
	24½	69	5	109	15	40C2569TWBSSS	\$4,779	\$5,042	\$5,496	\$6,211
	24½	68	5	107	15	40C2568TWBSSS	\$4,733	\$5,349	\$6,248	\$7,100
	24½	67	5	106	15	40C2567TWBSSS	\$4,689	\$5,298	\$6,190	\$7,032
	24½	66	5	105	15	40C2566TWBSSS	\$4,644	\$4,899	\$5,341	\$6,037
	24½	65	5	104	14	40C2565TWBSSS	\$4,598	\$5,196	\$6,070	\$6,897
	24½	64	5	102	14	40C2564TWBSSS	\$4,553	\$5,146	\$6,011	\$6,829
	24½	63	5	101	14	40C2563TWBSSS	\$4,529	\$4,779	\$5,209	\$5,888
	24½	62	5	100	14	40C2562TWBSSS	\$4,504	\$5,089	\$5,944	\$6,755
	24½	61	5	99	14	40C2561TWBSSS	\$4,478	\$5,060	\$5,911	\$6,716
	24½	60	5	97	13	40C2560TWBSSS	\$4,452	\$4,697	\$5,121	\$5,788
	24½	59	5	96	13	40C2559TWBSSS	\$4,416	\$4,991	\$5,830	\$6,624
	24½	58	5	95	13	40C2558TWBSSS	\$4,381	\$4,951	\$5,783	\$6,572
	24½	57	5	93	13	40C2557TWBSSS	\$4,346	\$4,586	\$4,998	\$5,649
	24½	56	5	92	13	40C2556TWBSSS	\$4,310	\$4,870	\$5,690	\$6,466
	24½	55	5	91	12	40C2555TWBSSS	\$4,275	\$4,831	\$5,643	\$6,412
24½	54	5	90	12	40C2554TWBSSS	\$4,240	\$4,473	\$4,877	\$5,512	
24½	53	5	88	12	40C2553TWBSSS	\$4,216	\$4,764	\$5,566	\$6,325	
24½	52	5	87	12	40C2552TWBSSS	\$4,194	\$4,738	\$5,536	\$6,290	
24½	51	5	86	11	40C2551TWBSSS	\$4,171	\$4,402	\$4,797	\$5,422	
24½	50	5	85	11	40C2550TWBSSS	\$4,148	\$4,689	\$5,477	\$6,223	
24½	49	5	83	11	40C2549TWBSSS	\$4,103	\$4,637	\$5,416	\$6,154	

- 3mm radius front edge, sides and back are flat
- Integral Sink is always Designer White

Specify: Model | Worksurface Solid Surface | Sink Location

Model	Worksurface Solid Surface	Sink Location
	see Forge Solid Surface Finishes	Sink location is available in 1" increments from left side of worksurface to centerline of sink with minimum of 12" to centerline from either edge of surface. Sink should always be centered over sink cabinet

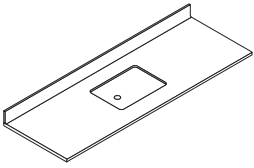
Description	D	W	H	CTN WT	CU FT	① Model	Tier 1	Tier 2	Tier 3	Tier 4
24½" d Solid Surface Worksurfaces with Integral Backsplash & Sink (continued) 	24½	48	5	82	11	40C2548TWBSSS	\$4,056	\$4,279	\$4,664	\$5,272
	24½	47	5	81	11	40C2547TWBSSS	\$4,039	\$4,565	\$5,333	\$6,059
	24½	46	5	80	10	40C2546TWBSSS	\$4,024	\$4,547	\$5,311	\$6,035
	24½	45	5	78	10	40C2545TWBSSS	\$4,007	\$4,228	\$4,609	\$5,209
	24½	44	5	77	10	40C2544TWBSSS	\$3,991	\$4,511	\$5,268	\$5,987
	24½	43	5	76	10	40C2543TWBSSS	\$3,975	\$4,492	\$5,247	\$5,962
	24½	42	5	74	10	40C2542TWBSSS	\$3,959	\$4,177	\$4,553	\$5,147
	24½	41	5	73	9	40C2541TWBSSS	\$3,912	\$4,421	\$5,164	\$5,868
	24½	40	5	72	9	40C2540TWBSSS	\$3,866	\$4,370	\$5,103	\$5,798
	24½	39	5	71	9	40C2539TWBSSS	\$3,820	\$4,031	\$4,392	\$4,966
	24½	38	5	69	9	40C2538TWBSSS	\$3,772	\$4,264	\$4,980	\$5,659
	24½	37	5	68	9	40C2537TWBSSS	\$3,727	\$4,212	\$4,919	\$5,589
	24½	36	5	67	8	40C2536TWBSSS	\$3,681	\$3,883	\$4,234	\$4,785
	24½	35	5	66	8	40C2535TWBSSS	\$3,596	\$4,111	\$4,802	\$5,456
	24½	34	5	64	8	40C2534TWBSSS	\$3,554	\$4,064	\$4,747	\$5,394
	24½	33	5	63	8	40C2533TWBSSS	\$3,513	\$3,706	\$4,039	\$4,566
	24½	32	5	62	8	40C2532TWBSSS	\$3,454	\$3,904	\$4,560	\$5,181
	24½	31	5	61	7	40C2531TWBSSS	\$3,397	\$3,840	\$4,485	\$5,097
	24½	30	5	59	7	40C2530TWBSSS	\$3,341	\$3,525	\$3,842	\$4,344
	24½	29	5	58	7	40C2529TWBSSS	\$3,317	\$3,749	\$4,379	\$4,975
	24½	28	5	57	7	40C2528TWBSSS	\$3,292	\$3,721	\$4,347	\$4,939
	24½	27	5	55	6	40C2527TWBSSS	\$3,268	\$3,448	\$3,759	\$4,248
	24½	26	5	54	6	40C2526TWBSSS	\$3,256	\$3,681	\$4,299	\$4,885
	24½	25	5	53	6	40C2525TWBSSS	\$3,213	\$3,631	\$4,242	\$4,820
24½	24	5	52	6	40C2524TWBSSS	\$3,171	\$3,345	\$3,647	\$4,122	

- 3mm radius front edge, sides and back are flat
- Integral Sink is always Designer White

Specify: Model | Worksurface Solid Surface | Sink Location

Model	Worksurface Solid Surface	Sink Location
	see Forge Solid Surface Finishes	Sink location is available in 1" increments from left side of worksurface to centerline of sink with minimum of 12" to centerline from either edge of surface. Sink should always be centered over sink cabinet

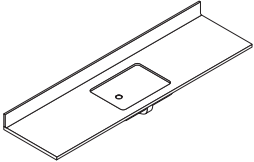
Description	D	W	H	CTN WT	CU FT	① Model	Tier 1	Tier 2	Tier 3	Tier 4
19½" d Solid Surface Worksurfaces with Integral Backsplash & Sink 	19½	120	5	144	21	40C20120TWBSSS	\$5,892	\$6,218	\$6,776	\$7,660
	19½	119	5	143	21	40C20119TWBSSS	\$5,853	\$6,614	\$7,727	\$8,779
	19½	118	5	142	21	40C20118TWBSSS	\$5,814	\$6,570	\$7,674	\$8,719
	19½	117	5	141	20	40C20117TWBSSS	\$5,774	\$6,092	\$6,640	\$7,506
	19½	116	5	140	20	40C20116TWBSSS	\$5,735	\$6,479	\$7,569	\$8,601
	19½	115	5	139	20	40C20115TWBSSS	\$5,695	\$6,437	\$7,518	\$8,542
	19½	114	5	138	20	40C20114TWBSSS	\$5,656	\$5,967	\$6,504	\$7,353
	19½	113	5	137	20	40C20113TWBSSS	\$5,616	\$6,346	\$7,413	\$8,424
	19½	112	5	136	20	40C20112TWBSSS	\$5,577	\$6,302	\$7,361	\$8,365
	19½	111	5	135	19	40C20111TWBSSS	\$5,549	\$5,854	\$6,381	\$7,214
	19½	110	5	133	19	40C20110TWBSSS	\$5,520	\$6,237	\$7,287	\$8,280
	19½	109	5	132	19	40C20109TWBSSS	\$5,490	\$6,205	\$7,248	\$8,236
	19½	108	5	131	19	40C20108TWBSSS	\$5,462	\$5,763	\$6,281	\$7,101
	19½	107	5	130	19	40C20107TWBSSS	\$5,429	\$6,135	\$7,166	\$8,144
	19½	106	5	129	19	40C20106TWBSSS	\$5,395	\$6,096	\$7,121	\$8,092
	19½	105	5	128	18	40C20105TWBSSS	\$5,361	\$5,656	\$6,165	\$6,968
	19½	104	5	127	18	40C20104TWBSSS	\$5,327	\$6,020	\$7,032	\$7,990
	19½	103	5	126	18	40C20103TWBSSS	\$5,260	\$5,944	\$6,943	\$7,889
	19½	102	5	125	18	40C20102TWBSSS	\$5,191	\$5,477	\$5,969	\$6,748
	19½	101	5	124	18	40C20101TWBSSS	\$5,175	\$5,848	\$6,831	\$7,762
	19½	100	5	123	18	40C20100TWBSSS	\$5,160	\$5,831	\$6,812	\$7,739
	19½	99	5	122	17	40C2099TWBSSS	\$5,145	\$5,429	\$5,917	\$6,688
	19½	98	5	121	17	40C2098TWBSSS	\$5,130	\$5,797	\$6,772	\$7,695
	19½	97	5	120	17	40C2097TWBSSS	\$5,114	\$5,780	\$6,752	\$7,672
	19½	96	5	119	17	40C2096TWBSSS	\$5,100	\$5,380	\$5,864	\$6,630
	19½	95	5	118	17	40C2095TWBSSS	\$5,067	\$5,725	\$6,688	\$7,600
	19½	94	5	117	17	40C2094TWBSSS	\$5,033	\$5,688	\$6,645	\$7,549
	19½	93	5	116	16	40C2093TWBSSS	\$5,000	\$5,275	\$5,751	\$6,501
	19½	92	5	115	16	40C2092TWBSSS	\$4,967	\$5,613	\$6,556	\$7,450
	19½	91	5	114	16	40C2091TWBSSS	\$4,934	\$5,576	\$6,513	\$7,401
19½	90	5	113	16	40C2090TWBSSS	\$4,900	\$5,171	\$5,637	\$6,371	
19½	89	5	112	16	40C2089TWBSSS	\$4,867	\$5,501	\$6,425	\$7,301	
19½	88	5	111	16	40C2088TWBSSS	\$4,834	\$5,463	\$6,381	\$7,251	
19½	87	5	110	15	40C2087TWBSSS	\$4,801	\$5,066	\$5,522	\$6,242	
19½	86	5	109	15	40C2086TWBSSS	\$4,767	\$5,388	\$6,293	\$7,151	
19½	85	5	108	15	40C2085TWBSSS	\$4,734	\$5,350	\$6,251	\$7,102	

- 3mm radius front edge, sides and back are flat
- Integral Sink is always Designer White

Specify: Model | Worksurface Solid Surface | Sink Location

Model	Worksurface Solid Surface	Sink Location
	see Forge Solid Surface Finishes	Sink location is available in 1" increments from left side of worksurface to centerline of sink with minimum of 12" to centerline from either edge of surface. Sink should always be centered over sink cabinet

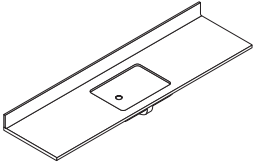
Description	D	W	H	CTN WT	CU FT	① Model	Tier 1	Tier 2	Tier 3	Tier 4
19½" d Solid Surface Worksurfaces with Integral Backsplash & Sink (continued) 	19½	84	5	107	15	40C2084TWBSSS	\$4,701	\$4,961	\$5,407	\$6,113
	19½	83	5	106	15	40C2083TWBSSS	\$4,674	\$5,282	\$6,169	\$7,010
	19½	82	5	105	15	40C2082TWBSSS	\$4,646	\$5,249	\$6,132	\$6,968
	19½	81	5	104	14	40C2081TWBSSS	\$4,618	\$4,872	\$5,311	\$6,003
	19½	80	5	103	14	40C2080TWBSSS	\$4,590	\$5,187	\$6,059	\$6,885
	19½	79	5	102	14	40C2079TWBSSS	\$4,562	\$5,156	\$6,022	\$6,843
	19½	78	5	101	14	40C2078TWBSSS	\$4,535	\$4,784	\$5,214	\$5,895
	19½	77	5	100	14	40C2077TWBSSS	\$4,484	\$5,068	\$5,919	\$6,726
	19½	76	5	99	14	40C2076TWBSSS	\$4,434	\$5,010	\$5,853	\$6,650
	19½	75	5	98	13	40C2075TWBSSS	\$4,407	\$4,650	\$5,068	\$5,728
	19½	74	5	97	13	40C2074TWBSSS	\$4,381	\$4,951	\$5,783	\$6,572
	19½	73	5	96	13	40C2073TWBSSS	\$4,355	\$4,922	\$5,749	\$6,533
	19½	72	5	95	13	40C2072TWBSSS	\$4,330	\$4,569	\$4,980	\$5,629
	19½	71	5	94	13	40C2071TWBSSS	\$4,301	\$4,860	\$5,677	\$6,450
	19½	70	5	93	13	40C2070TWBSSS	\$4,271	\$4,827	\$5,638	\$6,406
	19½	69	5	92	12	40C2069TWBSSS	\$4,242	\$4,476	\$4,879	\$5,514
	19½	68	5	91	12	40C2068TWBSSS	\$4,212	\$4,760	\$5,559	\$6,317
	19½	67	5	90	12	40C2067TWBSSS	\$4,182	\$4,726	\$5,520	\$6,273
	19½	66	5	89	12	40C2066TWBSSS	\$4,153	\$4,382	\$4,777	\$5,399
	19½	65	5	88	12	40C2065TWBSSS	\$4,123	\$4,659	\$5,443	\$6,184
	19½	64	5	87	12	40C2064TWBSSS	\$4,093	\$4,625	\$5,403	\$6,139
	19½	63	5	86	11	40C2063TWBSSS	\$4,074	\$4,299	\$4,685	\$5,296
	19½	62	5	85	11	40C2062TWBSSS	\$4,054	\$4,580	\$5,350	\$6,080
	19½	61	5	84	11	40C2061TWBSSS	\$4,033	\$4,558	\$5,324	\$6,049
	19½	60	5	83	11	40C2060TWBSSS	\$4,012	\$4,234	\$4,615	\$5,216
	19½	59	5	82	11	40C2059TWBSSS	\$3,996	\$4,515	\$5,274	\$5,993
	19½	58	5	81	11	40C2058TWBSSS	\$3,978	\$4,495	\$5,252	\$5,967
	19½	57	5	80	10	40C2057TWBSSS	\$3,961	\$4,180	\$4,556	\$5,150
	19½	56	5	79	10	40C2056TWBSSS	\$3,945	\$4,458	\$5,208	\$5,917
	19½	55	5	78	10	40C2055TWBSSS	\$3,928	\$4,439	\$5,186	\$5,891
19½	54	5	77	10	40C2054TWBSSS	\$3,910	\$4,127	\$4,497	\$5,084	
19½	53	5	76	10	40C2053TWBSSS	\$3,893	\$4,400	\$5,138	\$5,839	
19½	52	5	75	10	40C2052TWBSSS	\$3,875	\$4,380	\$5,115	\$5,814	
19½	51	5	74	9	40C2051TWBSSS	\$3,859	\$4,071	\$4,438	\$5,017	
19½	50	5	72	9	40C2050TWBSSS	\$3,841	\$4,342	\$5,071	\$5,762	
19½	49	5	71	9	40C2049TWBSSS	\$3,810	\$4,306	\$5,029	\$5,715	

- 3mm radius front edge, sides and back are flat
- Integral Sink is always Designer White

Specify: Model | Worksurface Solid Surface | Sink Location

Model	Worksurface Solid Surface	Sink Location
	see Forge Solid Surface Finishes	<p>Sink location is available in 1" increments from left side of worksurface to centerline of sink with minimum of 12" to centerline from either edge of surface.</p> <p>Sink should always be centered over sink cabinet</p>

Description	D	W	H	CTN WT	CU FT	① Model	Tier 1	Tier 2	Tier 3	Tier 4
19½" d Solid Surface Worksurfaces with Integral Backsplash & Sink (continued)	19½	48	5	70	9	40C2048TWBSSS	\$3,779	\$3,986	\$4,345	\$4,912
	19½	47	5	69	9	40C2047TWBSSS	\$3,712	\$4,195	\$4,899	\$5,567
	19½	46	5	68	9	40C2046TWBSSS	\$3,646	\$4,119	\$4,812	\$5,468
	19½	45	5	67	8	40C2045TWBSSS	\$3,579	\$3,775	\$4,115	\$4,652
	19½	44	5	66	8	40C2044TWBSSS	\$3,514	\$3,971	\$4,639	\$5,270
	19½	43	5	65	8	40C2043TWBSSS	\$3,447	\$3,896	\$4,550	\$5,171
	19½	42	5	64	8	40C2042TWBSSS	\$3,381	\$3,567	\$3,889	\$4,396
	19½	41	5	63	8	40C2041TWBSSS	\$3,364	\$3,802	\$4,441	\$5,046
	19½	40	5	62	8	40C2040TWBSSS	\$3,352	\$3,788	\$4,424	\$5,027
	19½	39	5	61	7	40C2039TWBSSS	\$3,339	\$3,523	\$3,840	\$4,341
	19½	38	5	60	7	40C2038TWBSSS	\$3,326	\$3,759	\$4,390	\$4,989
	19½	37	5	59	7	40C2037TWBSSS	\$3,313	\$3,744	\$4,374	\$4,969
	19½	36	5	58	7	40C2036TWBSSS	\$3,301	\$3,482	\$3,795	\$4,290
	19½	35	5	57	7	40C2035TWBSSS	\$3,279	\$3,705	\$4,329	\$4,918
	19½	34	5	56	7	40C2034TWBSSS	\$3,257	\$3,682	\$4,300	\$4,886
	19½	33	5	55	6	40C2033TWBSSS	\$3,236	\$3,415	\$3,721	\$4,207
	19½	32	5	54	6	40C2032TWBSSS	\$3,214	\$3,632	\$4,243	\$4,821
	19½	31	5	53	6	40C2031TWBSSS	\$3,171	\$3,583	\$4,185	\$4,756
	19½	30	5	52	6	40C2030TWBSSS	\$3,127	\$3,300	\$3,596	\$4,065
	19½	29	5	51	6	40C2029TWBSSS	\$3,119	\$3,525	\$4,117	\$4,679
19½	28	5	50	6	40C2028TWBSSS	\$3,113	\$3,518	\$4,109	\$4,669	
19½	27	5	49	5	40C2027TWBSSS	\$3,106	\$3,278	\$3,573	\$4,038	
19½	26	5	48	5	40C2026TWBSSS	\$3,100	\$3,504	\$4,092	\$4,650	
19½	25	5	47	5	40C2025TWBSSS	\$3,093	\$3,495	\$4,082	\$4,639	
19½	24	5	46	5	40C2024TWBSSS	\$3,086	\$3,256	\$3,549	\$4,011	

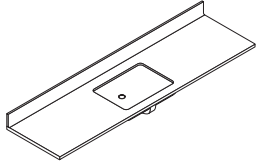

- 3mm radius front edge, sides and back are flat
- Integral Sink is always Designer White

Specify: Model | Worksurface Solid Surface | Sink Location

Model	Worksurface Solid Surface	Sink Location
	see Forge Solid Surface Finishes	<p>Sink location is available in 1" increments from left side of worksurface to centerline of sink with minimum of 12" to centerline from either edge of surface.</p> <p>Sink should always be centered over sink cabinet</p>

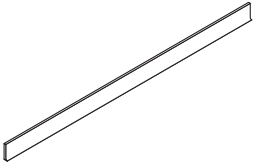
Description	D	W	H	CTN WT	CU FT	① Model	Tier 1	Tier 2	Tier 3	Tier 4
 <p>Solid Surface Backsplash</p>	½	120	4	16	2	40C1120BS	\$899	\$998	\$1,167	\$1,437
	½	119	4	16	2	40C1119BS	\$830	\$921	\$1,079	\$1,327
	½	118	4	16	2	40C1118BS	\$827	\$918	\$1,075	\$1,323
	½	117	4	16	2	40C1117BS	\$823	\$914	\$1,070	\$1,318
	½	116	4	15	2	40C1116BS	\$820	\$910	\$1,067	\$1,312
	½	115	4	15	2	40C1115BS	\$817	\$907	\$1,062	\$1,307
	½	114	4	15	2	40C1114BS	\$814	\$903	\$1,058	\$1,301
	½	113	4	15	1	40C1113BS	\$811	\$900	\$1,054	\$1,297
	½	112	4	15	1	40C1112BS	\$808	\$897	\$1,050	\$1,292
	½	111	4	15	1	40C1111BS	\$804	\$894	\$1,045	\$1,286
	½	110	4	15	1	40C1110BS	\$801	\$889	\$1,041	\$1,281
	½	109	4	15	1	40C1109BS	\$798	\$886	\$1,037	\$1,276
	½	108	4	14	1	40C1108BS	\$795	\$882	\$1,033	\$1,272
	½	107	4	14	1	40C1107BS	\$792	\$878	\$1,028	\$1,266
	½	106	4	14	1	40C1106BS	\$789	\$876	\$1,026	\$1,263
	½	105	4	14	1	40C1105BS	\$786	\$873	\$1,022	\$1,257
	½	104	4	14	1	40C1104BS	\$784	\$870	\$1,018	\$1,254
	½	103	4	14	1	40C1103BS	\$781	\$867	\$1,014	\$1,249
	½	102	4	14	1	40C1102BS	\$777	\$864	\$1,011	\$1,244
	½	101	4	14	1	40C1101BS	\$762	\$845	\$989	\$1,218
	½	100	4	13	1	40C1100BS	\$757	\$840	\$983	\$1,210
	½	99	4	13	1	40C199BS	\$750	\$834	\$976	\$1,200
	½	98	4	13	1	40C198BS	\$746	\$829	\$971	\$1,194
	½	97	4	13	1	40C197BS	\$741	\$822	\$963	\$1,186
	½	96	4	13	1	40C196BS	\$737	\$818	\$957	\$1,178
	½	95	4	13	1	40C195BS	\$654	\$726	\$849	\$1,044
	½	94	4	13	1	40C194BS	\$650	\$721	\$845	\$1,040
	½	93	4	12	1	40C193BS	\$647	\$717	\$841	\$1,035
	½	92	4	12	1	40C192BS	\$643	\$714	\$837	\$1,029
	½	91	4	12	1	40C191BS	\$640	\$711	\$833	\$1,024
½	90	4	12	1	40C190BS	\$637	\$707	\$828	\$1,018	
½	89	4	12	1	40C189BS	\$634	\$704	\$823	\$1,014	
½	88	4	12	1	40C188BS	\$631	\$701	\$819	\$1,009	
½	87	4	12	1	40C187BS	\$628	\$696	\$816	\$1,004	
½	86	4	12	1	40C186BS	\$625	\$693	\$812	\$999	
½	85	4	11	1	40C185BS	\$622	\$690	\$808	\$993	

Specify: Model | Worksurface Solid Surface

Model	Worksurface Solid Surface
	see Forge Solid Surface Finishes

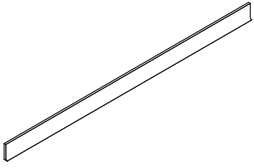
Description	D	W	H	CTN WT	CU FT	① Model	Tier 1	Tier 2	Tier 3	Tier 4
Solid Surface Backsplash (continued) 	1/2	84	4	11	1	40C184BS	\$616	\$684	\$802	\$986
	1/2	83	4	11	1	40C183BS	\$613	\$681	\$798	\$981
	1/2	82	4	11	1	40C182BS	\$610	\$678	\$794	\$976
	1/2	81	4	11	1	40C181BS	\$606	\$673	\$788	\$970
	1/2	80	4	11	1	40C180BS	\$603	\$669	\$784	\$964
	1/2	79	4	11	1	40C179BS	\$600	\$665	\$780	\$958
	1/2	78	4	11	1	40C178BS	\$596	\$661	\$774	\$952
	1/2	77	4	10	1	40C177BS	\$593	\$658	\$770	\$947
	1/2	76	4	10	1	40C176BS	\$589	\$654	\$766	\$942
	1/2	75	4	10	1	40C175BS	\$585	\$649	\$761	\$935
	1/2	74	4	10	1	40C174BS	\$581	\$646	\$757	\$930
	1/2	73	4	10	1	40C173BS	\$578	\$641	\$752	\$924
	1/2	72	4	10	1	40C172BS	\$575	\$638	\$747	\$920
	1/2	71	4	10	1	40C171BS	\$499	\$554	\$649	\$798
	1/2	70	4	9	1	40C170BS	\$496	\$551	\$645	\$793
	1/2	69	4	9	1	40C169BS	\$494	\$548	\$641	\$789
	1/2	68	4	9	1	40C168BS	\$491	\$544	\$637	\$784
	1/2	67	4	9	1	40C167BS	\$488	\$541	\$633	\$779
	1/2	66	4	9	1	40C166BS	\$486	\$539	\$631	\$775
	1/2	65	4	9	1	40C165BS	\$482	\$534	\$627	\$770
	1/2	64	4	9	1	40C164BS	\$479	\$532	\$624	\$767
	1/2	63	4	9	1	40C163BS	\$477	\$530	\$622	\$764
	1/2	62	4	8	1	40C162BS	\$474	\$527	\$616	\$759
	1/2	61	4	8	1	40C161BS	\$472	\$524	\$613	\$755
	1/2	60	4	8	1	40C160BS	\$470	\$522	\$610	\$752
	1/2	59	4	8	1	40C159BS	\$467	\$519	\$607	\$746
	1/2	58	4	8	1	40C158BS	\$465	\$517	\$604	\$743
	1/2	57	4	8	1	40C157BS	\$462	\$512	\$600	\$738
	1/2	56	4	8	1	40C156BS	\$460	\$509	\$597	\$735
	1/2	55	4	8	1	40C155BS	\$456	\$506	\$594	\$730
1/2	54	4	7	1	40C154BS	\$454	\$504	\$590	\$727	
1/2	53	4	7	1	40C153BS	\$374	\$416	\$488	\$599	
1/2	52	4	7	1	40C152BS	\$372	\$414	\$485	\$596	
1/2	51	4	7	1	40C151BS	\$370	\$411	\$482	\$593	
1/2	50	4	7	1	40C150BS	\$367	\$408	\$477	\$587	
1/2	49	4	7	1	40C149BS	\$365	\$405	\$474	\$583	

Specify: Model | Worksurface Solid Surface

Model	Worksurface Solid Surface
	see Forge Solid Surface Finishes

Description	D	W	H	CTN WT	CU FT	① Model	Tier 1	Tier 2	Tier 3	Tier 4
Solid Surface Backsplash (continued)	1/2	48	4	7	1	40C148BS	\$363	\$402	\$471	\$580
	1/2	47	4	7	1	40C147BS	\$360	\$399	\$468	\$575
	1/2	46	4	6	1	40C146BS	\$358	\$397	\$465	\$572
	1/2	45	4	6	1	40C145BS	\$356	\$394	\$462	\$569
	1/2	44	4	6	1	40C144BS	\$353	\$391	\$458	\$563
	1/2	43	4	6	1	40C143BS	\$351	\$389	\$455	\$560
	1/2	42	4	6	1	40C142BS	\$348	\$387	\$452	\$556
	1/2	41	4	6	1	40C141BS	\$345	\$383	\$448	\$552
	1/2	40	4	6	1	40C140BS	\$342	\$381	\$445	\$547
	1/2	39	4	5	1	40C139BS	\$340	\$379	\$442	\$544
	1/2	38	4	5	1	40C138BS	\$337	\$374	\$438	\$539
	1/2	37	4	5	1	40C137BS	\$335	\$371	\$436	\$535
	1/2	36	4	5	1	40C136BS	\$333	\$369	\$433	\$532
	1/2	35	4	5	1	40C135BS	\$326	\$361	\$423	\$521
	1/2	34	4	5	1	40C134BS	\$319	\$355	\$415	\$509
	1/2	33	4	5	1	40C133BS	\$313	\$347	\$406	\$500
	1/2	32	4	5	1	40C132BS	\$306	\$339	\$398	\$490
	1/2	31	4	4	1	40C131BS	\$301	\$334	\$391	\$480
	1/2	30	4	4	1	40C130BS	\$295	\$328	\$385	\$472
	1/2	29	4	4	1	40C129BS	\$233	\$259	\$303	\$372
	1/2	28	4	4	1	40C128BS	\$231	\$257	\$301	\$369
	1/2	27	4	4	1	40C127BS	\$230	\$256	\$299	\$367
	1/2	26	4	4	1	40C126BS	\$228	\$253	\$297	\$364
	1/2	25	4	4	1	40C125BS	\$227	\$252	\$294	\$363
	1/2	24	4	4	1	40C124BS	\$225	\$250	\$292	\$359
	1/2	23	4	3	1	40C123BS	\$224	\$249	\$290	\$358
	1/2	22	4	3	1	40C122BS	\$222	\$247	\$288	\$355
	1/2	21	4	3	1	40C121BS	\$221	\$246	\$287	\$353
	1/2	20	4	3	1	40C120BS	\$219	\$242	\$284	\$349
	1/2	19	4	3	1	40C119BS	\$218	\$240	\$283	\$347
	1/2	18	4	3	1	40C118BS	\$215	\$238	\$280	\$343
	1/2	17	4	3	1	40C117BS	\$190	\$210	\$247	\$303
	1/2	16	4	2	1	40C116BS	\$186	\$206	\$242	\$298
1/2	15	4	2	1	40C115BS	\$182	\$202	\$236	\$290	
1/2	14	4	2	1	40C114BS	\$179	\$198	\$232	\$286	
1/2	13	4	2	1	40C113BS	\$176	\$195	\$228	\$281	
1/2	12	4	2	1	40C112BS	\$173	\$192	\$224	\$276	

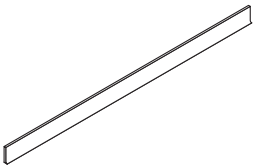

Specify: Model | Worksurface Solid Surface

Model	Worksurface Solid Surface
	see Forge Solid Surface Finishes

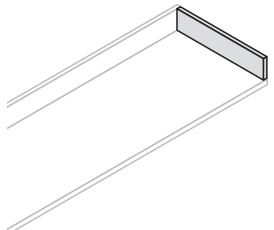
Description	D	W	H	CTN WT	CU FT	① Model	Tier 1	Tier 2	Tier 3	Tier 4	
Solid Surface Side Splash 	Right										
	1/2	23 3/8	4	3	1	40C123RSSS	\$255	\$283	\$331	\$407	
	1/2	18 3/8	4	3	1	40C118RSSS	\$215	\$238	\$280	\$343	
	Left										
	1/2	23 3/8	4	3	1	40C123LSSS	\$255	\$283	\$331	\$407	
	1/2	18 3/8	4	3	1	40C118LSSS	\$215	\$238	\$280	\$343	
<ul style="list-style-type: none"> • handed <p>Specify: Model Worksurface Solid Surface Side Splash</p>											

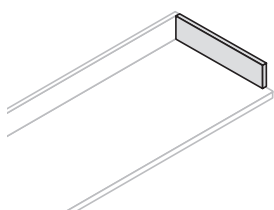
Solid Surface Side Splash Flush with Storage Cabinets 	Right										
	1/2	22 1/2	4	3	1	40C123RSSFS	\$255	\$283	\$331	\$407	
	1/2	17 1/2	4	3	1	40C118RSSFS	\$215	\$238	\$280	\$343	
	Left										
	1/2	22 1/2	4	3	1	40C123LSSFS	\$255	\$283	\$331	\$407	
	1/2	17 1/2	4	3	1	40C118LSSFS	\$215	\$238	\$280	\$343	
<ul style="list-style-type: none"> • handed • aligns flush with storage cabinet chassis <p>Specify: Model Worksurface Solid Surface Side Splash</p>											

Model	Worksurface Solid Surface	Side Splash
	see Forge Solid Surface Finishes	CIBS Compatible with Integrated Backsplash CSBS Compatible with Straight Backsplash

Description	D	W	H	CTN WT	CU FT	① Model	List
Worksurface Waste Ring	6 3/4	6 3/4	2	1	1	GPWSWR	\$396



- use with laminate and solid surface tops
- field cut and installed
- stainless steel finish

Specify: Model

Worksurface Bracket	15	1 3/4	18	3	1	GPWSBRKT18W (White)	\$497
	15	1 3/4	18	3	1	GPWSBRKT18B (Black)	\$497

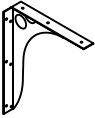

- used with 19 1/2" or 24 1/2" d surfaces
- includes hardware to attach to worksurface
- hardware to attach to wall is not included

Specify: Model

L-Bracket	1	21	1	4	1	GPLBRKT24	\$105
	1	17	1	3	1	GPLBRKT20	\$99

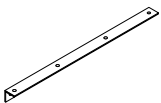

- GPLBRKT24 should be used with 24 1/2" d worksurface
- GPLBRKT20 should be used with 19 1/2" d worksurface
- attaches to the wall or storage cabinet
- one GPLBRKT20 is required with corner worksurface
- silver finish

Specify: Model

Edge Support	1 1/16	2	1 1/16	1	1	GPLBRKT04	\$14
---------------------	--------	---	--------	---	---	-----------	------



- two brackets may be used in place of L-bracket to attach worksurface to storage cabinet
- two brackets are required with base end panel
- one bracket may be used to anchor end panel to the wall
- black finish

Specify: Model

Flat Bracket	2	6		1	1	GPFBRKT	\$19
---------------------	---	---	--	---	---	---------	------



- required for use with corner worksurface
- two brackets are required at each seam
- black finish

Specify: Model

Support Rail	2	43	3/4	3	1	GP0243SB	\$90
	2	37	3/4	3	1	GP0237SB	\$83



- GP0243SB used where unsupported width span is 43" to 50"
- GP0237SB used for unsupported width span of 37" to 43"
- black finish

Specify: Model

Support Bracket for End Panel	9 5/16	1	9 5/16	2	1	GPEPSB	\$103
--------------------------------------	--------	---	--------	---	---	--------	-------

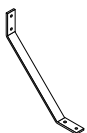

- used to support base end panels that are not attached to the wall
- black finish

Specify: Model

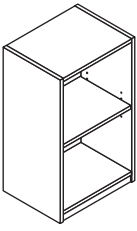
Description	D	W	H	CTN WT	CU FT	① Model	List
Open Upper Cabinet 	13 3/4	36	30	69	12	40C143630UCT	\$842
	13 3/4	30	30	61	10	40C143030UCT	\$760
	13 3/4	24	30	52	8	40C142430UCT	\$678
	13 3/4	21	30	47	7	40C142130UCT	\$597
	13 3/4	18	30	43	6	40C141830UCT	\$515
	13 3/4	15	30	38	5	40C141530UCT	\$451
	13 3/4	12	30	34	5	40C141230UCT	\$392
	13 3/4	36	24	61	9	40C143624UCT	\$774
	13 3/4	30	24	53	8	40C143024UCT	\$703
	13 3/4	24	24	45	7	40C142424UCT	\$638
	13 3/4	21	24	41	6	40C142124UCT	\$574
	13 3/4	18	24	37	5	40C141824UCT	\$509
	13 3/4	15	24	33	4	40C141524UCT	\$445
	13 3/4	12	24	29	4	40C141224UCT	\$382

• one adjustable shelf

Specify: Model | Chassis Laminate

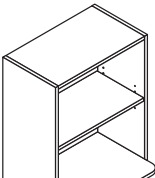
Open Upper Microwave Shelf Cabinet 	17 3/4	36	30	72	12	40C143630UCMT	\$911
	17 3/4	30	30	63	10	40C143030UCMT	\$852
	17 3/4	24	30	54	8	40C142430UCMT	\$794
	17 3/4	36	24	64	9	40C143624UCMT	\$844
	17 3/4	30	24	56	8	40C143024UCMT	\$772
	17 3/4	24	24	47	7	40C142424UCMT	\$708

• one adjustable shelf

Specify: Model | Chassis Laminate

Model	Chassis Laminate
	see Forge Laminate Finishes

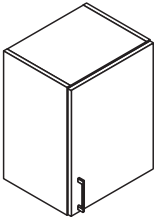
Description	D	W	H	CTN WT	CU FT	Model	List
 <p>right shown</p>	30" h Right Hinged						
	14 ½	24	30	67	8	40C152430UCDRT	\$1,084
	14 ½	21	30	61	7	40C152130UCDRT	\$1,006
	14 ½	18	30	54	7	40C151830UCDRT	\$927
	14 ½	15	30	48	6	40C151530UCDRT	\$850
	14 ½	12	30	41	5	40C151230UCDRT	\$772
	30" h Left Hinged						
	14 ½	24	30	67	8	40C152430UCDLT	\$1,084
	14 ½	21	30	61	7	40C152130UCDLT	\$1,006
	14 ½	18	30	54	7	40C151830UCDLT	\$927
	14 ½	15	30	48	6	40C151530UCDLT	\$850
	14 ½	12	30	41	5	40C151230UCDLT	\$772
	24" h Right Hinged						
	14 ½	24	24	57	7	40C152424UCDRT	\$1,013
	14 ½	21	24	52	6	40C152124UCDRT	\$938
	14 ½	18	24	46	5	40C151824UCDRT	\$864
	14 ½	15	24	40	5	40C151524UCDRT	\$788
	14 ½	12	24	35	4	40C151224UCDRT	\$713
	24" h Left Hinged						
	14 ½	24	24	57	7	40C152424UCDLT	\$1,013
14 ½	21	24	52	6	40C152124UCDLT	\$938	
14 ½	18	24	46	5	40C151824UCDLT	\$864	
14 ½	15	24	40	5	40C151524UCDLT	\$788	
14 ½	12	24	35	4	40C151224UCDLT	\$713	

• one adjustable shelf

Specify: Model | Chassis Laminate | Door Laminate | Pull | Lock

Model	Chassis Laminate	Door Laminate	Pull	Lock
	see Forge Laminate Finishes	see Forge Laminate Finishes	P001 Bar see Bar Pull Color P005 Delve see Delve Pull Color P011 Prospect see Prospect Pull Color P003 Sweep see Sweep Pull Color	NLK No Lock KLK Standard - add \$85 ASL Arctic Silver MBK Matte Black DLK Keyless Lock - add \$250

Description	D	W	H	CTN WT	CU FT	① Model	List
Upper Door Cabinet with Glove Box	14 ½	24	30	67	8	40C152430UCDGBT	\$1,185
	14 ½	21	30	61	7	40C152130UCDGBT	\$1,147
	14 ½	18	30	54	7	40C151830UCDGBT	\$1,110
	14 ½	24	24	57	7	40C152424UCDGBT	\$1,072
	14 ½	21	24	52	6	40C152124UCDGBT	\$1,035
	14 ½	18	24	46	5	40C151824UCDGBT	\$998

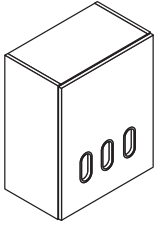

- one fixed shelf
- metal glove box holder is included
- zinc oval glove grommet size 6 ½" x 3" x 13/16"
- 24" & 21"w units have 3 glove box openings
- 18"w units have 2 glove box openings

Specify: Model | Chassis Laminate | Door Laminate | Lock | Waste Grommet Color

Model	Chassis Laminate	Door Laminate	Lock	Waste Grommet Color
	see Forge Laminate Finishes	see Forge Laminate Finishes	NLK No Lock KLK Standard - add \$85 ASL Arctic Silver MBK Matte Black	MBK Matte Black SNK Soft Nickel

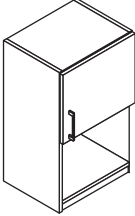
Description	D	W	H	CTN WT	CU FT	Model	List
Upper Door with Open Shelf Cabinet  right shown	Right Hinged						
	14 ½	24	30	59	8	40C152430UCHDRT	\$917
	14 ½	21	30	54	7	40C152130UCHDRT	\$847
	14 ½	18	30	48	7	40C151830UCHDRT	\$777
	14 ½	15	30	43	6	40C151530UCHDRT	\$708
	14 ½	12	30	37	5	40C151230UCHDRT	\$638
	Left Hinged						
	14 ½	24	30	59	8	40C152430UCHDLT	\$917
	14 ½	21	30	54	7	40C152130UCHDLT	\$847
	14 ½	18	30	48	7	40C151830UCHDLT	\$777
	14 ½	15	30	43	6	40C151530UCHDLT	\$708
14 ½	12	30	37	5	40C151230UCHDLT	\$638	

• one adjustable shelf

Specify: Model | Chassis Laminate | Door Laminate | Pull | Lock

Model	Chassis Laminate	Door Laminate	Pull	Lock
	see Forge Laminate Finishes	see Forge Laminate Finishes	P001 Bar see Bar Pull Color P005 Delve see Delve Pull Color P011 Prospect see Prospect Pull Color P003 Sweep see Sweep Pull Color	NLK No Lock KLK Standard - add \$85 ASL Arctic Silver MBK Matte Black DLK Keyless Lock - add \$250

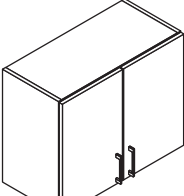
Description	D	W	H	CTN WT	CU FT	① Model	List
	14 ½	36	30	92	12	40C153630UCDT	\$1,372
	14 ½	30	30	80	10	40C153030UCDT	\$1,265
	14 ½	24	30	67	8	40C152430UCDT	\$1,158
	14 ½	36	24	80	10	40C153624UCDT	\$1,259
	14 ½	30	24	69	8	40C153024UCDT	\$1,152
	14 ½	24	24	57	7	40C152424UCDT	\$1,045

• one adjustable shelf

Specify: Model | Chassis Laminate | Door Laminate | Pull | Lock

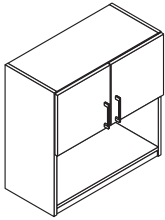
	14 ½	36	30	81	12	40C153630UCHDT	\$1,147
	14 ½	30	30	70	10	40C153030UCHDT	\$1,051
	14 ½	24	30	59	8	40C152430UCHDT	\$954

• one adjustable shelf

Specify: Model | Chassis Laminate | Door Laminate | Pull | Lock

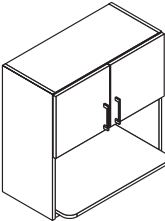
	17 ¾	36	30	84	12	40C153630UCHDMT	\$1,223
	17 ¾	30	30	72	10	40C153030UCHDMT	\$1,137
	17 ¾	24	30	61	8	40C152430UCHDMT	\$1,051

Specify: Model | Chassis Laminate | Door Laminate | Pull | Lock

Model	Chassis Laminate	Door Laminate	Pull	Lock
	see Forge Laminate Finishes	see Forge Laminate Finishes	P001 Bar see Bar Pull Color P005 Delve see Delve Pull Color P011 Prospect see Prospect Pull Color P003 Sweep see Sweep Pull Color	NLK No Lock KLK Standard - add \$85 ASL Arctic Silver MBK Matte Black DLK Keyless Lock - add \$276

Description	D	W	H	CTN WT	CU FT	① Model	List
Upper Filler	13 ¾	6	30	4	3	40C14630UFT	\$205
	13 ¾	6	24	4	2	40C14624UFT	\$156

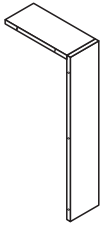

- includes brackets to attach to cabinet
- may be field scribed as needed

Specify: Model | Chassis Laminate

Model	Chassis Laminate
	see Forge Laminate Finishes

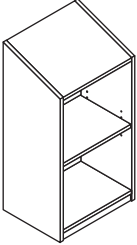
Description	D	W	H	CTN WT	CU FT	① Model	List
Sloped Top Open Upper Cabinet 	13 ¾	36	35	72	13	40C143635UCST	\$927
	13 ¾	30	35	63	11	40C143035UCST	\$849
	13 ¾	24	35	53	9	40C142435UCST	\$774
	13 ¾	21	35	49	8	40C142135UCST	\$700
	13 ¾	18	35	44	7	40C141835UCST	\$625
	13 ¾	15	35	40	6	40C141535UCST	\$549
	13 ¾	12	35	35	5	40C141235UCST	\$474
	13 ¾	36	29	64	11	40C143629UCST	\$852
	13 ¾	30	29	55	9	40C143029UCST	\$774
	13 ¾	24	29	47	8	40C142429UCST	\$696
	13 ¾	21	29	43	7	40C142129UCST	\$618
	13 ¾	18	29	39	6	40C141829UCST	\$540
	13 ¾	15	29	35	5	40C141529UCST	\$462
	13 ¾	12	29	30	4	40C141229UCST	\$397

• one adjustable shelf

Specify: Model | Chassis Laminate

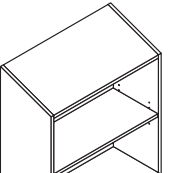
Sloped Top Open Upper Microwave Shelf Cabinet 	17 ¾	36	35	13	75	40C143635UCSMT	\$1,159
	17 ¾	30	35	11	65	40C143035UCSMT	\$1,081
	17 ¾	24	35	9	55	40C142435UCSMT	\$1,006
	17 ¾	36	29	11	67	40C143629UCSMT	\$927
	17 ¾	30	29	9	58	40C143029UCSMT	\$849
	17 ¾	24	29	8	49	40C142429UCSMT	\$771

• one adjustable shelf

Specify: Model | Chassis Laminate

Model	Chassis Laminate
	see Forge Laminate Finishes

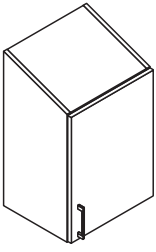
Description	D	W	H	CTN WT	CU FT	Model	List
 <p>right shown</p>	35" h Right Hinged						
	14 ½	24	35	69	10	40C152435UCDSRT	\$1,164
	14 ½	21	35	62	9	40C152135UCDSRT	\$1,086
	14 ½	18	35	56	8	40C151835UCDSRT	\$1,008
	14 ½	15	35	49	6	40C151535UCDSRT	\$930
	14 ½	12	35	43	5	40C151235UCDSRT	\$851
	35" h Left Hinged						
	14 ½	24	35	69	10	40C152435UCDSL	\$1,164
	14 ½	21	35	62	9	40C152135UCDSL	\$1,086
	14 ½	18	35	56	8	40C151835UCDSL	\$1,008
	14 ½	15	35	49	6	40C151535UCDSL	\$930
	14 ½	12	35	43	5	40C151235UCDSL	\$851
	29" h Right Hinged						
	14 ½	24	29	59	8	40C152429UCDSRT	\$1,087
	14 ½	21	29	54	7	40C152129UCDSRT	\$1,009
	14 ½	18	29	48	6	40C151829UCDSRT	\$931
	14 ½	15	29	42	5	40C151529UCDSRT	\$852
	14 ½	12	29	36	5	40C151229UCDSRT	\$774
	29" h Left Hinged						
	14 ½	24	29	59	8	40C152429UCDSL	\$1,087
14 ½	21	29	54	7	40C152129UCDSL	\$1,009	
14 ½	18	29	48	6	40C151829UCDSL	\$931	
14 ½	15	29	42	5	40C151529UCDSL	\$852	
14 ½	12	29	36	5	40C151229UCDSL	\$774	

• one adjustable shelf

Specify: Model | Chassis Laminate | Door Laminate | Pull | Lock

Model	Chassis Laminate	Door Laminate	Pull	Lock
	see Forge Laminate Finishes	see Forge Laminate Finishes	P001 Bar see Bar Pull Color P005 Delve see Delve Pull Color P011 Prospect see Prospect Pull Color P003 Sweep see Sweep Pull Color	NLK No Lock KLK Standard - add \$85 ASL Arctic Silver MBK Matte Black DLK Keyless Lock - add \$250

Description	D	W	H	CTN WT	CU FT	Model	List
Sloped Top Upper Door Cabinet with Glove Box	14 1/2	24	35	69	10	40C152435UCDGBST	\$1,329
	14 1/2	21	35	62	9	40C152135UCDGBST	\$1,270
	14 1/2	18	35	56	8	40C151835UCDGBST	\$1,212
	14 1/2	24	29	59	8	40C152429UCDGBST	\$1,185
	14 1/2	21	29	54	7	40C152129UCDGBST	\$1,147
	14 1/2	18	29	54	7	40C151829UCDGBST	\$1,110

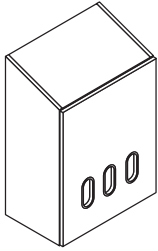

- one fixed shelf
- metal glove box holder is included
- zinc oval glove grommet size 6 1/2" x 3" x 13/16"
- 24" & 21"w units have 3 glove box openings
- 18"w units have 2 glove box openings

Specify: Model | Chassis Laminate | Door Laminate | Lock | Waste Grommet Color

Model	Chassis Laminate	Door Laminate	Lock	Waste Grommet Color
	see Forge Laminate Finishes	see Forge Laminate Finishes	NLK No Lock KLK Standard - add \$85 ASL Arctic Silver MBK Matte Black	MBK Matte Black SNK Soft Nickel

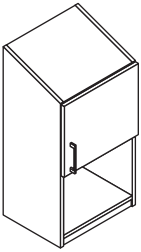
Description	D	W	H	CTN WT	CU FT	Model	List
 <p>right shown</p>	Right Hinged						
	14 ½	24	35	61	10	40C152435UCHDSRT	\$1,061
	14 ½	21	35	56	9	40C152135UCHDSRT	\$965
	14 ½	18	35	50	8	40C151835UCHDSRT	\$869
	14 ½	15	35	45	6	40C151535UCHDSRT	\$783
	14 ½	12	35	39	5	40C151235UCHDSRT	\$686
	Left Hinged						
	14 ½	24	35	61	10	40C152435UCHDSL	\$1,061
	14 ½	21	35	56	9	40C152135UCHDSL	\$965
	14 ½	18	35	50	8	40C151835UCHDSL	\$869
14 ½	15	35	45	6	40C151535UCHDSL	\$783	
14 ½	12	35	39	5	40C151235UCHDSL	\$686	

• one adjustable shelf

Specify: Model | Chassis Laminate | Door Laminate | Pull | Lock

Model	Chassis Laminate	Door Laminate	Pull	Lock
	see Forge Laminate Finishes	see Forge Laminate Finishes	P001 Bar see Bar Pull Color P005 Delve see Delve Pull Color P011 Prospect see Prospect Pull Color P003 Sweep see Sweep Pull Color	NLK No Lock KLK Standard - add \$85 ASL Arctic Silver MBK Matte Black DLK Keyless Lock - add \$250

Description	D	W	H	CTN WT	CU FT	① Model	List
Sloped Top Two Door Upper Cabinet	14 ½	36	35	95	14	40C153635UCDST	\$1,480
	14 ½	30	35	82	12	40C153035UCDST	\$1,372
	14 ½	24	35	69	10	40C152435UCDST	\$1,259
	14 ½	36	29	82	12	40C153629UCDST	\$1,366
	14 ½	30	29	71	10	40C153029UCDST	\$1,254
	14 ½	24	29	59	8	40C152429UCDST	\$1,142

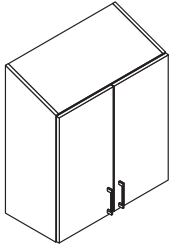

• one adjustable shelf

Specify: Model | Chassis Laminate | Door Laminate | Pull | Lock

Sloped Top Two Doors with Open Shelf Cabinet	14 ½	36	35	83	14	40C153635UCHDST	\$1,322
	14 ½	30	35	72	12	40C153035UCHDST	\$1,078
	14 ½	24	35	61	10	40C152435UCHDST	\$991

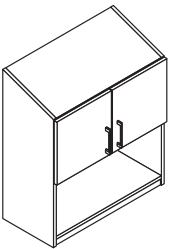

• one adjustable shelf

Specify: Model | Chassis Laminate | Door Laminate | Pull | Lock

Sloped Top Two Doors with Microwave Shelf Cabinet	18 ½	36	35	86	14	40C153635UCHDSMT	\$1,399
	18 ½	30	35	74	12	40C153035UCHDSMT	\$1,222
	18 ½	24	35	63	10	40C152435UCHDSMT	\$1,185

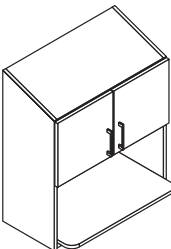

Specify: Model | Chassis Laminate | Door Laminate | Pull | Lock

Model	Chassis Laminate	Door Laminate	Pull	Lock
	see Forge Laminate Finishes	see Forge Laminate Finishes	P001 Bar see Bar Pull Color P005 Delve see Delve Pull Color P011 Prospect see Prospect Pull Color P003 Sweep see Sweep Pull Color	NLK No Lock KLK Standard - add \$85 ASL Arctic Silver MBK Matte Black DLK Keyless Lock - add \$276

Description	D	W	H	CTN WT	CU FT	Model	List
Sloped Top Upper Filler	13 3/4	6	35	6	3	40C14635UFST	\$218
	13 3/4	6	29	5	3	40C14629UFST	\$205

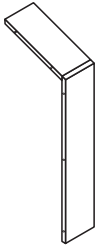

- includes brackets to attach to cabinet
- may be field scribed as needed

Specify: Model | Chassis Laminate

Model	Chassis Laminate
	see Forge Laminate Finishes

24"d Models

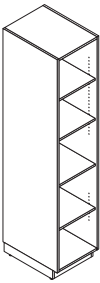
Description	D	W	H	CTN WT	CU FT	① Model	List
 <p>1 fixed & 3 adjustable shelves shown</p>	23 1/2	36	84	246	49	40C243684SCOT	\$2,673
	23 1/2	30	84	218	41	40C243084SCOT	\$2,518
	23 1/2	24	84	190	33	40C242484SCOT	\$2,357
	23 1/2	21	84	176	30	40C242184SCOT	\$2,196
	23 1/2	18	84	162	26	40C241884SCOT	\$2,031
	23 1/2	15	84	148	22	40C241584SCOT	\$1,870
	23 1/2	12	84	134	18	40C241284SCOT	\$1,709
	23 1/2	36	78	236	45	40C243678SCOT	\$2,368
	23 1/2	30	78	209	38	40C243078SCOT	\$2,245
	23 1/2	24	78	182	31	40C242478SCOT	\$2,122
	23 1/2	21	78	168	28	40C242178SCOT	\$1,997
	23 1/2	18	78	155	24	40C241878SCOT	\$1,873
	23 1/2	15	78	141	21	40C241578SCOT	\$1,750
	23 1/2	12	78	127	17	40C241278SCOT	\$1,627

Specify: Model | Chassis Laminate | Interior Configuration

19"d Models

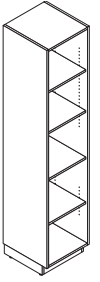
Description	D	W	H	CTN WT	CU FT	① Model	List
 <p>1 fixed & 3 adjustable shelves shown</p>	18 1/2	36	84	229	39	40C193684SCOT	\$2,420
	18 1/2	30	84	201	33	40C193084SCOT	\$2,261
	18 1/2	24	84	173	27	40C192484SCOT	\$2,106
	18 1/2	21	84	159	24	40C192184SCOT	\$1,950
	18 1/2	18	84	145	21	40C191884SCOT	\$1,795
	18 1/2	15	84	131	18	40C191584SCOT	\$1,634
	18 1/2	12	84	116	15	40C191284SCOT	\$1,473
	18 1/2	36	78	220	37	40C193678SCOT	\$2,111
	18 1/2	30	78	193	31	40C193078SCOT	\$1,988
	18 1/2	24	78	166	25	40C192478SCOT	\$1,865
	18 1/2	21	78	152	22	40C192178SCOT	\$1,816
	18 1/2	18	78	139	19	40C191878SCOT	\$1,694
	18 1/2	15	78	125	17	40C191578SCOT	\$1,570
	18 1/2	12	78	111	14	40C191278SCOT	\$1,447

Specify: Model | Chassis Laminate | Interior Configuration

Model	Chassis Laminate	Interior Configuration
	see Forge Laminate Finishes	CH Coat Hook CR2FS Coat Rod & 2 Fixed Shelves - add \$46 1F3AS 1 Fixed & 3 Adjustable Shelves - add \$161

24"d Models

Description	D	W	H	CTN WT	CU FT	① Model	List
 <p>right shown</p>	84" h Right Hinged						
	24 1/4	24	84	231	33	40C242484SCDRT	\$2,690
	24 1/4	21	84	212	30	40C242184SCDRT	\$2,534
	24 1/4	18	84	193	26	40C241884SCDRT	\$2,376
	24 1/4	15	84	174	22	40C241584SCDRT	\$2,154
	24 1/4	12	84	154	18	40C241284SCDRT	\$1,994
	84" h Left Hinged						
	24 1/4	24	84	231	33	40C242484SCDLT	\$2,690
	24 1/4	21	84	212	30	40C242184SCDLT	\$2,534
	24 1/4	18	84	193	26	40C241884SCDLT	\$2,376
	24 1/4	15	84	174	22	40C241584SCDLT	\$2,154
	24 1/4	12	84	154	18	40C241284SCDLT	\$1,994
	78" h Right Hinged						
	24 1/4	24	78	220	31	40C242478SCDRT	\$2,389
	24 1/4	21	78	202	28	40C242178SCDRT	\$2,287
	24 1/4	18	78	183	24	40C241878SCDRT	\$2,185
	24 1/4	15	78	165	21	40C241578SCDRT	\$2,062
	24 1/4	12	78	146	17	40C241278SCDRT	\$1,940
	78" h Left Hinged						
	24 1/4	24	78	220	31	40C242478SCDLT	\$2,389
24 1/4	21	78	202	28	40C242178SCDLT	\$2,287	
24 1/4	18	78	183	24	40C241878SCDLT	\$2,185	
24 1/4	15	78	165	21	40C241578SCDLT	\$2,062	
24 1/4	12	78	146	17	40C241278SCDLT	\$1,940	

Specify: Model | Chassis Laminate | Door Laminate | Interior Configuration | Pull | Lock

Model	Chassis Laminate	Door Laminate	Interior Configuration	Pull	Lock
	see Forge Laminate Finishes	see Forge Laminate Finishes	CH Coat Hook CR2FS Coat Rod & 2 Fixed Shelves - add \$46 1F3AS 1 Fixed & 3 Adjustable Shelves - add \$161	P001 Bar see Bar Pull Color P005 Delve see Delve Pull Color P011 Prospect see Prospect Pull Color P003 Sweep see Sweep Pull Color	NLK No Lock KLK Standard - add \$85 ASL Arctic Silver MBK Matte Black DLK Keyless Lock - add \$250

19"d Models

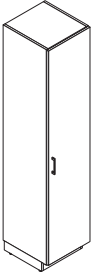
Description	D	W	H	CTN WT	CU FT	Model	List
 <p>right shown</p>	84"h Right Hinged						
	19 ¼	24	84	214	27	40C192484SCDRT	\$2,432
	19 ¼	21	84	195	24	40C192184SCDRT	\$2,203
	19 ¼	18	84	176	21	40C191884SCDRT	\$2,079
	19 ¼	15	84	156	18	40C191584SCDRT	\$1,935
	19 ¼	12	84	137	15	40C191284SCDRT	\$1,822
	84"h Left Hinged						
	19 ¼	24	84	214	27	40C192484SCDLT	\$2,432
	19 ¼	21	84	195	24	40C192184SCDLT	\$2,203
	19 ¼	18	84	176	21	40C191884SCDLT	\$2,079
	19 ¼	15	84	156	18	40C191584SCDLT	\$1,935
	19 ¼	12	84	137	15	40C191284SCDLT	\$1,822
	78"h Right Hinged						
	19 ¼	24	78	204	25	40C192478SCDRT	\$2,138
	19 ¼	21	78	186	22	40C192178SCDRT	\$2,015
	19 ¼	18	78	167	19	40C191878SCDRT	\$1,902
	19 ¼	15	78	149	17	40C191578SCDRT	\$1,816
	19 ¼	12	78	130	14	40C191278SCDRT	\$1,725
	78"h Left Hinged						
	19 ¼	24	78	204	25	40C192478SCDLT	\$2,138
19 ¼	21	78	186	22	40C192178SCDLT	\$2,015	
19 ¼	18	78	167	19	40C191878SCDLT	\$1,902	
19 ¼	15	78	149	17	40C191578SCDLT	\$1,816	
19 ¼	12	78	130	14	40C191278SCDLT	\$1,725	

Specify: Model | Chassis Laminate | Door Laminate | Interior Configuration | Pull | Lock

Model	Chassis Laminate	Door Laminate	Interior Configuration	Pull	Lock
	see Forge Laminate Finishes	see Forge Laminate Finishes	CH Coat Hook CR2FS Coat Rod & 2 Fixed Shelves - add \$46 1F3AS 1 Fixed & 3 Adjustable Shelves - add \$161	P001 Bar see Bar Pull Color P005 Delve see Delve Pull Color P011 Prospect see Prospect Pull Color P003 Sweep see Sweep Pull Color	NLK No Lock KLK Standard - add \$85 ASL Arctic Silver MBK Matte Black DLK Keyless Lock - add \$250

24" d Models

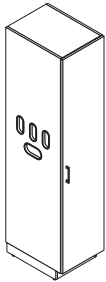
Description	D	W	H	CTN WT	CU FT	Model	List
Storage Cabinet with Glove Box  right shown	84" h Right Hinged						
	24 1/4	24	84	231	33	40C242484SCDGBRT	\$2,946
	24 1/4	21	84	212	30	40C242184SCDGBRT	\$2,792
	24 1/4	18	84	193	26	40C241884SCDGBRT	\$2,633
	24 1/4	15	84	174	22	40C241584SCDGBRT	\$2,478
	24 1/4	12	84	154	18	40C241284SCDGBRT	\$2,322
	84" h Left Hinged						
	24 1/4	24	84	231	33	40C242484SCDGBLT	\$2,946
	24 1/4	21	84	212	30	40C242184SCDGBLT	\$2,792
	24 1/4	18	84	193	26	40C241884SCDGBLT	\$2,633
24 1/4	15	84	174	22	40C241584SCDGBLT	\$2,478	
24 1/4	12	84	154	18	40C241284SCDGBLT	\$2,322	
78" h Right Hinged							
24 1/4	24	78	220	31	40C242478SCDGBRT	\$2,689	
24 1/4	21	78	202	28	40C242178SCDGBRT	\$2,565	
24 1/4	18	78	183	24	40C241878SCDGBRT	\$2,443	
24 1/4	15	78	165	21	40C241578SCDGBRT	\$2,319	
24 1/4	12	78	146	17	40C241278SCDGBRT	\$2,196	
78" h Left Hinged							
24 1/4	24	78	220	31	40C242478SCDGBLT	\$2,689	
24 1/4	21	78	202	28	40C242178SCDGBLT	\$2,565	
24 1/4	18	78	183	24	40C241878SCDGBLT	\$2,443	
24 1/4	15	78	165	21	40C241578SCDGBLT	\$2,319	
24 1/4	12	78	146	17	40C241278SCDGBLT	\$2,196	

- metal glove box holder is included
- glove grommet size 6 1/2" x 3" x 13/16"- zinc oval grommet
- waste grommet size 7 1/2" x 4" x 13/16"- zinc oval grommet

Specify: Model | Chassis Laminate | Door Laminate | Pull | Lock | Waste Grommet Color

Model	Chassis Laminate	Door Laminate	Pull	Lock	Waste Grommet Color
	see Forge Laminate Finishes	see Forge Laminate Finishes	P001 Bar see Bar Pull Color P005 Delve see Delve Pull Color P011 Prospect see Prospect Pull Color P003 Sweep see Sweep Pull Color	NLK No Lock KLK Standard - add \$85 ASL Arctic Silver MBK Matte Black DLK Keyless Lock - add \$250	MBK Matte Black SNK Soft Nickel

19"d Models

Description	D	W	H	CTN WT	CU FT	Model	List
 <p>right shown</p>	84"h Right Hinged						
	19 ¼	24	84	214	27	40C192484SCDGBRT	\$2,673
	19 ¼	21	84	195	24	40C192184SCDGBRT	\$2,531
	19 ¼	18	84	176	21	40C191884SCDGBRT	\$2,352
	19 ¼	15	84	156	18	40C191584SCDGBRT	\$2,206
	19 ¼	12	84	137	15	40C191284SCDGBRT	\$2,082
	84"h Left Hinged						
	19 ¼	24	84	214	27	40C192484SCDGBLT	\$2,673
	19 ¼	21	84	195	24	40C192184SCDGBLT	\$2,531
	19 ¼	18	84	176	21	40C191884SCDGBLT	\$2,352
	19 ¼	15	84	156	18	40C191584SCDGBLT	\$2,206
	19 ¼	12	84	137	15	40C191284SCDGBLT	\$2,082
	78"h Right Hinged						
	19 ¼	24	78	204	25	40C192478SCDGBRT	\$2,449
	19 ¼	21	78	186	22	40C192178SCDGBRT	\$2,325
	19 ¼	18	78	167	19	40C191878SCDGBRT	\$2,203
	19 ¼	15	78	149	17	40C191578SCDGBRT	\$2,079
	19 ¼	12	78	130	14	40C191278SCDGBRT	\$1,982
	78"h Left Hinged						
	19 ¼	24	78	204	25	40C192478SCDGBLT	\$2,449
19 ¼	21	78	186	22	40C192178SCDGBLT	\$2,325	
19 ¼	18	78	167	19	40C191878SCDGBLT	\$2,203	
19 ¼	15	78	149	17	40C191578SCDGBLT	\$2,079	
19 ¼	12	78	130	14	40C191278SCDGBLT	\$1,982	

• metal glove box holder is included

Specify: Model | Chassis Laminate | Door Laminate | Pull | Lock | Waste Grommet Color

Model	Chassis Laminate	Door Laminate	Pull	Lock	Waste Grommet Color
	see Forge Laminate Finishes	see Forge Laminate Finishes	P001 Bar see Bar Pull Color P005 Delve see Delve Pull Color P011 Prospect see Prospect Pull Color P003 Sweep see Sweep Pull Color	NLK No Lock KLK Standard - add \$85 ASL Arctic Silver MBK Matte Black DLK Keyless Lock - add \$250	MBK Matte Black SNK Soft Nickel

24"d Models

Description	D	W	H	CTN WT	CU FT	① Model	List
Storage Cabinet with Doors	24 ¼	36	84	308	49	40C243684SCDT	\$3,386
	24 ¼	30	84	270	41	40C243084SCDT	\$3,241
	24 ¼	36	78	294	45	40C243678SCDT	\$3,092
	24 ¼	30	78	257	38	40C243078SCDT	\$2,946

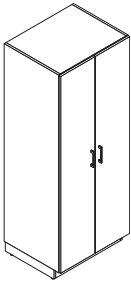

Specify: Model | Chassis Laminate | Door Laminate | Interior Configuration | Pull | Lock

19"d Models

Description	D	W	H	CTN WT	CU FT	① Model	List
Storage Cabinet with Doors	19 ¼	36	84	291	39	40C193684SCDT	\$3,129
	19 ¼	30	84	252	33	40C193084SCDT	\$2,984
	19 ¼	36	78	278	37	40C193678SCDT	\$2,899
	19 ¼	30	78	241	31	40C193078SCDT	\$2,754

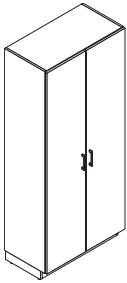

Specify: Model | Chassis Laminate | Door Laminate | Interior Configuration | Pull | Lock

Model	Chassis Laminate	Door Laminate	Interior Configuration	Pull	Lock
	see Forge Laminate Finishes	see Forge Laminate Finishes	CH Coat Hook CR2FS Coat Rod & 2 Fixed Shelves - add \$46 1F3AS 1 Fixed & 3 Adjustable Shelves - add \$161	P001 Bar see Bar Pull Color P005 Delve see Delve Pull Color P011 Prospect see Prospect Pull Color P003 Sweep see Sweep Pull Color	NLK No Lock KLK Standard - add \$111 ASL Arctic Silver MBK Matte Black DLK Keyless Lock - add \$276

24"d Models

Description	D	W	H	CTN WT	CU FT	① Model	List
Storage Filler	23 1/2	6	84	0	0	40C24684SFT	\$360
	23 1/2	6	78	0	0	40C24678SFT	\$343

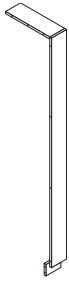

- includes brackets to attach to cabinet
- may be field scribed as needed

Specify: Model | Chassis Laminate

19"d Models

Description	D	W	H	CTN WT	CU FT	① Model	List
Storage Filler	19 1/4	6	84	7	9	40C19684SFT	\$346
	19 1/4	6	78	7	8	40C19678SFT	\$328

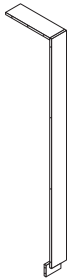

- includes brackets to attach to cabinet
- may be field scribed as needed

Specify: Model | Chassis Laminate

Model	Chassis Laminate
	see Forge Laminate Finishes

24"d Models

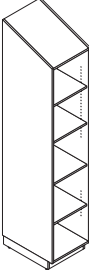
Description	D	W	H	CTN WT	CU FT	Model	List
Sloped Top Open Storage Cabinet  1 fixed & 3 adjustable shelves shown	23 1/2	36	92 1/2	258	53	40C243693SCSOT	\$2,732
	23 1/2	30	92 1/2	229	45	40C243093SCSOT	\$2,571
	23 1/2	24	92 1/2	199	37	40C242493SCSOT	\$2,411
	23 1/2	21	92 1/2	185	33	40C242193SCSOT	\$2,261
	23 1/2	18	92 1/2	170	28	40C241893SCSOT	\$2,101
	23 1/2	15	92 1/2	155	24	40C241593SCSOT	\$1,940
	23 1/2	12	92 1/2	140	20	40C241293SCSOT	\$1,779
	23 1/2	36	86 1/2	247	50	40C243687SCSOT	\$2,417
	23 1/2	30	86 1/2	219	42	40C243087SCSOT	\$2,293
	23 1/2	24	86 1/2	190	34	40C242487SCSOT	\$2,170
	23 1/2	21	86 1/2	176	30	40C242187SCSOT	\$2,047
	23 1/2	18	86 1/2	162	27	40C241887SCSOT	\$1,924
	23 1/2	15	86 1/2	147	23	40C241587SCSOT	\$1,801
	23 1/2	12	86 1/2	133	19	40C241287SCSOT	\$1,677

Specify: Model | Chassis Laminate | Interior Configuration

19"d Models

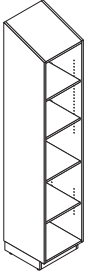
Description	D	W	H	CTN WT	CU FT	Model	List
Sloped Top Open Storage Cabinet  1 fixed & 3 adjustable shelves shown	18 1/2	36	90 3/4	236	43	40C193691SCSOT	\$2,513
	18 1/2	30	90 3/4	207	36	40C193091SCSOT	\$2,400
	18 1/2	24	90 3/4	177	30	40C192491SCSOT	\$2,240
	18 1/2	21	90 3/4	163	26	40C192191SCSOT	\$2,036
	18 1/2	18	90 3/4	148	23	40C191891SCSOT	\$1,929
	18 1/2	15	90 3/4	134	20	40C191591SCSOT	\$1,768
	18 1/2	12	90 3/4	119	16	40C191291SCSOT	\$1,607
	18 1/2	36	84 3/4	228	40	40C193685SCSOT	\$2,218
	18 1/2	30	84 3/4	199	34	40C193085SCSOT	\$2,096
	18 1/2	24	84 3/4	170	28	40C192485SCSOT	\$1,972
	18 1/2	21	84 3/4	156	25	40C192185SCSOT	\$1,848
	18 1/2	18	84 3/4	142	21	40C191885SCSOT	\$1,726
	18 1/2	15	84 3/4	128	18	40C191585SCSOT	\$1,602
	18 1/2	12	84 3/4	113	15	40C191285SCSOT	\$1,527

Specify: Model | Chassis Laminate | Interior Configuration

Model	Chassis Laminate	Interior Configuration
	see Forge Laminate Finishes	CH Coat Hook CR2FS Coat Rod & 2 Fixed Shelves - add \$46 1F3AS 1 Fixed & 3 Adjustable Shelves - add \$161

24" d Models

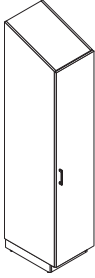
Description	D	W	H	CTN WT	CU FT	Model	List
 <p>right shown</p>	92 ½" h Right Hinged						
	24 ¼	24	92 ½	240	37	40C242493SCDSRT	\$2,722
	24 ¼	21	92 ½	221	33	40C242193SCDSRT	\$2,559
	24 ¼	18	92 ½	201	28	40C241893SCDSRT	\$2,405
	24 ¼	15	92 ½	181	24	40C241593SCDSRT	\$2,256
	24 ¼	12	92 ½	161	20	40C241293SCDSRT	\$2,102
	92 ½" h Left Hinged						
	24 ¼	24	92 ½	240	37	40C242493SCDSL	\$2,722
	24 ¼	21	92 ½	221	33	40C242193SCDSL	\$2,559
	24 ¼	18	92 ½	201	28	40C241893SCDSL	\$2,405
	24 ¼	15	92 ½	181	24	40C241593SCDSL	\$2,256
	24 ¼	12	92 ½	161	20	40C241293SCDSL	\$2,102
	86 ½" h Right Hinged						
	24 ¼	24	86 ½	228	34	40C242487SCDSRT	\$2,411
	24 ¼	21	86 ½	209	30	40C242187SCDSRT	\$2,293
	24 ¼	18	86 ½	190	27	40C241887SCDSRT	\$2,272
	24 ¼	15	86 ½	171	23	40C241587SCDSRT	\$2,154
	24 ¼	12	86 ½	152	19	40C241287SCDSRT	\$1,940
	86 ½" h Left Hinged						
	24 ¼	24	86 ½	228	34	40C242487SCDSL	\$2,411
24 ¼	21	86 ½	209	30	40C242187SCDSL	\$2,293	
24 ¼	18	86 ½	190	27	40C241887SCDSL	\$2,272	
24 ¼	15	86 ½	171	23	40C241587SCDSL	\$2,154	
24 ¼	12	86 ½	152	19	40C241287SCDSL	\$1,940	

Specify: Model | Chassis Laminate | Door Laminate | Interior Configuration | Pull | Lock

Model	Chassis Laminate	Door Laminate	Interior Configuration	Pull	Lock
	see Forge Laminate Finishes	see Forge Laminate Finishes	CH Coat Hook CR2FS Coat Rod & 2 Fixed Shelves - add \$46 1F3AS 1 Fixed & 3 Adjustable Shelves - add \$161	P001 Bar see Bar Pull Color P005 Delve see Delve Pull Color P011 Prospect see Prospect Pull Color P003 Sweep see Sweep Pull Color	NLK No Lock KLK Standard - add \$85 ASL Arctic Silver MBK Matte Black DLK Keyless Lock - add \$250

19"d Models

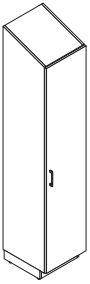
Description	D	W	H	CTN WT	CU FT	Model	List
 <p>right shown</p>	90 ¾" h Right Hinged						
	19 ¼	24	90 ¾	218	30	40C192491SCDSRT	\$2,497
	19 ¼	21	90 ¾	199	26	40C192191SCDSRT	\$2,388
	19 ¼	18	90 ¾	179	23	40C191891SCDSRT	\$2,234
	19 ¼	15	90 ¾	159	20	40C191591SCDSRT	\$2,025
	19 ¼	12	90 ¾	139	16	40C191291SCDSRT	\$1,925
	90 ¾" h Left Hinged						
	19 ¼	24	90 ¾	218	30	40C192491SCDSL	\$2,497
	19 ¼	21	90 ¾	199	26	40C192191SCDSL	\$2,388
	19 ¼	18	90 ¾	179	23	40C191891SCDSL	\$2,234
	19 ¼	15	90 ¾	159	20	40C191591SCDSL	\$2,025
	19 ¼	12	90 ¾	139	16	40C191291SCDSL	\$1,925
	84 ¾" h Right Hinged						
	19 ¼	24	84 ¾	208	28	40C192485SCDSRT	\$2,186
	19 ¼	21	84 ¾	190	25	40C192185SCDSRT	\$2,084
	19 ¼	18	84 ¾	170	21	40C191885SCDSRT	\$1,967
	19 ¼	15	84 ¾	152	18	40C191585SCDSRT	\$1,865
	19 ¼	12	84 ¾	132	15	40C191285SCDSRT	\$1,768
	84 ¾" h Left Hinged						
	19 ¼	24	84 ¾	208	28	40C192485SCDSL	\$2,186
19 ¼	21	84 ¾	190	25	40C192185SCDSL	\$2,084	
19 ¼	18	84 ¾	170	21	40C191885SCDSL	\$1,967	
19 ¼	15	84 ¾	152	18	40C191585SCDSL	\$1,865	
19 ¼	12	84 ¾	132	15	40C191285SCDSL	\$1,768	

Specify: Model | Chassis Laminate | Door Laminate | Interior Configuration | Pull | Lock

Model	Chassis Laminate	Door Laminate	Interior Configuration	Pull	Lock
	see Forge Laminate Finishes	see Forge Laminate Finishes	CH Coat Hook CR2FS Coat Rod & 2 Fixed Shelves - add \$46 1F3AS 1 Fixed & 3 Adjustable Shelves - add \$161	P001 Bar see Bar Pull Color P005 Delve see Delve Pull Color P011 Prospect see Prospect Pull Color P003 Sweep see Sweep Pull Color	NLK No Lock KLK Standard - add \$85 ASL Arctic Silver MBK Matte Black DLK Keyless Lock - add \$250

24"d Models

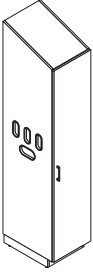
Description	D	W	H	CTN WT	CU FT	Model	List
 <p>right shown</p>	92 ½" h Right Hinged						
	24 ¼	24	92 ½	240	37	40C242493SCDGBSRT	\$2,979
	24 ¼	21	92 ½	221	33	40C242193SCDGBSRT	\$2,824
	24 ¼	18	92 ½	201	28	40C241893SCDGBSRT	\$2,668
	24 ¼	15	92 ½	181	24	40C241593SCDGBSRT	\$2,513
	24 ¼	12	92 ½	161	20	40C241293SCDGBSRT	\$2,357
	92 ½" h Left Hinged						
	24 ¼	24	92 ½	240	37	40C242493SCDGBSLT	\$2,979
	24 ¼	21	92 ½	221	33	40C242193SCDGBSLT	\$2,824
	24 ¼	18	92 ½	201	28	40C241893SCDGBSLT	\$2,668
	24 ¼	15	92 ½	181	24	40C241593SCDGBSLT	\$2,513
	24 ¼	12	92 ½	161	20	40C241293SCDGBSLT	\$2,357
	86 ½" h Right Hinged						
	24 ¼	24	86 ½	228	34	40C242487SCDGBSRT	\$2,765
	24 ¼	21	86 ½	209	30	40C242187SCDGBSRT	\$2,647
	24 ¼	18	86 ½	190	27	40C241887SCDGBSRT	\$2,529
	24 ¼	15	86 ½	171	23	40C241587SCDGBSRT	\$2,411
	24 ¼	12	86 ½	152	19	40C241287SCDGBSRT	\$2,293
	86 ½" h Left Hinged						
	24 ¼	24	86 ½	228	34	40C242487SCDGBSLT	\$2,765
24 ¼	21	86 ½	209	30	40C242187SCDGBSLT	\$2,647	
24 ¼	18	86 ½	190	27	40C241887SCDGBSLT	\$2,529	
24 ¼	15	86 ½	171	23	40C241587SCDGBSLT	\$2,411	
24 ¼	12	86 ½	152	19	40C241287SCDGBSLT	\$2,293	

• metal glove box holder is included

Specify: Model | Chassis Laminate | Door Laminate | Pull | Lock | Waste Grommet Color

Model	Chassis Laminate	Door Laminate	Pull	Lock	Waste Grommet Color
	see Forge Laminate Finishes	see Forge Laminate Finishes	P001 Bar see Bar Pull Color P005 Delve see Delve Pull Color P011 Prospect see Prospect Pull Color P003 Sweep see Sweep Pull Color	NLK No Lock KLK Standard - add \$85 ASL Arctic Silver MBK Matte Black DLK Keyless Lock - add \$250	MBK Matte Black SNK Soft Nickel

19" d Models

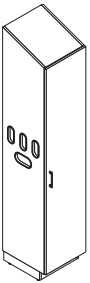
Description	D	W	H	CTN WT	CU FT	Model	List
 <p>right shown</p>	90 3/4" h Right Hinged						
	19 1/4	24	90 3/4	218	30	40C192491SCDGBSRT	\$2,759
	19 1/4	21	90 3/4	199	26	40C192191SCDGBSRT	\$2,566
	19 1/4	18	90 3/4	179	23	40C191891SCDGBSRT	\$2,474
	19 1/4	15	90 3/4	159	20	40C191591SCDGBSRT	\$2,320
	19 1/4	12	90 3/4	139	16	40C191291SCDGBSRT	\$2,133
	90 3/4" h Left Hinged						
	19 1/4	24	90 3/4	218	30	40C192491SCDGBSLT	\$2,759
	19 1/4	21	90 3/4	199	26	40C192191SCDGBSLT	\$2,566
	19 1/4	18	90 3/4	179	23	40C191891SCDGBSLT	\$2,474
	19 1/4	15	90 3/4	159	20	40C191591SCDGBSLT	\$2,320
	19 1/4	12	90 3/4	139	16	40C191291SCDGBSLT	\$2,133
	84 3/4" h Right Hinged						
	19 1/4	24	84 3/4	208	28	40C192485SCDGBSRT	\$2,539
	19 1/4	21	84 3/4	190	25	40C192185SCDGBSRT	\$2,454
	19 1/4	18	84 3/4	170	21	40C191885SCDGBSRT	\$2,337
	19 1/4	15	84 3/4	152	18	40C191585SCDGBSRT	\$2,165
	19 1/4	12	84 3/4	132	15	40C191285SCDGBSRT	\$2,069
	84 3/4" h Left Hinged						
	19 1/4	24	84 3/4	208	28	40C192485SCDGBSLT	\$2,539
19 1/4	21	84 3/4	190	25	40C192185SCDGBSLT	\$2,454	
19 1/4	18	84 3/4	170	21	40C191885SCDGBSLT	\$2,337	
19 1/4	15	84 3/4	152	18	40C191585SCDGBSLT	\$2,165	
19 1/4	12	84 3/4	132	15	40C191285SCDGBSLT	\$2,069	

• metal glove box holder is included

Specify: Model | Chassis Laminate | Door Laminate | Pull | Lock | Waste Grommet Color

Model	Chassis Laminate	Door Laminate	Pull	Lock	Waste Grommet Color
	see Forge Laminate Finishes	see Forge Laminate Finishes	P001 Bar see Bar Pull Color P005 Delve see Delve Pull Color P011 Prospect see Prospect Pull Color P003 Sweep see Sweep Pull Color	NLK No Lock KLK Standard - add \$85 ASL Arctic Silver MBK Matte Black DLK Keyless Lock - add \$250	MBK Matte Black SNK Soft Nickel

24"d Models

Description	D	W	H	CTN WT	CU FT	① Model	List
Sloped Top Storage Cabinet with Doors	24 ¼	36	92 ½	320	53	40C243693SCDST	\$3,450
	24 ¼	30	92 ½	280	45	40C243093SCDST	\$3,306
	24 ¼	36	86 ½	305	50	40C243687SCDST	\$3,145
	24 ¼	30	86 ½	266	42	40C243087SCDST	\$3,000

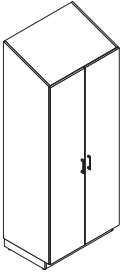

Specify: Model | Chassis Laminate | Door Laminate | Interior Configuration | Pull | Lock

19"d Models

Description	D	W	H	CTN WT	CU FT	① Model	List
Sloped Top Storage Cabinet with Doors	19 ¼	36	90 ¾	298	43	40C193691SCDST	\$3,209
	19 ¼	30	90 ¾	258	36	40C193091SCDST	\$3,065
	19 ¼	36	84 ¾	285	40	40C193685SCDST	\$2,984
	19 ¼	30	84 ¾	247	34	40C193085SCDST	\$2,839

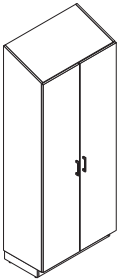

Specify: Model | Chassis Laminate | Door Laminate | Interior Configuration | Pull | Lock

Model	Chassis Laminate	Door Laminate	Interior Configuration	Pull	Lock
	see Forge Laminate Finishes	see Forge Laminate Finishes	CH Coat Hook CR2FS Coat Rod & 2 Fixed Shelves - add \$46 1F3AS 1 Fixed & 3 Adjustable Shelves - add \$161	P001 Bar see Bar Pull Color P005 Delve see Delve Pull Color P011 Prospect see Prospect Pull Color P003 Sweep see Sweep Pull Color	NLK No Lock KLK Standard - add \$111 ASL Arctic Silver MBK Matte Black DLK Keyless Lock - add \$276

24"d Models

Description	D	W	H	CTN WT	CU FT	Model	List
Sloped Top Storage Filler	23 1/2	6	92 1/2	8	12	40C24693SFST	\$384
	23 1/2	6	86 1/2	7	12	40C24687SFST	\$365

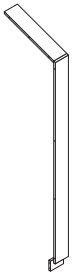

- includes brackets to attach to cabinet
- may be field scribed as needed

Specify: Model | Chassis Laminate

19"d Models

Description	D	W	H	CTN WT	CU FT	Model	List
Sloped Top Storage Filler	19 1/4	6	90 3/4	7	10	40C19691SFST	\$363
	19 1/4	6	84 3/4	7	9	40C19685SFST	\$346



- includes brackets to attach to cabinet
- may be field scribed as needed

Specify: Model | Chassis Laminate

Model	Chassis Laminate
	see Forge Laminate Finishes

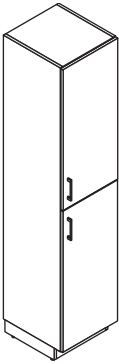
Description	D	W	H	CTN WT	CU FT	Model	List
 <p>right shown</p>	Right Hinged						
	24 ¼	24	84	208	33	40C242484SCDR2T	\$2,459
	24 ¼	21	84	193	30	40C242184SCDR2T	\$2,344
	24 ¼	18	84	177	26	40C241884SCDR2T	\$2,229
	24 ¼	15	84	162	22	40C241584SCDR2T	\$2,114
	24 ¼	12	84	146	18	40C241284SCDR2T	\$2,000
	19 ¼	24	84	179	28	40C192484SCDR2T	\$2,223
	19 ¼	21	84	164	25	40C192184SCDR2T	\$2,033
	19 ¼	18	84	149	22	40C191884SCDR2T	\$1,843
	19 ¼	15	84	134	19	40C191584SCDR2T	\$1,761
	19 ¼	12	84	119	15	40C191284SCDR2T	\$1,678
	Left Hinged						
	24 ¼	24	84	208	33	40C242484SCDL2T	\$2,459
	24 ¼	21	84	193	30	40C242184SCDL2T	\$2,344
	24 ¼	18	84	177	26	40C241884SCDL2T	\$2,229
	24 ¼	15	84	162	22	40C241584SCDL2T	\$2,114
	24 ¼	12	84	146	18	40C241284SCDL2T	\$2,000
	19 ¼	24	84	179	28	40C192484SCDL2T	\$2,223
	19 ¼	21	84	164	25	40C192184SCDL2T	\$2,033
19 ¼	18	84	149	22	40C191884SCDL2T	\$1,843	
19 ¼	15	84	134	19	40C191584SCDL2T	\$1,761	
19 ¼	12	84	119	15	40C191284SCDL2T	\$1,678	

• includes two coat hooks per door

Specify: Model | Chassis Laminate | Door Laminate | Pull | Lock

Model	Chassis Laminate	Door Laminate	Pull	Lock
	see Forge Laminate Finishes	see Forge Laminate Finishes	P001 Bar see Bar Pull Color P005 Delve see Delve Pull Color P011 Prospect see Prospect Pull Color P003 Sweep see Sweep Pull Color	NLK No Lock KLK Standard - add \$168 ASL Arctic Silver MBK Matte Black DLK Keyless Lock - add \$498

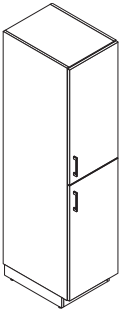
Description	D	W	H	CTN WT	CU FT	Model	List
 <p>right shown</p>	Right Hinged						
	24 ¼	24	78	196	31	40C242478SCDR2T	\$1,972
	24 ¼	21	78	182	28	40C242178SCDR2T	\$1,929
	24 ¼	18	78	167	24	40C241878SCDR2T	\$1,881
	24 ¼	15	78	152	21	40C241578SCDR2T	\$1,673
	24 ¼	12	78	137	17	40C241278SCDR2T	\$1,527
	19 ¼	24	78	169	26	40C192478SCDR2T	\$1,929
	19 ¼	21	78	155	23	40C192178SCDR2T	\$1,747
	19 ¼	18	78	141	20	40C191878SCDR2T	\$1,672
	19 ¼	15	78	127	17	40C191578SCDR2T	\$1,572
	19 ¼	12	78	112	14	40C191278SCDR2T	\$1,473
	Left Hinged						
	24 ¼	24	78	196	31	40C242478SCDL2T	\$1,972
	24 ¼	21	78	182	28	40C242178SCDL2T	\$1,929
	24 ¼	18	78	167	24	40C241878SCDL2T	\$1,881
	24 ¼	15	78	152	21	40C241578SCDL2T	\$1,673
	24 ¼	12	78	137	17	40C241278SCDL2T	\$1,527
	19 ¼	24	78	169	26	40C192478SCDL2T	\$1,929
	19 ¼	21	78	155	23	40C192178SCDL2T	\$1,747
19 ¼	18	78	141	20	40C191878SCDL2T	\$1,672	
19 ¼	15	78	127	17	40C191578SCDL2T	\$1,572	
19 ¼	12	78	112	14	40C191278SCDL2T	\$1,473	

• includes two coat hooks per door

Specify: Model | Chassis Laminate | Door Laminate | Pull | Lock

Model	Chassis Laminate	Door Laminate	Pull	Lock
	see Forge Laminate Finishes	see Forge Laminate Finishes	P001 Bar see Bar Pull Color P005 Delve see Delve Pull Color P011 Prospect see Prospect Pull Color P003 Sweep see Sweep Pull Color	NLK No Lock KLK Standard - add \$168 ASL Arctic Silver MBK Matte Black DLK Keyless Lock - add \$498

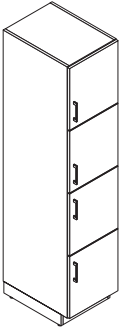
Description	D	W	H	CTN WT	CU FT	Model	List
 <p>right shown</p>	Right Hinged						
	24 ¼	24	84	219	33	40C242484SCDR4T	\$2,770
	24 ¼	21	84	202	30	40C242184SCDR4T	\$2,578
	24 ¼	18	84	185	26	40C241884SCDR4T	\$2,384
	24 ¼	15	84	168	22	40C241584SCDR4T	\$2,191
	24 ¼	12	84	151	18	40C241284SCDR4T	\$1,999
	19 ¼	24	84	189	28	40C192484SCDR4T	\$2,518
	19 ¼	21	84	172	25	40C192184SCDR4T	\$2,316
	19 ¼	18	84	156	22	40C191884SCDR4T	\$2,112
	19 ¼	15	84	140	19	40C191584SCDR4T	\$1,910
	19 ¼	12	84	123	15	40C191284SCDR4T	\$1,707
	Left Hinged						
	24 ¼	24	84	219	33	40C242484SCDL4T	\$2,770
	24 ¼	21	84	202	30	40C242184SCDL4T	\$2,578
	24 ¼	18	84	185	26	40C241884SCDL4T	\$2,384
	24 ¼	15	84	168	22	40C241584SCDL4T	\$2,191
	24 ¼	12	84	151	18	40C241284SCDL4T	\$1,999
	19 ¼	24	84	194	28	40C192484SCDL4T	\$2,518
	19 ¼	21	84	177	25	40C192184SCDL4T	\$2,316
19 ¼	18	84	160	22	40C191884SCDL4T	\$2,112	
19 ¼	15	84	143	19	40C191584SCDL4T	\$1,910	
19 ¼	12	84	126	15	40C191284SCDL4T	\$1,707	

• includes two coat hooks per door

Specify: Model | Chassis Laminate | Door Laminate | Pull | Lock

Model	Chassis Laminate	Door Laminate	Pull	Lock
	see Forge Laminate Finishes	see Forge Laminate Finishes	P001 Bar see Bar Pull Color P005 Delve see Delve Pull Color P011 Prospect see Prospect Pull Color P003 Sweep see Sweep Pull Color	NLK No Lock KLK Standard - add \$335 ASL Arctic Silver MBK Matte Black DLK Keyless Lock - add \$995

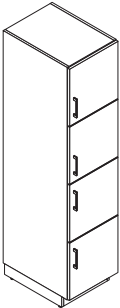
Description	D	W	H	CTN WT	CU FT	Model	List
 <p>right shown</p>	Right Hinged						
	24 ¼	24	78	207	31	40C242478SCDR4T	\$2,433
	24 ¼	21	78	191	28	40C242178SCDR4T	\$2,297
	24 ¼	18	78	174	24	40C241878SCDR4T	\$2,161
	24 ¼	15	78	158	21	40C241578SCDR4T	\$2,025
	24 ¼	12	78	142	17	40C241278SCDR4T	\$1,890
	19 ¼	24	78	178	26	40C192478SCDR4T	\$2,188
	19 ¼	21	78	163	23	40C192178SCDR4T	\$2,058
	19 ¼	18	78	147	20	40C191878SCDR4T	\$1,929
	19 ¼	15	78	132	17	40C191578SCDR4T	\$1,799
	19 ¼	12	78	116	14	40C191278SCDR4T	\$1,669
	Left Hinged						
	24 ¼	24	78	207	31	40C242478SCDL4T	\$2,433
	24 ¼	21	78	191	28	40C242178SCDL4T	\$2,297
	24 ¼	18	78	174	24	40C241878SCDL4T	\$2,161
	24 ¼	15	78	158	21	40C241578SCDL4T	\$2,025
	24 ¼	12	78	142	17	40C241278SCDL4T	\$1,890
	19 ¼	24	78	184	26	40C192478SCDL4T	\$2,188
	19 ¼	21	78	168	23	40C192178SCDL4T	\$2,058
19 ¼	18	78	152	20	40C191878SCDL4T	\$1,929	
19 ¼	15	78	136	17	40C191578SCDL4T	\$1,799	
19 ¼	12	78	120	14	40C191278SCDL4T	\$1,669	

• includes two coat hooks per door

Specify: Model | Chassis Laminate | Door Laminate | Pull | Lock

Model	Chassis Laminate	Door Laminate	Pull	Lock
	see Forge Laminate Finishes	see Forge Laminate Finishes	P001 Bar see Bar Pull Color P005 Delve see Delve Pull Color P011 Prospect see Prospect Pull Color P003 Sweep see Sweep Pull Color	NLK No Lock KLK Standard - add \$335 ASL Arctic Silver MBK Matte Black DLK Keyless Lock - add \$995

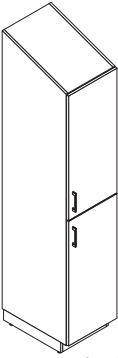
Description	D	W	H	CTN WT	CU FT	Model	List
Sloped Top Two Door Lockers							
92 ½" h Right Hinged							
	24 ¼	24	92 ½	208	37	40C242493SCDR2ST	\$2,529
	24 ¼	21	92 ½	193	33	40C242193SCDR2ST	\$2,414
	24 ¼	18	92 ½	177	28	40C241893SCDR2ST	\$2,298
	24 ¼	15	92 ½	162	24	40C241593SCDR2ST	\$2,184
	24 ¼	12	92 ½	146	20	40C241293SCDR2ST	\$2,070
92 ½" h Left Hinged							
	24 ¼	24	92 ½	208	37	40C242493SCDL2ST	\$2,529
	24 ¼	21	92 ½	193	33	40C242193SCDL2ST	\$2,414
	24 ¼	18	92 ½	177	28	40C241893SCDL2ST	\$2,298
	24 ¼	15	92 ½	162	24	40C241593SCDL2ST	\$2,184
	24 ¼	12	92 ½	146	20	40C241293SCDL2ST	\$2,070
90 ¾" h Right Hinged							
	19 ¼	24	90 ¾	181	30	40C192491SCDR2ST	\$2,296
	19 ¼	21	90 ¾	166	27	40C192191SCDR2ST	\$2,106
	19 ¼	18	90 ¾	151	24	40C191891SCDR2ST	\$1,916
	19 ¼	15	90 ¾	136	20	40C191591SCDR2ST	\$1,834
	19 ¼	12	90 ¾	121	17	40C191291SCDR2ST	\$1,751
90 ¾" h Left Hinged							
	19 ¼	24	90 ¾	181	30	40C192491SCDL2ST	\$2,296
	19 ¼	21	90 ¾	166	27	40C192191SCDL2ST	\$2,106
	19 ¼	18	90 ¾	151	24	40C191891SCDL2ST	\$1,916
	19 ¼	15	90 ¾	136	20	40C191591SCDL2ST	\$1,834
	19 ¼	12	90 ¾	121	17	40C191291SCDL2ST	\$1,751

• includes two coat hooks per door

Specify: Model | Chassis Laminate | Door Laminate | Pull | Lock

Model	Chassis Laminate	Door Laminate	Pull	Lock
	see Forge Laminate Finishes	see Forge Laminate Finishes	P001 Bar see Bar Pull Color P005 Delve see Delve Pull Color P011 Prospect see Prospect Pull Color P003 Sweep see Sweep Pull Color	NLK No Lock KLK Standard - add \$168 ASL Arctic Silver MBK Matte Black DLK Keyless Lock - add \$498

Description	D	W	H	CTN WT	CU FT	Model	List
-------------	---	---	---	--------	-------	-------	------

Sloped Top Two Door Lockers

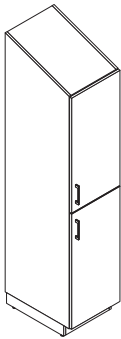

right shown

86 1/2" h Right Hinged

24 1/4	24	86 1/2	196	34	40C242487SCDR2ST	\$2,042
24 1/4	21	86 1/2	182	30	40C242187SCDR2ST	\$1,999
24 1/4	18	86 1/2	167	27	40C241887SCDR2ST	\$1,950
24 1/4	15	86 1/2	152	23	40C241587SCDR2ST	\$1,743
24 1/4	12	86 1/2	137	19	40C241287SCDR2ST	\$1,597

86 1/2" h Left Hinged

24 1/4	24	86 1/2	196	34	40C242487SCDL2ST	\$2,042
24 1/4	21	86 1/2	182	30	40C242187SCDL2ST	\$1,999
24 1/4	18	86 1/2	167	27	40C241887SCDL2ST	\$1,950
24 1/4	15	86 1/2	152	23	40C241587SCDL2ST	\$1,743
24 1/4	12	86 1/2	137	19	40C241287SCDL2ST	\$1,597

84 3/4" h Right Hinged

19 1/4	24	84 3/4	171	29	40C192485SCDR2ST	\$2,002
19 1/4	21	84 3/4	157	25	40C192185SCDR2ST	\$1,819
19 1/4	18	84 3/4	142	22	40C191885SCDR2ST	\$1,745
19 1/4	15	84 3/4	128	19	40C191585SCDR2ST	\$1,645
19 1/4	12	84 3/4	114	16	40C191285SCDR2ST	\$1,547

84 3/4" h Left Hinged

19 1/4	24	84 3/4	171	29	40C192485SCDL2ST	\$2,002
19 1/4	21	84 3/4	157	25	40C192185SCDL2ST	\$1,819
19 1/4	18	84 3/4	142	22	40C191885SCDL2ST	\$1,745
19 1/4	15	84 3/4	128	19	40C191585SCDL2ST	\$1,645
19 1/4	12	84 3/4	114	16	40C191285SCDL2ST	\$1,547

• includes two coat hooks per door

Specify: Model | Chassis Laminate | Door Laminate | Pull | Lock

Model	Chassis Laminate	Door Laminate	Pull	Lock
	see Forge Laminate Finishes	see Forge Laminate Finishes	P001 Bar see Bar Pull Color P005 Delve see Delve Pull Color P011 Prospect see Prospect Pull Color P003 Sweep see Sweep Pull Color	NLK No Lock KLK Standard - add \$168 ASL Arctic Silver MBK Matte Black DLK Keyless Lock - add \$498

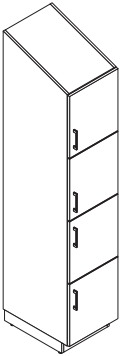
Description	D	W	H	CTN WT	CU FT	Model	List
 <p>right shown</p>	92 ½" h Right Hinged						
	24 ¼	24	92 ½	219	37	40C242493SCDR4ST	\$2,863
	24 ¼	21	92 ½	202	33	40C242193SCDR4ST	\$2,670
	24 ¼	18	92 ½	185	28	40C241893SCDR4ST	\$2,478
	24 ¼	15	92 ½	168	24	40C241593SCDR4ST	\$2,285
	24 ¼	12	92 ½	151	20	40C241293SCDR4ST	\$2,092
	92 ½" h Left Hinged						
	24 ¼	24	92 ½	219	37	40C242493SCDL4ST	\$2,863
	24 ¼	21	92 ½	202	33	40C242193SCDL4ST	\$2,670
	24 ¼	18	92 ½	185	28	40C241893SCDL4ST	\$2,478
	24 ¼	15	92 ½	168	24	40C241593SCDL4ST	\$2,285
	24 ¼	12	92 ½	151	20	40C241293SCDL4ST	\$2,092
	90 ¾" h Right Hinged						
	19 ¼	24	90 ¾	190	30	40C192491SCDR4ST	\$2,620
	19 ¼	21	90 ¾	174	27	40C192191SCDR4ST	\$2,418
	19 ¼	18	90 ¾	157	24	40C191891SCDR4ST	\$2,214
	19 ¼	15	90 ¾	141	20	40C191591SCDR4ST	\$2,012
	19 ¼	12	90 ¾	125	17	40C191291SCDR4ST	\$1,809
	90 ¾" h Left Hinged						
	19 ¼	24	90 ¾	190	30	40C192491SCDL4ST	\$2,620
19 ¼	21	90 ¾	174	27	40C192191SCDL4ST	\$2,418	
19 ¼	18	90 ¾	157	24	40C191891SCDL4ST	\$2,214	
19 ¼	15	90 ¾	141	20	40C191591SCDL4ST	\$2,012	
19 ¼	12	90 ¾	125	17	40C191291SCDL4ST	\$1,809	

• includes two coat hooks per door

Specify: Model | Chassis Laminate | Door Laminate | Pull | Lock

Model	Chassis Laminate	Door Laminate	Pull	Lock
	see Forge Laminate Finishes	see Forge Laminate Finishes	P001 Bar see Bar Pull Color P005 Delve see Delve Pull Color P011 Prospect see Prospect Pull Color P003 Sweep see Sweep Pull Color	NLK No Lock KLK Standard - add \$335 ASL Arctic Silver MBK Matte Black DLK Keyless Lock - add \$995

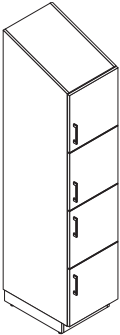
Description	D	W	H	CTN WT	CU FT	Model	List
 <p>right shown</p>	86 ½" h Right Hinged						
	24 ¼	24	86 ½	207	34	40C242487SCDR4ST	\$2,532
	24 ¼	21	86 ½	191	30	40C242187SCDR4ST	\$2,396
	24 ¼	18	86 ½	174	27	40C241887SCDR4ST	\$2,260
	24 ¼	15	86 ½	158	23	40C241587SCDR4ST	\$2,124
	24 ¼	12	86 ½	142	19	40C241287SCDR4ST	\$1,988
	86 ½" h Left Hinged						
	24 ¼	24	86 ½	207	34	40C242487SCDL4ST	\$2,532
	24 ¼	21	86 ½	191	30	40C242187SCDL4ST	\$2,396
	24 ¼	18	86 ½	174	27	40C241887SCDL4ST	\$2,260
	24 ¼	15	86 ½	158	23	40C241587SCDL4ST	\$2,124
	24 ¼	12	86 ½	142	19	40C241287SCDL4ST	\$1,988
	84 ¾" h Right Hinged						
	19 ¼	24	84 ¾	180	29	40C192485SCDR4ST	\$2,287
	19 ¼	21	84 ¾	165	25	40C192185SCDR4ST	\$2,157
	19 ¼	18	84 ¾	149	22	40C191885SCDR4ST	\$2,028
	19 ¼	15	84 ¾	133	19	40C191585SCDR4ST	\$1,897
	19 ¼	12	84 ¾	118	16	40C191285SCDR4ST	\$1,767
	84 ¾" h Right Hinged						
	19 ¼	24	84 ¾	180	29	40C192485SCDL4ST	\$2,287
19 ¼	21	84 ¾	165	25	40C192185SCDL4ST	\$2,157	
19 ¼	18	84 ¾	149	22	40C191885SCDL4ST	\$2,028	
19 ¼	15	84 ¾	133	19	40C191585SCDL4ST	\$1,897	
19 ¼	12	84 ¾	118	16	40C191285SCDL4ST	\$1,767	

• includes two coat hooks per door

Specify: Model | Chassis Laminate | Door Laminate | Pull | Lock

Model	Chassis Laminate	Door Laminate	Pull	Lock
	see Forge Laminate Finishes	see Forge Laminate Finishes	P001 Bar see Bar Pull Color P005 Delve see Delve Pull Color P011 Prospect see Prospect Pull Color P003 Sweep see Sweep Pull Color	NLK No Lock KLK Standard - add \$335 ASL Arctic Silver MBK Matte Black DLK Keyless Lock - add \$995

Description	D	W	H	CTN WT	CU FT	Model	List
	¾	36	42	33	3	40C3642WPT	\$515
	¾	30	42	28	3	40C3042WPT	\$511
	¾	24	42	22	2	40C2442WPT	\$506
	¾	21	42	20	2	40C2142WPT	\$503
	¾	18	42	17	2	40C1842WPT	\$500
	¾	36	36	29	3	40C3636WPT	\$438
	¾	30	36	24	2	40C3036WPT	\$434
	¾	24	36	19	2	40C2436WPT	\$429
	¾	21	36	17	2	40C2136WPT	\$426
	¾	18	36	14	2	40C1836WPT	\$423
	¾	36	30	24	2	40C3630WPT	\$353
	¾	30	30	20	2	40C3030WPT	\$348
	¾	24	30	16	2	40C2430WPT	\$343
	¾	21	30	14	2	40C2130WPT	\$340
	¾	18	30	12	1	40C1830WPT	\$337
	¾	36	24	19	2	40C3624WPT	\$308
	¾	30	24	16	2	40C3024WPT	\$304
	¾	24	24	13	2	40C2424WPT	\$300
	¾	21	24	11	1	40C2124WPT	\$297
	¾	18	24	10	1	40C1824WPT	\$293
¾	36	18	15	2	40C3618WPT	\$290	
¾	30	18	12	1	40C3018WPT	\$287	
¾	24	18	10	1	40C2418WPT	\$284	
¾	21	18	9	1	40C2118WPT	\$281	
¾	18	18	7	1	40C1818WPT	\$278	

Specify: Model | Chassis Laminate

Model	Chassis Laminate
	see Forge Laminate Finishes

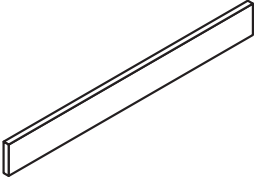
Description	D	W	H	CTN WT	CU FT	Model	List
Toe Kick 	¾	96	4	8	1	40C496TKT	\$231
	¾	95 ½	4	8	1	40C495TKT	\$229
	¾	93	4	8	1	40C493TKT	\$227
	¾	92 ½	4	8	1	40C492TKT	\$225
	¾	90	4	8	1	40C490TKT	\$223
	¾	89 ½	4	8	1	40C489TKT	\$221
	¾	87	4	8	1	40C487TKT	\$219
	¾	86 ½	4	7	1	40C486TKT	\$217
	¾	84	4	7	1	40C484TKT	\$214
	¾	83 ½	4	7	1	40C483TKT	\$212
	¾	81	4	7	1	40C481TKT	\$210
	¾	80 ½	4	7	1	40C480TKT	\$208
	¾	78	4	7	1	40C478TKT	\$206
	¾	77 ½	4	7	1	40C477TKT	\$204
	¾	75	4	7	1	40C475TKT	\$202
	¾	74 ½	4	7	1	40C474TKT	\$200
	¾	72	4	6	1	40C472TKT	\$198
	¾	71 ½	4	6	1	40C471TKT	\$196
	¾	69	4	6	1	40C469TKT	\$194
	¾	68 ½	4	6	1	40C468TKT	\$192
	¾	66	4	6	1	40C466TKT	\$190
	¾	65 ½	4	6	1	40C465TKT	\$187
	¾	63	4	6	1	40C463TKT	\$185
	¾	62 ½	4	6	1	40C462TKT	\$183
	¾	60	4	5	1	40C460TKT	\$181
	¾	59 ½	4	5	1	40C459TKT	\$179
	¾	57	4	5	1	40C457TKT	\$177
	¾	56 ½	4	5	1	40C456TKT	\$175
¾	54	4	5	1	40C454TKT	\$173	
¾	53 ½	4	5	1	40C453TKT	\$170	
¾	51	4	5	1	40C451TKT	\$168	
¾	50 ½	4	5	1	40C450TKT	\$166	
¾	48	4	4	1	40C448TKT	\$165	
¾	47 ½	4	4	1	40C447TKT	\$163	

Specify: Model | Chassis Laminate

Model	Chassis Laminate
	see Forge Laminate Finishes

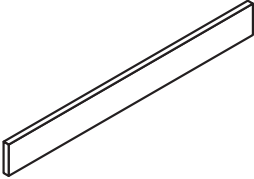
Description	D	W	H	CTN WT	CU FT	① Model	List
Toe Kick (continued)	¾	45	4	4	1	40C445TKT	\$160
	¾	44 ½	4	4	1	40C444TKT	\$158
	¾	42	4	4	1	40C442TKT	\$157
	¾	41 ½	4	4	1	40C441TKT	\$155
	¾	39	4	4	1	40C439TKT	\$153
	¾	38 ½	4	4	1	40C438TKT	\$151
	¾	36	4	3	1	40C436TKT	\$149
	¾	35 ½	4	3	1	40C435TKT	\$147
	¾	33	4	3	1	40C433TKT	\$145
	¾	32 ½	4	3	1	40C432TKT	\$143
	¾	30	4	3	1	40C430TKT	\$141
	¾	29 ½	4	3	1	40C429TKT	\$139
	¾	27	4	3	1	40C427TKT	\$136
	¾	26 ½	4	3	1	40C426TKT	\$133
	¾	24	4	2	1	40C424TKT	\$132
	¾	23 ½	4	2	1	40C423TKT	\$130
	¾	21	4	2	1	40C421TKT	\$128
	¾	20 ½	4	2	1	40C420TKT	\$127
	¾	18	4	2	1	40C418TKT	\$125
	¾	17 ½	4	2	1	40C417TKT	\$123
	¾	15	4	2	1	40C415TKT	\$121
¾	14 ½	4	2	1	40C414TKT	\$120	
¾	12	4	2	1	40C412TKT	\$118	
¾	11 ½	4	1	1	40C411TKT	\$116	

Specify: Model | Chassis Laminate

Removable Drawer Liner	15 7/8	15 ¼	3	1	2	40CDBL244	\$145
	15 7/8	21 ¼	3	1	2	40CDBL184	\$131

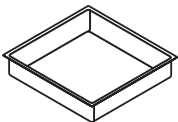

Specify: Model

Model Chassis Laminate
[see Forge Laminate Finishes](#)



Formica Laminate

Forge offers an extensive program for laminates beyond our Standard Program. Always reference below the most current listing and tier pricing when using a Graded-In Laminate; on page 108 select the color of the PVC edge color.

Laminate	Pattern-Sheen	Tier	Laminate	Pattern-Sheen	Tier	Laminate	Pattern-Sheen	Tier	Laminate	Pattern-Sheen	Tier
Acajou Mahogany	7008-58	2	Dark Chocolate	2200-58	2	Mission White	933-58	2	Smoke Onyx	3710-58	2
Aged Ash	8844-58	2	Denim	8822-58	2	Mocha Travertine	3456-58	2	Smoke Quarstone	6220-58	2
Algae	8796-58	2	Desert Beige	899-58	2	Mojave	8751-58	2	Smokey Brown Pear	5488-58	2
Almond	920-58	2	Dover White	7197-58	2	Moonstone	7872-58	2	Solar Orange	8235-58	2
Aluminum	9318-58	2	Earth	5342-58	2	Mouse	928-58	2	Sorrel Cherry	5886-58	2
Amber Kashmir	6227-58	2	Earth Wash	7213-58	2	Muslin Fabric	6127-58	2	Spectrum Blue	851-58	2
Amber Maple	7012-58	2	Earthen Twill	8828-58	2	Natural Ash	8843-58	2	Spectrum Green	7897-58	2
Antique White	932-58	2	Earthen Warp	5880-58	2	Natural Birch	7481-58	2	Spectrum Red	845-58	2
Argento Romano	6697-58	2	Earthenware	8241-58	2	Natural Canvas	7022-58	2	Stainless	9319-58	2
Artichoke	800-58	2	Earthenware	6999-58	2	Natural Gray Felt	4971-58	2	Star Dune	9309-58	2
Ashwood Beige	5785-58	2	Brushstroke		2	Natural Maple	756-58	2	Starched Paperfold	8678-58	2
Ashwood Bone	5784-58	2	Ebony	9012-58	2	Natural Oak	346-58	2	Stone Grafix	503-58	2
Ashwood Oak	5786-58	2	Ebony Oxide	299-58	2	Natural Recycled Kraft	9684-58	2	Stop Red	839-58	2
Basalt Slate	3690-58	2	Elemental Concrete	8830-58	2	Natural Riftwood	9282-58	2	Storm	912-58	2
Beige Elm	5794-58	2	Elemental Stone	8831-58	2	Natural Teak	8849-58	2	Storm Solidz	3505-58	2
Belmonte Granite	3496-58	2	Espresso Pear	5489-58	2	Navy Blue	969-58	2	Storm Teakwood	8908-58	2
Birchbark	8684-58	2	Finnish Oak	118-58	2	Navy Grafix	7018-58	2	Sugar Glass	3705-58	2
Black	909-58	2	Flax Gauze	7708-58	2	Neo Cloud	6314-58	2	Surf	923-58	2
Black Bardiglio	5019-58	2	Flint Crystal	3518-58	2	Neutral Twill	8826-58	2	Swede Rift Oak	8676-58	2
Black Birchply	8552-58	2	Fog	961-58	2	Neutral Weft	5875-58	2	Taupe Walnut	5787-58	2
Black Recycled Kraft	9685-58	2	Folkstone	927-58	2	Neutral White	918-58	2	Terril	2297-58	2
Black Riftwood	6414-58	2	Folkstone Celesta	692-58	2	New Burgundy	7966-58	2	Thermo Walnut	6402-58	2
Black Shalestone	9527-58	2	Folkstone Grafix	507-58	2	Night Forest	8244-58	2	Travertine	3526-58	2
Black Walnut	3485-58	2	Formal Walnut	5782-58	2	Night Shade	8243-58	2	Tula Oak	8589-58	2
Blackened Fiberwood	8916-58	2	Fossil	5349-58	2	Noble Mahogany	9236-58	2	Venetian Gold Granite	6223-58	2
Blackened Legno	8848-58	2	Fox Teakwood	8907-58	2	Nocturne	5323-58	2	Vibrant Green	6901-58	2
Blackened Steel	8918-58	2	Geriba Gray	9308-58	2	Noir Cedar	1547-58	2	Walnut Butcherblock	3712-58	2
Blackstone	271-58	2	Ginger Root Maple	7288-58	2	Noir Envision	7500-58	2	Walnut Fiberwood	8915-58	2
Bleached Legno	8845-58	2	Glamour Cherry	6208-58	2	Nut Brown Cherry	5790-58	2	Walnut Riftwood	9283-58	2
Blond Cedar	8576-58	2	Glass Cloth	8683-58	2	Oiled Legno	8846-58	2	Walnut Softwood	4925-58	2
Blossom Cherrywood	758-58	2	Gold Braze	1193-58	2	Oiled Walnut	5487-58	2	Washi Paperfold	8680-58	2
Blue Felt	9320-58	2	Graphite	837-58	2	Orange Felt	4973-58	2	Waxed Maple	8905-58	2
Blush	8238-58	2	Graphite Elm	5796-58	2	Origami Paperfold	8679-58	2	Weathered Ash	8842-58	2
Brazilian Brown Granite	6222-58	2	Graphite Grafix	515-58	2	Otter	3202-58	2	Weathered Fiberwood	8914-58	2
Brite White	459-58	2	Graphite Twill	8829-58	2	Oxidized Beamwood	9484-58	2	Wenge Strand	6306-58	2
Bronzed Steel	8919-58	2	Gray Fabric	6129-58	2	Oyster Grey	929-58	2	Wheat Strand	6212-58	2
Bubble Art	8958-58	2	Gray Grafix	9300-58	2	Pale Brushstroke	6997-58	2	White	949-58	2
Buff Elm	5793-58	2	Gray Onyx	7409-58	2	Paloma Polar	6698-58	2	White Ash	8841-58	2
Burnished Coin	3708-58	2	Grayed Oak	5791-58	2	Patine Bronze	3707-58	2	White Bardiglio	9306-58	2
Burnished Iron	3709-58	2	Graystone	464-58	2	Patine Concrete	3706-58	2	White Drops	8824-58	2
Burnt Strand	6307-58	2	Green Felt	4974-58	2	Pearl	934-58	2	White Ice Granite	9476-58	2
Butterum Granite	7732-58	2	Green Slate	8793-58	2	Pecan Walnut	6996-58	2	White Marble	9310-58	2
Camel Elm	5795-58	2	Greige Softwood	4924-58	2	Pecan Woodline	5883-58	2	Herringbone		2
Cardboard Solidz	7813-58	2	Gull Grey	9242-58	2	Pencil Wood	7747-58	2	White Onyx	827-58	2
Carrara Bianco	6696-58	2	Hard Rock Maple	86992-58	2	Perlato Granite	3522-58	2	White Painted Wood	8902-58	2
Carrara Envision	7494-58	2	Hazel Walnut	5788-58	2	Planked Coffee Oak	7413-58	2	White Pearl Cascade	3720-58	2
Cascara Teakwood	8909-58	2	Ice Onyx	7408-58	2	Planked Deluxe Pear	6206-58	2	White Shalestone	9525-58	2
Cassis	6903-58	2	Inked Oak	5792-58	2	Planked Raw Oak	7412-58	2	White Twill	9285-58	2
Ceruse Gray Walnut	6994-58	2	Ivory Kashmir	6226-58	2	Planked Urban Oak	9312-58	2	White Washed	6372-58	2
Chambray Fabric	6130-58	2	Jadeite	1198-58	2	Platinum	902-58	2	Birchply		2
Charcoal Boomerang	6942-58	2	Jamocho Granite	7734-58	2	Portico Marble	7735-58	2	Wild Cherry	5904-58	2
Chelsea Maple	9238-58	2	Just Rose	8858-58	2	Prestige Walnut	6209-58	2	Winter Sky	8792-58	2
Cherry Heartwood	9240-58	2	Labrador Granite	3692-58	2	Pumice	858-58	2	Wood Brushstroke	6998-58	2
Cherry Walnut	6995-58	2	Layered Black Sand	9510-58	2	Purple Dye	1196-58	2	Woolen Cloth	8682-58	2
Chestnut Woodline	5884-58	2	Layered Sand	9511-58	2	Raw Birchply	8910-58	2	Yellow Felt	4972-58	2
Chrome Yellow	1485-58	2	Layered White Sand	9512-58	2	Raw Cedar	1545-58	2			
Cinnamon Cherry	8955-58	2	Lime Stone	7264-58	2	Sail White	463-58	2			
Citadel	1097-58	2	Liquid Glass	8240-58	2	Sand Crystal	3517-58	2			
Citadel Warp	5882-58	2	Luxe Mango	8685-58	2	Sand Maple	9237-58	2			
Classic White	9244-58	2	Macchiato Walnut	6932-58	2	Sarum Grey	2770-58	2			
Clementine	2962-58	2	Maple Woodline	6925-58	2	Sarum Twill	8827-58	2			
Clove Spice Cherry	5789-58	2	Marine Blue	914-58	2	Scandi Rift Oak	8677-58	2			
Cocoa Maple	7739-58	2	Marmara Beige	7406-58	2	Sea Salt	9529-58	2			
Cocoa Oak	9374-58	2	Marmara Gray	7407-58	2	Seasoned Planked Elm	6477-58	2			
Cognac Maple	7738-58	2	Matrix Blue	8795-58	2	Select Cherry	7759-58	2			
Concrete Formwood	6362-58	2	Mdf Solidz	7812-58	2	Sheer Fabric	6126-58	2			
Concrete Stone	7267-58	2	Midnight Stone	6280-58	2	Silver Quartzite	9497-58	2			
Cotton Cloth	8681-58	2	Milk	9634-58	2	Silver Riftwood	6413-58	2			
Cream Softwood	4923-58	2	Millennium Oak	5887-58	2	Silver Shalestone	9307-58	2			
Danish Maple	8906-58	2	Mineral Jet	3450-58	2	Slate Noir	3711-58	2			
			Mineral Spa	6920-58	2	Smoke	3245-58	2			

Wilsonart Laminate

Forge offers an extensive program for laminates beyond our Standard Program. Always reference below the most current listing and tier pricing when using a Graded-In Laminate; see below on the PVC edge color selection.

Laminate	Pattern-Sheen	Tier	Laminate	Pattern-Sheen	Tier	Laminate	Pattern-Sheen	Tier	Laminate	Pattern-Sheen	Tier
Almond Leather	2932-60	2	Florence Walnut	7993-38	2	Lowell Ash	7994-38	2	Port	D14-60	2
Anitque White	1572-60	2	Fonthill Pear	10745-60	2	Mangalore Mango	7984-38	2	Pressed Linen	4991-38	2
Anzio Marble	5037-38	2	Forged Steel	4995-60	2	Manitoba Maple	7911-60	2	Raw Cotton	4947-38	2
Atlantis	D25-60	2	Fossil Shale	D504-60	2	Midnight	D505-60	2	River Cherry	7937-38	2
Bannister Oak	7806-60	2	French Linen	5016-38	2	Mission Maple	7990-38	2	Rustic Slate	4888-38	2
Beige	1530-60	2	French Pear	8220-38	2	Misted Zephyr	4843-60	2	Sable Soapstone	4883-38	2
Beigewood	7850-60	2	Frosty White	1573-60	2	Monticello Maple	7925-38	2	Sap Walnut	8221-38	2
Boardwalk Oak	7983-38	2	Fusion Maple	7909-60	2	Morelia Maple	7985-38	2	Shadow Zephyr	4857-60	2
Brazilwood	7946-38	2	Graphite	10657-60	2	Morro Zephyr	4846-60	2	Sheer Mesh	4876-38	2
Brittany Blue	D321-60	2	Graphite Nebula	4623-60	2	Natural Almond	D30-60	2	Sierra Cascade	5005-38	2
Bronze Legacy	4656-60	2	Green Tigris	4667-60	2	Natural Cotton	4946-38	2	Silicon Ev	4811-60	2
Buka Bark	7982-38	2	Grey	1500-60	2	Natural Recon	7996-38	2	Solar Oak	7816-60	2
Burnished Chestnut	4796-60	2	Grey Glace	4142-60	2	Natural Rift	7954-38	2	Steel Mesh	4879-38	2
Candy Apple	13096-60	2	Grey Mesh	4877-38	2	Natural Tigris	4669-60	2	Sterling Ash	7995-38	2
Canyon Zephyr	4842-60	2	Grey Nebula	4622-60	2	Navy Legacy	4651-60	2	Sunny Side Up	13089-60	2
Carbon Ev	4820-60	2	Grey Pampas	4168-60	2	Neo Walnut	7991-38	2	Tailored Linen	4992-38	2
Carbon Mesh	4880-60	2	Gumball	13102-60	2	Neutral Glace	4143-60	2	Titanium EV	4810-60	2
Castle Oak	7928-38	2	Handspun Chestnut	5036-38	2	New Age Oak	7938-38	2	Tungsten EV	4814-60	2
Casual Linen	4944-38	2	Handspun Dove	5034-38	2	Nordic Linen	5015-38	2	Tuscan Walnut	7921-38	2
Catalina	13092-60	2	Handspun Pearl	5033-38	2	Nori	13091-60	2	Twilight Zephyr	4845-60	2
Cement	D503-60	2	Hanspun Slate	5035-38	2	North Sea	D90-60	2	Wallaby	D439-60	2
Centizo Cherry	8239-38	2	Harvest Maple	7953-38	2	Norwegian Ash	8241-38	2	Washi Crystal	5017-38	2
Classic Linen	4843-38	2	high Rise	4996-38	2	Oiled Soapstone	4882-38	2	Washi Pewter	5018-38	2
Cloud Nebula	4830-60	2	Hollyberry	D307-60	2	Orange Grove	D501-60	2	White	1570-60	2
Cloud Zephyr	4856-60	2	Huntington Mplae	7929-38	2	Organic Cotton	4945-38	2	White Carrara	4924-38	2
Coffee Bean	D495-60	2	Indigo	D379-60	2	Palisades Oak	7987-38	2	White Cascade	5003-38	2
Crisp Linen	4942-38	2	Invoy Birch	8219-38	2	Pampas	4170-60	2	White Nebula	4621-60	2
Crystal	D388-60	2	Jubilee Oak	8242-38	2	Pasadena Oak	7966-38	2	White Sand	D403-60	2
Desert Zephyr	4841-60	2	Kensington Maple	10776-60	2	Pearl Soapstone	4886-38	2	White Tigris	4783-60	2
Dove Grey	D92-60	2	Khaki Brown	D50-60	2	Pepperdust	D327-60	2	Wild Cherry	7054-60	2
Dragon Fly	13088-60	2	Kingswood Walnut	8218-38	2	Pewter	D73-60	2	Windswept Pewter	4795-60	2
Ebony Recon	7997-38	2	Lapis Blue	D417-60	2	Pewter Brush	4779-60	2	Woolamai Brush	4746-60	2
Evening Tigris	4674-60	2	Limber Maple	10734-60	2	Pewter Mesh	4878-38	2			
Fashion Grey	D381-60	2	Linen	D427-60	2	Pinnacle Walnut	7992-38	2			
Flax Linen	4930-38	2	Loden Zephyr	4844-60	2	Platinum	D315-60	2			

PVC Edge Selection

Tier 2 and 3 Laminates require the additional specification of a PVC edge band. Choose from one of the following JSI standard options.

ALB	Alabaster	MES	Mesa
BEL	Belair	MIN	Mineral
BLK	Black	MCH	Mocha
BRK	Brickdust	OBK	Outback
BBL	Bridal Blanco	PIL	Pilsner
CSK	Cask	PIN	Pinnacle Walnut
CLY	Clay	SHD	Shadow
DWH	Designer White	SLG	Slate Grey
EGR	Egret	UMB	Umber
FAW	Fawn	VAL	Valley
FLN	Flint	WLH	Walnut Heights
FLO	Florence Walnut	WEA	Weathered Ash
LOF	Loft	ZEN	Zen Grey

Wilsonart Solid Surface

Forge offers an extensive program for Solid Surface beyond our Standard Program. Always reference below the most current listing and tier pricing when using a Graded-In Solid Surface.

Solid Surface	Pattern	Tier	Solid Surface	Pattern	Tier
Angel Falls	9223SS	3	Silver Smoke	9226SS	3
Antique White	1572SL	2	Steel Grey Tempest	9194TM	2
Arctic Drift	9246SS	3	Titanium Grey	9222SS	2
Arctic Dune	9253CM	3	Tumbled Stone	9220CE	3
Arctic Melange	9070ML	2	Whisper White	9237SS	3
Aspen Quartzite	9245SS	3	White Stone	9208CS	3
Avalanche Melange	9175ML	2	Whitewater	9198EA	3
Baja Melange	9030ML	2	Yukon Riverstone	9196RS	2
Basalt Concrete	9254SS	3	Zen Grey	9115GS	2
Beachfront	9233SS	2			
Beige Tempest	1530TM	2			
Beige Travertine	9236SS	3			
Bluestone	9074EA	3			
Brooklyn Concrete	9219GS	2			
Calacatta Perlato	9913SS	3			
Calming Waves	9240SS	3			
Cannon Beach	9250SS	2			
Caramel Melange	9033ML	2			
Carbone Marmo	9914SS	3			
Carrara Emporio	9909SS	3			
Cashmere Mirage	9135MG	2			
Chai Cream Mirage	9111MG	2			
Chicory Cream	9047ML	2			
Melange					
Chilled Earth	9228SS	2			
Cloud Mist	9243SS	3			
Coconut Oil	9100GS	2			
Cool Basalt	9251SS	2			
Cream Swirl	9242SS	3			
Dusk Ice	9203CE	3			
Europa	9210CM	3			
Flint Rock	9207CS	3			
French Blue Melange	9024ML	2			
Frosty White	1573SL	2			
Frosty White Mirage	1573MG	2			
Gold Glitz	9108CS	3			
Golden Sail	9234SS	3			
Grey Beola	9218CM	3			
Grey Lace	9224SS	3			
Gulf Coast	9239SS	3			
Hidden Space	9227SS	2			
Ice Statuario	9912SS	3			
Iron Falls	9238SS	3			
Jovian	9211CM	3			
Kimberlite	9215CE	3			
Luminous White	9221SP	2			
Mansoned Concrete	9252SS	3			
Maple Harvest	9106CS	3			
Marzipan Mirage	9130MG	2			
Metro Concrete	9249SS	2			
Midnight Frost	9244SS	3			
Midnight Melange	9091ML	2			
Milk Glass Spectra	9077ST	2			
Mink Concrete	9248SS	2			
Monte Amiata	9911SS	3			
Moon Geyser	9209CM	3			
Morning Ice	9204CE	3			
Mystique	9200CS	3			
Night Stars	9105CS	3			
Northern Melange	9195ML	2			
Oatmeal	9101GS	2			
Paris Fog	9110CS	3			
Peace Grey	9232SS	2			
Pearl Mirage	9199MG	2			
Pebble	9036EA	3			
Powder White	9230SS	2			
Quarry Melange	9041ML	2			
Quiet Swirl	9241SS	3			
Relaxed White	9247SS	2			
Saharan Night	9225SS	3			
Sea Stone	9202CS	3			

Corian Solid Surface

Forge offers an extensive program for Solid Surface beyond our Standard Program. Always reference below the most current listing and tier pricing when using a Graded-In Solid Surface.

Solid Surface	Pattern	Tier	Solid Surface	Pattern	Tier
Abalone	COR-ABA	3	Sahara	COR-SAH	4
Antarctica	COR-ANT	3	Sand Storm	COR-SST	4
Archeologic	COR-ARC	3	Sandalwood	COR-SDL	4
Arctic Ice	COR-AIC	4	Sandstone	COR-SAN	3
Arrowroot	COR-ARR	4	Savannah	COR-SAV	4
Artista Beige	COR-ABE	3	Sepia Linear	COR-SLI	4
Artista Canvas	COR-ACA	3	Serene Sage	COR-SSA	4
Artista Dust	COR-ADU	3	Silt	COR-SIL	3
Artista Gray	COR-AGR	3	Silver Birch	COR-SBI	4
Ash Aggregate	COR-AAG	4	Silver Gray	COR-SGR	2
Ash Concrete	COR-ACO	4	Silver Linear	COR-SLN	4
Aurora	COR-AUR	3	Silverite	COR-SLV	4
Bisque	COR-BIS	2	Smoke Drift Prima	COR-SDP	4
Bleached NuWood	COR-BNU	4	Sorrel	COR-SOR	4
Bone	COR-BON	2	Sparkling Granita	COR-SPG	4
Cameo White	COR-CWH	2	Sparkling White	COR-SWH	3
Canvas	COR-CNV	4	Stonique	COR-STO	3
Canyon	COR-CAN	3	Vanilla	COR-VAN	2
Carbon Aggregate	COR-CAG	4	Venaro White	COR-VWH	4
Carbon Concrete	COR-CCO	4	Verdant	COR-VER	4
Carrara Crema	COR-CCR	4	Weathered Aggregate	COR-WAG	4
Carrara Lino	COR-CLI	4	Weathered Concrete	COR-WCO	4
Cirrus White	COR-CIW	4	Whipped Cream	COR-WCR	4
Clam Shell	COR-CSH	4	Whisper	COR-WHI	4
Concrete	COR-CON	4	White Jasmine	COR-WJA	4
Cosmos Prima	COR-CPR	4	White Onyx	COR-WON	4
Deep Anthracite	COR-DAN	4	Willow	COR-WIL	4
Deep Black Quartz	COR-DBQ	4	Windswept Prima	COR-WPR	4
Deep Cloud	COR-DCL	4	Witch Hazel	COR-WHA	4
Deep Espresso	COR-DES	4			
Deep Mink	COR-DMI	4			
Deep Night Sky	COR-DNS	4			
Deep Nocturne	COR-DNO	4			
Deep Sable	COR-DSA	4			
Deep Storm	COR-DST	4			
Deep Titanium	COR-DTI	4			
Designer White	COR-DWH	3			
Doeskin	COR-DOE	4			
Domino Terrazzo	COR-DTE	4			
Dove	COR-DOV	3			
Dune Prima	COR-DPR	4			
Elegant Gray	COR-EGR	3			
Evening Prima	COR-EPR	4			
Everest	COR-EVE	3			
Excavage	COR-EXC	3			
Glacier Ice	COR-GIC	3			
Glacier White	COR-GWH	2			
Gray Onyx	COR-GON	4			
Hazelnut	COR-HAZ	4			
Hot	COR-HOT	4			
Juniper	COR-JUN	4			
Laguna	COR-LAG	4			
Laguna Terrazzo	COR-LTE	4			
Lava Rock	COR-LRO	4			
Limestone Prima	COR-LPR	4			
Linen	COR-LIN	2			
Matterhorn	COR-MAT	3			
Modern White	COR-MWH	3			
Natural Gray	COR-NGR	4			
Neutral Aggregate	COR-NAG	4			
Neutral Concrete	COR-NCO	3			
Nimbus Prima	COR-NPR	4			
Pearl Gray	COR-PGR	2			
Pebble Lane	COR-PLA	3			
Peppered Terrazzo	COR-PTE	4			
Platinum	COR-PAT	4			
Provence NuWood	COR-PNU	4			
Rain Cloud	COR-RCL	4			
Rice Paper	COR-RPA	4			
Rosemary	COR-ROS	4			
Sagebrush	COR-SAG	4			