

**Conference - Table of Contents**



**Lok - Conference**

**Product Information**

Conference Overview . . . . . 170  
 Tables Shapes & Sizes . . . . . 176-177  
 Laminate Specifications . . . . . 173  
 Veneer Specifications . . . . . 174  
 Solid Surface Specifications . . . . . 174  
 Base Styles - Features . . . . . 178  
 Electrical Planning - Options . . . . . 179-181

**Pricing Pages**

Conference Tables at Working Height . 182-295  
 Conference Tables at Counter Height . 296-349  
 Conference Tables at Bar Height . . . 350-403  
 Credenzas . . . . . 404-407  
 Electrical . . . . . 408-409

## Conference - Overview



rectangular  
29"H - Pages 222, 224, 226,  
234, 236, 238  
36"H - Pages 334, 338  
42"H - Pages 386, 390



rounded rectangular  
29"H - Pages 228, 230, 232,  
240, 242, 244  
36"H - Pages 336, 340  
42"H - Pages 388, 392

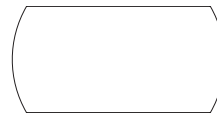

arc rectangular  
29"H - Pages 246, 248, 250  
258, 260, 262  
36"H - Pages 342, 346  
42"H - Pages 394, 398



rounded arc rectangular  
29"H - Pages 252, 254, 256  
264, 266, 268  
36"H - Pages 344, 348  
42"H - Pages 396, 400

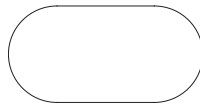

racetrack  
29"H - Pages 270, 272, 274  
36"H - Pages 350  
42"H - Pages 402



oval  
29"H - Pages 276, 278  
36"H - Pages 352  
42"H - Pages 404

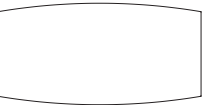

boat  
29"H - Pages 280, 282, 284  
292, 294, 296  
36"H - Pages 354, 356  
42"H - Pages 406, 408

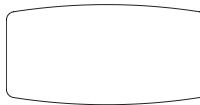

rounded boat  
29"H - Pages 286, 288, 290

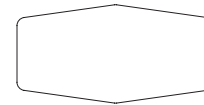

rounded double chevron  
29"H - Pages 298, 300  
36"H - Pages 358, 360  
42"H - Pages 410, 412

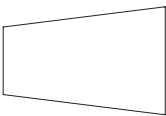

taper  
29"H - Pages 302, 304, 310, 312  
36"H - Pages 362, 366  
42"H - Pages 414, 418

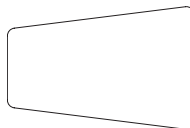

rounded taper  
29"H - Pages 306, 308, 314, 316  
36"H - Pages 364, 368  
42"H - Pages 416, 420

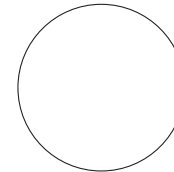

round  
29"H - Pages 318, 320  
36"H - Pages 370, 372  
42"H - Pages 422, 424

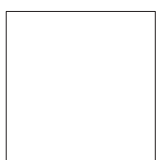

square  
29"H - Pages 322, 326  
36"H - Pages 374, 378  
42"H - Pages 426, 430

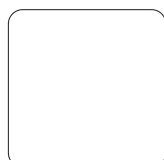

rounded square  
29"H - Pages 324, 328  
36"H - Pages 376, 378  
42"H - Pages 428, 432

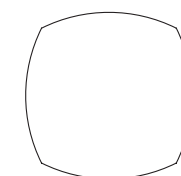

squircle  
29"H - Pages 330, 332  
36"H - Pages 382, 384  
42"H - Pages 434, 436

## Conference - Materials

### Laminate Tops

Lok conference table worksurfaces are offered in HPL (High Pressure Laminate) The tops are 1 3/16" thick, 3 ply balanced construction. Particle board core and a phenolic backer sheet complete the balanced construction.

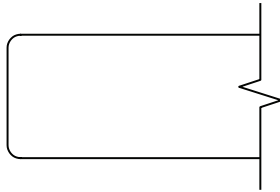

**Eased Edge (R3)**  
PVC

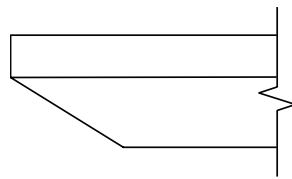

**Reverse Bevel (K9)**  
PVC on painted top of painted MDF

### Standard PVC Edge Colors

JSI supports 26 standard PVC edge colors listed below. These coordinate with our Standard (Tier1) Laminates.

When selecting a Standard (Tier 1) Laminate, the coordinating PVC edge color is automatically applied. When selecting a Graded-In Laminate (Tier 2 or 3), you will be prompted to choose one these 26 PVC edge colors to be applied to the edge.

<b>ALB</b> Alabaster	<b>MES</b> Mesa
<b>BEL</b> Belair	<b>MIN</b> Mineral
<b>BLK</b> Black	<b>MCH</b> Mocha
<b>BRK</b> Brickdust	<b>OBK</b> Outback
<b>BBL</b> Bridal Blanco	<b>PIL</b> Pilsner
<b>CSK</b> Cask	<b>PIN</b> Pinnacle Walnut
<b>CLY</b> Clay	<b>SHD</b> Shadow
<b>DWH</b> Designer White	<b>SLG</b> Slate Grey
<b>EGR</b> Egret	<b>UMB</b> Umber
<b>FAW</b> Fawn	<b>VAL</b> Valley
<b>FLN</b> Flint	<b>WAL</b> Walnut Heights
<b>FLO</b> Florence Walnut	<b>WEA</b> Weathered Ash
<b>LOF</b> Loft	<b>ZEN</b> Zen Grey

### Standard Laminates

JSI Standard Laminate program consists of 26 solid and wood grain patterns, and establish our Tier 1 laminate pricing. Each has a coordinating PVC edge color that is automatically used with the Standard Laminates.

#### Wood Grain Laminate

<b>BEL</b> Belair	<b>MIN</b> Mineral
<b>BRK</b> Brickdust	<b>MCH</b> Mocha
<b>CSK</b> Cask	<b>OBK</b> Outback
<b>CLY</b> Clay	<b>PIL</b> Pilsner
<b>EGR</b> Egret	<b>PIN</b> Pinnacle Walnut
<b>FAW</b> Fawn	<b>UMB</b> Umber
<b>FLN</b> Flint	<b>VAL</b> Valley
<b>FLO</b> Florence Walnut	<b>WAL</b> Walnut Heights
<b>LOF</b> Loft	<b>WEA</b> Weathered Ash
<b>MES</b> Mesa	

#### Solid Laminate

<b>ALB</b> Alabaster
<b>BLK</b> Black
<b>BBL</b> Bridal Blanco
<b>DWH</b> Designer White
<b>SHD</b> Shadow
<b>SLG</b> Slate Grey
<b>ZEN</b> Zen Grey

## Conference - Materials

### Veneer Tops

Tops are 1 3/8" thick, 5 ply balanced construction with particle board core. Standard Tier 1 veneer is essentials, book matched for cherry, maple, walnut and black oak veneer. Standard Tier 2 veneer is artisan.

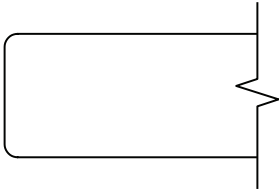

**Eased Edge (R3)**  
Internal Lumber Band

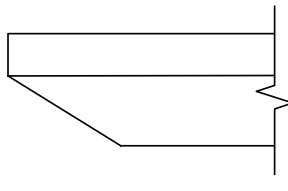

**Reverse Bevel (K9)**  
Veneer Band on Stained MDF

### Finish - Stain/Colors

#### ESS Essentials Veneer Collection

BRK	Brickdust	MIN	Mineral
CSK	Cask	MCH	Mocha
CLY	Clay	OBK	Outback
FAW	Fawn	PIL	Pilsner
FLX	Flax	SIE	Sienna
FLN	Flint	TRF	Truffle
LOF	Loft	UMB	Umber
MES	Mesa	VAL	Valley

#### ART Artisan Veneer Collection

BAR	Barrel	RAV	Raven
BUF	Buff	RYE	Rye
CND	Cinder	SAB	Sable
EGR	Egret	SAD	Saddle

#### Protective Top Coat

DuraTex™ offers exceptional hardness along with abrasion and impact resistance, it has been formulated to eliminate hazardous and harmful gases that are normally associated with wood finish.

#### DuraTex™ Features

**Safety** - Significantly reduces hazardous formaldehyde emissions which help improve the quality of the of the indoor air we breathe.  
**Quality** - Developed to be tough and durable with special attention to appearance. The DuraTex™ finish preserves the natural beauty of wood.  
**Durability** - Designed to meet a wide range of demanding performance and environmental standards to withstand even the highest wear and tear.

#### Finish Sheen

All veneer finishes are standard in 35-sheen, with the exception of Raven. Raven is only offered in 15-sheen. All other finishes can have their sheen modified with a 15% upcharge added to the list price of each item.

#### Custom/Special Finishes

JSI, upon request, will accommodate special finishes. A written request is required to proceed with custom finish orders. A sample reference is required for first-time matches and must be included with the written request.

There is a one-time charge of **\$412 list per order** for any non-standard wood finish.

Orders will be entered noting the special finish. A sample match will be provided to the customer. Written approval is needed before the finish process can be started. Delays in approval may have an impact on lead times.

Every effort will be made to create the requested match; however, an acceptable match may not be possible because of natural variations of wood. These natural variations can also cause minor differences in the final finish product.

Use standard pricing and option pricing for each line item with a special finish, unless additional modifications have been specified. For items available in both Essential and Artisan veneers, apply the Essentials pricing.

### Solid Surface Tops

Tops are 1 3/8" thick constructed of 1/2" thick Solid Surface on top of a 1/4" MDF sub top. Sub top has an under cut bevel profile and is painted in a coordinated color to match the Solid Surface.

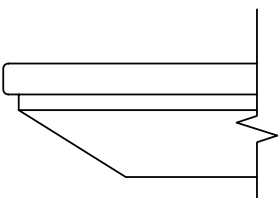

**Reverse Bevel Edge (K7)**  
Solid Surface over painted MDF

#### Standard Solid Surface

<b>ONX</b>	Black Onyx Mirage
<b>DWH</b>	Designer White
<b>HST</b>	Hot Stone
<b>SOG</b>	Soothing Grey

## Conference - Top Shapes

Lok offers 16 conference table top shapes. Tables are available in 29", 36" or 42" high and in laminate, veneer or solid surface. Compatible bases are: X Base, X4 Base, or Y Base.



rectangular

29"h

- 36" x 84" Seats 6
- 36" x 96" Seats 8
- 42" x 84" Seats 6
- 42" x 96" Seats 8
- 48" x 84" Seats 6
- 48" x 96" Seats 8
- 48" x 108" Seats 8
- 48" x 120" Seats 8
- 48" x 144" Seats 12
- 48" x 168" Seats 14
- 48" x 192" Seats 16
- 48" x 216" Seats 18
- 48" x 240" Seats 20
- 54" x 120" Seats 8
- 54" x 144" Seats 12
- 54" x 168" Seats 14
- 54" x 192" Seats 16
- 54" x 216" Seats 18
- 54" x 240" Seats 20
- 60" x 120" Seats 8
- 60" x 144" Seats 12
- 60" x 168" Seats 14
- 60" x 192" Seats 16
- 60" x 216" Seats 18
- 60" x 240" Seats 20

36"h

- 36" x 84" Seats 6
- 36" x 96" Seats 8
- 42" x 84" Seats 6
- 42" x 96" Seats 8
- 48" x 84" Seats 6
- 48" x 96" Seats 8

42"h

- 36" x 84" Seats 6
- 36" x 96" Seats 8
- 42" x 84" Seats 6
- 42" x 96" Seats 8
- 48" x 84" Seats 6
- 48" x 96" Seats 8



rounded rectangular

29"h

- 36" x 84" Seats 6
- 36" x 96" Seats 8
- 42" x 84" Seats 6
- 42" x 96" Seats 8
- 48" x 84" Seats 6
- 48" x 96" Seats 8
- 48" x 108" Seats 8
- 48" x 120" Seats 8
- 48" x 144" Seats 12
- 48" x 168" Seats 14
- 48" x 192" Seats 16
- 48" x 216" Seats 18
- 48" x 240" Seats 20
- 54" x 120" Seats 8
- 54" x 144" Seats 12
- 54" x 168" Seats 14
- 54" x 192" Seats 16
- 54" x 216" Seats 18
- 54" x 240" Seats 20
- 60" x 120" Seats 8
- 60" x 144" Seats 12
- 60" x 168" Seats 14
- 60" x 192" Seats 16
- 60" x 216" Seats 18
- 60" x 240" Seats 20

36"h

- 36" x 84" Seats 6
- 36" x 96" Seats 8
- 42" x 84" Seats 6
- 42" x 96" Seats 8
- 48" x 84" Seats 6
- 48" x 96" Seats 8

42"h

- 36" x 84" Seats 6
- 36" x 96" Seats 8
- 42" x 84" Seats 6
- 42" x 96" Seats 8
- 48" x 84" Seats 6
- 48" x 96" Seats 8



arc rectangular

29"h

- 36" x 84" Seats 6
- 36" x 96" Seats 8
- 42" x 84" Seats 6
- 42" x 96" Seats 8
- 48" x 84" Seats 6
- 48" x 96" Seats 8
- 48" x 108" Seats 8
- 48" x 120" Seats 8
- 48" x 144" Seats 12
- 48" x 168" Seats 14
- 48" x 192" Seats 16
- 48" x 216" Seats 18
- 48" x 240" Seats 20
- 54" x 120" Seats 8
- 54" x 144" Seats 12
- 54" x 168" Seats 14
- 54" x 192" Seats 16
- 54" x 216" Seats 18
- 54" x 240" Seats 20
- 60" x 120" Seats 8
- 60" x 144" Seats 12
- 60" x 168" Seats 14
- 60" x 192" Seats 16
- 60" x 216" Seats 18
- 60" x 240" Seats 20

36"h

- 36" x 84" Seats 6
- 36" x 96" Seats 8
- 42" x 84" Seats 6
- 42" x 96" Seats 8
- 48" x 84" Seats 6
- 48" x 96" Seats 8

42"h

- 36" x 84" Seats 6
- 36" x 96" Seats 8
- 42" x 84" Seats 6
- 42" x 96" Seats 8
- 48" x 84" Seats 6
- 48" x 96" Seats 8



rounded arc rectangular

29"h

- 36" x 84" Seats 6
- 36" x 96" Seats 8
- 42" x 84" Seats 6
- 42" x 96" Seats 8
- 48" x 84" Seats 6
- 48" x 96" Seats 8
- 48" x 108" Seats 8
- 48" x 120" Seats 8
- 48" x 144" Seats 12
- 48" x 168" Seats 14
- 48" x 192" Seats 16
- 48" x 216" Seats 18
- 48" x 240" Seats 20
- 54" x 120" Seats 8
- 54" x 144" Seats 12
- 54" x 168" Seats 14
- 54" x 192" Seats 16
- 54" x 216" Seats 18
- 54" x 240" Seats 20
- 60" x 120" Seats 8
- 60" x 144" Seats 12
- 60" x 168" Seats 14
- 60" x 192" Seats 16
- 60" x 216" Seats 18
- 60" x 240" Seats 20

36"h

- 36" x 84" Seats 6
- 36" x 96" Seats 8
- 42" x 84" Seats 6
- 42" x 96" Seats 8
- 48" x 84" Seats 6
- 48" x 96" Seats 8

42"h

- 36" x 84" Seats 6
- 36" x 96" Seats 8
- 42" x 84" Seats 6
- 42" x 96" Seats 8
- 48" x 84" Seats 6
- 48" x 96" Seats 8



racetrack

29"h

- 36" x 84" Seats 6
- 36" x 96" Seats 8
- 42" x 84" Seats 6
- 42" x 96" Seats 8
- 48" x 84" Seats 6
- 48" x 96" Seats 8
- 48" x 108" Seats 8
- 48" x 120" Seats 8
- 48" x 144" Seats 12
- 48" x 168" Seats 14
- 48" x 192" Seats 16
- 48" x 216" Seats 18
- 48" x 240" Seats 20
- 54" x 120" Seats 8
- 54" x 144" Seats 12
- 54" x 168" Seats 14
- 54" x 192" Seats 16
- 54" x 216" Seats 18
- 54" x 240" Seats 20
- 60" x 120" Seats 8
- 60" x 144" Seats 12
- 60" x 168" Seats 14
- 60" x 192" Seats 16
- 60" x 216" Seats 18
- 60" x 240" Seats 20

36"h

- 36" x 84" Seats 6
- 36" x 96" Seats 8
- 42" x 84" Seats 6
- 42" x 96" Seats 8
- 48" x 84" Seats 6
- 48" x 96" Seats 8

42"h

- 36" x 84" Seats 6
- 36" x 96" Seats 8
- 42" x 84" Seats 6
- 42" x 96" Seats 8
- 48" x 84" Seats 6
- 48" x 96" Seats 8

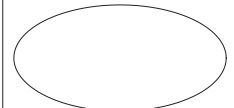

oval

29"h

- 42" x 84" Seats 6
- 48" x 96" Seats 8
- 54" x 108" Seats 8
- 60" x 120" Seats 10

36"h

- 42" x 84" Seats 6
- 48" x 96" Seats 8

42"h

- 42" x 84" Seats 6
- 48" x 96" Seats 8

## Conference - Top Shapes

Lok offers 15 conference table top shapes. Tables are available in 29", 36" or 42" high and in laminate, veneer or solid surface. Compatible bases are: X Base, X4 Base, or Y Base.

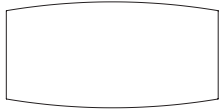

boat

29"h

- 36" x 84" Seats 6
- 36" x 96" Seats 8
- 42" x 84" Seats 6
- 42" x 96" Seats 8
- 48" x 84" Seats 6
- 48" x 96" Seats 8
- 48" x 108" Seats 8
- 48" x 120" Seats 8
- 48" x 144" Seats 12
- 48" x 168" Seats 14
- 48" x 192" Seats 16
- 48" x 216" Seats 18
- 48" x 240" Seats 20
- 54" x 120" Seats 8
- 54" x 144" Seats 12
- 54" x 168" Seats 14
- 54" x 192" Seats 16
- 54" x 216" Seats 18
- 54" x 240" Seats 20
- 60" x 120" Seats 8
- 60" x 144" Seats 12
- 60" x 168" Seats 14
- 60" x 192" Seats 16
- 60" x 216" Seats 18
- 60" x 240" Seats 20

36"h

- 36" x 84" Seats 6
- 36" x 96" Seats 8
- 42" x 84" Seats 6
- 42" x 96" Seats 8
- 48" x 84" Seats 6
- 48" x 96" Seats 8

42"h

- 36" x 84" Seats 6
- 36" x 96" Seats 8
- 42" x 84" Seats 6
- 42" x 96" Seats 8
- 48" x 84" Seats 6
- 48" x 96" Seats 8

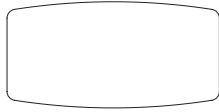

rounded boat

29"h

- 36" x 84" Seats 6
- 36" x 96" Seats 8
- 42" x 84" Seats 6
- 42" x 96" Seats 8
- 48" x 84" Seats 6
- 48" x 96" Seats 8
- 48" x 108" Seats 8
- 48" x 120" Seats 8
- 48" x 144" Seats 12
- 48" x 168" Seats 14
- 48" x 192" Seats 16
- 48" x 216" Seats 18
- 48" x 240" Seats 20
- 54" x 120" Seats 8
- 54" x 144" Seats 12
- 54" x 168" Seats 14
- 54" x 192" Seats 16
- 54" x 216" Seats 18
- 54" x 240" Seats 20
- 60" x 120" Seats 8
- 60" x 144" Seats 12
- 60" x 168" Seats 14
- 60" x 192" Seats 16
- 60" x 216" Seats 18
- 60" x 240" Seats 20

36"h

- 36" x 84" Seats 6
- 36" x 96" Seats 8
- 42" x 84" Seats 6
- 42" x 96" Seats 8
- 48" x 84" Seats 6
- 48" x 96" Seats 8

42"h

- 36" x 84" Seats 6
- 36" x 96" Seats 8
- 42" x 84" Seats 6
- 42" x 96" Seats 8
- 48" x 84" Seats 6
- 48" x 96" Seats 8

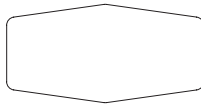

rounded double chevron

29"h

- 36" x 84" Seats 6
- 36" x 96" Seats 8
- 42" x 84" Seats 6
- 42" x 96" Seats 8
- 48" x 84" Seats 6
- 48" x 96" Seats 8

36"h

- 36" x 84" Seats 6
- 36" x 96" Seats 8
- 42" x 84" Seats 6
- 42" x 96" Seats 8
- 48" x 84" Seats 6
- 48" x 96" Seats 8

42"h

- 36" x 84" Seats 6
- 36" x 96" Seats 8
- 42" x 84" Seats 6
- 42" x 96" Seats 8
- 48" x 84" Seats 6
- 48" x 96" Seats 8

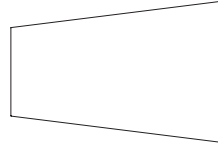

taper

29"h

- 54" x 96" Seats 8
- 60" x 120" Seats 10

36"h

- 54" x 96" Seats 8

42"h

- 54" x 96" Seats 8

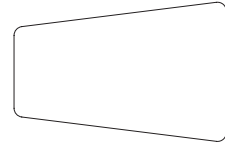

rounded taper

29"h

- 54" x 96" Seats 8
- 60" x 120" Seats 10

36"h

- 54" x 96" Seats 8

42"h

- 54" x 96" Seats 8

## Lok - Top Shapes

Lok offers 15 conference table top shapes. Tables are available in 29", 36" or 42" high and in laminate, veneer or solid surface. Compatible bases are: X Base, X4 Base, or Y Base.

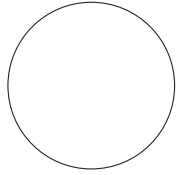

round

29"h

30"	Seats 3
36"	Seats 4
42"	Seats 4
48"	Seats 4
54"	Seats 6
60"	Seats 8

36"h

30"	Seats 3
36"	Seats 4
42"	Seats 4
48"	Seats 4
54"	Seats 6
60"	Seats 8

42"h

30"	Seats 3
36"	Seats 4
42"	Seats 4
48"	Seats 4
54"	Seats 6
60"	Seats 8



square

29"h

30" x 30"	Seats 4
36" x 36"	Seats 4
42" x 42"	Seats 4
48" x 48"	Seats 4
54" x 54"	Seats 6
60" x 60"	Seats 8

36"h

30" x 30"	Seats 4
36" x 36"	Seats 4
42" x 42"	Seats 4
48" x 48"	Seats 4
54" x 54"	Seats 6
60" x 60"	Seats 8

42"h

30" x 30"	Seats 4
36" x 36"	Seats 4
42" x 42"	Seats 4
48" x 48"	Seats 4
54" x 54"	Seats 6
60" x 60"	Seats 8

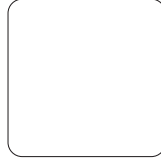

rounded square

29"h

30" x 30"	Seats 4
36" x 36"	Seats 4
42" x 42"	Seats 4
48" x 48"	Seats 4
54" x 54"	Seats 6
60" x 60"	Seats 8

36"h

30" x 30"	Seats 4
36" x 36"	Seats 4
42" x 42"	Seats 4
48" x 48"	Seats 4
54" x 54"	Seats 6
60" x 60"	Seats 8

42"h

30" x 30"	Seats 4
36" x 36"	Seats 4
42" x 42"	Seats 4
48" x 48"	Seats 4
54" x 54"	Seats 6
60" x 60"	Seats 8

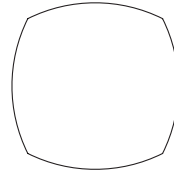

squircle

29"h

30" x 30"	Seats 4
36" x 36"	Seats 4
42" x 42"	Seats 4
48" x 48"	Seats 4
54" x 54"	Seats 6
60" x 60"	Seats 8

36"h

30" x 30"	Seats 4
36" x 36"	Seats 4
42" x 42"	Seats 4
48" x 48"	Seats 4
54" x 54"	Seats 6
60" x 60"	Seats 8

42"h

30" x 30"	Seats 4
36" x 36"	Seats 4
42" x 42"	Seats 4
48" x 48"	Seats 4
54" x 54"	Seats 6
60" x 60"	Seats 8

## Conference - Base Styles

Lok provides a choice selection of bases in both function and aesthetics to serve a variety of needs. The conferencing offering includes: X-Base, Y Base and X4 base.

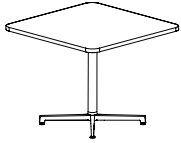

### X-Base

- available 29"h, 36"h or 42"h only in glides.
- compatible with the following top shapes: round, square or squircle
- base finish - select single metal finish or two-tone metal finish. See options listed below.
- power access version, with integrated wire management available with an upcharge

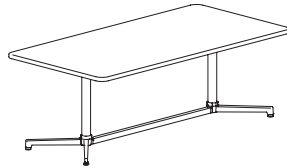

### Y Base

- available in 29"h, 36"h or 42"h only in glides.
- compatible with the following top shapes: arc rectangular, boat, double chevron, oval, racetrack, rectangular, round, square and taper
- base finish - select single metal finish or two-tone metal finish. See options listed below.

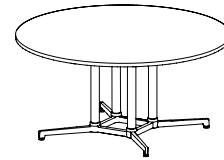

### X4 Base

- available in 29"h, 36"h or 42"h only in glides
- compatible with the following top shapes: round, square, and squircle
- base finish - select single metal finish or two-tone metal finish. See options listed below.

### Single Metal Finish

- ABZ** Aged Bronze Feet & Post
- ASL** Arctic Silver Feet & Post
- GLD** Gold Feet & Post
- PEW** Pewter Feet & Post
- MBK** Matte Black Feet & Post
- SBZ** Soft Bronze Feet & Post
- SNK** Soft Nickel Feet & Post

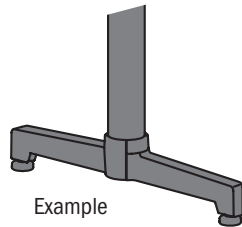

### Two - Tone Metal Finish

Two - Tone Aesthetics can be achieved by specifying Polished Aluminum on the foot and a contrasting finish on the post

#### Polished Aluminum Feet

- ABZ** Aged Bronze Post
- ASL** Arctic Silver Post
- GLD** Gold Post
- PEW** Pewter Post
- MBK** Matte Black Post
- SBZ** Soft Bronze Post
- SNK** Soft Nickel Post

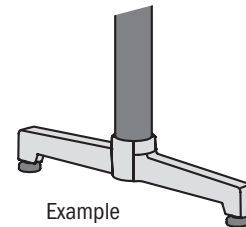

### Power/Charging Options

Lok offers the ability to place power and charging options in the center of select tables. Select your choice of EC23 or EC24, available in black and white.



#### Moire - EC23

- Three 110 outlets
- Dual USB port with 72" power cord
- Black (B) or White (W)

select CTEC23 for cutout in worksurfaces



#### Node - EC24

- One 110 outlet
- Dual USB port with 72" power cord
- Black (B) or White (W)

select CTEC24 for cutout in worksurfaces

Cut outs are located in the center of each table. See below for representation or location.

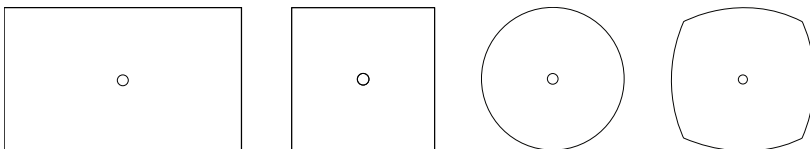

# Lok Product Information

## Electrical Overview

Lok provides several packages to choose from for your electrical needs. Choose solutions for top surface power, underneath outlets, wireless charging, or a combination.

Specifying an electrical package eliminates your need to calculate additional components, as all units and necessary jumpers will ship with your table. You will only need to determine which power in-feed best suits your needs and order separately.

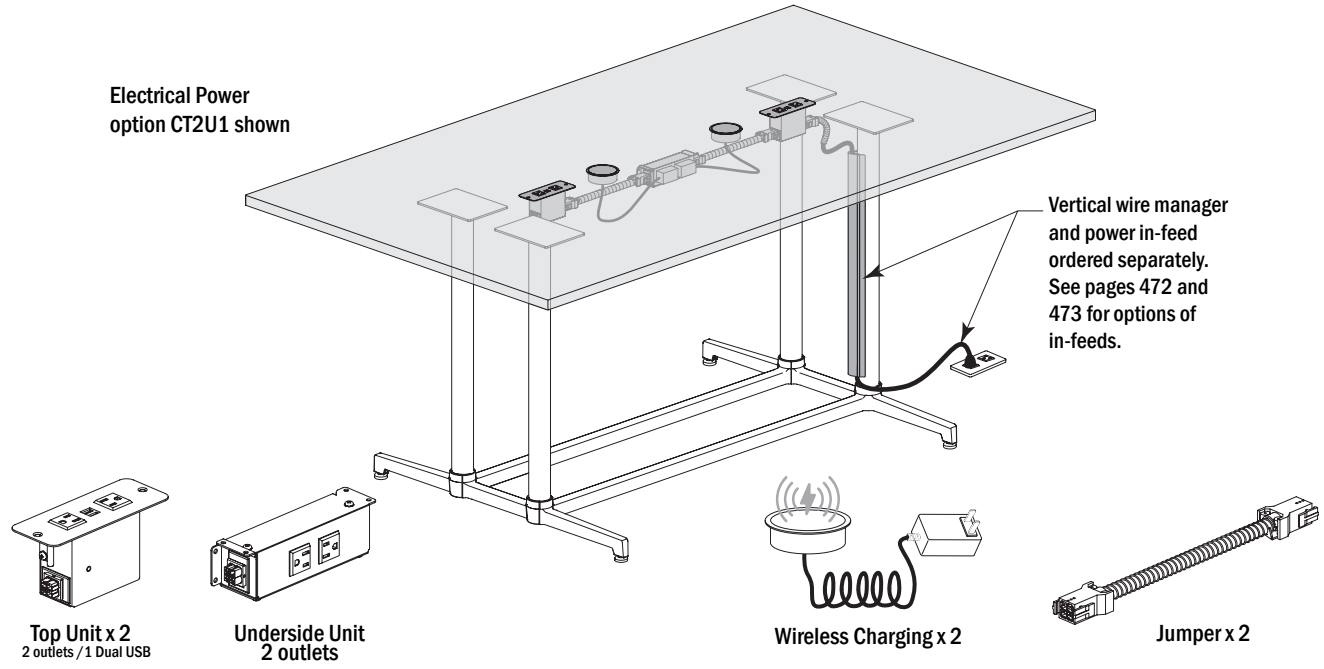

## Electrical - 1 Piece Tops

Power and Charging Packages are measured and located out from the center of the table. Shown on rectangular tops, these dimensions are the same from center regardless of table shape (ie chevron, boat, etc.). Power in-feed is specified separately to support building electrical connection.

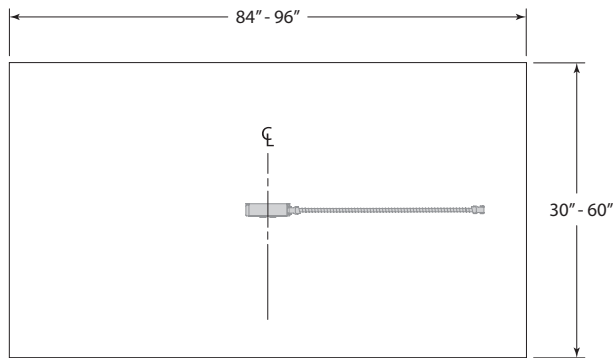

CU1 - Single Power Underside

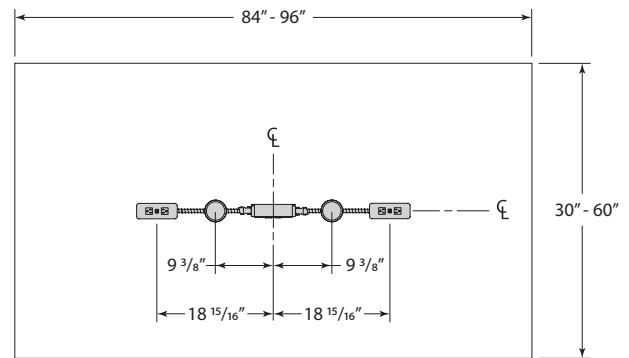

CT2U1 - Dual Power Center Top with Underside and Two Wireless Charging

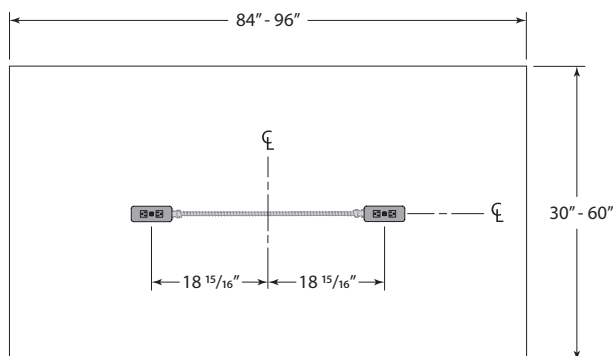

CT2 - Dual Power Center Top

## Conference - Electrical

### Electrical - 2 Piece Tops

Power and Charging Packages are measured and located out from the center of the table. Shown on rectangular tops, these dimensions are the same from center regardless of table shape (ie chevron, boat, etc.). Power in-feed is specified separately to support building electrical connection.

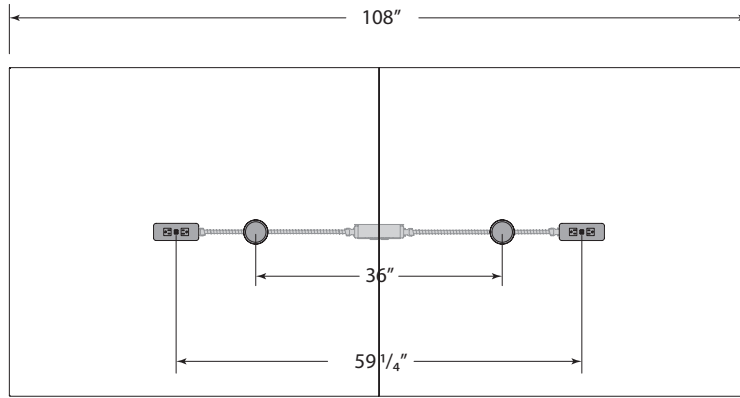

**CT2 - Dual Power Top with Underside and Two Wireless Charging**

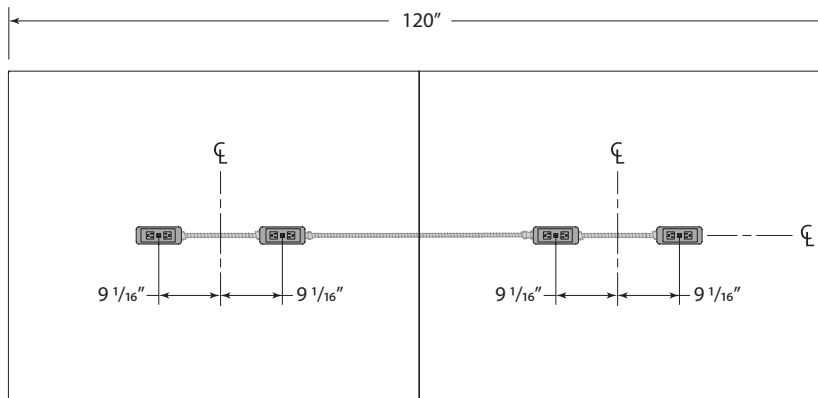

**CT4 - Four Power Top**

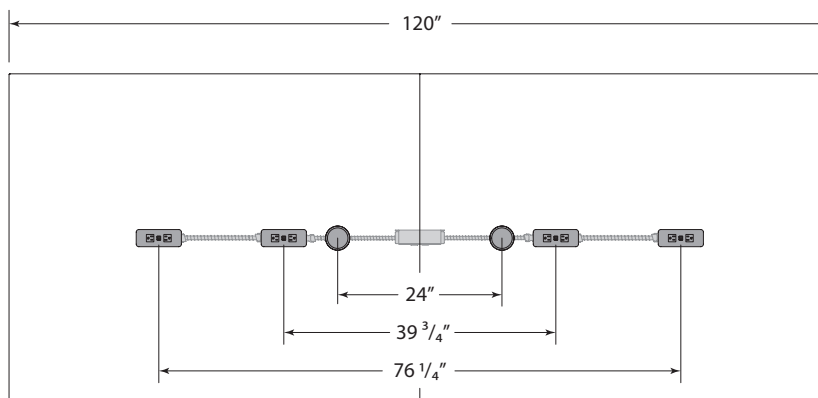

**CT4 - Four Power Top with Underside and Two Wireless Charging**

**Conference - Electrical**

**Electrical - 3 Piece Tops**

Power and Charging Packages are measured and located out from the center of the table. Shown on rectangular tops, these dimensions are the same from center regardless of table shape (ie chevron, boat, etc.). Power in-feed is specified separately to support building electrical connection.

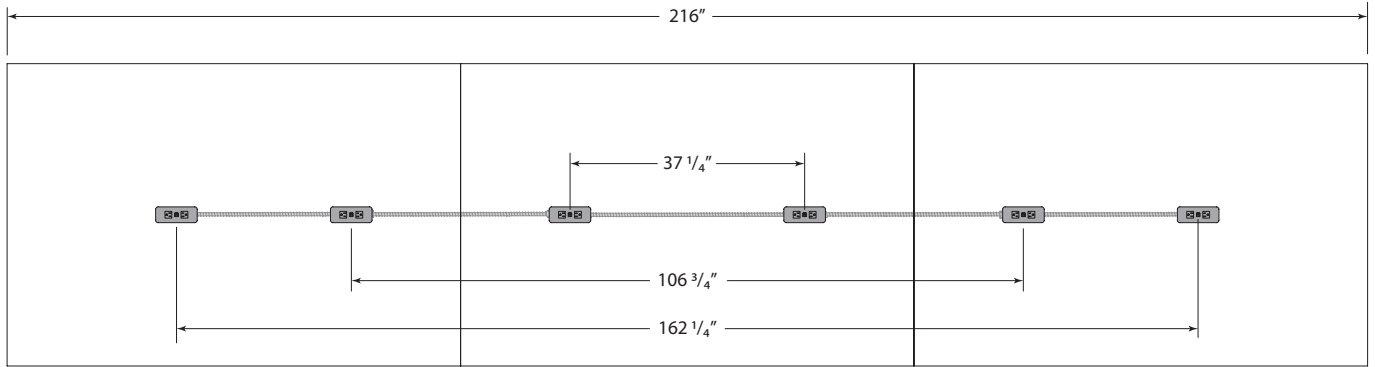

**CT6 - Six Power Top**

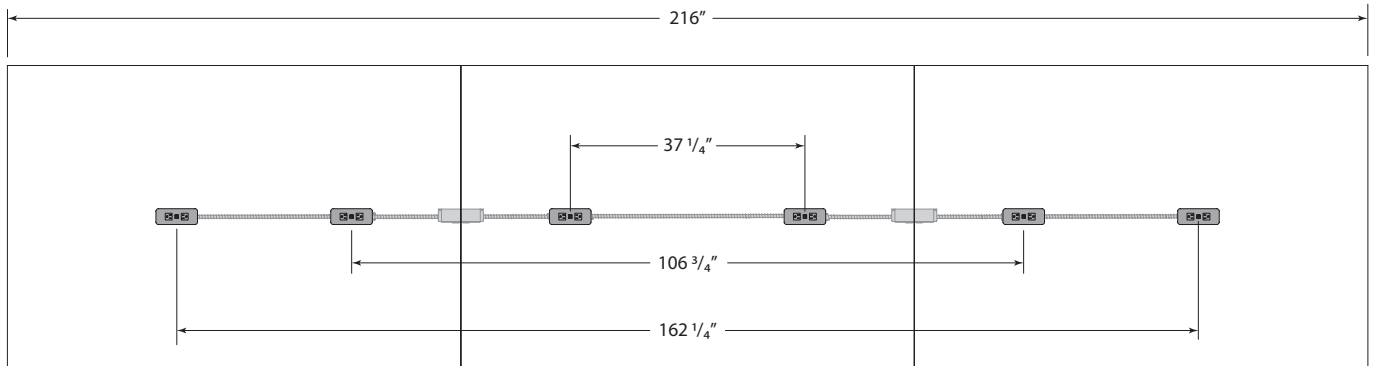

**CT6 - Six Power Top**

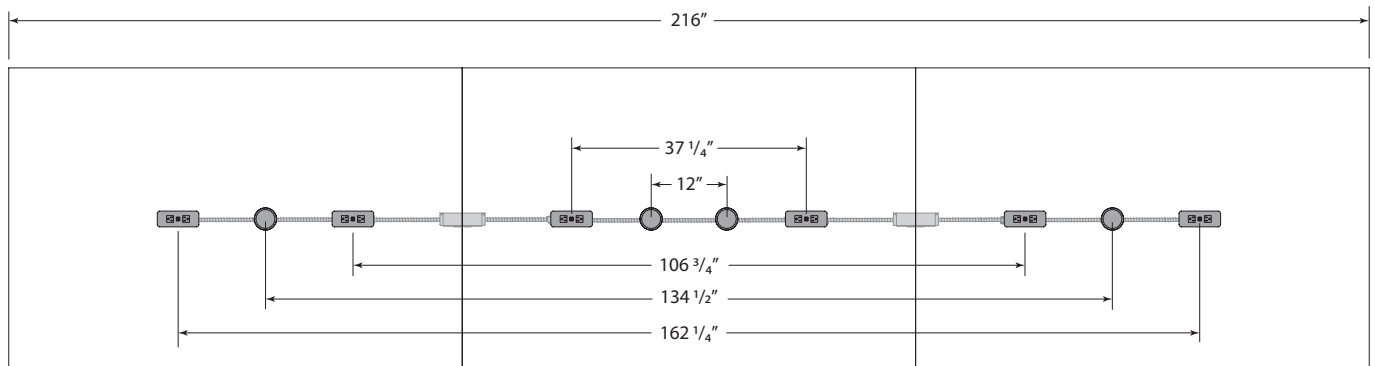

**CT6 - Six Power Top with Dual Underside and Four Wireless Charging**

LOK - CONFERENCE

Description

Rectangular 3pc Table with T Base at Working Height

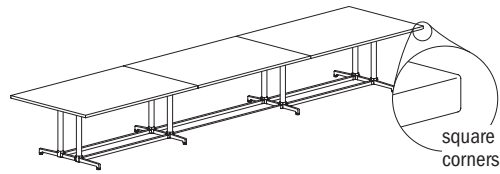

Laminate Tables "LKT" Models

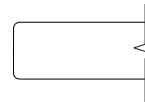

Eased Edge (R3)

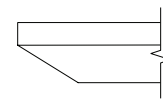

Reverse Bevel Edge (K9)

D	W	H	CTN WT	CU FT	Model	Eased Edge (R3)		Reverse Bevel Edge (K9)	
						Standard Tier 1	Graded In Tier 2	Standard Tier 1	Graded In Tier 2
60	240	29	653	281	LKT60240-29TTT	\$12,049	\$12,247	\$12,887	\$13,083
60	216	29	598	253	LKT60216-29TTT	\$10,110	\$10,285	\$10,908	\$11,084
54	240	29	603	254	LKT54240-29TTT	\$9,695	\$9,872	\$10,488	\$10,666
54	216	29	453	229	LKT54216-29TTT	\$9,123	\$9,283	\$9,885	\$10,043
48	240	29	551	228	LKT48240-29TTT	\$9,245	\$9,403	\$9,997	\$10,154
48	216	29	553	206	LKT48216-29TTT	\$8,709	\$8,851	\$9,433	\$9,575

LAMINATE

Features:

- price reflects complete table - top and base
- ships KD in multiple cartons
- three piece top
- model includes adjustable glide

Options:

- specify power/charging option, see below for options and upcharges



top shape

LOK - CONFERENCE

To Order Specify

1 Laminate Model #	2 Edge Detail	3 Laminate Selection	4 PVC Edge Color	5 Electrical	6 Metal Color
Laminate (LKT)	<a href="#">See Edge Detail Options</a>	<a href="#">See Laminate Selection</a>	<a href="#">See PVC Edge Color Options</a>	N None CT6 Six Power Center Top CU2 Dual Power Underside CT6U2 Six Power Center Top with Underside (See chart on next page)	<a href="#">See Metal Finish Color Options</a>

Model Number Breakdown

LKT60240-29TTT					
LK	T	60240	29	TT	T
LOK	Laminate	60" x 240"	Height	Rectangular Top Shape	T base

Description

Rectangular 3pc Table with T Base at Working Height (continued)

Veneer Tables "LKV" Models

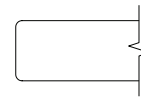

Eased Edge (R3)

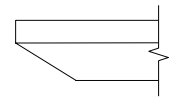

Reverse Bevel Edge (K9)

VENEER	D	W	H	CTN WT	CU FT	Model	Essentials	Artisan	Essentials	Artisan
		60	240	29	653	281	LKV60240-29TTT	\$18,756	\$20,255	\$20,441
	60	216	29	598	253	LKV60216-29TTT	\$16,497	\$17,815	\$17,982	\$19,151
	54	240	29	603	254	LKV54240-29TTT	\$15,866	\$17,179	\$16,631	\$17,877
	54	216	29	603	254	LKV54216-29TTT	\$14,732	\$15,895	\$15,435	\$16,540
	48	240	29	324	130	LKV48240-29TTT	\$13,697	\$14,853	\$14,388	\$15,481
	48	216	29	551	228	LKV48216-29TTT	\$13,850	\$14,872	\$14,486	\$15,453

Electrical Options and Upcharges

	216 - 240 wide
<b>CT6</b>	
Six Power Center Top - Black	CT6BL - add \$4,949
Six Power Center Top - White	CT6WH - add \$4,949
<b>CU2</b>	
Dual Power Underside - Black	CU2-1C - add \$1,298
Dual Power Underside with 4 Wireless Charging - Black	CU2-1CW - add \$3,278
<b>CT6U2</b>	
Six Power Center Top - Black with Dual Underside	CT6U2-BL - add \$5,748
Six Power Center Top - White with Dual Underside	CT6U2-WH - add \$5,748
Six Power Center Top - Black Dual Underside with 4 Wireless Charging	CT6U2-BLW2 - add \$7,668
Six Power Center Top - White Dual Underside with 4 Wireless Charging	CT6U2-WHW2 - add \$7,668

Note: Order power infeed that best fits application

To Order Specify

1 Veneer Model #	2 Edge Detail	3 Wood Collection	4 Wood Finish	5 Electrical	6 Metal Color
Veneer (LKV)	<a href="#">See Edge Detail Options</a>	Essentials	<a href="#">See Essentials Wood Finish Options</a>	N None CT6 Six Power Center Top CU2 Dual Power Underside CT6U2 Six Power Center Top with Underside (See chart above)	<a href="#">See Metal Finish Color Options</a>
		Artisan	<b>4 Wood Finish</b> <a href="#">See Artisan Wood Finish Options</a>		

LOK - CONFERENCE

Description

Rectangular 2pc Table with T Base at Working Height

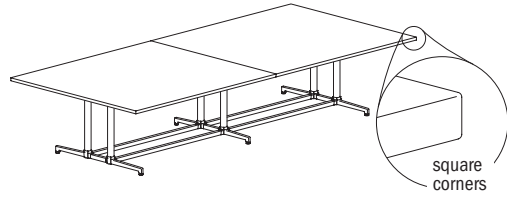

Laminate Tables "LKT" Models

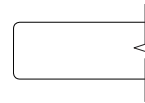

Eased Edge (R3)

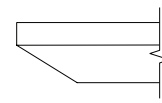

Reverse Bevel Edge (K9)

D	W	H	CTN WT	CU FT	Model	Eased Edge (R3)		Reverse Bevel Edge (K9)	
						Standard Tier 1	Graded In Tier 2	Standard Tier 1	Graded In Tier 2
60	192	29	513	226	LKT60192-29TTT	\$8,533	\$8,692	\$9,292	\$9,451
60	168	29	460	198	LKT60168-29TTT	\$7,978	\$8,117	\$8,700	\$8,839
60	144	29	405	169	LKT60144-29TTT	\$7,378	\$7,495	\$8,065	\$8,182
60	120	29	350	143	LKT60120-29TTT	\$6,413	\$6,509	\$7,061	\$7,163
LAMINATE									
54	192	29	472	204	LKT54192-29TTT	\$7,984	\$8,125	\$8,712	\$8,853
54	168	29	389	178	LKT54168-29TTT	\$7,234	\$7,356	\$7,930	\$8,054
54	144	29	375	154	LKT54144-29TTT	\$6,666	\$6,773	\$7,331	\$7,438
54	120	29	324	130	LKT54120-29TTT	\$6,032	\$6,122	\$6,662	\$6,751
48	192	29	432	183	LKT48192-29TTT	\$6,961	\$7,089	\$7,657	\$7,784
48	168	29	389	161	LKT48168-29TTT	\$6,476	\$6,588	\$7,141	\$7,254
48	144	29	344	139	LKT48144-29TTT	\$5,941	\$6,037	\$6,583	\$6,677
48	120	29	298	116	LKT48120-29TTT	\$5,342	\$5,422	\$5,954	\$6,032
48	108	29	275	105	LKT48108-29TTT	\$4,514	\$4,586	\$5,112	\$5,184

Features:

- price reflects complete table - top and base
- ships KD in multiple cartons
- two piece top
- model includes adjustable glide

specify power/charging option, see below for options and upcharges

LOK - CONFERENCE



top shape

To Order Specify

1 Laminate Model #	2 Edge Detail	3 Laminate Selection	3a PVC Edge Color	4 Electrical	5 Metal Color
Laminate (LKT)	<a href="#">See Edge Detail Options</a>	<a href="#">See Laminate Selection</a>	<a href="#">See PVC Edge Color Options</a>	N None CT2 Dual Power Center Top CU2 Dual Power Underside CT2U1 Dual Power Center Top with Underside CT4U2 Four Power Center Top with Underside CT4 Four Power Center Top (See chart on next page)	<a href="#">See Metal Finish Color Options</a>

Model Number Breakdown

LKT60192-29TTT					
LK	T	60192	29	TT	T
LOK	Laminate	60" x 192"	Height	Rectangular Top Shape	T base

Description

Rectangular 2pc Table with T Base at Working Height (continued)

Veneer Tables "LKV" Models

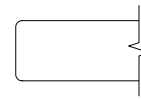

Eased Edge (R3)

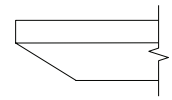

Reverse Bevel Edge (K9)

D	W	H	CTN WT	CU FT	Model	Eased Edge (R3)		Reverse Bevel Edge (K9)	
						Essentials	Artisan	Essentials	Artisan
60	192	29	513	226	LKV60192-29TTT	\$13,064	\$14,110	\$14,241	\$15,167
60	168	29	460	198	LKV60168-29TTT	\$12,028	\$12,990	\$13,108	\$13,959
60	144	29	460	198	LKV60144-29TTT	\$10,953	\$11,829	\$11,941	\$12,715
60	120	29	405	169	LKV60120-29TTT	\$9,670	\$10,444	\$10,540	\$11,226
54	192	29	453	204	LKV54192-29TTT	\$11,954	\$12,910	\$13,028	\$13,876
54	168	29	472	204	LKV54168-29TTT	\$12,230	\$13,207	\$13,328	\$14,196
54	144	29	389	178	LKV54144-29TTT	\$9,941	\$10,733	\$10,835	\$11,536
54	120	29	375	154	LKV54120-29TTT	\$8,878	\$9,588	\$9,677	\$10,304
48	192	29	553	206	LKV48192-29TTT	\$11,990	\$12,890	\$12,577	\$13,422
48	168	29	432	183	LKV48168-29TTT	\$9,846	\$10,622	\$10,380	\$11,108
48	144	29	389	161	LKV48144-29TTT	\$8,921	\$9,575	\$9,407	\$10,020
48	120	29	344	139	LKV48120-29TTT	\$7,935	\$8,470	\$8,369	\$8,870
48	108	29	298	116	LKV48108-29TTT	\$6,505	\$7,020	\$7,089	\$7,548

Electrical Options and Upcharges

CT2	108 wide	120 - 192 wide
Dual Power Center Top - Black	CT2BL - add \$1,837	n/a
Dual Power Center Top - White	CT2WH - add \$1,837	n/a
CU1		
Single Power Underside - Black	CU1-1C - add \$731	CU1-1C - add \$849
Single Power Underside with Wireless Charging - Black	CU1-1CW - add \$1,691	CU1-1CW - add \$1,776
CT2U1		
Dual Power Center Top - Black with Underside	CT2U1-BL - add \$2,235	n/a
Dual Power Center Top - White with Underside	CT2U1-WH - add \$2,235	n/a
Dual Power Center Top - Black with Wireless Charging	CT2U1-BLW2 - add \$3,194	n/a
Dual Power Center Top - White with Wireless Charging	CT2U1-WHW2 - add \$3,194	n/a

CT4U1	108 wide	120 - 192 wide
Four Power Center Top with Single Underside - Black	n/a	CT4U1-BL - add \$3,906
Four Power Center Top with Single Underside - White	n/a	CT4U1-WH - add \$3,906
Four Power Center Top - Black with Underside & Wireless Charging	n/a	CT4U1-BLW2 - add \$4,840
Four Power Center Top - White with Underside & Wireless Charging	n/a	CT4U1-WHW2 - add \$4,840
CT4		
Four Power Center Top - Black	n/a	CT4BL - add \$3,421
Four Power Center Top - White	n/a	CT4WH - add \$3,421

Note: Order power infeed that best fits application

To Order Specify

1 Veneer Model #	2 Edge Detail	3 Wood Collection	4 Wood Finish	5 Electrical	6 Metal Color
Veneer (LKV)	<a href="#">See Edge Detail Options</a>	Essentials	<a href="#">See Essentials Wood Finish Options</a>	N None CT2 Dual Power Center Top CU2 Dual Power Underside CT2U1 Dual Power Center Top with Underside CT4U2 Four Power Center Top with Underside CT4 Four Power Center Top	<a href="#">See Metal Finish Color Options</a>
		Artisan	4 Wood Finish <a href="#">See Artisan Wood Finish Options</a>		

LOK- CONFERENCE

Description

Rectangular Table with T Base at Working Height

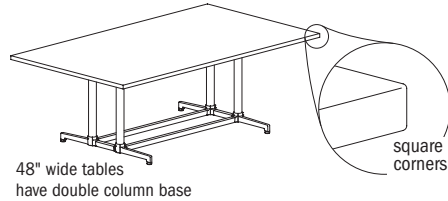

48" wide tables have double column base

LAMINATE

D	W	H	CTN WT	CU FT	Model
48	96	29	204	105	LKT4896-29TTT
48	84	29	204	83	LKT4884-29TTT
42	96	29	183	73	LKT4296-29TTT
42	84	29	164	72	LKT4284-29TTT
36	96	29	162	72	LKT3696-29TTT
36	84	29	151	64	LKT3684-29TTT

Laminate Tables "LKT" Models

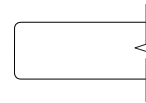

Eased Edge (R3)

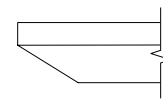

Reverse Bevel Edge (K9)

Eased Edge (R3)		Reverse Bevel Edge (K9)	
Standard Tier 1	Graded In Tier 2	Standard Tier 1	Graded In Tier 2
\$3,784	\$3,848	\$4,366	\$4,429
\$3,370	\$3,424	\$3,936	\$3,992
\$3,446	\$3,503	\$4,013	\$4,069
\$2,834	\$2,884	\$3,388	\$3,436
\$2,893	\$2,942	\$3,444	\$3,493
\$2,594	\$2,636	\$3,133	\$3,177

Features:

- price reflects complete table - top and base
- ships KD in multiple cartons
- one piece top
- model includes adjustable glide

Options:

- specify power/charging option, see below for options and upcharges

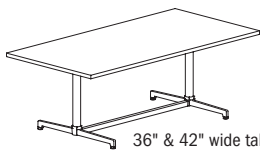

36" & 42" wide tables have single column base



top shape

LOK - CONFERENCE

To Order Specify

1 Laminates Model #	2 Edge Detail	3 Laminates Selection	3a PVC Edge Color	4 Electrical	5 Metal Color
Laminates (LKT)	<a href="#">See Edge Detail Options</a>	<a href="#">See Laminates Selection</a>	<a href="#">See PVC Edge Color Options</a>	N None CT2 Dual Power Center Top CU2 Dual Power Underside CT2U1 Dual Power Center Top with Underside (See chart on next page)	<a href="#">See Metal Finish Color Options</a>

Model Number Breakdown

LKT4896-29TTT					
LK	T	4896	29	TT	T
LOK	Laminates	48" x 96"	Height	Rectangular Top Shape	T base

Description

Rectangular Table with T Base  
at Working Height  
(continued)

Veneer Tables  
"LKV" Models

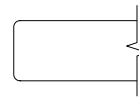

Eased Edge (R3)

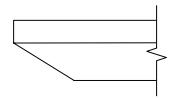

Reverse Bevel Edge (K9)

VENEER	D	W	H	CTN WT	CU FT	① Model	Essentials	Artisan	Essentials	Artisan
		48	96	29	275	105	LKV4896-29TTT	\$5,297	\$5,716	\$5,678
	48	84	29	204	94	LKV4884-29TTT	\$4,817	\$5,178	\$5,172	\$5,506
	42	96	29	183	83	LKV4296-29TTT	\$5,779	\$6,244	\$6,299	\$6,707
	42	84	29	164	73	LKV4284-29TTT	\$4,399	\$4,749	\$4,794	\$5,105
	36	96	29	162	72	LKV3696-29TTT	\$3,912	\$4,222	\$4,262	\$4,537
	36	84	29	145	72	LKV3684-29TTT	\$3,667	\$3,960	\$3,999	\$4,258

Electrical Options and Upcharges

CT2	84 - 96 wide
Dual Power Center Top - Black	CT2BL - add \$1,837
Dual Power Center Top - White	CT2WH - add \$1,837
CU1	
Single Power Underside - Black	CU1-1C - add \$731
Single Power Underside with Wireless Charging - Black	CU1-1CW - add \$1,691
CT2U1	
Dual Power Center Top - Black with Single Underside	CT2U1-BL - add \$2,235
Dual Power Center Top - White with Single Underside	CT2U1-WH - add \$2,235
Dual Power Center Top - Black with Wireless Charging	CT2U1-BLW2 - add \$3,194
Dual Power Center Top - White with Wireless Charging	CT2U1-WHW2 - add \$3,194

Note: Order power infed that best fits application

To Order Specify

① Veneer Model #	② Edge Detail	③ Wood Collection	④ Wood Finish	⑤ Electrical	⑥ Metal Color
Veneer (LKV)	<a href="#">See Edge Detail Options</a>	Essentials	<a href="#">See Essentials Wood Finish Options</a>	N None CT2 Dual Power Center Top CU2 Dual Power Underside CT2U1 Dual Power Center Top with Underside (See chart above)	<a href="#">See Metal Finish Color Options</a>
		Artisan	④ Wood Finish <a href="#">See Artisan Wood Finish Options</a>		

LOK - CONFERENCE

Description

Rounded Rectangular 3pc Table with T Base at Working Height

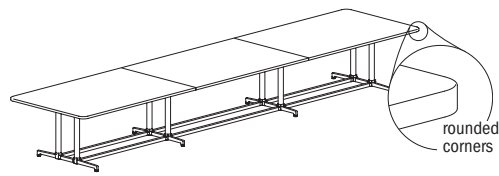

Laminate Tables "LKT" Models

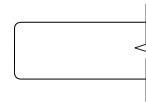

Eased Edge (R3)

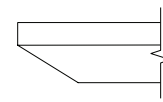

Reverse Bevel Edge (K9)

LAMINATE	D	W	H	CTN WT	CU FT	Model	Standard Tier 1	Graded In Tier 2	Standard Tier 1	Graded In Tier 2
		60	240	29	653	281	LKT60240-29TTRT	\$12,271	\$12,471	\$13,108
	60	216	29	598	253	LKT60216-29TTRT	\$10,460	\$10,636	\$11,260	\$11,438
	54	240	29	603	254	LKT54240-29TTRT	\$9,900	\$10,074	\$10,693	\$10,870
	54	216	29	453	229	LKT54216-29TTRT	\$9,309	\$9,470	\$10,073	\$10,232
	48	240	29	551	228	LKT48240-29TTRT	\$9,429	\$9,588	\$10,183	\$10,339
	48	216	29	553	206	LKT48216-29TTRT	\$8,341	\$8,484	\$9,068	\$9,210

Features:

- price reflects complete table - top and base
- ships KD in multiple cartons
- three piece top
- model includes adjustable glide

Options:

- specify power/charging option, see below for options and upcharges



top shape

LOK - CONFERENCE

To Order Specify

1 Laminate Model #	2 Edge Detail	3 Laminate Selection	3a PVC Edge Color	4 Electrical	5 Metal Color
Laminate (LKT)	<a href="#">See Edge Detail Options</a>	<a href="#">See Laminate Selection</a>	<a href="#">See PVC Edge Color Options</a>	N None CT6 Six Power Center Top CU2 Dual Power Underside CT6U2 Six Power Center Top with Underside (See chart on next page)	<a href="#">See Metal Finish Color Options</a>

Model Number Breakdown

LKT60240-29TTRT						
LK	T	60240	29	TT	R	T
LOK	Laminate	60" x 240"	Height	Rectangular Top Shape	Rounded Corner	T base

Description

Rounded Rectangular 3pc Table with T Base at Working Height (continued)

Veneer Tables "LKV" Models

Solid Surface Tables "LKS" Models

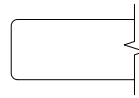

Eased Edge (R3)

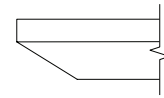

Reverse Bevel Edge (K9)

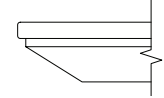

Reverse Bevel Edge (S7)

	D	W	H	CTN WT	CU FT	① Model	Veneer		Solid Surface		
							Essentials	Artisan	Essentials	Artisan	Standard
VENEER	60	240	29	653	281	LKV60240-29TTRT	\$19,086	\$20,613	\$20,803	\$22,155	--
	60	216	29	598	253	LKV60216-29TTRT	\$16,800	\$18,143	\$18,311	\$19,502	--
	54	240	29	603	254	LKV54240-29TTRT	\$16,169	\$17,479	\$16,932	\$18,176	--
	54	216	29	453	229	LKV54216-29TTRT	\$15,005	\$16,169	\$15,705	\$16,809	--
	48	240	29	551	228	LKV48240-29TTRT	\$15,170	\$16,325	\$15,864	\$16,954	--
	48	216	29	553	206	LKV48216-29TTRT	\$13,324	\$14,350	\$13,964	\$14,932	--
SOLID SURFACE	60	240	29	653	281	LKS60240-29TTRT	--	--	--	--	\$42,849
	60	216	29	598	253	LKS60216-29TTRT	--	--	--	--	\$38,729
	54	240	29	603	254	LKS54240-29TTRT	--	--	--	--	\$38,990
	54	216	29	453	229	LKS54216-29TTRT	--	--	--	--	\$35,281
	48	240	29	551	228	LKS48240-29TTRT	--	--	--	--	\$35,212
	48	216	29	553	206	LKS48216-29TTRT	--	--	--	--	\$31,136

Electrical Options and Upcharges

	216 - 240 wide
<b>CT6</b>	
Six Power Center Top - Black	CT6BL - add \$4,949
Six Power Center Top - White	CT6WH - add \$4,949
<b>CU2</b>	
Dual Power Underside - Black	CU2-1C - add \$1,298
Dual Power Underside with 4 Wireless Charging - Black	CU2-1CW - add \$3,278
<b>CT6U2</b>	
Six Power Center Top - Black with Dual Underside	CT6U2-BL - add \$5,748
Six Power Center Top - White with Dual Underside	CT6U2-WH - add \$5,748
Six Power Center Top - Black Dual Underside with 4 Wireless Charging	CT6U2-BLW2 - add \$7,668
Six Power Center Top - White Dual Underside with 4 Wireless Charging	CT6U2-WHW2 - add \$7,668

LOK - CONFERENCE

To Order Specify

Note: Order power infeed that best fits application, see page 408.

① Veneer Model #	② Edge Detail	③ Wood Collection	④ Wood Finish	⑤ Electrical	⑥ Metal Color
Veneer (LKV)	<a href="#">See Edge Detail Options</a>	Essentials	<a href="#">See Essentials Wood Finish Options</a>	N None CT6 Six Power Center Top CU2 Dual Power Underside CT6U2 Six Power Center Top with Underside (See chart above)	<a href="#">See Metal Finish Color Options</a>
		Artisan	④ Wood Finish <a href="#">See Artisan Wood Finish Options</a>		

① Solid Surface Model #	② Top Surface Selection	③ Electrical	④ Metal Color
Solid Surface (LKS)	<a href="#">See Solid Surface Top Surface Selection Options</a>	N None CT6 Six Power Center Top CU2 Dual Power Underside CT6U2 Six Power Center Top with Underside (See chart above)	<a href="#">See Metal Finish Color Options</a>

Description

Rounded Rectangular 2pc Table with T Base at Working Height

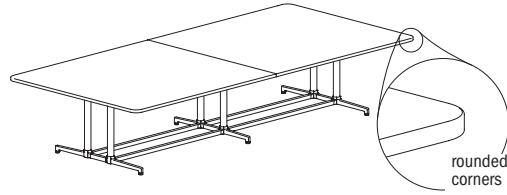

Laminate Tables "LKT" Models

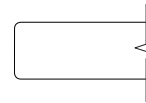

Eased Edge (R3)

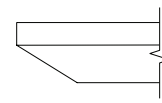

Reverse Bevel Edge (K9)

D	W	H	CTN WT	CU FT	Model	Eased Edge (R3)		Reverse Bevel Edge (K9)	
						Standard Tier 1	Graded In Tier 2	Standard Tier 1	Graded In Tier 2
60	192	29	513	226	LKT60192-29TTRT	\$8,547	\$8,708	\$9,307	\$9,465
60	168	29	460	198	LKT60168-29TTRT	\$7,977	\$8,115	\$8,699	\$8,838
60	144	29	405	169	LKT60144-29TTRT	\$7,360	\$7,478	\$8,048	\$8,165
60	120	29	350	143	LKT60120-29TTRT	\$6,526	\$6,623	\$7,176	\$7,275
54	192	29	472	204	LKT54192-29TTRT	\$8,133	\$8,277	\$8,861	\$9,004
54	168	29	389	178	LKT54168-29TTRT	\$7,367	\$7,493	\$8,065	\$8,187
54	144	29	375	154	LKT54144-29TTRT	\$6,787	\$6,895	\$7,452	\$7,558
54	120	29	324	130	LKT54120-29TTRT	\$6,081	\$6,169	\$6,708	\$6,798
48	192	29	432	183	LKT48192-29TTRT	\$7,097	\$7,224	\$7,793	\$7,918
48	168	29	389	161	LKT48168-29TTRT	\$6,598	\$6,708	\$7,264	\$7,375
48	144	29	344	139	LKT48144-29TTRT	\$6,053	\$6,147	\$6,691	\$6,787
48	120	29	298	116	LKT48120-29TTRT	\$5,439	\$5,518	\$6,051	\$6,130
48	108	29	275	105	LKT48108-29TTRT	\$4,609	\$4,678	\$5,202	\$5,274

LAMINATE

Features:

- price reflects complete table - top and base
- ships KD in multiple cartons
- two piece top
- model includes adjustable glide

Options:

- specify power/charging option, see below for options and upcharges

Electrical Options and Upcharges

	108 wide	120 - 192 wide
<b>CT2</b>		
Dual Power Center Top - Black	CT2BL - add \$1,837	n/a
Dual Power Center Top - White	CT2WH - add \$1,837	n/a
<b>CU1</b>		
Single Power Underside - Black	CU1-1C - add \$731	CU1-1C - add \$849
Single Power Underside with Wireless Charging - Black	CU1-1CW - add \$1,691	CU1-1CW - add \$1,776
<b>CT2U1</b>		
Dual Power Center Top - Black with Underside	CT2U1-BL - add \$2,235	n/a
Dual Power Center Top - White with Underside	CT2U1-WH - add \$2,235	n/a
Dual Power Center Top - Black with Wireless Charging	CT2U1-BLW2 - add \$3,194	n/a
Dual Power Center Top - White with Wireless Charging	CT2U1-WHW2 - add \$3,194	n/a

Note: Order power infeed that best fits application.

	108 wide	120 - 192 wide
<b>CT4U1</b>		
Four Power Center Top with Single Underside - Black	n/a	CT4U1-BL - add \$3,906
Four Power Center Top with Single Underside - White	n/a	CT4U1-WH - add \$3,906
Four Power Center Top - Black with Underside & Wireless Charging	n/a	CT4U1-BLW2 - add \$4,840
Four Power Center Top - White with Underside & Wireless Charging	n/a	CT4U1-WHW2 - add \$4,840
<b>CT4</b>		
Four Power Center Top - Black	n/a	CT4BL - add \$3,421
Four Power Center Top - White	n/a	CT4WH - add \$3,421

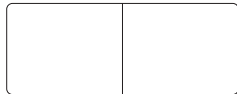

top shape

LOK - CONFERENCE

To Order Specify

1 Laminate Model #	2 Edge Detail	3 Laminate Selection	3a PVC Edge Color	4 Electrical	5 Metal Color
Laminate (LKT)	<a href="#">See Edge Detail Options</a>	<a href="#">See Laminate Selection</a>	<a href="#">See PVC Edge Color Options</a>	N None CT2 Dual Power Center Top CU2 Dual Power Underside CT2U1 Dual Power Center Top with Underside CT4U2 Four Power Center Top with Underside CT4 Four Power Center Top (See chart above)	<a href="#">See Metal Finish Color Options</a>

Model Number Breakdown

LKT60192-29TTRT						
LK	T	60192	29	TT	R	T
LOK	Laminate	60" x 192"	Height	Rectangular Top Shape	Rounded Corner	T base

Description

Rounded Rectangular 2pc Table with T Base at Working Height (continued)

Veneer Tables "LKV" Models      Solid Surface Tables "LKS" Models

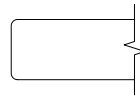

Eased Edge (R3)

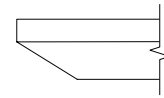

Reverse Bevel Edge (K9)

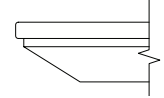

Reverse Bevel Edge (S7)

	D	W	H	CTN WT	CU FT	① Model	Veneer Tables		Solid Surface Tables		Standard	
							Essentials	Artisan	Essentials	Artisan		
VENEER	60	192	29	513	226	LKV60192-29TTRT	\$13,301	\$14,366	\$14,497	\$15,439	--	
	60	168	29	460	198	LKV60168-29TTRT	\$12,235	\$13,213	\$13,335	\$14,202	--	
	60	144	29	405	169	LKV60144-29TTRT	\$11,137	\$12,028	\$12,138	\$12,928	--	
	60	120	29	350	143	LKV60120-29TTRT	\$9,827	\$10,613	\$10,712	\$11,405	--	
	54	192	29	472	204	LKV54192-29TTRT	\$12,166	\$13,143	\$13,263	\$14,122	--	
	54	168	29	389	178	LKV54168-29TTRT	\$11,127	\$12,018	\$12,128	\$12,916	--	
	54	144	29	375	154	LKV54144-29TTRT	\$10,106	\$10,914	\$11,017	\$11,730	--	
	54	120	29	324	130	LKV54120-29TTRT	\$8,944	\$9,658	\$9,747	\$10,378	--	
	48	192	29	432	183	LKV48192-29TTRT	\$10,927	\$11,822	\$11,511	\$12,356	--	
	48	168	29	389	161	LKV48168-29TTRT	\$10,017	\$10,790	\$10,549	\$11,281	--	
	48	144	29	344	139	LKV48144-29TTRT	\$9,072	\$9,725	\$9,556	\$10,170	--	
	48	120	29	298	116	LKV48120-29TTRT	\$8,065	\$8,601	\$8,500	\$9,003	--	
	48	108	29	275	105	LKV48108-29TTRT	\$6,622	\$7,152	\$7,217	\$7,685	--	
	SOLID SURFACE	60	192	29	513	226	LKS60192-29TTRT	--	--	--	--	\$32,183
		60	168	29	460	198	LKS60168-29TTRT	--	--	--	--	\$28,438
		60	144	29	405	169	LKS60144-29TTRT	--	--	--	--	\$24,738
60		120	29	350	143	LKS60120-29TTRT	--	--	--	--	\$27,055	
54		192	29	472	204	LKS54192-29TTRT	--	--	--	--	\$29,137	
54		168	29	389	178	LKS54168-29TTRT	--	--	--	--	\$25,867	
54		144	29	375	154	LKS54144-29TTRT	--	--	--	--	\$22,540	
54		120	29	324	130	LKS54120-29TTRT	--	--	--	--	\$19,149	
48		192	29	432	183	LKS48192-29TTRT	--	--	--	--	\$26,347	
48		168	29	389	161	LKS48168-29TTRT	--	--	--	--	\$23,357	
48		144	29	344	139	LKS48144-29TTRT	--	--	--	--	\$20,391	
48		120	29	298	116	LKS48120-29TTRT	--	--	--	--	\$17,434	
48		108	29	275	105	LKS48108-29TTRT	--	--	--	--	\$15,926	

LOK- CONFERENCE

To Order Specify

① Veneer Model #	② Edge Detail	③ Wood Collection	④ Wood Finish	⑤ Electrical	⑥ Metal Color
Veneer (LKV)	<a href="#">See Edge Detail Options</a>	Essentials	<a href="#">See Essentials Wood Finish Options</a>	N None CT2 Dual Power Center Top CU2 Dual Power Underside CT2U1 Dual Power Center Top with Underside CT4U2 Four Power Center Top with Underside CT4 Four Power Center Top (See chart on previous page)	<a href="#">See Metal Finish Color Options</a>
		Artisan	④ Wood Finish <a href="#">See Artisan Wood Finish Options</a>		

① Solid Surface Model #	② Top Surface Selection	③ Electrical	④ Metal Color
Solid Surface (LKS)	<a href="#">See Solid Surface Top Surface Selection Options</a>	N None CT2 Dual Power Center Top CU2 Dual Power Underside CT2U1 Dual Power Center Top with Underside CT4U2 Four Power Center Top with Underside CT4 Four Power Center Top (See chart on previous page)	<a href="#">See Metal Finish Color Options</a>

## Description

Rounded Rectangular Table with T Base at Working Height

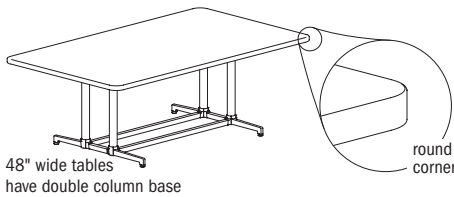

48" wide tables have double column base

LAMINATE

D	W	H	CTN WT	CU FT	Model
48	96	29	204	105	LKT4896-29TTRT
48	84	29	183	83	LKT4884-29TTRT
42	96	29	164	73	LKT4296-29TTRT
42	84	29	162	72	LKT4284-29TTRT
36	96	29	145	72	LKT3696-29TTRT
36	84	29	151	64	LKT3684-29TTRT

## Laminate Tables "LKT" Models

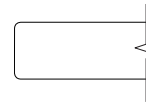

Eased Edge (R3)

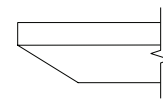

Reverse Bevel Edge (K9)

Eased Edge (R3)		Reverse Bevel Edge (K9)	
Standard Tier 1	Graded In Tier 2	Standard Tier 1	Graded In Tier 2
\$3,861	\$3,924	\$4,443	\$4,506
\$3,439	\$3,498	\$4,007	\$4,062
\$3,517	\$3,572	\$4,084	\$4,138
\$2,897	\$2,947	\$3,455	\$3,503
\$2,957	\$3,007	\$3,510	\$3,557
\$2,655	\$2,694	\$3,194	\$3,238

### Features:

- price reflects complete table - top and base
- ships KD in multiple cartons
- one piece top
- model includes adjustable glide

### Options:

- specify power/charging option, see below for options and upcharges

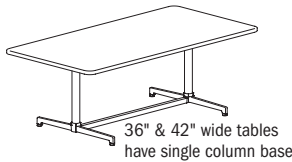

36" & 42" wide tables have single column base



top shape

LOK - CONFERENCE

## To Order Specify

1 Laminate Model #	2 Edge Detail	3 Laminate Selection	3a PVC Edge Color	4 Electrical	5 Metal Color
Laminate (LKT)	<a href="#">See Edge Detail Options</a>	<a href="#">See Laminate Selection</a>	<a href="#">See PVC Edge Color Options</a>	N None CT2 Dual Power Center Top CU2 Dual Power Underside CT2U1 Dual Power Center Top with Underside (See chart on next page)	<a href="#">See Metal Finish Color Options</a>

## Model Number Breakdown

LKT4896-29TTRT						
LK	T	4896	29	TT	R	T
LOK	Laminate	48" x 96"	Height	Rectangular Top Shape	Rounded Corner	T base

Description

Rounded Rectangular Table with T Base at Working Height (continued)

Veneer Tables "LKV" Models      Solid Surface Tables "LKS" Models

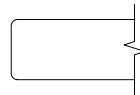

Eased Edge (R3)

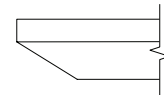

Reverse Bevel Edge (K9)

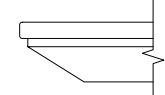

Reverse Bevel Edge (S7)

	D	W	H	CTN WT	CU FT	① Model	Veneer Tables		Solid Surface Tables		
							Essentials	Artisan	Essentials	Artisan	Standard
VENEER	48	96	29	204	105	LKV4896-29TTRT	\$5,378	\$5,796	\$5,762	\$6,146	--
	48	84	29	204	83	LKV4884-29TTRT	\$4,922	\$5,281	\$5,276	\$5,610	--
	42	96	29	183	83	LKV4296-29TTRT	\$5,256	\$5,678	\$5,729	\$6,100	--
	42	84	29	164	73	LKV4284-29TTRT	\$4,419	\$4,771	\$4,817	\$5,131	--
	36	96	29	162	72	LKV3696-29TTRT	\$4,001	\$4,320	\$4,359	\$4,644	--
	36	84	29	151	64	LKV3684-29TTRT	\$3,682	\$3,973	\$4,012	\$4,270	--
SOLID SURFACE	48	96	29	204	105	LKS4896-29TTRT	--	--	--	--	\$12,622
	48	84	29	183	83	LKS4884-29TTRT	--	--	--	--	\$11,205
	42	96	29	164	73	LKS4296-29TTRT	--	--	--	--	\$10,285
	42	84	29	162	72	LKS4284-29TTRT	--	--	--	--	\$9,066
	36	96	29	145	72	LKS3696-29TTRT	--	--	--	--	\$9,038
	36	84	29	151	64	LKS3684-29TTRT	--	--	--	--	\$8,146

Electrical Options and Upcharges

CT2	84 - 96 wide
Dual Power Center Top - Black	CT2BL - add \$1,837
Dual Power Center Top - White	CT2WH - add \$1,837
CU1	
Single Power Underside - Black	CU1-1C - add \$731
Single Power Underside with Wireless Charging - Black	CU1-1CW - add \$1,691
CT2U1	
Dual Power Center Top - Black with Single Underside	CT2U1-BL - add \$2,235
Dual Power Center Top - White with Single Underside	CT2U1-WH - add \$2,235
Dual Power Center Top - Black with Wireless Charging	CT2U1-BLW2 - add \$3,194
Dual Power Center Top - White with Wireless Charging	CT2U1-WHW2 - add \$3,194

LOK - CONFERENCE

Note: Order power infeed that best fits application

To Order Specify

① Veneer Model #	② Edge Detail	③ Wood Collection	④ Wood Finish	⑤ Electrical	⑥ Metal Color
Veneer (LKV)	<a href="#">See Edge Detail Options</a>	Essentials	<a href="#">See Essentials Wood Finish Options</a>	N None CT2 Dual Power Center Top CU2 Dual Power Underside CT2U1 Dual Power Center Top with Underside (See chart above)	<a href="#">See Metal Finish Color Options</a>
		Artisan	④ Wood Finish <a href="#">See Artisan Wood Finish Options</a>		

① Solid Surface Model #	② Top Surface Selection	③ Electrical	④ Metal Color
Solid Surface (LKS)	<a href="#">See Solid Surface Top Surface Selection Options</a>	N None CT2 Dual Power Center Top CU2 Dual Power Underside CT2U1 Dual Power Center Top with Underside (See chart above)	<a href="#">See Metal Finish Color Options</a>

Description

Rectangular Table 3pc with Y Base at Working Height

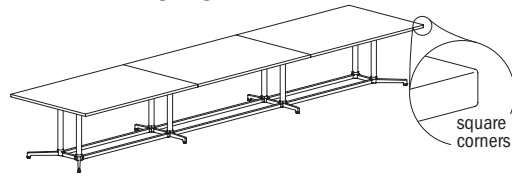

Laminate Tables "LKT" Models

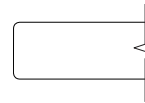

Eased Edge (R3)

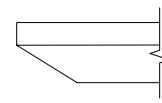

Reverse Bevel Edge (K9)

LAMINATE	D	W	H	CTN WT	CU FT	1 Model	Standard Tier 1	Graded In Tier 2	Standard Tier 1	Graded In Tier 2
		60	240	29	653	281	LKT60240-29TTY	\$11,665	\$11,862	\$12,501
	60	216	29	598	253	LKT60216-29TTY	\$9,703	\$9,879	\$10,500	\$10,679
	54	240	29	584	254	LKT54240-29TTY	\$9,203	\$9,380	\$9,996	\$10,175
	54	216	29	538	229	LKT54216-29TTY	\$8,221	\$8,381	\$8,983	\$9,141
	48	240	29	545	228	LKT48240-29TTY	\$8,904	\$9,064	\$9,657	\$9,815
	48	216	29	492	206	LKT48216-29TTY	\$7,791	\$7,932	\$8,514	\$8,657

Features:

- price reflects complete table - top and base
- ships KD in multiple cartons
- three piece top
- model includes adjustable glide

Options:

- specify power/charging option, see below for options and upcharges



top shape

LOK - CONFERENCE

To Order Specify

1 Laminate Model #	2 Edge Detail	3 Laminate Selection	4 PVC Edge Color	4 Electrical	5 Metal Color
Laminate (LKT)	<a href="#">See Edge Detail Options</a>	<a href="#">See Laminate Selection</a>	<a href="#">See PVC Edge Color Options</a>	N None CT6 Six Power Center Top CU2 Dual Power Underside CT6U2 Six Power Center Top with Underside (See chart on next page)	<a href="#">See Metal Finish Color Options</a>

Model Number Breakdown

LKT60240-29TTY					
LK	T	60240	29	TT	Y
LOK	Laminate	60" x 240"	Height	Rectangular Top Shape	Y base

Description

Rectangular Table 3pc with Y Base at Working Height (continued)

Veneer Tables "LKV" Models

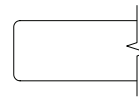

Eased Edge (R3)

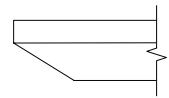

Reverse Bevel Edge (K9)

D	W	H	CTN WT	CU FT	① Model	Eased Edge (R3)		Reverse Bevel Edge (K9)		
						Essentials	Artisan	Essentials	Artisan	
60	240	29	653	281	LKV60240-29TTY	\$18,175	\$19,629	\$19,812	\$21,098	
60	216	29	598	253	LKV60216-29TTY	\$15,898	\$17,171	\$17,332	\$18,455	
VENEER	54	240	29	584	254	LKV54240-29TTY	\$15,140	\$16,454	\$15,904	\$17,152
	54	216	29	538	229	LKV54216-29TTY	\$13,423	\$14,587	\$14,124	\$15,229
	48	240	29	545	228	LKV48240-29TTY	\$14,404	\$15,562	\$15,097	\$16,191
	48	216	29	492	206	LKV48216-29TTY	\$12,538	\$13,564	\$13,178	\$14,147

Electrical Options and Upcharges

	216 - 240 wide
<b>CT6</b>	
Six Power Center Top - Black	CT6BL - add \$4,949
Six Power Center Top - White	CT6WH - add \$4,949
<b>CU2</b>	
Dual Power Underside - Black	CU2-1C - add \$1,298
Dual Power Underside with 4 Wireless Charging - Black	CU2-1CW - add \$3,278
<b>CT6U2</b>	
Six Power Center Top - Black with Dual Underside	CT6U2-BL - add \$5,748
Six Power Center Top - White with Dual Underside	CT6U2-WH - add \$5,748
Six Power Center Top - Black Dual Underside with 4 Wireless Charging	CT6U2-BLW2 - add \$7,668
Six Power Center Top - White Dual Underside with 4 Wireless Charging	CT6U2-WHW2 - add \$7,668

Note: Order power infeed that best fits application

To Order Specify

① Veneer Model #	② Edge Detail	③ Wood Collection	④ Wood Finish	⑤ Electrical	⑥ Metal Color
Veneer (LKV)	<a href="#">See Edge Detail Options</a>	Essentials	<a href="#">See Essentials Wood Finish Options</a>	N None CT6 Six Power Center Top CU2 Dual Power Underside CT6U2 Six Power Center Top with Underside (See chart above)	<a href="#">See Metal Finish Color Options</a>
		Artisan	④ Wood Finish <a href="#">See Artisan Wood Finish Options</a>		

LOK - CONFERENCE

Description

Rectangular 2pc Table with Y Base at Working Height

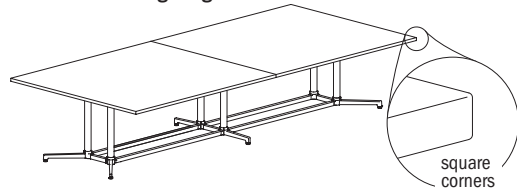

Laminate Tables "LKT" Models

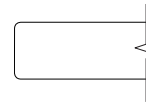

Eased Edge (R3)

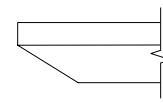

Reverse Bevel Edge (K9)

D	W	H	CTN WT	CU FT	Model	Eased Edge (R3)		Reverse Bevel Edge (K9)	
						Standard Tier 1	Graded In Tier 2	Standard Tier 1	Graded In Tier 2
60	192	29	513	226	LKT60192-29TTY	\$8,300	\$8,456	\$9,060	\$9,217
60	168	29	460	198	LKT60168-29TTY	\$7,725	\$7,866	\$8,451	\$8,589
60	144	29	345	169	LKT60144-29TTY	\$7,053	\$7,172	\$7,743	\$7,860
60	120	29	342	143	LKT60120-29TTY	\$6,224	\$6,324	\$6,876	\$6,972
LAMINATE									
54	192	29	462	204	LKT54192-29TTY	\$7,875	\$8,016	\$8,601	\$8,744
54	168	29	368	178	LKT54168-29TTY	\$7,011	\$7,136	\$7,705	\$7,830
54	144	29	365	154	LKT54144-29TTY	\$6,377	\$6,482	\$7,041	\$7,144
54	120	29	316	130	LKT54120-29TTY	\$5,847	\$5,934	\$6,477	\$6,565
48	192	29	422	183	LKT48192-29TTY	\$7,666	\$7,794	\$8,361	\$8,486
48	168	29	375	161	LKT48168-29TTY	\$6,204	\$6,312	\$6,869	\$6,980
48	144	29	333	139	LKT48144-29TTY	\$5,749	\$5,846	\$6,389	\$6,482
48	120	29	291	116	LKT48120-29TTY	\$5,198	\$5,277	\$5,809	\$5,888
48	108	29	269	105	LKT48108-29TTY	\$4,627	\$4,697	\$5,224	\$5,295

Features:

- price reflects complete table - top and base
- ships KD in multiple cartons
- two piece top
- model includes adjustable glide

Options:

- specify power/charging option, see below for options and upcharges

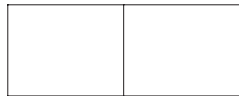

top shape

LOK - CONFERENCE

To Order Specify

1 Laminate Model #	2 Edge Detail	3 Laminate Selection	3a PVC Edge Color	4 Electrical	5 Metal Color
Laminate (LKT)	<a href="#">See Edge Detail Options</a>	<a href="#">See Laminate Selection</a>	<a href="#">See PVC Edge Color Options</a>	N None CT2 Dual Power Center Top CU2 Dual Power Underside CT2U1 Dual Power Center Top with Underside CT4U2 Four Power Center Top with Underside CT4 Four Power Center Top (See chart on next page)	<a href="#">See Metal Finish Color Options</a>

Model Number Breakdown

LKT60192-29TTY					
LK	T	60192	29	TT	Y
LOK	Laminate	60" x 192"	Height	Rectangular Top Shape	Y base

Description

Rectangular 2pc Table with Y Base at Working Height (continued)

Veneer Tables "LKV" Models

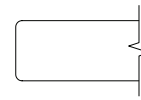

Eased Edge (R3)

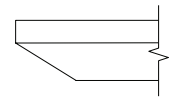

Reverse Bevel Edge (K9)

D	W	H	CTN WT	CU FT	① Model	Essentials		Artisan		
						Essentials	Artisan	Essentials	Artisan	
60	192	29	513	226	LKV60192-29TTY	\$12,726	\$13,744	\$13,871	\$14,773	
60	168	29	460	198	LKV60168-29TTY	\$11,667	\$12,601	\$12,717	\$13,542	
60	144	29	345	169	LKV60144-29TTY	\$10,500	\$11,341	\$11,445	\$12,187	
60	120	29	342	143	LKV60120-29TTY	\$9,414	\$10,165	\$10,260	\$10,927	
VENEER	54	192	29	462	204	LKV54192-29TTY	\$11,798	\$12,744	\$12,860	\$13,697
	54	168	29	368	178	LKV54168-29TTY	\$10,626	\$11,476	\$11,583	\$12,335
	54	144	29	365	154	LKV54144-29TTY	\$9,539	\$10,302	\$10,398	\$11,074
	54	120	29	316	130	LKV54120-29TTY	\$8,629	\$9,318	\$9,404	\$10,014
48	192	29	422	183	LKV48192-29TTY	\$11,724	\$12,617	\$12,308	\$13,152	
48	168	29	375	161	LKV48168-29TTY	\$9,472	\$10,244	\$10,005	\$10,732	
48	144	29	333	139	LKV48144-29TTY	\$8,663	\$9,314	\$9,149	\$9,758	
48	120	29	291	116	LKV48120-29TTY	\$7,747	\$8,282	\$8,180	\$8,682	
48	108	29	269	105	LKV48108-29TTY	\$6,647	\$7,180	\$7,248	\$7,717	

Electrical Options and Upcharges

		120 - 192 wide
<b>CT4</b>		
Four Power Center Top - Black	CT4BL - add \$3,906	
Four Power Center Top - White	CT4WH - add \$3,906	
<b>CU1</b>		
Single Power Underside - Black	CU1-1C - add \$849	
Single Power Underside with Wireless Charging - Black	CU1-1CW - add \$1,776	
<b>CT4U1</b>		
Four Power Center Top with Underside - Black	CT4U1-BL - add \$3,906	
Four Power Center Top with Underside - White	CT4U1-WH - add \$3,906	
Four Power Center Top - Black with Underside & 2 Wireless Charging	CT4U1-BLW2 - add \$4,840	
Four Power Center Top - White with Underside & 2 Wireless Charging	CT4U1-WHW2 - add \$4,840	

Note: Order power infeed that best fits application, see page 408.

To Order Specify

① Veneer Model #	② Edge Detail	③ Wood Collection	④ Wood Finish	⑤ Electrical	⑥ Metal Color
Veneer (LKV)	<a href="#">See Edge Detail Options</a>	Essentials	<a href="#">See Essentials Wood Finish Options</a>	N None CT2 Dual Power Center Top CU2 Dual Power Underside CT2U1 Dual Power Center Top with Underside CT4U2 Four Power Center Top with Underside CT4 Four Power Center Top	<a href="#">See Metal Finish Color Options</a>
		Artisan	④ Wood Finish <a href="#">See Artisan Wood Finish Options</a>		

LOK - CONFERENCE

Description

Rectangular Table with Y Base at Working Height

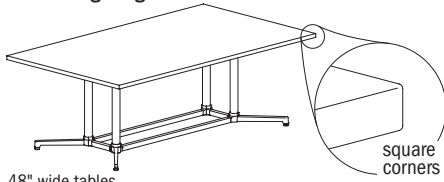

48" wide tables have double column base

LAMINATE	D	W	H	CTN WT	CU FT	Model	Laminate Tables "LKT" Models			
							Eased Edge (R3)		Reverse Bevel Edge (K9)	
							Standard Tier 1	Graded In Tier 2	Standard Tier 1	Graded In Tier 2
	48	96	29	225	105	LKT4896-29TTY	\$3,818	\$3,882	\$4,403	\$4,467
	48	84	29	333	83	LKT4884-29TTY	\$3,348	\$3,402	\$3,920	\$3,971
	42	96	29	174	83	LKT4296-29TTY	\$3,640	\$3,694	\$4,207	\$4,262
	42	84	29	174	72	LKT4284-29TTY	\$3,045	\$3,092	\$3,600	\$3,646
	36	96	29	152	72	LKT3696-29TTY	\$2,905	\$2,955	\$3,459	\$3,507
	36	84	29	156	64	LKT3684-29TTY	\$2,656	\$2,698	\$3,196	\$3,239

Features:

- price reflects complete table - top and base
- ships KD in multiple cartons
- one piece top
- model includes adjustable glide

Options:

- specify power/charging option, see below for options and upcharges

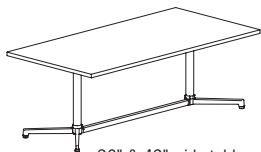

36" & 42" wide tables have single column base



top shape

LOK - CONFERENCE

To Order Specify

1 Laminata Model #	2 Edge Detail	3 Laminata Selection	3a PVC Edge Color	4 Electrical	5 Metal Color
Laminata (LKT)	<a href="#">See Edge Detail Options</a>	<a href="#">See Laminata Selection</a>	<a href="#">See PVC Edge Color Options</a>	N None CT2 Dual Power Center Top CU2 Dual Power Underside CT2U1 Dual Power Center Top with Underside (See chart on next page)	<a href="#">See Metal Finish Color Options</a>

Model Number Breakdown

LKT4896-29TTY					
LK	T	4896	29	TT	Y
LOK	Laminata	48" x 96"	Height	Rectangular Top Shape	Y base

Description

Rectangular Table with Y Base  
at Working Height  
(continued)

Veneer Tables  
"LKV" Models

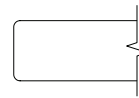

Eased Edge (R3)

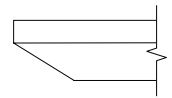

Reverse Bevel Edge (K9)

D	W	H	CTN WT	CU FT	① Model	Eased Edge (R3)		Reverse Bevel Edge (K9)	
						Essentials	Artisan	Essentials	Artisan
48	96	29	225	105	LKV4896-29TTY	\$5,328	\$5,744	\$5,708	\$6,094
48	84	29	333	83	LKV4884-29TTY	\$4,807	\$5,166	\$5,163	\$5,496
42	96	29	174	83	LKV4296-29TTY	\$5,411	\$5,846	\$5,898	\$6,282
	84	29	174	72	LKV4284-29TTY	\$4,597	\$4,964	\$5,010	\$5,334
36	96	29	152	72	LKV3696-29TTY	\$3,936	\$4,252	\$4,291	\$4,568
36	84	29	156	64	LKV3684-29TTY	\$3,683	\$3,975	\$4,014	\$4,274

VENEER

Electrical Options and Upcharges

CT2	84 - 96 wide
Dual Power Center Top - Black	CT2BL - add \$1,837
Dual Power Center Top - White	CT2WH - add \$1,837
CU1	
Single Power Underside - Black	CU1-1C - add \$731
Single Power Underside with Wireless Charging - Black	CU1-1CW - add \$1,691
CT2U1	
Dual Power Center Top - Black with Single Underside	CT2U1-BL - add \$2,235
Dual Power Center Top - White with Single Underside	CT2U1-WH - add \$2,235
Dual Power Center Top - Black with Wireless Charging	CT2U1-BLW2 - add \$3,194
Dual Power Center Top - White with Wireless Charging	CT2U1-WHW2 - add \$3,194

Note: Order power infed that best fits application

To Order Specify

① Veneer Model #	② Edge Detail	③ Wood Collection	④ Wood Finish	⑤ Electrical	⑥ Metal Color
Veneer (LKV)	<a href="#">See Edge Detail Options</a>	Essentials	<a href="#">See Essentials Wood Finish Options</a>	N None CT2 Dual Power Center Top CU2 Dual Power Underside CT2U1 Dual Power Center Top with Underside (See chart above)	<a href="#">See Metal Finish Color Options</a>
		Artisan	④ Wood Finish <a href="#">See Artisan Wood Finish Options</a>		

LOK - CONFERENCE

Description

Rounded Rectangular 3pc Table with Y Base at Working Height

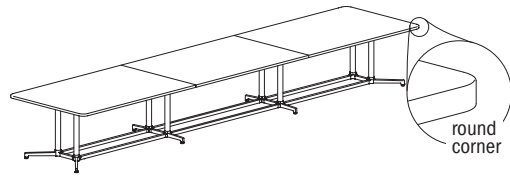

Laminate Tables  
"LKT" Models

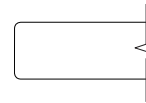

Eased Edge (R3)

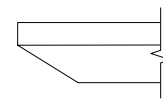

Reverse Bevel Edge (K9)

D	W	H	CTN WT	CU FT	① Model	Eased Edge (R3)		Reverse Bevel Edge (K9)	
						Standard Tier 1	Graded In Tier 2	Standard Tier 1	Graded In Tier 2
60	240	29	653	281	LKT60240-29TTRY	\$11,889	\$12,084	\$12,723	\$12,920
60	216	29	598	253	LKT60216-29TTRY	\$10,053	\$10,232	\$10,852	\$11,030
54	240	29	584	254	LKT54240-29TTRY	\$9,406	\$9,582	\$10,200	\$10,376
54	216	29	538	229	LKT54216-29TTRY	\$8,408	\$8,568	\$9,169	\$9,329
48	240	29	545	228	LKT48240-29TTRY	\$9,088	\$9,249	\$9,841	\$9,999
48	216	29	492	206	LKT48216-29TTRY	\$8,423	\$8,566	\$9,152	\$9,291

LAMINATE

Features:

- price reflects complete table - top and base
- ships KD in multiple cartons
- three piece top
- model includes adjustable glide

Options:

- specify power/charging option, see below for options and upcharges



top shape

LOK - CONFERENCE

To Order Specify

① Laminate Model #	② Edge Detail	③ Laminate Selection	④ PVC Edge Color	⑤ Electrical	⑥ Metal Color
Laminate (LKT)	<a href="#">See Edge Detail Options</a>	<a href="#">See Laminate Selection</a>	<a href="#">See PVC Edge Color Options</a>	N None CT6 Six Power Center Top CU2 Dual Power Underside CT6U2 Six Power Center Top with Underside (See chart on next page)	<a href="#">See Metal Finish Color Options</a>

Model Number Breakdown

LKT60240-29TTRY						
LK	T	60240	29	TT	R	Y
LOK	Laminate	60" x 240"	Height	Rectangular Top Shape	Rounded Corner	Y base

Description

Rounded Rectangular 3pc Table with Y Base at Working Height (continued)

Veneer Tables "LKV" Models

Solid Surface Tables "LKS" Models

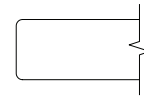

Eased Edge (R3)

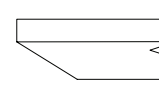

Reverse Bevel Edge (K9)

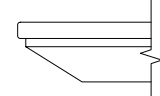

Reverse Bevel Edge (S7)

	D	W	H	CTN WT	CU FT	① Model	Veneer		Solid Surface		
							Essentials	Artisan	Essentials	Artisan	Standard
VENEER	60	240	29	653	281	LKV60240-29TTRY	\$18,509	\$19,989	\$20,175	\$21,485	--
	60	216	29	598	253	LKV60216-29TTRY	\$16,198	\$17,494	\$17,654	\$18,803	--
	54	240	29	584	254	LKV54240-29TTRY	\$15,440	\$16,755	\$16,203	\$17,449	--
	54	216	29	538	229	LKV54216-29TTRY	\$13,697	\$14,858	\$14,398	\$15,501	--
	48	240	29	545	228	LKV48240-29TTRY	\$14,674	\$15,830	\$15,364	\$16,459	--
	48	216	29	492	206	LKV48216-29TTRY	\$13,444	\$14,466	\$14,080	\$15,048	--
SOLID SURFACE	60	240	29	653	281	LKS60240-29TTRY	--	--	--	--	\$42,272
	60	216	29	598	253	LKS60216-29TTRY	--	--	--	--	\$38,130
	54	240	29	584	254	LKS54240-29TTRY	--	--	--	--	\$38,268
	54	216	29	538	229	LKS54216-29TTRY	--	--	--	--	\$33,974
	48	240	29	545	228	LKS48240-29TTRY	--	--	--	--	\$34,719
	48	216	29	492	206	LKS48216-29TTRY	--	--	--	--	\$31,253

Electrical Options and Upcharges

	216 - 240 wide
<b>CT6</b>	
Six Power Center Top - Black	CT6BL - add \$4,949
Six Power Center Top - White	CT6WH - add \$4,949
<b>CU2</b>	
Dual Power Underside - Black	CU2-1C - add \$1,298
Dual Power Underside with 4 Wireless Charging - Black	CU2-1CW - add \$3,278
<b>CT6U2</b>	
Six Power Center Top - Black with Dual Underside	CT6U2-BL - add \$5,748
Six Power Center Top - White with Dual Underside	CT6U2-WH - add \$5,748
Six Power Center Top - Black Dual Underside with 4 Wireless Charging	CT6U2-BLW2 - add \$7,668
Six Power Center Top - White Dual Underside with 4 Wireless Charging	CT6U2-WHW2 - add \$7,668

LOK - CONFERENCE

To Order Specify

Note: Order power infed that best fits application

① Veneer Model #	② Edge Detail	③ Wood Collection	④ Wood Finish	⑤ Electrical	⑥ Metal Color
Veneer (LKV)	<a href="#">See Edge Detail Options</a>	Essentials	<a href="#">See Essentials Wood Finish Options</a>	N None CT6 Six Power Center Top CU2 Dual Power Underside CT6U2 Six Power Center Top with Underside (See chart above)	<a href="#">See Metal Finish Color Options</a>
		Artisan	④ Wood Finish <a href="#">See Artisan Wood Finish Options</a>		

① Solid Surface Model #	② Top Surface Selection	③ Electrical	④ Metal Color
Solid Surface (LKS)	<a href="#">See Solid Surface Top Surface Selection Options</a>	N None CT6 Six Power Center Top CU2 Dual Power Underside CT6U2 Six Power Center Top with Underside (See chart above)	<a href="#">See Metal Finish Color Options</a>

Description

Rounded Rectangular 2pc Table with Y Base at Working Height

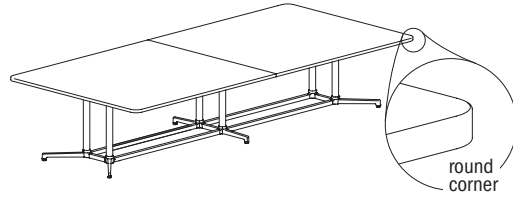

Laminate Tables "LKT" Models

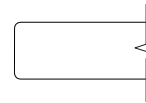

Eased Edge (R3)

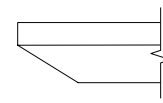

Reverse Bevel Edge (K9)

D	W	H	CTN WT	CU FT	Model	Eased Edge (R3)		Reverse Bevel Edge (K9)	
						Standard Tier 1	Graded In Tier 2	Standard Tier 1	Graded In Tier 2
60	192	29	513	226	LKT60192-29TTRY	\$8,315	\$8,471	\$9,074	\$9,230
60	168	29	460	198	LKT60168-29TTRY	\$7,724	\$7,862	\$8,448	\$8,588
60	144	29	345	169	LKT60144-29TTRY	\$7,037	\$7,155	\$7,723	\$7,841
60	120	29	342	143	LKT60120-29TTRY	\$6,338	\$6,436	\$6,990	\$7,089
54	192	29	462	204	LKT54192-29TTRY	\$8,024	\$8,165	\$8,753	\$8,893
54	168	29	368	178	LKT54168-29TTRY	\$7,144	\$7,270	\$7,841	\$7,965
54	144	29	365	154	LKT54144-29TTRY	\$6,497	\$6,601	\$7,162	\$7,264
54	120	29	316	130	LKT54120-29TTRY	\$5,953	\$6,040	\$6,584	\$6,673
48	192	29	422	183	LKT48192-29TTRY	\$7,802	\$7,931	\$8,498	\$8,623
48	168	29	375	161	LKT48168-29TTRY	\$6,328	\$6,436	\$6,994	\$7,102
48	144	29	333	139	LKT48144-29TTRY	\$5,860	\$5,955	\$6,501	\$6,596
48	120	29	291	116	LKT48120-29TTRY	\$5,296	\$5,376	\$5,908	\$5,986
48	108	29	269	105	LKT48108-29TTRY	\$4,718	\$4,790	\$5,316	\$5,386

LAMINATE

Features:

- price reflects complete table - top and base
- ships KD in multiple cartons
- two piece top
- model includes adjustable glide

Options:

- specify power/charging option, see below for options and upcharges



top shape

Electrical Options and Upcharges

	108 wide	120 - 192 wide
<b>CT2</b>		
Dual Power Center Top - Black	CT2BL - add \$1,837	n/a
Dual Power Center Top - White	CT2WH - add \$1,837	n/a
<b>CU1</b>		
Single Power Underside - Black	CU1-1C - add \$731	CU1-1C - add \$849
Single Power Underside with Wireless Charging - Black	CU1-1CW - add \$1,691	CU1-1CW - add \$1,776
<b>CT2U1</b>		
Dual Power Center Top - Black with Underside	CT2U1-BL - add \$2,235	n/a
Dual Power Center Top - White with Underside	CT2U1-WH - add \$2,235	n/a
Dual Power Center Top - Black with Wireless Charging	CT2U1-BLW2 - add \$3,194	n/a
Dual Power Center Top - White with Wireless Charging	CT2U1-WHW2 - add \$3,194	n/a

Note: Order power infeed that best fits application.

	108 wide	120 - 192 wide
<b>CT4U1</b>		
Four Power Center Top with Single Underside - Black	n/a	CT4U1-BL - add \$3,906
Four Power Center Top with Single Underside - White	n/a	CT4U1-WH - add \$3,906
Four Power Center Top - Black with Underside & Wireless Charging	n/a	CT4U1-BLW2 - add \$4,840
Four Power Center Top - White with Underside & Wireless Charging	n/a	CT4U1-WHW2 - add \$4,840
<b>CT4</b>		
Four Power Center Top - Black	n/a	CT4BL - add \$3,421
Four Power Center Top - White	n/a	CT4WH - add \$3,421

To Order Specify

1 Laminate Model #	2 Edge Detail	3 Laminate Selection	3a PVC Edge Color	4 Electrical	5 Metal Color
Laminate (LKT)	<a href="#">See Edge Detail Options</a>	<a href="#">See Laminate Selection</a>	<a href="#">See PVC Edge Color Options</a>	N None CT2 Dual Power Center Top CU2 Dual Power Underside CT2U1 Dual Power Center Top with Underside CT4U2 Four Power Center Top with Underside CT4 Four Power Center Top (See chart above)	<a href="#">See Metal Finish Color Options</a>

Model Number Breakdown

LKT60192-29TTRY						
LK	T	60192	29	TT	R	Y
LOK	Laminate	60" x 192"	Height	Rectangular Top Shape	Rounded Corner	Y base

Description

Rounded Rectangular 2pc Table with Y Base at Working Height (continued)

Veneer Tables "LKV" Models      Solid Surface Tables "LKS" Models

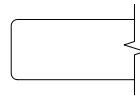

Eased Edge (R3)

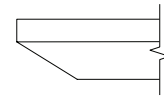

Reverse Bevel Edge (K9)

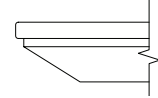

Reverse Bevel Edge (S7)

	D	W	H	CTN WT	CU FT	① Model	Veneer Tables "LKV" Models		Solid Surface Tables "LKS" Models			
							Essentials	Artisan	Essentials	Artisan	Standard	
VENEER	60	192	29	513	226	LKV60192-29TTRY	\$12,962	\$13,999	\$14,129	\$15,047	--	
	60	168	29	460	198	LKV60168-29TTRY	\$11,877	\$12,825	\$12,946	\$13,787	--	
	60	144	29	345	169	LKV60144-29TTRY	\$10,684	\$11,536	\$11,644	\$12,399	--	
	60	120	29	342	143	LKV60120-29TTRY	\$9,571	\$10,333	\$10,428	\$11,107	--	
	54	192	29	462	204	LKV54192-29TTRY	\$12,010	\$12,971	\$13,091	\$13,941	--	
	54	168	29	368	178	LKV54168-29TTRY	\$10,816	\$11,682	\$11,789	\$12,555	--	
	54	144	29	365	154	LKV54144-29TTRY	\$9,705	\$10,482	\$10,578	\$11,267	--	
	54	120	29	316	130	LKV54120-29TTRY	\$8,773	\$9,472	\$9,563	\$10,180	--	
	48	192	29	422	183	LKV48192-29TTRY	\$11,913	\$12,809	\$12,499	\$13,346	--	
	48	168	29	389	161	LKV48168-29TTRY	\$9,643	\$10,415	\$10,177	\$10,902	--	
	48	144	29	333	139	LKV48144-29TTRY	\$8,813	\$9,465	\$9,295	\$9,911	--	
	48	120	29	291	116	LKV48120-29TTRY	\$7,875	\$8,412	\$8,310	\$8,814	--	
	48	108	29	269	105	LKV48108-29TTRY	\$6,767	\$7,308	\$7,375	\$7,855	--	
	SOLID SURFACE	60	192	29	513	226	LKS60192-29TTRY	--	--	--	--	\$31,846
		60	168	29	460	198	LKS60168-29TTRY	--	--	--	--	\$28,074
		60	144	29	345	169	LKS60144-29TTRY	--	--	--	--	\$24,285
60		120	29	342	143	LKS60120-29TTRY	--	--	--	--	\$26,797	
54		192	29	462	204	LKS54192-29TTRY	--	--	--	--	\$28,979	
54		168	29	368	178	LKS54168-29TTRY	--	--	--	--	\$25,555	
54		144	29	365	154	LKS54144-29TTRY	--	--	--	--	\$22,143	
54		120	29	316	130	LKS54120-29TTRY	--	--	--	--	\$18,977	
48		192	29	422	183	LKS48192-29TTRY	--	--	--	--	\$27,334	
48		168	29	375	161	LKS48168-29TTRY	--	--	--	--	\$22,980	
48		144	29	333	139	LKS48144-29TTRY	--	--	--	--	\$20,132	
48		120	29	291	116	LKS48120-29TTRY	--	--	--	--	\$17,245	
48		108	29	269	105	LKS48108-29TTRY	--	--	--	--	\$16,071	

LOK- CONFERENCE

To Order Specify

① Veneer Model #	② Edge Detail	③ Wood Collection	④ Wood Finish	⑤ Electrical	⑥ Metal Color
Veneer (LKV)	<a href="#">See Edge Detail Options</a>	Essentials	<a href="#">See Essentials Wood Finish Options</a>	N None CT2 Dual Power Center Top CU2 Dual Power Underside CT2U1 Dual Power Center Top with Underside CT4U2 Four Power Center Top with Underside CT4 Four Power Center Top (See chart on previous page)	<a href="#">See Metal Finish Color Options</a>
		Artisan	④ Wood Finish <a href="#">See Artisan Wood Finish Options</a>		

① Solid Surface Model #	② Top Surface Selection	③ Electrical	④ Metal Color
Solid Surface (LKS)	<a href="#">See Solid Surface Top Surface Selection Options</a>	N None CT2 Dual Power Center Top CU2 Dual Power Underside CT2U1 Dual Power Center Top with Underside CT4U2 Four Power Center Top with Underside CT4 Four Power Center Top (See chart on previous page)	<a href="#">See Metal Finish Color Options</a>

## Description

Rounded Rectangular Table with Y Base at Working Height

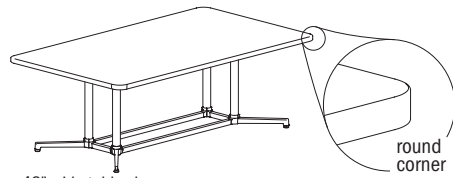

48" wide tables have double column base

LAMINATE	D	W	H	CTN WT	CU FT	Model	Laminate Tables "LKT" Models			
							Eased Edge (R3)		Reverse Bevel Edge (K9)	
							Standard Tier 1	Graded In Tier 2	Standard Tier 1	Graded In Tier 2
	48	96	29	225	105	LKT4896-29TTRY	\$3,898	\$3,960	\$4,479	\$4,541
	48	84	29	333	83	LKT4884-29TTRY	\$3,421	\$3,476	\$3,988	\$4,046
	42	96	29	174	83	LKT4296-29TTRY	\$3,712	\$3,767	\$4,276	\$4,335
	42	84	29	174	72	LKT4284-29TTRY	\$3,109	\$3,157	\$3,664	\$3,715
	36	96	29	152	72	LKT3696-29TTRY	\$2,973	\$3,019	\$3,523	\$3,570
	36	84	29	156	64	LKT3684-29TTRY	\$2,717	\$2,760	\$3,258	\$3,300

### Features:

- price reflects complete table - top and base
- ships KD in multiple cartons
- one piece top
- model includes adjustable glide

### Options:

- specify power/charging option, see below for options and upcharges

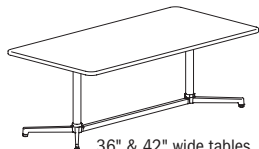

36" & 42" wide tables have single column base



top shape

LOK - CONFERENCE

## To Order Specify

1 Laminite Model #	2 Edge Detail	3 Laminite Selection	3a PVC Edge Color	4 Electrical	5 Metal Color
Laminite (LKT)	<a href="#">See Edge Detail Options</a>	<a href="#">See Laminite Selection</a>	<a href="#">See PVC Edge Color Options</a>	N None CT2 Dual Power Center Top CU2 Dual Power Underside CT2U1 Dual Power Center Top with Underside (See chart on next page)	<a href="#">See Metal Finish Color Options</a>

## Model Number Breakdown

LKT4896-29TTRY						
LK	T	4896	29	TT	R	Y
LOK	Laminite	48" x 96"	Height	Rectangular Top Shape	Rounded Corner	Y base

Description

Rounded Rectangular Table with Y Base at Working Height (continued)

Veneer Tables "LKV" Models

Solid Surface Tables "LKS" Models

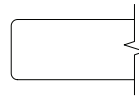

Eased Edge (R3)

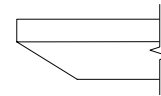

Reverse Bevel Edge (K9)

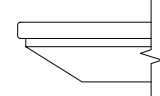

Reverse Bevel Edge (S7)

	D	W	H	CTN WT	CU FT	1 Model	Veneer Tables "LKV" Models		Solid Surface Tables "LKS" Models		
							Essentials	Artisan	Essentials	Artisan	Standard
VENEER	48	96	29	225	105	LKV4896-29TTRY	\$5,426	\$5,842	\$5,806	\$6,196	--
	48	84	29	333	83	LKV4884-29TTRY	\$4,895	\$5,254	\$5,250	\$5,585	--
	42	96	29	174	83	LKV4296-29TTRY	\$5,500	\$5,939	\$5,994	\$6,385	--
	42	84	29	174	72	LKV4284-29TTRY	\$4,678	\$5,051	\$5,098	\$5,430	--
	36	96	29	152	72	LKV3696-29TTRY	\$4,017	\$4,339	\$4,380	\$4,663	--
	36	84	29	156	64	LKV3684-29TTRY	\$3,758	\$4,058	\$4,094	\$4,359	--
SOLID SURFACE	48	96	29	225	105	LKS4896-29TTRY	--	--	--	--	\$12,669
	48	84	29	333	83	LKS4884-29TTRY	--	--	--	--	\$11,183
	42	96	29	174	83	LKS4296-29TTRY	--	--	--	--	\$10,528
	42	84	29	174	72	LKS4284-29TTRY	--	--	--	--	\$9,321
	36	96	29	152	72	LKS3696-29TTRY	--	--	--	--	\$9,052
	36	84	29	156	64	LKS3684-29TTRY	--	--	--	--	\$8,223

Electrical Options and Upcharges

CT2	84 - 96 wide
Dual Power Center Top - Black	CT2BL - add \$1,837
Dual Power Center Top - White	CT2WH - add \$1,837
CU1	
Single Power Underside - Black	CU1-1C - add \$731
Single Power Underside with Wireless Charging - Black	CU1-1CW - add \$1,691
CT2U1	
Dual Power Center Top - Black with Single Underside	CT2U1-BL - add \$2,235
Dual Power Center Top - White with Single Underside	CT2U1-WH - add \$2,235
Dual Power Center Top - Black with Wireless Charging	CT2U1-BLW2 - add \$3,194
Dual Power Center Top - White with Wireless Charging	CT2U1-WhW2 - add \$3,194

Note: Order power infeed that best fits application

To Order Specify

1 Veneer Model #	2 Edge Detail	3 Wood Collection	4 Wood Finish	5 Electrical	6 Metal Color
Veneer (LKV)	<a href="#">See Edge Detail Options</a>	Essentials	<a href="#">See Essentials Wood Finish Options</a>	N None CT2 Dual Power Center Top CU2 Dual Power Underside CT2U1 Dual Power Center Top with Underside (See chart above)	<a href="#">See Metal Finish Color Options</a>
		Artisan	4 Wood Finish <a href="#">See Artisan Wood Finish Options</a>		

1 Solid Surface Model #	2 Top Surface Selection	3 Electrical	4 Metal Color
Solid Surface (LKS)	<a href="#">See Solid Surface Top Surface Selection Options</a>	N None CT2 Dual Power Center Top CU2 Dual Power Underside CT2U1 Dual Power Center Top with Underside (See chart above)	<a href="#">See Metal Finish Color Options</a>

LOK - CONFERENCE

Description

Arc Rectangular 3pc Table with T Base at Working Height

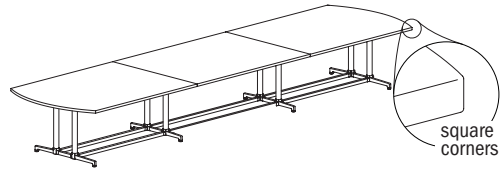

Laminate Tables  
"LKT" Models

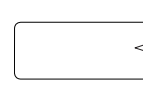

Eased Edge (R3)

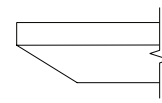

Reverse Bevel Edge (K9)

D	W	H	CTN WT	CU FT	① Model	Eased Edge (R3)		Reverse Bevel Edge (K9)	
						Standard Tier 1	Graded In Tier 2	Standard Tier 1	Graded In Tier 2
60	240	29	648	281	LKT60240-29ART	\$12,271	\$12,471	\$13,108	\$13,305
60	216	29	593	253	LKT60216-29ART	\$10,460	\$10,636	\$11,260	\$11,438
54	240	29	598	254	LKT54240-29ART	\$9,900	\$10,074	\$10,693	\$10,870
54	216	29	549	229	LKT54216-29ART	\$9,380	\$9,539	\$10,143	\$10,302
48	240	29	548	228	LKT48240-29ART	\$9,429	\$9,588	\$10,183	\$10,339
48	216	29	549	206	LKT48216-29ART	\$8,341	\$8,484	\$9,068	\$9,210

LAMINATE

Features:

- price reflects complete table - top and base
- ships KD in multiple cartons
- three piece top
- model includes adjustable glide

Options:

- specify power/charging option, see below for options and upcharges



top shape

LOK - CONFERENCE

To Order Specify

① Laminate Model #	② Edge Detail	③ Laminate Selection	④ PVC Edge Color	⑤ Electrical	⑥ Metal Color
Laminate (LKT)	<a href="#">See Edge Detail Options</a>	<a href="#">See Laminate Selection</a>	<a href="#">See PVC Edge Color Options</a>	N None CT6 Six Power Center Top CU2 Dual Power Underside CT6U2 Six Power Center Top with Underside (See chart on next page)	<a href="#">See Metal Finish Color Options</a>

Model Number Breakdown

LKT60240-29ART					
LK	T	60240	29	TT	T
LOK	Laminate	60" x 240"	Height	Rectangular Top Shape	T base

Description

Arc Rectangular 3pc Table with T Base at Working Height (continued)

Veneer Tables "LKV" Models

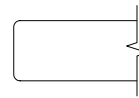

Eased Edge (R3)

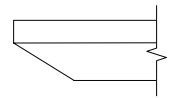

Reverse Bevel Edge (K9)

D	W	H	CTN WT	CU FT	Model	Eased Edge (R3)		Reverse Bevel Edge (K9)	
						Essentials	Artisan	Essentials	Artisan
60	240	29	648	281	LKV60240-29ART	\$19,086	\$20,613	\$20,803	\$22,155
60	216	29	593	253	LKV60216-29ART	\$16,800	\$18,143	\$18,311	\$19,502
54	240	29	598	254	LKV54240-29ART	\$16,169	\$17,479	\$16,932	\$18,176
54	216	29	549	229	LKV54216-29ART	\$15,108	\$16,271	\$15,806	\$16,911
48	240	29	548	228	LKV48240-29ART	\$15,170	\$16,325	\$15,864	\$16,954
48	216	29	549	206	LKV48216-29ART	\$13,324	\$14,350	\$13,964	\$14,932

VENEER

Electrical Options and Upcharges

	216 - 240 wide
<b>CT6</b>	
Six Power Center Top - Black	CT6BL - add \$4,949
Six Power Center Top - White	CT6WH - add \$4,949
<b>CU2</b>	
Dual Power Underside - Black	CU2-1C - add \$1,298
Dual Power Underside with 4 Wireless Charging - Black	CU2-1CW - add \$3,278
<b>CT6U2</b>	
Six Power Center Top - Black with Dual Underside	CT6U2-BL - add \$5,748
Six Power Center Top - White with Dual Underside	CT6U2-WH - add \$5,748
Six Power Center Top- Black Dual Underside with 4 Wireless Charging	CT6U2-BLW2 - add \$7,668
Six Power Center Top- White Dual Underside with 4 Wireless Charging	CT6U2-WHW2 - add \$7,668

Note: Order power infeed that best fits application

To Order Specify

1 Veneer Model #	2 Edge Detail	3 Wood Collection	4 Wood Finish	5 Electrical	6 Metal Color
Veneer (LKV)	<a href="#">See Edge Detail Options</a>	Essentials	<a href="#">See Essentials Wood Finish Options</a>	N None CT6 Six Power Center Top CU2 Dual Power Underside CT6U2 Six Power Center Top with Underside (See chart above)	<a href="#">See Metal Finish Color Options</a>
		Artisan	<b>4 Wood Finish</b> <a href="#">See Artisan Wood Finish Options</a>		

LOK- CONFERENCE

Description

Arc Rectangular 2pc Table with T Base at Working Height

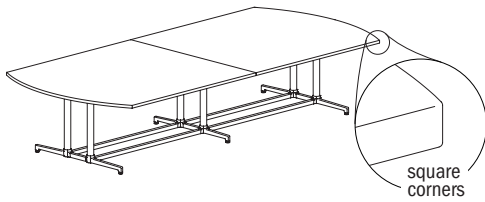

Laminate Tables "LKT" Models

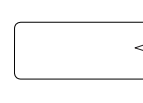

Eased Edge (R3)

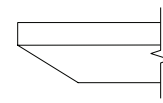

Reverse Bevel Edge (K9)

	D	W	H	CTN WT	CU FT	Model	Eased Edge (R3)		Reverse Bevel Edge (K9)	
							Standard Tier 1	Graded In Tier 2	Standard Tier 1	Graded In Tier 2
LAMINATE	60	192	29	507	226	LKT60192-29ART	\$8,547	\$8,708	\$9,307	\$9,465
	60	168	29	453	198	LKT60168-29ART	\$7,977	\$8,115	\$8,699	\$8,838
	60	144	29	396	169	LKT60144-29ART	\$7,360	\$7,478	\$8,048	\$8,165
	60	120	29	339	143	LKT60120-29ART	\$6,526	\$6,623	\$7,176	\$7,275
	54	192	29	467	204	LKT54192-29ART	\$8,133	\$8,277	\$8,861	\$9,004
	54	168	29	389	178	LKT54168-29ART	\$7,367	\$7,493	\$8,065	\$8,187
	54	144	29	368	154	LKT54144-29ART	\$6,787	\$6,895	\$7,452	\$7,558
	54	120	29	316	130	LKT54120-29ART	\$6,081	\$6,169	\$6,708	\$6,798
	48	192	29	429	183	LKT48192-29ART	\$7,097	\$7,224	\$7,793	\$7,918
	48	168	29	385	161	LKT48168-29ART	\$6,598	\$6,708	\$7,264	\$7,375
	48	144	29	339	139	LKT48144-29ART	\$6,053	\$6,147	\$6,691	\$6,787
	48	120	29	293	116	LKT48120-29ART	\$5,439	\$5,518	\$6,051	\$6,130
	48	108	29	270	105	LKT48108-29ART	\$4,609	\$4,678	\$5,202	\$5,274

Features:

- price reflects complete table - top and base
- ships KD in multiple cartons
- two piece top
- model includes adjustable glide

Options:

- specify power/charging option, see below for options and upcharges

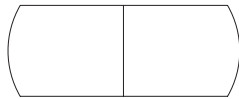

top shape

LOK - CONFERENCE

To Order Specify

1 Laminate Model #	2 Edge Detail	3 Laminate Selection	3a PVC Edge Color	4 Electrical	5 Metal Color
Laminate (LKT)	<a href="#">See Edge Detail Options</a>	<a href="#">See Laminate Selection</a>	<a href="#">See PVC Edge Color Options</a>	N None CT2 Dual Power Center Top CU2 Dual Power Underside CT2U1 Dual Power Center Top with Underside CT4U2 Four Power Center Top with Underside CT4 Four Power Center Top (See chart on next page)	<a href="#">See Metal Finish Color Options</a>

Model Number Breakdown

LKT60192-29ART					
LK	T	60192	29	TT	T
LOK	Laminate	60" x 192"	Height	Rectangular Top Shape	T base

Description

Arc Rectangular 2pc Table with T Base at Working Height (continued)

Veneer Tables "LKV" Models

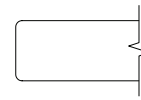

Eased Edge (R3)

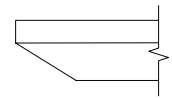

Reverse Bevel Edge (K9)

D	W	H	CTN WT	CU FT	Model	Eased Edge (R3)		Reverse Bevel Edge (K9)		
						Essentials	Artisan	Essentials	Artisan	
60	192	29	507	226	LKV60192-29ART	\$13,301	\$14,366	\$14,497	\$15,439	
60	168	29	453	198	LKV60168-29ART	\$12,235	\$13,213	\$13,335	\$14,202	
60	144	29	396	169	LKV60144-29ART	\$11,137	\$12,028	\$12,138	\$12,928	
60	120	29	339	143	LKV60120-29ART	\$9,827	\$10,613	\$10,712	\$11,405	
VENEER	54	192	29	467	204	LKV54192-29ART	\$12,166	\$13,143	\$13,263	\$14,122
	54	168	29	389	178	LKV54168-29ART	\$11,127	\$12,018	\$12,128	\$12,916
	54	144	29	368	154	LKV54144-29ART	\$10,106	\$10,914	\$11,017	\$11,730
	54	120	29	316	130	LKV54120-29ART	\$8,944	\$9,658	\$9,747	\$10,378
48	192	29	429	183	LKV48192-29ART	\$10,927	\$11,822	\$11,511	\$12,356	
48	168	29	385	161	LKV48168-29ART	\$10,017	\$10,790	\$10,549	\$11,281	
48	144	29	339	139	LKV48144-29ART	\$9,072	\$9,725	\$9,556	\$10,170	
48	120	29	293	116	LKV48120-29ART	\$8,065	\$8,601	\$8,500	\$9,003	
48	108	29	270	105	LKV48108-29ART	\$6,622	\$7,152	\$7,217	\$7,685	

Electrical Options and Upcharges

CT2	108 wide	120 - 192 wide
Dual Power Center Top - Black	CT2BL - add \$1,837	n/a
Dual Power Center Top - White	CT2WH - add \$1,837	n/a
CU1		
Single Power Underside - Black	CU1-1C - add \$731	CU1-1C - add \$849
Single Power Underside with Wireless Charging - Black	CU1-1CW - add \$1,691	CU1-1CW - add \$1,776
CT2U1		
Dual Power Center Top - Black with Underside	CT2U1-BL - add \$2,235	n/a
Dual Power Center Top - White with Underside	CT2U1-WH - add \$2,235	n/a
Dual Power Center Top - Black with Wireless Charging	CT2U1-BLW2 - add \$3,194	n/a
Dual Power Center Top - White with Wireless Charging	CT2U1-WHW2 - add \$3,194	n/a

CT4U1	108 wide	120 - 192 wide
Four Power Center Top with Single Underside - Black	n/a	CT4U1-BL - add \$3,906
Four Power Center Top with Single Underside - White	n/a	CT4U1-WH - add \$3,906
Four Power Center Top - Black with Underside & Wireless Charging	n/a	CT4U1-BLW2 - add \$4,840
Four Power Center Top - White with Underside & Wireless Charging	n/a	CT4U1-WHW2 - add \$4,840
CT4		
Four Power Center Top - Black	n/a	CT4BL - add \$3,421
Four Power Center Top - White	n/a	CT4WH - add \$3,421

Note: Order power infeed that best fits application

To Order Specify

1 Veneer Model #	2 Edge Detail	3 Wood Collection	4 Wood Finish	5 Electrical	6 Metal Color
Veneer (LKV)	<a href="#">See Edge Detail Options</a>	Essentials	<a href="#">See Essentials Wood Finish Options</a>	N None CT2 Dual Power Center Top CU2 Dual Power Underside CT2U1 Dual Power Center Top with Underside CT4U2 Four Power Center Top with Underside CT4 Four Power Center Top	<a href="#">See Metal Finish Color Options</a>
		Artisan	4 Wood Finish <a href="#">See Artisan Wood Finish Options</a>		

LOK - CONFERENCE

Description

Arc Rectangular Table with T Base at Working Height

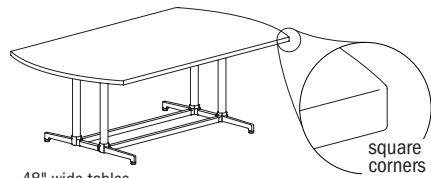

48" wide tables have double column base

D	W	H	CTN WT	CU FT	Model	Laminate Tables "LKT" Models			
						Eased Edge (R3)		Reverse Bevel Edge (K9)	
						Standard Tier 1	Graded In Tier 2	Standard Tier 1	Graded In Tier 2
48	96	29	219	83	LKT4896-29ART	\$3,875	\$3,936	\$4,456	\$4,521
48	84	29	196	83	LKT4884-29ART	\$3,439	\$3,498	\$4,007	\$4,062
42	96	29	179	73	LKT4296-29ART	\$3,517	\$3,572	\$4,084	\$4,138
42	84	29	158	72	LKT4284-29ART	\$2,897	\$2,947	\$3,455	\$3,503
36	96	29	160	72	LKT3696-29ART	\$2,957	\$3,007	\$3,510	\$3,557
36	84	29	148	64	LKT3684-29ART	\$2,655	\$2,694	\$3,194	\$3,238

LAMINATE

Features:

- price reflects complete table - top and base
- ships KD in multiple cartons
- one piece top
- model includes adjustable glide

Options:

- specify power/charging option, see below for options and upcharges

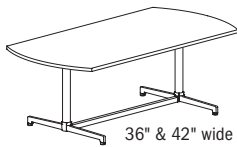

36" & 42" wide tables have single column base



top shape

LOK - CONFERENCE

To Order Specify

1 Laminate Model #	2 Edge Detail	3 Laminate Selection	3a PVC Edge Color	4 Electrical	5 Metal Color
Laminate (LKT)	<a href="#">See Edge Detail Options</a>	<a href="#">See Laminate Selection</a>	<a href="#">See PVC Edge Color Options</a>	N None CT2 Dual Power Center Top CU2 Dual Power Underside CT2U1 Dual Power Center Top with Underside (See chart on next page)	<a href="#">See Metal Finish Color Options</a>

Model Number Breakdown

LKT4896-29ART					
LK	T	4896	29	AR	T
LOK	Laminate	48" x 96"	Height	Arc Rectangular Top Shape	T base

Description

Arc Rectangular Table with T Base at Working Height (continued)

Veneer Tables "LKV" Models

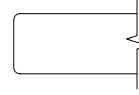

Eased Edge (R3)

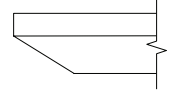

Reverse Bevel Edge (K9)

D	W	H	CTN WT	CU FT	Model	Eased Edge (R3)		Reverse Bevel Edge (K9)	
						Essentials	Artisan	Essentials	Artisan
48	96	29	219	83	LKV4896-29ART	\$5,395	\$5,810	\$5,776	\$6,168
48	84	29	196	83	LKV4884-29ART	\$4,922	\$5,281	\$5,276	\$5,610
42	96	29	179	73	LKV4296-29ART	\$5,256	\$5,678	\$5,729	\$6,100
42	84	29	158	72	LKV4284-29ART	\$4,419	\$4,771	\$4,817	\$5,131
36	96	29	160	72	LKV3696-29ART	\$4,001	\$4,320	\$4,359	\$4,644
36	84	29	148	64	LKV3684-29ART	\$3,682	\$3,973	\$4,012	\$4,270

VENEER

Electrical Options and Upcharges

CT2	84 - 96 wide
Dual Power Center Top - Black	CT2BL - add \$1,837
Dual Power Center Top - White	CT2WH - add \$1,837
CU1	
Single Power Underside - Black	CU1-1C - add \$731
Single Power Underside with Wireless Charging - Black	CU1-1CW - add \$1,691
CT2U1	
Dual Power Center Top - Black with Single Underside	CT2U1-BL - add \$2,235
Dual Power Center Top - White with Single Underside	CT2U1-WH - add \$2,235
Dual Power Center Top - Black with Wireless Charging	CT2U1-BLW2 - add \$3,194
Dual Power Center Top - White with Wireless Charging	CT2U1-WHW2 - add \$3,194

Note: Order power infed that best fits application

To Order Specify

1 Veneer Model #	2 Edge Detail	3 Wood Collection	4 Wood Finish	5 Electrical	6 Metal Color
Veneer (LKV)	<a href="#">See Edge Detail Options</a>	Essentials	<a href="#">See Essentials Wood Finish Options</a>	N None CT2 Dual Power Center Top CU2 Dual Power Underside CT2U1 Dual Power Center Top with Underside (See chart above)	<a href="#">See Metal Finish Color Options</a>
		Artisan	4 Wood Finish <a href="#">See Artisan Wood Finish Options</a>		

Description

Rounded Arc Rectangular 3pc Table with T Base at Working Height

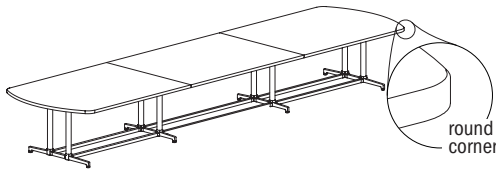

Laminate Tables  
"LKT" Models

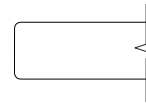

Eased Edge (R3)

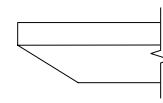

Reverse Bevel Edge (K9)

LAMINATE	D	W	H	CTN WT	CU FT	1 Model	Standard Tier 1	Graded In Tier 2	Standard Tier 1	Graded In Tier 2
		60	240	29	648	281	LKT60240-29ARRT	\$12,271	\$12,471	\$13,108
	60	216	29	593	253	LKT60216-29ARRT	\$10,460	\$10,636	\$11,260	\$11,438
	54	240	29	598	254	LKT54240-29ARRT	\$9,900	\$10,074	\$10,693	\$10,870
	54	216	29	549	229	LKT54216-29ARRT	\$9,309	\$9,470	\$10,073	\$10,232
	48	240	29	548	228	LKT48240-29ARRT	\$9,429	\$9,588	\$10,183	\$10,339
	48	216	29	549	206	LKT48216-29ARRT	\$8,341	\$8,484	\$9,068	\$9,210

Features:

- price reflects complete table - top and base
- ships KD in multiple cartons
- three piece top
- model includes adjustable glide

Options:

- specify power/charging option, see below for options and upcharges

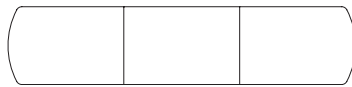

top shape

LOK - CONFERENCE

To Order Specify

1 Laminate Model #	2 Edge Detail	3 Laminate Selection	3a PVC Edge Color	4 Electrical	5 Metal Color
Laminate (LKT)	<a href="#">See Edge Detail Options</a>	<a href="#">See Laminate Selection</a>	<a href="#">See PVC Edge Color Options</a>	N None CT6 Six Power Center Top CU2 Dual Power Underside CT6U2 Six Power Center Top with Underside (See chart on next page)	<a href="#">See Metal Finish Color Options</a>

Model Number Breakdown

LKT60240-29ARRT						
LK	T	60240	29	AR	R	T
LOK	Laminate	60" x 240"	Height	Arc Rectangular Top Shape	Rounded Corner	T base

Description

Rounded Arc Rectangular 3pc Table with T Base at Working Height (continued)

Veneer Tables "LKV" Models

Solid Surface Tables "LKS" Models

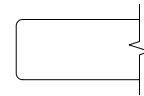

Eased Edge (R3)

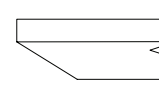

Reverse Bevel Edge (K9)

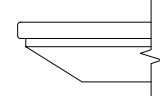

Reverse Bevel Edge (S7)

	D	W	H	CTN WT	CU FT	① Model	Veneer		Solid Surface		
							Essentials	Artisan	Essentials	Artisan	Standard
VENEER	60	240	29	648	281	LKV60240-29ARRT	\$19,086	\$20,613	\$20,803	\$22,155	--
	60	216	29	593	253	LKV60216-29ARRT	\$16,800	\$18,143	\$18,311	\$19,502	--
	54	240	29	598	254	LKV54240-29ARRT	\$16,169	\$17,479	\$16,932	\$18,176	--
	54	216	29	549	229	LKV54216-29ARRT	\$15,005	\$16,169	\$15,705	\$16,809	--
	48	240	29	548	228	LKV48240-29ARRT	\$15,170	\$16,325	\$15,864	\$16,954	--
	48	216	29	549	206	LKV48216-29ARRT	\$13,324	\$14,350	\$13,964	\$14,932	--
SOLID SURFACE	60	240	29	648	281	LKS60240-29ARRT	--	--	--	--	\$42,849
	60	216	29	593	253	LKS60216-29ARRT	--	--	--	--	\$38,729
	54	240	29	598	254	LKS54240-29ARRT	--	--	--	--	\$38,990
	54	216	29	549	229	LKS54216-29ARRT	--	--	--	--	\$35,281
	48	240	29	548	228	LKS48240-29ARRT	--	--	--	--	\$35,212
	48	216	29	549	206	LKS48216-29ARRT	--	--	--	--	\$31,136

Electrical Options and Upcharges

	216 - 240 wide
<b>CT6</b>	
Six Power Center Top - Black	CT6BL - add \$4,949
Six Power Center Top - White	CT6WH - add \$4,949
<b>CU2</b>	
Dual Power Underside - Black	CU2-1C - add \$1,298
Dual Power Underside with 4 Wireless Charging - Black	CU2-1CW - add \$3,278
<b>CT6U2</b>	
Six Power Center Top - Black with Dual Underside	CT6U2-BL - add \$5,748
Six Power Center Top - White with Dual Underside	CT6U2-WH - add \$5,748
Six Power Center Top - Black	CT6U2-BLW2 - add \$7,668
Dual Underside with 4 Wireless Charging	CT6U2-BLW2 - add \$7,668
Six Power Center Top - White	CT6U2-WHW2 - add \$7,668
Dual Underside with 4 Wireless Charging	CT6U2-WHW2 - add \$7,668

LOK - CONFERENCE

To Order Specify

Note: Order power infed that best fits application

① Veneer Model #	② Edge Detail	③ Wood Collection	④ Wood Finish	⑤ Electrical	⑥ Metal Color
Veneer (LKV)	<a href="#">See Edge Detail Options</a>	Essentials	<a href="#">See Essentials Wood Finish Options</a>	N None CT6 Six Power Center Top CU2 Dual Power Underside CT6U2 Six Power Center Top with Underside (See chart above)	<a href="#">See Metal Finish Color Options</a>
		Artisan	④ Wood Finish <a href="#">See Artisan Wood Finish Options</a>		

① Solid Surface Model #	② Top Surface Selection	③ Electrical	④ Metal Color
Solid Surface (LKS)	<a href="#">See Solid Surface Top Surface Selection Options</a>	N None CT6 Six Power Center Top CU2 Dual Power Underside CT6U2 Six Power Center Top with Underside (See chart above)	<a href="#">See Metal Finish Color Options</a>

Description

Rounded Arc Rectangular 2pc Table with T Base at Working Height

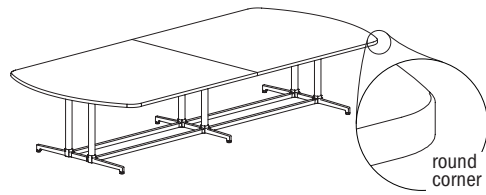

Laminate Tables "LKT" Models

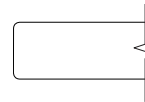

Eased Edge (R3)

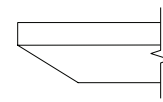

Reverse Bevel Edge (K9)

D	W	H	CTN WT	CU FT	Model	Eased Edge (R3)		Reverse Bevel Edge (K9)	
						Standard Tier 1	Graded In Tier 2	Standard Tier 1	Graded In Tier 2
60	192	29	507	226	LKT60192-29ARRT	\$8,547	\$8,708	\$9,307	\$9,465
60	168	29	453	198	LKT60168-29ARRT	\$7,977	\$8,115	\$8,699	\$8,838
60	144	29	396	169	LKT60144-29ARRT	\$7,360	\$7,478	\$8,048	\$8,165
60	120	29	339	143	LKT60120-29ARRT	\$6,526	\$6,623	\$7,176	\$7,275
54	192	29	467	204	LKT54192-29ARRT	\$8,133	\$8,277	\$8,861	\$9,004
54	168	29	389	178	LKT54168-29ARRT	\$7,367	\$7,493	\$8,065	\$8,187
54	144	29	368	154	LKT54144-29ARRT	\$6,787	\$6,895	\$7,452	\$7,558
54	120	29	316	130	LKT54120-29ARRT	\$6,081	\$6,169	\$6,708	\$6,798
48	192	29	429	183	LKT48192-29ARRT	\$7,097	\$7,224	\$7,793	\$7,918
48	168	29	385	161	LKT48168-29ARRT	\$6,598	\$6,708	\$7,264	\$7,375
48	144	29	339	139	LKT48144-29ARRT	\$6,952	\$7,045	\$7,589	\$7,684
48	120	29	293	116	LKT48120-29ARRT	\$5,439	\$5,518	\$6,051	\$6,130
48	108	29	270	105	LKT48108-29ARRT	\$4,609	\$4,678	\$5,202	\$5,274

LAMINATE

Features:

- price reflects complete table - top and base
- ships KD in multiple cartons
- two piece top
- model includes adjustable glide

Options:

- specify power/charging option, see below for options and upcharges



top shape

Electrical Options and Upcharges

	108 wide	120 - 192 wide
<b>CT2</b>		
Dual Power Center Top - Black	CT2BL - add \$1,837	n/a
Dual Power Center Top - White	CT2WH - add \$1,837	n/a
<b>CU1</b>		
Single Power Underside - Black	CU1-1C - add \$731	CU1-1C - add \$849
Single Power Underside with Wireless Charging - Black	CU1-1CW - add \$1,691	CU1-1CW - add \$1,776
<b>CT2U1</b>		
Dual Power Center Top - Black with Underside	CT2U1-BL - add \$2,235	n/a
Dual Power Center Top - White with Underside	CT2U1-WH - add \$2,235	n/a
Dual Power Center Top - Black with Wireless Charging	CT2U1-BLW2 - add \$3,194	n/a
Dual Power Center Top - White with Wireless Charging	CT2U1-WHW2 - add \$3,194	n/a

Note: Order power infeed that best fits application.

	108 wide	120 - 192 wide
<b>CT4U1</b>		
Four Power Center Top with Single Underside - Black	n/a	CT4U1-BL - add \$3,906
Four Power Center Top with Single Underside - White	n/a	CT4U1-WH - add \$3,906
Four Power Center Top - Black with Underside & Wireless Charging	n/a	CT4U1-BLW2 - add \$4,840
Four Power Center Top - White with Underside & Wireless Charging	n/a	CT4U1-WHW2 - add \$4,840
<b>CT4</b>		
Four Power Center Top - Black	n/a	CT4BL - add \$3,421
Four Power Center Top - White	n/a	CT4WH - add \$3,421

To Order Specify

1 Laminate Model #	2 Edge Detail	3 Laminate Selection	3a PVC Edge Color	4 Electrical	5 Metal Color
Laminate (LKT)	<a href="#">See Edge Detail Options</a>	<a href="#">See Laminate Selection</a>	<a href="#">See PVC Edge Color Options</a>	N None CT2 Dual Power Center Top CU2 Dual Power Underside CT2U1 Dual Power Center Top with Underside CT4U2 Four Power Center Top with Underside CT4 Four Power Center Top (See chart above)	<a href="#">See Metal Finish Color Options</a>

Model Number Breakdown

LKT60192-29ARRT						
LK	T	60192	29	AR	R	T
LOK	Laminate	60" x 192"	Height	Arc Rectangular Top Shape	Rounded Corner	T base

LOK - CONFERENCE

Description

Rounded Arc Rectangular 2pc  
Table with T Base at Working Height  
(continued)

Veneer Tables  
"LKV" Models

Solid Surface Tables  
"LKS" Models

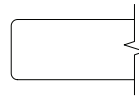

Eased Edge (R3)

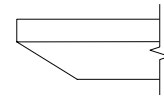

Reverse Bevel Edge (K9)

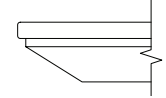

Reverse Bevel Edge (S7)

	D	W	H	CTN WT	CU FT	① Model	Veneer Tables "LKV" Models		Solid Surface Tables "LKS" Models			
							Essentials	Artisan	Essentials	Artisan	Standard	
VENEER	60	192	29	507	226	LKV60192-29ARRT	\$13,301	\$14,366	\$14,497	\$15,439	--	
	60	168	29	453	198	LKV60168-29ARRT	\$12,235	\$13,213	\$13,335	\$14,202	--	
	60	144	29	396	169	LKV60144-29ARRT	\$11,137	\$12,028	\$12,138	\$12,928	--	
	60	120	29	339	143	LKV60120-29ARRT	\$9,827	\$10,613	\$10,712	\$11,405	--	
	54	192	29	467	204	LKV54192-29ARRT	\$12,166	\$13,143	\$13,263	\$14,122	--	
	54	168	29	389	178	LKV54168-29ARRT	\$11,127	\$12,018	\$12,128	\$12,916	--	
	54	144	29	368	154	LKV54144-29ARRT	\$10,106	\$10,914	\$11,017	\$11,730	--	
	54	120	29	316	130	LKV54120-29ARRT	\$8,944	\$9,658	\$9,747	\$10,378	--	
	48	192	29	429	183	LKV48192-29ARRT	\$10,927	\$11,822	\$11,511	\$12,356	--	
	48	168	29	385	161	LKV48168-29ARRT	\$10,017	\$10,790	\$10,549	\$11,281	--	
	48	144	29	339	139	LKV48144-29ARRT	\$9,072	\$9,725	\$9,556	\$10,170	--	
	48	120	29	293	116	LKV48120-29ARRT	\$8,065	\$8,601	\$8,500	\$9,003	--	
	48	108	29	270	105	LKV48108-29ARRT	\$6,622	\$7,152	\$7,217	\$7,685	--	
	SOLID SURFACE	60	192	29	507	226	LKS60192-29ARRT	--	--	--	--	\$32,183
		60	168	29	453	198	LKS60168-29ARRT	--	--	--	--	\$28,438
		60	144	29	396	169	LKS60144-29ARRT	--	--	--	--	\$24,738
60		120	29	339	143	LKS60120-29ARRT	--	--	--	--	\$27,055	
54		192	29	467	204	LKS54192-29ARRT	--	--	--	--	\$29,137	
54		168	29	389	178	LKS54168-29ARRT	--	--	--	--	\$25,867	
54		144	29	368	154	LKS54144-29ARRT	--	--	--	--	\$22,540	
54		120	29	316	130	LKS54120-29ARRT	--	--	--	--	\$19,149	
48		192	29	429	183	LKS48192-29ARRT	--	--	--	--	\$26,347	
48		168	29	385	161	LKS48168-29ARRT	--	--	--	--	\$23,357	
48		144	29	339	139	LKS48144-29ARRT	--	--	--	--	\$20,391	
48		120	29	293	116	LKS48120-29ARRT	--	--	--	--	\$17,434	
48		108	29	270	105	LKS48108-29ARRT	--	--	--	--	\$15,926	

LOK- CONFERENCE

To Order Specify

① Veneer Model #	② Edge Detail	③ Wood Collection	④ Wood Finish	⑤ Electrical	⑥ Metal Color
Veneer (LKV)	<a href="#">See Edge Detail Options</a>	Essentials	<a href="#">See Essentials Wood Finish Options</a>	N None CT2 Dual Power Center Top CU2 Dual Power Underside CT2U1 Dual Power Center Top with Underside CT4U2 Four Power Center Top with Underside CT4 Four Power Center Top (See chart on previous page)	<a href="#">See Metal Finish Color Options</a>
		Artisan	④ Wood Finish <a href="#">See Artisan Wood Finish Options</a>		

① Solid Surface Model #	② Top Surface Selection	③ Electrical	④ Metal Color
Solid Surface (LKS)	<a href="#">See Solid Surface Top Surface Selection Options</a>	N None CT2 Dual Power Center Top CU2 Dual Power Underside CT2U1 Dual Power Center Top with Underside CT4U2 Four Power Center Top with Underside CT4 Four Power Center Top (See chart on previous page)	<a href="#">See Metal Finish Color Options</a>

Description

Rounded Arc Rectangular Table with T Base at Working Height

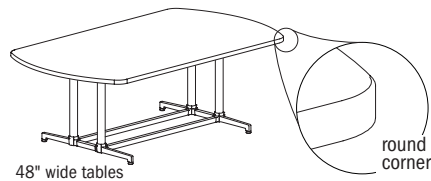

48" wide tables have double column base

D	W	H	CTN WT	CU FT	Model
---	---	---	--------	-------	-------

LAMINATE

48	96	29	219	83	LKT4896-29ARRT
48	84	29	196	83	LKT4884-29ARRT
42	96	29	179	83	LKT4296-29ARRT
42	84	29	158	73	LKT4284-29ARRT
36	96	29	160	72	LKT3696-29ARRT
36	84	29	148	64	LKT3684-29ARRT

Laminate Tables "LKT" Models

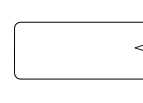

Eased Edge (R3)

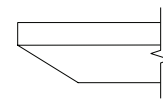

Reverse Bevel Edge (K9)

Eased Edge (R3)		Reverse Bevel Edge (K9)	
Standard Tier 1	Graded In Tier 2	Standard Tier 1	Graded In Tier 2
\$3,875	\$3,936	\$4,456	\$4,521
\$3,439	\$3,498	\$4,007	\$4,062
\$3,517	\$3,572	\$4,084	\$4,138
\$2,897	\$2,947	\$3,455	\$3,503
\$2,957	\$3,007	\$3,510	\$3,557
\$2,655	\$2,694	\$3,194	\$3,238

Features:

- price reflects complete table - top and base
- ships KD in multiple cartons
- one piece top
- model includes adjustable glide

Options:

- specify power/charging option, see below for options and upcharges

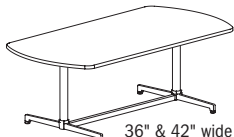

36" & 42" wide tables have single column base



top shape

LOK - CONFERENCE

To Order Specify

1 Laminate Model #	2 Edge Detail	3 Laminate Selection	3a PVC Edge Color	4 Electrical	5 Metal Color
Laminate (LKT)	<a href="#">See Edge Detail Options</a>	<a href="#">See Laminate Selection</a>	<a href="#">See PVC Edge Color Options</a>	N None CT2 Dual Power Center Top CU2 Dual Power Underside CT2U1 Dual Power Center Top with Underside (See chart on next page)	<a href="#">See Metal Finish Color Options</a>

Model Number Breakdown

LKT4896-29ARRT						
LK	T	4896	29	AR	R	T
LOK	Laminate	48" x 96"	Height	Arc Rectangular Top Shape	Rounded Corner	T base

Description

Rounded Arc Rectangular Table with T Base at Working Height (continued)

Veneer Tables "LKV" Models      Solid Surface Tables "LKS" Models

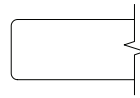

Eased Edge (R3)

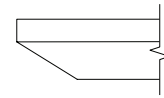

Reverse Bevel Edge (K9)

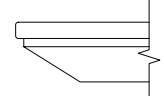

Reverse Bevel Edge (S7)

	D	W	H	CTN WT	CU FT	① Model	Veneer		Solid Surface		
							Essentials	Artisan	Essentials	Artisan	Standard
VENEER	48	96	29	219	83	LKV4896-29ARRT	\$5,395	\$5,810	\$5,776	\$6,168	--
	48	84	29	196	83	LKV4884-29ARRT	\$4,922	\$5,281	\$5,276	\$5,610	--
	42	96	29	179	83	LKV4296-29ARRT	\$5,256	\$5,678	\$5,729	\$6,100	--
	42	84	29	158	73	LKV4284-29ARRT	\$4,419	\$4,771	\$4,817	\$5,131	--
	36	96	29	160	72	LKV3696-29ARRT	\$4,001	\$4,320	\$4,359	\$4,644	--
	36	84	29	148	64	LKV3684-29ARRT	\$3,682	\$3,973	\$4,012	\$4,270	--
SOLID SURFACE	48	96	29	219	83	LKS4896-29ARRT	--	--	--	--	\$12,641
	48	84	29	196	83	LKS4884-29ARRT	--	--	--	--	\$11,205
	42	96	29	179	83	LKS4296-29ARRT	--	--	--	--	\$10,285
	42	84	29	158	73	LKS4284-29ARRT	--	--	--	--	\$9,066
	36	96	29	160	72	LKS3696-29ARRT	--	--	--	--	\$9,038
	36	84	29	148	64	LKS3684-29ARRT	--	--	--	--	\$8,146

Electrical Options and Upcharges

CT2	84 - 96 wide
Dual Power Center Top - Black	CT2BL - add \$1,837
Dual Power Center Top - White	CT2WH - add \$1,837
CU1	
Single Power Underside - Black	CU1-1C - add \$731
Single Power Underside with Wireless Charging - Black	CU1-1CW - add \$1,691
CT2U1	
Dual Power Center Top - Black with Single Underside	CT2U1-BL - add \$2,235
Dual Power Center Top - White with Single Underside	CT2U1-WH - add \$2,235
Dual Power Center Top - Black with Wireless Charging	CT2U1-BLW2 - add \$3,194
Dual Power Center Top - White with Wireless Charging	CT2U1-WHW2 - add \$3,194

LOK - CONFERENCE

Note: Order power infeed that best fits application

To Order Specify

① Veneer Model #	② Edge Detail	③ Wood Collection	④ Wood Finish	⑤ Electrical	⑥ Metal Color
Veneer (LKV)	<a href="#">See Edge Detail Options</a>	Essentials	<a href="#">See Essentials Wood Finish Options</a>	N None CT2 Dual Power Center Top CU2 Dual Power Underside CT2U1 Dual Power Center Top with Underside (See chart above)	<a href="#">See Metal Finish Color Options</a>
		Artisan	④ Wood Finish <a href="#">See Artisan Wood Finish Options</a>		

① Solid Surface Model #	② Top Surface Selection	③ Electrical	④ Metal Color
Solid Surface (LKS)	<a href="#">See Solid Surface Top Surface Selection Options</a>	N None CT2 Dual Power Center Top CU2 Dual Power Underside CT2U1 Dual Power Center Top with Underside (See chart above)	<a href="#">See Metal Finish Color Options</a>

Description

Arc Rectangular 3pc Table with Y Base at Working Height

Laminate Tables "LKT" Models

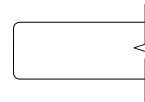
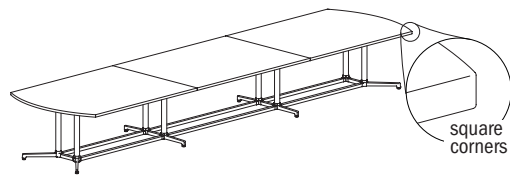

Eased Edge (R3)

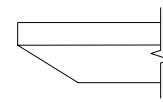

Reverse Bevel Edge (K9)

LAMINATE	D	W	H	CTN WT	CU FT	Model	Standard Tier 1	Graded In Tier 2	Standard Tier 1	Graded In Tier 2
		60	240	29	648	281	LKT60240-29ARY	\$11,889	\$12,084	\$12,723
	60	216	29	593	253	LKT60216-29ARY	\$10,053	\$10,232	\$10,852	\$11,030
	54	240	29	575	254	LKT54240-29ARY	\$9,406	\$9,582	\$10,200	\$10,376
	54	216	29	529	229	LKT54216-29ARY	\$8,408	\$8,568	\$9,169	\$9,329
	48	240	29	548	228	LKT48240-29ARY	\$9,088	\$9,249	\$9,841	\$9,999
	48	216	29	486	206	LKT48216-29ARY	\$8,423	\$8,566	\$9,152	\$9,291

Features:

- price reflects complete table - top and base
- ships KD in multiple cartons
- three piece top
- model includes adjustable glide

Options:

- specify power/charging option, see below for options and upcharges



top shape

LOK - CONFERENCE

To Order Specify

1 Laminate Model #	2 Edge Detail	3 Laminate Selection	4 PVC Edge Color	5 Electrical	6 Metal Color
Laminate (LKT)	<a href="#">See Edge Detail Options</a>	<a href="#">See Laminate Selection</a>	<a href="#">See PVC Edge Color Options</a>	N None CT6 Six Power Center Top CU2 Dual Power Underside CT6U2 Six Power Center Top with Underside (See chart on next page)	<a href="#">See Metal Finish Color Options</a>

Model Number Breakdown

LKT60240-29ARY					
LK	T	60240	29	AR	Y
LK	Laminate	60" x 240"	Height	Arc Rectangular Top Shape	Y base

Description

Arc Rectangular 3pc Table with Y Base at Working Height (continued)

Veneer Tables "LKV" Models

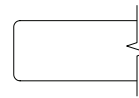

Eased Edge (R3)

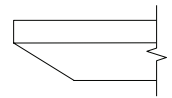

Reverse Bevel Edge (K9)

VENEER	D	W	H	CTN WT	CU FT	① Model	Essentials	Artisan	Essentials	Artisan
		60	240	29	648	281	LKV60240-29ARY	\$18,509	\$19,989	\$20,175
	60	216	29	593	253	LKV60216-29ARY	\$16,198	\$17,494	\$17,654	\$18,803
	54	240	29	575	254	LKV54240-29ARY	\$15,440	\$16,755	\$16,203	\$17,449
	54	216	29	529	229	LKV54216-29ARY	\$13,697	\$14,858	\$14,398	\$15,501
	48	240	29	548	228	LKV48240-29ARY	\$14,674	\$15,830	\$15,364	\$16,459
	48	216	29	486	206	LKV48216-29ARY	\$13,444	\$14,466	\$14,080	\$15,048

Electrical Options and Upcharges

	216 - 240 wide
<b>CT6</b>	
Six Power Center Top - Black	CT6BL - add \$4,949
Six Power Center Top - White	CT6WH - add \$4,949
<b>CU2</b>	
Dual Power Underside - Black	CU2-1C - add \$1,298
Dual Power Underside with 4 Wireless Charging - Black	CU2-1CW - add \$3,278
<b>CT6U2</b>	
Six Power Center Top - Black with Dual Underside	CT6U2-BL - add \$5,748
Six Power Center Top - White with Dual Underside	CT6U2-WH - add \$5,748
Six Power Center Top - Black Dual Underside with 4 Wireless Charging	CT6U2-BLW2 - add \$7,668
Six Power Center Top - White Dual Underside with 4 Wireless Charging	CT6U2-WHW2 - add \$7,668

Note: Order power infeed that best fits application

To Order Specify

① Veneer Model #	② Edge Detail	③ Wood Collection	④ Wood Finish	⑤ Electrical	⑥ Metal Color
Veneer (LKV)	<a href="#">See Edge Detail Options</a>	Essentials	<a href="#">See Essentials Wood Finish Options</a>	N None CT6 Six Power Center Top CU2 Dual Power Underside CT6U2 Six Power Center Top with Underside (See chart above)	<a href="#">See Metal Finish Color Options</a>
		Artisan	<b>④ Wood Finish</b> <a href="#">See Artisan Wood Finish Options</a>		

Description

Arc Rectangular 2pc Table with Y Base at Working Height

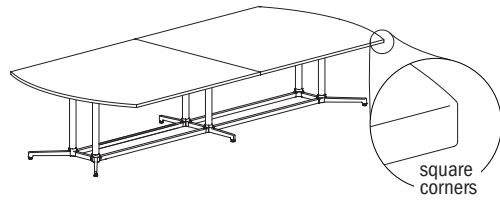

Laminate Tables "LKT" Models

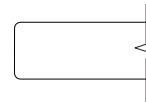

Eased Edge (R3)

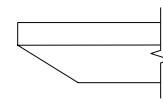

Reverse Bevel Edge (K9)

D	W	H	CTN WT	CU FT	Model	Eased Edge (R3)		Reverse Bevel Edge (K9)		
						Standard Tier 1	Graded In Tier 2	Standard Tier 1	Graded In Tier 2	
60	192	29	507	226	LKT60192-29ARY	\$9,253	\$9,413	\$10,012	\$10,173	
60	168	29	453	198	LKT60168-29ARY	\$7,724	\$7,862	\$8,448	\$8,588	
60	144	29	333	169	LKT60144-29ARY	\$7,037	\$7,155	\$7,723	\$7,841	
60	120	29	300	143	LKT60120-29ARY	\$6,338	\$6,436	\$6,990	\$7,089	
LAMINATE	54	192	29	454	204	LKT54192-29ARY	\$8,024	\$8,165	\$8,753	\$8,893
	54	168	29	360	178	LKT54168-29ARY	\$7,144	\$7,270	\$7,841	\$7,965
	54	144	29	357	154	LKT54144-29ARY	\$6,497	\$6,601	\$7,162	\$7,264
	54	120	29	308	130	LKT54120-29ARY	\$5,953	\$6,040	\$6,584	\$6,673
48	192	29	416	183	LKT48192-29ARY	\$7,802	\$7,931	\$8,498	\$8,623	
48	168	29	369	161	LKT48168-29ARY	\$6,328	\$6,436	\$6,994	\$7,102	
48	144	29	327	139	LKT48144-29ARY	\$5,860	\$5,955	\$6,501	\$6,596	
48	120	29	285	116	LKT48120-29ARY	\$5,296	\$5,376	\$5,908	\$5,986	
48	108	29	263	105	LKT48108-29ARY	\$4,718	\$4,790	\$5,316	\$5,386	

Features:

- price reflects complete table - top and base
- ships KD in multiple cartons
- two piece top
- model includes adjustable glide

Options:

- specify power/charging option, see below for options and upcharges



top shape

LOK - CONFERENCE

To Order Specify

1 Laminate Model #	2 Edge Detail	3 Laminate Selection	3a PVC Edge Color	4 Electrical	5 Metal Color
Laminate (LKT)	<a href="#">See Edge Detail Options</a>	<a href="#">See Laminate Selection</a>	<a href="#">See PVC Edge Color Options</a>	N None CT2 Dual Power Center Top CU2 Dual Power Underside CT2U1 Dual Power Center Top with Underside CT4U2 Four Power Center Top with Underside CT4 Four Power Center Top (See chart on next page)	<a href="#">See Metal Finish Color Options</a>

Model Number Breakdown

LKT60192-29ARY					
LK	T	60192	29	AR	Y
LOK	Laminate	60" x 192"	Height	Arc Rectangular Top Shape	Y base

Description

Arc Rectangular 2pc Table with Y Base at Working Height (continued)

Veneer Tables "LKV" Models

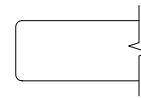

Eased Edge (R3)

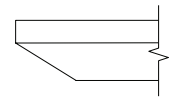

Reverse Bevel Edge (K9)

D	W	H	CTN WT	CU FT	Model	Eased Edge (R3)		Reverse Bevel Edge (K9)	
						Essentials	Artisan	Essentials	Artisan
60	192	29	507	226	LKV60192-29ARY	\$14,325	\$15,470	\$15,614	\$16,628
60	168	29	453	198	LKV60168-29ARY	\$11,877	\$12,825	\$12,946	\$13,787
60	144	29	333	169	LKV60144-29ARY	\$10,684	\$11,536	\$11,644	\$12,399
60	120	29	300	143	LKV60120-29ARY	\$9,571	\$10,333	\$10,428	\$11,107
54	192	29	454	204	LKV54192-29ARY	\$12,010	\$12,971	\$13,091	\$13,941
54	168	29	360	178	LKV54168-29ARY	\$10,816	\$11,682	\$11,789	\$12,555
54	144	29	357	154	LKV54144-29ARY	\$9,705	\$10,482	\$10,578	\$11,267
54	120	29	308	130	LKV54120-29ARY	\$8,773	\$9,472	\$9,563	\$10,180
48	192	29	416	183	LKV48192-29ARY	\$11,913	\$12,809	\$12,499	\$13,346
48	168	29	369	161	LKV48168-29ARY	\$9,643	\$10,415	\$10,177	\$10,902
48	144	29	327	139	LKV48144-29ARY	\$8,813	\$9,465	\$9,295	\$9,911
48	120	29	285	116	LKV48120-29ARY	\$7,875	\$8,412	\$8,310	\$8,814
48	108	29	263	105	LKV48108-29ARY	\$6,767	\$7,308	\$7,375	\$7,855

Electrical Options and Upcharges

CT2	108 wide	120 - 192 wide
Dual Power Center Top - Black	CT2BL - add \$1,837	n/a
Dual Power Center Top - White	CT2WH - add \$1,837	n/a
CU1		
Single Power Underside - Black	CU1-1C - add \$731	CU1-1C - add \$849
Single Power Underside with Wireless Charging - Black	CU1-1CW - add \$1,691	CU1-1CW - add \$1,776
CT2U1		
Dual Power Center Top - Black with Underside	CT2U1-BL - add \$2,235	n/a
Dual Power Center Top - White with Underside	CT2U1-WH - add \$2,235	n/a
Dual Power Center Top - Black with Wireless Charging	CT2U1-BLW2 - add \$3,194	n/a
Dual Power Center Top - White with Wireless Charging	CT2U1-WHW2 - add \$3,194	n/a

CT4U1	108 wide	120 - 192 wide
Four Power Center Top with Single Underside - Black	n/a	CT4U1-BL - add \$3,906
Four Power Center Top with Single Underside - White	n/a	CT4U1-WH - add \$3,906
Four Power Center Top - Black with Underside & Wireless Charging	n/a	CT4U1-BLW2 - add \$4,840
Four Power Center Top - White with Underside & Wireless Charging	n/a	CT4U1-WHW2 - add \$4,840
CT4		
Four Power Center Top - Black	n/a	CT4BL - add \$3,421
Four Power Center Top - White	n/a	CT4WH - add \$3,421

Note: Order power infeed that best fits application

To Order Specify

1 Veneer Model #	2 Edge Detail	3 Wood Collection	4 Wood Finish	5 Electrical	6 Metal Color
Veneer (LKV)	<a href="#">See Edge Detail Options</a>	Essentials	<a href="#">See Essentials Wood Finish Options</a>	N None CT2 Dual Power Center Top CU2 Dual Power Underside CT2U1 Dual Power Center Top with Underside CT4U2 Four Power Center Top with Underside CT4 Four Power Center Top	<a href="#">See Metal Finish Color Options</a>
		Artisan	4 Wood Finish <a href="#">See Artisan Wood Finish Options</a>		

LOK- CONFERENCE

## Description

Arc Rectangular Table with Y Base at Working Height

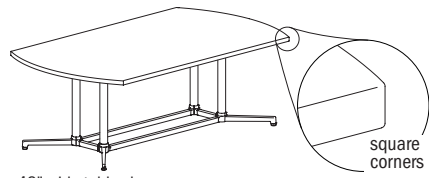

48" wide tables have double column base

**D** **W** **H** **CTN WT** **CU FT** **Model**

48	96	29	218	105	LKT4896-29ARY
48	84	29	333	83	LKT4884-29ARY
42	96	29	169	83	LKT4296-29ARY
42	84	29	636	281	LKT4284-29ARY
36	96	29	636	281	LKT3696-29ARY
36	84	29	648	281	LKT3684-29ARY

LAMINATE

## Laminate Tables "LKT" Models

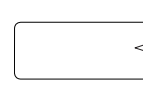

Eased Edge (R3)

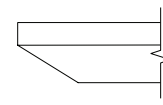

Reverse Bevel Edge (K9)

Eased Edge (R3)		Reverse Bevel Edge (K9)	
Standard Tier 1	Graded In Tier 2	Standard Tier 1	Graded In Tier 2
\$3,898	\$3,960	\$4,479	\$4,541
\$3,421	\$3,476	\$3,988	\$4,046
\$3,712	\$3,767	\$4,276	\$4,335
\$3,109	\$3,157	\$3,664	\$3,715
\$3,023	\$3,069	\$3,572	\$3,622
\$2,717	\$2,760	\$3,258	\$3,300

### Features:

- price reflects complete table - top and base
- ships KD in multiple cartons
- one piece top
- model includes adjustable glide

### Options:

- specify power/charging option, see below for options and upcharges



36" & 42" wide tables have single column base



top shape

LOK - CONFERENCE

## To Order Specify

1 Laminate Model #	2 Edge Detail	3 Laminate Selection	3a PVC Edge Color	4 Electrical	5 Metal Color
Laminate (LKT)	<a href="#">See Edge Detail Options</a>	<a href="#">See Laminate Selection</a>	<a href="#">See PVC Edge Color Options</a>	N None CT2 Dual Power Center Top CU2 Dual Power Underside CT2U1 Dual Power Center Top with Underside (See chart on next page)	<a href="#">See Metal Finish Color Options</a>

## Model Number Breakdown

LKT4896-29ARY					
LK	T	4896	29	AR	Y
LOK	Laminate	48" x 96"	Height	Arc Rectangular Top Shape	Y base

Description

Arc Rectangular Table with Y Base at Working Height (continued)

Veneer Tables "LKV" Models

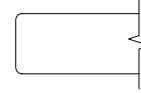

Eased Edge (R3)

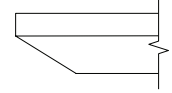

Reverse Bevel Edge (K9)

D	W	H	CTN WT	CU FT	Model	Eased Edge (R3)		Reverse Bevel Edge (K9)		
						Essentials	Artisan	Essentials	Artisan	
48	96	29	218	105	LKV4896-29ARY	\$5,426	\$5,842	\$5,806	\$6,196	
48	84	29	333	83	LKV4884-29ARY	\$4,895	\$5,254	\$5,250	\$5,585	
VENEER	42	96	29	169	83	LKV4296-29ARY	\$5,500	\$5,939	\$5,994	\$6,385
	42	84	29	636	281	LKV4284-29ARY	\$4,678	\$5,051	\$5,098	\$5,430
	36	96	29	636	281	LKV3696-29ARY	\$4,080	\$4,404	\$4,444	\$4,734
	36	84	29	648	281	LKV3684-29ARY	\$3,758	\$4,058	\$4,094	\$4,359

Electrical Options and Upcharges

CT2	84 - 96 wide
Dual Power Center Top - Black	CT2BL - add \$1,837
Dual Power Center Top - White	CT2WH - add \$1,837
CU1	
Single Power Underside - Black	CU1-1C - add \$731
Single Power Underside with Wireless Charging - Black	CU1-1CW - add \$1,691
CT2U1	
Dual Power Center Top - Black with Single Underside	CT2U1-BL - add \$2,235
Dual Power Center Top - White with Single Underside	CT2U1-WH - add \$2,235
Dual Power Center Top - Black with Wireless Charging	CT2U1-BLW2 - add \$3,194
Dual Power Center Top - White with Wireless Charging	CT2U1-WHW2 - add \$3,194

Note: Order power infed that best fits application

To Order Specify

1 Veneer Model #	2 Edge Detail	3 Wood Collection	4 Wood Finish	5 Electrical	6 Metal Color
Veneer (LKV)	<a href="#">See Edge Detail Options</a>	Essentials	<a href="#">See Essentials Wood Finish Options</a>	N None CT2 Dual Power Center Top CU2 Dual Power Underside CT2U1 Dual Power Center Top with Underside (See chart above)	<a href="#">See Metal Finish Color Options</a>
		Artisan	<b>4 Wood Finish</b> <a href="#">See Artisan Wood Finish Options</a>		

LOK - CONFERENCE

Description

Rounded Arc Rectangular 3pc Table with Y Base at Working Height

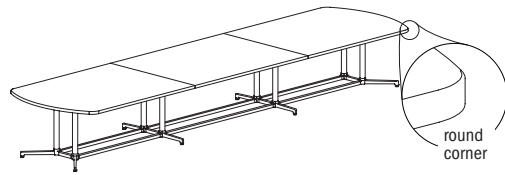

Laminate Tables  
"LKT" Models

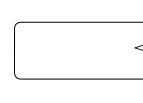

Eased Edge (R3)

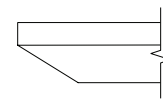

Reverse Bevel Edge (K9)

LAMINATE	D	W	H	CTN WT	CU FT	Model	Standard Tier 1	Graded In Tier 2	Standard Tier 1	Graded In Tier 2
	60	240	29	648	281	LKT60240-29ARRY	\$11,889	\$12,084	\$12,723	\$12,920
60	216	29	593	253	LKT60216-29ARRY	\$10,053	\$10,232	\$10,852	\$11,030	
54	240	29	575	254	LKT54240-29ARRY	\$9,406	\$9,582	\$10,200	\$10,376	
54	216	29	529	229	LKT54216-29ARRY	\$8,408	\$8,568	\$9,169	\$9,329	
48	240	29	548	228	LKT48240-29ARRY	\$9,088	\$9,249	\$9,841	\$9,999	
48	216	29	486	206	LKT48216-29ARRY	\$8,423	\$8,566	\$9,152	\$9,291	

Features:

- price reflects complete table - top and base
- ships KD in multiple cartons
- three piece top
- model includes adjustable glide

Options:

- specify power/charging option, see below for options and upcharges



top shape

LOK - CONFERENCE

To Order Specify

1 Laminate Model #	2 Edge Detail	3 Laminate Selection	3a PVC Edge Color	4 Electrical	5 Metal Color
Laminate (LKT)	<a href="#">See Edge Detail Options</a>	<a href="#">See Laminate Selection</a>	<a href="#">See PVC Edge Color Options</a>	N None CT6 Six Power Center Top CU2 Dual Power Underside CT6U2 Six Power Center Top with Underside (See chart on next page)	<a href="#">See Metal Finish Color Options</a>

Model Number Breakdown

LKT60240-29ARRY						
LK	T	60240	29	AR	R	Y
LOK	Laminate	60" x 240"	Height	Arc Rectangular Top Shape	Rounded Corner	Y base

Description

Rounded Arc Rectangular 3pc Table with Y Base at Working Height (continued)

Veneer Tables "LKV" Models

Solid Surface Tables "LKS" Models

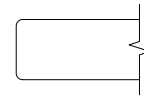

Eased Edge (R3)

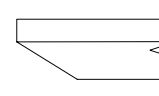

Reverse Bevel Edge (K9)

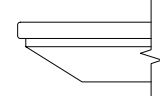

Reverse Bevel Edge (S7)

	D	W	H	CTN WT	CU FT	① Model	Veneer		Solid Surface		
							Essentials	Artisan	Essentials	Artisan	Standard
VENEER	60	240	29	648	281	LKV60240-29ARRY	\$18,509	\$19,989	\$20,175	\$21,485	--
	60	216	29	593	253	LKV60216-29ARRY	\$16,198	\$17,494	\$17,654	\$18,803	--
	54	240	29	575	254	LKV54240-29ARRY	\$15,440	\$16,755	\$16,203	\$17,449	--
	54	216	29	529	229	LKV54216-29ARRY	\$13,697	\$14,858	\$14,398	\$15,501	--
	48	240	29	548	228	LKV48240-29ARRY	\$14,674	\$15,830	\$15,364	\$16,459	--
	48	216	29	486	206	LKV48216-29ARRY	\$13,444	\$14,466	\$14,080	\$15,048	--
SOLID SURFACE	60	240	29	648	281	LKS60240-29ARRY	--	--	--	--	\$42,272
	60	216	29	593	253	LKS60216-29ARRY	--	--	--	--	\$38,130
	54	240	29	575	254	LKS54240-29ARRY	--	--	--	--	\$38,268
	54	216	29	529	229	LKS54216-29ARRY	--	--	--	--	\$33,974
	48	240	29	548	228	LKS48240-29ARRY	--	--	--	--	\$34,719
	48	216	29	486	206	LKS48216-29ARRY	--	--	--	--	\$31,253

Electrical Options and Upcharges

	216 - 240 wide
<b>CT6</b>	
Six Power Center Top - Black	CT6BL - add \$4,949
Six Power Center Top - White	CT6WH - add \$4,949
<b>CU2</b>	
Dual Power Underside - Black	CU2-1C - add \$1,298
Dual Power Underside with 4 Wireless Charging - Black	CU2-1CW - add \$3,278
<b>CT6U2</b>	
Six Power Center Top - Black with Dual Underside	CT6U2-BL - add \$5,748
Six Power Center Top - White with Dual Underside	CT6U2-WH - add \$5,748
Six Power Center Top - Black Dual Underside with 4 Wireless Charging	CT6U2-BLW2 - add \$7,668
Six Power Center Top - White Dual Underside with 4 Wireless Charging	CT6U2-WHW2 - add \$7,668

LOK - CONFERENCE

To Order Specify

Note: Order power infed that best fits application

① Veneer Model #	② Edge Detail	③ Wood Collection	④ Wood Finish	⑤ Electrical	⑥ Metal Color
Veneer (LKV)	<a href="#">See Edge Detail Options</a>	Essentials	<a href="#">See Essentials Wood Finish Options</a>	N None CT6 Six Power Center Top CU2 Dual Power Underside CT6U2 Six Power Center Top with Underside (See chart above)	<a href="#">See Metal Finish Color Options</a>
		Artisan	④ Wood Finish <a href="#">See Artisan Wood Finish Options</a>		

① Solid Surface Model #	② Top Surface Selection	③ Electrical	④ Metal Color
Solid Surface (LKS)	<a href="#">See Solid Surface Top Surface Selection Options</a>	N None CT6 Six Power Center Top CU2 Dual Power Underside CT6U2 Six Power Center Top with Underside (See chart above)	<a href="#">See Metal Finish Color Options</a>

Description

Rounded Arc Rectangular 2pc Table with Y Base at Working Height

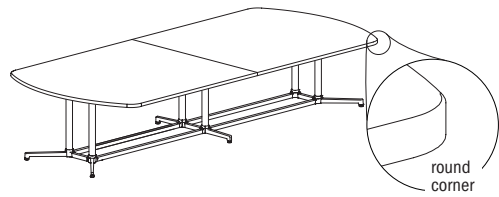

Laminate Tables "LKT" Models

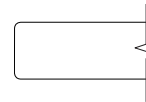

Eased Edge (R3)

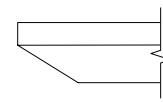

Reverse Bevel Edge (K9)

LAMINATE	D	W	H	CTN WT	CU FT	Model	Standard Tier 1	Graded In Tier 2	Standard Tier 1	Graded In Tier 2
		60	192	29	507	226	LKT60192-29ARRY	\$8,315	\$8,471	\$9,074
	60	168	29	453	198	LKT60168-29ARRY	\$7,724	\$7,862	\$8,448	\$8,588
	60	144	29	333	169	LKT60144-29ARRY	\$7,037	\$7,155	\$7,723	\$7,841
	60	120	29	330	143	LKT60120-29ARRY	\$6,338	\$6,436	\$6,990	\$7,089
	54	192	29	454	204	LKT54192-29ARRY	\$8,024	\$8,165	\$8,753	\$8,893
	54	168	29	360	178	LKT54168-29ARRY	\$7,144	\$7,270	\$7,841	\$7,965
	54	144	29	357	154	LKT54144-29ARRY	\$6,497	\$6,601	\$7,162	\$7,264
	54	120	29	308	130	LKT54120-29ARRY	\$5,953	\$6,040	\$6,584	\$6,673
	48	192	29	416	183	LKT48192-29ARRY	\$7,802	\$7,931	\$8,498	\$8,623
	48	168	29	369	161	LKT48168-29ARRY	\$6,328	\$6,436	\$6,994	\$7,102
	48	144	29	327	139	LKT48144-29ARRY	\$5,860	\$5,955	\$6,501	\$6,596
	48	120	29	285	116	LKT48120-29ARRY	\$5,296	\$5,376	\$5,908	\$5,986
	48	108	29	263	105	LKT48108-29ARRY	\$4,622	\$4,692	\$5,220	\$5,289

Features:

- price reflects complete table - top and base
- ships KD in multiple cartons
- two piece top
- model includes adjustable glide

Options:

- specify power/charging option, see below for options and upcharges

Electrical Options and Upcharges

	108 wide	120 - 192 wide
<b>CT2</b>		
Dual Power Center Top - Black	CT2BL - add \$1,837	n/a
Dual Power Center Top - White	CT2WH - add \$1,837	n/a
<b>CU1</b>		
Single Power Underside - Black	CU1-1C - add \$731	CU1-1C - add \$849
Single Power Underside with Wireless Charging - Black	CU1-1CW - add \$1,691	CU1-1CW - add \$1,776
<b>CT2U1</b>		
Dual Power Center Top - Black with Underside	CT2U1-BL - add \$2,235	n/a
Dual Power Center Top - White with Underside	CT2U1-WH - add \$2,235	n/a
Dual Power Center Top - Black with Wireless Charging	CT2U1-BLW2 - add \$3,194	n/a
Dual Power Center Top - White with Wireless Charging	CT2U1-WHW2 - add \$3,194	n/a

Note: Order power infeed that best fits application.

	108 wide	120 - 192 wide
<b>CT4U1</b>		
Four Power Center Top with Single Underside - Black	n/a	CT4U1-BL - add \$3,906
Four Power Center Top with Single Underside - White	n/a	CT4U1-WH - add \$3,906
Four Power Center Top - Black with Underside & Wireless Charging	n/a	CT4U1-BLW2 - add \$4,840
Four Power Center Top - White with Underside & Wireless Charging	n/a	CT4U1-WHW2 - add \$4,840
<b>CT4</b>		
Four Power Center Top - Black	n/a	CT4BL - add \$3,421
Four Power Center Top - White	n/a	CT4WH - add \$3,421

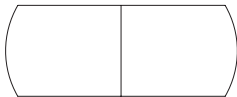

top shape

To Order Specify

1 Laminate Model #	2 Edge Detail	3 Laminate Selection	3a PVC Edge Color	4 Electrical	5 Metal Color
Laminate (LKT)	<a href="#">See Edge Detail Options</a>	<a href="#">See Laminate Selection</a>	<a href="#">See PVC Edge Color Options</a>	N None CT2 Dual Power Center Top CU2 Dual Power Underside CT2U1 Dual Power Center Top with Underside CT4U2 Four Power Center Top with Underside CT4 Four Power Center Top (See chart above)	<a href="#">See Metal Finish Color Options</a>

Model Number Breakdown

LKT60192-29ARRY						
LK	T	60192	29	AR	R	Y
LOK	Laminate	60" x 192"	Height	Arc Rectangular Top Shape	Rounded Corner	Y base

Description

Rounded Arc Rectangular 2pc Table with Y Base at Working Height (continued)

Veneer Tables "LKV" Models      Solid Surface Tables "LKS" Models

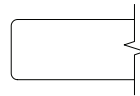

Eased Edge (R3)

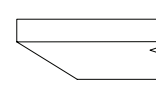

Reverse Bevel Edge (K9)

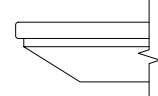

Reverse Bevel Edge (S7)

	D	W	H	CTN WT	CU FT	① Model	Veneer		Solid Surface		Standard	
							Essentials	Artisan	Essentials	Artisan		
VENEER	60	192	29	507	226	LKV60192-29ARRY	\$12,962	\$13,999	\$14,129	\$15,047	--	
	60	168	29	453	198	LKV60168-29ARRY	\$11,877	\$12,825	\$12,946	\$13,787	--	
	60	144	29	333	169	LKV60144-29ARRY	\$10,684	\$11,536	\$11,644	\$12,399	--	
	60	120	29	330	143	LKV60120-29ARRY	\$9,571	\$10,333	\$10,428	\$11,107	--	
	54	192	29	454	204	LKV54192-29ARRY	\$12,010	\$12,971	\$13,091	\$13,941	--	
	54	168	29	360	178	LKV54168-29ARRY	\$10,816	\$11,682	\$11,789	\$12,555	--	
	54	144	29	357	154	LKV54144-29ARRY	\$9,705	\$10,482	\$10,578	\$11,267	--	
	54	120	29	308	130	LKV54120-29ARRY	\$8,773	\$9,472	\$9,563	\$10,180	--	
	48	192	29	416	183	LKV48192-29ARRY	\$11,913	\$12,809	\$12,499	\$13,346	--	
	48	168	29	385	161	LKV48168-29ARRY	\$9,643	\$10,415	\$10,177	\$10,902	--	
	48	144	29	327	139	LKV48144-29ARRY	\$8,813	\$9,465	\$9,295	\$9,911	--	
	48	120	29	285	116	LKV48120-29ARRY	\$7,875	\$8,412	\$8,310	\$8,814	--	
	48	108	29	263	105	LKV48108-29ARRY	\$6,643	\$7,172	\$7,242	\$7,709	--	
	SOLID SURFACE	60	192	29	507	226	LKS60192-29ARRY	--	--	--	--	\$31,846
		60	168	29	453	198	LKS60168-29ARRY	--	--	--	--	\$28,074
		60	144	29	333	169	LKS60144-29ARRY	--	--	--	--	\$24,285
60		120	29	330	143	LKS60120-29ARRY	--	--	--	--	\$26,797	
54		192	29	454	204	LKS54192-29ARRY	--	--	--	--	\$28,979	
54		168	29	360	178	LKS54168-29ARRY	--	--	--	--	\$25,555	
54		144	29	357	154	LKS54144-29ARRY	--	--	--	--	\$22,143	
54		120	29	308	130	LKS54120-29ARRY	--	--	--	--	\$18,977	
48		192	29	416	183	LKS48192-29ARRY	--	--	--	--	\$27,334	
48		168	29	369	161	LKS48168-29ARRY	--	--	--	--	\$22,980	
48		144	29	327	139	LKS48144-29ARRY	--	--	--	--	\$20,132	
48		120	29	285	116	LKS48120-29ARRY	--	--	--	--	\$17,245	
48		108	29	263	105	LKS48108-29ARRY	--	--	--	--	\$15,944	

LOK- CONFERENCE

To Order Specify

① Veneer Model #	② Edge Detail	③ Wood Collection	④ Wood Finish	⑤ Electrical	⑥ Metal Color
Veneer (LKV)	<a href="#">See Edge Detail Options</a>	Essentials	<a href="#">See Essentials Wood Finish Options</a>	N None CT2 Dual Power Center Top CU2 Dual Power Underside CT2U1 Dual Power Center Top with Underside CT4U2 Four Power Center Top with Underside CT4 Four Power Center Top (See chart on previous page)	<a href="#">See Metal Finish Color Options</a>
		Artisan	④ Wood Finish <a href="#">See Artisan Wood Finish Options</a>		

① Solid Surface Model #	② Top Surface Selection	③ Electrical	④ Metal Color
Solid Surface (LKS)	<a href="#">See Solid Surface Top Surface Selection Options</a>	N None CT2 Dual Power Center Top CU2 Dual Power Underside CT2U1 Dual Power Center Top with Underside CT4U2 Four Power Center Top with Underside CT4 Four Power Center Top (See chart on previous page)	<a href="#">See Metal Finish Color Options</a>

## Description

Rounded Arc Rectangular Table with Y Base at Working Height

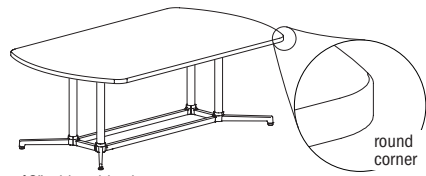

48" wide tables have double column base

D	W	H	CTN WT	CU FT	Model
---	---	---	--------	-------	-------

LAMINATE

48	96	29	218	105	LKT4896-29ARRY
48	84	29	333	83	LKT4884-29ARRY
42	96	29	169	83	LKT4296-29ARRY
42	84	29	174	72	LKT4284-29ARRY
36	96	29	156	72	LKT3696-29ARRY
36	84	29	152	64	LKT3684-29ARRY

## Laminate Tables "LKT" Models

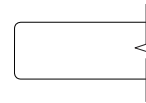

Eased Edge (R3)

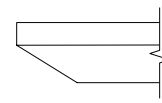

Reverse Bevel Edge (K9)

Standard Tier 1	Graded In Tier 2	Standard Tier 1	Graded In Tier 2
\$3,421	\$3,476	\$3,988	\$4,046
\$3,712	\$3,767	\$4,276	\$4,335
\$3,109	\$3,157	\$3,664	\$3,715
\$3,023	\$3,069	\$3,572	\$3,622
\$2,717	\$2,760	\$3,258	\$3,300

### Features:

- price reflects complete table - top and base
- ships KD in multiple cartons
- one piece top
- model includes adjustable glide

### Options:

- specify power/charging option, see below for options and upcharges

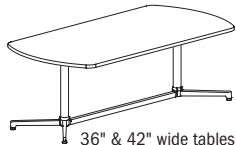

36" & 42" wide tables have single column base



top shape

LOK - CONFERENCE

## To Order Specify

1 Laminate Model #	2 Edge Detail	3 Laminate Selection	3a PVC Edge Color	4 Electrical	5 Metal Color
Laminate (LKT)	<a href="#">See Edge Detail Options</a>	<a href="#">See Laminate Selection</a>	<a href="#">See PVC Edge Color Options</a>	N None CT2 Dual Power Center Top CU2 Dual Power Underside CT2U1 Dual Power Center Top with Underside (See chart on next page)	<a href="#">See Metal Finish Color Options</a>

## Model Number Breakdown

LKT4896-29ARRY						
LK	T	4896	29	AR	R	Y
LOK	Laminate	48" x 96"	Height	Arc Rectangular Top Shape	Rounded Corner	Y base

Description

Rounded Arc Rectangular Table with Y Base at Working Height (continued)

Veneer Tables "LKV" Models      Solid Surface Tables "LKS" Models

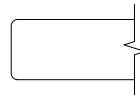

Eased Edge (R3)

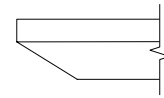

Reverse Bevel Edge (K9)

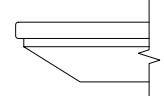

Reverse Bevel Edge (S7)

	D	W	H	CTN WT	CU FT	① Model	Veneer Tables		Solid Surface Tables		
							Essentials	Artisan	Essentials	Artisan	Standard
VENEER	48	96	29	218	105	LKV4896-29ARRY	\$5,426	\$5,842	\$5,806	\$6,196	--
	48	84	29	333	83	LKV4884-29ARRY	\$4,895	\$5,254	\$5,250	\$5,585	--
	42	96	29	169	83	LKV4296-29ARRY	\$5,500	\$5,939	\$5,994	\$6,385	--
	42	84	29	174	72	LKV4284-29ARRY	\$4,678	\$5,051	\$5,098	\$5,430	--
	36	96	29	156	72	LKV3696-29ARRY	\$4,080	\$4,404	\$4,444	\$4,734	--
	36	84	29	152	64	LKV3684-29ARRY	\$3,758	\$4,058	\$4,094	\$4,359	--
SOLID SURFACE	48	96	29	218	105	LKS4896-29ARRY	--	--	--	--	\$12,669
	48	84	29	333	73	LKS4884-29ARRY	--	--	--	--	\$11,183
	42	96	29	169	83	LKS4296-29ARRY	--	--	--	--	\$10,528
	42	84	29	174	72	LKS4284-29ARRY	--	--	--	--	\$9,321
	36	96	29	156	72	LKS3696-29ARRY	--	--	--	--	\$9,114
	36	84	29	152	64	LKS3684-29ARRY	--	--	--	--	\$8,223

Electrical Options and Upcharges

CT2	84 - 96 wide
Dual Power Center Top - Black	CT2BL - add \$1,837
Dual Power Center Top - White	CT2WH - add \$1,837
CU1	
Single Power Underside - Black	CU1-1C - add \$731
Single Power Underside with Wireless Charging - Black	CU1-1CW - add \$1,691
CT2U1	
Dual Power Center Top - Black with Single Underside	CT2U1-BL - add \$2,235
Dual Power Center Top - White with Single Underside	CT2U1-WH - add \$2,235
Dual Power Center Top - Black with Wireless Charging	CT2U1-BLW2 - add \$3,194
Dual Power Center Top - White with Wireless Charging	CT2U1-WHW2 - add \$3,194

LOK - CONFERENCE

Note: Order power infeed that best fits application

To Order Specify

① Veneer Model #	② Edge Detail	③ Wood Collection	④ Wood Finish	⑤ Electrical	⑥ Metal Color
Veneer (LKV)	<a href="#">See Edge Detail Options</a>	Essentials	<a href="#">See Essentials Wood Finish Options</a>	N None CT2 Dual Power Center Top CU2 Dual Power Underside CT2U1 Dual Power Center Top with Underside (See chart above)	<a href="#">See Metal Finish Color Options</a>
		Artisan	④ Wood Finish <a href="#">See Artisan Wood Finish Options</a>		

① Solid Surface Model #	② Top Surface Selection	③ Electrical	④ Metal Color
Solid Surface (LKS)	<a href="#">See Solid Surface Top Surface Selection Options</a>	N None CT2 Dual Power Center Top CU2 Dual Power Underside CT2U1 Dual Power Center Top with Underside (See chart above)	<a href="#">See Metal Finish Color Options</a>

Description

Racetrack 3pc Table with Y Base at Working Height

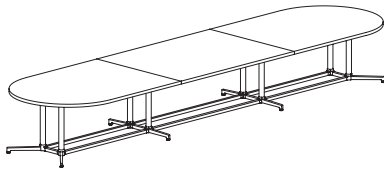

Laminate Tables  
"LKT" Models

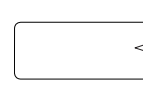

Eased Edge (R3)

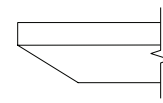

Reverse Bevel Edge (K9)

D	W	H	CTN WT	CU FT	① Model	Eased Edge (R3)		Reverse Bevel Edge (K9)	
						Standard Tier 1	Graded In Tier 2	Standard Tier 1	Graded In Tier 2
60	240	29	636	281	LKT60240-29RKY	\$11,889	\$12,084	\$12,723	\$12,920
60	216	29	584	253	LKT60216-29RKY	\$10,053	\$10,232	\$10,852	\$11,030
54	240	29	561	254	LKT54240-29RKY	\$9,406	\$9,582	\$10,200	\$10,376
54	216	29	515	229	LKT54216-29RKY	\$8,355	\$8,514	\$9,119	\$9,276
48	240	29	517	228	LKT48240-29RKY	\$8,447	\$8,602	\$9,200	\$9,357
48	216	29	474	206	LKT48216-29RKY	\$7,931	\$8,071	\$8,655	\$8,800

LAMINATE

Features:

- price reflects complete table - top and base
- ships KD in multiple cartons
- three piece top
- model includes adjustable glide

Options:

- specify power/charging option, see below for options and upcharges

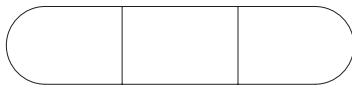

top shape

LOK - CONFERENCE

To Order Specify

① Laminate Model #	② Edge Detail	③ Laminate Selection	④ PVC Edge Color	⑤ Electrical	⑥ Metal Color
Laminate (LKT)	<a href="#">See Edge Detail Options</a>	<a href="#">See Laminate Selection</a>	<a href="#">See PVC Edge Color Options</a>	N None CT6 Six Power Center Top CU2 Dual Power Underside CT6U2 Six Power Center Top with Underside (See chart on next page)	<a href="#">See Metal Finish Color Options</a>

Model Number Breakdown

LKT60240-29RKY					
LK	T	60240	29	RK	Y
LOK	Laminate	60" x 240"	Height	Racetrack Top Shape	Y base

Description

Racetrack 3pc Table with Y Base at Working Height (continued)

Veneer Tables "LKV" Models

Solid Surface Tables "LKS" Models

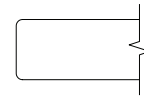

Eased Edge (R3)

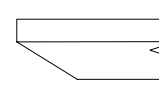

Reverse Bevel Edge (K9)

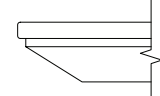

Reverse Bevel Edge (S7)

	D	W	H	CTN WT	CU FT	① Model	Veneer		Solid Surface		
							Essentials	Artisan	Essentials	Artisan	Standard
VENEER	60	240	29	636	281	LKV60240-29RKY	\$18,509	\$19,989	\$20,175	\$21,485	--
	60	216	29	584	253	LKV60216-29RKY	\$16,198	\$17,494	\$17,654	\$18,803	--
	54	240	29	561	254	LKV54240-29RKY	\$15,440	\$16,755	\$16,203	\$17,449	--
	54	216	29	515	229	LKV54216-29RKY	\$13,619	\$14,781	\$14,320	\$15,425	--
	48	240	29	517	228	LKV48240-29RKY	\$13,743	\$14,899	\$14,434	\$15,529	--
	48	216	29	474	206	LKV48216-29RKY	\$12,741	\$13,765	\$13,376	\$14,344	--
SOLID SURFACE	60	240	29	636	281	LKS60240-29RKY	--	--	--	--	\$42,272
	60	216	29	584	253	LKS60216-29RKY	--	--	--	--	\$38,130
	54	240	29	561	254	LKS54240-29RKY	--	--	--	--	\$38,268
	54	216	29	515	229	LKS54216-29RKY	--	--	--	--	\$33,897
	48	240	29	517	228	LKS48240-29RKY	--	--	--	--	\$33,786
	48	216	29	474	206	LKS48216-29RKY	--	--	--	--	\$30,549

Electrical Options and Upcharges

	216 - 240 wide
<b>CT6</b>	
Six Power Center Top - Black	CT6BL - add \$4,949
Six Power Center Top - White	CT6WH - add \$4,949
<b>CU2</b>	
Dual Power Underside - Black	CU2-1C - add \$1,298
Dual Power Underside with 4 Wireless Charging - Black	CU2-1CW - add \$3,278
<b>CT6U2</b>	
Six Power Center Top - Black with Dual Underside	CT6U2-BL - add \$5,748
Six Power Center Top - White with Dual Underside	CT6U2-WH - add \$5,748
Six Power Center Top - Black Dual Underside with 4 Wireless Charging	CT6U2-BLW2 - add \$7,668
Six Power Center Top - White Dual Underside with 4 Wireless Charging	CT6U2-WHW2 - add \$7,668

LOK - CONFERENCE

To Order Specify

Note: Order power infed that best fits application

① Veneer Model #	② Edge Detail	③ Wood Collection	④ Wood Finish	⑤ Electrical	⑥ Metal Color
Veneer (LKV)	<a href="#">See Edge Detail Options</a>	Essentials	<a href="#">See Essentials Wood Finish Options</a>	N None CT6 Six Power Center Top CU2 Dual Power Underside CT6U2 Six Power Center Top with Underside (See chart above)	<a href="#">See Metal Finish Color Options</a>
		Artisan	④ Wood Finish <a href="#">See Artisan Wood Finish Options</a>		

① Solid Surface Model #	② Top Surface Selection	③ Electrical	④ Metal Color
Solid Surface (LKS)	<a href="#">See Solid Surface Top Surface Selection Options</a>	N None CT6 Six Power Center Top CU2 Dual Power Underside CT6U2 Six Power Center Top with Underside (See chart above)	<a href="#">See Metal Finish Color Options</a>

Description

Racetrack 2pc Table with Y Base at Working Height

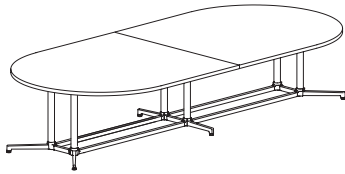

Laminate Tables "LKT" Models

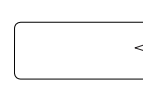

Eased Edge (R3)

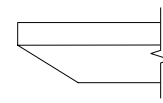

Reverse Bevel Edge (K9)

LAMINATE	D	W	H	CTN WT	CU FT	Model	Standard Tier 1	Graded In Tier 2	Standard Tier 1	Graded In Tier 2
	60	192	29	511	226	LKT60192-29RKY	\$8,183	\$8,341	\$8,945	\$9,102
	60	168	29	449	198	LKT60168-29RKY	\$7,724	\$7,862	\$8,448	\$8,588
60	144	29	315	169	LKT60144-29RKY	\$6,873	\$6,990	\$7,559	\$7,676	
60	120	29	313	143	LKT60120-29RKY	\$6,252	\$6,351	\$6,904	\$7,002	
54	192	29	439	204	LKT54192-29RKY	\$7,907	\$8,049	\$8,632	\$8,776	
54	168	29	343	178	LKT54168-29RKY	\$7,042	\$7,166	\$7,737	\$7,860	
54	144	29	294	154	LKT54144-29RKY	\$6,390	\$6,499	\$7,053	\$7,163	
54	120	29	294	130	LKT54120-29RKY	\$5,867	\$5,954	\$6,497	\$6,587	
48	192	29	403	183	LKT48192-29RKY	\$6,790	\$6,914	\$7,484	\$7,611	
48	168	29	356	161	LKT48168-29RKY	\$6,175	\$6,286	\$6,841	\$6,953	
48	144	29	314	139	LKT48144-29RKY	\$5,608	\$5,703	\$6,250	\$6,344	
48	120	29	273	116	LKT48120-29RKY	\$5,200	\$5,281	\$5,810	\$5,893	
48	108	29	250	105	LKT48108-29RKY	\$4,572	\$4,644	\$5,167	\$5,241	

Features:

- price reflects complete table - top and base
- ships KD in multiple cartons
- two piece top
- model includes adjustable glide

Options:

- specify power/charging option, see below for options and upcharges

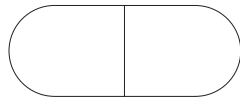

top shape

Electrical Options and Upcharges

	108 wide	120 - 192 wide
<b>CT2</b>		
Dual Power Center Top - Black	CT2BL - add \$1,837	n/a
Dual Power Center Top - White	CT2WH - add \$1,837	n/a
<b>CU1</b>		
Single Power Underside - Black	CU1-1C - add \$731	CU1-1C - add \$849
Single Power Underside with Wireless Charging - Black	CU1-1CW - add \$1,691	CU1-1CW - add \$1,776
<b>CT2U1</b>		
Dual Power Center Top - Black with Underside	CT2U1-BL - add \$2,235	n/a
Dual Power Center Top - White with Underside	CT2U1-WH - add \$2,235	n/a
Dual Power Center Top - Black with Wireless Charging	CT2U1-BLW2 - add \$3,194	n/a
Dual Power Center Top - White with Wireless Charging	CT2U1-WHW2 - add \$3,194	n/a

Note: Order power infeed that best fits application.

	108 wide	120 - 192 wide
<b>CT4U1</b>		
Four Power Center Top with Single Underside - Black	n/a	CT4U1-BL - add \$3,906
Four Power Center Top with Single Underside - White	n/a	CT4U1-WH - add \$3,906
Four Power Center Top - Black with Underside & Wireless Charging	n/a	CT4U1-BLW2 - add \$4,840
Four Power Center Top - White with Underside & Wireless Charging	n/a	CT4U1-WHW2 - add \$4,840
<b>CT4</b>		
Four Power Center Top - Black	n/a	CT4BL - add \$3,421
Four Power Center Top - White	n/a	CT4WH - add \$3,421

To Order Specify

1 Laminate Model #	2 Edge Detail	3 Laminate Selection	3a PVC Edge Color	4 Electrical	5 Metal Color
Laminate (LKT)	<a href="#">See Edge Detail Options</a>	<a href="#">See Laminate Selection</a>	<a href="#">See PVC Edge Color Options</a>	N None CT2 Dual Power Center Top CU2 Dual Power Underside CT2U1 Dual Power Center Top with Underside CT4U2 Four Power Center Top with Underside CT4 Four Power Center Top (See chart above)	<a href="#">See Metal Finish Color Options</a>

Model Number Breakdown

LKT60192-29RKY					
LK	T	60192	29	RK	Y
LOK	Laminate	60" x 192"	Height	Racetrack Top Shape	Y base

Description

Racetrack 2pc Table with Y  
Base at Working Height  
(continued)

Veneer Tables  
"LKV" Models

Solid Surface Tables  
"LKS" Models

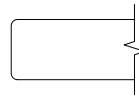

Eased Edge (R3)

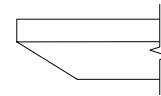

Reverse Bevel Edge (K9)

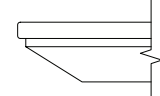

Reverse Bevel Edge (S7)

	D	W	H	CTN WT	CU FT	① Model	Veneer Tables "LKV" Models		Solid Surface Tables "LKS" Models			
							Essentials	Artisan	Essentials	Artisan	Standard	
VENEER	60	192	29	511	226	LKV60192-29RKY	\$14,137	\$15,268	\$15,407	\$16,408	--	
	60	168	29	449	198	LKV60168-29RKY	\$11,877	\$12,825	\$12,946	\$13,787	--	
	60	144	29	315	169	LKV60144-29RKY	\$10,452	\$11,288	\$11,392	\$12,133	--	
	60	120	29	313	143	LKV60120-29RKY	\$9,449	\$10,204	\$10,300	\$10,970	--	
	54	192	29	439	204	LKV54192-29RKY	\$11,844	\$12,790	\$12,907	\$13,746	--	
	54	168	29	343	178	LKV54168-29RKY	\$10,667	\$11,522	\$11,628	\$12,383	--	
	54	144	29	294	154	LKV54144-29RKY	\$9,563	\$10,325	\$10,421	\$11,099	--	
	54	120	29	294	130	LKV54120-29RKY	\$8,654	\$9,344	\$9,433	\$10,045	--	
	48	192	29	403	183	LKV48192-29RKY	\$10,492	\$11,389	\$11,078	\$11,921	--	
	48	168	29	356	161	LKV48168-29RKY	\$9,433	\$10,208	\$9,968	\$10,694	--	
	48	144	29	314	139	LKV48144-29RKY	\$8,473	\$9,127	\$8,958	\$9,571	--	
	48	120	29	273	116	LKV48120-29RKY	\$7,749	\$8,283	\$8,182	\$8,684	--	
	48	108	29	250	105	LKV48108-29RKY	\$6,581	\$7,102	\$7,168	\$7,635	--	
	SOLID SURFACE	60	192	29	511	226	LKS60192-29RKY	--	--	--	--	\$31,653
		60	168	29	449	198	LKS60168-29RKY	--	--	--	--	\$28,074
		60	144	29	315	169	LKS60144-29RKY	--	--	--	--	\$24,055
60		120	29	313	143	LKS60120-29RKY	--	--	--	--	\$26,680	
54		192	29	439	204	LKS54192-29RKY	--	--	--	--	\$28,815	
54		168	29	343	178	LKS54168-29RKY	--	--	--	--	\$25,410	
54		144	29	294	154	LKS54144-29RKY	--	--	--	--	\$21,999	
54		120	29	294	130	LKS54120-29RKY	--	--	--	--	\$18,862	
48		192	29	403	183	LKS48192-29RKY	--	--	--	--	\$25,911	
48		168	29	356	161	LKS48168-29RKY	--	--	--	--	\$22,772	
48		144	29	314	139	LKS48144-29RKY	--	--	--	--	\$19,794	
48		120	29	273	116	LKS48120-29RKY	--	--	--	--	\$17,116	
48		108	29	250	105	LKS48108-29RKY	--	--	--	--	\$15,881	

LOK- CONFERENCE

To Order Specify

① Veneer Model #	② Edge Detail	③ Wood Collection	④ Wood Finish	⑤ Electrical	⑥ Metal Color
Veneer (LKV)	<a href="#">See Edge Detail Options</a>	Essentials	<a href="#">See Essentials Wood Finish Options</a>	N None CT2 Dual Power Center Top CU2 Dual Power Underside CT2U1 Dual Power Center Top with Underside CT4U2 Four Power Center Top with Underside CT4 Four Power Center Top (See chart on previous page)	<a href="#">See Metal Finish Color Options</a>
		Artisan	④ Wood Finish <a href="#">See Artisan Wood Finish Options</a>		

① Solid Surface Model #	② Top Surface Selection	③ Electrical	④ Metal Color
Solid Surface (LKS)	<a href="#">See Solid Surface Top Surface Selection Options</a>	N None CT2 Dual Power Center Top CU2 Dual Power Underside CT2U1 Dual Power Center Top with Underside CT4U2 Four Power Center Top with Underside CT4 Four Power Center Top (See chart on previous page)	<a href="#">See Metal Finish Color Options</a>

Description

Racetrack Table with Y Base at Working Height

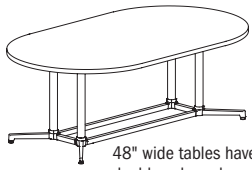

48" wide tables have double column base

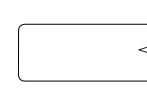

Eased Edge (R3)

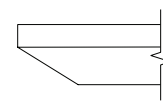

Reverse Bevel Edge (K9)

Laminate Tables "LKT" Models

LAMINATE	D	W	H	CTN WT	CU FT	1 Model	Eased Edge (R3)		Reverse Bevel Edge (K9)	
							Standard Tier 1	Graded In Tier 2	Standard Tier 1	Graded In Tier 2
		48	96	29	207	105	LKT4896-29RKY	\$3,898	\$3,960	\$4,479
	48	84	29	315	83	LKT4884-29RKY	\$3,421	\$3,476	\$3,988	\$4,046
	42	96	29	161	83	LKT4296-29RKY	\$3,712	\$3,767	\$4,276	\$4,335
	42	84	29	161	72	LKT4284-29RKY	\$3,109	\$3,157	\$3,664	\$3,715
	36	96	29	150	72	LKT3696-29RKY	\$2,973	\$3,019	\$3,523	\$3,570
	36	84	29	146	64	LKT3684-29RKY	\$2,717	\$2,760	\$3,258	\$3,300

Features:

- price reflects complete table - top and base
- ships KD in multiple cartons
- one piece top
- model includes adjustable glide

Options:

- specify power/charging option, see below for options and upcharges

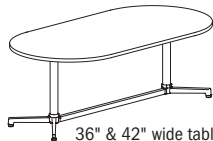

36" & 42" wide tables have single column base



top shape

LOK - CONFERENCE

To Order Specify

1 Laminate Model #	2 Edge Detail	3 Laminate Selection	3a PVC Edge Color	4 Electrical	5 Metal Color
Laminate (LKT)	<a href="#">See Edge Detail Options</a>	<a href="#">See Laminate Selection</a>	<a href="#">See PVC Edge Color Options</a>	N None CT2 Dual Power Center Top CU2 Dual Power Underside CT2U1 Dual Power Center Top with Underside (See chart on next page)	<a href="#">See Metal Finish Color Options</a>

Model Number Breakdown

LKT4896-29RKY					
LK	T	4896	29	RK	Y
LOK	Laminate	48" x 96"	Height	Racetrack Top Shape	Y base

Description

Racetrack Table with Y Base at Working Height (continued)

Veneer Tables "LKV" Models

Solid Surface Tables "LKS" Models

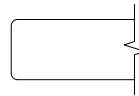

Eased Edge (R3)

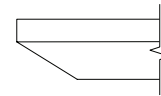

Reverse Bevel Edge (K9)

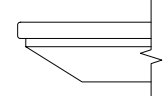

Reverse Bevel Edge (S7)

	D	W	H	CTN WT	CU FT	① Model	Veneer Tables		Solid Surface Tables		
							Essentials	Artisan	Essentials	Artisan	Standard
VENEER	48	96	29	207	105	LKV4896-29RKY	\$5,426	\$5,842	\$5,806	\$6,196	--
	48	84	29	315	83	LKV4884-29RKY	\$4,895	\$5,254	\$5,250	\$5,585	--
	42	96	29	161	83	LKV4296-29RKY	\$5,500	\$5,939	\$5,994	\$6,385	--
	42	84	29	161	72	LKV4284-29RKY	\$4,678	\$5,051	\$5,098	\$5,430	--
	36	96	29	150	72	LKV3696-29RKY	\$4,017	\$4,339	\$4,380	\$4,663	--
	36	84	29	146	64	LKV3684-29RKY	\$3,758	\$4,058	\$4,094	\$4,359	--
SOLID SURFACE	48	96	29	207	105	LKS4896-29RKY	--	--	--	--	\$12,669
	48	84	29	315	83	LKS4884-29RKY	--	--	--	--	\$11,183
	42	96	29	161	83	LKS4296-29RKY	--	--	--	--	\$10,528
	42	84	29	161	72	LKS4284-29RKY	--	--	--	--	\$9,321
	36	96	29	150	72	LKS3696-29RKY	--	--	--	--	\$9,052
	36	84	29	146	64	LKS3684-29RKY	--	--	--	--	\$8,223

Electrical Options and Upcharges

CT2	84 - 96 wide
Dual Power Center Top - Black	CT2BL - add \$1,837
Dual Power Center Top - White	CT2WH - add \$1,837
CU1	
Single Power Underside - Black	CU1-1C - add \$731
Single Power Underside with Wireless Charging - Black	CU1-1CW - add \$1,691
CT2U1	
Dual Power Center Top - Black with Single Underside	CT2U1-BL - add \$2,235
Dual Power Center Top - White with Single Underside	CT2U1-WH - add \$2,235
Dual Power Center Top - Black with Wireless Charging	CT2U1-BLW2 - add \$3,194
Dual Power Center Top - White with Wireless Charging	CT2U1-WHW2 - add \$3,194

LOK - CONFERENCE

Note: Order power infeed that best fits application

To Order Specify

① Veneer Model #	② Edge Detail	③ Wood Collection	④ Wood Finish	⑤ Electrical	⑥ Metal Color
Veneer (LKV)	<a href="#">See Edge Detail Options</a>	Essentials	<a href="#">See Essentials Wood Finish Options</a>	N None CT2 Dual Power Center Top CU2 Dual Power Underside CT2U1 Dual Power Center Top with Underside (See chart above)	<a href="#">See Metal Finish Color Options</a>
		Artisan	④ Wood Finish <a href="#">See Artisan Wood Finish Options</a>		

① Solid Surface Model #	② Top Surface Selection	③ Electrical	④ Metal Color
Solid Surface (LKS)	<a href="#">See Solid Surface Top Surface Selection Options</a>	N None CT2 Dual Power Center Top CU2 Dual Power Underside CT2U1 Dual Power Center Top with Underside (See chart above)	<a href="#">See Metal Finish Color Options</a>

Description

Oval 2pc Table with Y Base at Working Height

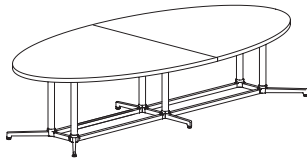

Laminate Tables "LKT" Models

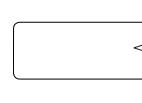

Eased Edge (R3)

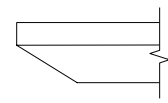

Reverse Bevel Edge (K9)

LAMINATE	D	W	H	CTN WT	CU FT	Model	Eased Edge (R3)		Reverse Bevel Edge (K9)	
							Standard Tier 1	Graded In Tier 2	Standard Tier 1	Graded In Tier 2
	60	120	29	294	130	LKT60120-290VY	\$6,200	\$6,298	\$6,851	\$6,951
54	108	29	222	117	LKT54108-290VY	\$4,858	\$4,937	\$5,471	\$5,552	

Features:

- price reflects complete table - top and base
- ships KD in multiple cartons
- two piece top
- model includes adjustable glide

Options:

- specify power/charging option, see below for options and upcharges

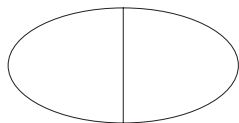

top shape

To Order Specify

1 Laminate Model #	2 Edge Detail	3 Laminate Selection	3a PVC Edge Color	4 Electrical	5 Metal Color
Laminate (LKT)	<a href="#">See Edge Detail Options</a>	<a href="#">See Laminate Selection</a>	<a href="#">See PVC Edge Color Options</a>	N None CT2 Dual Power Center Top CU2 Dual Power Underside CT2U1 Dual Power Center Top with Underside CT4U2 Four Power Center Top with Underside CT4 Four Power Center Top (See chart above)	<a href="#">See Metal Finish Color Options</a>

Model Number Breakdown

LKT60120-290VY					
LK	T	60120	29	OV	Y
LOK	Laminate	60" x 120"	Height	Oval Top Shape	Y base

Description

Oval 2pc Table with Y Base at Working Height (continued)

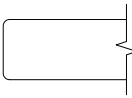
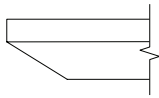
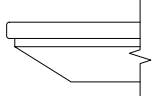
		Veneer Tables "LKV" Models				Solid Surface Tables "LKS" Models					
		 <p>Eased Edge (R3)</p>		 <p>Reverse Bevel Edge (K9)</p>		 <p>Reverse Bevel Edge (S7)</p>					
	D	W	H	CTN WT	CU FT	Model	Essentials	Artisan	Essentials	Artisan	Standard
VENEER	60	120	29	294	130	LKV60120-290VY	\$9,380	\$10,129	\$10,222	\$10,888	--
	54	108	29	222	117	LKV54108-290VY	\$7,287	\$7,833	\$7,725	\$8,237	--
SOL. SURF.	60	120	29	294	130	LKS60120-290VY	--	--	--	--	\$26,607
	54	108	29	222	117	LKS54108-290VY	--	--	--	--	\$21,480

Electrical Options and Upcharges

CT2	108 wide	120 - 192 wide
Dual Power Center Top - Black	CT2BL - add \$1,837	n/a
Dual Power Center Top - White	CT2WH - add \$1,837	n/a
CU1		
Single Power Underside - Black	CU1-1C - add \$731	CU1-1C - add \$849
Single Power Underside with Wireless Charging - Black	CU1-1CW - add \$1,691	CU1-1CW - add \$1,776
CT2U1		
Dual Power Center Top - Black with Underside	CT2U1-BL - add \$2,235	n/a
Dual Power Center Top - White with Underside	CT2U1-WH - add \$2,235	n/a
Dual Power Center Top-Black with Wireless Charging	CT2U1-BLW2 - add \$3,194	n/a
Dual Power Center Top-White with Wireless Charging	CT2U1-WhW2 - add \$3,194	n/a

CT4U1	108 wide	120 - 192 wide
Four Power Center Top with Single Underside - Black	n/a	CT4U1-BL - add \$3,906
Four Power Center Top with Single Underside - White	n/a	CT4U1-WH - add \$3,906
Four Power Center Top - Black with Underside & Wireless Charging	n/a	CT4U1-BLW2 - add \$4,840
Four Power Center Top - White with Underside & Wireless Charging	n/a	CT4U1-WhW2 - add \$4,840
CT4		
Four Power Center Top - Black	n/a	CT4BL - add \$3,421
Four Power Center Top - White	n/a	CT4WH - add \$3,421

Note: Order power infed that best fits application, see page 408.

To Order Specify

1 Veneer Model #	2 Edge Detail	3 Wood Collection	4 Wood Finish	5 Electrical	6 Metal Color
Veneer (LKV)	<a href="#">See Edge Detail Options</a>	Essentials	<a href="#">See Essentials Wood Finish Options</a>	N None CT2 Dual Power Center Top CU2 Dual Power Underside CT2U1 Dual Power Center Top with Underside CT4U2 Four Power Center Top with Underside CT4 Four Power Center Top (See chart on previous page)	<a href="#">See Metal Finish Color Options</a>
		Artisan	4 Wood Finish <a href="#">See Artisan Wood Finish Options</a>		

1 Solid Surface Model #	2 Top Surface Selection	3 Electrical	4 Metal Color
Solid Surface (LKS)	<a href="#">See Solid Surface Top Surface Selection Options</a>	N None CT2 Dual Power Center Top CU2 Dual Power Underside CT2U1 Dual Power Center Top with Underside CT4U2 Four Power Center Top with Underside CT4 Four Power Center Top (See chart on previous page)	<a href="#">See Metal Finish Color Options</a>

LOK - CONFERENCE

Description

Oval Table with Y Base at Working Height

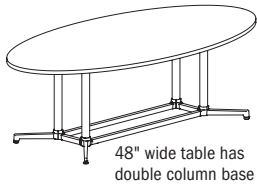

Laminate Tables "LKT" Models

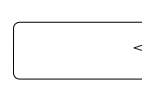

Eased Edge (R3)

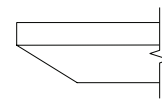

Reverse Bevel Edge (K9)

LAMINATE	D	W	H	CTN WT	CU FT	1 Model	Eased Edge (R3)		Reverse Bevel Edge (K9)	
							Standard Tier 1	Graded In Tier 2	Standard Tier 1	Graded In Tier 2
	48	96	29	186	105	LKT4896-290VY	\$3,809	\$3,874	\$4,391	\$4,454
42	84	29	147	72	LKT4284-290VY	\$3,109	\$3,157	\$3,664	\$3,715	

Features:

- price reflects complete table - top and base
- ships KD in multiple cartons
- one piece top
- model includes adjustable glide

Options:

- specify power/charging option, see below for options and upcharges

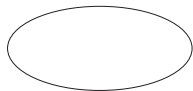
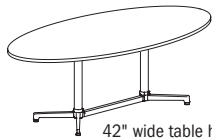

top shape

LOK - CONFERENCE

To Order Specify

1 Laminates Model #	2 Edge Detail	3 Laminates Selection	3a PVC Edge Color	4 Electrical	5 Metal Color
Laminates (LKT)	<a href="#">See Edge Detail Options</a>	<a href="#">See Laminates Selection</a>	<a href="#">See PVC Edge Color Options</a>	N None CT2 Dual Power Center Top CU2 Dual Power Underside CT2U1 Dual Power Center Top with Underside (See chart on next page)	<a href="#">See Metal Finish Color Options</a>

Model Number Breakdown

LKT4896-290VY					
LK	T	4896	29	OV	Y
LOK	Laminates	48" x 96"	Height	Oval Top Shape	Y base

Description

Oval Table with Y Base at Working Height (continued)

Veneer Tables "LKV" Models      Solid Surface Tables "LKS" Models

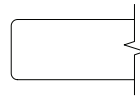

Eased Edge (R3)

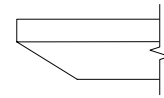

Reverse Bevel Edge (K9)

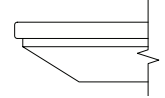

Reverse Bevel Edge (S7)

	D	W	H	CTN WT	CU FT	① Model	Veneer Tables "LKV" Models		Solid Surface Tables "LKS" Models		
							Essentials	Artisan	Essentials	Artisan	Standard
VENEER	48	96	29	186	105	LKV4896-290VY	\$5,313	\$5,729	\$5,693	\$6,083	--
	42	84	29	147	72	LKV4284-290VY	\$4,678	\$5,051	\$5,098	\$5,430	--
SOL SURF	48	96	29	186	105	LKS4896-290VY	--	--	--	--	\$12,556
	42	84	29	147	72	LKS4284-290VY	--	--	--	--	\$9,321

Electrical Options and Upcharges

CT2	84 - 96 wide
Dual Power Center Top - Black	CT2BL - add \$1,837
Dual Power Center Top - White	CT2WH - add \$1,837
CU1	
Single Power Underside - Black	CU1-1C - add \$731
Single Power Underside with Wireless Charging - Black	CU1-1CW - add \$1,691
CT2U1	
Dual Power Center Top - Black with Single Underside	CT2U1-BL - add \$2,235
Dual Power Center Top - White with Single Underside	CT2U1-WH - add \$2,235
Dual Power Center Top - Black with Wireless Charging	CT2U1-BLW2 - add \$3,194
Dual Power Center Top - White with Wireless Charging	CT2U1-WHW2 - add \$3,194

LOK - CONFERENCE

Note: Order power infeed that best fits application

To Order Specify

① Veneer Model #	② Edge Detail	③ Wood Collection	④ Wood Finish	⑤ Electrical	⑥ Metal Color
Veneer (LKV)	<a href="#">See Edge Detail Options</a>	Essentials	<a href="#">See Essentials Wood Finish Options</a>	N None CT2 Dual Power Center Top CU2 Dual Power Underside CT2U1 Dual Power Center Top with Underside (See chart above)	<a href="#">See Metal Finish Color Options</a>
		Artisan	④ Wood Finish <a href="#">See Artisan Wood Finish Options</a>		

① Solid Surface Model #	② Top Surface Selection	③ Electrical	④ Metal Color
Solid Surface (LKS)	<a href="#">See Solid Surface Top Surface Selection Options</a>	N None CT2 Dual Power Center Top CU2 Dual Power Underside CT2U1 Dual Power Center Top with Underside (See chart above)	<a href="#">See Metal Finish Color Options</a>

Description

Boat 3pc Table with T Base at Working Height

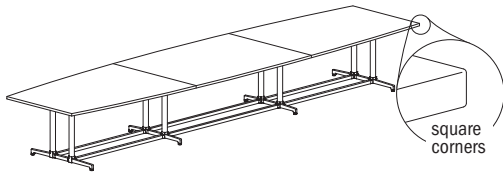

Laminate Tables "LKT" Models

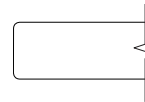

Eased Edge (R3)

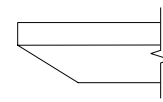

Reverse Bevel Edge (K9)

D	W	H	CTN WT	CU FT	Model	Eased Edge (R3)		Reverse Bevel Edge (K9)	
						Standard Tier 1	Graded In Tier 2	Standard Tier 1	Graded In Tier 2
60	240	29	636	281	LKT60240-29BTT	\$12,271	\$12,471	\$13,108	\$13,305
60	216	29	584	253	LKT60216-29BTT	\$10,460	\$10,636	\$11,260	\$11,438
54	240	29	586	254	LKT54240-29BTT	\$9,900	\$10,074	\$10,693	\$10,870
54	216	29	538	229	LKT54216-29BTT	\$9,309	\$9,470	\$10,073	\$10,232
48	240	29	534	228	LKT48240-29BTT	\$9,429	\$9,588	\$10,183	\$10,339
48	216	29	538	206	LKT48216-29BTT	\$8,341	\$8,484	\$9,068	\$9,210

LAMINATE

Features:

- price reflects complete table - top and base
- ships KD in multiple cartons
- three piece top
- model includes adjustable glide

Options:

- specify power/charging option, see below for options and upcharges



top shape

LOK - CONFERENCE

To Order Specify

1 Laminate Model #	2 Edge Detail	3 Laminate Selection	4 PVC Edge Color	4 Electrical	5 Metal Color
Laminate (LKT)	<a href="#">See Edge Detail Options</a>	<a href="#">See Laminate Selection</a>	<a href="#">See PVC Edge Color Options</a>	N None CT6 Six Power Center Top CU2 Dual Power Underside CT6U2 Six Power Center Top with Underside (See chart on next page)	<a href="#">See Metal Finish Color Options</a>

Model Number Breakdown

LKT60240-29BTT					
LK	T	60240	29	BT	T
LOK	Laminate	60" x 240"	Height	Boat Top Shape	T base

Description

Boat 3pc Table with T Base  
at Working Height  
(continued)

Veneer Tables  
"LKV" Models

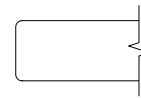

Eased Edge (R3)

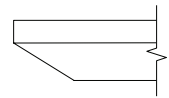

Reverse Bevel Edge (K9)

D	W	H	CTN WT	CU FT	① Model	Eased Edge (R3)		Reverse Bevel Edge (K9)		
						Essentials	Artisan	Essentials	Artisan	
60	240	29	636	281	LKV60240-29BTT	\$19,086	\$20,613	\$20,803	\$22,155	
60	216	29	584	253	LKV60216-29BTT	\$16,800	\$18,143	\$18,311	\$19,502	
VENEER	54	240	29	586	254	LKV54240-29BTT	\$16,169	\$17,479	\$16,932	\$18,176
	54	216	29	538	229	LKV54216-29BTT	\$15,005	\$16,169	\$15,705	\$16,809
	48	240	29	534	228	LKV48240-29BTT	\$15,170	\$16,325	\$15,864	\$16,954
	48	216	29	538	206	LKV48216-29BTT	\$13,324	\$14,350	\$13,964	\$14,932

Electrical Options and Upcharges

	216 - 240 wide
<b>CT6</b>	
Six Power Center Top - Black	CT6BL - add \$4,949
Six Power Center Top - White	CT6WH - add \$4,949
<b>CU2</b>	
Dual Power Underside - Black	CU2-1C - add \$1,298
Dual Power Underside with 4 Wireless Charging - Black	CU2-1CW - add \$3,278
<b>CT6U2</b>	
Six Power Center Top - Black with Dual Underside	CT6U2-BL - add \$5,748
Six Power Center Top - White with Dual Underside	CT6U2-WH - add \$5,748
Six Power Center Top - Black Dual Underside with 4 Wireless Charging	CT6U2-BLW2 - add \$7,668
Six Power Center Top - White Dual Underside with 4 Wireless Charging	CT6U2-WHW2 - add \$7,668

Note: Order power infeed that best fits application

To Order Specify

① Veneer Model #	② Edge Detail	③ Wood Collection	④ Wood Finish	⑤ Electrical	⑥ Metal Color
Veneer (LKV)	<a href="#">See Edge Detail Options</a>	Essentials	<a href="#">See Essentials Wood Finish Options</a>	N None CT6 Six Power Center Top CU2 Dual Power Underside CT6U2 Six Power Center Top with Underside (See chart above)	<a href="#">See Metal Finish Color Options</a>
		Artisan	<b>④ Wood Finish</b> <a href="#">See Artisan Wood Finish Options</a>		

LOK - CONFERENCE

Description

Boat 2pc Table with T Base at Working Height

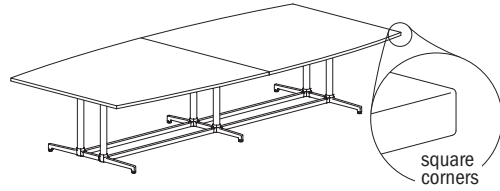

Laminate Tables "LKT" Models

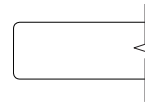

Eased Edge (R3)

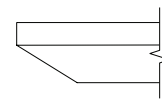

Reverse Bevel Edge (K9)

D	W	H	CTN WT	CU FT	Model	Eased Edge (R3)		Reverse Bevel Edge (K9)	
						Standard Tier 1	Graded In Tier 2	Standard Tier 1	Graded In Tier 2
60	192	29	511	226	LKT60192-29BTT	\$8,547	\$8,708	\$9,307	\$9,465
60	168	29	449	198	LKT60168-29BTT	\$7,977	\$8,115	\$8,699	\$8,838
60	144	29	395	169	LKT60144-29BTT	\$7,360	\$7,478	\$8,048	\$8,165
60	120	29	342	143	LKT60120-29BTT	\$6,526	\$6,623	\$7,176	\$7,275
54	192	29	459	204	LKT54192-29BTT	\$8,133	\$8,277	\$8,861	\$9,004
54	168	29	377	178	LKT54168-29BTT	\$7,367	\$7,493	\$8,065	\$8,187
54	144	29	365	154	LKT54144-29BTT	\$6,787	\$6,895	\$7,452	\$7,558
54	120	29	316	130	LKT54120-29BTT	\$6,081	\$6,169	\$6,708	\$6,798
48	192	29	419	183	LKT48192-29BTT	\$7,097	\$7,224	\$7,793	\$7,918
48	168	29	377	161	LKT48168-29BTT	\$6,598	\$6,708	\$7,264	\$7,375
48	144	29	334	139	LKT48144-29BTT	\$6,053	\$6,147	\$6,691	\$6,787
48	120	29	290	116	LKT48120-29BTT	\$5,439	\$5,518	\$6,051	\$6,130
48	108	29	268	105	LKT48108-29BTT	\$4,609	\$4,678	\$5,202	\$5,274

LAMINATE

Features:

- price reflects complete table - top and base
- ships KD in multiple cartons
- two piece top
- model includes adjustable glide

Options:

- specify power/charging option, see below for options and upcharges



top shape

LOK - CONFERENCE

To Order Specify

1 Laminate Model #	2 Edge Detail	3 Laminate Selection	3a PVC Edge Color	4 Electrical	5 Metal Color
Laminate (LKT)	<a href="#">See Edge Detail Options</a>	<a href="#">See Laminate Selection</a>	<a href="#">See PVC Edge Color Options</a>	N None CT2 Dual Power Center Top CU2 Dual Power Underside CT2U1 Dual Power Center Top with Underside CT4U2 Four Power Center Top with Underside CT4 Four Power Center Top (See chart on next page)	<a href="#">See Metal Finish Color Options</a>

Model Number Breakdown

LKT60192-29BTT					
LK	T	60192	29	BT	T
LOK	Laminate	60" x 192"	Height	Boat Top Shape	T base

Description

Boat 2pc Table with  
T Base at Working Height  
(continued)

Veneer Tables  
"LKV" Models

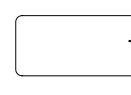

Eased Edge (R3)

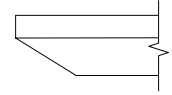

Reverse Bevel Edge (K9)

D	W	H	CTN WT	CU FT	Model	Eased Edge (R3)		Reverse Bevel Edge (K9)		
						Essentials	Artisan	Essentials	Artisan	
60	192	29	511	226	LKV60192-29BTT	\$13,301	\$14,366	\$14,497	\$15,439	
60	168	29	449	198	LKV60168-29BTT	\$12,235	\$13,213	\$13,335	\$14,202	
60	144	29	395	169	LKV60144-29BTT	\$11,137	\$12,028	\$12,138	\$12,928	
60	120	29	342	143	LKV60120-29BTT	\$9,827	\$10,613	\$10,712	\$11,405	
VENEER	54	192	29	459	204	LKV54192-29BTT	\$12,166	\$13,143	\$13,263	\$14,122
	54	168	29	377	178	LKV54168-29BTT	\$11,127	\$12,018	\$12,128	\$12,916
	54	144	29	365	154	LKV54144-29BTT	\$10,106	\$10,914	\$11,017	\$11,730
	54	120	29	316	130	LKV54120-29BTT	\$8,944	\$9,658	\$9,747	\$10,378
48	192	29	419	183	LKV48192-29BTT	\$10,927	\$11,822	\$11,511	\$12,356	
48	168	29	377	161	LKV48168-29BTT	\$10,017	\$10,790	\$10,549	\$11,281	
48	144	29	334	139	LKV48144-29BTT	\$9,072	\$9,725	\$9,556	\$10,170	
48	120	29	290	116	LKV48120-29BTT	\$8,065	\$8,601	\$8,500	\$9,003	
48	108	29	268	105	LKV48108-29BTT	\$6,622	\$7,152	\$7,217	\$7,685	

Electrical Options and Upcharges

	108 wide	120 - 192 wide
<b>CT2</b>		
Dual Power Center Top - Black	CT2BL - add \$1,837	n/a
Dual Power Center Top - White	CT2WH - add \$1,837	n/a
<b>CU1</b>		
Single Power Underside - Black	CU1-1C - add \$731	CU1-1C - add \$849
Single Power Underside with Wireless Charging - Black	CU1-1CW - add \$1,691	CU1-1CW - add \$1,776
<b>CT2U1</b>		
Dual Power Center Top - Black with Underside	CT2U1-BL - add \$2,235	n/a
Dual Power Center Top - White with Underside	CT2U1-WH - add \$2,235	n/a
Dual Power Center Top - Black with Wireless Charging	CT2U1-BLW2 - add \$3,194	n/a
Dual Power Center Top - White with Wireless Charging	CT2U1-WHW2 - add \$3,194	n/a

	108 wide	120 - 192 wide
<b>CT4U1</b>		
Four Power Center Top with Single Underside - Black	n/a	CT4U1-BL - add \$3,906
Four Power Center Top with Single Underside - White	n/a	CT4U1-WH - add \$3,906
Four Power Center Top - Black with Underside & Wireless Charging	n/a	CT4U1-BLW2 - add \$4,840
Four Power Center Top - White with Underside & Wireless Charging	n/a	CT4U1-WHW2 - add \$4,840
<b>CT4</b>		
Four Power Center Top - Black	n/a	CT4BL - add \$3,421
Four Power Center Top - White	n/a	CT4WH - add \$3,421

Note: Order power infeed that best fits application

To Order Specify

1 Veneer Model #	2 Edge Detail	3 Wood Collection	4 Wood Finish	5 Electrical	6 Metal Color
Veneer (LKV)	<a href="#">See Edge Detail Options</a>	Essentials	<a href="#">See Essentials Wood Finish Options</a>	N None CT2 Dual Power Center Top CU2 Dual Power Underside CT2U1 Dual Power Center Top with Underside CT4U2 Four Power Center Top with Underside CT4 Four Power Center Top	<a href="#">See Metal Finish Color Options</a>
		Artisan	4 Wood Finish <a href="#">See Artisan Wood Finish Options</a>		

LOK - CONFERENCE

Description

Boat Table with T Base at Working Height

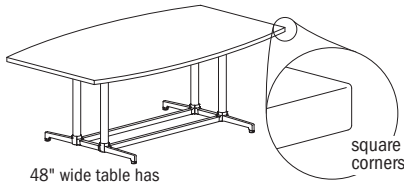

48" wide table has double column base

Laminate Tables "LKT" Models

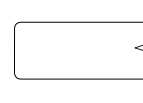

Eased Edge (R3)

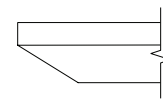

Reverse Bevel Edge (K9)

LAMINATE

D	W	H	CTN WT	CU FT	Model	Eased Edge (R3)		Reverse Bevel Edge (K9)	
						Standard Tier 1	Graded In Tier 2	Standard Tier 1	Graded In Tier 2
48	96	29	219	83	LKT4896-29BTT	\$3,875	\$3,936	\$4,456	\$4,521
48	84	29	198	83	LKT4884-29BTT	\$3,439	\$3,498	\$4,007	\$4,062
42	96	29	177	73	LKT4296-29BTT	\$3,517	\$3,572	\$4,084	\$4,138
42	84	29	158	72	LKT4284-29BTT	\$2,897	\$2,947	\$3,455	\$3,503
36	96	29	156	72	LKT3696-29BTT	\$2,957	\$3,007	\$3,510	\$3,557
36	84	29	146	64	LKT3684-29BTT	\$2,655	\$2,694	\$3,194	\$3,238

Features:

- price reflects complete table - top and base
- ships KD in multiple cartons
- one piece top
- model includes adjustable glide

Options:

- specify power/charging option, see below for options and upcharges

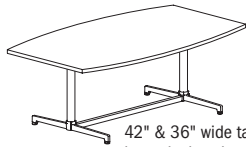

42" & 36" wide tables have single column base



top shape

LOK - CONFERENCE

To Order Specify

1 Laminate Model #	2 Edge Detail	3 Laminate Selection	3a PVC Edge Color	4 Electrical	5 Metal Color
Laminate (LKT)	<a href="#">See Edge Detail Options</a>	<a href="#">See Laminate Selection</a>	<a href="#">See PVC Edge Color Options</a>	N None CT2 Dual Power Center Top CU2 Dual Power Underside CT2U1 Dual Power Center Top with Underside (See chart on next page)	<a href="#">See Metal Finish Color Options</a>

Model Number Breakdown

LKT4896-29BTT					
LK	T	4896	29	BT	T
LOK	Laminate	48" x 96"	Height	Boat Top Shape	T base

Description

Boat Table with T Base at Working Height (continued)

Veneer Tables "LKV" Models



Eased Edge (R3)

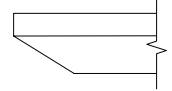

Reverse Bevel Edge (K9)

VENEER	D	W	H	CTN WT	CU FT	1 Model	Essentials	Artisan	Essentials	Artisan
	48	96	29	219	83	LKV4896-29BTT	\$5,395	\$5,810	\$5,776	\$6,168
48	84	29	198	83	LKV4884-29BTT	\$4,922	\$5,281	\$5,276	\$5,610	
42	96	29	177	73	LKV4296-29BTT	\$5,256	\$5,678	\$5,729	\$6,100	
42	84	29	158	72	LKV4284-29BTT	\$4,419	\$4,771	\$4,817	\$5,131	
36	96	29	156	72	LKV3696-29BTT	\$4,001	\$4,320	\$4,359	\$4,644	
36	84	29	146	64	LKV3684-29BTT	\$3,682	\$3,973	\$4,012	\$4,270	

Electrical Options and Upcharges

CT2	84 - 96 wide
Dual Power Center Top - Black	CT2BL - add \$1,837
Dual Power Center Top - White	CT2WH - add \$1,837
CU1	
Single Power Underside - Black	CU1-1C - add \$731
Single Power Underside with Wireless Charging - Black	CU1-1CW - add \$1,691
CT2U1	
Dual Power Center Top - Black with Single Underside	CT2U1-BL - add \$2,235
Dual Power Center Top - White with Single Underside	CT2U1-WH - add \$2,235
Dual Power Center Top - Black with Wireless Charging	CT2U1-BLW2 - add \$3,194
Dual Power Center Top - White with Wireless Charging	CT2U1-WHW2 - add \$3,194

Note: Order power infed that best fits application

To Order Specify

1 Veneer Model #	2 Edge Detail	3 Wood Collection	4 Wood Finish	5 Electrical	6 Metal Color
Veneer (LKV)	<a href="#">See Edge Detail Options</a>	Essentials	<a href="#">See Essentials Wood Finish Options</a>	N None CT2 Dual Power Center Top CU2 Dual Power Underside CT2U1 Dual Power Center Top with Underside (See chart above)	<a href="#">See Metal Finish Color Options</a>
		Artisan	4 Wood Finish <a href="#">See Artisan Wood Finish Options</a>		

LOK - CONFERENCE

Description

Rounded Boat 3pc Table with T Base at Working Height

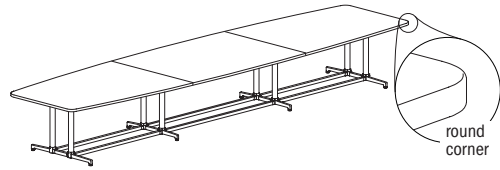

Laminate Tables "LKT" Models

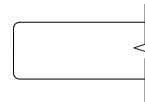

Eased Edge (R3)

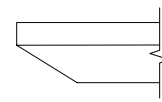

Reverse Bevel Edge (K9)

LAMINATE	D	W	H	CTN WT	CU FT	1 Model	Standard Tier 1	Graded In Tier 2	Standard Tier 1	Graded In Tier 2
		60	240	29	636	281	LKT60240-29BTRT	\$12,271	\$12,471	\$13,108
	60	216	29	584	253	LKT60216-29BTRT	\$10,460	\$10,636	\$11,260	\$11,438
	54	240	29	586	254	LKT54240-29BTRT	\$9,900	\$10,074	\$10,693	\$10,870
	54	216	29	538	229	LKT54216-29BTRT	\$9,309	\$9,470	\$10,073	\$10,232
	48	240	29	534	228	LKT48240-29BTRT	\$9,429	\$9,588	\$10,183	\$10,339
	48	216	29	538	206	LKT48216-29BTRT	\$8,341	\$8,484	\$9,068	\$9,210

Features:

- price reflects complete table - top and base
- ships KD in multiple cartons
- three piece top
- model includes adjustable glide

Options:

- specify power/charging option, see below for options and upcharges



top shape

LOK - CONFERENCE

To Order Specify

1 Laminate Model #	2 Edge Detail	3 Laminate Selection	3a PVC Edge Color	4 Electrical	5 Metal Color
Laminate (LKT)	<a href="#">See Edge Detail Options</a>	<a href="#">See Laminate Selection</a>	<a href="#">See PVC Edge Color Options</a>	N None CT6 Six Power Center Top CU2 Dual Power Underside CT6U2 Six Power Center Top with Underside (See chart on next page)	<a href="#">See Metal Finish Color Options</a>

Model Number Breakdown

LKT60240-29BTRT						
LK	T	60240	29	BT	R	T
LOK	Laminate	60" x 240"	Height	Boat Top Shape	Rounded Corner	T base

Description

Rounded Boat 3pc Table with T Base at Working Height (continued)

Veneer Tables "LKV" Models

Solid Surface Tables "LKS" Models

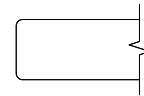

Eased Edge (R3)

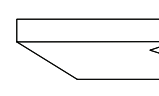

Reverse Bevel Edge (K9)

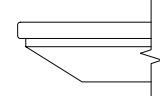

Reverse Bevel Edge (S7)

	D	W	H	CTN WT	CU FT	① Model	Veneer		Solid Surface		
							Essentials	Artisan	Essentials	Artisan	Standard
VENEER	60	240	29	636	281	LKV60240-29BTRT	\$19,086	\$20,613	\$20,803	\$22,155	--
	60	216	29	584	253	LKV60216-29BTRT	\$16,800	\$18,143	\$18,311	\$19,502	--
	54	240	29	586	254	LKV54240-29BTRT	\$16,169	\$17,479	\$16,932	\$18,176	--
	54	216	29	538	229	LKV54216-29BTRT	\$15,005	\$16,169	\$15,705	\$16,809	--
	48	240	29	534	228	LKV48240-29BTRT	\$15,170	\$16,325	\$15,864	\$16,954	--
	48	216	29	538	206	LKV48216-29BTRT	\$13,324	\$14,350	\$13,964	\$14,932	--
SOLID SURFACE	60	240	29	636	281	LKS60240-29BTRT	--	--	--	--	\$42,849
	60	216	29	584	253	LKS60216-29BTRT	--	--	--	--	\$38,729
	54	240	29	586	254	LKS54240-29BTRT	--	--	--	--	\$38,990
	54	216	29	538	229	LKS54216-29BTRT	--	--	--	--	\$35,281
	48	240	29	534	228	LKS48240-29BTRT	--	--	--	--	\$35,212
	48	216	29	538	206	LKS48216-29BTRT	--	--	--	--	\$31,136

Electrical Options and Upcharges

	216 - 240 wide
<b>CT6</b>	
Six Power Center Top - Black	CT6BL - add \$4,949
Six Power Center Top - White	CT6WH - add \$4,949
<b>CU2</b>	
Dual Power Underside - Black	CU2-1C - add \$1,298
Dual Power Underside with 4 Wireless Charging - Black	CU2-1CW - add \$3,278
<b>CT6U2</b>	
Six Power Center Top - Black with Dual Underside	CT6U2-BL - add \$5,748
Six Power Center Top - White with Dual Underside	CT6U2-WH - add \$5,748
Six Power Center Top - Black Dual Underside with 4 Wireless Charging	CT6U2-BLW2 - add \$7,668
Six Power Center Top - White Dual Underside with 4 Wireless Charging	CT6U2-WHW2 - add \$7,668

LOK - CONFERENCE

To Order Specify

Note: Order power infed that best fits application

① Veneer Model #	② Edge Detail	③ Wood Collection	④ Wood Finish	⑤ Electrical	⑥ Metal Color
Veneer (LKV)	<a href="#">See Edge Detail Options</a>	Essentials	<a href="#">See Essentials Wood Finish Options</a>	N None CT6 Six Power Center Top CU2 Dual Power Underside CT6U2 Six Power Center Top with Underside (See chart above)	<a href="#">See Metal Finish Color Options</a>
		Artisan	④ Wood Finish <a href="#">See Artisan Wood Finish Options</a>		

① Solid Surface Model #	② Top Surface Selection	③ Electrical	④ Metal Color
Solid Surface (LKS)	<a href="#">See Solid Surface Top Surface Selection Options</a>	N None CT6 Six Power Center Top CU2 Dual Power Underside CT6U2 Six Power Center Top with Underside (See chart above)	<a href="#">See Metal Finish Color Options</a>

Description

Rounded Boat 2pc Table with T Base at Working Height

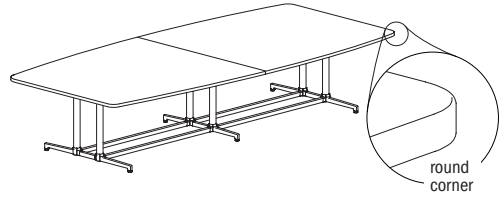

Laminate Tables "LKT" Models

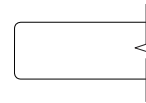

Eased Edge (R3)

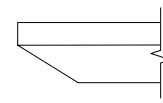

Reverse Bevel Edge (K9)

D	W	H	CTN WT	CU FT	Model	Eased Edge (R3)		Reverse Bevel Edge (K9)	
						Standard Tier 1	Graded In Tier 2	Standard Tier 1	Graded In Tier 2
60	192	29	511	226	LKT60192-29BTRT	\$8,547	\$8,708	\$9,307	\$9,465
60	168	29	449	198	LKT60168-29BTRT	\$7,977	\$8,115	\$8,699	\$8,838
60	144	29	395	169	LKT60144-29BTRT	\$7,360	\$7,478	\$8,048	\$8,165
60	120	29	342	143	LKT60120-29BTRT	\$6,526	\$6,623	\$7,176	\$7,275
54	192	29	459	204	LKT54192-29BTRT	\$8,133	\$8,277	\$8,861	\$9,004
54	168	29	377	178	LKT54168-29BTRT	\$7,367	\$7,493	\$8,065	\$8,187
54	144	29	365	154	LKT54144-29BTRT	\$6,787	\$6,895	\$7,452	\$7,558
54	120	29	316	130	LKT54120-29BTRT	\$6,081	\$6,169	\$6,708	\$6,798
48	192	29	419	183	LKT48192-29BTRT	\$7,097	\$7,224	\$7,793	\$7,918
48	168	29	377	161	LKT48168-29BTRT	\$6,598	\$6,708	\$7,264	\$7,375
48	144	29	334	139	LKT48144-29BTRT	\$6,053	\$6,147	\$6,691	\$6,787
48	120	29	290	116	LKT48120-29BTRT	\$5,439	\$5,518	\$6,051	\$6,130
48	108	29	268	105	LKT48108-29BTRT	\$4,609	\$4,678	\$5,202	\$5,274

LAMINATE

Features:

- price reflects complete table - top and base
- ships KD in multiple cartons
- two piece top
- model includes adjustable glide

Options:

- specify power/charging option, see below for options and upcharges

Electrical Options and Upcharges

	108 wide	120 - 192 wide
<b>CT2</b>		
Dual Power Center Top - Black	CT2BL - add \$1,837	n/a
Dual Power Center Top - White	CT2WH - add \$1,837	n/a
<b>CU1</b>		
Single Power Underside - Black	CU1-1C - add \$731	CU1-1C - add \$849
Single Power Underside with Wireless Charging - Black	CU1-1CW - add \$1,691	CU1-1CW - add \$1,776
<b>CT2U1</b>		
Dual Power Center Top - Black with Underside	CT2U1-BL - add \$2,235	n/a
Dual Power Center Top - White with Underside	CT2U1-WH - add \$2,235	n/a
Dual Power Center Top - Black with Wireless Charging	CT2U1-BLW2 - add \$3,194	n/a
Dual Power Center Top - White with Wireless Charging	CT2U1-WHW2 - add \$3,194	n/a

Note: Order power infeed that best fits application.

	108 wide	120 - 192 wide
<b>CT4U1</b>		
Four Power Center Top with Single Underside - Black	n/a	CT4U1-BL - add \$3,906
Four Power Center Top with Single Underside - White	n/a	CT4U1-WH - add \$3,906
Four Power Center Top - Black with Underside & Wireless Charging	n/a	CT4U1-BLW2 - add \$4,840
Four Power Center Top - White with Underside & Wireless Charging	n/a	CT4U1-WHW2 - add \$4,840
<b>CT4</b>		
Four Power Center Top - Black	n/a	CT4BL - add \$3,421
Four Power Center Top - White	n/a	CT4WH - add \$3,421



top shape

To Order Specify

1 Laminate Model #	2 Edge Detail	3 Laminate Selection	3a PVC Edge Color	4 Electrical	5 Metal Color
Laminate (LKT)	<a href="#">See Edge Detail Options</a>	<a href="#">See Laminate Selection</a>	<a href="#">See PVC Edge Color Options</a>	N None CT2 Dual Power Center Top CU2 Dual Power Underside CT2U1 Dual Power Center Top with Underside CT4U2 Four Power Center Top with Underside CT4 Four Power Center Top (See chart above)	<a href="#">See Metal Finish Color Options</a>

Model Number Breakdown

LKT60192-29BTRT						
LK	T	60192	29	BT	R	T
LOK	Laminate	60" x 192"	Height	Boat Top Shape	Rounded Corner	T base

LOK - CONFERENCE

Description

Rounded Boat 2pc Table with T Base at Working Height (continued)

Veneer Tables "LKV" Models      Solid Surface Tables "LKS" Models

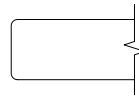

Eased Edge (R3)

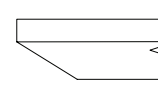

Reverse Bevel Edge (K9)

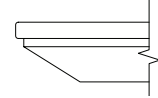

Reverse Bevel Edge (S7)

	D	W	H	CTN WT	CU FT	① Model	Veneer		Solid Surface		
							Essentials	Artisan	Essentials	Artisan	Standard
VENEER	60	192	29	511	226	LKV60192-29BTRT	\$13,301	\$14,366	\$14,497	\$15,439	--
	60	168	29	449	198	LKV60168-29BTRT	\$12,235	\$13,213	\$13,335	\$14,202	--
	60	144	29	395	169	LKV60144-29BTRT	\$11,137	\$12,028	\$12,138	\$12,928	--
	60	120	29	342	143	LKV60120-29BTRT	\$9,827	\$10,613	\$10,712	\$11,405	--
	54	192	29	459	204	LKV54192-29BTRT	\$12,166	\$13,143	\$13,263	\$14,122	--
	54	168	29	377	178	LKV54168-29BTRT	\$11,127	\$12,018	\$12,128	\$12,916	--
	54	144	29	365	154	LKV54144-29BTRT	\$10,106	\$10,914	\$11,017	\$11,730	--
	54	120	29	316	130	LKV54120-29BTRT	\$8,944	\$9,658	\$9,747	\$10,378	--
	48	192	29	419	183	LKV48192-29BTRT	\$13,301	\$11,822	\$11,511	\$12,356	--
	48	168	29	377	161	LKV48168-29BTRT	\$10,017	\$10,790	\$10,549	\$11,281	--
	48	144	29	334	139	LKV48144-29BTRT	\$9,072	\$9,725	\$9,556	\$10,170	--
	48	120	29	290	116	LKV48120-29BTRT	\$8,065	\$8,601	\$8,500	\$9,003	--
48	108	29	268	105	LKV48108-29BTRT	\$6,622	\$7,152	\$7,217	\$7,685	--	
SOLID SURFACE	60	192	29	511	226	LKS60192-29BTRT	--	--	--	--	\$32,183
	60	168	29	449	198	LKS60168-29BTRT	--	--	--	--	\$28,438
	60	144	29	395	169	LKS60144-29BTRT	--	--	--	--	\$24,738
	60	120	29	342	143	LKS60120-29BTRT	--	--	--	--	\$27,055
	54	192	29	459	204	LKS54192-29BTRT	--	--	--	--	\$29,137
	54	168	29	377	178	LKS54168-29BTRT	--	--	--	--	\$25,867
	54	144	29	365	154	LKS54144-29BTRT	--	--	--	--	\$22,540
	54	120	29	316	130	LKS54120-29BTRT	--	--	--	--	\$19,149
	48	192	29	419	183	LKS48192-29BTRT	--	--	--	--	\$26,347
	48	168	29	377	161	LKS48168-29BTRT	--	--	--	--	\$23,357
	48	144	29	334	139	LKS48144-29BTRT	--	--	--	--	\$20,391
	48	120	29	290	116	LKS48120-29BTRT	--	--	--	--	\$17,434
48	108	29	268	105	LKS48108-29BTRT	--	--	--	--	\$15,926	

LOK- CONFERENCE

To Order Specify

① Veneer Model #	② Edge Detail	③ Wood Collection	④ Wood Finish	⑤ Electrical	⑥ Metal Color
Veneer (LKV)	<a href="#">See Edge Detail Options</a>	Essentials	<a href="#">See Essentials Wood Finish Options</a>	N None CT2 Dual Power Center Top CU2 Dual Power Underside CT2U1 Dual Power Center Top with Underside CT4U2 Four Power Center Top with Underside CT4 Four Power Center Top (See chart on previous page)	<a href="#">See Metal Finish Color Options</a>
		Artisan	④ Wood Finish <a href="#">See Artisan Wood Finish Options</a>		

① Solid Surface Model #	② Top Surface Selection	③ Electrical	④ Metal Color
Solid Surface (LKS)	<a href="#">See Solid Surface Top Surface Selection Options</a>	N None CT2 Dual Power Center Top CU2 Dual Power Underside CT2U1 Dual Power Center Top with Underside CT4U2 Four Power Center Top with Underside CT4 Four Power Center Top (See chart on previous page)	<a href="#">See Metal Finish Color Options</a>

Description

Rounded Boat Table with T Base at Working Height

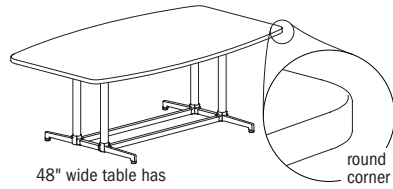

48" wide table has double column base

D	W	H	CTN WT	CU FT	1 Model
48	96	29	219	83	LKT4896-29BTRT
48	84	29	198	83	LKT4884-29BTRT
42	96	29	177	73	LKT4296-29BTRT
42	84	29	158	72	LKT4284-29BTRT
36	96	29	156	72	LKT3696-29BTRT
36	84	29	146	64	LKT3684-29BTRT

LAMINATE

Laminate Tables "LKT" Models

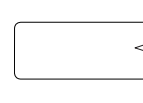

Eased Edge (R3)

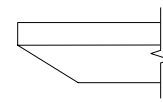

Reverse Bevel Edge (K9)

Eased Edge (R3)		Reverse Bevel Edge (K9)	
Standard Tier 1	Graded In Tier 2	Standard Tier 1	Graded In Tier 2
\$3,875	\$3,936	\$4,456	\$4,521
\$3,439	\$3,498	\$4,007	\$4,062
\$3,517	\$3,572	\$4,084	\$4,138
\$2,897	\$2,947	\$3,455	\$3,503
\$2,957	\$3,007	\$3,510	\$3,557
\$2,655	\$2,694	\$3,194	\$3,238

Features:

- price reflects complete table - top and base
- ships KD in multiple cartons
- one piece top
- model includes adjustable glide

Options:

- specify power/charging option, see below for options and upcharges

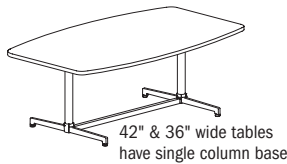

42" & 36" wide tables have single column base



top shape

LOK - CONFERENCE

To Order Specify

1 Laminate Model #	2 Edge Detail	3 Laminate Selection	3a PVC Edge Color	4 Electrical	5 Metal Color
Laminate (LKT)	<a href="#">See Edge Detail Options</a>	<a href="#">See Laminate Selection</a>	<a href="#">See PVC Edge Color Options</a>	N None CT2 Dual Power Center Top CU2 Dual Power Underside CT2U1 Dual Power Center Top with Underside (See chart on next page)	<a href="#">See Metal Finish Color Options</a>

Model Number Breakdown

LKT4896-29BTRT						
LK	T	4896	29	BT	R	T
LOK	Laminate	48" x 96"	Height	Boat Top Shape	Rounded Corner	T base

Description

Rounded Boat Table with T Base at Working Height (continued)

Veneer Tables "LKV" Models      Solid Surface Tables "LKS" Models

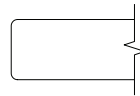

Eased Edge (R3)

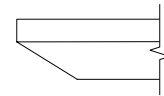

Reverse Bevel Edge (K9)

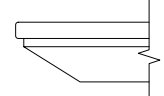

Reverse Bevel Edge (S7)

	D	W	H	CTN WT	CU FT	① Model	Veneer		Solid Surface		
							Essentials	Artisan	Essentials	Artisan	Standard
VENEER	48	96	29	219	83	LKV4896-29BTRT	\$5,395	\$5,810	\$5,776	\$6,168	--
	48	84	29	198	83	LKV4884-29BTRT	\$4,922	\$5,281	\$5,276	\$5,610	--
	42	96	29	177	73	LKV4296-29BTRT	\$5,256	\$5,678	\$5,729	\$6,100	--
	42	84	29	158	72	LKV4284-29BTRT	\$4,419	\$4,771	\$4,817	\$5,131	--
	36	96	29	156	72	LKV3696-29BTRT	\$4,001	\$4,320	\$4,359	\$4,644	--
	36	84	29	146	64	LKV3684-29BTRT	\$3,682	\$3,973	\$4,012	\$4,270	--
SOLID SURFACE	48	96	29	219	83	LKS4896-29BTRT	--	--	--	--	\$12,641
	48	84	29	198	83	LKS4884-29BTRT	--	--	--	--	\$11,205
	42	96	29	177	73	LKS4296-29BTRT	--	--	--	--	\$10,285
	42	84	29	158	72	LKS4284-29BTRT	--	--	--	--	\$9,066
	36	96	29	156	72	LKS3696-29BTRT	--	--	--	--	\$9,038
	36	84	29	146	64	LKS3684-29BTRT	--	--	--	--	\$8,146

Electrical Options and Upcharges

CT2	84 - 96 wide
Dual Power Center Top - Black	CT2BL - add \$1,837
Dual Power Center Top - White	CT2WH - add \$1,837
CU1	
Single Power Underside - Black	CU1-1C - add \$731
Single Power Underside with Wireless Charging - Black	CU1-1CW - add \$1,691
CT2U1	
Dual Power Center Top - Black with Single Underside	CT2U1-BL - add \$2,235
Dual Power Center Top - White with Single Underside	CT2U1-WH - add \$2,235
Dual Power Center Top - Black with Wireless Charging	CT2U1-BLW2 - add \$3,194
Dual Power Center Top - White with Wireless Charging	CT2U1-WhW2 - add \$3,194

LOK - CONFERENCE

Note: Order power infeed that best fits application

To Order Specify

① Veneer Model #	② Edge Detail	③ Wood Collection	④ Wood Finish	⑤ Electrical	⑥ Metal Color
Veneer (LKV)	<a href="#">See Edge Detail Options</a>	Essentials	<a href="#">See Essentials Wood Finish Options</a>	N None CT2 Dual Power Center Top CU2 Dual Power Underside CT2U1 Dual Power Center Top with Underside (See chart above)	<a href="#">See Metal Finish Color Options</a>
		Artisan	④ Wood Finish <a href="#">See Artisan Wood Finish Options</a>		

① Solid Surface Model #	② Top Surface Selection	③ Electrical	④ Metal Color
Solid Surface (LKS)	<a href="#">See Solid Surface Top Surface Selection Options</a>	N None CT2 Dual Power Center Top CU2 Dual Power Underside CT2U1 Dual Power Center Top with Underside (See chart above)	<a href="#">See Metal Finish Color Options</a>

Description

Boat 3pc Table with Y Base at Working Height

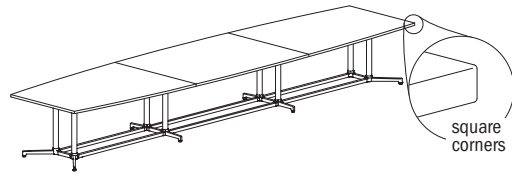

Laminate Tables "LKT" Models

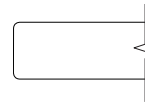

Eased Edge (R3)

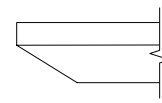

Reverse Bevel Edge (K9)

LAMINATE	D	W	H	CTN WT	CU FT	Model	Standard Tier 1	Graded In Tier 2	Standard Tier 1	Graded In Tier 2
		60	240	29	636	281	LKT60240-29BTY	\$11,889	\$12,084	\$12,723
	60	216	29	584	253	LKT60216-29BTY	\$10,053	\$10,232	\$10,852	\$11,030
	54	240	29	575	254	LKT54240-29BTY	\$9,406	\$9,582	\$10,200	\$10,376
	54	216	29	523	229	LKT54216-29BTY	\$8,408	\$8,568	\$9,169	\$9,329
	48	240	29	537	228	LKT48240-29BTY	\$9,088	\$9,249	\$9,841	\$9,999
	48	216	29	477	206	LKT48216-29BTY	\$8,423	\$8,566	\$9,152	\$9,291

Features:

- price reflects complete table - top and base
- ships KD in multiple cartons
- three piece top
- model includes adjustable glide

Options:

- specify power/charging option, see below for options and upcharges



top shape

LOK - CONFERENCE

To Order Specify

1 Laminate Model #	2 Edge Detail	3 Laminate Selection	4 PVC Edge Color	4 Electrical	5 Metal Color
Laminate (LKT)	<a href="#">See Edge Detail Options</a>	<a href="#">See Laminate Selection</a>	<a href="#">See PVC Edge Color Options</a>	N None CT6 Six Power Center Top CU2 Dual Power Underside CT6U2 Six Power Center Top with Underside (See chart on next page)	<a href="#">See Metal Finish Color Options</a>

Model Number Breakdown

LKT60240-29BTY					
LK	T	60240	29	BT	Y
LOK	Laminate	60" x 240"	Height	Boat Top Shape	Y base

Description

Boat 3pc Table with Y Base  
at Working Height  
(continued)

Veneer Tables  
"LKV" Models

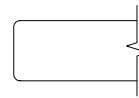

Eased Edge (R3)

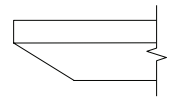

Reverse Bevel Edge (K9)

D	W	H	CTN WT	CU FT	① Model	Eased Edge (R3)		Reverse Bevel Edge (K9)		
						Essentials	Artisan	Essentials	Artisan	
60	240	29	636	281	LKV60240-29BTY	\$18,509	\$19,989	\$20,175	\$21,485	
60	216	29	584	253	LKV60216-29BTY	\$16,198	\$17,494	\$17,654	\$18,803	
VENEER	54	240	29	575	254	LKV54240-29BTY	\$15,440	\$16,755	\$16,203	\$17,449
	54	216	29	523	229	LKV54216-29BTY	\$13,697	\$14,858	\$14,398	\$15,501
	48	240	29	537	228	LKV48240-29BTY	\$14,674	\$15,830	\$15,364	\$16,459
	48	216	29	477	206	LKV48216-29BTY	\$13,444	\$14,466	\$14,080	\$15,048

Electrical Options and Upcharges

	216 - 240 wide
<b>CT6</b>	
Six Power Center Top - Black	CT6BL - add \$4,949
Six Power Center Top - White	CT6WH - add \$4,949
<b>CU2</b>	
Dual Power Underside - Black	CU2-1C - add \$1,298
Dual Power Underside with 4 Wireless Charging - Black	CU2-1CW - add \$3,278
<b>CT6U2</b>	
Six Power Center Top - Black with Dual Underside	CT6U2-BL - add \$5,748
Six Power Center Top - White with Dual Underside	CT6U2-WH - add \$5,748
Six Power Center Top - Black Dual Underside with 4 Wireless Charging	CT6U2-BLW2 - add \$7,668
Six Power Center Top - White Dual Underside with 4 Wireless Charging	CT6U2-WHW2 - add \$7,668

Note: Order power infeed that best fits application

To Order Specify

① Veneer Model #	② Edge Detail	③ Wood Collection	④ Wood Finish	⑤ Electrical	⑥ Metal Color
Veneer (LKV)	<a href="#">See Edge Detail Options</a>	Essentials	<a href="#">See Essentials Wood Finish Options</a>	N None CT6 Six Power Center Top CU2 Dual Power Underside CT6U2 Six Power Center Top with Underside (See chart above)	<a href="#">See Metal Finish Color Options</a>
		Artisan	④ Wood Finish <a href="#">See Artisan Wood Finish Options</a>		

LOK - CONFERENCE

Description

Boat 2pc Table with Y Base at Working Height

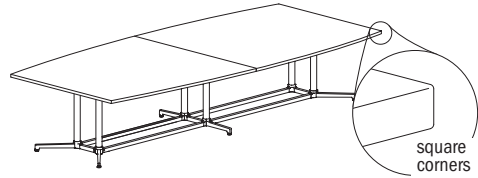

Laminate Tables "LKT" Models

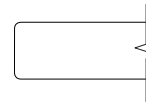

Eased Edge (R3)

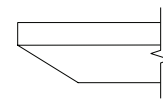

Reverse Bevel Edge (K9)

D	W	H	CTN WT	CU FT	Model	Eased Edge (R3)		Reverse Bevel Edge (K9)		
						Standard Tier 1	Graded In Tier 2	Standard Tier 1	Graded In Tier 2	
60	192	29	511	226	LKT60192-29BTY	\$8,315	\$8,471	\$9,074	\$9,230	
60	168	29	449	198	LKT60168-29BTY	\$7,724	\$7,862	\$8,448	\$8,588	
60	144	29	333	169	LKT60144-29BTY	\$7,037	\$7,155	\$7,723	\$7,841	
60	120	29	334	143	LKT60120-29BTY	\$6,338	\$6,436	\$6,990	\$7,089	
LAMINATE	54	192	29	449	204	LKT54192-29BTY	\$8,024	\$8,165	\$8,753	\$8,893
	54	168	29	359	178	LKT54168-29BTY	\$7,144	\$7,270	\$7,841	\$7,965
	54	144	29	356	154	LKT54144-29BTY	\$6,497	\$6,601	\$7,162	\$7,264
	54	120	29	308	130	LKT54120-29BTY	\$5,953	\$6,040	\$6,584	\$6,673
48	192	29	409	183	LKT48192-29BTY	\$7,802	\$7,931	\$8,498	\$8,623	
48	168	29	363	161	LKT48168-29BTY	\$6,328	\$6,436	\$6,994	\$7,102	
48	144	29	323	139	LKT48144-29BTY	\$5,860	\$5,955	\$6,501	\$6,596	
48	120	29	283	116	LKT48120-29BTY	\$5,296	\$5,376	\$5,908	\$5,986	
48	108	29	262	105	LKT48108-29BTY	\$4,718	\$4,790	\$5,316	\$5,386	

Features:

- price reflects complete table - top and base
- ships KD in multiple cartons
- two piece top
- model includes adjustable glide

Options:

- specify power/charging option, see below for options and upcharges



top shape

LOK - CONFERENCE

To Order Specify

1 Laminate Model #	2 Edge Detail	3 Laminate Selection	3a PVC Edge Color	4 Electrical	5 Metal Color
Laminate (LKT)	<a href="#">See Edge Detail Options</a>	<a href="#">See Laminate Selection</a>	<a href="#">See PVC Edge Color Options</a>	N None CT2 Dual Power Center Top CU2 Dual Power Underside CT2U1 Dual Power Center Top with Underside CT4U2 Four Power Center Top with Underside CT4 Four Power Center Top (See chart on next page)	<a href="#">See Metal Finish Color Options</a>

Model Number Breakdown

LKT60192-29BTY					
LK	T	60192	29	BT	Y
LOK	Laminate	60" x 192"	Height	Boat Top Shape	Y base

Description

Boat 2pc Table with Y Base  
at Working Height  
(continued)

Veneer Tables  
"LKV" Models

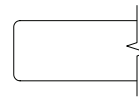

Eased Edge (R3)

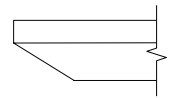

Reverse Bevel Edge (K9)

D	W	H	CTN WT	CU FT	① Model	Eased Edge (R3)		Reverse Bevel Edge (K9)		
						Essentials	Artisan	Essentials	Artisan	
60	192	29	511	226	LKV60192-29BTY	\$12,962	\$13,999	\$14,129	\$15,047	
60	168	29	449	198	LKV60168-29BTY	\$11,877	\$12,825	\$12,946	\$13,787	
60	144	29	333	169	LKV60144-29BTY	\$10,684	\$11,536	\$11,644	\$12,399	
60	120	29	334	143	LKV60120-29BTY	\$9,571	\$10,333	\$10,428	\$11,107	
VENEER	54	192	29	449	204	LKV54192-29BTY	\$12,010	\$12,971	\$13,091	\$13,941
	54	168	29	359	178	LKV54168-29BTY	\$10,816	\$11,682	\$11,789	\$12,555
	54	144	29	356	154	LKV54144-29BTY	\$9,705	\$10,482	\$10,578	\$11,267
	54	120	29	308	130	LKV54120-29BTY	\$8,773	\$9,472	\$9,563	\$10,180
48	192	29	409	183	LKV48192-29BTY	\$11,913	\$12,809	\$12,499	\$13,346	
48	168	29	363	161	LKV48168-29BTY	\$9,643	\$10,415	\$10,177	\$10,902	
48	144	29	323	139	LKV48144-29BTY	\$8,813	\$9,465	\$9,295	\$9,911	
48	120	29	283	116	LKV48120-29BTY	\$7,875	\$8,412	\$8,310	\$8,814	
48	108	29	262	105	LKV48108-29BTY	\$6,767	\$7,308	\$7,375	\$7,855	

Electrical Options and Upcharges

CT2	108 wide	120 - 192 wide
Dual Power Center Top - Black	CT2BL - add \$1,837	n/a
Dual Power Center Top - White	CT2WH - add \$1,837	n/a
CU1		
Single Power Underside - Black	CU1-1C - add \$731	CU1-1C - add \$849
Single Power Underside with Wireless Charging - Black	CU1-1CW - add \$1,691	CU1-1CW - add \$1,776
CT2U1		
Dual Power Center Top - Black with Underside	CT2U1-BL - add \$2,235	n/a
Dual Power Center Top - White with Underside	CT2U1-WH - add \$2,235	n/a
Dual Power Center Top - Black with Wireless Charging	CT2U1-BLW2 - add \$3,194	n/a
Dual Power Center Top - White with Wireless Charging	CT2U1-WHW2 - add \$3,194	n/a

CT4U1	108 wide	120 - 192 wide
Four Power Center Top with Single Underside - Black	n/a	CT4U1-BL - add \$3,906
Four Power Center Top with Single Underside - White	n/a	CT4U1-WH - add \$3,906
Four Power Center Top - Black with Underside & Wireless Charging	n/a	CT4U1-BLW2 - add \$4,840
Four Power Center Top - White with Underside & Wireless Charging	n/a	CT4U1-WHW2 - add \$4,840
CT4		
Four Power Center Top - Black	n/a	CT4BL - add \$3,421
Four Power Center Top - White	n/a	CT4WH - add \$3,421

Note: Order power infeed that best fits application

To Order Specify

① Veneer Model #	② Edge Detail	③ Wood Collection	④ Wood Finish	⑤ Electrical	⑥ Metal Color
Veneer (LKV)	<a href="#">See Edge Detail Options</a>	Essentials	<a href="#">See Essentials Wood Finish Options</a>	N None CT2 Dual Power Center Top CU2 Dual Power Underside CT2U1 Dual Power Center Top with Underside CT4U2 Four Power Center Top with Underside CT4 Four Power Center Top	<a href="#">See Metal Finish Color Options</a>
		Artisan	④ Wood Finish <a href="#">See Artisan Wood Finish Options</a>		

LOK - CONFERENCE

Description

Boat Table with Y Base at Working Height

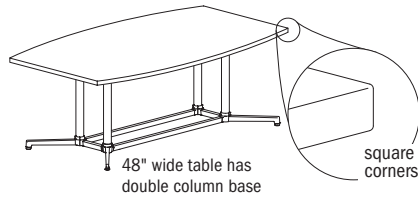

Laminate Tables "LKT" Models



Eased Edge (R3)

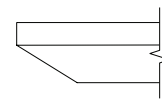

Reverse Bevel Edge (K9)

LAMINATE	D	W	H	CTN WT	CU FT	Model	Standard Tier 1	Graded In Tier 2	Standard Tier 1	Graded In Tier 2
		48	96	29	219	105	LKT4896-29BTY	\$3,898	\$3,960	\$4,479
	48	84	29	327	83	LKT4884-29BTY	\$3,421	\$3,476	\$3,988	\$4,046
	42	96	29	168	83	LKT4296-29BTY	\$3,712	\$3,767	\$4,276	\$4,335
	42	84	29	636	281	LKT4284-29BTY	\$3,109	\$3,157	\$3,664	\$3,715
	36	96	29	636	281	LKT3696-29BTY	\$3,023	\$3,069	\$3,572	\$3,622
	36	84	29	648	281	LKT3684-29BTY	\$2,717	\$2,760	\$3,258	\$3,300

Features:

- price reflects complete table - top and base
- ships KD in multiple cartons
- one piece top
- model includes adjustable glide

Options:

- specify power/charging option, see below for options and upcharges

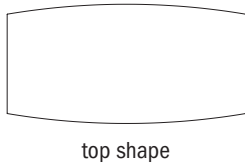
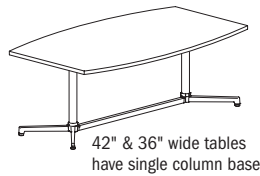

LOK - CONFERENCE

To Order Specify

1 Laminite Model #	2 Edge Detail	3 Laminite Selection	3a PVC Edge Color	4 Electrical	5 Metal Color
Laminite (LKT)	<a href="#">See Edge Detail Options</a>	<a href="#">See Laminite Selection</a>	<a href="#">See PVC Edge Color Options</a>	N None CT2 Dual Power Center Top CU2 Dual Power Underside CT2U1 Dual Power Center Top with Underside (See chart on next page)	<a href="#">See Metal Finish Color Options</a>

Model Number Breakdown

LKT4896-29BTY					
LK	T	4896	29	BT	Y
LOK	Laminite	48" x 96"	Height	Boat Top Shape	Y base

Description

Boat Table with  
Y Base at Working Height  
(continued)

Veneer Tables  
"LKV" Models

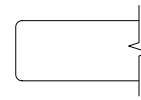

Eased Edge (R3)

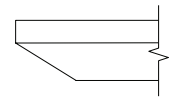

Reverse Bevel Edge (K9)

D	W	H	CTN WT	CU FT	① Model	Eased Edge (R3)		Reverse Bevel Edge (K9)		
						Essentials	Artisan	Essentials	Artisan	
48	96	29	219	105	LKV4896-29BTY	\$5,426	\$5,842	\$5,806	\$6,196	
48	84	29	327	83	LKV4884-29BTY	\$4,895	\$5,254	\$5,250	\$5,585	
VENEER	42	96	29	168	83	LKV4296-29BTY	\$5,500	\$5,939	\$5,994	\$6,385
	42	84	29	636	281	LKV4284-29BTY	\$4,678	\$5,051	\$5,098	\$5,430
	36	96	29	636	281	LKV3696-29BTY	\$4,080	\$4,404	\$4,444	\$4,734
	36	84	29	648	281	LKV3684-29BTY	\$3,758	\$4,058	\$4,094	\$4,359

Electrical Options and Upcharges

CT2	84 - 96 wide
Dual Power Center Top - Black	CT2BL - add \$1,837
Dual Power Center Top - White	CT2WH - add \$1,837
<b>CU1</b>	
Single Power Underside - Black	CU1-1C - add \$731
Single Power Underside with Wireless Charging - Black	CU1-1CW - add \$1,691
<b>CT2U1</b>	
Dual Power Center Top - Black with Single Underside	CT2U1-BL - add \$2,235
Dual Power Center Top - White with Single Underside	CT2U1-WH - add \$2,235
Dual Power Center Top - Black with Wireless Charging	CT2U1-BLW2 - add \$3,194
Dual Power Center Top - White with Wireless Charging	CT2U1-WHW2 - add \$3,194

Note: Order power infed that best fits application

To Order Specify

① Veneer Model #	② Edge Detail	③ Wood Collection	④ Wood Finish	⑤ Electrical	⑥ Metal Color
Veneer (LKV)	<a href="#">See Edge Detail Options</a>	Essentials	<a href="#">See Essentials Wood Finish Options</a>	N None CT2 Dual Power Center Top CU2 Dual Power Underside CT2U1 Dual Power Center Top with Underside (See chart above)	<a href="#">See Metal Finish Color Options</a>
		Artisan	④ Wood Finish <a href="#">See Artisan Wood Finish Options</a>		

LOK - CONFERENCE

Description

Rounded Double Chevron Table with T Base at Working Height

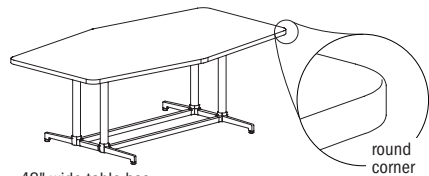

48" wide table has double column base

D	W	H	CTN WT	CU FT	Model
48	96	29	204	105	LKT4896-29DCRT
48	84	29	182	83	LKT4884-29DCRT
42	96	29	161	73	LKT4296-29DCRT
42	84	29	142	72	LKT4284-29DCRT
36	96	29	146	72	LKT3696-29DCRT
36	84	29	134	64	LKT3684-29DCRT

LAMINATE

Laminate Tables "LKT" Models

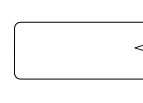

Eased Edge (R3)

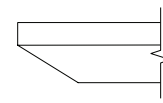

Reverse Bevel Edge (K9)

Standard Tier 1	Graded In Tier 2	Standard Tier 1	Graded In Tier 2
\$3,439	\$3,498	\$4,007	\$4,062
\$3,517	\$3,572	\$4,084	\$4,138
\$2,897	\$2,947	\$3,455	\$3,503
\$2,957	\$3,007	\$3,510	\$3,557
\$2,655	\$2,694	\$3,194	\$3,238

Features:

- price reflects complete table - top and base
- ships KD in multiple cartons
- one piece top
- model includes adjustable glide

Options:

- specify power/charging option, see below for options and upcharges

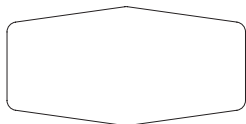
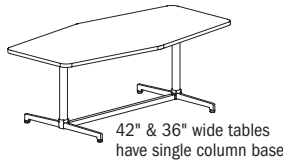

top shape

LOK - CONFERENCE

To Order Specify

1 Laminite Model #	2 Edge Detail	3 Laminite Selection	3a PVC Edge Color	4 Electrical	5 Metal Color
Laminite (LKT)	<a href="#">See Edge Detail Options</a>	<a href="#">See Laminite Selection</a>	<a href="#">See PVC Edge Color Options</a>	N None CT2 Dual Power Center Top CU2 Dual Power Underside CT2U1 Dual Power Center Top with Underside (See chart on next page)	<a href="#">See Metal Finish Color Options</a>

Model Number Breakdown

LKT4896-29DCRT						
LK	T	4896	29	DC	R	T
LOK	Laminite	48" x 96"	Height	Double Chevron Top Shape	Rounded Corner	T base

Description

Rounded Double Chevron Table with T Base at Working Height (continued)

Veneer Tables "LKV" Models      Solid Surface Tables "LKS" Models

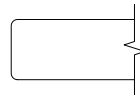

Eased Edge (R3)

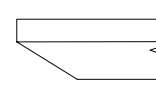

Reverse Bevel Edge (K9)

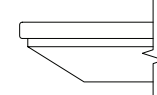

Reverse Bevel Edge (S7)

	D	W	H	CTN WT	CU FT	① Model	Veneer		Solid Surface		
							Essentials	Artisan	Essentials	Artisan	Standard
VENEER	48	96	29	204	105	LKV4896-29DCRT	\$5,395	\$5,810	\$5,776	\$6,168	--
	48	84	29	182	83	LKV4884-29DCRT	\$4,922	\$5,281	\$5,276	\$5,610	--
	42	96	29	161	73	LKV4296-29DCRT	\$5,256	\$5,678	\$5,729	\$6,100	--
	42	84	29	142	72	LKV4284-29DCRT	\$4,419	\$4,771	\$4,817	\$5,131	--
	36	96	29	146	72	LKV3696-29DCRT	\$4,001	\$4,320	\$4,359	\$4,644	--
	36	84	29	134	64	LKV3684-29DCRT	\$3,682	\$3,973	\$4,012	\$4,270	--
SOLID SURFACE	48	96	29	204	105	LKS4896-29DCRT	--	--	--	--	\$12,641
	48	84	29	182	83	LKS4884-29DCRT	--	--	--	--	\$11,205
	42	96	29	161	73	LKS4296-29DCRT	--	--	--	--	\$10,285
	42	84	29	142	72	LKS4284-29DCRT	--	--	--	--	\$9,066
	36	96	29	146	72	LKS3696-29DCRT	--	--	--	--	\$9,038
	36	84	29	134	64	LKS3684-29DCRT	--	--	--	--	\$8,146

Electrical Options and Upcharges

CT2	84 - 96 wide
Dual Power Center Top - Black	CT2BL - add \$1,837
Dual Power Center Top - White	CT2WH - add \$1,837
CU1	
Single Power Underside - Black	CU1-1C - add \$731
Single Power Underside with Wireless Charging - Black	CU1-1CW - add \$1,691
CT2U1	
Dual Power Center Top - Black with Single Underside	CT2U1-BL - add \$2,235
Dual Power Center Top - White with Single Underside	CT2U1-WH - add \$2,235
Dual Power Center Top - Black with Wireless Charging	CT2U1-BLW2 - add \$3,194
Dual Power Center Top - White with Wireless Charging	CT2U1-WHW2 - add \$3,194

LOK - CONFERENCE

Note: Order power infeed that best fits application

To Order Specify

① Veneer Model #	② Edge Detail	③ Wood Collection	④ Wood Finish	⑤ Electrical	⑥ Metal Color
Veneer (LKV)	<a href="#">See Edge Detail Options</a>	Essentials	<a href="#">See Essentials Wood Finish Options</a>	N None CT2 Dual Power Center Top CU2 Dual Power Underside CT2U1 Dual Power Center Top with Underside (See chart above)	<a href="#">See Metal Finish Color Options</a>
		Artisan	④ Wood Finish <a href="#">See Artisan Wood Finish Options</a>		

① Solid Surface Model #	② Top Surface Selection	③ Electrical	④ Metal Color
Solid Surface (LKS)	<a href="#">See Solid Surface Top Surface Selection Options</a>	N None CT2 Dual Power Center Top CU2 Dual Power Underside CT2U1 Dual Power Center Top with Underside (See chart above)	<a href="#">See Metal Finish Color Options</a>

## Description

Rounded Double Chevron Table with Y Base at Working Height

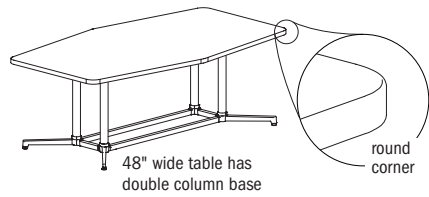

## Laminate Tables "LKT" Models

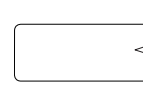

Eased Edge (R3)

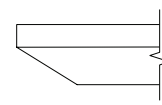

Reverse Bevel Edge (K9)

LAMINATE	D	W	H	CTN WT	CU FT	Model	Standard Tier 1	Graded In Tier 2	Standard Tier 1	Graded In Tier 2
	48	96	29	199	105	LKT4896-29DCRY	\$3,898	\$3,960	\$4,479	\$4,541
	48	84	29	312	83	LKT4884-29DCRY	\$3,421	\$3,476	\$3,988	\$4,046
42	96	29	153	83	LKT4296-29DCRY	\$3,712	\$3,767	\$4,276	\$4,335	
42	84	29	153	72	LKT4284-29DCRY	\$3,109	\$3,157	\$3,664	\$3,715	
36	96	29	150	72	LKT3696-29DCRY	\$3,023	\$3,069	\$3,572	\$3,622	
36	84	29	144	64	LKT3684-29DCRY	\$2,717	\$2,760	\$3,258	\$3,300	

### Features:

- price reflects complete table - top and base
- ships KD in multiple cartons
- one piece top
- model includes adjustable glide

### Options:

- specify power/charging option, see below for options and upcharges

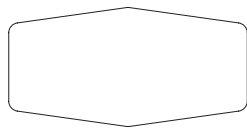
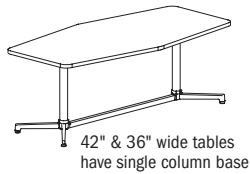

LOK - CONFERENCE

## To Order Specify

1 Laminate Model #	2 Edge Detail	3 Laminate Selection	3a PVC Edge Color	4 Electrical	5 Metal Color
Laminate (LKT)	<a href="#">See Edge Detail Options</a>	<a href="#">See Laminate Selection</a>	<a href="#">See PVC Edge Color Options</a>	N None CT2 Dual Power Center Top CU2 Dual Power Underside CT2U1 Dual Power Center Top with Underside (See chart on next page)	<a href="#">See Metal Finish Color Options</a>

## Model Number Breakdown

LKT4896-29DCRY						
LK	T	4896	29	DC	R	Y
LOK	Laminate	48" x 96"	Height	Double Chevron Top Shape	Rounded Corner	Y base

Description

Rounded Double Chevron Table with Y Base at Working Height (continued)

Veneer Tables "LKV" Models

Solid Surface Tables "LKS" Models

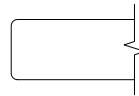

Eased Edge (R3)

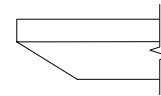

Reverse Bevel Edge (K9)

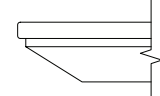

Reverse Bevel Edge (S7)

	D	W	H	CTN WT	CU FT	① Model	Veneer Tables		Solid Surface Tables		
							Essentials	Artisan	Essentials	Artisan	Standard
VENEER	48	96	29	199	105	LKV4896-29DCRY	\$5,426	\$5,842	\$5,806	\$6,196	--
	48	84	29	312	83	LKV4884-29DCRY	\$4,895	\$5,254	\$5,250	\$5,585	--
	42	96	29	153	83	LKV4296-29DCRY	\$5,500	\$5,939	\$5,994	\$6,385	--
	42	84	29	153	72	LKV4284-29DCRY	\$4,678	\$5,051	\$5,098	\$5,430	--
	36	96	29	150	72	LKV3696-29DCRY	\$4,080	\$4,404	\$4,444	\$4,734	--
	36	84	29	144	64	LKV3684-29DCRY	\$3,758	\$4,058	\$4,094	\$4,359	--
SOLID SURFACE	48	96	29	199	105	LKS4896-29DCRY	--	--	--	--	\$12,669
	48	84	29	312	83	LKS4884-29DCRY	--	--	--	--	\$11,183
	42	96	29	153	83	LKS4296-29DCRY	--	--	--	--	\$10,528
	42	84	29	153	72	LKS4284-29DCRY	--	--	--	--	\$9,321
	36	96	29	150	72	LKS3696-29DCRY	--	--	--	--	\$9,114
	36	84	29	144	64	LKS3684-29DCRY	--	--	--	--	\$8,223

Electrical Options and Upcharges

CT2	84 - 96 wide
Dual Power Center Top - Black	CT2BL - add \$1,837
Dual Power Center Top - White	CT2WH - add \$1,837
CU1	
Single Power Underside - Black	CU1-1C - add \$731
Single Power Underside with Wireless Charging - Black	CU1-1CW - add \$1,691
CT2U1	
Dual Power Center Top - Black with Single Underside	CT2U1-BL - add \$2,235
Dual Power Center Top - White with Single Underside	CT2U1-WH - add \$2,235
Dual Power Center Top - Black with Wireless Charging	CT2U1-BLW2 - add \$3,194
Dual Power Center Top - White with Wireless Charging	CT2U1-WHW2 - add \$3,194

LOK - CONFERENCE

Note: Order power infeed that best fits application

To Order Specify

① Veneer Model #	② Edge Detail	③ Wood Collection	④ Wood Finish	⑤ Electrical	⑥ Metal Color
Veneer (LKV)	<a href="#">See Edge Detail Options</a>	Essentials	<a href="#">See Essentials Wood Finish Options</a>	N None CT2 Dual Power Center Top CU2 Dual Power Underside CT2U1 Dual Power Center Top with Underside (See chart above)	<a href="#">See Metal Finish Color Options</a>
		Artisan	④ Wood Finish <a href="#">See Artisan Wood Finish Options</a>		

① Solid Surface Model #	② Top Surface Selection	③ Electrical	④ Metal Color
Solid Surface (LKS)	<a href="#">See Solid Surface Top Surface Selection Options</a>	N None CT2 Dual Power Center Top CU2 Dual Power Underside CT2U1 Dual Power Center Top with Underside (See chart above)	<a href="#">See Metal Finish Color Options</a>

## Description

Taper 2pc Table with T Base at Working Height

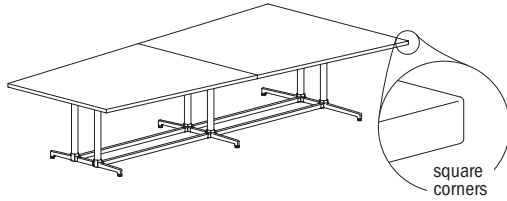

## Laminate Tables "LKT" Models

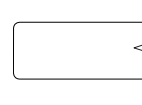

Eased Edge (R3)

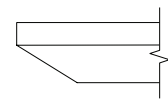

Reverse Bevel Edge (K9)

LAMI	D	W	H	CTN WT	CU FT	Model	Standard Tier 1	Graded In Tier 2	Standard Tier 1	Graded In Tier 2
		60	120	29	312	143	LKT60120-29TPT	\$6,478	\$6,581	\$7,130

### Features:

- price reflects complete table - top and base
- ships KD in multiple cartons
- two piece top
- model includes adjustable glide

### Options:

- specify power/charging option, see below for options and upcharges

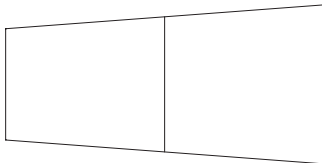

top shape

LOK - CONFERENCE

## To Order Specify

1 Laminate Model #	2 Edge Detail	3 Laminate Selection	3a PVC Edge Color	4 Electrical	5 Metal Color
Laminate (LKT)	<a href="#">See Edge Detail Options</a>	<a href="#">See Laminate Selection</a>	<a href="#">See PVC Edge Color Options</a>	N None CT4 Four Power on Top CU1 Single Power Underside CT4U1 Four Power Center Top with Underside (See chart on next page)	<a href="#">See Metal Finish Color Options</a>

## Model Number Breakdown

LKT60120-29TPT					
LK	T	60120	29	TP	T
LOK	Laminate	60" x 120"	Height	Taper Top Shape	T base

Description

Taper 2pc Table with T Base  
at Working Height  
(continued)

Veneer Tables  
"LKV" Models

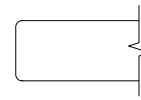

Eased Edge (R3)

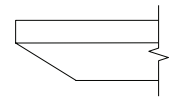

Reverse Bevel Edge (K9)

VEN.	D	W	H	CTN WT	CU FT	① Model	Eased Edge (R3)		Reverse Bevel Edge (K9)	
							Essentials	Artisan	Essentials	Artisan
	60	120	29	312	143	LKV60120-29TPT	\$9,761	\$10,541	\$10,639	\$11,330

Electrical Options and Upcharges

	120 - 192 wide
<b>CT4</b>	
Four Power Center Top - Black	CT4BL - add \$3,421
Four Power Center Top - White	CT4WH - add \$3,421
<b>CU1</b>	
Single Power Underside - Black	CU1-1C - add \$849
Single Power Underside with Wireless Charging - Black	CU1-1CW - add \$1,776
<b>CT4U1</b>	
Four Power Center Top with Underside - Black	CT4U1-BL - add \$3,906
Four Power Center Top with Underside - White	CT4U1-WH - add \$3,906
Four Power Center Top - Black with Underside & 2 Wireless Charging	CT4U1-BLW2 - add \$4,840
Four Power Center Top - White with Underside & 2 Wireless Charging	CT4U1-WhW2 - add \$4,840

Note: Order power infed that best fits application

To Order Specify

① Veneer Model #	② Edge Detail	③ Wood Collection	④ Wood Finish	⑤ Electrical	⑥ Metal Color
Veneer (LKV)	<a href="#">See Edge Detail Options</a>	Essentials	<a href="#">See Essentials Wood Finish Options</a>	N None CT4 Four Power on Top CU1 Single Power Underside CT4U1 Four Power Center Top with Underside (See chart above)	<a href="#">See Metal Finish Color Options</a>
		Artisan	④ Wood Finish <a href="#">See Artisan Wood Finish Options</a>		

LOK - CONFERENCE

Description

Taper Table with T Base at Working Height

Laminate Tables "LKT" Models

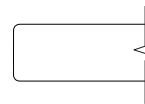
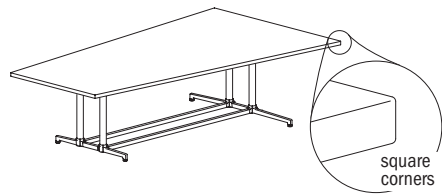

Eased Edge (R3)

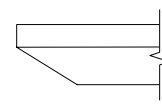

Reverse Bevel Edge (K9)

LAMI	D	W	H	CTN WT	CU FT	Model	Standard Tier 1	Graded In Tier 2	Standard Tier 1	Graded In Tier 2
		54	96	29	216	105	LKT5496-29TPT	\$4,404	\$4,475	\$5,001

Features:

- price reflects complete table - top and base
- ships KD in multiple cartons
- one piece top
- model includes adjustable glide

Options:

- specify power/charging option, see below for options and upcharges

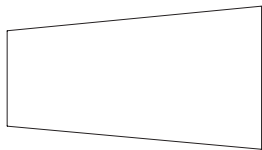

top shape

LOK - CONFERENCE

To Order Specify

1 Laminate Model #	2 Edge Detail	3 Laminate Selection	3a PVC Edge Color	4 Electrical	5 Metal Color
Laminate (LKT)	<a href="#">See Edge Detail Options</a>	<a href="#">See Laminate Selection</a>	<a href="#">See PVC Edge Color Options</a>	N None CT2 Dual Power Center Top CU2 Dual Power Underside CT2U1 Dual Power Center Top with Underside (See chart on next page)	<a href="#">See Metal Finish Color Options</a>

Model Number Breakdown

LKT5496-29TPT					
LK	T	5496	29	TP	T
LOK	Laminate	54" x 96"	Height	Taper Top Shape	T base

Description

Taper Table with T Base  
at Working Height  
(continued)

Veneer Tables  
"LKV" Models

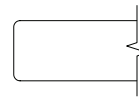

Eased Edge (R3)

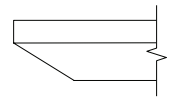

Reverse Bevel Edge (K9)

VEN.	D	W	H	CTN WT	CU FT	① Model	Essentials		Artisan	
							Essentials	Artisan	Essentials	Artisan
	54	96	29	216	105	LKV5496-29TPT	\$6,021	\$6,504	\$6,561	\$6,990

Electrical Options and Upcharges

CT2	84 - 96 wide
Dual Power Center Top - Black	CT2BL - add \$1,837
Dual Power Center Top - White	CT2WH - add \$1,837
CU1	
Single Power Underside - Black	CU1-1C - add \$731
Single Power Underside with Wireless Charging - Black	CU1-1CW - add \$1,691
CT2U1	
Dual Power Center Top - Black with Single Underside	CT2U1-BL - add \$2,235
Dual Power Center Top - White with Single Underside	CT2U1-WH - add \$2,235
Dual Power Center Top - Black with Wireless Charging	CT2U1-BLW2 - add \$3,194
Dual Power Center Top - White with Wireless Charging	CT2U1-WHW2 - add \$3,194

Note: Order power infed that best fits application

To Order Specify

① Veneer Model #	② Edge Detail	③ Wood Collection	④ Wood Finish	⑤ Electrical	⑥ Metal Color
Veneer (LKV)	<a href="#">See Edge Detail Options</a>	Essentials	<a href="#">See Essentials Wood Finish Options</a>	N None CT2 Dual Power Center Top CU2 Dual Power Underside CT2U1 Dual Power Center Top with Underside (See chart above)	<a href="#">See Metal Finish Color Options</a>
		Artisan	④ Wood Finish <a href="#">See Artisan Wood Finish Options</a>		

Description

Rounded Taper 2pc Table with T Base at Working Height

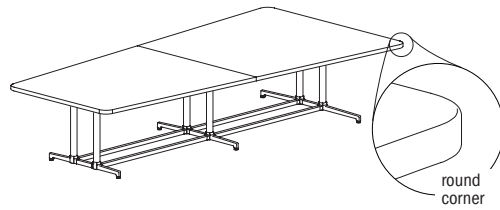

Laminate Tables  
"LKT" Models

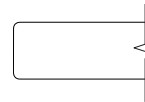

Eased Edge (R3)

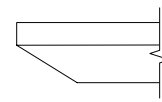

Reverse Bevel Edge (K9)

LAMI	D	W	H	CTN WT	CU FT	1 Model	Standard	Graded In	Standard	Graded In
	60	120	29	312	143	LKT60120-29TPRT	Tier 1	Tier 2	Tier 1	Tier 2
							\$6,478	\$6,581	\$7,130	\$7,227

Features:

- price reflects complete table - top and base
- ships KD in multiple cartons
- two piece top
- model includes adjustable glide

Options:

- specify power/charging option, see below for options and upcharges

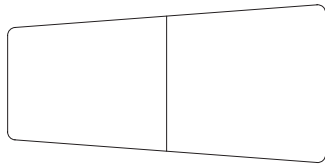

top shape

LOK - CONFERENCE

To Order Specify

1 Laminate Model #	2 Edge Detail	3 Laminate Selection	3a PVC Edge Color	4 Electrical	5 Metal Color
Laminate (LKT)	<a href="#">See Edge Detail Options</a>	<a href="#">See Laminate Selection</a>	<a href="#">See PVC Edge Color Options</a>	N None CT4 Four Power on Top CU1 Single Power Underside CT4U1 Four Power Center Top with Underside (See chart on next page)	<a href="#">See Metal Finish Color Options</a>

Model Number Breakdown

LKT60120-29TPRT						
LK	T	60120	29	TP	R	T
LOK	Laminate	60" x 120"	Height	Taper Top Shape	Rounded Corner	T base

Description

Rounded Taper 2pc Table with T Base at Working Height (continued)

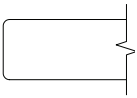
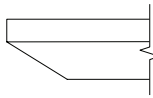
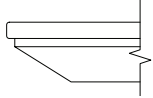
		Veneer Tables "LKV" Models				Solid Surface Tables "LKS" Models					
		 <p>Eased Edge (R3)</p>		 <p>Reverse Bevel Edge (K9)</p>		 <p>Reverse Bevel Edge (S7)</p>					
		Essentials	Artisan	Essentials	Artisan	Standard					
VEN.	D	W	H	CTN WT	CU FT	Model	Essentials	Artisan	Essentials	Artisan	Standard
	60	120	29	312	143	LKV60120-29TPRT	\$9,761	\$10,541	\$10,639	\$11,330	--
S.S.	60	120	29	312	143	LKS60120-29TPRT	--	--	--	--	\$26,991

Electrical Options and Upcharges

	120 - 192 wide
<b>CT4</b>	
Four Power Center Top - Black	CT4BL - add \$3,421
Four Power Center Top - White	CT4WH - add \$3,421
<b>CU1</b>	
Single Power Underside - Black	CU1-1C - add \$849
Single Power Underside with Wireless Charging - Black	CU1-1CW - add \$1,776
<b>CT4U1</b>	
Four Power Center Top with Underside - Black	CT4U1-BL - add \$3,906
Four Power Center Top with Underside - White	CT4U1-WH - add \$3,906
Four Power Center Top - Black with Underside & 2 Wireless Charging	CT4U1-BLW2 - add \$4,840
Four Power Center Top - White with Underside & 2 Wireless Charging	CT4U1-WHW2 - add \$4,840

LOK - CONFERENCE

Note: Order power infeed that best fits application

To Order Specify

1 Veneer Model #	2 Edge Detail	3 Wood Collection	4 Wood Finish	5 Electrical	6 Metal Color
Veneer (LKV)	<a href="#">See Edge Detail Options</a>	Essentials	<a href="#">See Essentials Wood Finish Options</a>	N None CT4 Four Power on Top CU1 Single Power Underside CT4U1 Four Power Center Top with Underside (See chart above)	<a href="#">See Metal Finish Color Options</a>
		Artisan	<b>4 Wood Finish</b> <a href="#">See Artisan Wood Finish Options</a>		
1 Solid Surface Model #	2 Top Surface Selection	3 Electrical	4 Metal Color		
Solid Surface (LKS)	<a href="#">See Solid Surface Top Surface Selection Options</a>	N None CT4 Four Power on Top CU1 Single Power Underside CT4U1 Four Power Center Top with Underside (See chart above)	<a href="#">See Metal Finish Color Options</a>		

Description

Rounded Taper Table with T Base at Working Height

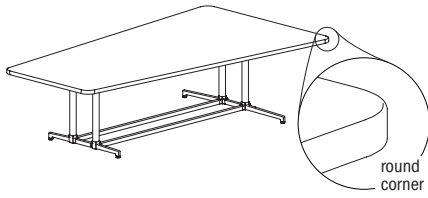

Laminate Tables "LKT" Models

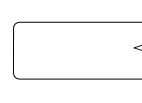

Eased Edge (R3)

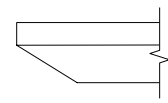

Reverse Bevel Edge (K9)

LAMI	D	W	H	CTN WT	CU FT	Model	Standard Tier 1	Graded In Tier 2	Standard Tier 1	Graded In Tier 2
		54	96	29	216	105	LKT5496-29TPRT	\$4,404	\$4,475	\$5,001

Features:

- price reflects complete table - top and base
- ships KD in multiple cartons
- one piece top
- model includes adjustable glide

Options:

- specify power/charging option, see below for options and upcharges

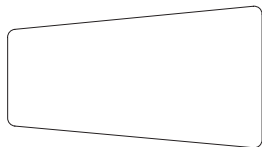

top shape

LOK - CONFERENCE

To Order Specify

1 Laminate Model #	2 Edge Detail	3 Laminate Selection	3a PVC Edge Color	4 Electrical	5 Metal Color
Laminate (LKT)	<a href="#">See Edge Detail Options</a>	<a href="#">See Laminate Selection</a>	<a href="#">See PVC Edge Color Options</a>	N None CT2 Dual Power Center Top CU2 Dual Power Underside CT2U1 Dual Power Center Top with Underside (See chart on next page)	<a href="#">See Metal Finish Color Options</a>

Model Number Breakdown

LKT5496-29TPRT						
LK	T	5496	29	TP	R	T
LOK	Laminate	54" x 96"	Height	Taper Top Shape	Rounded Corner	T base

Description

Rounded Taper Table with T Base at Working Height (continued)

Veneer Tables "LKV" Models	Solid Surface Tables "LKS" Models
----------------------------	-----------------------------------

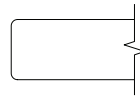

Eased Edge (R3)

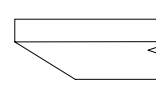

Reverse Bevel Edge (K9)

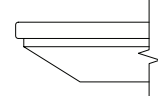

Reverse Bevel Edge (S7)

	D	W	H	CTN WT	CU FT	① Model	Veneer Tables "LKV" Models		Solid Surface Tables "LKS" Models		
							Essentials	Artisan	Essentials	Artisan	Standard
VEN.	54	96	29	216	105	LKV5496-29TPRT	\$6,021	\$6,504	\$6,561	\$6,990	--
S.S.	54	96	29	216	105	LKS5496-29TPRT	--	--	--	--	\$16,845

Electrical Options and Upcharges

<b>CT2</b>	84 - 96 wide
Dual Power Center Top - Black	CT2BL - add \$1,837
Dual Power Center Top - White	CT2WH - add \$1,837
<b>CU1</b>	
Single Power Underside - Black	CU1-1C - add \$731
Single Power Underside with Wireless Charging - Black	CU1-1CW - add \$1,691
<b>CT2U1</b>	
Dual Power Center Top - Black with Single Underside	CT2U1-BL - add \$2,235
Dual Power Center Top - White with Single Underside	CT2U1-WH - add \$2,235
Dual Power Center Top - Black with Wireless Charging	CT2U1-BLW2 - add \$3,194
Dual Power Center Top - White with Wireless Charging	CT2U1-WHW2 - add \$3,194

LOK - CONFERENCE

Note: Order power infeed that best fits application, see page 408.

To Order Specify

① Veneer Model #	② Edge Detail	③ Wood Collection	④ Wood Finish	⑤ Electrical	⑥ Metal Color
Veneer (LKV)	<a href="#">See Edge Detail Options</a>	Essentials	<a href="#">See Essentials Wood Finish Options</a>	N None CT2 Dual Power Center Top CU2 Dual Power Underside CT2U1 Dual Power Center Top with Underside (See chart above)	<a href="#">See Metal Finish Color Options</a>
		Artisan	④ Wood Finish <a href="#">See Artisan Wood Finish Options</a>		

① Solid Surface Model #	② Top Surface Selection	③ Electrical	④ Metal Color
Solid Surface (LKS)	<a href="#">See Solid Surface Top Surface Selection Options</a>	N None CT2 Dual Power Center Top CU2 Dual Power Underside (See chart above) CT2U1 Dual Power Center Top with Underside	<a href="#">See Metal Finish Color Options</a>

## Description

Taper 2pc Table with Y Base at Working Height

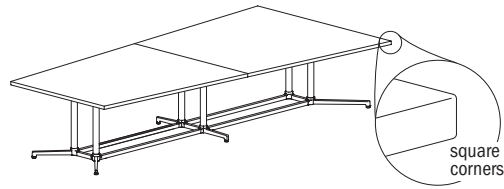

## Laminate Tables "LKT" Models

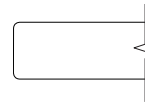

Eased Edge (R3)

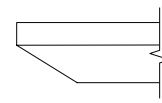

Reverse Bevel Edge (K9)

LAMI	D	W	H	CTN WT	CU FT	Model	Standard Tier 1	Graded In Tier 2	Standard Tier 1	Graded In Tier 2
		60	120	29	301	143	LKT60120-29TPY	\$6,292	\$6,388	\$6,940

### Features:

- price reflects complete table - top and base
- ships KD in multiple cartons
- two piece top
- model includes adjustable glide

### Options:

- specify power/charging option, see below for options and upcharges

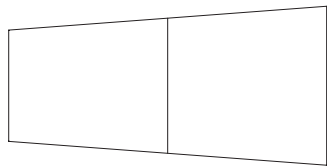

top shape

LOK - CONFERENCE

## To Order Specify

1 Laminate Model #	2 Edge Detail	3 Laminate Selection	3a PVC Edge Color	4 Electrical	5 Metal Color
Laminate (LKT)	<a href="#">See Edge Detail Options</a>	<a href="#">See Laminate Selection</a>	<a href="#">See PVC Edge Color Options</a>	N None CT4 Four Power on Top CU1 Single Power Underside CT4U1 Four Power Center Top with Underside (See chart on next page)	<a href="#">See Metal Finish Color Options</a>

## Model Number Breakdown

LKT60120-29TPY					
LK	T	60120	29	TP	Y
LOK	Laminate	60" x 120"	Height	Taper Top Shape	Y base

Description

Taper 2pc Table with Y Base  
at Working Height  
(continued)

Veneer Tables  
"LKV" Models

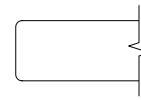

Eased Edge (R3)

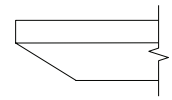

Reverse Bevel Edge (K9)

VEN.	D	W	H	CTN WT	CU FT	① Model	Eased Edge (R3)		Reverse Bevel Edge (K9)	
							Essentials	Artisan	Essentials	Artisan
	60	120	29	301	143	LKV60120-29TPY	\$4,655	\$5,026	\$5,071	\$5,400

Electrical Options and Upcharges

	120 - 192 wide
<b>CT4</b>	
Four Power Center Top - Black	CT4BL - add \$3,421
Four Power Center Top - White	CT4WH - add \$3,421
<b>CU1</b>	
Single Power Underside - Black	CU1-1C - add \$849
Single Power Underside with Wireless Charging - Black	CU1-1CW - add \$1,776
<b>CT4U1</b>	
Four Power Center Top with Underside - Black	CT4U1-BL - add \$3,906
Four Power Center Top with Underside - White	CT4U1-WH - add \$3,906
Four Power Center Top - Black with Underside & 2 Wireless Charging	CT4U1-BLW2 - add \$4,840
Four Power Center Top - White with Underside & 2 Wireless Charging	CT4U1-WHW2 - add \$4,840

Note: Order power infed that best fits application

To Order Specify

① Veneer Model #	② Edge Detail	③ Wood Collection	④ Wood Finish	⑤ Electrical	⑥ Metal Color
Veneer (LKV)	<a href="#">See Edge Detail Options</a>	Essentials	<a href="#">See Essentials Wood Finish Options</a>	N None CT4 Four Power on Top CU1 Single Power Underside CT4U1 Four Power Center Top with Underside (See chart above)	<a href="#">See Metal Finish Color Options</a>
		Artisan	④ Wood Finish <a href="#">See Artisan Wood Finish Options</a>		

LOK - CONFERENCE

Description

Taper Table with Y Base at Working Height

Laminate Tables  
"LKT" Models

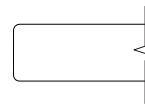
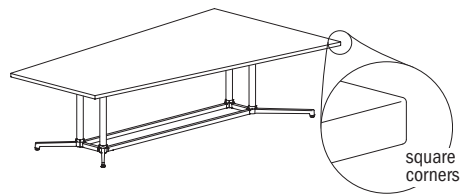

Eased Edge (R3)

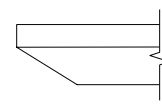

Reverse Bevel Edge (K9)

LAMI	D	W	H	CTN WT	CU FT	Model	Eased Edge (R3)		Reverse Bevel Edge (K9)	
							Standard Tier 1	Graded In Tier 2	Standard Tier 1	Graded In Tier 2
	54	96	29	198	105	LKT5496-29TPY	\$2,043	\$2,111	\$2,640	\$2,711

Features:

- price reflects complete table - top and base
- ships KD in multiple cartons
- one piece top
- model includes adjustable glide

Options:

- specify power/charging option, see below for options and upcharges

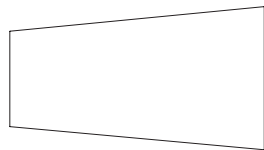

top shape

LOK - CONFERENCE

To Order Specify

1 Laminates Model #	2 Edge Detail	3 Laminates Selection	3a PVC Edge Color	4 Electrical	5 Metal Color
Laminates (LKT)	<a href="#">See Edge Detail Options</a>	<a href="#">See Laminates Selection</a>	<a href="#">See PVC Edge Color Options</a>	N None CT2 Dual Power Center Top CU2 Dual Power Underside CT2U1 Dual Power Center Top with Underside (See chart on next page)	<a href="#">See Metal Finish Color Options</a>

Model Number Breakdown

LKT5496-29TPY					
LK	T	5496	29	TP	Y
LOK	Laminates	54" x 96"	Height	Taper Top Shape	Y base

Description

Taper Table with Y Base  
at Working Height  
(continued)

Veneer Tables  
"LKV" Models

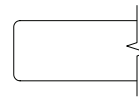

Eased Edge (R3)

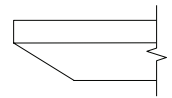

Reverse Bevel Edge (K9)

VEN.	D	W	H	CTN WT	CU FT	① Model	Eased Edge (R3)		Reverse Bevel Edge (K9)	
							Essentials	Artisan	Essentials	Artisan
54	96	29	198	105	LKV5496-29TPY	\$6,137	\$6,627	\$6,688	\$7,122	

Electrical Options and Upcharges

CT2	84 - 96 wide
Dual Power Center Top - Black	CT2BL - add \$1,837
Dual Power Center Top - White	CT2WH - add \$1,837
CU1	
Single Power Underside - Black	CU1-1C - add \$731
Single Power Underside with Wireless Charging - Black	CU1-1CW - add \$1,691
CT2U1	
Dual Power Center Top - Black with Single Underside	CT2U1-BL - add \$2,235
Dual Power Center Top - White with Single Underside	CT2U1-WH - add \$2,235
Dual Power Center Top - Black with Wireless Charging	CT2U1-BLW2 - add \$3,194
Dual Power Center Top - White with Wireless Charging	CT2U1-WHW2 - add \$3,194

Note: Order power infeed that best fits application

To Order Specify

① Veneer Model #	② Edge Detail	③ Wood Collection	④ Wood Finish	⑤ Electrical	⑥ Metal Color
Veneer (LKV)	<a href="#">See Edge Detail Options</a>	Essentials	<a href="#">See Essentials Wood Finish Options</a>	N None CT2 Dual Power Center Top CU2 Dual Power Underside CT2U1 Dual Power Center Top with Underside (See chart above)	<a href="#">See Metal Finish Color Options</a>
		Artisan	④ Wood Finish <a href="#">See Artisan Wood Finish Options</a>		

LOK - CONFERENCE

Description

Rounded Taper 2pc Table with Y Base at Working Height

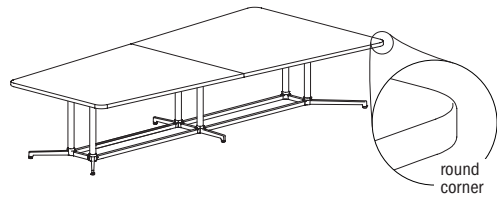

Laminate Tables  
"LKT" Models

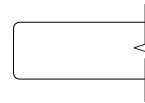

Eased Edge (R3)

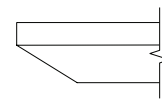

Reverse Bevel Edge (K9)

LAMI	D	W	H	CTN WT	CU FT	Model	Standard Tier 1	Graded In Tier 2	Standard Tier 1	Graded In Tier 2
		60	120	29	301	143	LKT60120-29TPRY	\$6,292	\$6,388	\$6,940

Features:

- price reflects complete table - top and base
- ships KD in multiple cartons
- two piece top
- model includes adjustable glide

Options:

- specify power/charging option, see below for options and upcharges

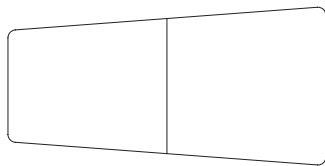

top shape

LOK - CONFERENCE

To Order Specify

1 Laminate Model #	2 Edge Detail	3 Laminate Selection	3a PVC Edge Color	4 Electrical	5 Metal Color
Laminate (LKT)	<a href="#">See Edge Detail Options</a>	<a href="#">See Laminate Selection</a>	<a href="#">See PVC Edge Color Options</a>	N None CT4 Four Power on Top CU1 Single Power Underside CT4U1 Four Power Center Top with Underside (See chart on next page)	<a href="#">See Metal Finish Color Options</a>

Model Number Breakdown

LKT60120-29TPRY						
LK	T	60120	29	TP	R	Y
LOK	Laminate	60" x 120"	Height	Taper Top Shape	Rounded Corner	Y base

Description

Rounded Taper 2pc Table with Y Base at Working Height (continued)

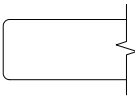
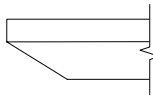
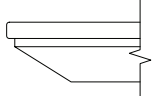
		Veneer Tables "LKV" Models				Solid Surface Tables "LKS" Models					
		 <p>Eased Edge (R3)</p>		 <p>Reverse Bevel Edge (K9)</p>		 <p>Reverse Bevel Edge (S7)</p>					
	D	W	H	CTN WT	CU FT	Model	Essentials	Artisan	Essentials	Artisan	Standard
VEN.	60	120	29	301	143	LKV60120-29TPRY	\$9,503	\$10,261	\$10,359	\$11,028	--
S.S.	60	120	29	301	143	LKS60120-29TPRY	--	--	--	--	\$26,731

Electrical Options and Upcharges

120 - 192 wide	
<b>CT4</b>	
Four Power Center Top - Black	CT4BL - add \$3,421
Four Power Center Top - White	CT4WH - add \$3,421
<b>CU1</b>	
Single Power Underside - Black	CU1-1C - add \$849
Single Power Underside with Wireless Charging - Black	CU1-1CW - add \$1,776
<b>CT4U1</b>	
Four Power Center Top with Underside - Black	CT4U1-BL - add \$3,906
Four Power Center Top with Underside - White	CT4U1-WH - add \$3,906
Four Power Center Top - Black with Underside & 2 Wireless Charging	CT4U1-BLW2 - add \$4,840
Four Power Center Top - White with Underside & 2 Wireless Charging	CT4U1-WHW2 - add \$4,840

LOK - CONFERENCE

Note: Order power infeed that best fits application

To Order Specify

1 Veneer Model #	2 Edge Detail	3 Wood Collection	4 Wood Finish	5 Electrical	6 Metal Color
Veneer (LKV)	<a href="#">See Edge Detail Options</a>	Essentials	<a href="#">See Essentials Wood Finish Options</a>	N None CT4 Four Power on Top CU1 Single Power Underside CT4U1 Four Power Center Top with Underside (See chart above)	<a href="#">See Metal Finish Color Options</a>
		Artisan	<b>4 Wood Finish</b> <a href="#">See Artisan Wood Finish Options</a>		
1 Solid Surface Model #	2 Top Surface Selection	3 Electrical		4 Metal Color	
Solid Surface (LKS)	<a href="#">See Solid Surface Top Surface Selection Options</a>	N None CT4 Four Power on Top CU1 Single Power Underside CT4U1 Four Power Center Top with Underside (See chart above)		<a href="#">See Metal Finish Color Options</a>	

Description

Rounded Taper Table with Y Base at Working Height

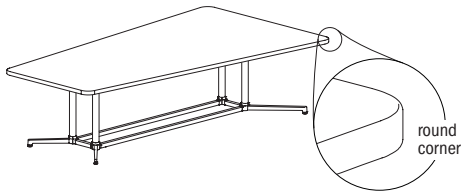

Laminate Tables "LKT" Models

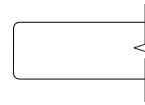

Eased Edge (R3)

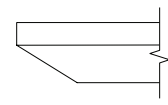

Reverse Bevel Edge (K9)

LAMI	D	W	H	CTN WT	CU FT	Model	Standard Tier 1	Graded In Tier 2	Standard Tier 1	Graded In Tier 2
		54	96	29	198	105	LKT5496-29TPRY	\$4,497	\$4,568	\$5,095

Features:

- price reflects complete table - top and base
- ships KD in multiple cartons
- one piece top
- model includes adjustable glide

Options:

- specify power/charging option, see below for options and upcharges

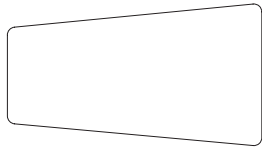

top shape

LOK - CONFERENCE

To Order Specify

1 Laminate Model #	2 Edge Detail	3 Laminate Selection	3a PVC Edge Color	4 Electrical	5 Metal Color
Laminate (LKT)	<a href="#">See Edge Detail Options</a>	<a href="#">See Laminate Selection</a>	<a href="#">See PVC Edge Color Options</a>	N None CT2 Dual Power Center Top CU2 Dual Power Underside CT2U1 Dual Power Center Top with Underside (See chart on next page)	<a href="#">See Metal Finish Color Options</a>

Model Number Breakdown

LKT5496-29TPRY						
LK	T	5496	29	TP	R	Y
LOK	Laminate	54" x 96"	Height	Taper Top Shape	Rounded Corner	Y base

Description

Rounded Taper Table with Y Base at Working Height (continued)

		Veneer Tables "LKV" Models				Solid Surface Tables "LKS" Models	
		Eased Edge (R3)		Reverse Bevel Edge (K9)		Reverse Bevel Edge (S7)	
		Essentials	Artisan	Essentials	Artisan	Standard	
VEN.	D W H CTN WT CU FT	Model	Essentials	Artisan	Essentials	Artisan	Standard
	54 96 29 198 105	LKV5496-29TPRY	\$6,137	\$6,627	\$6,688	\$7,122	--
S.S.	54 96 29 198 105	LKS5496-29TPRY	--	--	--	--	\$16,957

Electrical Options and Upcharges

CT2	84 - 96 wide
Dual Power Center Top - Black	CT2BL - add \$1,837
Dual Power Center Top - White	CT2WH - add \$1,837
CU1	
Single Power Underside - Black	CU1-1C - add \$731
Single Power Underside with Wireless Charging - Black	CU1-1CW - add \$1,691
CT2U1	
Dual Power Center Top - Black with Single Underside	CT2U1-BL - add \$2,235
Dual Power Center Top - White with Single Underside	CT2U1-WH - add \$2,235
Dual Power Center Top- Black with Wireless Charging	CT2U1-BLW2 - add \$3,194
Dual Power Center Top- White with Wireless Charging	CT2U1-WHW2 - add \$3,194

LOK- CONFERENCE

Note: Order power infeed that best fits application

To Order Specify

1 Veneer Model #	2 Edge Detail	3 Wood Collection	4 Wood Finish	5 Electrical	6 Metal Color
Veneer (LKV)	<a href="#">See Edge Detail Options</a>	Essentials	<a href="#">See Essentials Wood Finish Options</a>	N None CT2 Dual Power Center Top CU2 Dual Power Underside CT2U1 Dual Power Center Top with Underside (See chart above)	<a href="#">See Metal Finish Color Options</a>
		Artisan	4 Wood Finish <a href="#">See Artisan Wood Finish Options</a>		
1 Solid Surface Model #	2 Top Surface Selection	3 Electrical	4 Metal Color		
Solid Surface (LKS)	<a href="#">See Solid Surface Top Surface Selection Options</a>	N None CT2 Dual Power Center Top CU2 Dual Power Underside (See chart above) CT2U1 Dual Power Center Top with Underside	<a href="#">See Metal Finish Color Options</a>		

Description

Round Table with X Base  
at Working Height



Laminate Tables  
"LKT" Models

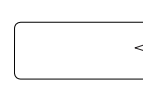

Eased Edge (R3)

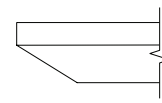

Reverse Bevel Edge (K9)

LAMINATE	D	W	H	CTN WT	CU FT	1 Model	Standard Tier 1	Graded In Tier 2	Standard Tier 1	Graded In Tier 2
	48	48	29	86	49	LKT48-29RDX	\$1,937	\$2,085	\$2,497	\$2,645
	42	42	29	72	38	LKT42-29RDX	\$1,769	\$1,914	\$2,330	\$2,474
36	36	29	58	29	LKT36-29RDX	\$1,712	\$1,763	\$2,272	\$2,323	
30	30	29	58	21	LKT30-29RDX	\$1,650	\$1,692	\$2,194	\$2,253	

Features:

- price reflects complete table - top and base
- ships KD in multiple cartons
- one piece top
- model includes adjustable glide
- when electrical option is selected, power accessible base is shipped; see page 178 for details
- power/charging units have 72" cord
- power cord is routed inside base column

Options:

- specify power access base with power unit option; None (N), add \$735 for EC23 (CTEC23), add \$616 for EC24 (CTEC24)

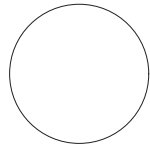

top shape

LOK - CONFERENCE

To Order Specify

1 Laminate Model #	2 Edge Detail	3 Laminate Selection	3a PVC Edge Color	4 Electrical	5 Metal Color
Laminate (LKT)	<a href="#">See Edge Detail Options</a>	<a href="#">See Laminate Selection</a>	<a href="#">See PVC Edge Color Options</a>	N None CTEC23 Power Center Top CTEC24 Power Center Top (See chart on next page)	<a href="#">See Metal Finish Color Options</a>

Model Number Breakdown

LKT48-29RDX					
LK	T	48	29	RD	X
LOK	Laminate	48" dia.	Height	Round Top Shape	X base

Description

Round Table with X Base  
at Working Height  
(continued)

Veneer Tables  
"LKV" Models

Solid Surface Tables  
"LKS" Models

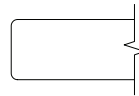

Eased Edge (R3)

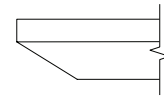

Reverse Bevel Edge (K9)

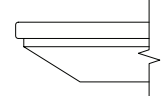

Reverse Bevel Edge (S7)

	D	W	H	CTN WT	CU FT	① Model	Veneer Tables "LKV" Models		Solid Surface Tables "LKS" Models		
							Essentials	Artisan	Essentials	Artisan	Standard
VENEER	48	48	29	86	49	LKV48-29RDX	\$2,595	\$2,774	\$2,698	\$2,889	--
	42	42	29	72	38	LKV42-29RDX	\$2,368	\$2,535	\$2,465	\$2,639	--
	36	36	29	58	29	LKV36-29RDX	\$2,294	\$2,455	\$2,388	\$2,555	--
	30	30	29	58	21	LKV30-29RDX	\$2,207	\$2,363	\$2,297	\$2,459	--
SOLID SURFACE	48	48	29	86	49	LKS48-29RDX	--	--	--	--	\$6,219
	42	42	29	72	38	LKS42-29RDX	--	--	--	--	\$5,281
	36	36	29	58	29	LKS36-29RDX	--	--	--	--	\$4,588
	30	30	29	47	21	LKS30-29RDX	--	--	--	--	\$3,976

Electrical Options and Upcharges

CTEC23	
EC23 Power Center Top - Black	CTEC23BL - add \$735
EC23 Power Center Top - White	CTEC23WH - add \$735
CTEC24	
EC24 Power Center Top - Black	CTEC43BL - add \$616
EC24 Power Center Top - White	CTEC43WH - add \$616

To Order Specify

① Veneer Model #	② Edge Detail	③ Wood Collection	④ Wood Finish	⑤ Electrical	⑥ Metal Color
Veneer (LKV)	<a href="#">See Edge Detail Options</a>	Essentials	<a href="#">See Essentials Wood Finish Options</a>	N None CTEC23 Power Center Top CTEC24 Power Center Top (See chart above)	<a href="#">See Metal Finish Color Options</a>
		Artisan	<a href="#">See Artisan Wood Finish Options</a>		

① Solid Surface Model #	② Top Surface Selection	③ Electrical Cut Out	④ Metal Color
Solid Surface (LKS)	<a href="#">See Solid Surface Top Surface Selection Options</a>	N None CTEC23 Power Center Top CTEC24 Power Center Top (See chart above)	<a href="#">See Metal Finish Color Options</a>

Description

Round Table with X4 Base at Working Height



Laminate Tables "LKT" Models

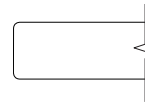

Eased Edge (R3)

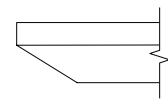

Reverse Bevel Edge (K9)

LAMINATE	D	W	H	CTN WT	CU FT	1 Model	Eased Edge (R3)		Reverse Bevel Edge (K9)	
							Standard Tier 1	Graded In Tier 2	Standard Tier 1	Graded In Tier 2
	60	60	29	148	73	LKT60-29RDZ	\$3,156	\$3,270	\$3,717	\$3,833
54	54	29	130	61	LKT54-29RDZ	\$3,092	\$3,180	\$3,653	\$3,743	

Features:

- price reflects complete table - top and base
- ships KD in multiple cartons
- one piece top
- model includes adjustable glide
- power cord is routed outside base column
- order vertical wire manager separately; see page 408

Options:

- specify power unit option; None (N), add \$594 for EC23 (CTEC23), add \$474 for EC24 (CTEC24)

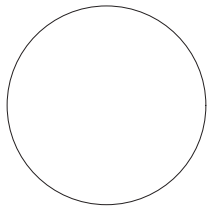

top shape

LOK - CONFERENCE

To Order Specify

1 Laminate Model #	2 Edge Detail	3 Laminate Selection	3a PVC Edge Color	4 Electrical	5 Metal Color
Laminate (LKT)	<a href="#">See Edge Detail Options</a>	<a href="#">See Laminate Selection</a>	<a href="#">See PVC Edge Color Options</a>	N None CTEC23 Power Center Top CTEC24 Power Center Top (See chart on next page)	<a href="#">See Metal Finish Color Options</a>

Model Number Breakdown

LKT60-29RDZ					
LK	T	60	29	RD	Z
LOK	Laminate	60" dia.	Height	Round Top Shape	X4 base

Description

Round Table with X4 Base  
at Working Height  
(continued)

Veneer Tables  
"LKV" Models

Solid Surface Tables  
"LKS" Models

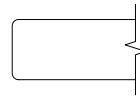

Eased Edge (R3)

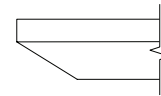

Reverse Bevel Edge (K9)

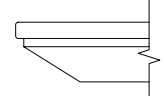

Reverse Bevel Edge (S7)

	D	W	H	CTN WT	CU FT	① Model	Veneer Tables "LKV" Models		Solid Surface Tables "LKS" Models		
							Essentials	Artisan	Essentials	Artisan	Standard
VENEER	60	60	29	148	73	LKV60-29RDZ	\$4,227	\$4,525	\$4,396	\$4,707	--
	54	54	29	130	61	LKV54-29RDZ	\$4,139	\$4,430	\$4,308	\$4,611	--
SOL. SURF.	60	60	29	148	73	LKS60-29RDZ	--	--	--	--	\$9,556
	54	54	29	130	61	LKS54-29RDZ	--	--	--	--	\$8,571

Electrical Options and Upcharges

CTEC23	
EC23 Power Center Top - Black	CTEC23BL - add \$594
EC23 Power Center Top - White	CTEC23WH - add \$594
CTEC24	
EC24 Power Center Top - Black	CTEC43BL - add \$474
EC24 Power Center Top - White	CTEC43WH - add \$474

To Order Specify

① Veneer Model #	② Edge Detail	③ Wood Collection	④ Wood Finish	⑤ Electrical	⑥ Metal Color
Veneer (LKV)	<a href="#">See Edge Detail Options</a>	Essentials	<a href="#">See Essentials Wood Finish Options</a>	N None CTEC23 Power Center Top CTEC24 Power Center Top (See chart above)	<a href="#">See Metal Finish Color Options</a>
		Artisan	<a href="#">See Artisan Wood Finish Options</a>		

① Solid Surface Model #	② Top Surface Selection	③ Electrical Cut Out	④ Metal Color
Solid Surface (LKS)	<a href="#">See Solid Surface Top Surface Selection Options</a>	N None CTEC23 Power Center Top CTEC24 Power Center Top (See chart above)	<a href="#">See Metal Finish Color Options</a>

Description

Square Table with X Base at Working Height

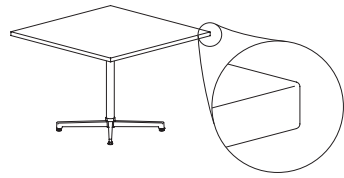

Laminate Tables "LKT" Models

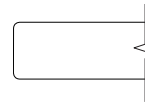

Eased Edge (R3)

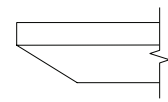

Reverse Bevel Edge (K9)

LAMINATE	D	W	H	CTN WT	CU FT	1 Model	Standard Tier 1	Graded In Tier 2	Standard Tier 1	Graded In Tier 2
		48	48	29	103	49	LKT4848-29SQX	\$1,981	\$2,049	\$2,542
	42	42	29	85	38	LKT4242-29SQX	\$1,816	\$1,881	\$2,378	\$2,442
	36	36	29	69	29	LKT3636-29SQX	\$1,599	\$1,652	\$2,315	\$2,337
	30	30	29	53	21	LKT3030-29SQX	\$1,426	\$1,470	\$1,987	\$2,028

Features:

- price reflects complete table - top and base
- ships KD in multiple cartons
- one piece top
- model includes adjustable glide
- when electrical option is selected, power accessible base is shipped; see page 178 for details
- power/charging units have 72" cord
- power cord is routed inside base column

Options:

- specify power access base with power unit option; None (N), add \$735 for EC23 (CTEC23), add \$616 for EC24 (CTEC24)



top shape

LOK - CONFERENCE

To Order Specify

1 Laminate Model #	2 Edge Detail	3 Laminate Selection	3a PVC Edge Color	4 Electrical	5 Metal Color
Laminate (LKT)	<a href="#">See Edge Detail Options</a>	<a href="#">See Laminate Selection</a>	<a href="#">See PVC Edge Color Options</a>	N None CTEC23 Power Center Top CTEC24 Power Center Top (See chart on next page)	<a href="#">See Metal Finish Color Options</a>

Model Number Breakdown

LKT4848-29SQX					
LK	T	4848	29	SQ	X
LOK	Laminate	48" x 48"	Height	Square Top Shape	X base

Description

Square Table with X Base  
at Working Height  
(continued)

Veneer Tables  
"LKV" Models

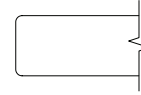

Eased Edge (R3)

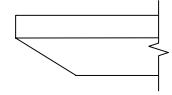

Reverse Bevel Edge (K9)

D	W	H	CTN WT	CU FT	① Model	Eased Edge (R3)		Reverse Bevel Edge (K9)	
						Essentials	Artisan	Essentials	Artisan
48	48	29	103	49	LKV4848-29SQX	\$2,613	\$2,797	\$2,718	\$2,910
42	42	29	85	38	LKV4242-29SQX	\$2,397	\$2,563	\$2,493	\$2,667
36	36	29	69	29	LKV3636-29SQX	\$2,110	\$2,261	\$2,197	\$2,350
30	30	29	53	21	LKV3030-29SQX	\$1,882	\$2,015	\$1,959	\$2,096

VENEER

LOK- CONFERENCE

Electrical Options and Upcharges

CTEC23	
EC23 Power Center Top - Black	CTEC23BL - add \$735
EC23 Power Center Top - White	CTEC23WH - add \$735
CTEC24	
EC24 Power Center Top - Black	CTEC43BL - add \$616
EC24 Power Center Top - White	CTEC43WH - add \$616

To Order Specify

① Veneer Model #	② Edge Detail	③ Wood Collection	④ Wood Finish	⑤ Electrical	⑥ Metal Color
Veneer (LKV)	<a href="#">See Edge Detail Options</a>	Essentials	<a href="#">See Essentials Wood Finish Options</a>	N None CTEC23 Power Center Top CTEC24 Power Center Top (See chart above)	<a href="#">See Metal Finish Color Options</a>
		Artisan	④ Wood Finish <a href="#">See Artisan Wood Finish Options</a>		

Description

Rounded Square Table with X Base at Working Height

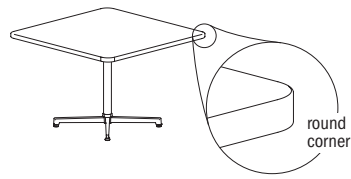

Laminate Tables  
"LKT" Models

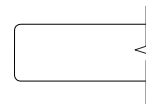

Eased Edge (R3)

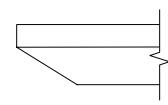

Reverse Bevel Edge (K9)

LAMINATE	D	W	H	CTN WT	CU FT	1 Model	Standard Tier 1	Graded In Tier 2	Standard Tier 1	Graded In Tier 2
		48	48	29	103	49	LKT4848-29SQRX	\$2,438	\$2,504	\$2,997
	42	42	29	85	38	LKT4242-29SQRX	\$2,254	\$2,319	\$2,815	\$2,884
	36	36	29	69	29	LKT3636-29SQRX	\$1,861	\$1,912	\$2,420	\$2,474
	30	30	29	53	21	LKT3030-29SQRX	\$1,653	\$1,698	\$2,213	\$2,259

Features:

- price reflects complete table - top and base
- ships KD in multiple cartons
- one piece top
- model includes adjustable glide
- when electrical option is selected, power accessible base is shipped; see page 178 for details
- power/charging units have 72" cord
- power cord is routed inside base column

Options:

- specify power access base with power unit option; None (N), add \$735 for EC23 (CTEC23), add \$616 for EC24 (CTEC24)

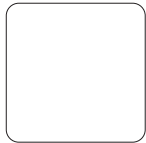

top shape

LOK - CONFERENCE

To Order Specify

1 Laminite Model #	2 Edge Detail	3 Laminite Selection	3a PVC Edge Color	4 Electrical	5 Metal Color
Laminite (LKT)	<a href="#">See Edge Detail Options</a>	<a href="#">See Laminite Selection</a>	<a href="#">See PVC Edge Color Options</a>	N None CTEC23 Power Center Top CTEC24 Power Center Top (See chart on next page)	<a href="#">See Metal Finish Color Options</a>

Model Number Breakdown

LKT4848-29SQRX						
LK	T	4848	29	SQ	R	X
LOK	Laminite	48" x 48"	Height	Square Top Shape	Round Corner	X base

Description

Rounded Square Table with X Base at Working Height (continued)

		Veneer Tables "LKV" Models				Solid Surface Tables "LKS" Models						
		Eased Edge (R3)		Reverse Bevel Edge (K9)		Reverse Bevel Edge (S7)						
		D	W	H	CTN WT	CU FT	Model	Essentials	Artisan	Essentials	Artisan	Standard
VENEER		48	48	29	103	49	LKV4848-29SQRX	\$3,214	\$3,439	\$3,344	\$3,578	--
		42	42	29	85	38	LKV4242-29SQRX	\$2,986	\$3,194	\$3,108	\$3,324	--
		36	36	29	69	29	LKV3636-29SQRX	\$2,455	\$2,627	\$2,553	\$2,733	--
		30	30	29	53	21	LKV3030-29SQRX	\$2,183	\$2,336	\$2,269	\$2,429	--
SOLID SURFACE		48	48	29	103	49	LKS4848-29SQRX	--	--	--	--	\$6,837
		42	42	29	85	38	LKS4242-29SQRX	--	--	--	--	\$5,898
		36	36	29	69	29	LKS3636-29SQRX	--	--	--	--	\$4,749
		30	30	29	53	21	LKS3030-29SQRX	--	--	--	--	\$3,954

Electrical Options and Upcharges

CTEC23	
EC23 Power Center Top - Black	CTEC23BL - add \$735
EC23 Power Center Top - White	CTEC23WH - add \$735
CTEC24	
EC24 Power Center Top - Black	CTEC43BL - add \$616
EC24 Power Center Top - White	CTEC43WH - add \$616

To Order Specify

1 Veneer Model #	2 Edge Detail	3 Wood Collection	4 Wood Finish	5 Electrical	6 Metal Color
Veneer (LKV)	<a href="#">See Edge Detail Options</a>	Essentials	<a href="#">See Essentials Wood Finish Options</a>	N None CTEC23 Power Center Top CTEC24 Power Center Top (See chart above)	<a href="#">See Metal Finish Color Options</a>
		Artisan	<a href="#">See Artisan Wood Finish Options</a>		

1 Solid Surface Model #	2 Top Surface Selection	3 Electrical Cut Out	4 Metal Color
Solid Surface (LKS)	<a href="#">See Solid Surface Top Surface Selection Options</a>	N None CTEC23 Power Center Top CTEC24 Power Center Top (See chart above)	<a href="#">See Metal Finish Color Options</a>

LOK - CONFERENCE

Description

Square Table with X4 Base at Working Height

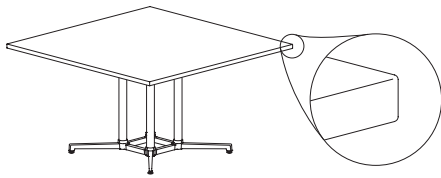

Laminate Tables "LKT" Models

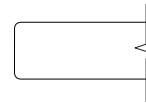

Eased Edge (R3)

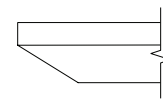

Reverse Bevel Edge (K9)

LAMINATE	D	W	H	CTN WT	CU FT	Model	Eased Edge (R3)		Reverse Bevel Edge (K9)	
							Standard Tier 1	Graded In Tier 2	Standard Tier 1	Graded In Tier 2
	60	60	29	174	73	LKT6060-29SQZ	\$3,624	\$3,736	\$4,183	\$4,298
	54	54	29	151	61	LKT5454-29SQZ	\$3,436	\$3,538	\$3,999	\$4,099

Features:

- price reflects complete table - top and base
- ships KD in multiple cartons
- one piece top
- model includes adjustable glide
- power cord is routed outside base column
- order vertical wire manager separately; see page 408

Options:

- specify power unit option; None (N), add \$594 for EC23 (CTEC23), add \$474 for EC24 (CTEC24)

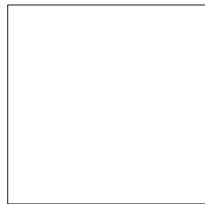

top shape

LOK - CONFERENCE

To Order Specify

1 Laminate Model #	2 Edge Detail	3 Laminate Selection	3a PVC Edge Color	4 Electrical	5 Metal Color
Laminate (LKT)	<a href="#">See Edge Detail Options</a>	<a href="#">See Laminate Selection</a>	<a href="#">See PVC Edge Color Options</a>	N None CTEC23 Power Center Top CTEC24 Power Center Top (See chart on next page)	<a href="#">See Metal Finish Color Options</a>

Model Number Breakdown

LKT6060-29SQZ					
LK	T	6060	29	SQ	Z
LOK	Laminate	60" x 60"	Height	Square Top Shape	X4 base

Description

Square Table with X4 Base  
at Working Height  
(continued)

Veneer Tables  
"LKV" Models

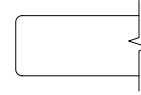

Eased Edge (R3)

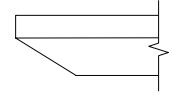

Reverse Bevel Edge (K9)

VENEER	D	W	H	CTN WT	CU FT	① Model	Eased Edge (R3)		Reverse Bevel Edge (K9)	
							Essentials	Artisan	Essentials	Artisan
	60	60	29	174	73	LKV6060-29SQZ	\$4,780	\$5,117	\$4,973	\$5,320
	54	54	29	151	61	LKV5454-29SQZ	\$4,536	\$4,855	\$4,717	\$5,049

LOK - CONFERENCE

Electrical Options and Upcharges

CTEC23	
EC23 Power Center Top - Black	CTEC23BL - add \$594
EC23 Power Center Top - White	CTEC23WH - add \$594
CTEC24	
EC24 Power Center Top - Black	CTEC43BL - add \$474
EC24 Power Center Top - White	CTEC43WH - add \$474

To Order Specify

① Veneer Model #	② Edge Detail	③ Wood Collection	④ Wood Finish	⑤ Electrical	⑥ Metal Color
Veneer (LKV)	<a href="#">See Edge Detail Options</a>	Essentials	<a href="#">See Essentials Wood Finish Options</a>	N None CTEC23 Power Center Top CTEC24 Power Center Top (See chart above)	<a href="#">See Metal Finish Color Options</a>
		Artisan	④ Wood Finish <a href="#">See Artisan Wood Finish Options</a>		

Description

Rounded Square Table with X4 Base at Working Height

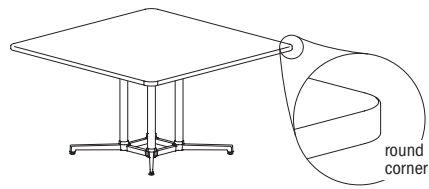

Laminate Tables  
"LKT" Models

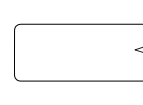

Eased Edge (R3)

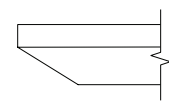

Reverse Bevel Edge (K9)

LAMINATE	D	W	H	CTN WT	CU FT	Model	Eased Edge (R3)		Reverse Bevel Edge (K9)	
							Standard	Graded In	Standard	Graded In
							Tier 1	Tier 2	Tier 1	Tier 2
	60	60	29	174	73	LKT6060-29SQRZ	\$3,913	\$4,013	\$4,473	\$4,573
	54	54	29	151	61	LKT5454-29SQRZ	\$3,193	\$3,296	\$3,755	\$3,854

Features:

- price reflects complete table - top and base
- ships KD in multiple cartons
- one piece top
- model includes adjustable glide
- power cord is routed outside base column
- order vertical wire manager separately; see page 408

Options:

- specify power unit option; None (N), add \$594 for EC23 (CTEC23), add \$474 for EC24 (CTEC24)

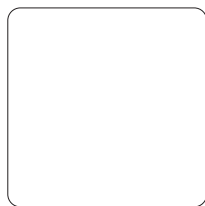

top shape

LOK - CONFERENCE

To Order Specify

1 Laminite Model #	2 Edge Detail	3 Laminite Selection	3a PVC Edge Color	4 Electrical	5 Metal Color
Laminite (LKT)	<a href="#">See Edge Detail Options</a>	<a href="#">See Laminite Selection</a>	<a href="#">See PVC Edge Color Options</a>	N None CTEC23 Power Center Top CTEC24 Power Center Top (See chart on next page)	<a href="#">See Metal Finish Color Options</a>

Model Number Breakdown

LKT6060-29SQRZ						
LK	T	6060	29	SQ	R	Z
LOK	Laminite	60" x 60"	Height	Square Top Shape	Round Corner	X4 base

Description

Rounded Square Table with X4 Base at Working Height (continued)

Veneer Tables "LKV" Models      Solid Surface Tables "LKS" Models

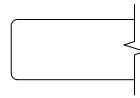

Eased Edge (R3)

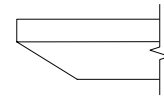

Reverse Bevel Edge (K9)

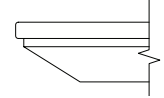

Reverse Bevel Edge (S7)

	D	W	H	CTN WT	CU FT	① Model	Veneer Tables "LKV" Models		Solid Surface Tables "LKS" Models		
							Essentials	Artisan	Essentials	Artisan	Standard
VENEER	60	60	29	174	73	LKV6060-29SQRZ	\$5,163	\$5,526	\$5,370	\$5,747	--
	54	54	29	151	61	LKV5454-29SQRZ	\$4,215	\$4,510	\$4,383	\$4,691	--
SOL. SURF.	60	60	29	174	73	LKS6060-29SQRZ	--	--	--	--	\$10,491
	54	54	29	151	61	LKS5454-29SQRZ	--	--	--	--	\$8,647

Electrical Options and Upcharges

CTEC23	
EC23 Power Center Top - Black	CTEC23BL - add \$594
EC23 Power Center Top - White	CTEC23WH - add \$594
CTEC24	
EC24 Power Center Top - Black	CTEC43BL - add \$474
EC24 Power Center Top - White	CTEC43WH - add \$474

To Order Specify

① Veneer Model #	② Edge Detail	③ Wood Collection	④ Wood Finish	⑤ Electrical	⑥ Metal Color
Veneer (LKV)	<a href="#">See Edge Detail Options</a>	Essentials	<a href="#">See Essentials Wood Finish Options</a>	N None CTEC23 Power Center Top CTEC24 Power Center Top (See chart above)	<a href="#">See Metal Finish Color Options</a>
		Artisan	<a href="#">See Artisan Wood Finish Options</a>		

① Solid Surface Model #	② Top Surface Selection	③ Electrical Cut Out	④ Metal Color
Solid Surface (LKS)	<a href="#">See Solid Surface Top Surface Selection Options</a>	N None CTEC23 Power Center Top CTEC24 Power Center Top (See chart above)	<a href="#">See Metal Finish Color Options</a>

LOK-CONFERENCE

Description

Squire Table with X Base at Working Height



Laminate Tables "LKT" Models

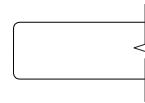

Eased Edge (R3)

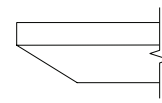

Reverse Bevel Edge (K9)

LAMINATE	D	W	H	CTN WT	CU FT	① Model	Eased Edge (R3)		Reverse Bevel Edge (K9)	
							Standard Tier 1	Graded In Tier 2	Standard Tier 1	Graded In Tier 2
	48	48	29	92	49	LKT48-29SCX	\$1,964	\$2,108	\$2,525	\$2,673
42	42	29	101	38	LKT42-29SCX	\$1,794	\$1,941	\$2,359	\$2,503	
36	36	29	62	29	LKT36-29SCX	\$1,737	\$1,789	\$2,298	\$2,352	
30	30	29	61	21	LKT30-29SCX	\$1,673	\$1,714	\$2,235	\$2,279	

Features:

- price reflects complete table - top and base
- ships KD in multiple cartons
- one piece top
- model includes adjustable glide
- when electrical option is selected, power accessible base is shipped; see page 178 for details
- power/charging units have 72" cord
- power cord is routed inside base column

Options:

- specify power access base with power unit option; None (N), add \$735 for EC23 (CTEC23), add \$616 for EC24 (CTEC24)

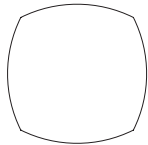

top shape

LOK - CONFERENCE

To Order Specify

① Laminate Model #	② Edge Detail	③ Laminate Selection	④ PVC Edge Color	⑤ Electrical	⑥ Metal Color
Laminate (LKT)	<a href="#">See Edge Detail Options</a>	<a href="#">See Laminate Selection</a>	<a href="#">See PVC Edge Color Options</a>	N None CTEC23 Power Center Top CTEC24 Power Center Top (See chart on next page)	<a href="#">See Metal Finish Color Options</a>

Model Number Breakdown

LKT48-29SQX					
LK	T	48	29	SQ	X
LOK	Laminate	48" dia.	Height	Squire Top Shape	X base

Description

Squirrel Table with X Base at Working Height (continued)

		Veneer Tables "LKV" Models				Solid Surface Tables "LKS" Models						
		Eased Edge (R3)		Reverse Bevel Edge (K9)		Reverse Bevel Edge (S7)						
		D	W	H	CTN WT	CU FT	Model	Essentials	Artisan	Essentials	Artisan	Standard
VENEER		48	48	29	92	49	LKV48-29SCX	\$2,620	\$2,801	\$2,727	\$2,916	--
		42	42	29	101	38	LKV42-29SCX	\$2,397	\$2,560	\$2,493	\$2,666	--
		36	36	29	62	29	LKV36-29SCX	\$2,318	\$2,479	\$2,412	\$2,582	--
		30	30	29	61	21	LKV30-29SCX	\$2,233	\$2,388	\$2,322	\$2,486	--
SOLID SURFACE		48	48	29	92	49	LKS48-29SCX	--	--	--	--	\$6,267
		42	42	29	101	38	LKS42-29SCX	--	--	--	--	\$5,331
		36	36	29	62	29	LKS36-29SCX	--	--	--	--	\$4,637
		30	30	29	61	21	LKS30-29SCX	--	--	--	--	\$4,028

Electrical Options and Upcharges

CTEC23	
EC23 Power Center Top - Black	CTEC23BL - add \$735
EC23 Power Center Top - White	CTEC23WH - add \$735
CTEC24	
EC24 Power Center Top - Black	CTEC43BL - add \$616
EC24 Power Center Top - White	CTEC43WH - add \$616

To Order Specify

1 Veneer Model #	2 Edge Detail	3 Wood Collection	4 Wood Finish	5 Electrical	6 Metal Color
Veneer (LKV)	<a href="#">See Edge Detail Options</a>	Essentials	<a href="#">See Essentials Wood Finish Options</a>	N None CTEC23 Power Center Top CTEC24 Power Center Top (See chart above)	<a href="#">See Metal Finish Color Options</a>
		Artisan	<a href="#">See Artisan Wood Finish Options</a>		

1 Solid Surface Model #	2 Top Surface Selection	3 Electrical Cut Out	4 Metal Color
Solid Surface (LKS)	<a href="#">See Solid Surface Top Surface Selection Options</a>	N None CTEC23 Power Center Top CTEC24 Power Center Top (See chart above)	<a href="#">See Metal Finish Color Options</a>

LOK- CONFERENCE

Description

Squircle Table with X4 Base at Working Height



Laminate Tables "LKT" Models

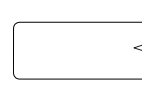

Eased Edge (R3)

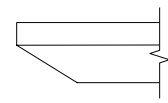

Reverse Bevel Edge (K9)

LAMINATE	D	W	H	CTN WT	CU FT	Model	Eased Edge (R3)		Reverse Bevel Edge (K9)	
							Standard	Graded In	Standard	Graded In
							Tier 1	Tier 2	Tier 1	Tier 2
	60	60	29	156	74	LKT60-29SCZ	\$3,180	\$3,298	\$3,744	\$3,861
	54	54	29	138	61	LKT54-29SCZ	\$3,116	\$3,209	\$3,680	\$3,770

Features:

- price reflects complete table - top and base
- ships KD in multiple cartons
- one piece top
- model includes adjustable glide
- power cord is routed outside base column
- order vertical wire manager separately; see page 408

Options:

- specify power unit option; None (N), add \$594 for EC23 (CTEC23), add \$474 for EC24 (CTEC24)

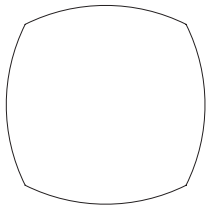

top shape

LOK - CONFERENCE

To Order Specify

1 Laminate Model #	2 Edge Detail	3 Laminate Selection	3a PVC Edge Color	4 Electrical	5 Metal Color
Laminate (LKT)	<a href="#">See Edge Detail Options</a>	<a href="#">See Laminate Selection</a>	<a href="#">See PVC Edge Color Options</a>	N None CTEC23 Power Center Top CTEC24 Power Center Top (See chart on next page)	<a href="#">See Metal Finish Color Options</a>

Model Number Breakdown

LKT60-29SCZ					
LK	T	60	29	SC	Z
LOK	Laminate	60" dia.	Height	Squircle Top Shape	X4 base

Description

Squirrel Table with X4 Base at Working Height (continued)

Veneer Tables "LKV" Models      Solid Surface Tables "LKS" Models

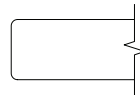

Eased Edge (R3)

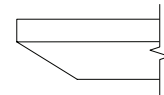

Reverse Bevel Edge (K9)

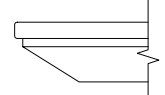

Reverse Bevel Edge (S7)

	D	W	H	CTN WT	CU FT	① Model	Veneer Tables "LKV" Models		Solid Surface Tables "LKS" Models		
							Essentials	Artisan	Essentials	Artisan	Standard
VENEER	60	60	29	156	74	LKV60-29SCZ	\$4,253	\$4,551	\$4,425	\$4,734	--
	54	54	29	138	61	LKV54-29SCZ	\$4,168	\$4,458	\$4,335	\$4,634	--
SOL. SURF.	60	60	29	156	74	LKS60-29SCZ	--	--	--	--	\$9,605
	54	54	29	138	61	LKS54-29SCZ	--	--	--	--	\$8,620

Electrical Options and Upcharges

CTEC23	
EC23 Power Center Top - Black	CTEC23BL - add \$594
EC23 Power Center Top - White	CTEC23WH - add \$594
CTEC24	
EC24 Power Center Top - Black	CTEC43BL - add \$474
EC24 Power Center Top - White	CTEC43WH - add \$474

To Order Specify

① Veneer Model #	② Edge Detail	③ Wood Collection	④ Wood Finish	⑤ Electrical	⑥ Metal Color
Veneer (LKV)	<a href="#">See Edge Detail Options</a>	Essentials	<a href="#">See Essentials Wood Finish Options</a>	N None CTEC23 Power Center Top CTEC24 Power Center Top (See chart above)	<a href="#">See Metal Finish Color Options</a>
		Artisan	<a href="#">See Artisan Wood Finish Options</a>		

① Solid Surface Model #	② Top Surface Selection	③ Electrical Cut Out	④ Metal Color
Solid Surface (LKS)	<a href="#">See Solid Surface Top Surface Selection Options</a>	N None CTEC23 Power Center Top CTEC24 Power Center Top (See chart above)	<a href="#">See Metal Finish Color Options</a>

LOK - CONFERENCE

Description

Hive Table with T Base at Working Height

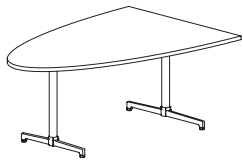

Laminate Tables  
"LKT" Models

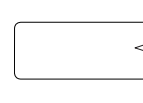

Eased Edge (R3)

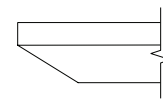

Reverse Bevel Edge (K9)

LAMI	D	W	H	CTN WT	CU FT	Model	Standard Tier 1	Graded In Tier 2	Standard Tier 1	Graded In Tier 2
		48	72	29	135	71	LKT4872-29HVT	\$2,518	\$2,568	\$3,127

Features:

- price reflects complete table - top and base
- ships KD in multiple cartons

Options:

- specify power/charging option, see below for options and upcharges
- specify glide (G) or caster (C) -choice of black (BL) or white/grey casters (WG)

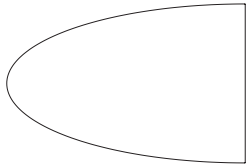

top shape

LOK - CONFERENCE

To Order Specify

1 Laminate Model #	2 Edge Detail	3 Laminate Selection	3a PVC Edge Color	4 Electrical
Laminate (LKT)	<a href="#">See Edge Detail Options</a>	<a href="#">See Laminate Selection</a>	<a href="#">See PVC Edge Color Options</a>	N None CT2 Dual Power Center Top (See chart on next page) CU1 Single Power Underside <b>5 Foot/Caster</b> G Glide C Caster - BL Black Caster - WG White Caster w/Grey Wheels <b>6 Metal Finish</b> <a href="#">See Metal Finish Color Options</a>

Model Number Breakdown

LKT4872-29HVT					
LK	T	4872	29	HV	T
LOK	Laminate	48" x 72"	Height	Hive Top Shape	T base

Description

Hive Table with T Base at Working Height (continued)

Veneer Tables "LKV" Models

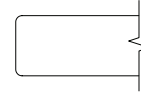

Eased Edge (R3)

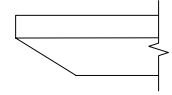

Reverse Bevel Edge (K9)

VEN.	D	W	H	CTN WT	CU FT	① Model	Essentials		Artisan	
							Price	Price	Price	Price
	48	72	29	135	71	LKV4872-29HVT	\$3,223	\$3,480	\$3,514	\$3,744

Electrical Options and Upcharges

CT2	
Dual Power Center Top - Black	CT2BL - add \$1,773
Dual Power Center Top - White	CT2WH - add \$1,773
CU1	
Single Power Underside - Black	CU11C - add \$711
Single Power Underside with Wireless Charging - Black	CU11CW - add \$1,651

Note: Order power infeed that best fits application, see page 408.

To Order, Specify:

① Veneer Model #	② Edge Detail	③ Wood Collection	④ Top Wood Finish	⑤ Electrical	⑥ Base - Foot/Caster	⑦ Metal Color
Veneer (LKV)	<a href="#">See Edge Detail Options</a>	Essentials	<a href="#">See Essentials Wood Finish Options</a>	N None CT2 Dual Power Center Top CU1 Single Power Underside (See chart above)	G Glide C Caster - BL Black Caster - WG White Caster with Grey Wheels	<a href="#">See Metal Finish Color Options</a>
		Artisan	④ Top Wood Finish <a href="#">See Artisan Wood Finish Options</a>			

LOK- CONFERENCE

Description

Rectangular Table with T Base at Counter Height

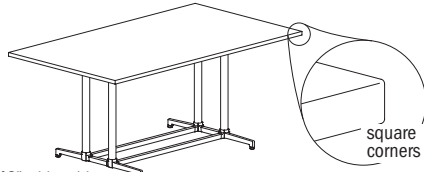

48" wide tables have double column base

D	W	H	CTN WT	CU FT	Model
48	96	36	233	115	LKT4896-36TTT
48	84	36	209	101	LKT4884-36TTT
42	96	36	186	83	LKT4296-36TTT
42	84	36	167	90	LKT4284-36TTT
36	96	36	166	89	LKT3696-36TTT
36	84	36	149	78	LKT3684-36TTT

LAMINATE

Laminate Tables "LKT" Models

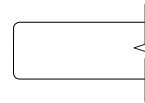

Eased Edge (R3)

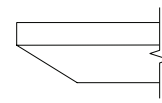

Reverse Bevel Edge (K9)

Eased Edge (R3)		Reverse Bevel Edge (K9)	
Standard Tier 1	Graded In Tier 2	Standard Tier 1	Graded In Tier 2
\$4,051	\$4,114	\$4,632	\$4,694
\$3,706	\$3,761	\$4,273	\$4,327
\$3,630	\$3,683	\$4,192	\$4,251
\$3,013	\$3,063	\$3,569	\$3,616
\$3,073	\$3,124	\$3,629	\$3,675
\$2,773	\$2,816	\$3,316	\$3,356

Features:

- price reflects complete table - top and base
- ships KD in multiple cartons
- one piece top
- model includes adjustable glide

Options:

- specify power/charging option, see below for options and upcharges

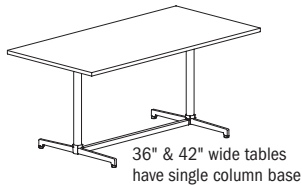

36" & 42" wide tables have single column base



top shape

LOK - CONFERENCE

To Order Specify

1 Laminate Model #	2 Edge Detail	3 Laminate Selection	3a PVC Edge Color	4 Electrical	5 Metal Color
Laminate (LKT)	<a href="#">See Edge Detail Options</a>	<a href="#">See Laminate Selection</a>	<a href="#">See PVC Edge Color Options</a>	N None CT2 Dual Power Center Top CU2 Dual Power Underside CT2U1 Dual Power Center Top with Underside (See chart on next page)	<a href="#">See Metal Finish Color Options</a>

Model Number Breakdown

LKT4896-36TTT					
LK	T	4896	36	TT	T
LOK	Laminate	48" x 96"	Height	Rectangular Top Shape	T base

Description

Rectangular Table with T Base  
at Counter Height  
(continued)

Veneer Tables  
"LKV" Models

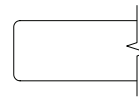

Eased Edge (R3)

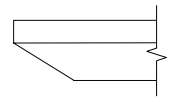

Reverse Bevel Edge (K9)

VENEER	D	W	H	CTN WT	CU FT	① Model	Essentials	Artisan	Essentials	Artisan
		48	96	36	233	115	LKV4896-36TTT	\$5,621	\$6,037	\$6,002
	48	84	36	209	101	LKV4884-36TTT	\$5,250	\$5,611	\$5,607	\$5,939
	42	96	36	186	83	LKV4296-36TTT	\$5,395	\$5,825	\$5,882	\$6,262
	42	84	36	167	90	LKV4284-36TTT	\$4,559	\$4,924	\$4,970	\$5,292
	36	96	36	166	89	LKV3696-36TTT	\$4,142	\$4,474	\$4,515	\$4,809
	36	84	36	149	78	LKV3684-36TTT	\$3,830	\$4,135	\$4,173	\$4,444

Electrical Options and Upcharges

CT2	84 - 96 wide
Dual Power Center Top - Black	CT2BL - add \$1,837
Dual Power Center Top - White	CT2WH - add \$1,837
CU1	
Dual Power Underside - Black	CU1-1C - add \$731
Dual Power Underside with Wireless Charging - Black	CU1-1CW - add \$1,691
CT2U1	
Dual Power Center Top - Black with Underside	CT2U1-BL - add \$2,235
Dual Power Center Top - White with Underside	CT2U1-WH - add \$2,235
Dual Power Center Top - Black with Wireless Charging	CT2U1-BLW2 - add \$3,194
Dual Power Center Top - White with Wireless Charging	CT2U1-WHW2 - add \$3,194

Note: Order power infeed that best fits application

To Order Specify

① Veneer Model #	② Edge Detail	③ Wood Collection	④ Wood Finish	⑤ Electrical	⑥ Metal Color
Veneer (LKV)	<a href="#">See Edge Detail Options</a>	Essentials	<a href="#">See Essentials Wood Finish Options</a>	N None CT2 Dual Power Center Top CU2 Dual Power Underside CT2U1 Dual Power Center Top with Underside (See chart above)	<a href="#">See Metal Finish Color Options</a>
		Artisan	④ Wood Finish <a href="#">See Artisan Wood Finish Options</a>		

Description

Rounded Rectangular Table with T Base at Counter Height

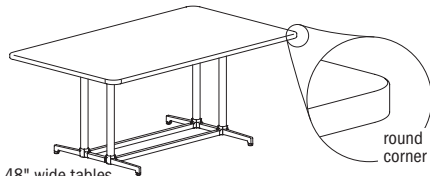

48" wide tables have double column base

D	W	H	CTN WT	CU FT	Model
48	96	36	233	115	LKT4896-36TTRT
48	84	36	209	101	LKT4884-36TTRT
42	96	36	186	83	LKT4296-36TTRT
42	84	36	167	90	LKT4284-36TTRT
36	96	36	166	89	LKT3696-36TTRT
36	84	36	149	78	LKT3684-36TTRT

LAMINATE

Laminate Tables "LKT" Models

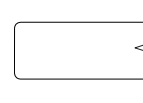

Eased Edge (R3)

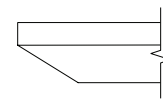

Reverse Bevel Edge (K9)

Eased Edge (R3)		Reverse Bevel Edge (K9)	
Standard Tier 1	Graded In Tier 2	Standard Tier 1	Graded In Tier 2
\$4,151	\$4,214	\$4,734	\$4,796
\$3,775	\$3,831	\$4,343	\$4,400
\$3,697	\$3,755	\$4,265	\$4,321
\$3,079	\$3,128	\$3,634	\$3,683
\$3,142	\$3,188	\$3,692	\$3,737
\$2,838	\$2,879	\$3,377	\$3,419

Features:

- price reflects complete table - top and base
- ships KD in multiple cartons
- one piece top
- model includes adjustable glide

Options:

- specify power/charging option, see below for options and upcharges

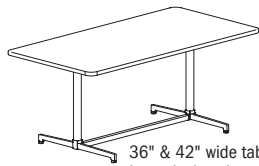

36" & 42" wide tables have single column base



top shape

LOK - CONFERENCE

To Order Specify

1 Laminate Model #	2 Edge Detail	3 Laminate Selection	3a PVC Edge Color	4 Electrical	5 Metal Color
Laminate (LKT)	<a href="#">See Edge Detail Options</a>	<a href="#">See Laminate Selection</a>	<a href="#">See PVC Edge Color Options</a>	N None CT2 Dual Power Center Top CU2 Dual Power Underside CT2U1 Dual Power Center Top with Underside (See chart on next page)	<a href="#">See Metal Finish Color Options</a>

Model Number Breakdown

LKT4896-36TTRT						
LK	T	4896	36	TT	R	T
LOK	Laminate	48" x 96"	Height	Rectangular Top Shape	Rounded Corner	T Base

Description

Rounded Rectangular Table with T Base at Counter Height (continued)

Veneer Tables "LKV" Models      Solid Surface Tables "LKS" Models

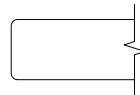

Eased Edge (R3)

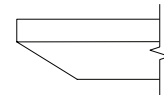

Reverse Bevel Edge (K9)

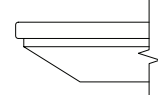

Reverse Bevel Edge (K7)

	D	W	H	CTN WT	CU FT	① Model	Veneer Tables		Solid Surface Tables		
							Essentials	Artisan	Essentials	Artisan	Standard
VENEER	48	96	36	233	115	LKV4896-36TTRT	\$5,748	\$6,168	\$6,130	\$6,514	--
	48	84	36	209	101	LKV4884-36TTRT	\$5,341	\$5,699	\$5,696	\$6,030	--
	42	96	36	186	83	LKV4296-36TTRT	\$5,485	\$5,925	\$5,977	\$6,368	--
	42	84	36	167	90	LKV4284-36TTRT	\$4,643	\$5,013	\$5,060	\$5,386	--
	36	96	36	166	89	LKV3696-36TTRT	\$4,222	\$4,563	\$4,604	\$4,901	--
	36	84	36	149	78	LKV3684-36TTRT	\$3,901	\$4,215	\$4,257	\$4,530	--
SOLID SURFACE	48	96	36	233	115	LKS4896-36TTRT	--	--	--	--	\$12,994
	48	84	36	209	101	LKS4884-36TTRT	--	--	--	--	\$11,627
	42	96	36	186	83	LKS4296-36TTRT	--	--	--	--	\$10,507
	42	84	36	167	90	LKS4284-36TTRT	--	--	--	--	\$9,287
	36	96	36	166	89	LKS3696-36TTRT	--	--	--	--	\$9,259
	36	84	36	149	78	LKS3684-36TTRT	--	--	--	--	\$8,366

Electrical Options and Upcharges

CT2	84 - 96 wide
Dual Power Center Top - Black	CT2BL - add \$1,837
Dual Power Center Top - White	CT2WH - add \$1,837
CU1	
Dual Power Underside - Black	CU1-1C - add \$731
Dual Power Underside with Wireless Charging - Black	CU1-1CW - add \$1,691
CT2U1	
Dual Power Center Top - Black with Underside	CT2U1-BL - add \$2,235
Dual Power Center Top - White with Underside	CT2U1-WH - add \$2,235
Dual Power Center Top - Black with Wireless Charging	CT2U1-BLW2 - add \$3,194
Dual Power Center Top - White with Wireless Charging	CT2U1-WHW2 - add \$3,194

Note: Order power infeed that best fits application

To Order Specify

① Veneer Model #	② Edge Detail	③ Wood Collection	④ Wood Finish	⑤ Electrical	⑥ Metal Color
Veneer (LKV)	<a href="#">See Edge Detail Options</a>	Essentials	<a href="#">See Essentials Wood Finish Options</a>	N None CT2 Dual Power Center Top CU2 Dual Power Underside CT2U1 Dual Power Center Top with Underside (See chart above)	<a href="#">See Metal Finish Color Options</a>
		Artisan	④ Wood Finish <a href="#">See Artisan Wood Finish Options</a>		

① Solid Surface Model #	② Top Surface Selection	③ Electrical	④ Metal Color
Solid Surface (LKS)	<a href="#">See Solid Surface Top Surface Selection Options</a>	N None CT2 Dual Power Center Top CU2 Dual Power Underside CT2U1 Dual Power Center Top with Underside (See chart above)	<a href="#">See Metal Finish Color Options</a>

LOK - CONFERENCE

Description

Rectangular Table with Y Base at Counter Height

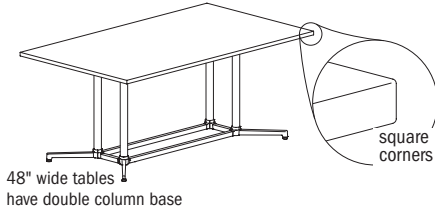

Laminate Tables "LKT" Models

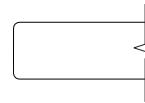

Eased Edge (R3)

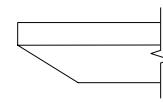

Reverse Bevel Edge (K9)

LAMINATE	D	W	H	CTN WT	CU FT	Model	Eased Edge (R3)		Reverse Bevel Edge (K9)	
							Standard Tier 1	Graded In Tier 2	Standard Tier 1	Graded In Tier 2
	48	96	36	232	115	LKT4896-36TTY	\$4,090	\$4,154	\$4,673	\$4,737
48	84	36	209	101	LKT4884-36TTY	\$3,622	\$3,676	\$4,186	\$4,244	
42	96	36	197	102	LKT4296-36TTY	\$4,634	\$4,691	\$5,202	\$5,256	
42	84	36	178	89	LKT4284-36TTY	\$3,155	\$3,203	\$3,710	\$3,758	
36	96	36	177	89	LKT3696-36TTY	\$3,170	\$3,218	\$3,722	\$3,770	
36	84	36	159	78	LKT3684-36TTY	\$2,818	\$2,859	\$3,360	\$3,401	

Features:

- price reflects complete table - top and base
- ships KD in multiple cartons
- one piece top
- model includes adjustable glide

Options:

- specify power/charging option, see below for options and upcharges

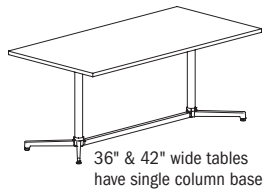

top shape

LOK - CONFERENCE

To Order Specify

1 Laminate Model #	2 Edge Detail	3 Laminate Selection	3a PVC Edge Color	4 Electrical	5 Metal Color
Laminate (LKT)	<a href="#">See Edge Detail Options</a>	<a href="#">See Laminate Selection</a>	<a href="#">See PVC Edge Color Options</a>	N None CT2 Dual Power Center Top CU2 Dual Power Underside CT2U1 Dual Power Center Top with Underside (See chart on next page)	<a href="#">See Metal Finish Color Options</a>

Model Number Breakdown

LKT4896-36TTY					
LK	T	4896	36	TT	Y
LOK	Laminate	48" x 96"	Height	Rectangular Top Shape	Y Base

Description

Rectangular Table with Y Base  
at Counter Height  
(continued)

Veneer Tables  
"LKV" Models

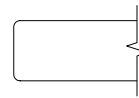

Eased Edge (R3)

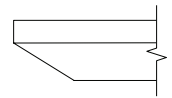

Reverse Bevel Edge (K9)

D	W	H	CTN WT	CU FT	① Model	Essentials		Artisan	
						Essentials	Artisan	Essentials	Artisan
48	96	36	232	115	LKV4896-36TTY	\$5,673	\$6,089	\$6,053	\$6,442
48	84	36	209	101	LKV4884-36TTY	\$5,146	\$5,506	\$5,501	\$5,836
42	96	36	197	102	LKV4296-36TTY	\$6,658	\$7,189	\$7,255	\$7,725
	84	36	178	89	LKV4284-36TTY	\$4,735	\$5,112	\$5,161	\$5,495
36	96	36	177	89	LKV3696-36TTY	\$4,261	\$4,602	\$4,644	\$4,944
36	84	36	159	78	LKV3684-36TTY	\$3,881	\$4,190	\$4,230	\$4,505

VENEER

Electrical Options and Upcharges

CT2	84 - 96 wide
Dual Power Center Top - Black	CT2BL - add \$1,837
Dual Power Center Top - White	CT2WH - add \$1,837
CU1	
Dual Power Underside - Black	CU1-1C - add \$731
Dual Power Underside with Wireless Charging - Black	CU1-1CW - add \$1,691
CT2U1	
Dual Power Center Top - Black with Underside	CT2U1-BL - add \$2,235
Dual Power Center Top - White with Underside	CT2U1-WH - add \$2,235
Dual Power Center Top - Black with Wireless Charging	CT2U1-BLW2 - add \$3,194
Dual Power Center Top - White with Wireless Charging	CT2U1-WHW2 - add \$3,194

Note: Order power infeed that best fits application

To Order Specify

① Veneer Model #	② Edge Detail	③ Wood Collection	④ Wood Finish	⑤ Electrical	⑥ Metal Color
Veneer (LKV)	<a href="#">See Edge Detail Options</a>	Essentials	<a href="#">See Essentials Wood Finish Options</a>	N None CT2 Dual Power Center Top CU2 Dual Power Underside CT2U1 Dual Power Center Top with Underside (See chart above)	<a href="#">See Metal Finish Color Options</a>
		Artisan	④ Wood Finish <a href="#">See Artisan Wood Finish Options</a>		

LOK - CONFERENCE

Description

Rounded Rectangular Table with Y Base at Counter Height

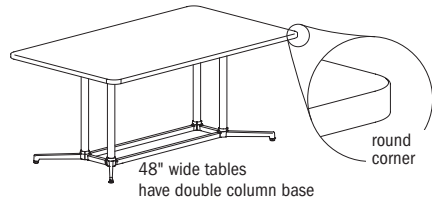

Laminate Tables  
"LKT" Models

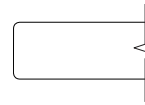

Eased Edge (R3)

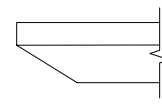

Reverse Bevel Edge (K9)

LAMINATE	D	W	H	CTN WT	CU FT	Model	Standard Tier 1	Graded In Tier 2	Standard Tier 1	Graded In Tier 2
		48	96	36	232	115	LKT4896-36TTRY	\$4,169	\$4,230	\$4,749
	48	84	36	209	101	LKT4884-36TTRY	\$3,691	\$3,747	\$4,260	\$4,315
	42	96	36	197	102	LKT4296-36TTRY	\$4,709	\$4,763	\$5,273	\$5,330
	42	84	36	178	89	LKT4284-36TTRY	\$3,219	\$3,268	\$3,775	\$3,823
	36	96	36	177	89	LKT3696-36TTRY	\$3,237	\$3,283	\$3,787	\$3,835
	36	84	36	159	78	LKT3684-36TTRY	\$2,880	\$2,921	\$3,422	\$3,464

Features:

- price reflects complete table - top and base
- ships KD in multiple cartons
- one piece top
- model includes adjustable glide

Options:

- specify power/charging option, see below for options and upcharges

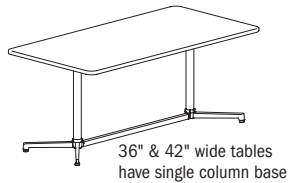

To Order Specify

1 Laminite Model #	2 Edge Detail	3 Laminite Selection	3a PVC Edge Color	4 Electrical	5 Metal Color
Laminite (LKT)	<a href="#">See Edge Detail Options</a>	<a href="#">See Laminite Selection</a>	<a href="#">See PVC Edge Color Options</a>	N None CT2 Dual Power Center Top CU2 Dual Power Underside CT2U1 Dual Power Center Top with Underside (See chart on next page)	<a href="#">See Metal Finish Color Options</a>

Model Number Breakdown

LKT4896-36TTRY						
LK	T	4896	36	TT	R	Y
LOK	Laminite	48" x 96"	Height	Rectangular Top Shape	Rounded Corner	Y Base

Description

Rounded Rectangular Table with Y Base at Counter Height (continued)

Veneer Tables "LKV" Models      Solid Surface Tables "LKS" Models

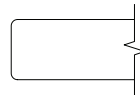

Eased Edge (R3)

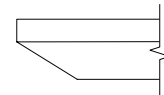

Reverse Bevel Edge (K9)

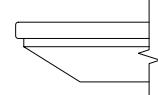

Reverse Bevel Edge (K7)

	D	W	H	CTN WT	CU FT	① Model	Veneer		Solid Surface		
							Essentials	Artisan	Essentials	Artisan	Standard
VENEER	48	96	36	232	115	LKV4896-36TTRY	\$5,770	\$6,187	\$6,151	\$6,542	--
	48	84	36	209	101	LKV4884-36TTRY	\$5,236	\$5,594	\$5,589	\$5,926	--
	42	96	36	197	102	LKV4296-36TTRY	\$6,745	\$7,285	\$7,352	\$7,829	--
	42	84	36	178	89	LKV4284-36TTRY	\$4,813	\$5,197	\$5,246	\$5,588	--
	36	96	36	177	89	LKV3696-36TTRY	\$4,339	\$4,687	\$4,728	\$5,036	--
	36	84	36	159	78	LKV3684-36TTRY	\$3,958	\$4,273	\$4,312	\$4,591	--
SOLID SURFACE	48	96	36	232	115	LKS4896-36TTRY	--	--	--	--	\$13,015
	48	84	36	209	101	LKS4884-36TTRY	--	--	--	--	\$11,522
	42	96	36	197	102	LKS4296-36TTRY	--	--	--	--	\$11,770
	42	84	36	178	89	LKS4284-36TTRY	--	--	--	--	\$9,459
	36	96	36	177	89	LKS3696-36TTRY	--	--	--	--	\$9,376
	36	84	36	159	78	LKS3684-36TTRY	--	--	--	--	\$8,418

Electrical Options and Upcharges

CT2	84 - 96 wide
Dual Power Center Top - Black	CT2BL - add \$1,837
Dual Power Center Top - White	CT2WH - add \$1,837
CU1	
Dual Power Underside - Black	CU1-1C - add \$731
Dual Power Underside with Wireless Charging - Black	CU1-1CW - add \$1,691
CT2U1	
Dual Power Center Top - Black with Underside	CT2U1-BL - add \$2,235
Dual Power Center Top - White with Underside	CT2U1-WH - add \$2,235
Dual Power Center Top - Black with Wireless Charging	CT2U1-BLW2 - add \$3,194
Dual Power Center Top - White with Wireless Charging	CT2U1-WHW2 - add \$3,194

Note: Order power infeed that best fits application

To Order Specify

① Veneer Model #	② Edge Detail	③ Wood Collection	④ Wood Finish	⑤ Electrical	⑥ Metal Color
Veneer (LKV)	<a href="#">See Edge Detail Options</a>	Essentials	<a href="#">See Essentials Wood Finish Options</a>	N None CT2 Dual Power Center Top CU2 Dual Power Underside CT2U1 Dual Power Center Top with Underside (See chart above)	<a href="#">See Metal Finish Color Options</a>
		Artisan	④ Wood Finish <a href="#">See Artisan Wood Finish Options</a>		

① Solid Surface Model #	② Top Surface Selection	③ Electrical	④ Metal Color
Solid Surface (LKS)	<a href="#">See Solid Surface Top Surface Selection Options</a>	N None CT2 Dual Power Center Top CU2 Dual Power Underside CT2U1 Dual Power Center Top with Underside (See chart above)	<a href="#">See Metal Finish Color Options</a>

LOK - CONFERENCE

Description

Arc Rectangular Table with T Base at Counter Height

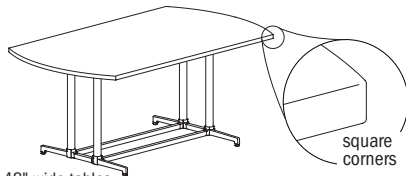

48" wide tables have double column base

LAMINATE

D	W	H	CTN WT	CU FT	Model
48	96	36	226	115	LKT4896-36ART
48	84	36	202	101	LKT4884-36ART
42	96	36	182	83	LKT4296-36ART
42	84	36	162	90	LKT4284-36ART
36	96	36	163	89	LKT3696-36ART
36	84	36	145	78	LKT3684-36ART

Laminate Tables "LKT" Models

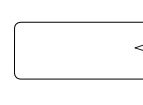

Eased Edge (R3)

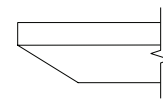

Reverse Bevel Edge (K9)

Eased Edge (R3)		Reverse Bevel Edge (K9)	
Standard Tier 1	Graded In Tier 2	Standard Tier 1	Graded In Tier 2
\$4,151	\$4,214	\$4,734	\$4,796
\$3,775	\$3,831	\$4,343	\$4,400
\$3,697	\$3,755	\$4,265	\$4,321
\$3,079	\$3,128	\$3,634	\$3,683
\$3,142	\$3,188	\$3,692	\$3,737
\$2,838	\$2,879	\$3,377	\$3,419

Features:

- price reflects complete table - top and base
- ships KD in multiple cartons
- one piece top
- model includes adjustable glide

Options:

- specify power/charging option, see below for options and upcharges

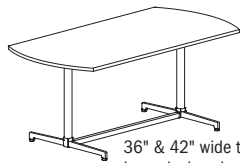

36" & 42" wide tables have single column base

LOK - CONFERENCE

To Order Specify

1 Laminite Model #	2 Edge Detail	3 Laminite Selection	3a PVC Edge Color	4 Electrical	5 Metal Color
Laminite (LKT)	<a href="#">See Edge Detail Options</a>	<a href="#">See Laminite Selection</a>	<a href="#">See PVC Edge Color Options</a>	N None CT2 Dual Power Center Top CU2 Dual Power Underside CT2U1 Dual Power Center Top with Underside (See chart on next page)	<a href="#">See Metal Finish Color Options</a>

Model Number Breakdown

LKT4896-36ART					
LK	T	4896	36	AR	T
LOK	Laminite	48" x 96"	Height	Arc Rectangular Top Shape	T Base

Description

Arc Rectangular Table with T Base at Counter Height (continued)

Veneer Tables "LKV" Models

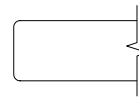

Eased Edge (R3)

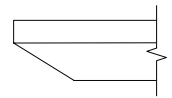

Reverse Bevel Edge (K9)

VENEER	D	W	H	CTN WT	CU FT	Model	Essentials	Artisan	Essentials	Artisan
		48	96	36	226	115	LKV4896-36ART	\$5,748	\$6,168	\$6,130
	48	84	36	202	101	LKV4884-36ART	\$5,341	\$5,699	\$5,696	\$6,030
	42	96	36	182	83	LKV4296-36ART	\$5,485	\$5,925	\$5,977	\$6,368
	42	84	36	162	90	LKV4284-36ART	\$4,643	\$5,013	\$5,060	\$5,386
	36	96	36	163	89	LKV3696-36ART	\$4,222	\$4,563	\$4,604	\$4,901
	36	84	36	145	78	LKV3684-36ART	\$3,901	\$4,215	\$4,257	\$4,530

Electrical Options and Upcharges

CT2	84 - 96 wide
Dual Power Center Top - Black	CT2BL - add \$1,837
Dual Power Center Top - White	CT2WH - add \$1,837
CU1	
Dual Power Underside - Black	CU1-1C - add \$731
Dual Power Underside with Wireless Charging - Black	CU1-1CW - add \$1,691
CT2U1	
Dual Power Center Top - Black with Underside	CT2U1-BL - add \$2,235
Dual Power Center Top - White with Underside	CT2U1-WH - add \$2,235
Dual Power Center Top - Black with Wireless Charging	CT2U1-BLW2 - add \$3,194
Dual Power Center Top - White with Wireless Charging	CT2U1-WhW2 - add \$3,194

Note: Order power infeed that best fits application

To Order Specify

1 Veneer Model #	2 Edge Detail	3 Wood Collection	4 Wood Finish	5 Electrical	6 Metal Color
Veneer (LKV)	<a href="#">See Edge Detail Options</a>	Essentials	<a href="#">See Essentials Wood Finish Options</a>	N None CT2 Dual Power Center Top CU2 Dual Power Underside CT2U1 Dual Power Center Top with Underside (See chart above)	<a href="#">See Metal Finish Color Options</a>
		Artisan	4 Wood Finish <a href="#">See Artisan Wood Finish Options</a>		

LOK - CONFERENCE

Description

Rounded Arc Rectangular Table with T Base at Counter Height

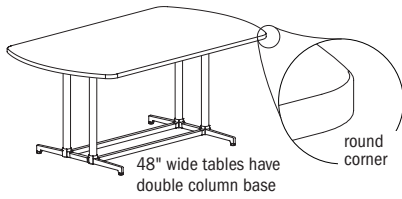

Laminate Tables  
"LKT" Models

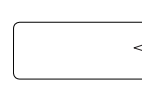

Eased Edge (R3)

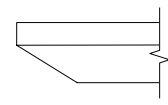

Reverse Bevel Edge (K9)

LAMINATE	D	W	H	CTN WT	CU FT	1 Model	Eased Edge (R3)		Reverse Bevel Edge (K9)	
							Standard Tier 1	Graded In Tier 2	Standard Tier 1	Graded In Tier 2
	48	96	36	226	115	LKT4896-36ARRT	\$4,151	\$4,214	\$4,734	\$4,796
48	84	36	202	101	LKT4884-36ARRT	\$3,775	\$3,831	\$4,343	\$4,400	
42	96	36	182	83	LKT4296-36ARRT	\$3,697	\$3,755	\$4,265	\$4,321	
42	84	36	162	90	LKT4284-36ARRT	\$3,079	\$3,128	\$3,634	\$3,683	
36	96	36	163	89	LKT3696-36ARRT	\$3,142	\$3,188	\$3,692	\$3,737	
36	84	36	145	78	LKT3684-36ARRT	\$2,838	\$2,879	\$3,377	\$3,419	

Features:

- price reflects complete table - top and base
- ships KD in multiple cartons
- one piece top
- model includes adjustable glide

Options:

- specify power/charging option, see below for options and upcharges

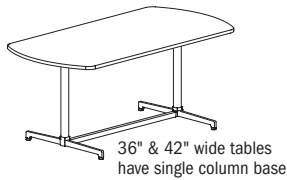

LOK - CONFERENCE

To Order Specify

1 Laminite Model #	2 Edge Detail	3 Laminite Selection	3a PVC Edge Color	4 Electrical	5 Metal Color
Laminite (LKT)	<a href="#">See Edge Detail Options</a>	<a href="#">See Laminite Selection</a>	<a href="#">See PVC Edge Color Options</a>	N None CT2 Dual Power Center Top CU2 Dual Power Underside CT2U1 Dual Power Center Top with Underside (See chart on next page)	<a href="#">See Metal Finish Color Options</a>

Model Number Breakdown

LKT4896-36ARRT						
LK	T	4896	36	AR	R	T
LOK	Laminite	48" x 96"	Height	Arc Rectangular Top Shape	Rounded Corner	T Base

Description

Rounded Arc Rectangular Table with T Base at Counter Height (continued)

Veneer Tables "LKV" Models      Solid Surface Tables "LKS" Models

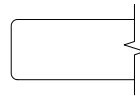

Eased Edge (R3)

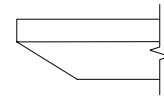

Reverse Bevel Edge (K9)

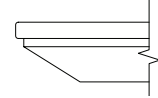

Reverse Bevel Edge (K7)

	D	W	H	CTN WT	CU FT	① Model	Veneer Tables		Solid Surface Tables		
							Essentials	Artisan	Essentials	Artisan	Standard
VENEER	48	96	36	226	115	LKV4896-36ARRT	\$5,748	\$6,168	\$6,130	\$6,514	--
	48	84	36	202	101	LKV4884-36ARRT	\$5,341	\$5,699	\$5,696	\$6,030	--
	42	96	36	182	83	LKV4296-36ARRT	\$5,485	\$5,925	\$5,977	\$6,368	--
	42	84	36	162	90	LKV4284-36ARRT	\$4,643	\$5,013	\$5,060	\$5,386	--
	36	96	36	163	89	LKV3696-36ARRT	\$4,222	\$4,563	\$4,604	\$4,901	--
	36	84	36	145	78	LKV3684-36ARRT	\$3,901	\$4,215	\$4,257	\$4,530	--
SOLID SURFACE	48	96	36	226	115	LKS4896-36ARRT	--	--	--	--	\$12,994
	48	84	36	202	101	LKS4884-36ARRT	--	--	--	--	\$11,627
	42	96	36	182	83	LKS4296-36ARRT	--	--	--	--	\$10,507
	42	84	36	162	90	LKS4284-36ARRT	--	--	--	--	\$9,287
	36	96	36	163	89	LKS3696-36ARRT	--	--	--	--	\$9,259
	36	84	36	145	78	LKS3684-36ARRT	--	--	--	--	\$8,366

Electrical Options and Upcharges

CT2	84 - 96 wide
Dual Power Center Top - Black	CT2BL - add \$1,837
Dual Power Center Top - White	CT2WH - add \$1,837
CU1	
Dual Power Underside - Black	CU1-1C - add \$731
Dual Power Underside with Wireless Charging - Black	CU1-1CW - add \$1,691
CT2U1	
Dual Power Center Top - Black with Underside	CT2U1-BL - add \$2,235
Dual Power Center Top - White with Underside	CT2U1-WH - add \$2,235
Dual Power Center Top - Black with Wireless Charging	CT2U1-BLW2 - add \$3,194
Dual Power Center Top - White with Wireless Charging	CT2U1-WHW2 - add \$3,194

Note: Order power infeed that best fits application

To Order Specify

① Veneer Model #	② Edge Detail	③ Wood Collection	④ Wood Finish	⑤ Electrical	⑥ Metal Color
Veneer (LKV)	<a href="#">See Edge Detail Options</a>	Essentials	<a href="#">See Essentials Wood Finish Options</a>	N None CT2 Dual Power Center Top CU2 Dual Power Underside CT2U1 Dual Power Center Top with Underside (See chart above)	<a href="#">See Metal Finish Color Options</a>
		Artisan	④ Wood Finish <a href="#">See Artisan Wood Finish Options</a>		

① Solid Surface Model #	② Top Surface Selection	③ Electrical	④ Metal Color
Solid Surface (LKS)	<a href="#">See Solid Surface Top Surface Selection Options</a>	N None CT2 Dual Power Center Top CU2 Dual Power Underside CT2U1 Dual Power Center Top with Underside (See chart above)	<a href="#">See Metal Finish Color Options</a>

LOK - CONFERENCE

Description

Arc Rectangular Table with Y Base at Counter Height

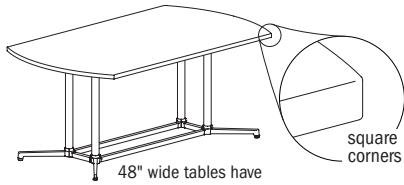

48" wide tables have double column base

LAMINATE

D	W	H	CTN WT	CU FT	Model
---	---	---	--------	-------	-------

48	96	36	226	115	LKT4896-36ARY
48	84	36	201	101	LKT4884-36ARY
42	96	36	193	102	LKT4296-36ARY
42	84	36	172	89	LKT4284-36ARY
36	96	36	177	89	LKT3696-36ARY
36	84	36	156	78	LKT3684-36ARY

Laminate Tables "LKT" Models

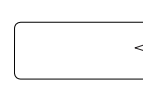

Eased Edge (R3)

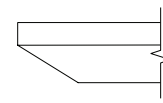

Reverse Bevel Edge (K9)

Standard Tier 1	Graded In Tier 2	Standard Tier 1	Graded In Tier 2
\$2,443	\$2,490	\$3,069	\$3,116
\$2,230	\$2,315	\$2,792	\$2,875
\$2,056	\$2,131	\$2,614	\$2,689
\$2,566	\$2,621	\$3,209	\$3,263
\$2,150	\$2,230	\$2,711	\$2,792

Features:

- price reflects complete table - top and base
- ships KD in multiple cartons
- one piece top
- model includes adjustable glide

Options:

- specify power/charging option, see below for options and upcharges

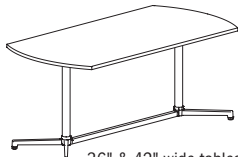

36" & 42" wide tables have single column base

LOK - CONFERENCE

To Order Specify

1 Laminate Model #	2 Edge Detail	3 Laminate Selection	3a PVC Edge Color	4 Electrical	5 Metal Color
Laminate (LKT)	<a href="#">See Edge Detail Options</a>	<a href="#">See Laminate Selection</a>	<a href="#">See PVC Edge Color Options</a>	N None CT2 Dual Power Center Top CU2 Dual Power Underside CT2U1 Dual Power Center Top with Underside (See chart on next page)	<a href="#">See Metal Finish Color Options</a>

Model Number Breakdown

LKT4896-36ARY					
LK	T	4896	36	AR	Y
LOK	Laminate	48" x 96"	Height	Arc Rectangular Top Shape	Y Base

Description

Arc Rectangular Table with Y Base at Counter Height (continued)

Veneer Tables "LKV" Models

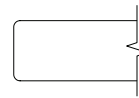

Eased Edge (R3)

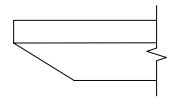

Reverse Bevel Edge (K9)

D	W	H	CTN WT	CU FT	① Model	Essentials		Artisan	
						Essentials	Artisan	Essentials	Artisan
48	96	36	226	115	LKV4896-36ARY	\$5,770	\$6,187	\$6,151	\$6,542
48	84	36	201	101	LKV4884-36ARY	\$5,236	\$5,594	\$5,589	\$5,926
42	96	36	193	102	LKV4296-36ARY	\$6,745	\$7,285	\$7,352	\$7,829
	84	36	172	89	LKV4284-36ARY	\$4,813	\$5,197	\$5,246	\$5,588
36	96	36	177	89	LKV3696-36ARY	\$4,339	\$4,687	\$4,728	\$5,036
36	84	36	156	78	LKV3684-36ARY	\$3,958	\$4,273	\$4,312	\$4,591

VENEER

Electrical Options and Upcharges

CT2	84 - 96 wide
Dual Power Center Top - Black	CT2BL - add \$1,837
Dual Power Center Top - White	CT2WH - add \$1,837
CU1	
Dual Power Underside - Black	CU1-1C - add \$731
Dual Power Underside with Wireless Charging - Black	CU1-1CW - add \$1,691
CT2U1	
Dual Power Center Top - Black with Underside	CT2U1-BL - add \$2,235
Dual Power Center Top - White with Underside	CT2U1-WH - add \$2,235
Dual Power Center Top - Black with Wireless Charging	CT2U1-BLW2 - add \$3,194
Dual Power Center Top - White with Wireless Charging	CT2U1-WHW2 - add \$3,194

Note: Order power infeed that best fits application

To Order Specify

① Veneer Model #	② Edge Detail	③ Wood Collection	④ Wood Finish	⑤ Electrical	⑥ Metal Color
Veneer (LKV)	<a href="#">See Edge Detail Options</a>	Essentials	<a href="#">See Essentials Wood Finish Options</a>	N None CT2 Dual Power Center Top CU2 Dual Power Underside CT2U1 Dual Power Center Top with Underside (See chart above)	<a href="#">See Metal Finish Color Options</a>
		Artisan	④ Wood Finish <a href="#">See Artisan Wood Finish Options</a>		

LOK - CONFERENCE

Description

Rounded Arc Rectangular Table with Y Base at Counter Height

Laminate Tables  
"LKT" Models

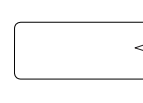
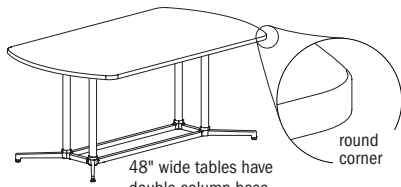

Eased Edge (R3)

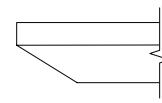

Reverse Bevel Edge (K9)

LAMINATE	D	W	H	CTN WT	CU FT	Model	Standard Tier 1	Graded In Tier 2	Standard Tier 1	Graded In Tier 2
		48	96	36	226	115	LKT4896-36ARRY	\$4,169	\$4,230	\$4,749
	48	84	36	201	101	LKT4884-36ARRY	\$3,691	\$3,747	\$4,260	\$4,315
	42	96	36	193	102	LKT4296-36ARRY	\$4,709	\$4,763	\$5,273	\$5,330
	42	84	36	172	89	LKT4284-36ARRY	\$3,219	\$3,268	\$3,775	\$3,823
	36	96	36	177	89	LKT3696-36ARRY	\$3,237	\$3,283	\$3,787	\$3,835
	36	84	36	156	78	LKT3684-36ARRY	\$2,880	\$2,921	\$3,422	\$3,464

Features:

- price reflects complete table - top and base
- ships KD in multiple cartons
- one piece top
- model includes adjustable glide

Options:

- specify power/charging option, see below for options and upcharges

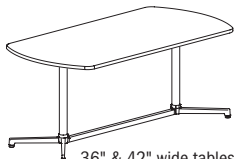

36" & 42" wide tables have single column base

LOK - CONFERENCE

To Order Specify

1 Laminite Model #	2 Edge Detail	3 Laminite Selection	3a PVC Edge Color	4 Electrical	5 Metal Color
Laminite (LKT)	<a href="#">See Edge Detail Options</a>	<a href="#">See Laminite Selection</a>	<a href="#">See PVC Edge Color Options</a>	N None CT2 Dual Power Center Top CU2 Dual Power Underside CT2U1 Dual Power Center Top with Underside (See chart on next page)	<a href="#">See Metal Finish Color Options</a>

Model Number Breakdown

LKT4896-36ARRY						
LK	T	4896	36	AR	R	Y
LOK	Laminite	48" x 96"	Height	Arc Rectangular Top Shape	Rounded Corner	Y Base

Description

Rounded Arc Rectangular Table with Y Base at Counter Height (continued)

Veneer Tables "LKV" Models      Solid Surface Tables "LKS" Models

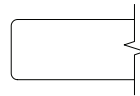

Eased Edge (R3)

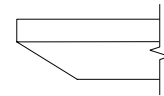

Reverse Bevel Edge (K9)

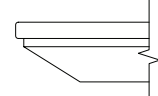

Reverse Bevel Edge (K7)

	D	W	H	CTN WT	CU FT	① Model	Veneer Tables		Solid Surface Tables		
							Essentials	Artisan	Essentials	Artisan	Standard
VENEER	48	96	36	226	115	LKV4896-36ARRY	\$5,770	\$6,187	\$6,151	\$6,542	--
	48	84	36	201	101	LKV4884-36ARRY	\$5,236	\$5,594	\$5,589	\$5,926	--
	42	96	36	193	102	LKV4296-36ARRY	\$6,745	\$7,285	\$7,352	\$7,829	--
	42	84	36	172	89	LKV4284-36ARRY	\$4,813	\$5,197	\$5,246	\$5,588	--
	36	96	36	177	89	LKV3696-36ARRY	\$4,339	\$4,687	\$4,728	\$5,036	--
	36	84	36	156	78	LKV3684-36ARRY	\$3,958	\$4,273	\$4,312	\$4,591	--
SOLID SURFACE	48	96	36	226	115	LKS4896-36ARRY	--	--	--	--	\$13,015
	48	84	36	201	101	LKS4884-36ARRY	--	--	--	--	\$11,522
	42	96	36	193	102	LKS4296-36ARRY	--	--	--	--	\$11,770
	42	84	36	172	89	LKS4284-36ARRY	--	--	--	--	\$9,459
	36	96	36	177	89	LKS3696-36ARRY	--	--	--	--	\$9,376
	36	84	36	156	78	LKS3684-36ARRY	--	--	--	--	\$8,418

Electrical Options and Upcharges

CT2	84 - 96 wide
Dual Power Center Top - Black	CT2BL - add \$1,837
Dual Power Center Top - White	CT2WH - add \$1,837
CU1	
Dual Power Underside - Black	CU1-1C - add \$731
Dual Power Underside with Wireless Charging - Black	CU1-1CW - add \$1,691
CT2U1	
Dual Power Center Top - Black with Underside	CT2U1-BL - add \$2,235
Dual Power Center Top - White with Underside	CT2U1-WH - add \$2,235
Dual Power Center Top - Black with Wireless Charging	CT2U1-BLW2 - add \$3,194
Dual Power Center Top - White with Wireless Charging	CT2U1-WHW2 - add \$3,194

Note: Order power infeed that best fits application

To Order Specify

① Veneer Model #	② Edge Detail	③ Wood Collection	④ Wood Finish	⑤ Electrical	⑥ Metal Color
Veneer (LKV)	<a href="#">See Edge Detail Options</a>	Essentials	<a href="#">See Essentials Wood Finish Options</a>	N None CT2 Dual Power Center Top CU2 Dual Power Underside CT2U1 Dual Power Center Top with Underside (See chart above)	<a href="#">See Metal Finish Color Options</a>
		Artisan	④ Wood Finish <a href="#">See Artisan Wood Finish Options</a>		

① Solid Surface Model #	② Top Surface Selection	③ Electrical	④ Metal Color
Solid Surface (LKS)	<a href="#">See Solid Surface Top Surface Selection Options</a>	N None CT2 Dual Power Center Top CU2 Dual Power Underside CT2U1 Dual Power Center Top with Underside (See chart above)	<a href="#">See Metal Finish Color Options</a>

LOK - CONFERENCE

Description

Racetrack Table with Y Base at Counter Height

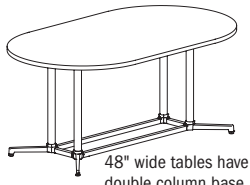

Laminate Tables "LKT" Models

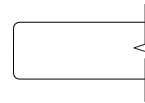

Eased Edge (R3)

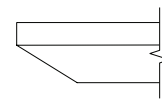

Reverse Bevel Edge (K9)

LAMINATE	D	W	H	CTN WT	CU FT	Model	Eased Edge (R3)		Reverse Bevel Edge (K9)	
							Standard Tier 1	Graded In Tier 2	Standard Tier 1	Graded In Tier 2
	48	96	36	213	115	LKT4896-36RKY	\$4,013	\$4,078	\$4,594	\$4,660
48	84	36	191	101	LKT4884-36RKY	\$3,691	\$3,747	\$4,260	\$4,315	
42	96	36	185	102	LKT4296-36RKY	\$4,709	\$4,763	\$5,273	\$5,330	
42	84	36	164	89	LKT4284-36RKY	\$3,219	\$3,268	\$3,775	\$3,823	
36	96	36	168	89	LKT3696-36RKY	\$3,237	\$3,283	\$3,787	\$3,835	
36	84	36	150	78	LKT3684-36RKY	\$2,880	\$2,921	\$3,422	\$3,464	

Features:

- price reflects complete table - top and base
- ships KD in multiple cartons
- one piece top
- model includes adjustable glide

Options:

- specify power/charging option, see below for options and upcharges

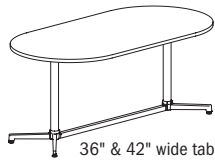

36" & 42" wide tables have single column base

LOK - CONFERENCE

To Order Specify

1 Laminite Model #	2 Edge Detail	3 Laminite Selection	3a PVC Edge Color	4 Electrical	5 Metal Color
Laminite (LKT)	<a href="#">See Edge Detail Options</a>	<a href="#">See Laminite Selection</a>	<a href="#">See PVC Edge Color Options</a>	N None CT2 Dual Power Center Top CU2 Dual Power Underside CT2U1 Dual Power Center Top with Underside (See chart on next page)	<a href="#">See Metal Finish Color Options</a>

Model Number Breakdown

LKT4896-36RKY					
LK	T	4896	36	RK	Y
LOK	Laminite	48" x 96"	Height	Racetrack Top Shape	Y Base

Description

Racetrack Table with Y Base at Counter Height (continued)

Veneer Tables "LKV" Models

Solid Surface Tables "LKS" Models

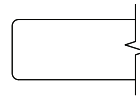

Eased Edge (R3)

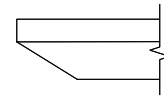

Reverse Bevel Edge (K9)

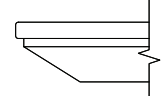

Reverse Bevel Edge (K7)

	D	W	H	CTN WT	CU FT	① Model	Veneer Tables "LKV" Models		Solid Surface Tables "LKS" Models		
							Essentials	Artisan	Essentials	Artisan	Standard
VENEER	48	96	36	213	115	LKV4896-36RKY	\$5,576	\$5,990	\$5,955	\$6,344	--
	48	84	36	191	101	LKV4884-36RKY	\$5,236	\$5,594	\$5,589	\$5,926	--
	42	96	36	185	102	LKV4296-36RKY	\$6,745	\$7,285	\$7,352	\$7,829	--
	42	84	36	164	89	LKV4284-36RKY	\$4,813	\$5,197	\$5,246	\$5,588	--
	36	96	36	168	89	LKV3696-36RKY	\$4,339	\$4,687	\$4,728	\$5,036	--
	36	84	36	150	78	LKV3684-36RKY	\$3,958	\$4,273	\$4,312	\$4,591	--
SOLID SURFACE	48	96	36	213	115	LKS4896-36RKY	--	--	--	--	\$12,817
	48	84	36	191	101	LKS4884-36RKY	--	--	--	--	\$11,522
	42	96	36	185	102	LKS4296-36RKY	--	--	--	--	\$11,770
	42	84	36	164	89	LKS4284-36RKY	--	--	--	--	\$9,459
	36	96	36	168	89	LKS3696-36RKY	--	--	--	--	\$9,376
	36	84	36	150	78	LKS3684-36RKY	--	--	--	--	\$8,418

Electrical Options and Upcharges

CT2	84 - 96 wide
Dual Power Center Top - Black	CT2BL - add \$1,837
Dual Power Center Top - White	CT2WH - add \$1,837
CU1	
Dual Power Underside - Black	CU1-1C - add \$731
Dual Power Underside with Wireless Charging - Black	CU1-1CW - add \$1,691
CT2U1	
Dual Power Center Top - Black with Underside	CT2U1-BL - add \$2,235
Dual Power Center Top - White with Underside	CT2U1-WH - add \$2,235
Dual Power Center Top - Black with Wireless Charging	CT2U1-BLW2 - add \$3,194
Dual Power Center Top - White with Wireless Charging	CT2U1-WHW2 - add \$3,194

Note: Order power infeed that best fits application

To Order Specify

① Veneer Model #	② Edge Detail	③ Wood Collection	④ Wood Finish	⑤ Electrical	⑥ Metal Color
Veneer (LKV)	<a href="#">See Edge Detail Options</a>	Essentials	<a href="#">See Essentials Wood Finish Options</a>	N None CT2 Dual Power Center Top CU2 Dual Power Underside CT2U1 Dual Power Center Top with Underside (See chart above)	<a href="#">See Metal Finish Color Options</a>
		Artisan	④ Wood Finish <a href="#">See Artisan Wood Finish Options</a>		
① Solid Surface Model #	② Top Surface Selection	③ Electrical		④ Metal Color	
Solid Surface (LKS)	<a href="#">See Solid Surface Top Surface Selection Options</a>	N None CT2 Dual Power Center Top CU2 Dual Power Underside CT2U1 Dual Power Center Top with Underside (See chart above)		<a href="#">See Metal Finish Color Options</a>	

LOK - CONFERENCE

Description

Oval Table with Y Base at Counter Height

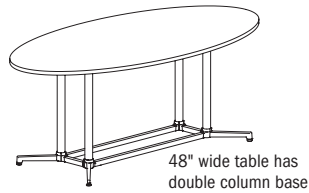

Laminate Tables "LKT" Models

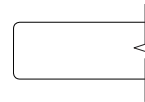

Eased Edge (R3)

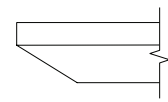

Reverse Bevel Edge (K9)

LAMINATE	D	W	H	CTN WT	CU FT	Model	Standard Tier 1	Graded In Tier 2	Standard Tier 1	Graded In Tier 2
		48	96	36	194	115	LKT4896-360VY	\$3,874	\$3,935	\$4,456
	42	84	36	150	89	LKT4284-360VY	\$3,219	\$3,268	\$3,775	\$3,823

Features:

- price reflects complete table - top and base
- ships KD in multiple cartons
- one piece top
- model includes adjustable glide

Options:

- specify power/charging option, see below for options and upcharges

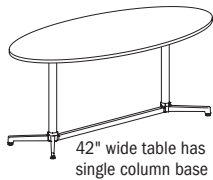

LOK - CONFERENCE

To Order Specify

1 Laminate Model #	2 Edge Detail	3 Laminate Selection	3a PVC Edge Color	4 Electrical	5 Metal Color
Laminate (LKT)	<a href="#">See Edge Detail Options</a>	<a href="#">See Laminate Selection</a>	<a href="#">See PVC Edge Color Options</a>	N None CT2 Dual Power Center Top CU2 Dual Power Underside CT2U1 Dual Power Center Top with Underside (See chart on next page)	<a href="#">See Metal Finish Color Options</a>

Model Number Breakdown

LKT4896-36RKY					
LK	T	4896	36	RK	Y
LOK	Laminate	48" x 96"	Height	Racetrack Top Shape	Y Base

Description

Oval Table with Y Base at Counter Height (continued)

Veneer Tables "LKV" Models      Solid Surface Tables "LKS" Models

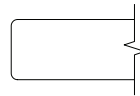

Eased Edge (R3)

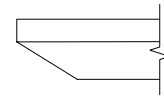

Reverse Bevel Edge (K9)

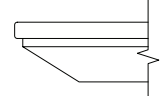

Reverse Bevel Edge (K7)

	D	W	H	CTN WT	CU FT	① Model	Veneer Tables "LKV" Models		Solid Surface Tables "LKS" Models		
							Essentials	Artisan	Essentials	Artisan	Standard
VENEER	48	96	36	194	115	LKV4896-360VY	\$5,395	\$5,809	\$5,775	\$6,163	--
	42	84	36	150	89	LKV4284-360VY	\$4,813	\$5,197	\$5,246	\$5,588	--
SOL SURF	48	96	36	194	115	LKS4896-360VY	--	--	--	--	\$12,639
	42	84	36	150	89	LKS4284-360VY	--	--	--	--	\$9,459

Electrical Options and Upcharges

CT2	84 - 96 wide
Dual Power Center Top - Black	CT2BL - add \$1,837
Dual Power Center Top - White	CT2WH - add \$1,837
CU1	
Dual Power Underside - Black	CU1-1C - add \$731
Dual Power Underside with Wireless Charging - Black	CU1-1CW - add \$1,691
CT2U1	
Dual Power Center Top - Black with Underside	CT2U1-BL - add \$2,235
Dual Power Center Top - White with Underside	CT2U1-WH - add \$2,235
Dual Power Center Top - Black with Wireless Charging	CT2U1-BLW2 - add \$3,194
Dual Power Center Top - White with Wireless Charging	CT2U1-WHW2 - add \$3,194

LOK - CONFERENCE

Note: Order power infeed that best fits application

To Order Specify

① Veneer Model #	② Edge Detail	③ Wood Collection	④ Wood Finish	⑤ Electrical	⑥ Metal Color
Veneer (LKV)	<a href="#">See Edge Detail Options</a>	Essentials	<a href="#">See Essentials Wood Finish Options</a>	N None CT2 Dual Power Center Top CU2 Dual Power Underside CT2U1 Dual Power Center Top with Underside (See chart above)	<a href="#">See Metal Finish Color Options</a>
		Artisan	④ Wood Finish <a href="#">See Artisan Wood Finish Options</a>		
① Solid Surface Model #	② Top Surface Selection	③ Electrical		④ Metal Color	
Solid Surface (LKS)	<a href="#">See Solid Surface Top Surface Selection Options</a>	N None CT2 Dual Power Center Top CU2 Dual Power Underside (See chart above) CT2U1 Dual Power Center Top with Underside		<a href="#">See Metal Finish Color Options</a>	

Description

Boat Table with T Base at Counter Height

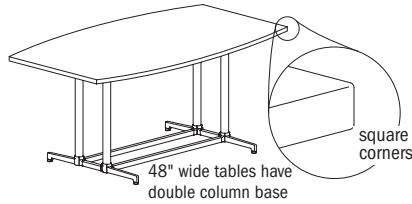

Laminate Tables  
"LKT" Models

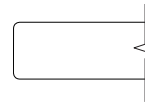

Eased Edge (R3)

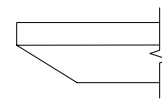

Reverse Bevel Edge (K9)

LAMINATE	D	W	H	CTN WT	CU FT	Model	Eased Edge (R3)		Reverse Bevel Edge (K9)	
							Standard	Graded In	Standard	Graded In
							Tier 1	Tier 2	Tier 1	Tier 2
	48	96	36	226	101	LKT4896-36BTT	\$4,151	\$4,214	\$4,734	\$4,796
	48	84	36	204	101	LKT4884-36BTT	\$3,775	\$3,831	\$4,343	\$4,400
	42	96	36	180	83	LKT4296-36BTT	\$3,697	\$3,755	\$4,265	\$4,321
	42	84	36	162	90	LKT4284-36BTT	\$3,079	\$3,128	\$3,634	\$3,683
	36	96	36	159	89	LKT3696-36BTT	\$3,142	\$3,188	\$3,692	\$3,737
	36	84	36	143	78	LKT3684-36BTT	\$2,838	\$2,879	\$3,377	\$3,419

Features:

- price reflects complete table - top and base
- ships KD in multiple cartons
- one piece top
- model includes adjustable glide

Options:

- specify power/charging option, see below for options and upcharges

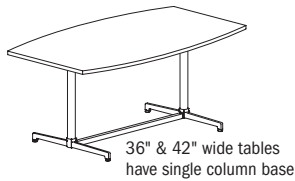

LOK - CONFERENCE

To Order Specify

1 Laminite Model #	2 Edge Detail	3 Laminite Selection	3a PVC Edge Color	4 Electrical	5 Metal Color
Laminite (LKT)	<a href="#">See Edge Detail Options</a>	<a href="#">See Laminite Selection</a>	<a href="#">See PVC Edge Color Options</a>	N None CT2 Dual Power Center Top CU2 Dual Power Underside CT2U1 Dual Power Center Top with Underside (See chart on next page)	<a href="#">See Metal Finish Color Options</a>

Model Number Breakdown

LKT4896-36BTT					
LK	T	4896	36	BT	T
LOK	Laminite	48" x 96"	Height	Boat Top Shape	T Base

Description

Boat Table with T Base at Counter Height (continued)

Veneer Tables "LKV" Models

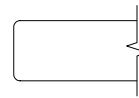

Eased Edge (R3)

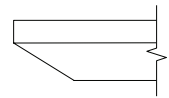

Reverse Bevel Edge (K9)

D	W	H	CTN WT	CU FT	Model	Essentials		Artisan	
						Essentials	Artisan	Essentials	Artisan
48	96	36	226	101	LKV4896-36BTT	\$5,748	\$6,168	\$6,130	\$6,514
48	84	36	204	101	LKV4884-36BTT	\$5,341	\$5,699	\$5,696	\$6,030
42	96	36	180	83	LKV4296-36BTT	\$5,485	\$5,925	\$5,977	\$6,368
42	84	36	162	90	LKV4284-36BTT	\$4,643	\$5,013	\$5,060	\$5,386
36	96	36	159	89	LKV3696-36BTT	\$4,222	\$4,563	\$4,604	\$4,901
36	84	36	143	78	LKV3684-36BTT	\$3,901	\$4,215	\$4,257	\$4,530

VENEER

Electrical Options and Upcharges

CT2	84 - 96 wide
Dual Power Center Top - Black	CT2BL - add \$1,837
Dual Power Center Top - White	CT2WH - add \$1,837
CU1	
Dual Power Underside - Black	CU1-1C - add \$731
Dual Power Underside with Wireless Charging - Black	CU1-1CW - add \$1,691
CT2U1	
Dual Power Center Top - Black with Underside	CT2U1-BL - add \$2,235
Dual Power Center Top - White with Underside	CT2U1-WH - add \$2,235
Dual Power Center Top - Black with Wireless Charging	CT2U1-BLW2 - add \$3,194
Dual Power Center Top - White with Wireless Charging	CT2U1-WhW2 - add \$3,194

Note: Order power infeed that best fits application

To Order Specify

1 Veneer Model #	2 Edge Detail	3 Wood Collection	4 Wood Finish	5 Electrical	6 Metal Color
Veneer (LKV)	<a href="#">See Edge Detail Options</a>	Essentials	<a href="#">See Essentials Wood Finish Options</a>	N None CT2 Dual Power Center Top CU2 Dual Power Underside CT2U1 Dual Power Center Top with Underside (See chart above)	<a href="#">See Metal Finish Color Options</a>
		Artisan	4 Wood Finish <a href="#">See Artisan Wood Finish Options</a>		

LOK - CONFERENCE

Description

Boat Table with Y Base at Counter Height

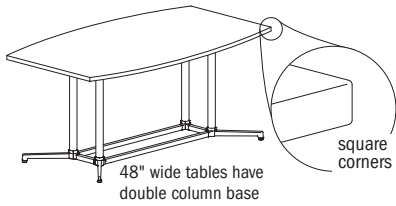

Laminate Tables  
"LKT" Models



Eased Edge (R3)

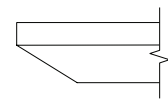

Reverse Bevel Edge (K9)

LAMINATE	D	W	H	CTN WT	CU FT	Model	Eased Edge (R3)		Reverse Bevel Edge (K9)	
							Standard Tier 1	Graded In Tier 2	Standard Tier 1	Graded In Tier 2
	48	96	36	225	115	LKT4896-36BTY	\$4,169	\$4,230	\$4,749	\$4,813
	48	84	36	204	101	LKT4884-36BTY	\$3,691	\$3,747	\$4,260	\$4,315
	42	96	36	194	102	LKT4296-36BTY	\$4,709	\$4,763	\$5,273	\$5,330
	42	84	36	172	89	LKT4284-36BTY	\$3,219	\$3,268	\$3,775	\$3,823
	36	96	36	175	89	LKT3696-36BTY	\$3,237	\$3,283	\$3,787	\$3,835
	36	84	36	153	78	LKT3684-36BTY	\$2,880	\$2,921	\$3,422	\$3,464

Features:

- price reflects complete table - top and base
- ships KD in multiple cartons
- one piece top
- model includes adjustable glide

Options:

- specify power/charging option, see below for options and upcharges

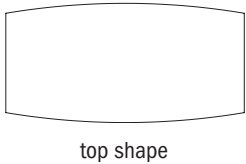
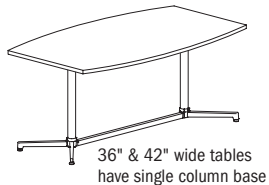

top shape

LOK - CONFERENCE

To Order Specify

1 Laminite Model #	2 Edge Detail	3 Laminite Selection	3a PVC Edge Color	4 Electrical	5 Metal Color
Laminite (LKT)	<a href="#">See Edge Detail Options</a>	<a href="#">See Laminite Selection</a>	<a href="#">See PVC Edge Color Options</a>	N None CT2 Dual Power Center Top CU2 Dual Power Underside CT2U1 Dual Power Center Top with Underside (See chart on next page)	<a href="#">See Metal Finish Color Options</a>

Model Number Breakdown

LKT4896-36BTY					
LK	T	4896	36	BT	Y
LOK	Laminite	48" x 96"	Height	Boat Top Shape	Y Base

Description

Boat Table with Y Base at Counter Height  
(continued)

Veneer Tables  
"LKV" Models

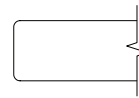

Eased Edge (R3)

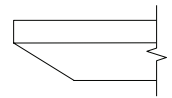

Reverse Bevel Edge (K9)

VENEER	D	W	H	CTN WT	CU FT	① Model	Essentials	Artisan	Essentials	Artisan
		48	96	36	225	115	LKV4896-36BTY	\$5,770	\$6,187	\$6,151
	48	84	36	204	101	LKV4884-36BTY	\$5,236	\$5,594	\$5,589	\$5,926
	42	96	36	194	102	LKV4296-36BTY	\$6,745	\$7,285	\$7,352	\$7,829
	42	84	36	172	89	LKV4284-36BTY	\$4,813	\$5,197	\$5,246	\$5,588
	36	96	36	175	89	LKV3696-36BTY	\$4,339	\$4,687	\$4,728	\$5,036
	36	84	36	153	78	LKV3684-36BTY	\$3,958	\$4,273	\$4,312	\$4,591

Electrical Options and Upcharges

CT2	84 - 96 wide
Dual Power Center Top - Black	CT2BL - add \$1,837
Dual Power Center Top - White	CT2WH - add \$1,837
CU1	
Dual Power Underside - Black	CU1-1C - add \$731
Dual Power Underside with Wireless Charging - Black	CU1-1CW - add \$1,691
CT2U1	
Dual Power Center Top - Black with Underside	CT2U1-BL - add \$2,235
Dual Power Center Top - White with Underside	CT2U1-WH - add \$2,235
Dual Power Center Top - Black with Wireless Charging	CT2U1-BLW2 - add \$3,194
Dual Power Center Top - White with Wireless Charging	CT2U1-WHW2 - add \$3,194

Note: Order power infeed that best fits application

To Order Specify

① Veneer Model #	② Edge Detail	③ Wood Collection	④ Wood Finish	⑤ Electrical	⑥ Metal Color
Veneer (LKV)	<a href="#">See Edge Detail Options</a>	Essentials	<a href="#">See Essentials Wood Finish Options</a>	N None CT2 Dual Power Center Top CU2 Dual Power Underside CT2U1 Dual Power Center Top with Underside (See chart above)	<a href="#">See Metal Finish Color Options</a>
		Artisan	④ Wood Finish <a href="#">See Artisan Wood Finish Options</a>		

Description

Rounded Double Chevron Table with T Base at Counter Height

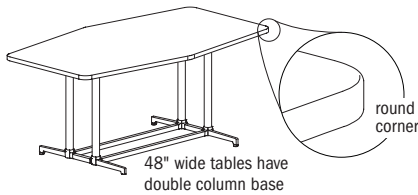

Laminate Tables "LKT" Models

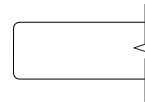

Eased Edge (R3)

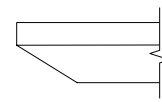

Reverse Bevel Edge (K9)

LAMINATE	D	W	H	CTN WT	CU FT	Model	Eased Edge (R3)		Reverse Bevel Edge (K9)	
							Standard Tier 1	Graded In Tier 2	Standard Tier 1	Graded In Tier 2
	48	96	36	211	115	LKT4896-36DCRT	\$4,151	\$4,214	\$4,734	\$4,796
	48	84	36	189	101	LKT4884-36DCRT	\$3,775	\$3,831	\$4,343	\$4,400
	42	96	36	165	83	LKT4296-36DCRT	\$3,697	\$3,755	\$4,265	\$4,321
	42	84	36	146	90	LKT4284-36DCRT	\$3,079	\$3,128	\$3,634	\$3,683
	36	96	36	149	89	LKT3696-36DCRT	\$3,142	\$3,188	\$3,692	\$3,737
	36	84	36	142	78	LKT3684-36DCRT	\$2,838	\$2,879	\$3,377	\$3,419

Features:

- price reflects complete table - top and base
- ships KD in multiple cartons
- one piece top
- model includes adjustable glide

Options:

- specify power/charging option, see below for options and upcharges

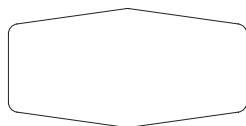
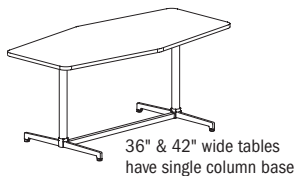

top shape

LOK - CONFERENCE

To Order Specify

1 Laminite Model #	2 Edge Detail	3 Laminite Selection	3a PVC Edge Color	4 Electrical	5 Metal Color
Laminite (LKT)	<a href="#">See Edge Detail Options</a>	<a href="#">See Laminite Selection</a>	<a href="#">See PVC Edge Color Options</a>	N None CT2 Dual Power Center Top CU2 Dual Power Underside CT2U1 Dual Power Center Top with Underside (See chart on next page)	<a href="#">See Metal Finish Color Options</a>

Model Number Breakdown

LKT4896-36DCRT						
LK	T	4896	36	DC	R	T
LOK	Laminite	48" x 96"	Height	Double Chevron Top Shape	Rounded Corner	T Base

Description

Rounded Double Chevron Table with T Base at Counter Height (continued)

Veneer Tables "LKV" Models      Solid Surface Tables "LKS" Models

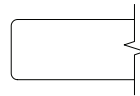

Eased Edge (R3)

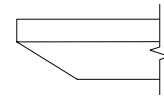

Reverse Bevel Edge (K9)

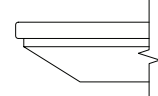

Reverse Bevel Edge (K7)

	D	W	H	CTN WT	CU FT	① Model	Veneer		Solid Surface		
							Essentials	Artisan	Essentials	Artisan	Standard
VENEER	48	96	36	211	115	LKV4896-36DCRT	\$5,748	\$6,168	\$6,130	\$6,514	--
	48	84	36	189	101	LKV4884-36DCRT	\$5,341	\$5,699	\$5,696	\$6,030	--
	42	96	36	165	83	LKV4296-36DCRT	\$5,485	\$5,925	\$5,977	\$6,368	--
	42	84	36	146	90	LKV4284-36DCRT	\$4,643	\$5,013	\$5,060	\$5,386	--
	36	96	36	149	89	LKV3696-36DCRT	\$4,222	\$4,563	\$4,604	\$4,901	--
	36	84	36	142	78	LKV3684-36DCRT	\$3,901	\$4,215	\$4,257	\$4,530	--
SOLID SURFACE	48	96	36	211	115	LKS4896-36DCRT	--	--	--	--	\$12,994
	48	84	36	189	101	LKS4884-36DCRT	--	--	--	--	\$11,627
	42	96	36	165	83	LKS4296-36DCRT	--	--	--	--	\$10,507
	42	84	36	146	90	LKS4284-36DCRT	--	--	--	--	\$9,287
	36	96	36	149	89	LKS3696-36DCRT	--	--	--	--	\$9,259
	36	84	36	142	78	LKS3684-36DCRT	--	--	--	--	\$8,366

Electrical Options and Upcharges

CT2	84 - 96 wide
Dual Power Center Top - Black	CT2BL - add \$1,837
Dual Power Center Top - White	CT2WH - add \$1,837
CU1	
Dual Power Underside - Black	CU1-1C - add \$731
Dual Power Underside with Wireless Charging - Black	CU1-1CW - add \$1,691
CT2U1	
Dual Power Center Top - Black with Underside	CT2U1-BL - add \$2,235
Dual Power Center Top - White with Underside	CT2U1-WH - add \$2,235
Dual Power Center Top - Black with Wireless Charging	CT2U1-BLW2 - add \$3,194
Dual Power Center Top - White with Wireless Charging	CT2U1-WHW2 - add \$3,194

Note: Order power infeed that best fits application

To Order Specify

① Veneer Model #	② Edge Detail	③ Wood Collection	④ Wood Finish	⑤ Electrical	⑥ Metal Color
Veneer (LKV)	<a href="#">See Edge Detail Options</a>	Essentials	<a href="#">See Essentials Wood Finish Options</a>	N None CT2 Dual Power Center Top CU2 Dual Power Underside CT2U1 Dual Power Center Top with Underside (See chart above)	<a href="#">See Metal Finish Color Options</a>
		Artisan	④ Wood Finish <a href="#">See Artisan Wood Finish Options</a>		

① Solid Surface Model #	② Top Surface Selection	③ Electrical	④ Metal Color
Solid Surface (LKS)	<a href="#">See Solid Surface Top Surface Selection Options</a>	N None CT2 Dual Power Center Top CU2 Dual Power Underside CT2U1 Dual Power Center Top with Underside (See chart above)	<a href="#">See Metal Finish Color Options</a>

LOK - CONFERENCE

Description

Rounded Double Chevron Table with Y Base at Counter Height

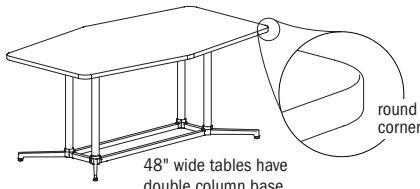

Laminate Tables "LKT" Models

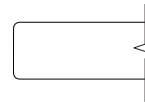

Eased Edge (R3)

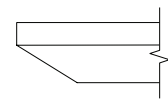

Reverse Bevel Edge (K9)

LAMINATE	D	W	H	CTN WT	CU FT	Model	Eased Edge (R3)		Reverse Bevel Edge (K9)	
							Standard Tier 1	Graded In Tier 2	Standard Tier 1	Graded In Tier 2
	48	96	36	206	115	LKT4896-36DCRY	\$4,169	\$4,230	\$4,749	\$4,813
48	84	36	188	101	LKT4884-36DCRY	\$3,691	\$3,747	\$4,260	\$4,315	
42	96	36	172	102	LKT4296-36DCRY	\$4,709	\$4,763	\$5,273	\$5,330	
42	84	36	156	89	LKT4284-36DCRY	\$3,219	\$3,268	\$3,775	\$3,823	
36	96	36	175	89	LKT3696-36DCRY	\$3,237	\$3,283	\$3,787	\$3,835	
36	84	36	144	78	LKT3684-36DCRY	\$2,880	\$2,921	\$3,422	\$3,464	

Features:

- price reflects complete table - top and base
- ships KD in multiple cartons
- one piece top
- model includes adjustable glide

Options:

- specify power/charging option, see below for options and upcharges

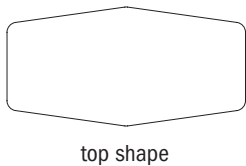
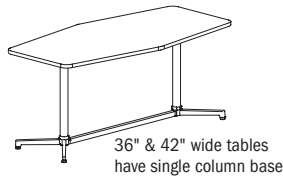

LOK - CONFERENCE

To Order Specify

1 Laminite Model #	2 Edge Detail	3 Laminite Selection	3a PVC Edge Color	4 Electrical	5 Metal Color
Laminite (LKT)	<a href="#">See Edge Detail Options</a>	<a href="#">See Laminite Selection</a>	<a href="#">See PVC Edge Color Options</a>	N None CT2 Dual Power Center Top CU2 Dual Power Underside CT2U1 Dual Power Center Top with Underside (See chart on next page)	<a href="#">See Metal Finish Color Options</a>

Model Number Breakdown

LKT4896-36DCRY						
LK	T	4896	36	DC	R	Y
LOK	Laminite	48" x 96"	Height	Double Chevron Top Shape	Rounded Corner	Y Base

Description

Rounded Double Chevron Table with Y Base at Counter Height (continued)

Veneer Tables "LKV" Models      Solid Surface Tables "LKS" Models

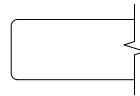

Eased Edge (R3)

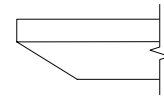

Reverse Bevel Edge (K9)

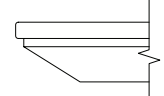

Reverse Bevel Edge (K7)

	D	W	H	CTN WT	CU FT	① Model	Veneer Tables		Solid Surface Tables		
							Essentials	Artisan	Essentials	Artisan	Standard
VENEER	48	96	36	206	115	LKV4896-36DCRY	\$5,770	\$6,187	\$6,151	\$6,542	--
	48	84	36	188	101	LKV4884-36DCRY	\$5,236	\$5,594	\$5,589	\$5,926	--
	42	96	36	172	102	LKV4296-36DCRY	\$6,745	\$7,285	\$7,352	\$7,829	--
	42	84	36	156	89	LKV4284-36DCRY	\$4,813	\$5,197	\$5,246	\$5,588	--
	36	96	36	175	89	LKV3696-36DCRY	\$4,339	\$4,687	\$4,728	\$5,036	--
	36	84	36	144	78	LKV3684-36DCRY	\$3,958	\$4,273	\$4,312	\$4,591	--
SOLID SURFACE	48	96	36	206	115	LKS4896-36DCRY	--	--	--	--	\$13,015
	48	84	36	188	101	LKS4884-36DCRY	--	--	--	--	\$11,522
	42	96	36	172	102	LKS4296-36DCRY	--	--	--	--	\$11,770
	42	84	36	156	89	LKS4284-36DCRY	--	--	--	--	\$9,459
	36	96	36	175	89	LKS3696-36DCRY	--	--	--	--	\$9,376
	36	84	36	144	78	LKS3684-36DCRY	--	--	--	--	\$8,418

Electrical Options and Upcharges

CT2	84 - 96 wide
Dual Power Center Top - Black	CT2BL - add \$1,837
Dual Power Center Top - White	CT2WH - add \$1,837
CU1	
Dual Power Underside - Black	CU1-1C - add \$731
Dual Power Underside with Wireless Charging - Black	CU1-1CW - add \$1,691
CT2U1	
Dual Power Center Top - Black with Underside	CT2U1-BL - add \$2,235
Dual Power Center Top - White with Underside	CT2U1-WH - add \$2,235
Dual Power Center Top - Black with Wireless Charging	CT2U1-BLW2 - add \$3,194
Dual Power Center Top - White with Wireless Charging	CT2U1-WHW2 - add \$3,194

Note: Order power infeed that best fits application

To Order Specify

① Veneer Model #	② Edge Detail	③ Wood Collection	④ Wood Finish	⑤ Electrical	⑥ Metal Color
Veneer (LKV)	<a href="#">See Edge Detail Options</a>	Essentials	<a href="#">See Essentials Wood Finish Options</a>	N None CT2 Dual Power Center Top CU2 Dual Power Underside CT2U1 Dual Power Center Top with Underside (See chart above)	<a href="#">See Metal Finish Color Options</a>
		Artisan	④ Wood Finish <a href="#">See Artisan Wood Finish Options</a>		

① Solid Surface Model #	② Top Surface Selection	③ Electrical	④ Metal Color
Solid Surface (LKS)	<a href="#">See Solid Surface Top Surface Selection Options</a>	N None CT2 Dual Power Center Top CU2 Dual Power Underside CT2U1 Dual Power Center Top with Underside (See chart above)	<a href="#">See Metal Finish Color Options</a>

LOK - CONFERENCE

Description

Taper Table with T Base at Counter Height

Laminate Tables  
"LKT" Models

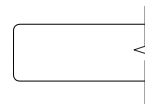
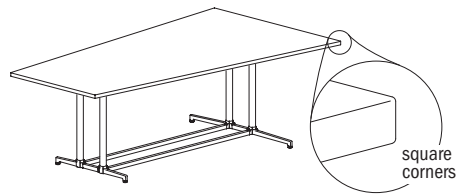

Eased Edge (R3)

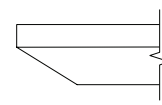

Reverse Bevel Edge (K9)

LAMI	D	W	H	CTN WT	CU FT	Model	Standard Tier 1	Graded In Tier 2	Standard Tier 1	Graded In Tier 2
		54	96	36	222	127	LKT5496-36TPT	\$4,434	\$4,506	\$5,033

Features:

- price reflects complete table - top and base
- ships KD in multiple cartons
- one piece top
- model includes adjustable glide

Options:

- specify power/charging option, see below for options and upcharges

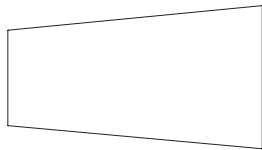

top shape

LOK - CONFERENCE

To Order Specify

1 Laminate Model #	2 Edge Detail	3 Laminate Selection	3a PVC Edge Color	4 Electrical	5 Metal Color
Laminate (LKT)	<a href="#">See Edge Detail Options</a>	<a href="#">See Laminate Selection</a>	<a href="#">See PVC Edge Color Options</a>	N None CT2 Dual Power Center Top CU2 Dual Power Underside CT2U1 Dual Power Center Top with Underside (See chart on next page)	<a href="#">See Metal Finish Color Options</a>

Model Number Breakdown

LKT5496-36TPT					
LK	T	5496	36	TP	T
LOK	Laminate	54" x 96"	Height	Taper Top Shape	T Base

Description

Taper Table with T Base at Counter Height (continued)

Veneer Tables "LKV" Models

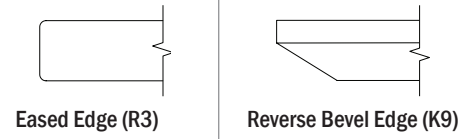

	D	W	H	CTN WT	CU FT	① Model	Essentials	Artisan	Essentials	Artisan
VEN.	54	96	36	222	127	LKV5496-36TPT	\$6,060	\$6,544	\$6,604	\$7,035

Electrical Options and Upcharges

	84 - 96 wide
<b>CT2</b>	
Dual Power Center Top - Black	CT2BL - add \$1,837
Dual Power Center Top - White	CT2WH - add \$1,837
<b>CU1</b>	
Dual Power Underside - Black	CU1-1C - add \$731
Dual Power Underside with Wireless Charging - Black	CU1-1CW - add \$1,691
<b>CT2U1</b>	
Dual Power Center Top - Black with Underside	CT2U1-BL - add \$2,235
Dual Power Center Top - White with Underside	CT2U1-WH - add \$2,235
Dual Power Center Top - Black with Wireless Charging	CT2U1-BLW2 - add \$3,194
Dual Power Center Top - White with Wireless Charging	CT2U1-WHW2 - add \$3,194

Note: Order power infeed that best fits application

To Order Specify

① Veneer Model #	② Edge Detail	③ Wood Collection	④ Wood Finish	⑤ Electrical	⑥ Metal Color
Veneer (LKV)	<a href="#">See Edge Detail Options</a>	Essentials	<a href="#">See Essentials Wood Finish Options</a>	N None CT2 Dual Power Center Top CU2 Dual Power Underside CT2U1 Dual Power Center Top with Underside (See chart above)	<a href="#">See Metal Finish Color Options</a>
		Artisan	④ Wood Finish <a href="#">See Artisan Wood Finish Options</a>		

LOK- CONFERENCE

Description

Rounded Taper Table with T Base at Counter Height

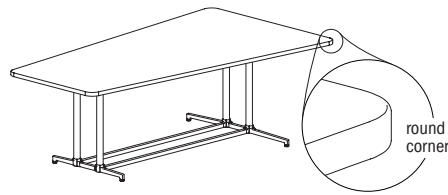

Laminate Tables "LKT" Models

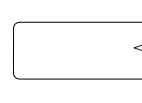

Eased Edge (R3)

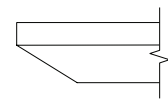

Reverse Bevel Edge (K9)

LAMI	D	W	H	CTN WT	CU FT	Model	Standard Tier 1	Graded In Tier 2	Standard Tier 1	Graded In Tier 2
		54	96	36	222	127	LKT5496-36TPRT	\$4,434	\$4,506	\$5,033

Features:

- price reflects complete table - top and base
- ships KD in multiple cartons
- one piece top
- model includes adjustable glide

Options:

- specify power/charging option, see below for options and upcharges

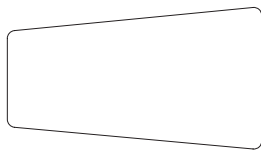

top shape

LOK - CONFERENCE

To Order Specify

1 Laminate Model #	2 Edge Detail	3 Laminate Selection	3a PVC Edge Color	4 Electrical	5 Metal Color
Laminate (LKT)	<a href="#">See Edge Detail Options</a>	<a href="#">See Laminate Selection</a>	<a href="#">See PVC Edge Color Options</a>	N None CT2 Dual Power Center Top CU2 Dual Power Underside CT2U1 Dual Power Center Top with Underside (See chart on next page)	<a href="#">See Metal Finish Color Options</a>

Model Number Breakdown

LKT5496-36TPRT						
LK	T	4896	36	TP	R	T
LOK	Laminate	48" x 96"	Height	Taper Top Shape	Rounded Corner	T Base

Description

Rounded Taper Table with T Base at Counter Height (continued)

Veneer Tables "LKV" Models      Solid Surface Tables "LKS" Models

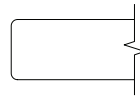

Eased Edge (R3)

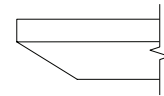

Reverse Bevel Edge (K9)

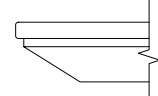

Reverse Bevel Edge (K7)

	D	W	H	CTN WT	CU FT	Model	Essentials	Artisan	Essentials	Artisan	Standard
VEN.	54	96	36	222	127	LKV5496-36TPRT	\$6,060	\$6,544	\$6,604	\$7,035	--
S.S.	54	96	36	222	127	LKS5496-36TPRT	--	--	--	--	\$16,884

Electrical Options and Upcharges

CT2	84 - 96 wide
Dual Power Center Top - Black	CT2BL - add \$1,837
Dual Power Center Top - White	CT2WH - add \$1,837
CU1	
Dual Power Underside - Black	CU1-1C - add \$731
Dual Power Underside with Wireless Charging - Black	CU1-1CW - add \$1,691
CT2U1	
Dual Power Center Top - Black with Underside	CT2U1-BL - add \$2,235
Dual Power Center Top - White with Underside	CT2U1-WH - add \$2,235
Dual Power Center Top - Black with Wireless Charging	CT2U1-BLW2 - add \$3,194
Dual Power Center Top - White with Wireless Charging	CT2U1-WHW2 - add \$3,194

Note: Order power infeed that best fits application

To Order Specify

1 Veneer Model #	2 Edge Detail	3 Wood Collection	4 Wood Finish	5 Electrical	6 Metal Color
Veneer (LKV)	<a href="#">See Edge Detail Options</a>	Essentials	<a href="#">See Essentials Wood Finish Options</a>	N None CT2 Dual Power Center Top CU2 Dual Power Underside CT2U1 Dual Power Center Top with Underside (See chart above)	<a href="#">See Metal Finish Color Options</a>
		Artisan	4 Wood Finish <a href="#">See Artisan Wood Finish Options</a>		

1 Solid Surface Model #	2 Top Surface Selection	3 Electrical	4 Metal Color
Solid Surface (LKS)	<a href="#">See Solid Surface Top Surface Selection Options</a>	N None CT2 Dual Power Center Top CU2 Dual Power Underside CT2U1 Dual Power Center Top with Underside (See chart above)	<a href="#">See Metal Finish Color Options</a>

LOK - CONFERENCE

Description

Taper Table with Y Base at Counter Height

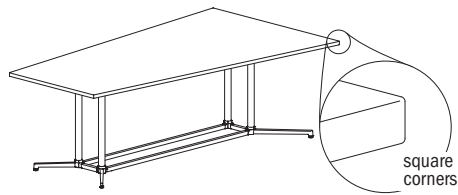

Laminate Tables  
"LKT" Models

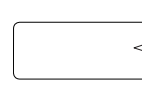

Eased Edge (R3)

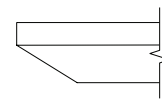

Reverse Bevel Edge (K9)

LAMI	D	W	H	CTN WT	CU FT	1 Model	Standard Tier 1	Graded In Tier 2	Standard Tier 1	Graded In Tier 2
		54	96	36	198	127	LKT5496-36TPY	\$4,197	\$4,267	\$4,794

Features:

- price reflects complete table - top and base
- ships KD in multiple cartons
- one piece top
- model includes adjustable glide

Options:

- specify power/charging option, see below for options and upcharges

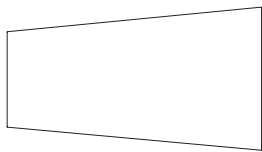

top shape

LOK - CONFERENCE

To Order Specify

1 Laminate Model #	2 Edge Detail	3 Laminate Selection	3a PVC Edge Color	4 Electrical	5 Metal Color
Laminate (LKT)	<a href="#">See Edge Detail Options</a>	<a href="#">See Laminate Selection</a>	<a href="#">See PVC Edge Color Options</a>	N None CT2 Dual Power Center Top CU2 Dual Power Underside CT2U1 Dual Power Center Top with Underside (See chart on next page)	<a href="#">See Metal Finish Color Options</a>

Model Number Breakdown

LKT4896-36TPY					
LK	T	4896	36	TP	Y
LOK	Laminate	48" x 96"	Height	Taper Top Shape	Y Base

Description

Taper Table with Y Base at Counter Height  
(continued)

Veneer Tables "LKV" Models

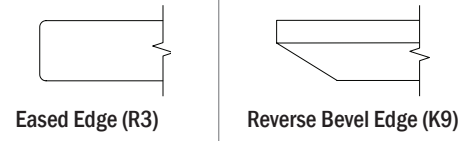

	D	W	H	CTN WT	CU FT	① Model	Essentials	Artisan	Essentials	Artisan
VEN.	54	96	36	198	127	LKV5496-36TPY	\$5,769	\$6,229	\$6,290	\$6,697

Electrical Options and Upcharges

	84 - 96 wide
<b>CT2</b>	
Dual Power Center Top - Black	CT2BL - add \$1,837
Dual Power Center Top - White	CT2WH - add \$1,837
<b>CU1</b>	
Dual Power Underside - Black	CU1-1C - add \$731
Dual Power Underside with Wireless Charging - Black	CU1-1CW - add \$1,691
<b>CT2U1</b>	
Dual Power Center Top - Black with Underside	CT2U1-BL - add \$2,235
Dual Power Center Top - White with Underside	CT2U1-WH - add \$2,235
Dual Power Center Top - Black with Wireless Charging	CT2U1-BLW2 - add \$3,194
Dual Power Center Top - White with Wireless Charging	CT2U1-WHW2 - add \$3,194

Note: Order power infeed that best fits application

To Order Specify

① Veneer Model #	② Edge Detail	③ Wood Collection	④ Wood Finish	⑤ Electrical	⑥ Metal Color
Veneer (LKV)	<a href="#">See Edge Detail Options</a>	Essentials	<a href="#">See Essentials Wood Finish Options</a>	N None CT2 Dual Power Center Top CU2 Dual Power Underside CT2U1 Dual Power Center Top with Underside (See chart above)	<a href="#">See Metal Finish Color Options</a>
		Artisan	④ Wood Finish <a href="#">See Artisan Wood Finish Options</a>		

LOK- CONFERENCE

Description

Rounded Taper Table with Y Base at Counter Height

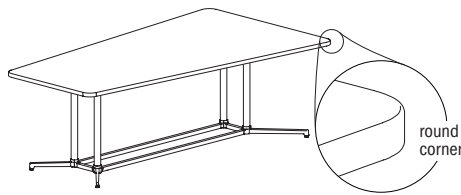

Laminate Tables "LKT" Models

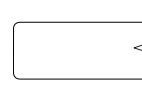

Eased Edge (R3)

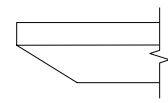

Reverse Bevel Edge (K9)

LAMI	D	W	H	CTN WT	CU FT	Model	Standard Tier 1	Graded In Tier 2	Standard Tier 1	Graded In Tier 2
		54	96	36	198	127	LKT5496-36TPRY	\$4,197	\$4,267	\$4,794

Features:

- price reflects complete table - top and base
- ships KD in multiple cartons
- one piece top
- model includes adjustable glide

Options:

- specify power/charging option, see below for options and upcharges

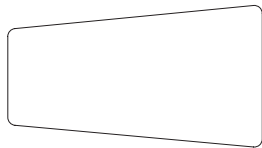

top shape

LOK - CONFERENCE

To Order Specify

1 Laminates Model #	2 Edge Detail	3 Laminates Selection	3a PVC Edge Color	4 Electrical	5 Metal Color
Laminates (LKT)	<a href="#">See Edge Detail Options</a>	<a href="#">See Laminates Selection</a>	<a href="#">See PVC Edge Color Options</a>	N None CT2 Dual Power Center Top CU2 Dual Power Underside CT2U1 Dual Power Center Top with Underside (See chart on next page)	<a href="#">See Metal Finish Color Options</a>

Model Number Breakdown

LKT5496-36TPRY						
LK	T	4896	36	TP	R	Y
LOK	Laminates	48" x 96"	Height	Taper Top Shape	Rounded Corner	Y Base

Description

Rounded Taper Table with Y Base at Counter Height (continued)

Veneer Tables "LKV" Models	Solid Surface Tables "LKS" Models
----------------------------	-----------------------------------

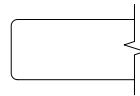

Eased Edge (R3)

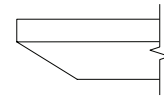

Reverse Bevel Edge (K9)

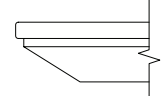

Reverse Bevel Edge (K7)

	D	W	H	CTN WT	CU FT	Model	Essentials	Artisan	Essentials	Artisan	Standard
VEN.	54	96	36	198	127	LKV5496-36TPRY	\$5,769	\$6,229	\$6,290	\$6,697	--
S.S.	54	96	36	198	127	LKS5496-36TPRY	--	--	--	--	\$16,592

Electrical Options and Upcharges

<b>CT2</b>	84 - 96 wide
Dual Power Center Top - Black	CT2BL - add \$1,837
Dual Power Center Top - White	CT2WH - add \$1,837
<b>CU1</b>	
Dual Power Underside - Black	CU1-1C - add \$731
Dual Power Underside with Wireless Charging - Black	CU1-1CW - add \$1,691
<b>CT2U1</b>	
Dual Power Center Top - Black with Underside	CT2U1-BL - add \$2,235
Dual Power Center Top - White with Underside	CT2U1-WH - add \$2,235
Dual Power Center Top - Black with Wireless Charging	CT2U1-BLW2 - add \$3,194
Dual Power Center Top - White with Wireless Charging	CT2U1-WHW2 - add \$3,194

Note: Order power infeed that best fits application

To Order Specify

1 Veneer Model #	2 Edge Detail	3 Wood Collection	4 Wood Finish	5 Electrical	6 Metal Color
Veneer (LKV)	<a href="#">See Edge Detail Options</a>	Essentials	<a href="#">See Essentials Wood Finish Options</a>	N None CT2 Dual Power Center Top CU2 Dual Power Underside CT2U1 Dual Power Center Top with Underside (See chart above)	<a href="#">See Metal Finish Color Options</a>
		Artisan	<b>4 Wood Finish</b> <a href="#">See Artisan Wood Finish Options</a>		

1 Solid Surface Model #	2 Top Surface Selection	3 Electrical	4 Metal Color
Solid Surface (LKS)	<a href="#">See Solid Surface Top Surface Selection Options</a>	N None CT2 Dual Power Center Top CU2 Dual Power Underside CT2U1 Dual Power Center Top with Underside (See chart above)	<a href="#">See Metal Finish Color Options</a>

LOK - CONFERENCE

Description

Round Table with X Base  
at Counter Height



Laminate Tables  
"LKT" Models

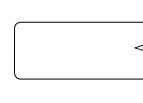

Eased Edge (R3)

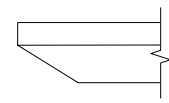

Reverse Bevel Edge (K9)

LAMINATE	D	W	H	CTN WT	CU FT	1 Model	Eased Edge (R3)		Reverse Bevel Edge (K9)	
							Standard	Graded In	Standard	Graded In
							Tier 1	Tier 2	Tier 1	Tier 2
	48	48	36	88	37	LKT48-36RDX	\$2,075	\$2,223	\$2,637	\$2,781
	42	42	36	74	35	LKT42-36RDX	\$1,908	\$2,053	\$2,470	\$2,613
	36	36	36	60	33	LKT36-36RDX	\$1,847	\$1,904	\$2,411	\$2,465
	30	30	36	48	30	LKT30-36RDX	\$1,786	\$1,830	\$2,349	\$2,391

Features:

- price reflects complete table - top and base
- ships KD in multiple cartons
- one piece top
- model includes adjustable glide
- when electrical option is selected, power accessible base is shipped; see page 178 for details
- power/charging units have 72" cord
- power cord is routed inside base column

Options:

- specify power access base with power unit option; None (N), add \$735 for EC23 (CTEC23), add \$616 for EC24 (CTEC24)

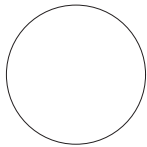

top shape

LOK - CONFERENCE

To Order Specify

1 Laminate Model #	2 Edge Detail	3 Laminate Selection	3a PVC Edge Color	4 Electrical	5 Metal Color
Laminate (LKT)	<a href="#">See Edge Detail Options</a>	<a href="#">See Laminate Selection</a>	<a href="#">See PVC Edge Color Options</a>	N None CTEC23 Power Center Top CTEC24 Power Center Top (See chart on next page)	<a href="#">See Metal Finish Color Options</a>

Model Number Breakdown

LKT48-36RDX					
LK	T	48	36	RD	X
LOK	Laminate	48" dia.	Height	Round Top Shape	X Base

Description

Round Table with X Base  
at Counter Height  
(continued)

Veneer Tables  
"LKV" Models

Solid Surface Tables  
"LKS" Models

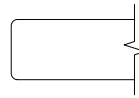

Eased Edge (R3)

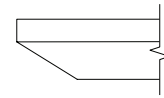

Reverse Bevel Edge (K9)

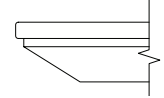

Reverse Bevel Edge (K7)

	D	W	H	CTN WT	CU FT	① Model	Veneer Tables "LKV" Models		Solid Surface Tables "LKS" Models		
							Essentials	Artisan	Essentials	Artisan	Standard
VENEER	48	48	36	88	37	LKV48-36RDX	\$2,733	\$2,913	\$2,839	\$3,025	--
	42	42	36	74	35	LKV42-36RDX	\$2,507	\$2,674	\$2,604	\$2,774	--
	36	36	36	60	33	LKV36-36RDX	\$2,432	\$2,594	\$2,525	\$2,691	--
	30	30	36	48	30	LKV30-36RDX	\$2,348	\$2,502	\$2,438	\$2,597	--
SOLID SURFACE	48	48	36	118	37	LKS48-36RDX	--	--	--	--	\$6,354
	42	42	36	95	35	LKS42-36RDX	--	--	--	--	\$5,420
	36	36	36	76	33	LKS36-36RDX	--	--	--	--	\$4,725
	30	30	36	59	30	LKS30-36RDX	--	--	--	--	\$4,117

Electrical Options and Upcharges

CTEC23	
EC23 Power Center Top - Black	CTEC23BL - add \$735
EC23 Power Center Top - White	CTEC23WH - add \$735
CTEC24	
EC24 Power Center Top - Black	CTEC43BL - add \$616
EC24 Power Center Top - White	CTEC43WH - add \$616

To Order Specify

① Veneer Model #	② Edge Detail	③ Wood Collection	④ Wood Finish	⑤ Electrical	⑥ Metal Color
Veneer (LKV)	<a href="#">See Edge Detail Options</a>	Essentials	<a href="#">See Essentials Wood Finish Options</a>	N None CTEC23 Power Center Top CTEC24 Power Center Top (See chart above)	<a href="#">See Metal Finish Color Options</a>
		Artisan	④ Wood Finish <a href="#">See Artisan Wood Finish Options</a>		

① Solid Surface Model #	② Top Surface Selection	③ Electrical Cut Out	④ Metal Color
Solid Surface (LKS)	<a href="#">See Solid Surface Top Surface Selection Options</a>	N None CTEC23 Power Center Top CTEC24 Power Center Top (See chart above)	<a href="#">See Metal Finish Color Options</a>

LOK - CONFERENCE

Description

Round Table with X4 Base at Counter Height



Laminate Tables "LKT" Models

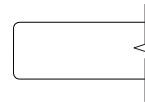

Eased Edge (R3)

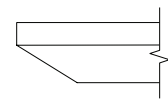

Reverse Bevel Edge (K9)

LAMINATE	D	W	H	CTN WT	CU FT	Model	Eased Edge (R3)		Reverse Bevel Edge (K9)	
							Standard	Graded In	Standard	Graded In
							Tier 1	Tier 2	Tier 1	Tier 2
	60	60	36	157	66	LKT60-36RDZ	\$3,457	\$3,572	\$4,019	\$4,135
	54	54	36	215	63	LKT54-36RDZ	\$3,230	\$3,318	\$3,790	\$3,879

Features:

- price reflects complete table - top and base
- ships KD in multiple cartons
- one piece top
- model includes adjustable glide
- power cord is routed outside base column
- order vertical wire manager separately; see page 407

Options:

- specify power unit option; None (N), add \$594 for EC23 (CTEC23), add \$474 for EC24 (CTEC24)

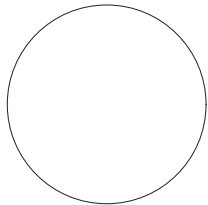

top shape

LOK - CONFERENCE

To Order Specify

1 Laminate Model #	2 Edge Detail	3 Laminate Selection	3a PVC Edge Color	4 Electrical	5 Metal Color
Laminate (LKT)	<a href="#">See Edge Detail Options</a>	<a href="#">See Laminate Selection</a>	<a href="#">See PVC Edge Color Options</a>	N None CTEC23 Power Center Top CTEC24 Power Center Top (See chart on next page)	<a href="#">See Metal Finish Color Options</a>

Model Number Breakdown

LKT60-36RDZ					
LK	T	60	36	RD	Z
LOK	Laminate	60" dia.	Height	Round Top Shape	X4 Base

Description

Round Table with X4 Base  
at Counter Height  
(continued)

Veneer Tables  
"LKV" Models

Solid Surface Tables  
"LKS" Models

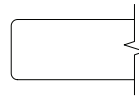

Eased Edge (R3)

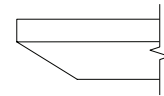

Reverse Bevel Edge (K9)

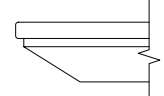

Reverse Bevel Edge (K7)

	D	W	H	CTN WT	CU FT	① Model	Veneer Tables "LKV" Models		Solid Surface Tables "LKS" Models		
							Essentials	Artisan	Essentials	Artisan	Standard
VENEER	60	60	36	215	66	LKV60-36RDZ	\$4,530	\$4,827	\$4,697	\$5,008	--
	54	54	36	186	63	LKV54-36RDZ	\$4,278	\$4,568	\$4,444	\$4,747	--
SOL SURF	60	60	36	157	66	LKS60-36RDZ	--	--	--	--	\$9,861
	54	54	36	186	63	LKS54-36RDZ	--	--	--	--	\$8,711

Electrical Options and Upcharges

CTEC23	
EC23 Power Center Top - Black	CTEC23BL - add \$594
EC23 Power Center Top - White	CTEC23WH - add \$594
CTEC24	
EC24 Power Center Top - Black	CTEC43BL - add \$474
EC24 Power Center Top - White	CTEC43WH - add \$474

To Order Specify

① Veneer Model #	② Edge Detail	③ Wood Collection	④ Wood Finish	⑤ Electrical	⑥ Metal Color
Veneer (LKV)	<a href="#">See Edge Detail Options</a>	Essentials	<a href="#">See Essentials Wood Finish Options</a>	N None CTEC23 Power Center Top CTEC24 Power Center Top (See chart above)	<a href="#">See Metal Finish Color Options</a>
		Artisan	④ Wood Finish <a href="#">See Artisan Wood Finish Options</a>		

① Solid Surface Model #	② Top Surface Selection	③ Electrical Cut Out	④ Metal Color
Solid Surface (LKS)	<a href="#">See Solid Surface Top Surface Selection Options</a>	N None CTEC23 Power Center Top CTEC24 Power Center Top (See chart above)	<a href="#">See Metal Finish Color Options</a>

LOK-CONFERENCE

Description

Square Table with X Base at Counter Height

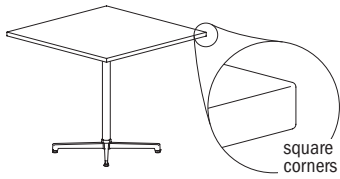

Laminate Tables "LKT" Models

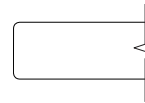

Eased Edge (R3)

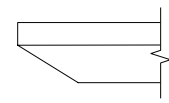

Reverse Bevel Edge (K9)

LAMINATE	D	W	H	CTN WT	CU FT	Model	Standard Tier 1	Graded In Tier 2	Standard Tier 1	Graded In Tier 2
		42	42	36	93	35	LKT4242-36SQX	\$1,953	\$2,018	\$2,517
	36	36	36	81	33	LKT3636-36SQX	\$1,738	\$1,789	\$2,298	\$2,351
	30	30	36	62	30	LKT3030-36SQX	\$1,566	\$1,606	\$2,121	\$2,166

Features:

- price reflects complete table - top and base
- ships KD in multiple cartons
- one piece top
- model includes adjustable glide
- when electrical option is selected, power accessible base is shipped; see page 178 for details
- power/charging units have 72" cord
- power cord is routed inside base column

Options:

- specify power access base with power unit option; None (N), add \$735 for EC23 (CTEC23), add \$616 for EC24 (CTEC24)

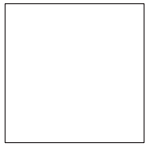

top shape

LOK - CONFERENCE

To Order Specify

1 Laminate Model #	2 Edge Detail	3 Laminate Selection	3a PVC Edge Color	4 Electrical	5 Metal Color
Laminate (LKT)	<a href="#">See Edge Detail Options</a>	<a href="#">See Laminate Selection</a>	<a href="#">See PVC Edge Color Options</a>	N None CTEC23 Power Center Top CTEC24 Power Center Top (See chart on next page)	<a href="#">See Metal Finish Color Options</a>

Model Number Breakdown

LKT4242-36SQX					
LK	T	4242	36	SQ	X
LOK	Laminate	42" x 42"	Height	Square Top Shape	X Base

Description

Square Table with X Base  
at Counter Height  
(continued)

Veneer Tables  
"LKV" Models

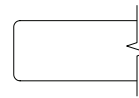

Eased Edge (R3)

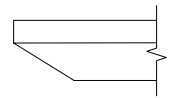

Reverse Bevel Edge (K9)

D	W	H	CTN WT	CU FT	① Model	Essentials		Artisan	
						Essentials	Artisan	Essentials	Artisan
42	42	36	93	35	LKV4242-36SQX	\$2,534	\$2,702	\$2,632	\$2,806
36	36	36	81	33	LKV3636-36SQX	\$2,250	\$2,398	\$2,335	\$2,489
30	30	36	62	30	LKV3030-36SQX	\$2,020	\$2,152	\$2,096	\$2,234

VENEER

LOK- CONFERENCE

Electrical Options and Upcharges

CTEC23	
EC23 Power Center Top - Black	CTEC23BL - add \$735
EC23 Power Center Top - White	CTEC23WH - add \$735
CTEC24	
EC24 Power Center Top - Black	CTEC43BL - add \$616
EC24 Power Center Top - White	CTEC43WH - add \$616

To Order Specify

① Veneer Model #	② Edge Detail	③ Wood Collection	④ Wood Finish	⑤ Electrical	⑥ Metal Color
Veneer (LKV)	<a href="#">See Edge Detail Options</a>	Essentials	<a href="#">See Essentials Wood Finish Options</a>	N None CTEC23 Power Center Top CTEC24 Power Center Top (See chart above)	<a href="#">See Metal Finish Color Options</a>
		Artisan	④ Wood Finish <a href="#">See Artisan Wood Finish Options</a>		

Description

Rounded Square Table with X Base at Counter Height

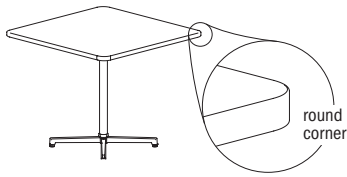

Laminate Tables  
"LKT" Models

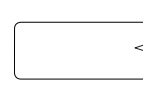

Eased Edge (R3)

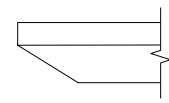

Reverse Bevel Edge (K9)

LAMINATE	D	W	H	CTN WT	CU FT	Model	Standard Tier 1	Graded In Tier 2	Standard Tier 1	Graded In Tier 2
		42	42	36	93	35	LKT4242-36SQRX	\$2,395	\$2,459	\$2,951
	36	36	36	81	33	LKT3636-36SQRX	\$1,861	\$1,912	\$2,420	\$2,474
	30	30	36	62	30	LKT3030-36SQRX	\$1,730	\$1,763	\$2,290	\$2,336

Features:

- price reflects complete table - top and base
- ships KD in multiple cartons
- one piece top
- model includes adjustable glide
- when electrical option is selected, power accessible base is shipped; see page 178 for details
- power/charging units have 72" cord
- power cord is routed inside base column

Options:

- specify power access base with power unit option; None (N), add \$735 for EC23 (CTEC23), add \$616 for EC24 (CTEC24)

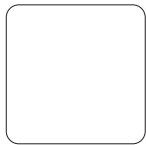

top shape

LOK - CONFERENCE

To Order Specify

1 Laminate Model #	2 Edge Detail	3 Laminate Selection	3a PVC Edge Color	4 Electrical	5 Metal Color
Laminate (LKT)	<a href="#">See Edge Detail Options</a>	<a href="#">See Laminate Selection</a>	<a href="#">See PVC Edge Color Options</a>	N None CTEC23 Power Center Top CTEC24 Power Center Top (See chart on next page)	<a href="#">See Metal Finish Color Options</a>

Model Number Breakdown

LKT4242-36SQRX						
LK	T	4242	36	SQ	R	X
LOK	Laminate	42" x 42"	Height	Square Top Shape	Rounded Corner	X Base

Description

Rounded Square Table with X Base at Counter Height (continued)

Veneer Tables "LKV" Models      Solid Surface Tables "LKS" Models

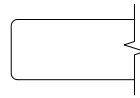

Eased Edge (R3)

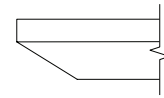

Reverse Bevel Edge (K9)

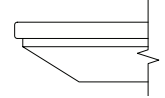

Reverse Bevel Edge (K7)

	D	W	H	CTN WT	CU FT	① Model	Veneer Tables		Solid Surface Tables		
							Essentials	Artisan	Essentials	Artisan	Standard
VENEER	42	42	36	93	35	LKV4242-36SQRX	\$3,126	\$3,334	\$3,243	\$3,464	--
	36	36	36	81	33	LKV3636-36SQRX	\$2,594	\$2,765	\$2,690	\$2,869	--
	30	30	36	62	30	LKV3030-36SQRX	\$2,319	\$2,473	\$2,409	\$2,567	--
SOLID SURFACE	42	42	36	93	35	LKS4242-36SQRX	--	--	--	--	\$6,174
	36	36	36	81	33	LKS3636-36SQRX	--	--	--	--	\$4,889
	30	30	36	62	30	LKS3030-36SQRX	--	--	--	--	\$4,090

Electrical Options and Upcharges

CTEC23	
EC23 Power Center Top - Black	CTEC23BL - add \$735
EC23 Power Center Top - White	CTEC23WH - add \$735
CTEC24	
EC24 Power Center Top - Black	CTEC43BL - add \$616
EC24 Power Center Top - White	CTEC43WH - add \$616

To Order Specify

① Veneer Model #	② Edge Detail	③ Wood Collection	④ Wood Finish	⑤ Electrical	⑥ Metal Color
Veneer (LKV)	<a href="#">See Edge Detail Options</a>	Essentials	<a href="#">See Essentials Wood Finish Options</a>	N None CTEC23 Power Center Top CTEC24 Power Center Top (See chart above)	<a href="#">See Metal Finish Color Options</a>
		Artisan	④ Wood Finish <a href="#">See Artisan Wood Finish Options</a>		

① Solid Surface Model #	② Top Surface Selection	③ Electrical Cut Out	④ Metal Color
Solid Surface (LKS)	<a href="#">See Solid Surface Top Surface Selection Options</a>	N None CTEC23 Power Center Top CTEC24 Power Center Top (See chart above)	<a href="#">See Metal Finish Color Options</a>

Description

Square Table with X4 Base at Counter Height

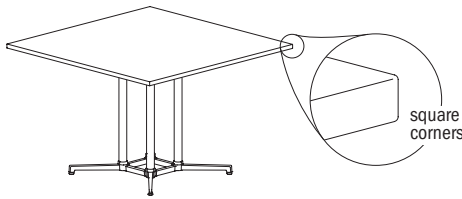

Laminate Tables "LKT" Models

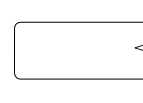

Eased Edge (R3)

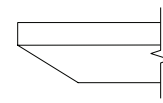

Reverse Bevel Edge (K9)

LAMINATE	D	W	H	CTN WT	CU FT	Model	Eased Edge (R3)		Reverse Bevel Edge (K9)	
							Standard	Graded In	Standard	Graded In
							Tier 1	Tier 2	Tier 1	Tier 2
	60	60	36	181	66	LKT6060-36SQZ	\$3,925	\$4,039	\$4,485	\$4,602
	54	54	36	157	63	LKT5454-36SQZ	\$3,737	\$3,838	\$4,299	\$4,400
	48	48	36	108	60	LKT4848-36SQZ	\$3,110	\$3,179	\$3,671	\$3,740

Features:

- price reflects complete table - top and base
- ships KD in multiple cartons
- one piece top
- model includes adjustable glide
- power cord is routed outside base column
- order vertical wire manager separately; see page 407

Options:

- specify power unit option; None (N), add \$594 for EC23 (CTEC23), add \$474 for EC24 (CTEC24)

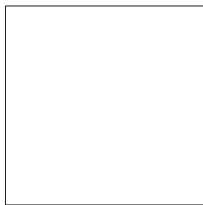

top shape

LOK - CONFERENCE

To Order Specify

1 Laminates Model #	2 Edge Detail	3 Laminates Selection	3a PVC Edge Color	4 Electrical	5 Metal Color
Laminates (LKT)	<a href="#">See Edge Detail Options</a>	<a href="#">See Laminates Selection</a>	<a href="#">See PVC Edge Color Options</a>	N None CTEC23 Power Center Top CTEC24 Power Center Top (See chart on next page)	<a href="#">See Metal Finish Color Options</a>

Model Number Breakdown

LKT6060-36SQZ					
LK	T	6060	36	SQ	Z
LOK	Laminates	60" x 60"	Height	Square Top Shape	X4 Base

Description

Square Table with X4 Base  
at Counter Height  
(continued)

Veneer Tables  
"LKV" Models

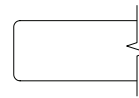

Eased Edge (R3)

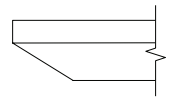

Reverse Bevel Edge (K9)

D	W	H	CTN WT	CU FT	① Model	Essentials		Artisan	
						Essentials	Artisan	Essentials	Artisan
60	60	36	181	66	LKV6060-36SQZ	\$5,083	\$5,419	\$5,274	\$5,624
54	54	36	157	63	LKV5454-36SQZ	\$4,839	\$5,158	\$5,018	\$5,350
48	48	36	108	60	LKV4848-36SQZ	\$3,744	\$3,927	\$3,850	\$4,042

VENEER

LOK - CONFERENCE

Electrical Options and Upcharges

CTEC23	
EC23 Power Center Top - Black	CTEC23BL - add \$594
EC23 Power Center Top - White	CTEC23WH - add \$594
CTEC24	
EC24 Power Center Top - Black	CTEC43BL - add \$474
EC24 Power Center Top - White	CTEC43WH - add \$474

To Order Specify

① Veneer Model #	② Edge Detail	③ Wood Collection	④ Wood Finish	⑤ Electrical	⑥ Metal Color
Veneer (LKV)	<a href="#">See Edge Detail Options</a>	Essentials	<a href="#">See Essentials Wood Finish Options</a>	N None CTEC23 Power Center Top CTEC24 Power Center Top (See chart above)	<a href="#">See Metal Finish Color Options</a>
		Artisan	④ Wood Finish <a href="#">See Artisan Wood Finish Options</a>		

Description

Rounded Square Table with X4 Base at Counter Height

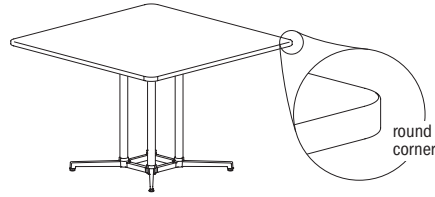

Laminate Tables "LKT" Models

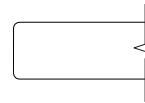

Eased Edge (R3)

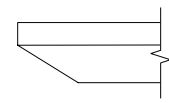

Reverse Bevel Edge (K9)

LAMINATE	D	W	H	CTN WT	CU FT	1 Model	Standard Tier 1	Graded In Tier 2	Standard Tier 1	Graded In Tier 2
		60	60	36	181	66	LKT6060-36SQRZ	\$4,168	\$4,230	\$4,898
	54	54	36	157	63	LKT5454-36SQRZ	\$3,498	\$3,599	\$4,057	\$4,159
	48	48	36	181	60	LKT4848-36SQRZ	\$3,564	\$3,636	\$4,127	\$4,197

Features:

- price reflects complete table - top and base
- ships KD in multiple cartons
- one piece top
- model includes adjustable glide
- power cord is routed outside base column
- order vertical wire manager separately; see page 407

Options:

- specify power unit option; None (N), add \$594 for EC23 (CTEC23), add \$474 for EC24 (CTEC24)

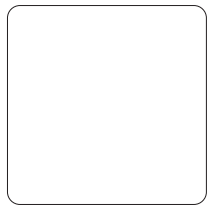

top shape

LOK - CONFERENCE

To Order Specify

1 Laminate Model #	2 Edge Detail	3 Laminate Selection	3a PVC Edge Color	4 Electrical	5 Metal Color
Laminate (LKT)	<a href="#">See Edge Detail Options</a>	<a href="#">See Laminate Selection</a>	<a href="#">See PVC Edge Color Options</a>	N None CTEC23 Power Center Top CTEC24 Power Center Top (See chart on next page)	<a href="#">See Metal Finish Color Options</a>

Model Number Breakdown

LKT6060-36SQRX						
LK	T	6060	36	SQ	R	Z
LOK	Laminate	60" x 60"	Height	Square Top Shape	Rounded Corner	X Base

Description

Rounded Square Table with X4 Base at Counter Height (continued)

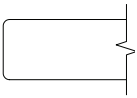
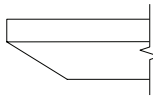
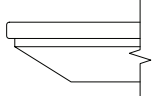
		Veneer Tables "LKV" Models				Solid Surface Tables "LKS" Models					
		 <p>Eased Edge (R3)</p>		 <p>Reverse Bevel Edge (K9)</p>		 <p>Reverse Bevel Edge (K7)</p>					
	D	W	H	CTN WT	CU FT	① Model	Essentials	Artisan	Essentials	Artisan	Standard
VENEER	60	60	36	181	66	LKV6060-36SQRZ	\$5,465	\$5,826	\$5,672	\$6,048	--
	54	54	36	157	63	LKV5454-36SQRZ	\$4,518	\$4,812	\$4,687	\$4,996	--
	48	48	36	142	60	LKV4848-36SQRZ	\$4,344	\$4,569	\$4,474	\$4,710	--
SOLID SURFACE	60	60	36	215	66	LKS6060-36SQRZ	--	--	--	--	\$10,792
	54	54	36	186	63	LKS5454-36SQRZ	--	--	--	--	\$8,947
	48	48	36	181	60	LKS4848-36SQRZ	--	--	--	--	\$7,116

Electrical Options and Upcharges

CTEC23	
EC23 Power Center Top - Black	CTEC23BL - add \$594
EC23 Power Center Top - White	CTEC23WH - add \$594
CTEC24	
EC24 Power Center Top - Black	CTEC43BL - add \$474
EC24 Power Center Top - White	CTEC43WH - add \$474

To Order Specify

① Veneer Model #	② Edge Detail	③ Wood Collection	④ Wood Finish	⑤ Electrical	⑥ Metal Color
Veneer (LKV)	<a href="#">See Edge Detail Options</a>	Essentials	<a href="#">See Essentials Wood Finish Options</a>	N None CTEC23 Power Center Top CTEC24 Power Center Top (See chart above)	<a href="#">See Metal Finish Color Options</a>
		Artisan	④ Wood Finish <a href="#">See Artisan Wood Finish Options</a>		
① Solid Surface Model #	② Top Surface Selection	③ Electrical Cut Out		④ Metal Color	
Solid Surface (LKS)	<a href="#">See Solid Surface Top Surface Selection Options</a>	N None CTEC23 Power Center Top CTEC24 Power Center Top (See chart above)		<a href="#">See Metal Finish Color Options</a>	

Description

Squircle Table with X Base at Counter Height



Laminate Tables "LKT" Models

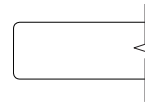

Eased Edge (R3)

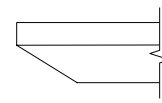

Reverse Bevel Edge (K9)

LAMINATE	D	W	H	CTN WT	CU FT	Model	Standard Tier 1	Graded In Tier 2	Standard Tier 1	Graded In Tier 2
	42	42	36	93	35	LKT42-36SCX	\$1,935	\$2,077	\$2,495	\$2,641
	36	36	36	81	33	LKT36-36SCX	\$1,873	\$1,927	\$2,438	\$2,491
	30	30	36	62	30	LKT30-36SCX	\$1,811	\$1,854	\$2,371	\$2,277

Features:

- price reflects complete table - top and base
- ships KD in multiple cartons
- one piece top
- model includes adjustable glide
- when electrical option is selected, power accessible base is shipped; see page 178 for details
- power/charging units have 72" cord
- power cord is routed inside base column

Options:

- specify power access base with power unit option; None (N), add \$735 for EC23 (CTEC23), add \$616 for EC24 (CTEC24)

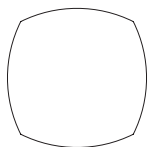

top shape

LOK - CONFERENCE

To Order Specify

1 Laminate Model #	2 Edge Detail	3 Laminate Selection	3a PVC Edge Color	4 Electrical	5 Metal Color
Laminate (LKT)	<a href="#">See Edge Detail Options</a>	<a href="#">See Laminate Selection</a>	<a href="#">See PVC Edge Color Options</a>	N None CTEC23 Power Center Top CTEC24 Power Center Top (See chart on next page)	<a href="#">See Metal Finish Color Options</a>

Model Number Breakdown

LKT42-36SCX					
LK	T	42	36	SC	X
LOK	Laminate	42" dia.	Height	Squircle Top Shape	X Base

Description

Squirrel Table with X Base at Counter Height (continued)

Veneer Tables "LKV" Models      Solid Surface Tables "LKS" Models

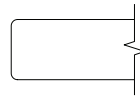

Eased Edge (R3)

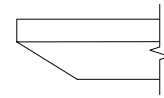

Reverse Bevel Edge (K9)

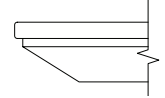

Reverse Bevel Edge (K7)

	D	W	H	CTN WT	CU FT	① Model	Veneer Tables		Solid Surface Tables		
							Essentials	Artisan	Essentials	Artisan	Standard
VENEER	42	42	36	93	35	LKV42-36SCX	\$2,534	\$2,701	\$2,632	\$2,805	--
	36	36	36	81	33	LKV36-36SCX	\$2,457	\$2,616	\$2,552	\$2,718	--
	30	30	36	62	30	LKV30-36SCX	\$2,368	\$2,525	\$2,461	\$2,621	--
SOLID SURFACE	42	42	36	93	35	LKS42-36SCX	--	--	--	--	\$5,468
	36	36	36	81	33	LKS36-36SCX	--	--	--	--	\$4,414
	30	30	36	62	30	LKS30-36SCX	--	--	--	--	\$4,605

Electrical Options and Upcharges

CTEC23	
EC23 Power Center Top - Black	CTEC23BL - add \$735
EC23 Power Center Top - White	CTEC23WH - add \$735
CTEC24	
EC24 Power Center Top - Black	CTEC43BL - add \$616
EC24 Power Center Top - White	CTEC43WH - add \$616

To Order Specify

① Veneer Model #	② Edge Detail	③ Wood Collection	④ Wood Finish	⑤ Electrical	⑥ Metal Color
Veneer (LKV)	<a href="#">See Edge Detail Options</a>	Essentials	<a href="#">See Essentials Wood Finish Options</a>	N None CTEC23 Power Center Top CTEC24 Power Center Top (See chart above)	<a href="#">See Metal Finish Color Options</a>
		Artisan	④ Wood Finish <a href="#">See Artisan Wood Finish Options</a>		

① Solid Surface Model #	② Top Surface Selection	③ Electrical Cut Out	④ Metal Color
Solid Surface (LKS)	<a href="#">See Solid Surface Top Surface Selection Options</a>	N None CTEC23 Power Center Top CTEC24 Power Center Top (See chart above)	<a href="#">See Metal Finish Color Options</a>

LOK-CONFERENCE

Description

Squircle Table with X4 Base at Counter Height



Laminate Tables "LKT" Models

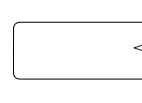

Eased Edge (R3)

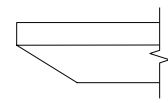

Reverse Bevel Edge (K9)

LAMINATE	D	W	H	CTN WT	CU FT	Model	Eased Edge (R3)		Reverse Bevel Edge (K9)	
							Standard Tier 1	Graded In Tier 2	Standard Tier 1	Graded In Tier 2
	60	60	36	163	66	LKT60-36SCZ	\$3,482	\$3,600	\$4,047	\$4,165
54	54	36	143	63	LKT54-36SCZ	\$3,256	\$3,345	\$3,817	\$3,908	
48	48	36	136	60	LKT48-36SCZ	\$3,095	\$3,240	\$3,655	\$3,804	

Features:

- price reflects complete table - top and base
- ships KD in multiple cartons
- one piece top
- model includes adjustable glide
- power cord is routed outside base column
- order vertical wire manager separately; see page 407

Options:

- specify power unit option; None (N), add \$594 for EC23 (CTEC23), add \$474 for EC24 (CTEC24)

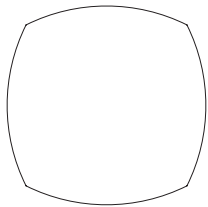

top shape

LOK - CONFERENCE

To Order Specify

1 Laminates Model #	2 Edge Detail	3 Laminates Selection	3a PVC Edge Color	4 Electrical	5 Metal Color
Laminates (LKT)	<a href="#">See Edge Detail Options</a>	<a href="#">See Laminates Selection</a>	<a href="#">See PVC Edge Color Options</a>	N None CTEC23 Power Center Top CTEC24 Power Center Top (See chart on next page)	<a href="#">See Metal Finish Color Options</a>

Model Number Breakdown

LKT60-36SCZ					
LK	T	60	36	SC	Z
LOK	Laminates	60" dia.	Height	Squircle Top Shape	X4 Base

Description

Squirrel Table with X4 Base at Counter Height (continued)

Veneer Tables "LKV" Models

Solid Surface Tables "LKS" Models

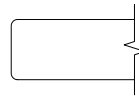

Eased Edge (R3)

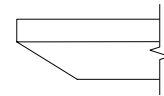

Reverse Bevel Edge (K9)

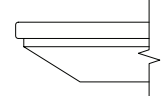

Reverse Bevel Edge (K7)

	D	W	H	CTN WT	CU FT	① Model	Veneer Tables		Solid Surface Tables		
							Essentials	Artisan	Essentials	Artisan	Standard
VENEER	60	60	36	163	66	LKV60-36SCZ	\$4,556	\$4,853	\$4,725	\$5,035	--
	54	54	36	143	63	LKV54-36SCZ	\$4,305	\$4,594	\$4,473	\$4,775	--
	48	48	36	136	60	LKV48-36SCZ	\$3,752	\$3,930	\$3,854	\$4,047	--
SOLID SURFACE	60	60	36	163	66	LKS60-36SCZ	--	--	--	--	\$9,909
	54	54	36	143	63	LKS54-36SCZ	--	--	--	--	\$9,304
	48	48	36	136	60	LKS48-36SCZ	--	--	--	--	\$7,398

Electrical Options and Upcharges

CTEC23	
EC23 Power Center Top - Black	CTEC23BL - add \$594
EC23 Power Center Top - White	CTEC23WH - add \$594
CTEC24	
EC24 Power Center Top - Black	CTEC43BL - add \$474
EC24 Power Center Top - White	CTEC43WH - add \$474

To Order Specify

① Veneer Model #	② Edge Detail	③ Wood Collection	④ Wood Finish	⑤ Electrical	⑥ Metal Color
Veneer (LKV)	<a href="#">See Edge Detail Options</a>	Essentials	<a href="#">See Essentials Wood Finish Options</a>	N None CTEC23 Power Center Top CTEC24 Power Center Top (See chart above)	<a href="#">See Metal Finish Color Options</a>
		Artisan	④ Wood Finish <a href="#">See Artisan Wood Finish Options</a>		

① Solid Surface Model #	② Top Surface Selection	③ Electrical Cut Out	④ Metal Color
Solid Surface (LKS)	<a href="#">See Solid Surface Top Surface Selection Options</a>	N None CTEC23 Power Center Top CTEC24 Power Center Top (See chart above)	<a href="#">See Metal Finish Color Options</a>

Description

Hive Table with T Base at Counter Height

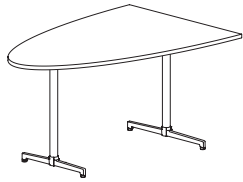

Laminate Tables  
"LKT" Models

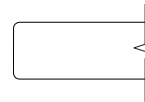

Eased Edge (R3)

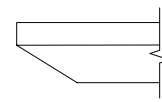

Reverse Bevel Edge (K9)

LAMI	D	W	H	CTN WT	CU FT	Model	Standard Tier 1	Graded In Tier 2	Standard Tier 1	Graded In Tier 2
		48	72	36	135	87	LKT4872-36HVT	\$2,724	\$2,777	\$3,334

Features:

- price reflects complete table - top and base
- ships KD in multiple cartons
- model includes adjustable glide

Options:

- specify power/charging option, see below for options and upcharges

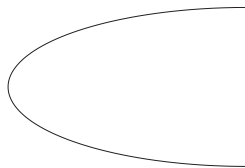

top shape

LOK - CONFERENCE

To Order Specify

1 Laminate Model #	2 Edge Detail	3 Laminate Selection	3a PVC Edge Color	4 Electrical
Laminate (LKT)	<a href="#">See Edge Detail Options</a>	<a href="#">See Laminate Selection</a>	<a href="#">See PVC Edge Color Options</a>	N None CT2 Dual Power Center Top (See chart on next page) CU1 Single Power Underside <b>5 Metal Finish</b> <a href="#">See Metal Finish Color Options</a>

Model Number Breakdown

LKT4872-36HVT					
LK	T	4872	36	HV	T
LOK	Laminate	48" x 72"	Height	Hive Top Shape	T base

Description

Hive Table with T Base at Counter Height  
(continued)

Veneer Tables  
"LKV" Models

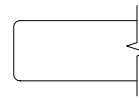

Eased Edge (R3)

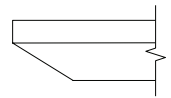

Reverse Bevel Edge (K9)

VEN.	D	W	H	CTN WT	CU FT	① Model	Essentials		Artisan	
	48	72	36	135	87	LKV4872-36HVT	\$3,431		\$3,706	
									\$3,737	\$3,982

Electrical Options and Upcharges

CT2	
Dual Power Center Top - Black	CT2BL - add \$1,773
Dual Power Center Top - White	CT2WH - add \$1,773
CU1	
Single Power Underside - Black	CU11C - add \$690
Single Power Underside with Wireless Charging - Black	CU11CW - add \$1,651

**Note: Order power infeed that best fits application.**

To Order, Specify:

① Veneer Model #	② Edge Detail	③ Wood Collection	④ Top Wood Finish	⑤ Electrical	⑥ Metal Color
Veneer (LKV)	<a href="#">See Edge Detail Options</a>	Essentials	<a href="#">See Essentials Wood Finish Options</a>	N None CT2 Dual Power Center Top CU1 Single Power Underside (See chart above)	<a href="#">See Metal Finish Color Options</a>
		Artisan	④ Top Wood Finish <a href="#">See Artisan Wood Finish Options</a>		

LOK- CONFERENCE

Description

Rectangular Table with T Base at Bar Height

Laminate Tables "LKT" Models

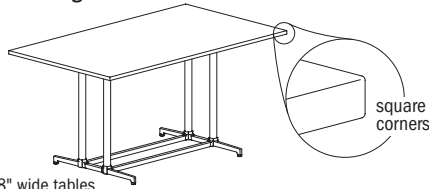

48" wide tables have double column base

D	W	H	CTN WT	CU FT	Model
48	84	42	216	117	LKT4884-42TTT
42	96	42	190	118	LKT4296-42TTT
42	84	42	215	105	LKT4284-42TTT
36	96	42	169	102	LKT3696-42TTT
36	84	42	151	90	LKT3684-42TTT

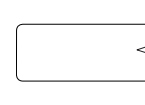

Eased Edge (R3)

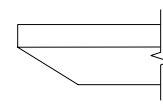

Reverse Bevel Edge (K9)

Standard Tier 1	Graded In Tier 2	Standard Tier 1	Graded In Tier 2
\$3,793	\$3,850	\$4,362	\$4,418
\$3,648	\$3,705	\$4,214	\$4,268
\$3,746	\$3,793	\$4,299	\$4,349
\$3,097	\$3,143	\$3,646	\$3,693
\$2,796	\$2,839	\$3,339	\$3,377

LAMINATE

Features:

- price reflects complete table - top and base
- ships KD in multiple cartons
- one piece top
- model includes adjustable glide

Options:

- specify power/charging option, see below for options and upcharges

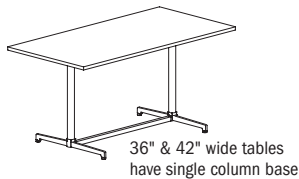

36" & 42" wide tables have single column base



top shape

LOK - CONFERENCE

To Order Specify

1 Laminate Model #	2 Edge Detail	3 Laminate Selection	3a PVC Edge Color	4 Electrical	5 Metal Color
Laminate (LKT)	<a href="#">See Edge Detail Options</a>	<a href="#">See Laminate Selection</a>	<a href="#">See PVC Edge Color Options</a>	N None CT2 Dual Power Center Top CU2 Dual Power Underside CT2U1 Dual Power Center Top with Underside (See chart on next page)	<a href="#">See Metal Finish Color Options</a>

Model Number Breakdown

LKT4896-42TTT					
LK	T	4896	42	TT	T
LOK	Laminate	48" x 96"	Height	Rectangular Top Shape	T base

Description

Rectangular Table with T Base  
at Bar Height  
(continued)

Veneer Tables  
"LKV" Models

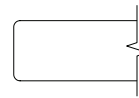

Eased Edge (R3)

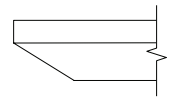

Reverse Bevel Edge (K9)

D	W	H	CTN WT	CU FT	① Model	Essentials		Artisan	
						Essentials	Artisan	Essentials	Artisan
48	96	42	239	132	LKV4896-42TTT	\$5,701	\$6,117	\$6,083	\$6,469
48	84	42	216	117	LKV4884-42TTT	\$5,364	\$5,724	\$5,719	\$6,051
42	96	42	190	118	LKV4296-42TTT	\$5,422	\$5,853	\$5,908	\$6,293
	84	42	215	105	LKV4284-42TTT	\$4,640	\$5,012	\$5,059	\$5,385
36	96	42	169	102	LKV3696-42TTT	\$4,169	\$4,503	\$4,541	\$4,839
36	84	42	151	90	LKV3684-42TTT	\$3,852	\$4,162	\$4,198	\$4,472

VENEER

Electrical Options and Upcharges

CT2	84 - 96 wide
Dual Power Center Top - Black	CT2BL - add \$1,837
Dual Power Center Top - White	CT2WH - add \$1,837
CU1	
Dual Power Underside - Black	CU1-1C - add \$731
Dual Power Underside with Wireless Charging - Black	CU1-1CW - add \$1,691
CT2U1	
Dual Power Center Top - Black with Underside	CT2U1-BL - add \$2,235
Dual Power Center Top - White with Underside	CT2U1-WH - add \$2,235
Dual Power Center Top - Black with Wireless Charging	CT2U1-BLW2 - add \$3,194
Dual Power Center Top - White with Wireless Charging	CT2U1-WhW2 - add \$3,194

Note: Order power infeed that best fits application

To Order Specify

① Veneer Model #	② Edge Detail	③ Wood Collection	④ Wood Finish	⑤ Electrical	⑥ Metal Color
Veneer (LKV)	<a href="#">See Edge Detail Options</a>	Essentials	<a href="#">See Essentials Wood Finish Options</a>	N None CT2 Dual Power Center Top CU2 Dual Power Underside CT2U1 Dual Power Center Top with Underside (See chart above)	<a href="#">See Metal Finish Color Options</a>
		Artisan	④ Wood Finish <a href="#">See Artisan Wood Finish Options</a>		

LOK - CONFERENCE

Description

Rounded Rectangular Table with T Base at Bar Height

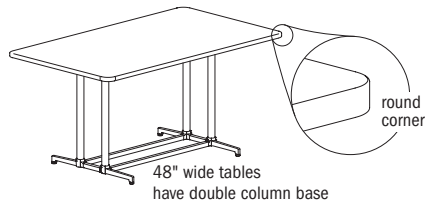

Laminate Tables "LKT" Models

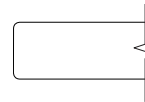

Eased Edge (R3)

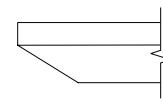

Reverse Bevel Edge (K9)

LAMINATE	D	W	H	CTN WT	CU FT	Model	Eased Edge (R3)		Reverse Bevel Edge (K9)	
							Standard Tier 1	Graded In Tier 2	Standard Tier 1	Graded In Tier 2
	48	96	42	239	132	LKT4896-42TTRT	\$4,189	\$4,253	\$4,771	\$4,836
48	84	42	216	117	LKT4884-42TTRT	\$3,815	\$3,871	\$4,383	\$4,436	
42	96	42	190	118	LKT4296-42TTRT	\$3,718	\$3,774	\$4,287	\$4,342	
42	84	42	215	105	LKT4284-42TTRT	\$3,812	\$3,860	\$4,365	\$4,415	
36	96	42	169	102	LKT3696-42TTRT	\$3,160	\$3,209	\$3,713	\$3,760	
36	84	42	151	90	LKT3684-42TTRT	\$2,856	\$2,897	\$3,396	\$3,438	

Features:

- price reflects complete table - top and base
- ships KD in multiple cartons
- one piece top
- model includes adjustable glide

Options:

- specify power/charging option, see below for options and upcharges

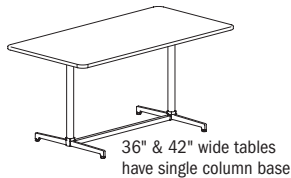

top shape

LOK - CONFERENCE

To Order Specify

1 Laminate Model #	2 Edge Detail	3 Laminate Selection	3a PVC Edge Color	4 Electrical	5 Metal Color
Laminate (LKT)	<a href="#">See Edge Detail Options</a>	<a href="#">See Laminate Selection</a>	<a href="#">See PVC Edge Color Options</a>	N None CT2 Dual Power Center Top CU2 Dual Power Underside CT2U1 Dual Power Center Top with Underside (See chart on next page)	<a href="#">See Metal Finish Color Options</a>

Model Number Breakdown

LKT4896-42TTRT						
LK	T	4896	42	TT	R	T
LOK	Laminate	48" x 96"	Height	Rectangular Top Shape	Rounded Corner	T Base

Description

Rounded Rectangular Table with T Base at Bar Height (continued)

Veneer Tables "LKV" Models      Solid Surface Tables "LKS" Models

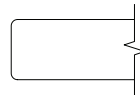

Eased Edge (R3)

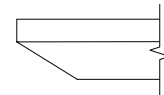

Reverse Bevel Edge (K9)

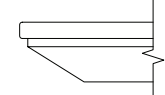

Reverse Bevel Edge (K7)

	D	W	H	CTN WT	CU FT	① Model	Veneer		Solid Surface		
							Essentials	Artisan	Essentials	Artisan	Standard
VENEER	48	96	42	239	132	LKV4896-42TTRT	\$5,800	\$6,216	\$6,178	\$6,566	--
	48	84	42	216	117	LKV4884-42TTRT	\$5,392	\$5,749	\$5,746	\$6,082	--
	42	96	42	190	118	LKV4296-42TTRT	\$5,511	\$5,948	\$6,005	\$6,393	--
	42	84	42	215	105	LKV4284-42TTRT	\$5,537	\$5,978	\$6,035	\$6,427	--
	36	96	42	169	102	LKV3696-42TTRT	\$4,249	\$4,586	\$4,628	\$4,928	--
	36	84	42	151	90	LKV3684-42TTRT	\$3,927	\$4,239	\$4,278	\$4,558	--
SOLID SURFACE	48	96	42	239	132	LKS4896-42TTRT	--	--	--	--	\$13,043
	48	84	42	216	117	LKS4884-42TTRT	--	--	--	--	\$11,678
	42	96	42	190	118	LKS4296-42TTRT	--	--	--	--	\$10,534
	42	84	42	215	105	LKS4284-42TTRT	--	--	--	--	\$10,183
	36	96	42	169	102	LKS3696-42TTRT	--	--	--	--	\$9,284
	36	84	42	151	90	LKS3684-42TTRT	--	--	--	--	\$8,390

Electrical Options and Upcharges

CT2	84 - 96 wide
Dual Power Center Top - Black	CT2BL - add \$1,837
Dual Power Center Top - White	CT2WH - add \$1,837
CU1	
Dual Power Underside - Black	CU1-1C - add \$731
Dual Power Underside with Wireless Charging - Black	CU1-1CW - add \$1,691
CT2U1	
Dual Power Center Top - Black with Underside	CT2U1-BL - add \$2,235
Dual Power Center Top - White with Underside	CT2U1-WH - add \$2,235
Dual Power Center Top - Black with Wireless Charging	CT2U1-BLW2 - add \$3,194
Dual Power Center Top - White with Wireless Charging	CT2U1-WHW2 - add \$3,194

Note: Order power infeed that best fits application

To Order Specify

① Veneer Model #	② Edge Detail	③ Wood Collection	④ Wood Finish	⑤ Electrical	⑥ Metal Color
Veneer (LKV)	<a href="#">See Edge Detail Options</a>	Essentials	<a href="#">See Essentials Wood Finish Options</a>	N None CT2 Dual Power Center Top CU2 Dual Power Underside CT2U1 Dual Power Center Top with Underside (See chart above)	<a href="#">See Metal Finish Color Options</a>
		Artisan	④ Wood Finish <a href="#">See Artisan Wood Finish Options</a>		

① Solid Surface Model #	② Top Surface Selection	③ Electrical	④ Metal Color
Solid Surface (LKS)	<a href="#">See Solid Surface Top Surface Selection Options</a>	N None CT2 Dual Power Center Top CU2 Dual Power Underside CT2U1 Dual Power Center Top with Underside (See chart above)	<a href="#">See Metal Finish Color Options</a>

LOK - CONFERENCE

Description

Rectangular Table with Y Base at Bar Height

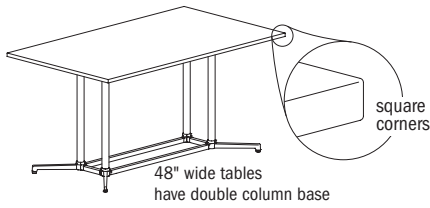

Laminate Tables "LKT" Models

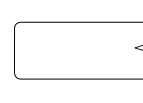

Eased Edge (R3)

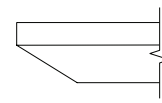

Reverse Bevel Edge (K9)

LAMINATE	D	W	H	CTN WT	CU FT	Model	Eased Edge (R3)		Reverse Bevel Edge (K9)	
							Standard Tier 1	Graded In Tier 2	Standard Tier 1	Graded In Tier 2
	48	96	42	229	132	LKT4896-42TTY	\$4,012	\$4,076	\$4,592	\$4,659
48	84	42	215	117	LKT4884-42TTY	\$3,544	\$3,597	\$4,107	\$4,166	
42	96	42	200	118	LKT4296-42TTY	\$4,557	\$4,612	\$5,123	\$5,180	
42	84	42	160	103	LKT4284-42TTY	\$3,166	\$3,217	\$3,723	\$3,771	
36	96	42	180	102	LKT3696-42TTY	\$3,181	\$3,232	\$3,732	\$3,783	
36	84	42	162	90	LKT3684-42TTY	\$2,834	\$2,874	\$3,375	\$3,418	

Features:

- price reflects complete table - top and base
- ships KD in multiple cartons
- one piece top
- model includes adjustable glide

Options:

- specify power/charging option, see below for options and upcharges

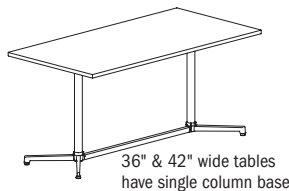

top shape

LOK - CONFERENCE

To Order Specify

1 Laminite Model #	2 Edge Detail	3 Laminite Selection	3a PVC Edge Color	4 Electrical	5 Metal Color
Laminite (LKT)	<a href="#">See Edge Detail Options</a>	<a href="#">See Laminite Selection</a>	<a href="#">See PVC Edge Color Options</a>	N None CT2 Dual Power Center Top CU2 Dual Power Underside CT2U1 Dual Power Center Top with Underside (See chart on next page)	<a href="#">See Metal Finish Color Options</a>

Model Number Breakdown

LKT4896-42TTY					
LK	T	4896	42	TT	Y
LOK	Laminite	48" x 96"	Height	Rectangular Top Shape	Y Base

Description

Rectangular Table with Y Base at Bar Height (continued)

Veneer Tables "LKV" Models

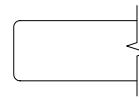

Eased Edge (R3)

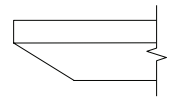

Reverse Bevel Edge (K9)

D	W	H	CTN WT	CU FT	Model	Essentials		Artisan	
						Essentials	Artisan	Essentials	Artisan
48	96	42	229	132	LKV4896-42TTY	\$5,573	\$5,986	\$5,954	\$6,342
48	84	42	215	117	LKV4884-42TTY	\$5,047	\$5,405	\$5,400	\$5,734
42	96	42	200	118	LKV4296-42TTY	\$6,557	\$7,082	\$7,145	\$7,612
	84	42	160	103	LKV4284-42TTY	\$4,748	\$5,129	\$5,175	\$5,512
36	96	42	180	102	LKV3696-42TTY	\$4,274	\$4,618	\$4,660	\$4,962
36	84	42	162	90	LKV3684-42TTY	\$3,899	\$4,212	\$4,251	\$4,527

VENEER

Electrical Options and Upcharges

CT2	84 - 96 wide
Dual Power Center Top - Black	CT2BL - add \$1,837
Dual Power Center Top - White	CT2WH - add \$1,837
CU1	
Dual Power Underside - Black	CU1-1C - add \$731
Dual Power Underside with Wireless Charging - Black	CU1-1CW - add \$1,691
CT2U1	
Dual Power Center Top - Black with Underside	CT2U1-BL - add \$2,235
Dual Power Center Top - White with Underside	CT2U1-WH - add \$2,235
Dual Power Center Top - Black with Wireless Charging	CT2U1-BLW2 - add \$3,194
Dual Power Center Top - White with Wireless Charging	CT2U1-WHW2 - add \$3,194

Note: Order power infeed that best fits application

To Order Specify

1 Veneer Model #	2 Edge Detail	3 Wood Collection	4 Wood Finish	5 Electrical	6 Metal Color
Veneer (LKV)	<a href="#">See Edge Detail Options</a>	Essentials	<a href="#">See Essentials Wood Finish Options</a>	N None CT2 Dual Power Center Top CU2 Dual Power Underside CT2U1 Dual Power Center Top with Underside (See chart above)	<a href="#">See Metal Finish Color Options</a>
		Artisan	4 Wood Finish <a href="#">See Artisan Wood Finish Options</a>		

LOK - CONFERENCE

Description

Rounded Rectangular Table with Y Base at Bar Height

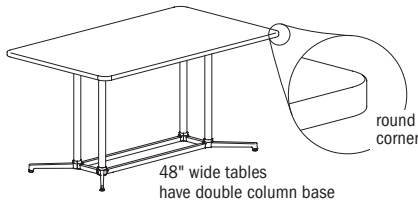

Laminate Tables  
"LKT" Models



Eased Edge (R3)

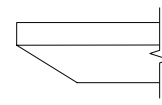

Reverse Bevel Edge (K9)

LAMINATE

D	W	H	CTN WT	CU FT	1 Model	Eased Edge (R3)		Reverse Bevel Edge (K9)	
						Standard Tier 1	Graded In Tier 2	Standard Tier 1	Graded In Tier 2
48	96	42	229	132	LKT4896-42TTRY	\$4,089	\$4,152	\$4,671	\$4,735
48	84	42	215	117	LKT4884-42TTRY	\$3,609	\$3,667	\$4,180	\$4,235
42	96	42	200	118	LKT4296-42TTRY	\$4,627	\$4,681	\$5,193	\$5,249
42	84	42	160	103	LKT4284-42TTRY	\$3,234	\$3,281	\$3,789	\$3,837
36	96	42	180	102	LKT3696-42TTRY	\$3,249	\$3,298	\$3,800	\$3,848
36	84	42	162	90	LKT3684-42TTRY	\$2,893	\$2,936	\$3,433	\$3,477

Features:

- price reflects complete table - top and base
- ships KD in multiple cartons
- one piece top
- model includes adjustable glide

Options:

- specify power/charging option, see below for options and upcharges

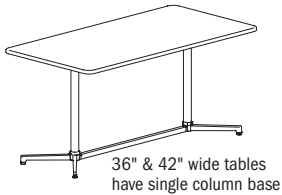

top shape

LOK - CONFERENCE

To Order Specify

1 Laminate Model #	2 Edge Detail	3 Laminate Selection	3a PVC Edge Color	4 Electrical	5 Metal Color
Laminate (LKT)	<a href="#">See Edge Detail Options</a>	<a href="#">See Laminate Selection</a>	<a href="#">See PVC Edge Color Options</a>	N None CT2 Dual Power Center Top CU2 Dual Power Underside CT2U1 Dual Power Center Top with Underside (See chart on next page)	<a href="#">See Metal Finish Color Options</a>

Model Number Breakdown

LKT4896-42TTRY						
LK	T	4896	42	TT	R	Y
LOK	Laminate	48" x 96"	Height	Rectangular Top Shape	Rounded Corner	Y Base

Description

Rounded Rectangular Table with Y Base at Bar Height (continued)

Veneer Tables "LKV" Models      Solid Surface Tables "LKS" Models

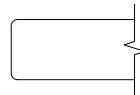

Eased Edge (R3)

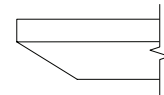

Reverse Bevel Edge (K9)

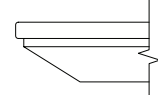

Reverse Bevel Edge (K7)

	D	W	H	CTN WT	CU FT	① Model	Veneer		Solid Surface		
							Essentials	Artisan	Essentials	Artisan	Standard
VENEER	48	96	42	229	132	LKV4896-42TTRY	\$5,671	\$6,085	\$6,051	\$6,437	--
	48	84	42	215	117	LKV4884-42TTRY	\$5,136	\$5,495	\$5,489	\$5,824	--
	42	96	42	200	118	LKV4296-42TTRY	\$6,645	\$7,176	\$7,244	\$7,714	--
	42	84	42	160	103	LKV4284-42TTRY	\$4,830	\$5,216	\$5,266	\$5,606	--
	36	96	42	180	102	LKV3696-42TTRY	\$4,356	\$4,705	\$4,747	\$5,057	--
	36	84	42	162	90	LKV3684-42TTRY	\$3,973	\$4,292	\$4,329	\$4,613	--
SOLID SURFACE	48	96	42	229	132	LKS4896-42TTRY	--	--	--	--	\$12,914
	48	84	42	215	117	LKS4884-42TTRY	--	--	--	--	\$11,421
	42	96	36	197	102	LKS4296-42TTRY	--	--	--	--	\$11,670
	42	84	42	160	103	LKS4284-42TTRY	--	--	--	--	\$9,473
	36	96	42	180	102	LKS3696-42TTRY	--	--	--	--	\$9,389
	36	84	42	162	90	LKS3684-42TTRY	--	--	--	--	\$8,440

Electrical Options and Upcharges

CT2	84 - 96 wide
Dual Power Center Top - Black	CT2BL - add \$1,837
Dual Power Center Top - White	CT2WH - add \$1,837
CU1	
Dual Power Underside - Black	CU1-1C - add \$731
Dual Power Underside with Wireless Charging - Black	CU1-1CW - add \$1,691
CT2U1	
Dual Power Center Top - Black with Underside	CT2U1-BL - add \$2,235
Dual Power Center Top - White with Underside	CT2U1-WH - add \$2,235
Dual Power Center Top - Black with Wireless Charging	CT2U1-BLW2 - add \$3,194
Dual Power Center Top - White with Wireless Charging	CT2U1-WHW2 - add \$3,194

Note: Order power infeed that best fits application

To Order Specify

① Veneer Model #	② Edge Detail	③ Wood Collection	④ Wood Finish	⑤ Electrical	⑥ Metal Color
Veneer (LKV)	<a href="#">See Edge Detail Options</a>	Essentials	<a href="#">See Essentials Wood Finish Options</a>	N None CT2 Dual Power Center Top CU2 Dual Power Underside CT2U1 Dual Power Center Top with Underside (See chart above)	<a href="#">See Metal Finish Color Options</a>
		Artisan	④ Wood Finish <a href="#">See Artisan Wood Finish Options</a>		

① Solid Surface Model #	② Top Surface Selection	③ Electrical	④ Metal Color
Solid Surface (LKS)	<a href="#">See Solid Surface Top Surface Selection Options</a>	N None CT2 Dual Power Center Top CU2 Dual Power Underside CT2U1 Dual Power Center Top with Underside (See chart above)	<a href="#">See Metal Finish Color Options</a>

LOK - CONFERENCE

Description

Arc Rectangular Table with T Base at Bar Height

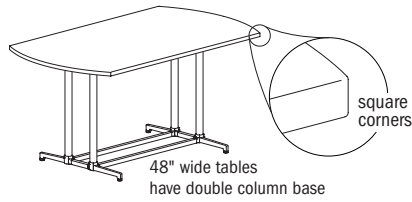

Laminate Tables "LKT" Models

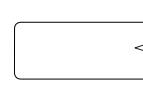

Eased Edge (R3)

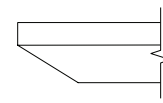

Reverse Bevel Edge (K9)

LAMINATE	D	W	H	CTN WT	CU FT	Model	Eased Edge (R3)		Reverse Bevel Edge (K9)	
							Standard Tier 1	Graded In Tier 2	Standard Tier 1	Graded In Tier 2
	48	96	42	232	132	LKT4896-42ART	\$4,189	\$4,253	\$4,771	\$4,836
48	84	42	208	117	LKT4884-42ART	\$3,815	\$3,871	\$4,383	\$4,436	
42	96	42	186	118	LKT4296-42ART	\$3,718	\$3,774	\$4,287	\$4,342	
42	84	42	207	90	LKT4284-42ART	\$3,812	\$3,860	\$4,365	\$4,415	
36	96	42	166	102	LKT3696-42ART	\$3,160	\$3,209	\$3,713	\$3,760	
36	84	42	147	90	LKT3684-42ART	\$2,856	\$2,897	\$3,396	\$3,438	

Features:

- price reflects complete table - top and base
- ships KD in multiple cartons
- one piece top
- model includes adjustable glide

Options:

- specify power/charging option, see below for options and upcharges

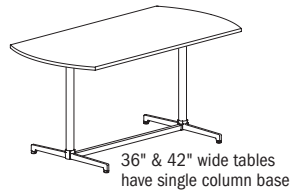

top shape

LOK - CONFERENCE

To Order Specify

1 Laminate Model #	2 Edge Detail	3 Laminate Selection	3a PVC Edge Color	4 Electrical	5 Metal Color
Laminate (LKT)	<a href="#">See Edge Detail Options</a>	<a href="#">See Laminate Selection</a>	<a href="#">See PVC Edge Color Options</a>	N None CT2 Dual Power Center Top CU2 Dual Power Underside CT2U1 Dual Power Center Top with Underside (See chart on next page)	<a href="#">See Metal Finish Color Options</a>

Model Number Breakdown

LKT4896-42ART					
LK	T	4896	42	AR	T
LOK	Laminate	48" x 96"	Height	Arc Rectangular Top Shape	T Base

Description

Arc Rectangular Table with T Base at Bar Height (continued)

Veneer Tables "LKV" Models

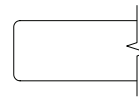

Eased Edge (R3)

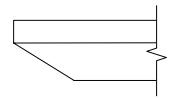

Reverse Bevel Edge (K9)

D	W	H	CTN WT	CU FT	Model	Essentials		Artisan	
						Essentials	Artisan	Essentials	Artisan
48	96	42	232	132	LKV4896-42ART	\$5,800	\$6,216	\$6,178	\$6,566
48	84	42	208	117	LKV4884-42ART	\$5,392	\$5,749	\$5,746	\$6,082
42	96	42	186	118	LKV4296-42ART	\$5,511	\$5,948	\$6,005	\$6,393
42	84	42	207	90	LKV4284-42ART	\$5,537	\$5,978	\$6,035	\$6,427
36	96	42	166	102	LKV3696-42ART	\$4,249	\$4,586	\$4,628	\$4,928
36	84	42	147	90	LKV3684-42ART	\$3,927	\$4,239	\$4,278	\$4,558

VENEER

Electrical Options and Upcharges

CT2	84 - 96 wide
Dual Power Center Top - Black	CT2BL - add \$1,837
Dual Power Center Top - White	CT2WH - add \$1,837
CU1	
Dual Power Underside - Black	CU1-1C - add \$731
Dual Power Underside with Wireless Charging - Black	CU1-1CW - add \$1,691
CT2U1	
Dual Power Center Top - Black with Underside	CT2U1-BL - add \$2,235
Dual Power Center Top - White with Underside	CT2U1-WH - add \$2,235
Dual Power Center Top - Black with Wireless Charging	CT2U1-BLW2 - add \$3,194
Dual Power Center Top - White with Wireless Charging	CT2U1-WhW2 - add \$3,194

Note: Order power infeed that best fits application

To Order Specify

1 Veneer Model #	2 Edge Detail	3 Wood Collection	4 Wood Finish	5 Electrical	6 Metal Color
Veneer (LKV)	<a href="#">See Edge Detail Options</a>	Essentials	<a href="#">See Essentials Wood Finish Options</a>	N None CT2 Dual Power Center Top CU2 Dual Power Underside CT2U1 Dual Power Center Top with Underside (See chart above)	<a href="#">See Metal Finish Color Options</a>
		Artisan	4 Wood Finish <a href="#">See Artisan Wood Finish Options</a>		

LOK - CONFERENCE

Description

Rounded Arc Rectangular Table with T Base at Bar Height

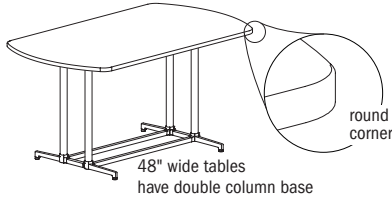

Laminate Tables  
"LKT" Models

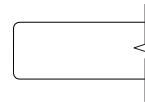

Eased Edge (R3)

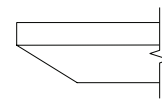

Reverse Bevel Edge (K9)

D	W	H	CTN WT	CU FT	Model	Eased Edge (R3)		Reverse Bevel Edge (K9)	
						Standard Tier 1	Graded In Tier 2	Standard Tier 1	Graded In Tier 2
48	96	42	232	132	LKT4896-42ARRT	\$4,189	\$4,253	\$4,771	\$4,836
48	84	42	208	117	LKT4884-42ARRT	\$3,815	\$3,871	\$4,383	\$4,436
42	96	42	186	118	LKT4296-42ARRT	\$3,718	\$3,774	\$4,287	\$4,342
42	84	42	207	90	LKT4284-42ARRT	\$3,812	\$3,860	\$4,365	\$4,415
36	96	42	166	102	LKT3696-42ARRT	\$3,160	\$3,209	\$3,713	\$3,760
36	84	42	147	90	LKT3684-42ARRT	\$2,856	\$2,897	\$3,396	\$3,438

LAMINATE

Features:

- price reflects complete table - top and base
- ships KD in multiple cartons
- one piece top
- model includes adjustable glide

Options:

- specify power/charging option, see below for options and upcharges

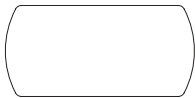
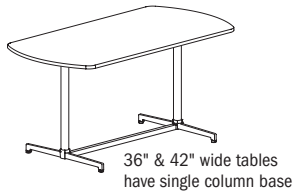

top shape

LOK - CONFERENCE

To Order Specify

1 Laminate Model #	2 Edge Detail	3 Laminate Selection	3a PVC Edge Color	4 Electrical	5 Metal Color
Laminate (LKT)	<a href="#">See Edge Detail Options</a>	<a href="#">See Laminate Selection</a>	<a href="#">See PVC Edge Color Options</a>	N None CT2 Dual Power Center Top CU2 Dual Power Underside CT2U1 Dual Power Center Top with Underside (See chart on next page)	<a href="#">See Metal Finish Color Options</a>

Model Number Breakdown

LKT4896-42ARRT						
LK	T	4896	42	AR	R	T
LOK	Laminate	48" x 96"	Height	Arc Rectangular Top Shape	Rounded Corner	T Base

Description

Rounded Arc Rectangular Table with T Base at Bar Height (continued)

Veneer Tables "LKV" Models      Solid Surface Tables "LKS" Models

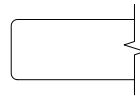

Eased Edge (R3)

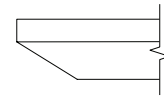

Reverse Bevel Edge (K9)

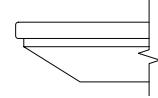

Reverse Bevel Edge (K7)

	D	W	H	CTN WT	CU FT	① Model	Veneer		Solid Surface		
							Essentials	Artisan	Essentials	Artisan	Standard
VENEER	48	96	42	232	132	LKV4896-42ARRT	\$5,800	\$6,216	\$6,178	\$6,566	--
	48	84	42	208	117	LKV4884-42ARRT	\$5,392	\$5,749	\$5,746	\$6,082	--
	42	96	42	186	118	LKV4296-42ARRT	\$5,511	\$5,948	\$6,005	\$6,393	--
	42	84	42	207	90	LKV4284-42ARRT	\$5,537	\$5,978	\$6,035	\$6,427	--
	36	96	42	166	102	LKV3696-42ARRT	\$4,249	\$4,586	\$4,628	\$4,928	--
	36	84	42	147	90	LKV3684-42ARRT	\$3,927	\$4,239	\$4,278	\$4,558	--
SOLID SURFACE	48	96	42	232	132	LKS4896-42ARRT	--	--	--	--	\$13,043
	48	84	42	208	117	LKS4884-42ARRT	--	--	--	--	\$11,678
	42	96	42	186	118	LKS4296-42ARRT	--	--	--	--	\$10,534
	42	84	42	207	90	LKS4284-42ARRT	--	--	--	--	\$10,183
	36	96	42	166	102	LKS3696-42ARRT	--	--	--	--	\$9,284
	36	84	42	147	90	LKS3684-42ARRT	--	--	--	--	\$8,390

Electrical Options and Upcharges

CT2	84 - 96 wide
Dual Power Center Top - Black	CT2BL - add \$1,837
Dual Power Center Top - White	CT2WH - add \$1,837
CU1	
Dual Power Underside - Black	CU1-1C - add \$731
Dual Power Underside with Wireless Charging - Black	CU1-1CW - add \$1,691
CT2U1	
Dual Power Center Top - Black with Underside	CT2U1-BL - add \$2,235
Dual Power Center Top - White with Underside	CT2U1-WH - add \$2,235
Dual Power Center Top - Black with Wireless Charging	CT2U1-BLW2 - add \$3,194
Dual Power Center Top - White with Wireless Charging	CT2U1-WHW2 - add \$3,194

Note: Order power infeed that best fits application

To Order Specify

① Veneer Model #	② Edge Detail	③ Wood Collection	④ Wood Finish	⑤ Electrical	⑥ Metal Color
Veneer (LKV)	<a href="#">See Edge Detail Options</a>	Essentials	<a href="#">See Essentials Wood Finish Options</a>	N None CT2 Dual Power Center Top CU2 Dual Power Underside CT2U1 Dual Power Center Top with Underside (See chart above)	<a href="#">See Metal Finish Color Options</a>
		Artisan	④ Wood Finish <a href="#">See Artisan Wood Finish Options</a>		

① Solid Surface Model #	② Top Surface Selection	③ Electrical	④ Metal Color
Solid Surface (LKS)	<a href="#">See Solid Surface Top Surface Selection Options</a>	N None CT2 Dual Power Center Top CU2 Dual Power Underside CT2U1 Dual Power Center Top with Underside (See chart above)	<a href="#">See Metal Finish Color Options</a>

LOK - CONFERENCE

Description

Arc Rectangular Table with Y Base at Bar Height

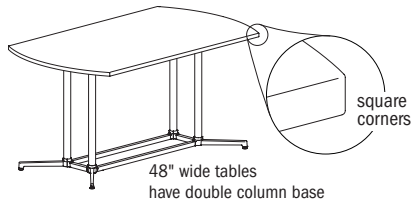

Laminate Tables "LKT" Models

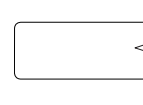

Eased Edge (R3)

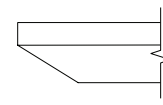

Reverse Bevel Edge (K9)

LAMINATE

D	W	H	CTN WT	CU FT	Model	Eased Edge (R3)		Reverse Bevel Edge (K9)	
						Standard Tier 1	Graded In Tier 2	Standard Tier 1	Graded In Tier 2
48	96	42	231	132	LKT4896-42ARY	\$4,089	\$4,152	\$4,671	\$4,735
48	84	42	207	117	LKT4884-42ARY	\$3,609	\$3,667	\$4,180	\$4,235
42	96	42	196	118	LKT4296-42ARY	\$4,627	\$4,681	\$5,193	\$5,249
42	84	42	160	103	LKT4284-42ARY	\$3,234	\$3,281	\$3,789	\$3,837
36	96	42	167	102	LKT3696-42ARY	\$3,249	\$3,298	\$3,800	\$3,848
36	84	42	153	90	LKT3684-42ARY	\$2,893	\$2,936	\$3,433	\$3,477

Features:

- price reflects complete table - top and base
- ships KD in multiple cartons
- one piece top
- model includes adjustable glide

Options:

- specify power/charging option, see below for options and upcharges

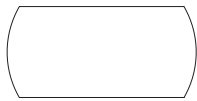
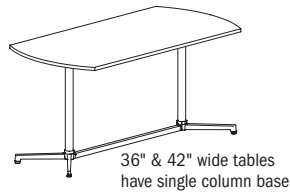

top shape

LOK - CONFERENCE

To Order Specify

1 Laminate Model #	2 Edge Detail	3 Laminate Selection	3a PVC Edge Color	4 Electrical	5 Metal Color
Laminate (LKT)	<a href="#">See Edge Detail Options</a>	<a href="#">See Laminate Selection</a>	<a href="#">See PVC Edge Color Options</a>	N None CT2 Dual Power Center Top CU2 Dual Power Underside CT2U1 Dual Power Center Top with Underside (See chart on next page)	<a href="#">See Metal Finish Color Options</a>

Model Number Breakdown

LKT4896-42ARY					
LK	T	4896	42	AR	Y
LOK	Laminate	48" x 96"	Height	Acr Rectangular Top Shape	Y Base

Description

Arc Rectangular Table with Y Base at Bar Height (continued)

Veneer Tables "LKV" Models

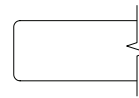

Eased Edge (R3)

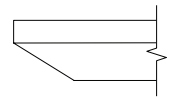

Reverse Bevel Edge (K9)

D	W	H	CTN WT	CU FT	Model	Essentials		Artisan	
						Essentials	Artisan	Essentials	Artisan
48	96	42	231	132	LKV4896-42ARY	\$5,671	\$6,085	\$6,051	\$6,437
48	84	42	207	117	LKV4884-42ARY	\$5,136	\$5,495	\$5,489	\$5,824
42	96	42	196	118	LKV4296-42ARY	\$6,645	\$7,176	\$7,244	\$7,714
	84	42	160	103	LKV4284-42ARY	\$4,830	\$5,216	\$5,266	\$5,606
36	96	42	167	102	LKV3696-42ARY	\$4,356	\$4,705	\$4,747	\$5,057
36	84	42	153	90	LKV3684-42ARY	\$3,973	\$4,292	\$4,329	\$4,613

VENEER

Electrical Options and Upcharges

CT2	84 - 96 wide
Dual Power Center Top - Black	CT2BL - add \$1,837
Dual Power Center Top - White	CT2WH - add \$1,837
CU1	
Dual Power Underside - Black	CU1-1C - add \$731
Dual Power Underside with Wireless Charging - Black	CU1-1CW - add \$1,691
CT2U1	
Dual Power Center Top - Black with Underside	CT2U1-BL - add \$2,235
Dual Power Center Top - White with Underside	CT2U1-WH - add \$2,235
Dual Power Center Top - Black with Wireless Charging	CT2U1-BLW2 - add \$3,194
Dual Power Center Top - White with Wireless Charging	CT2U1-WhW2 - add \$3,194

Note: Order power infeed that best fits application

To Order Specify

1 Veneer Model #	2 Edge Detail	3 Wood Collection	4 Wood Finish	5 Electrical	6 Metal Color
Veneer (LKV)	<a href="#">See Edge Detail Options</a>	Essentials	<a href="#">See Essentials Wood Finish Options</a>	N None CT2 Dual Power Center Top CU2 Dual Power Underside CT2U1 Dual Power Center Top with Underside (See chart above)	<a href="#">See Metal Finish Color Options</a>
		Artisan	4 Wood Finish <a href="#">See Artisan Wood Finish Options</a>		

LOK - CONFERENCE

Description

Rounded Arc Rectangular Table with Y Base at Bar Height

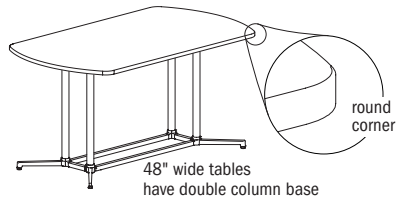

Laminate Tables  
"LKT" Models

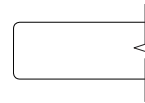

Eased Edge (R3)

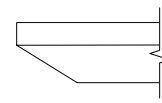

Reverse Bevel Edge (K9)

D	W	H	CTN WT	CU FT	Model	Eased Edge (R3)		Reverse Bevel Edge (K9)	
						Standard Tier 1	Graded In Tier 2	Standard Tier 1	Graded In Tier 2
48	96	42	231	132	LKT4896-42ARRY	\$4,089	\$4,152	\$4,671	\$4,735
48	84	42	175	117	LKT4884-42ARRY	\$3,609	\$3,667	\$4,180	\$4,235
42	96	42	196	118	LKT4296-42ARRY	\$4,627	\$4,681	\$5,193	\$5,249
42	84	42	180	103	LKT4284-42ARRY	\$3,234	\$3,281	\$3,789	\$3,837
36	96	42	167	102	LKT3696-42ARRY	\$3,249	\$3,298	\$3,800	\$3,848
36	84	42	159	90	LKT3684-42ARRY	\$2,893	\$2,936	\$3,433	\$3,477

LAMINATE

Features:

- price reflects complete table - top and base
- ships KD in multiple cartons
- one piece top
- model includes adjustable glide

Options:

- specify power/charging option, see below for options and upcharges

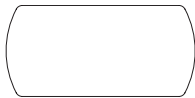
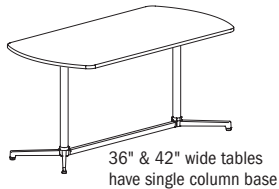

top shape

LOK - CONFERENCE

To Order Specify

1 Laminate Model #	2 Edge Detail	3 Laminate Selection	3a PVC Edge Color	4 Electrical	5 Metal Color
Laminate (LKT)	<a href="#">See Edge Detail Options</a>	<a href="#">See Laminate Selection</a>	<a href="#">See PVC Edge Color Options</a>	N None CT2 Dual Power Center Top CU2 Dual Power Underside CT2U1 Dual Power Center Top with Underside (See chart on next page)	<a href="#">See Metal Finish Color Options</a>

Model Number Breakdown

LKT4896-42ARRY						
LK	T	4896	42	AR	R	Y
LOK	Laminate	48" x 96"	Height	Arc Rectangular Top Shape	Rounded Corner	Y Base

Description

Rounded Arc Rectangular Table with Y Base at Bar Height (continued)

Veneer Tables "LKV" Models      Solid Surface Tables "LKS" Models

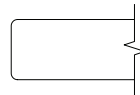

Eased Edge (R3)

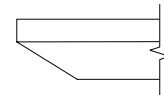

Reverse Bevel Edge (K9)

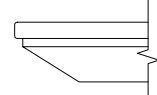

Reverse Bevel Edge (K7)

	D	W	H	CTN WT	CU FT	① Model	Veneer		Solid Surface		
							Essentials	Artisan	Essentials	Artisan	Standard
VENEER	48	96	42	231	132	LKV4896-42ARRY	\$5,671	\$6,085	\$6,051	\$6,437	--
	48	84	42	175	117	LKV4884-42ARRY	\$5,136	\$5,495	\$5,489	\$5,824	--
	42	96	42	196	118	LKV4296-42ARRY	\$6,645	\$7,176	\$7,244	\$7,714	--
	42	84	42	180	103	LKV4284-42ARRY	\$4,830	\$5,216	\$5,266	\$5,606	--
	36	96	42	167	102	LKV3696-42ARRY	\$4,356	\$4,705	\$4,747	\$5,057	--
	36	84	42	159	90	LKV3684-42ARRY	\$3,973	\$4,292	\$4,329	\$4,613	--
SOLID SURFACE	48	96	42	231	132	LKS4896-42ARRY	--	--	--	--	\$12,914
	48	84	42	175	117	LKS4884-42ARRY	--	--	--	--	\$11,421
	42	96	42	196	118	LKS4296-42ARRY	--	--	--	--	\$11,670
	42	84	42	180	103	LKS4284-42ARRY	--	--	--	--	\$9,473
	36	96	42	167	102	LKS3696-42ARRY	--	--	--	--	\$9,389
	36	84	42	159	90	LKS3684-42ARRY	--	--	--	--	\$8,440

Electrical Options and Upcharges

CT2	84 - 96 wide
Dual Power Center Top - Black	CT2BL - add \$1,837
Dual Power Center Top - White	CT2WH - add \$1,837
CU1	
Dual Power Underside - Black	CU1-1C - add \$731
Dual Power Underside with Wireless Charging - Black	CU1-1CW - add \$1,691
CT2U1	
Dual Power Center Top - Black with Underside	CT2U1-BL - add \$2,235
Dual Power Center Top - White with Underside	CT2U1-WH - add \$2,235
Dual Power Center Top - Black with Wireless Charging	CT2U1-BLW2 - add \$3,194
Dual Power Center Top - White with Wireless Charging	CT2U1-WHW2 - add \$3,194

Note: Order power infeed that best fits application

To Order Specify

① Veneer Model #	② Edge Detail	③ Wood Collection	④ Wood Finish	⑤ Electrical	⑥ Metal Color
Veneer (LKV)	<a href="#">See Edge Detail Options</a>	Essentials	<a href="#">See Essentials Wood Finish Options</a>	N None CT2 Dual Power Center Top CU2 Dual Power Underside CT2U1 Dual Power Center Top with Underside (See chart above)	<a href="#">See Metal Finish Color Options</a>
		Artisan	④ Wood Finish <a href="#">See Artisan Wood Finish Options</a>		

① Solid Surface Model #	② Top Surface Selection	③ Electrical	④ Metal Color
Solid Surface (LKS)	<a href="#">See Solid Surface Top Surface Selection Options</a>	N None CT2 Dual Power Center Top CU2 Dual Power Underside CT2U1 Dual Power Center Top with Underside (See chart above)	<a href="#">See Metal Finish Color Options</a>

LOK - CONFERENCE

Description

Racetrack Table with Y Base at Bar Height

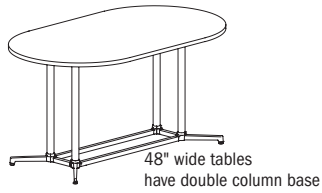

Laminate Tables "LKT" Models

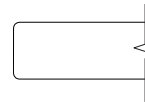

Eased Edge (R3)

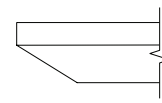

Reverse Bevel Edge (K9)

LAMINATE	D	W	H	CTN WT	CU FT	1 Model	Eased Edge (R3)		Reverse Bevel Edge (K9)	
							Standard Tier 1	Graded In Tier 2	Standard Tier 1	Graded In Tier 2
	48	96	42	219	132	LKT4896-42RKY	\$4,089	\$4,152	\$4,671	\$4,735
48	84	42	197	117	LKT4884-42RKY	\$3,609	\$3,667	\$4,180	\$4,235	
42	96	42	188	118	LKT4296-42RKY	\$4,627	\$4,681	\$5,193	\$5,249	
42	84	42	167	103	LKT4284-42RKY	\$3,234	\$3,281	\$3,789	\$3,837	
36	96	42	177	102	LKT3696-42RKY	\$3,249	\$3,298	\$3,800	\$3,848	
36	84	42	152	90	LKT3684-42RKY	\$2,893	\$2,936	\$3,433	\$3,477	

Features:

- price reflects complete table - top and base
- ships KD in multiple cartons
- one piece top
- model includes adjustable glide

Options:

- specify power/charging option, see below for options and upcharges



top shape

LOK - CONFERENCE

To Order Specify

1 Laminate Model #	2 Edge Detail	3 Laminate Selection	3a PVC Edge Color	4 Electrical	5 Metal Color
Laminate (LKT)	<a href="#">See Edge Detail Options</a>	<a href="#">See Laminate Selection</a>	<a href="#">See PVC Edge Color Options</a>	N None CT2 Dual Power Center Top CU2 Dual Power Underside CT2U1 Dual Power Center Top with Underside (See chart on next page)	<a href="#">See Metal Finish Color Options</a>

Model Number Breakdown

LKT4896-42RKY					
LK	T	4896	42	RK	Y
LOK	Laminate	48" x 96"	Height	Racetrack Top Shape	Y Base

Description

Racetrack Table with Y Base at Bar Height (continued)

Veneer Tables "LKV" Models

Solid Surface Tables "LKS" Models

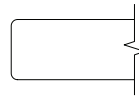

Eased Edge (R3)

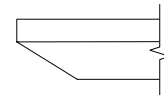

Reverse Bevel Edge (K9)

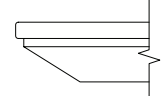

Reverse Bevel Edge (K7)

	D	W	H	CTN WT	CU FT	① Model	Veneer Tables		Solid Surface Tables		
							Essentials	Artisan	Essentials	Artisan	Standard
VENEER	48	96	42	219	132	LKV4896-42RKY	\$5,671	\$6,085	\$6,051	\$6,437	--
	48	84	42	197	117	LKV4884-42RKY	\$5,136	\$5,495	\$5,489	\$5,824	--
	42	96	42	188	118	LKV4296-42RKY	\$6,645	\$7,176	\$7,244	\$7,714	--
	42	84	42	167	103	LKV4284-42RKY	\$4,830	\$5,216	\$5,266	\$5,606	--
	36	96	42	177	102	LKV3696-42RKY	\$4,356	\$4,705	\$4,747	\$5,057	--
	36	84	42	152	90	LKV3684-42RKY	\$3,973	\$4,292	\$4,329	\$4,613	--
SOLID SURFACE	48	96	42	219	132	LKS4896-42RKY	--	--	--	--	\$12,914
	48	84	42	197	117	LKS4884-42RKY	--	--	--	--	\$11,421
	42	96	42	188	118	LKS4296-42RKY	--	--	--	--	\$11,670
	42	84	42	167	103	LKS4284-42RKY	--	--	--	--	\$9,473
	36	96	42	177	102	LKS3696-42RKY	--	--	--	--	\$9,389
	36	84	42	152	90	LKS3684-42RKY	--	--	--	--	\$8,440

Electrical Options and Upcharges

CT2	84 - 96 wide
Dual Power Center Top - Black	CT2BL - add \$1,837
Dual Power Center Top - White	CT2WH - add \$1,837
CU1	
Dual Power Underside - Black	CU1-1C - add \$731
Dual Power Underside with Wireless Charging - Black	CU1-1CW - add \$1,691
CT2U1	
Dual Power Center Top - Black with Underside	CT2U1-BL - add \$2,235
Dual Power Center Top - White with Underside	CT2U1-WH - add \$2,235
Dual Power Center Top - Black with Wireless Charging	CT2U1-BLW2 - add \$3,194
Dual Power Center Top - White with Wireless Charging	CT2U1-WHW2 - add \$3,194

Note: Order power infeed that best fits application

To Order Specify

① Veneer Model #	② Edge Detail	③ Wood Collection	④ Wood Finish	⑤ Electrical	⑥ Metal Color
Veneer (LKV)	<a href="#">See Edge Detail Options</a>	Essentials	<a href="#">See Essentials Wood Finish Options</a>	N None CT2 Dual Power Center Top CU2 Dual Power Underside CT2U1 Dual Power Center Top with Underside (See chart above)	<a href="#">See Metal Finish Color Options</a>
		Artisan	④ Wood Finish <a href="#">See Artisan Wood Finish Options</a>		

① Solid Surface Model #	② Top Surface Selection	③ Electrical	④ Metal Color
Solid Surface (LKS)	<a href="#">See Solid Surface Top Surface Selection Options</a>	N None CT2 Dual Power Center Top CU2 Dual Power Underside CT2U1 Dual Power Center Top with Underside (See chart above)	<a href="#">See Metal Finish Color Options</a>

LOK - CONFERENCE

Description

Oval Table with Y Base at Bar Height

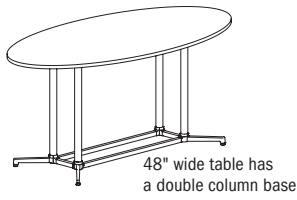

D	W	H	CTN WT	CU FT	Model
48	96	42	198	132	LKT4896-42OVY
42	84	42	153	103	LKT4284-42OVY

LAMINATE

Laminate Tables "LKT" Models

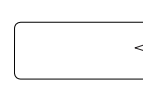

Eased Edge (R3)

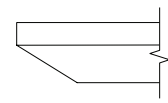

Reverse Bevel Edge (K9)

Standard Tier 1	Graded In Tier 2	Standard Tier 1	Graded In Tier 2
\$3,234	\$3,281	\$3,789	\$3,837

Features:

- price reflects complete table - top and base
- ships KD in multiple cartons
- one piece top
- model includes adjustable glide

Options:

- specify power/charging option, see below for options and upcharges

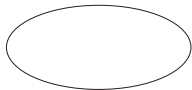
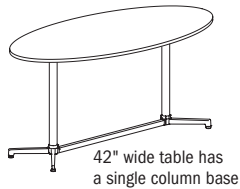

top shape

LOK - CONFERENCE

To Order Specify

1 Laminite Model #	2 Edge Detail	3 Laminite Selection	3a PVC Edge Color	4 Electrical	5 Metal Color
Laminite (LKT)	<a href="#">See Edge Detail Options</a>	<a href="#">See Laminite Selection</a>	<a href="#">See PVC Edge Color Options</a>	N None CT2 Dual Power Center Top CU2 Dual Power Underside CT2U1 Dual Power Center Top with Underside (See chart on next page)	<a href="#">See Metal Finish Color Options</a>

Model Number Breakdown

LKT4896-42OVY					
LK	T	4896	42	OV	Y
LOK	Laminite	48" x 96"	Height	Oval Top Shape	Y Base

Description

Oval Table with Y Base at Bar Height  
(continued)

Veneer Tables  
"LKV" Models

Solid Surface Tables  
"LKS" Models

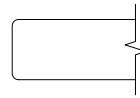

Eased Edge (R3)

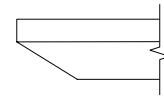

Reverse Bevel Edge (K9)

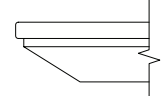

Reverse Bevel Edge (K7)

	D	W	H	CTN WT	CU FT	① Model	Veneer Tables "LKV" Models		Solid Surface Tables "LKS" Models		
							Essentials	Artisan	Essentials	Artisan	Standard
VENEER	48	96	42	198	132	LKV4896-420VY	\$5,290	\$5,708	\$5,673	\$6,061	--
	42	84	42	153	103	LKV4284-420VY	\$4,830	\$5,216	\$5,266	\$5,606	--
SOL. SURF.	48	96	42	198	132	LKS4896-420VY	--	--	--	--	\$12,537
	42	84	42	153	103	LKS4284-420VY	--	--	--	--	\$9,473

Electrical Options and Upcharges

CT2	84 - 96 wide
Dual Power Center Top - Black	CT2BL - add \$1,837
Dual Power Center Top - White	CT2WH - add \$1,837
CU1	
Dual Power Underside - Black	CU1-1C - add \$731
Dual Power Underside with Wireless Charging - Black	CU1-1CW - add \$1,691
CT2U1	
Dual Power Center Top - Black with Underside	CT2U1-BL - add \$2,235
Dual Power Center Top - White with Underside	CT2U1-WH - add \$2,235
Dual Power Center Top - Black with Wireless Charging	CT2U1-BLW2 - add \$3,194
Dual Power Center Top - White with Wireless Charging	CT2U1-WHW2 - add \$3,194

Note: Order power infeed that best fits application

To Order Specify

① Veneer Model #	② Edge Detail	③ Wood Collection	④ Wood Finish	⑤ Electrical	⑥ Metal Color
Veneer (LKV)	<a href="#">See Edge Detail Options</a>	Essentials	<a href="#">See Essentials Wood Finish Options</a>	N None CT2 Dual Power Center Top CU2 Dual Power Underside CT2U1 Dual Power Center Top with Underside (See chart above)	<a href="#">See Metal Finish Color Options</a>
		Artisan	④ Wood Finish <a href="#">See Artisan Wood Finish Options</a>		

① Solid Surface Model #	② Top Surface Selection	③ Electrical	④ Metal Color
Solid Surface (LKS)	<a href="#">See Solid Surface Top Surface Selection Options</a>	N None CT2 Dual Power Center Top CU2 Dual Power Underside CT2U1 Dual Power Center Top with Underside (See chart above)	<a href="#">See Metal Finish Color Options</a>

LOK - CONFERENCE

Description

Boat Table with T Base at Bar Height

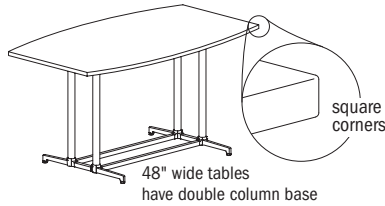

Laminate Tables  
"LKT" Models

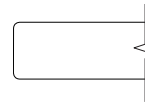

Eased Edge (R3)

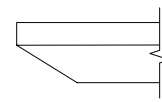

Reverse Bevel Edge (K9)

LAMINATE	D	W	H	CTN WT	CU FT	Model	Eased Edge (R3)		Reverse Bevel Edge (K9)	
							Standard Tier 1	Graded In Tier 2	Standard Tier 1	Graded In Tier 2
		48	96	42	216	132	LKT4896-42BTT	\$4,189	\$4,253	\$4,771
	48	84	42	210	117	LKT4884-42BTT	\$3,815	\$3,871	\$4,383	\$4,436
	42	96	42	183	118	LKT4296-42BTT	\$3,718	\$3,774	\$4,287	\$4,342
	42	84	42	209	105	LKT4284-42BTT	\$3,812	\$3,860	\$4,365	\$4,415
	36	96	42	162	102	LKT3696-42BTT	\$3,160	\$3,209	\$3,713	\$3,760
	36	84	42	146	90	LKT3684-42BTT	\$2,856	\$2,897	\$3,396	\$3,438

Features:

- price reflects complete table - top and base
- ships KD in multiple cartons
- one piece top
- model includes adjustable glide

Options:

- specify power/charging option, see below for options and upcharges

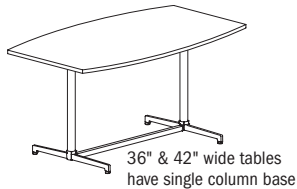

top shape

LOK - CONFERENCE

To Order Specify

1 Laminate Model #	2 Edge Detail	3 Laminate Selection	3a PVC Edge Color	4 Electrical	5 Metal Color
Laminate (LKT)	<a href="#">See Edge Detail Options</a>	<a href="#">See Laminate Selection</a>	<a href="#">See PVC Edge Color Options</a>	N None CT2 Dual Power Center Top CU2 Dual Power Underside CT2U1 Dual Power Center Top with Underside (See chart on next page)	<a href="#">See Metal Finish Color Options</a>

Model Number Breakdown

LKT4896-42BTT					
LK	T	4896	42	BT	T
LOK	Laminate	48" x 96"	Height	Boat Top Shape	T Base

Description

Boat Table with T Base at Bar Height  
(continued)

Veneer Tables  
"LKV" Models

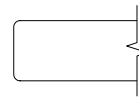

Eased Edge (R3)

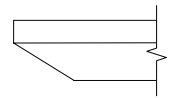

Reverse Bevel Edge (K9)

D	W	H	CTN WT	CU FT	① Model	Essentials		Artisan	
						Essentials	Artisan	Essentials	Artisan
48	96	42	216	132	LKV4896-42BTT	\$5,800	\$6,216	\$6,178	\$6,566
48	84	42	210	117	LKV4884-42BTT	\$5,392	\$5,749	\$5,746	\$6,082
42	96	42	183	118	LKV4296-42BTT	\$5,511	\$5,948	\$6,005	\$6,393
	84	42	209	105	LKV4284-42BTT	\$5,537	\$5,978	\$6,035	\$6,427
36	96	42	162	102	LKV3696-42BTT	\$4,249	\$4,586	\$4,628	\$4,928
36	84	42	146	90	LKV3684-42BTT	\$3,927	\$4,239	\$4,278	\$4,558

VENEER

Electrical Options and Upcharges

CT2	84 - 96 wide
Dual Power Center Top - Black	CT2BL - add \$1,837
Dual Power Center Top - White	CT2WH - add \$1,837
CU1	
Dual Power Underside - Black	CU1-1C - add \$731
Dual Power Underside with Wireless Charging - Black	CU1-1CW - add \$1,691
CT2U1	
Dual Power Center Top - Black with Underside	CT2U1-BL - add \$2,235
Dual Power Center Top - White with Underside	CT2U1-WH - add \$2,235
Dual Power Center Top - Black with Wireless Charging	CT2U1-BLW2 - add \$3,194
Dual Power Center Top - White with Wireless Charging	CT2U1-WhW2 - add \$3,194

Note: Order power infeed that best fits application

To Order Specify

① Veneer Model #	② Edge Detail	③ Wood Collection	④ Wood Finish	⑤ Electrical	⑥ Metal Color
Veneer (LKV)	<a href="#">See Edge Detail Options</a>	Essentials	<a href="#">See Essentials Wood Finish Options</a>	N None CT2 Dual Power Center Top CU2 Dual Power Underside CT2U1 Dual Power Center Top with Underside (See chart above)	<a href="#">See Metal Finish Color Options</a>
		Artisan	④ Wood Finish <a href="#">See Artisan Wood Finish Options</a>		

LOK- CONFERENCE

## Description

Boat Table with Y Base at Bar Height

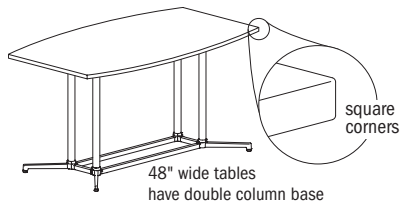

## Laminate Tables "LKT" Models

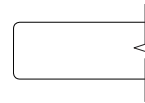

Eased Edge (R3)

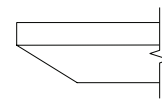

Reverse Bevel Edge (K9)

LAMINATE	D	W	H	CTN WT	CU FT	① Model	Eased Edge (R3)		Reverse Bevel Edge (K9)	
							Standard Tier 1	Graded In Tier 2	Standard Tier 1	Graded In Tier 2
	48	96	42	231	132	LKT4896-42BTY	\$4,089	\$4,152	\$4,671	\$4,735
	48	84	42	209	117	LKT4884-42BTY	\$3,609	\$3,667	\$4,180	\$4,235
	42	96	42	198	118	LKT4296-42BTY	\$4,627	\$4,681	\$5,193	\$5,249
	42	84	42	175	103	LKT4284-42BTY	\$3,234	\$3,281	\$3,789	\$3,837
	36	96	42	175	102	LKT3696-42BTY	\$3,249	\$3,298	\$3,800	\$3,848
	36	84	42	156	90	LKT3684-42BTY	\$2,893	\$2,936	\$3,433	\$3,477

### Features:

- price reflects complete table - top and base
- ships KD in multiple cartons
- one piece top
- model includes adjustable glide

### Options:

- specify power/charging option, see below for options and upcharges

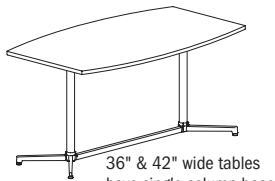

top shape

LOK - CONFERENCE

## To Order Specify

① Laminate Model #	② Edge Detail	③ Laminate Selection	④ PVC Edge Color	⑤ Electrical	⑥ Metal Color
Laminate (LKT)	<a href="#">See Edge Detail Options</a>	<a href="#">See Laminate Selection</a>	<a href="#">See PVC Edge Color Options</a>	N None CT2 Dual Power Center Top CU2 Dual Power Underside CT2U1 Dual Power Center Top with Underside (See chart on next page)	<a href="#">See Metal Finish Color Options</a>

## Model Number Breakdown

LKT4896-42BTY					
LK	T	4896	42	BT	Y
LOK	Laminate	48" x 96"	Height	Boat Top Shape	Y Base

Description

Boat Table with Y Base at Bar Height  
(continued)

Veneer Tables  
"LKV" Models

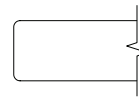

Eased Edge (R3)

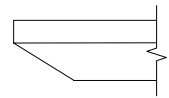

Reverse Bevel Edge (K9)

D	W	H	CTN WT	CU FT	① Model	Essentials		Artisan	
						Essentials	Artisan	Essentials	Artisan
48	96	42	231	132	LKV4896-42BTY	\$5,671	\$6,085	\$6,051	\$6,437
48	84	42	209	117	LKV4884-42BTY	\$5,136	\$5,495	\$5,489	\$5,824
42	96	42	198	118	LKV4296-42BTY	\$6,645	\$7,176	\$7,244	\$7,714
	84	42	175	103	LKV4284-42BTY	\$4,830	\$5,216	\$5,266	\$5,606
36	96	42	175	102	LKV3696-42BTY	\$4,356	\$4,705	\$4,747	\$5,057
36	84	42	156	90	LKV3684-42BTY	\$3,973	\$4,292	\$4,329	\$4,613

VENEER

Electrical Options and Upcharges

CT2	84 - 96 wide
Dual Power Center Top - Black	CT2BL - add \$1,837
Dual Power Center Top - White	CT2WH - add \$1,837
CU1	
Dual Power Underside - Black	CU1-1C - add \$731
Dual Power Underside with Wireless Charging - Black	CU1-1CW - add \$1,691
CT2U1	
Dual Power Center Top - Black with Underside	CT2U1-BL - add \$2,235
Dual Power Center Top - White with Underside	CT2U1-WH - add \$2,235
Dual Power Center Top - Black with Wireless Charging	CT2U1-BLW2 - add \$3,194
Dual Power Center Top - White with Wireless Charging	CT2U1-WHW2 - add \$3,194

Note: Order power infeed that best fits application

To Order Specify

① Veneer Model #	② Edge Detail	③ Wood Collection	④ Wood Finish	⑤ Electrical	⑥ Metal Color
Veneer (LKV)	<a href="#">See Edge Detail Options</a>	Essentials	<a href="#">See Essentials Wood Finish Options</a>	N None CT2 Dual Power Center Top CU2 Dual Power Underside CT2U1 Dual Power Center Top with Underside (See chart above)	<a href="#">See Metal Finish Color Options</a>
		Artisan	④ Wood Finish <a href="#">See Artisan Wood Finish Options</a>		

LOK - CONFERENCE

Description

Rounded Double Chevron Table with T Base at Bar Height

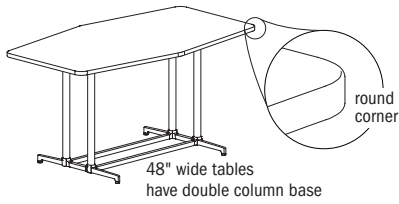

Laminate Tables  
"LKT" Models

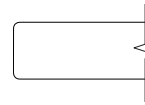

Eased Edge (R3)

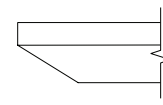

Reverse Bevel Edge (K9)

LAMINATE	D	W	H	CTN WT	CU FT	① Model	Eased Edge (R3)		Reverse Bevel Edge (K9)	
							Standard Tier 1	Graded In Tier 2	Standard Tier 1	Graded In Tier 2
	48	96	42	216	132	LKT4896-42DCRT	\$4,189	\$4,253	\$4,771	\$4,836
	48	84	42	195	117	LKT4884-42DCRT	\$3,815	\$3,871	\$4,383	\$4,436
	42	96	42	189	118	LKT4296-42DCRT	\$3,718	\$3,774	\$4,287	\$4,342
	42	84	42	195	105	LKT4284-42DCRT	\$3,812	\$3,860	\$4,365	\$4,415
	36	96	42	152	102	LKT3696-42DCRT	\$3,160	\$3,209	\$3,713	\$3,760
	36	84	42	135	90	LKT3684-42DCRT	\$2,856	\$2,897	\$3,396	\$3,438

Features:

- price reflects complete table - top and base
- ships KD in multiple cartons
- one piece top
- model includes adjustable glide

Options:

- specify power/charging option, see below for options and upcharges

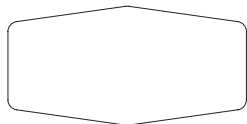
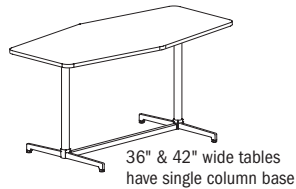

top shape

LOK - CONFERENCE

To Order Specify

① Laminate Model #	② Edge Detail	③ Laminate Selection	④ PVC Edge Color	⑤ Electrical	⑥ Metal Color
Laminate (LKT)	<a href="#">See Edge Detail Options</a>	<a href="#">See Laminate Selection</a>	<a href="#">See PVC Edge Color Options</a>	N None CT2 Dual Power Center Top CU2 Dual Power Underside CT2U1 Dual Power Center Top with Underside (See chart on next page)	<a href="#">See Metal Finish Color Options</a>

Model Number Breakdown

LKT4896-42DCRT						
LK	T	4896	42	DC	R	T
LOK	Laminate	48" x 96"	Height	Double Chevron Top Shape	Rounded Corner	T Base

Description

Rounded Double Chevron Table with T Base at Bar Height (continued)

Veneer Tables "LKV" Models      Solid Surface Tables "LKS" Models

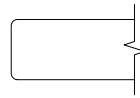

Eased Edge (R3)

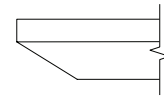

Reverse Bevel Edge (K9)

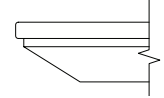

Reverse Bevel Edge (K7)

	D	W	H	CTN WT	CU FT	① Model	Veneer Tables		Solid Surface Tables		
							Essentials	Artisan	Essentials	Artisan	Standard
VENEER	48	96	42	216	132	LKV4896-42DCRT	\$5,800	\$6,216	\$6,178	\$6,566	--
	48	84	42	195	117	LKV4884-42DCRT	\$5,392	\$5,749	\$5,746	\$6,082	--
	42	96	42	189	118	LKV4296-42DCRT	\$5,511	\$5,948	\$6,005	\$6,393	--
	42	84	42	195	105	LKV4284-42DCRT	\$5,537	\$5,978	\$6,035	\$6,427	--
	36	96	42	152	102	LKV3696-42DCRT	\$4,249	\$4,586	\$4,628	\$4,928	--
	36	84	42	135	90	LKV3684-42DCRT	\$3,927	\$4,239	\$4,278	\$4,558	--
SOLID SURFACE	48	96	42	216	132	LKS4896-42DCRT	--	--	--	--	\$13,043
	48	84	42	195	117	LKS4884-42DCRT	--	--	--	--	\$11,678
	42	96	42	189	118	LKS4296-42DCRT	--	--	--	--	\$10,534
	42	84	42	195	105	LKS4284-42DCRT	--	--	--	--	\$10,183
	36	96	42	152	102	LKS3696-42DCRT	--	--	--	--	\$9,284
	36	84	42	135	90	LKS3684-42DCRT	--	--	--	--	\$8,390

Electrical Options and Upcharges

CT2	84 - 96 wide
Dual Power Center Top - Black	CT2BL - add \$1,837
Dual Power Center Top - White	CT2WH - add \$1,837
CU1	
Dual Power Underside - Black	CU1-1C - add \$731
Dual Power Underside with Wireless Charging - Black	CU1-1CW - add \$1,691
CT2U1	
Dual Power Center Top - Black with Underside	CT2U1-BL - add \$2,235
Dual Power Center Top - White with Underside	CT2U1-WH - add \$2,235
Dual Power Center Top - Black with Wireless Charging	CT2U1-BLW2 - add \$3,194
Dual Power Center Top - White with Wireless Charging	CT2U1-WHW2 - add \$3,194

Note: Order power infeed that best fits application

To Order Specify

① Veneer Model #	② Edge Detail	③ Wood Collection	④ Wood Finish	⑤ Electrical	⑥ Metal Color
Veneer (LKV)	<a href="#">See Edge Detail Options</a>	Essentials	<a href="#">See Essentials Wood Finish Options</a>	N None CT2 Dual Power Center Top CU2 Dual Power Underside CT2U1 Dual Power Center Top with Underside (See chart above)	<a href="#">See Metal Finish Color Options</a>
		Artisan	④ Wood Finish <a href="#">See Artisan Wood Finish Options</a>		

① Solid Surface Model #	② Top Surface Selection	③ Electrical	④ Metal Color
Solid Surface (LKS)	<a href="#">See Solid Surface Top Surface Selection Options</a>	N None CT2 Dual Power Center Top CU2 Dual Power Underside CT2U1 Dual Power Center Top with Underside (See chart above)	<a href="#">See Metal Finish Color Options</a>

LOK - CONFERENCE

Description

Rounded Double Chevron Table with Y Base at Bar Height

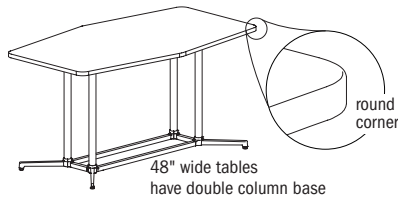

Laminate Tables  
"LKT" Models

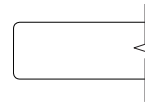

Eased Edge (R3)

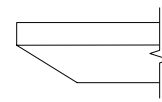

Reverse Bevel Edge (K9)

D	W	H	CTN WT	CU FT	① Model	Eased Edge (R3)		Reverse Bevel Edge (K9)	
						Standard Tier 1	Graded In Tier 2	Standard Tier 1	Graded In Tier 2
48	96	42	211	132	LKT4896-42DCRY	\$4,089	\$4,152	\$4,671	\$4,735
48	84	42	194	117	LKT4884-42DCRY	\$3,609	\$3,667	\$4,180	\$4,235
42	96	42	175	118	LKT4296-42DCRY	\$4,627	\$4,681	\$5,193	\$5,249
42	84	42	159	103	LKT4284-42DCRY	\$3,234	\$3,281	\$3,789	\$3,837
36	96	42	175	102	LKT3696-42DCRY	\$3,249	\$3,298	\$3,800	\$3,848
36	84	42	154	90	LKT3684-42DCRY	\$2,893	\$2,936	\$3,433	\$3,477

LAMINATE

Features:

- price reflects complete table - top and base
- ships KD in multiple cartons
- one piece top
- model includes adjustable glide

Options:

- specify power/charging option, see below for options and upcharges

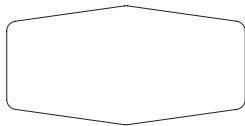
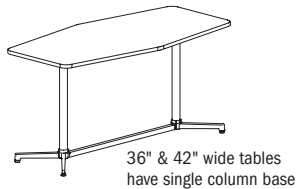

top shape

LOK - CONFERENCE

To Order Specify

① Laminate Model #	② Edge Detail	③ Laminate Selection	④ PVC Edge Color	⑤ Electrical	⑥ Metal Color
Laminate (LKT)	<a href="#">See Edge Detail Options</a>	<a href="#">See Laminate Selection</a>	<a href="#">See PVC Edge Color Options</a>	N None CT2 Dual Power Center Top CU2 Dual Power Underside CT2U1 Dual Power Center Top with Underside (See chart on next page)	<a href="#">See Metal Finish Color Options</a>

Model Number Breakdown

LKT4896-42DCRY						
LK	T	4896	42	DC	R	Y
LOK	Laminate	48" x 96"	Height	Double Chevron Top Shape	Rounded Corner	Y Base

Description

Rounded Double Chevron Table with Y Base at Bar Height (continued)

Veneer Tables "LKV" Models      Solid Surface Tables "LKS" Models

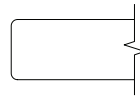

Eased Edge (R3)

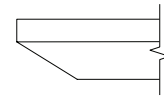

Reverse Bevel Edge (K9)

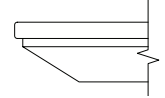

Reverse Bevel Edge (K7)

	D	W	H	CTN WT	CU FT	① Model	Veneer		Solid Surface		
							Essentials	Artisan	Essentials	Artisan	Standard
VENEER	48	96	42	211	132	LKV4896-42DCRY	\$5,671	\$6,085	\$6,051	\$6,437	--
	48	84	42	194	117	LKV4884-42DCRY	\$5,136	\$5,495	\$5,489	\$5,824	--
	42	96	42	175	118	LKV4296-42DCRY	\$6,645	\$7,176	\$7,244	\$7,714	--
	42	84	42	159	103	LKV4284-42DCRY	\$4,830	\$5,216	\$5,266	\$5,606	--
	36	96	42	175	102	LKV3696-42DCRY	\$4,356	\$4,705	\$4,747	\$5,057	--
	36	84	42	154	90	LKV3684-42DCRY	\$3,973	\$4,292	\$4,329	\$4,613	--
SOLID SURFACE	48	96	42	211	132	LKS4896-42DCRY	--	--	--	--	\$12,914
	48	84	42	194	117	LKS4884-42DCRY	--	--	--	--	\$11,421
	42	96	42	175	118	LKS4296-42DCRY	--	--	--	--	\$11,670
	42	84	42	159	103	LKS4284-42DCRY	--	--	--	--	\$9,473
	36	96	42	175	102	LKS3696-42DCRY	--	--	--	--	\$9,389
	36	84	42	154	90	LKS3684-42DCRY	--	--	--	--	\$8,440

Electrical Options and Upcharges

CT2	84 - 96 wide
Dual Power Center Top - Black	CT2BL - add \$1,837
Dual Power Center Top - White	CT2WH - add \$1,837
CU1	
Dual Power Underside - Black	CU1-1C - add \$731
Dual Power Underside with Wireless Charging - Black	CU1-1CW - add \$1,691
CT2U1	
Dual Power Center Top - Black with Underside	CT2U1-BL - add \$2,235
Dual Power Center Top - White with Underside	CT2U1-WH - add \$2,235
Dual Power Center Top - Black with Wireless Charging	CT2U1-BLW2 - add \$3,194
Dual Power Center Top - White with Wireless Charging	CT2U1-WHW2 - add \$3,194

Note: Order power infeed that best fits application

To Order Specify

① Veneer Model #	② Edge Detail	③ Wood Collection	④ Wood Finish	⑤ Electrical	⑥ Metal Color
Veneer (LKV)	<a href="#">See Edge Detail Options</a>	Essentials	<a href="#">See Essentials Wood Finish Options</a>	N None CT2 Dual Power Center Top CU2 Dual Power Underside CT2U1 Dual Power Center Top with Underside (See chart above)	<a href="#">See Metal Finish Color Options</a>
		Artisan	④ Wood Finish <a href="#">See Artisan Wood Finish Options</a>		

① Solid Surface Model #	② Top Surface Selection	③ Electrical	④ Metal Color
Solid Surface (LKS)	<a href="#">See Solid Surface Top Surface Selection Options</a>	N None CT2 Dual Power Center Top CU2 Dual Power Underside CT2U1 Dual Power Center Top with Underside (See chart above)	<a href="#">See Metal Finish Color Options</a>

LOK - CONFERENCE

Description

Taper Table with T Base at Bar Height

Laminate Tables  
"LKT" Models

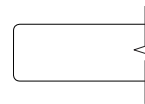
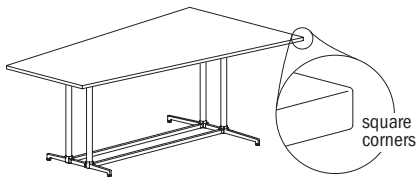

Eased Edge (R3)

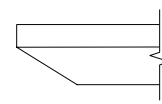

Reverse Bevel Edge (K9)

LAMI	D	W	H	CTN WT	CU FT	Model	Eased Edge (R3)		Reverse Bevel Edge (K9)	
							Standard Tier 1	Graded In Tier 2	Standard Tier 1	Graded In Tier 2
	54	96	42	228	147	LKT5496-42TPT	\$4,480	\$4,552	\$5,077	\$5,148

Features:

- price reflects complete table - top and base
- ships KD in multiple cartons
- one piece top
- model includes adjustable glide

Options:

- specify power/charging option, see below for options and upcharges

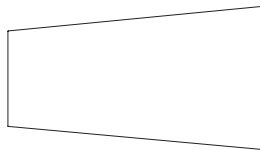

top shape

LOK - CONFERENCE

To Order Specify

1 Laminates Model #	2 Edge Detail	3 Laminate Selection	3a PVC Edge Color	4 Electrical	5 Metal Color
Laminates (LKT)	<a href="#">See Edge Detail Options</a>	<a href="#">See Laminate Selection</a>	<a href="#">See PVC Edge Color Options</a>	N None CT2 Dual Power Center Top CU2 Dual Power Underside CT2U1 Dual Power Center Top with Underside (See chart on next page)	<a href="#">See Metal Finish Color Options</a>

Model Number Breakdown

LKT5496-42TPT					
LK	T	5496	42	TP	T
LOK	Laminates	54" x 96"	Height	Taper Top Shape	T Base

Description

Taper Table with T Base at Bar Height  
(continued)

Veneer Tables  
"LKV" Models

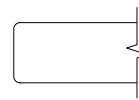

Eased Edge (R3)

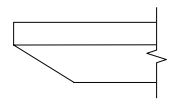

Reverse Bevel Edge (K9)

VEN.	D	W	H	CTN WT	CU FT	1 Model	Essentials	Artisan	Essentials	Artisan
	54	96	42	228	147	LKV5496-42TPT	\$6,115	\$6,601	\$6,664	\$7,096

Electrical Options and Upcharges

CT2	84 - 96 wide
Dual Power Center Top - Black	CT2BL - add \$1,837
Dual Power Center Top - White	CT2WH - add \$1,837
CU1	
Dual Power Underside - Black	CU1-1C - add \$731
Dual Power Underside with Wireless Charging - Black	CU1-1CW - add \$1,691
CT2U1	
Dual Power Center Top - Black with Underside	CT2U1-BL - add \$2,235
Dual Power Center Top - White with Underside	CT2U1-WH - add \$2,235
Dual Power Center Top - Black with Wireless Charging	CT2U1-BLW2 - add \$3,194
Dual Power Center Top - White with Wireless Charging	CT2U1-WHW2 - add \$3,194

Note: Order power infeed that best fits application

To Order Specify

1 Veneer Model #	2 Edge Detail	3 Wood Collection	4 Wood Finish	5 Electrical	6 Metal Color
Veneer (LKV)	<a href="#">See Edge Detail Options</a>	Essentials	<a href="#">See Essentials Wood Finish Options</a>	N None CT2 Dual Power Center Top CU2 Dual Power Underside CT2U1 Dual Power Center Top with Underside (See chart above)	<a href="#">See Metal Finish Color Options</a>
		Artisan	4 Wood Finish <a href="#">See Artisan Wood Finish Options</a>		

Description

Rounded Taper Table with T Base at Bar Height

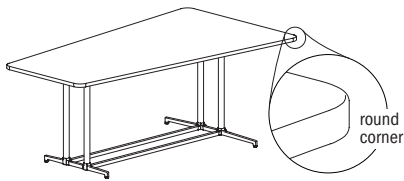

Laminate Tables "LKT" Models

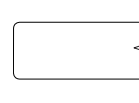

Eased Edge (R3)

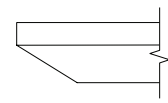

Reverse Bevel Edge (K9)

LAMI	D	W	H	CTN WT	CU FT	Model	Standard Tier 1	Graded In Tier 2	Standard Tier 1	Graded In Tier 2
		54	96	42	228	147	LKT5496-42TPRT	\$4,480	\$4,552	\$5,077

Features:

- price reflects complete table - top and base
- ships KD in multiple cartons
- one piece top
- model includes adjustable glide

Options:

- specify power/charging option, see below for options and upcharges

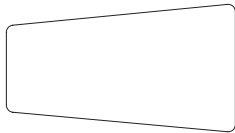

top shape

LOK - CONFERENCE

To Order Specify

1 Laminate Model #	2 Edge Detail	3 Laminate Selection	3a PVC Edge Color	4 Electrical	5 Metal Color
Laminate (LKT)	<a href="#">See Edge Detail Options</a>	<a href="#">See Laminate Selection</a>	<a href="#">See PVC Edge Color Options</a>	N None CT2 Dual Power Center Top CU2 Dual Power Underside CT2U1 Dual Power Center Top with Underside (See chart on next page)	<a href="#">See Metal Finish Color Options</a>

Model Number Breakdown

LKT5496-42TPRT						
LK	T	5496	42	TP	R	T
LOK	Laminate	54" x 96"	Height	Taper Top Shape	Rounded Corner	T Base

Description

Rounded Taper Table with T Base at Bar Height (continued)

Veneer Tables "LKV" Models      Solid Surface Tables "LKS" Models

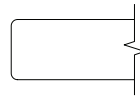

Eased Edge (R3)

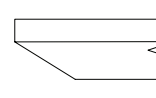

Reverse Bevel Edge (K9)

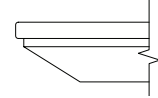

Reverse Bevel Edge (K7)

	D	W	H	CTN WT	CU FT	Model	Essentials	Artisan	Essentials	Artisan	Standard
VEN.	54	96	42	228	147	LKV5496-42TPRT	\$6,115	\$6,601	\$6,664	\$7,096	--
S.S.	54	96	42	228	147	LKS5496-42TPRT	--	--	--	--	\$16,937

Electrical Options and Upcharges

CT2	84 - 96 wide
Dual Power Center Top - Black	CT2BL - add \$1,837
Dual Power Center Top - White	CT2WH - add \$1,837
CU1	
Dual Power Underside - Black	CU1-1C - add \$731
Dual Power Underside with Wireless Charging - Black	CU1-1CW - add \$1,691
CT2U1	
Dual Power Center Top - Black with Underside	CT2U1-BL - add \$2,235
Dual Power Center Top - White with Underside	CT2U1-WH - add \$2,235
Dual Power Center Top - Black with Wireless Charging	CT2U1-BLW2 - add \$3,194
Dual Power Center Top - White with Wireless Charging	CT2U1-WHW2 - add \$3,194

LOK - CONFERENCE

Note: Order power infeed that best fits application

To Order Specify

1 Veneer Model #	2 Edge Detail	3 Wood Collection	4 Wood Finish	5 Electrical	6 Metal Color
Veneer (LKV)	<a href="#">See Edge Detail Options</a>	Essentials	<a href="#">See Essentials Wood Finish Options</a>	N None CT2 Dual Power Center Top CU2 Dual Power Underside CT2U1 Dual Power Center Top with Underside (See chart above)	<a href="#">See Metal Finish Color Options</a>
		Artisan	<b>4 Wood Finish</b> <a href="#">See Artisan Wood Finish Options</a>		

1 Solid Surface Model #	2 Top Surface Selection	3 Electrical	4 Metal Color
Solid Surface (LKS)	<a href="#">See Solid Surface Top Surface Selection Options</a>	N None CT2 Dual Power Center Top CU2 Dual Power Underside CT2U1 Dual Power Center Top with Underside (See chart above)	<a href="#">See Metal Finish Color Options</a>

Description

Taper Table with Y Base at Bar Height

Laminate Tables  
"LKT" Models

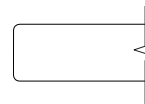
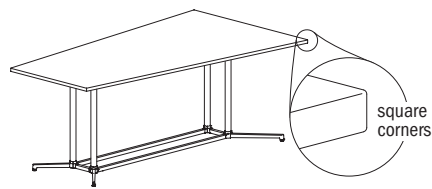

Eased Edge (R3)

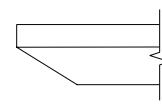

Reverse Bevel Edge (K9)

LAMI	D	W	H	CTN WT	CU FT	Model	Standard Tier 1	Graded In Tier 2	Standard Tier 1	Graded In Tier 2
		54	96	42	198	147	LKT5496-42TPY	\$4,336	\$4,406	\$4,933

Features:

- price reflects complete table - top and base
- ships KD in multiple cartons
- one piece top
- model includes adjustable glide

Options:

- specify power/charging option, see below for options and upcharges

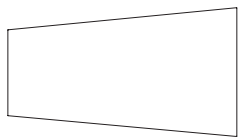

top shape

LOK - CONFERENCE

To Order Specify

1 Laminate Model #	2 Edge Detail	3 Laminate Selection	3a PVC Edge Color	4 Electrical	5 Metal Color
Laminate (LKT)	<a href="#">See Edge Detail Options</a>	<a href="#">See Laminate Selection</a>	<a href="#">See PVC Edge Color Options</a>	N None CT2 Dual Power Center Top CU2 Dual Power Underside CT2U1 Dual Power Center Top with Underside (See chart on next page)	<a href="#">See Metal Finish Color Options</a>

Model Number Breakdown

LKT5496-42TPY					
LK	T	5496	42	TP	Y
LOK	Laminate	54" x 96"	Height	Taper Top Shape	Y Base

Description

Taper Table with Y Base at Bar Height  
(continued)

Veneer Tables  
"LKV" Models

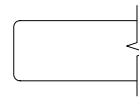

Eased Edge (R3)

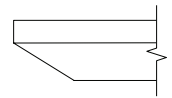

Reverse Bevel Edge (K9)

	D	W	H	CTN WT	CU FT	① Model	Essentials	Artisan	Essentials	Artisan
VEN.	54	96	42	198	147	LKV5496-42TPY	\$5,938	\$6,414	\$6,474	\$6,891

Electrical Options and Upcharges

	84 - 96 wide
<b>CT2</b>	
Dual Power Center Top - Black	CT2BL - add \$1,837
Dual Power Center Top - White	CT2WH - add \$1,837
<b>CU1</b>	
Dual Power Underside - Black	CU1-1C - add \$731
Dual Power Underside with Wireless Charging - Black	CU1-1CW - add \$1,691
<b>CT2U1</b>	
Dual Power Center Top - Black with Underside	CT2U1-BL - add \$2,235
Dual Power Center Top - White with Underside	CT2U1-WH - add \$2,235
Dual Power Center Top - Black with Wireless Charging	CT2U1-BLW2 - add \$3,194
Dual Power Center Top - White with Wireless Charging	CT2U1-WHW2 - add \$3,194

Note: Order power infeed that best fits application

To Order Specify

① Veneer Model #	② Edge Detail	③ Wood Collection	④ Wood Finish	⑤ Electrical	⑥ Metal Color
Veneer (LKV)	<a href="#">See Edge Detail Options</a>	Essentials	<a href="#">See Essentials Wood Finish Options</a>	N None CT2 Dual Power Center Top CU2 Dual Power Underside CT2U1 Dual Power Center Top with Underside (See chart above)	<a href="#">See Metal Finish Color Options</a>
		Artisan	④ Wood Finish <a href="#">See Artisan Wood Finish Options</a>		

Description

Rounded Taper Table with Y Base at Bar Height

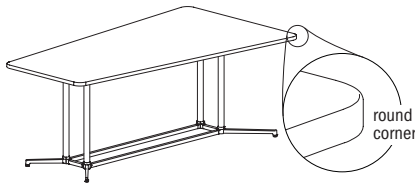

Laminate Tables  
"LKT" Models

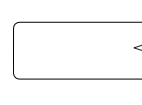

Eased Edge (R3)

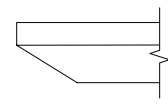

Reverse Bevel Edge (K9)

LAMI	D	W	H	CTN WT	CU FT	Model	Standard Tier 1	Graded In Tier 2	Standard Tier 1	Graded In Tier 2
		54	96	42	198	147	LKT5496-42TPRY	\$4,336	\$4,406	\$4,933

Features:

- price reflects complete table - top and base
- ships KD in multiple cartons
- one piece top
- model includes adjustable glide

Options:

- specify power/charging option, see below for options and upcharges

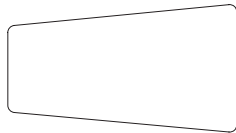

top shape

LOK - CONFERENCE

To Order Specify

1 Laminate Model #	2 Edge Detail	3 Laminate Selection	3a PVC Edge Color	4 Electrical	5 Metal Color
Laminate (LKT)	<a href="#">See Edge Detail Options</a>	<a href="#">See Laminate Selection</a>	<a href="#">See PVC Edge Color Options</a>	N None CT2 Dual Power Center Top CU2 Dual Power Underside CT2U1 Dual Power Center Top with Underside (See chart on next page)	<a href="#">See Metal Finish Color Options</a>

Model Number Breakdown

LKT5496-42TPRY						
LK	T	5496	42	TP	R	Y
LOK	Laminate	54" x 96"	Height	Taper Top Shape	Rounded Corner	Y Base

Description

Rounded Taper Table with Y Base at Bar Height (continued)

Veneer Tables "LKV" Models      Solid Surface Tables "LKS" Models

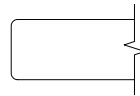

Eased Edge (R3)

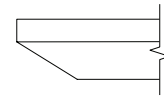

Reverse Bevel Edge (K9)

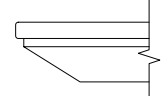

Reverse Bevel Edge (K7)

	D	W	H	CTN WT	CU FT	Model	Essentials	Artisan	Essentials	Artisan	Standard
VEN.	54	96	42	198	147	LKV5496-42TPRY	\$5,938	\$6,414	\$6,474	\$6,891	--
S.S.	54	96	42	198	147	LKS5496-42TPRY	--	--	--	--	\$16,761

Electrical Options and Upcharges

CT2	84 - 96 wide
Dual Power Center Top - Black	CT2BL - add \$1,837
Dual Power Center Top - White	CT2WH - add \$1,837
CU1	
Dual Power Underside - Black	CU1-1C - add \$731
Dual Power Underside with Wireless Charging - Black	CU1-1CW - add \$1,691
CT2U1	
Dual Power Center Top - Black with Underside	CT2U1-BL - add \$2,235
Dual Power Center Top - White with Underside	CT2U1-WH - add \$2,235
Dual Power Center Top - Black with Wireless Charging	CT2U1-BLW2 - add \$3,194
Dual Power Center Top - White with Wireless Charging	CT2U1-WHW2 - add \$3,194

Note: Order power infeed that best fits application

To Order Specify

1 Veneer Model #	2 Edge Detail	3 Wood Collection	4 Wood Finish	5 Electrical	6 Metal Color
Veneer (LKV)	<a href="#">See Edge Detail Options</a>	Essentials	<a href="#">See Essentials Wood Finish Options</a>	N None CT2 Dual Power Center Top CU2 Dual Power Underside CT2U1 Dual Power Center Top with Underside (See chart above)	<a href="#">See Metal Finish Color Options</a>
		Artisan	<b>4 Wood Finish</b> <a href="#">See Artisan Wood Finish Options</a>		

1 Solid Surface Model #	2 Top Surface Selection	3 Electrical	4 Metal Color
Solid Surface (LKS)	<a href="#">See Solid Surface Top Surface Selection Options</a>	N None CT2 Dual Power Center Top CU2 Dual Power Underside CT2U1 Dual Power Center Top with Underside (See chart above)	<a href="#">See Metal Finish Color Options</a>

LOK - CONFERENCE

Description

Round Table with X Base at Bar Height



Laminate Tables  
"LKT" Models

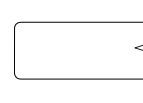

Eased Edge (R3)

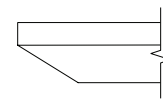

Reverse Bevel Edge (K9)

LAMINATE	D	W	H	CTN WT	CU FT	1 Model	Eased Edge (R3)		Reverse Bevel Edge (K9)	
							Standard	Graded In	Standard	Graded In
							Tier 1	Tier 2	Tier 1	Tier 2
	48	48	42	90	69	LKT48-42RDX	\$2,092	\$2,238	\$2,652	\$2,800
	42	42	42	75	54	LKT42-42RDX	\$1,926	\$2,070	\$2,488	\$2,632
	36	36	42	60	41	LKT36-42RDX	\$1,867	\$1,921	\$2,429	\$2,482
	30	30	42	50	30	LKT30-42RDX	\$1,804	\$1,845	\$2,365	\$2,407

Features:

- price reflects complete table - top and base
- ships KD in multiple cartons
- one piece top
- model includes adjustable glide
- when electrical option is selected, power accessible base is shipped; see page 178 for details
- power/charging units have 72" cord
- power cord is routed inside base column

Options:

- specify power access base with power unit option; None (N), add \$735 for EC23 (CTEC23), add \$616 for EC24 (CTEC24)

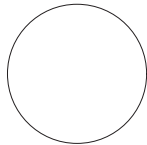

top shape

LOK - CONFERENCE

To Order Specify

1 Laminite Model #	2 Edge Detail	3 Laminite Selection	3a PVC Edge Color	4 Electrical	5 Metal Color
Laminite (LKT)	<a href="#">See Edge Detail Options</a>	<a href="#">See Laminite Selection</a>	<a href="#">See PVC Edge Color Options</a>	N None CTEC23 Power Center Top CTEC24 Power Center Top (See chart on next page)	<a href="#">See Metal Finish Color Options</a>

Model Number Breakdown

LKT48-42RDX					
LK	T	48	42	RD	X
LOK	Laminite	48" dia.	Height	Round Top Shape	X Base

Description

Round Table with X Base at Bar Height  
(continued)

Veneer Tables  
"LKV" Models

Solid Surface Tables  
"LKS" Models

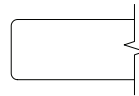

Eased Edge (R3)

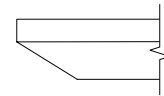

Reverse Bevel Edge (K9)

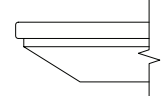

Reverse Bevel Edge (K7)

	D	W	H	CTN WT	CU FT	① Model	Veneer Tables		Solid Surface Tables		
							Essentials	Artisan	Essentials	Artisan	Standard
VENEER	48	48	42	90	69	LKV48-42RDX	\$2,750	\$2,931	\$2,854	\$3,045	--
	42	42	42	75	54	LKV42-42RDX	\$2,525	\$2,690	\$2,620	\$2,795	--
	36	36	42	60	41	LKV36-42RDX	\$2,448	\$2,609	\$2,544	\$2,711	--
	30	30	42	50	30	LKV30-42RDX	\$2,363	\$2,519	\$2,452	\$2,613	--
SOLID SURFACE	48	48	42	90	69	LKS48-42RDX	--	--	--	--	\$6,376
	42	42	42	75	54	LKS42-42RDX	--	--	--	--	\$5,437
	36	36	42	60	41	LKS36-42RDX	--	--	--	--	\$4,745
	30	30	42	50	30	LKS30-42RDX	--	--	--	--	\$4,134

Electrical Options and Upcharges

CTEC23	
EC23 Power Center Top - Black	CTEC23BL - add \$735
EC23 Power Center Top - White	CTEC23WH - add \$735
CTEC24	
EC24 Power Center Top - Black	CTEC43BL - add \$616
EC24 Power Center Top - White	CTEC43WH - add \$616

To Order Specify

① Veneer Model #	② Edge Detail	③ Wood Collection	④ Wood Finish	⑤ Electrical	⑥ Metal Color
Veneer (LKV)	<a href="#">See Edge Detail Options</a>	Essentials	<a href="#">See Essentials Wood Finish Options</a>	N None CTEC23 Power Center Top CTEC24 Power Center Top (See chart above)	<a href="#">See Metal Finish Color Options</a>
		Artisan	④ Wood Finish <a href="#">See Artisan Wood Finish Options</a>		

① Solid Surface Model #	② Top Surface Selection	③ Electrical Cut Out	④ Metal Color
Solid Surface (LKS)	<a href="#">See Solid Surface Top Surface Selection Options</a>	N None CTEC23 Power Center Top CTEC24 Power Center Top (See chart above)	<a href="#">See Metal Finish Color Options</a>

LOK - CONFERENCE

Description

Round Table with X4 Base at Bar Height



Laminate Tables  
"LKT" Models

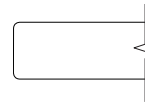

Eased Edge (R3)

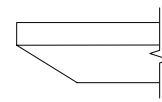

Reverse Bevel Edge (K9)

LAMINATE	D	W	H	CTN WT	CU FT	① Model	Eased Edge (R3)		Reverse Bevel Edge (K9)	
							Standard	Graded In	Standard	Graded In
							Tier 1	Tier 2	Tier 1	Tier 2
	60	60	42	207	94	LKT60-42RDZ	\$3,468	\$3,584	\$4,029	\$4,142
	54	54	42	180	86	LKT54-42RDZ	\$3,248	\$3,339	\$3,808	\$3,898

Features:

- price reflects complete table - top and base
- ships KD in multiple cartons
- one piece top
- model includes adjustable glide
- power cord is routed outside base column
- order vertical wire manager separately; see page 407

Options:

- specify power unit option; None (N), add \$594 for EC23 (CTEC23), add \$474 for EC24 (CTEC24)

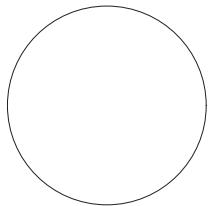

top shape

LOK - CONFERENCE

To Order Specify

① Laminate Model #	② Edge Detail	③ Laminate Selection	④ PVC Edge Color	⑤ Electrical	⑥ Metal Color
Laminate (LKT)	<a href="#">See Edge Detail Options</a>	<a href="#">See Laminate Selection</a>	<a href="#">See PVC Edge Color Options</a>	N None CTEC23 Power Center Top CTEC24 Power Center Top (See chart on next page)	<a href="#">See Metal Finish Color Options</a>

Model Number Breakdown

LKT60-42RDZ					
LK	T	60	42	RD	Z
LOK	Laminate	60" dia.	Height	Round Top Shape	X4 Base

Description

Round Table with X4 Base at Bar Height  
(continued)

Veneer Tables  
"LKV" Models

Solid Surface Tables  
"LKS" Models

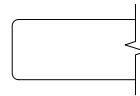

Eased Edge (R3)

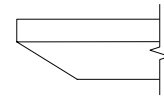

Reverse Bevel Edge (K9)

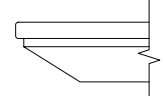

Reverse Bevel Edge (K7)

	D	W	H	CTN WT	CU FT	① Model	Veneer Tables "LKV" Models		Solid Surface Tables "LKS" Models		
							Essentials	Artisan	Essentials	Artisan	Standard
VENEER	60	60	42	207	94	LKV60-42RDZ	\$4,538	\$4,837	\$4,710	\$5,017	--
	54	54	42	180	86	LKV54-42RDZ	\$4,297	\$4,586	\$4,461	\$4,764	--
SOL. SURF.	60	60	42	207	94	LKS60-42RDZ	--	--	--	--	\$9,870
	54	54	42	180	86	LKS54-42RDZ	--	--	--	--	\$8,726

Electrical Options and Upcharges

CTEC23	
EC23 Power Center Top - Black	CTEC23BL - add \$594
EC23 Power Center Top - White	CTEC23WH - add \$594
CTEC24	
EC24 Power Center Top - Black	CTEC43BL - add \$474
EC24 Power Center Top - White	CTEC43WH - add \$474

To Order Specify

① Veneer Model #	② Edge Detail	③ Wood Collection	④ Wood Finish	⑤ Electrical	⑥ Metal Color
Veneer (LKV)	<a href="#">See Edge Detail Options</a>	Essentials	<a href="#">See Essentials Wood Finish Options</a>	N None CTEC23 Power Center Top CTEC24 Power Center Top (See chart above)	<a href="#">See Metal Finish Color Options</a>
		Artisan	④ Wood Finish <a href="#">See Artisan Wood Finish Options</a>		

① Solid Surface Model #	② Top Surface Selection	③ Electrical Cut Out	④ Metal Color
Solid Surface (LKS)	<a href="#">See Solid Surface Top Surface Selection Options</a>	N None CTEC23 Power Center Top CTEC24 Power Center Top (See chart above)	<a href="#">See Metal Finish Color Options</a>

Description

Square Table with X Base  
at Bar Height

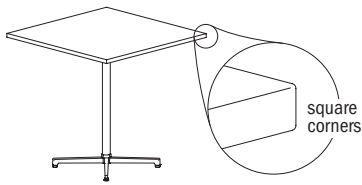

Laminate Tables  
"LKT" Models

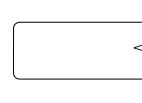

Eased Edge (R3)

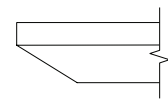

Reverse Bevel Edge (K9)

LAMINATE	D	W	H	CTN WT	CU FT	1 Model	Standard Tier 1	Graded In Tier 2	Standard Tier 1	Graded In Tier 2
		42	42	42	87	54	LKT4242-42SQX	\$1,970	\$2,036	\$2,533
	36	36	42	70	41	LKT3636-42SQX	\$1,755	\$1,806	\$2,317	\$2,367
	30	30	42	55	30	LKT3030-42SQX	\$1,581	\$1,623	\$2,143	\$2,185

Features:

- price reflects complete table - top and base
- ships KD in multiple cartons
- one piece top
- model includes adjustable glide
- when electrical option is selected, power accessible base is shipped; see page 178 for details
- power/charging units have 72" cord
- power cord is routed inside base column

Options:

- specify power access base with power unit option; None (N), add \$735 for EC23 (CTEC23), add \$616 for EC24 (CTEC24)



top shape

LOK - CONFERENCE

To Order Specify

1 Laminates Model #	2 Edge Detail	3 Laminates Selection	3a PVC Edge Color	4 Electrical	5 Metal Color
Laminates (LKT)	<a href="#">See Edge Detail Options</a>	<a href="#">See Laminates Selection</a>	<a href="#">See PVC Edge Color Options</a>	N None CTEC23 Power Center Top CTEC24 Power Center Top (See chart on next page)	<a href="#">See Metal Finish Color Options</a>

Model Number Breakdown

LKT4242-42SQX					
LK	T	4242	42	SQ	X
LOK	Laminates	42" x 42"	Height	Square Top Shape	X Base

Description

Square Table with X Base at Bar Height  
(continued)

Veneer Tables  
"LKV" Models

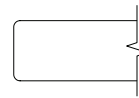

Eased Edge (R3)

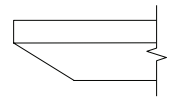

Reverse Bevel Edge (K9)

D	W	H	CTN WT	CU FT	① Model	Essentials		Artisan	
						Essentials	Artisan	Essentials	Artisan
42	42	42	87	54	LKV4242-42SQX	\$2,552	\$2,718	\$2,648	\$2,821
36	36	42	70	41	LKV3636-42SQX	\$2,267	\$2,414	\$2,351	\$2,504
30	30	42	55	30	LKV3030-42SQX	\$2,039	\$2,171	\$2,111	\$2,252

VENEER

LOK- CONFERENCE

Electrical Options and Upcharges

CTEC23	
EC23 Power Center Top - Black	CTEC23BL - add \$735
EC23 Power Center Top - White	CTEC23WH - add \$735
CTEC24	
EC24 Power Center Top - Black	CTEC43BL - add \$616
EC24 Power Center Top - White	CTEC43WH - add \$616

To Order Specify

① Veneer Model #	② Edge Detail	③ Wood Collection	④ Wood Finish	⑤ Electrical	⑥ Metal Color
Veneer (LKV)	<a href="#">See Edge Detail Options</a>	Essentials	<a href="#">See Essentials Wood Finish Options</a>	N None CTEC23 Power Center Top CTEC24 Power Center Top (See chart above)	<a href="#">See Metal Finish Color Options</a>
		Artisan	④ Wood Finish <a href="#">See Artisan Wood Finish Options</a>		

Description

Rounded Square Table with X Base at Bar Height

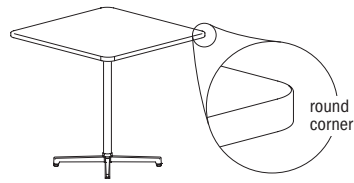

Laminate Tables "LKT" Models

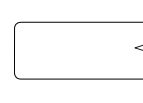

Eased Edge (R3)

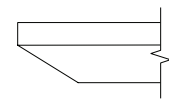

Reverse Bevel Edge (K9)

LAMINATE	D	W	H	CTN WT	CU FT	Model	Standard Tier 1	Graded In Tier 2	Standard Tier 1	Graded In Tier 2
		42	42	42	87	54	LKT4242-42SQRX	\$2,410	\$2,474	\$2,972
	36	36	42	70	41	LKT3636-42SQRX	\$2,016	\$2,069	\$2,576	\$2,631
	30	30	42	55	30	LKT3030-42SQRX	\$1,806	\$1,854	\$2,368	\$2,414

Features:

- price reflects complete table - top and base
- ships KD in multiple cartons
- one piece top
- model includes adjustable glide
- when electrical option is selected, power accessible base is shipped; see page 178 for details
- power/charging units have 72" cord
- power cord is routed inside base column

Options:

- specify power access base with power unit option; None (N), add \$735 for EC23 (CTEC23), add \$616 for EC24 (CTEC24)

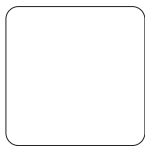

top shape

LOK - CONFERENCE

To Order Specify

1 Laminite Model #	2 Edge Detail	3 Laminite Selection	3a PVC Edge Color	4 Electrical	5 Metal Color
Laminite (LKT)	<a href="#">See Edge Detail Options</a>	<a href="#">See Laminite Selection</a>	<a href="#">See PVC Edge Color Options</a>	N None CTEC23 Power Center Top CTEC24 Power Center Top (See chart on next page)	<a href="#">See Metal Finish Color Options</a>

Model Number Breakdown

LKT4242-42SQRX						
LK	T	4242	42	SQ	R	X
LOK	Laminite	42" x 42"	Height	Square Top Shape	Rounded Corner	X Base

Description

Rounded Square Table with X Base at Bar Height (continued)

		Veneer Tables "LKV" Models				Solid Surface Tables "LKS" Models						
		Eased Edge (R3)		Reverse Bevel Edge (K9)		Reverse Bevel Edge (K7)						
		D	W	H	CTN WT	CU FT	Model	Essentials	Artisan	Essentials	Artisan	Standard
VENEER		42	42	42	87	54	LKV4242-42SQRX	\$3,143	\$3,349	\$3,263	\$3,479	--
		36	36	42	70	41	LKV3636-42SQRX	\$2,609	\$2,781	\$2,710	\$2,889	--
		30	30	42	55	30	LKV3030-42SQRX	\$2,337	\$2,491	\$2,426	\$2,585	--
SOLID SURFACE		42	42	42	87	54	LKS4242-42SQRX	--	--	--	--	\$6,052
		36	36	42	70	41	LKS3636-42SQRX	--	--	--	--	\$4,904
		30	30	42	55	30	LKS3030-42SQRX	--	--	--	--	\$4,107

Electrical Options and Upcharges

CTEC23	
EC23 Power Center Top - Black	CTEC23BL - add \$735
EC23 Power Center Top - White	CTEC23WH - add \$735
CTEC24	
EC24 Power Center Top - Black	CTEC43BL - add \$616
EC24 Power Center Top - White	CTEC43WH - add \$616

To Order Specify

1 Veneer Model #	2 Edge Detail	3 Wood Collection	4 Wood Finish	5 Electrical	6 Metal Color
Veneer (LKV)	<a href="#">See Edge Detail Options</a>	Essentials	<a href="#">See Essentials Wood Finish Options</a>	N None CTEC23 Power Center Top CTEC24 Power Center Top (See chart above)	<a href="#">See Metal Finish Color Options</a>
		Artisan	<b>4 Wood Finish</b> <a href="#">See Artisan Wood Finish Options</a>		

1 Solid Surface Model #	2 Top Surface Selection	3 Electrical Cut Out	4 Metal Color
Solid Surface (LKS)	<a href="#">See Solid Surface Top Surface Selection Options</a>	N None CTEC23 Power Center Top CTEC24 Power Center Top (See chart above)	<a href="#">See Metal Finish Color Options</a>

LOK-CONFERENCE

Description

Square Table with X4 Base at Bar Height

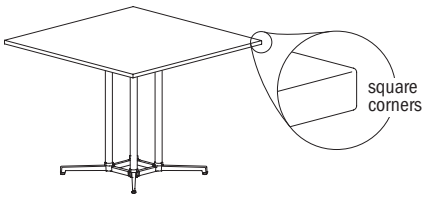

Laminate Tables  
"LKT" Models

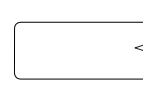

Eased Edge (R3)

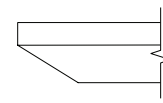

Reverse Bevel Edge (K9)

LAMINATE	D	W	H	CTN WT	CU FT	① Model	Eased Edge (R3)		Reverse Bevel Edge (K9)	
							Standard Tier 1	Graded In Tier 2	Standard Tier 1	Graded In Tier 2
	60	60	42	207	94	LKT6060-42SQZ	\$3,935	\$4,051	\$4,497	\$4,612
	54	54	42	180	86	LKT5454-42SQZ	\$3,749	\$3,850	\$4,311	\$4,411
	48	48	42	124	69	LKT4848-42SQZ	\$3,128	\$3,195	\$3,689	\$3,758

Features:

- price reflects complete table - top and base
- ships KD in multiple cartons
- one piece top
- model includes adjustable glide
- power cord is routed outside base column
- order vertical wire manager separately; see page 407

Options:

- specify power unit option; None (N), add \$594 for EC23 (CTEC23), add \$474 for EC24 (CTEC24)



top shape

LOK - CONFERENCE

To Order Specify

① Laminate Model #	② Edge Detail	③ Laminate Selection	④ PVC Edge Color	⑤ Electrical	⑥ Metal Color
Laminate (LKT)	<a href="#">See Edge Detail Options</a>	<a href="#">See Laminate Selection</a>	<a href="#">See PVC Edge Color Options</a>	N None CTEC23 Power Center Top CTEC24 Power Center Top (See chart on next page)	<a href="#">See Metal Finish Color Options</a>

Model Number Breakdown

LKT6060-42SQZ					
LK	T	6060	42	SQ	Z
LOK	Laminate	60" x 60"	Height	Square Top Shape	X4 Base

Description

Square Table with X4 Base  
at Bar Height  
(continued)

Veneer Tables  
"LKV" Models

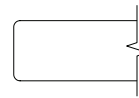

Eased Edge (R3)

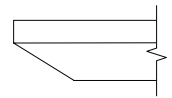

Reverse Bevel Edge (K9)

D	W	H	GTN WT	CU FT	① Model	Essentials		Artisan	
						Essentials	Artisan	Essentials	Artisan
60	60	42	207	94	LKV6060-42SQZ	\$5,093	\$5,428	\$5,286	\$5,635
54	54	42	180	86	LKV5454-42SQZ	\$4,849	\$5,165	\$5,029	\$5,362
48	48	42	124	69	LKV4848-42SQZ	\$3,762	\$3,945	\$3,867	\$4,058

VENEER

LOK - CONFERENCE

Electrical Options and Upcharges

CTEC23	
EC23 Power Center Top - Black	CTEC23BL - add \$594
EC23 Power Center Top - White	CTEC23WH - add \$594
CTEC24	
EC24 Power Center Top - Black	CTEC43BL - add \$474
EC24 Power Center Top - White	CTEC43WH - add \$474

To Order Specify

① Veneer Model #	② Edge Detail	③ Wood Collection	④ Wood Finish	⑤ Electrical	⑥ Metal Color
Veneer (LKV)	<a href="#">See Edge Detail Options</a>	Essentials	<a href="#">See Essentials Wood Finish Options</a>	N None CTEC23 Power Center Top CTEC24 Power Center Top (See chart above)	<a href="#">See Metal Finish Color Options</a>
		Artisan	④ Wood Finish <a href="#">See Artisan Wood Finish Options</a>		

Description

Rounded Square Table with X4 Base at Bar Height

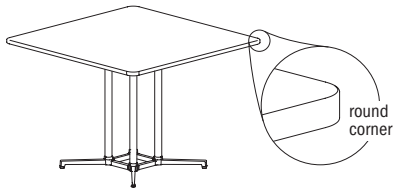

Laminate Tables  
"LKT" Models

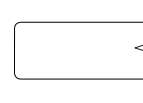

Eased Edge (R3)

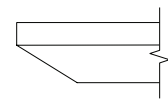

Reverse Bevel Edge (K9)

LAMINATE	D	W	H	CTN WT	CU FT	1 Model	Eased Edge (R3)		Reverse Bevel Edge (K9)	
							Standard Tier 1	Graded In Tier 2	Standard Tier 1	Graded In Tier 2
	60	60	42	207	94	LKT6060-42SQRZ	\$4,222	\$4,326	\$4,787	\$4,886
54	54	42	180	86	LKT5454-42SQRZ	\$3,508	\$3,607	\$4,066	\$4,169	
48	48	42	124	69	LKT4848-42SQRZ	\$3,584	\$3,653	\$4,142	\$4,214	

Features:

- price reflects complete table - top and base
- ships KD in multiple cartons
- one piece top
- model includes adjustable glide
- power cord is routed outside base column
- order vertical wire manager separately; see page 407

Options:

- specify power unit option; None (N), add \$594 for EC23 (CTEC23), add \$474 for EC24 (CTEC24)

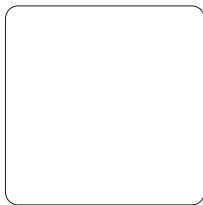

top shape

LOK - CONFERENCE

To Order Specify

1 Laminate Model #	2 Edge Detail	3 Laminate Selection	3a PVC Edge Color	4 Electrical	5 Metal Color
Laminate (LKT)	<a href="#">See Edge Detail Options</a>	<a href="#">See Laminate Selection</a>	<a href="#">See PVC Edge Color Options</a>	N None CTEC23 Power Center Top CTEC24 Power Center Top (See chart on next page)	<a href="#">See Metal Finish Color Options</a>

Model Number Breakdown

LKT6060-42SQRZ						
LK	T	6060	42	SQ	R	Z
LOK	Laminate	60" x 60"	Height	Square Top Shape	Rounded Corner	X4 Base

Description

Rounded Square Table with X4 Base at Bar Height (continued)

		Veneer Tables "LKV" Models				Solid Surface Tables "LKS" Models					
		Eased Edge (R3)		Reverse Bevel Edge (K9)		Reverse Bevel Edge (K7)					
		Essentials	Artisan	Essentials	Artisan	Standard					
	D	W	H	CTN WT	CU FT	Model	Essentials	Artisan	Essentials	Artisan	Standard
VENEER	60	60	42	207	94	LKV6060-42SQRZ	\$5,476	\$5,838	\$5,684	\$6,058	--
	54	54	42	180	86	LKV5454-42SQRZ	\$4,527	\$4,824	\$4,695	\$5,005	--
	48	48	42	124	69	LKV4848-42SQRZ	\$4,362	\$4,587	\$4,490	\$4,725	--
SOLID SURFACE	60	60	42	207	94	LKS6060-42SQRZ	--	--	--	--	\$10,805
	54	54	42	180	86	LKS5454-42SQRZ	--	--	--	--	\$8,958
	48	48	42	124	69	LKS4848-42SQRZ	--	--	--	--	\$6,994

Electrical Options and Upcharges

CTEC23	
EC23 Power Center Top - Black	CTEC23BL - add \$594
EC23 Power Center Top - White	CTEC23WH - add \$594
CTEC24	
EC24 Power Center Top - Black	CTEC43BL - add \$474
EC24 Power Center Top - White	CTEC43WH - add \$474

To Order Specify

1 Veneer Model #	2 Edge Detail	3 Wood Collection	4 Wood Finish	5 Electrical	6 Metal Color
Veneer (LKV)	<a href="#">See Edge Detail Options</a>	Essentials	<a href="#">See Essentials Wood Finish Options</a>	N None CTEC23 Power Center Top CTEC24 Power Center Top (See chart above)	<a href="#">See Metal Finish Color Options</a>
		Artisan	<b>4 Wood Finish</b> <a href="#">See Artisan Wood Finish Options</a>		
1 Solid Surface Model #	2 Top Surface Selection	3 Electrical Cut Out		4 Metal Color	
Solid Surface (LKS)	<a href="#">See Solid Surface Top Surface Selection Options</a>	N None CTEC23 Power Center Top CTEC24 Power Center Top (See chart above)		<a href="#">See Metal Finish Color Options</a>	

Description

Squircle Table with X Base at Bar Height



Laminate Tables  
"LKT" Models

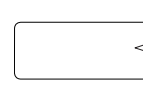

Eased Edge (R3)

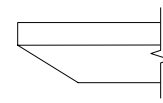

Reverse Bevel Edge (K9)

LAMINATE	D	W	H	CTN WT	CU FT	1 Model	Standard Tier 1	Graded In Tier 2	Standard Tier 1	Graded In Tier 2
	42	42	42	104	54	LKT42-42SCX	\$1,951	\$2,096	\$2,514	\$2,657
	36	36	42	82	41	LKT36-42SCX	\$1,892	\$1,943	\$2,451	\$2,504
30	30	42	64	30	LKT30-42SCX	\$1,829	\$1,870	\$2,391	\$2,436	

Features:

- price reflects complete table - top and base
- ships KD in multiple cartons
- one piece top
- model includes adjustable glide
- when electrical option is selected, power accessible base is shipped; see page 178 for details
- power/charging units have 72" cord
- power cord is routed inside base column

Options:

- specify power access base with power unit option; None (N), add \$735 for EC23 (CTEC23), add \$616 for EC24 (CTEC24)

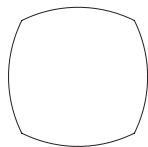

top shape

LOK - CONFERENCE

To Order Specify

1 Laminate Model #	2 Edge Detail	3 Laminate Selection	3a PVC Edge Color	4 Electrical	5 Metal Color
Laminate (LKT)	<a href="#">See Edge Detail Options</a>	<a href="#">See Laminate Selection</a>	<a href="#">See PVC Edge Color Options</a>	N None CTEC23 Power Center Top CTEC24 Power Center Top (See chart on next page)	<a href="#">See Metal Finish Color Options</a>

Model Number Breakdown

LKT42-42SCX					
LK	T	42	42	SC	X
LOK	Laminate	42" dia.	Height	Squircle Top Shape	X Base

Description

Squirrel Table with X Base at Bar Height (continued)

Veneer Tables "LKV" Models      Solid Surface Tables "LKS" Models

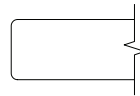

Eased Edge (R3)

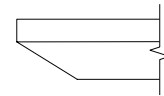

Reverse Bevel Edge (K9)

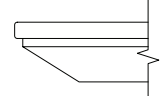

Reverse Bevel Edge (K7)

	D	W	H	CTN WT	CU FT	① Model	Veneer Tables		Solid Surface Tables		
							Essentials	Artisan	Essentials	Artisan	Standard
VENEER	42	42	42	104	54	LKV42-42SCX	\$2,552	\$2,717	\$2,648	\$2,820	--
	36	36	42	82	41	LKV36-42SCX	\$2,473	\$2,636	\$2,568	\$2,735	--
	30	30	42	64	30	LKV30-42SCX	\$2,388	\$2,544	\$2,479	\$2,640	--
SOLID SURFACE	42	42	42	104	54	LKS42-42SCX	--	--	--	--	\$5,485
	36	36	42	82	41	LKS36-42SCX	--	--	--	--	\$4,794
	30	30	42	64	30	LKS30-42SCX	--	--	--	--	\$4,622

Electrical Options and Upcharges

CTEC23	
EC23 Power Center Top - Black	CTEC23BL - add \$735
EC23 Power Center Top - White	CTEC23WH - add \$735
CTEC24	
EC24 Power Center Top - Black	CTEC43BL - add \$616
EC24 Power Center Top - White	CTEC43WH - add \$616

To Order Specify

① Veneer Model #	② Edge Detail	③ Wood Collection	④ Wood Finish	⑤ Electrical	⑥ Metal Color
Veneer (LKV)	<a href="#">See Edge Detail Options</a>	Essentials	<a href="#">See Essentials Wood Finish Options</a>	N None CTEC23 Power Center Top CTEC24 Power Center Top (See chart above)	<a href="#">See Metal Finish Color Options</a>
		Artisan	④ Wood Finish <a href="#">See Artisan Wood Finish Options</a>		

① Solid Surface Model #	② Top Surface Selection	③ Electrical Cut Out	④ Metal Color
Solid Surface (LKS)	<a href="#">See Solid Surface Top Surface Selection Options</a>	N None CTEC23 Power Center Top CTEC24 Power Center Top (See chart above)	<a href="#">See Metal Finish Color Options</a>

LOK-CONFERENCE

Description

Squire Table with X4 Base at Bar Height



Laminate Tables "LKT" Models

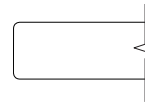

Eased Edge (R3)

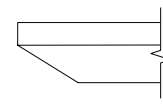

Reverse Bevel Edge (K9)

LAMINATE	D	W	H	CTN WT	CU FT	Model	Eased Edge (R3)		Reverse Bevel Edge (K9)	
							Standard Tier 1	Graded In Tier 2	Standard Tier 1	Graded In Tier 2
	60	60	42	207	94	LKT60-42SCZ	\$3,495	\$3,608	\$4,057	\$4,172
	54	54	42	180	86	LKT54-42SCZ	\$3,272	\$3,363	\$3,836	\$3,925
	48	48	42	129	69	LKT48-42SCZ	\$3,110	\$3,257	\$3,675	\$3,818

Features:

- price reflects complete table - top and base
- ships KD in multiple cartons
- one piece top
- model includes adjustable glide
- power cord is routed outside base column
- order vertical wire manager separately; see page 407

Options:

- specify power unit option; None (N), add \$594 for EC23 (CTEC23), add \$474 for EC24 (CTEC24)

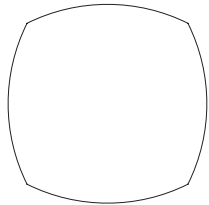

top shape

LOK - CONFERENCE

To Order Specify

1 Laminate Model #	2 Edge Detail	3 Laminate Selection	3a PVC Edge Color	4 Electrical	5 Metal Color
Laminate (LKT)	<a href="#">See Edge Detail Options</a>	<a href="#">See Laminate Selection</a>	<a href="#">See PVC Edge Color Options</a>	N None CTEC23 Power Center Top CTEC24 Power Center Top (See chart on next page)	<a href="#">See Metal Finish Color Options</a>

Model Number Breakdown

LKT60-42SCZ					
LK	T	60	42	SC	Z
LOK	Laminate	60" dia.	Height	Squire Top Shape	X4 Base

Description

Squirrel Table with X4  
Base at Bar Height  
(continued)

Veneer Tables "LKV" Models      Solid Surface Tables "LKS" Models

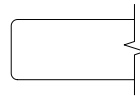

Eased Edge (R3)

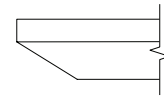

Reverse Bevel Edge (K9)

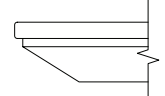

Reverse Bevel Edge (K7)

	D	W	H	CTN WT	CU FT	① Model	Veneer Tables "LKV" Models		Solid Surface Tables "LKS" Models		
							Essentials	Artisan	Essentials	Artisan	Standard
VENEER	60	60	42	207	94	LKV60-42SCZ	\$4,566	\$4,860	\$4,737	\$5,046	--
	54	54	42	180	86	LKV54-42SCZ	\$4,322	\$4,613	\$4,489	\$4,793	--
	48	48	42	129	69	LKV48-42SCZ	\$3,768	\$3,951	\$3,875	\$4,061	--
SOLID SURFACE	60	60	42	207	94	LKS60-42SCZ	--	--	--	--	\$9,917
	54	54	42	180	86	LKS54-42SCZ	--	--	--	--	\$8,775
	48	48	42	129	69	LKS48-42SCZ	--	--	--	--	\$7,413

Electrical Options and Upcharges

CTEC23	
EC23 Power Center Top - Black	CTEC23BL - add \$594
EC23 Power Center Top - White	CTEC23WH - add \$594
CTEC24	
EC24 Power Center Top - Black	CTEC43BL - add \$474
EC24 Power Center Top - White	CTEC43WH - add \$474

To Order Specify

① Veneer Model #	② Edge Detail	③ Wood Collection	④ Wood Finish	⑤ Electrical	⑥ Metal Color
Veneer (LKV)	<a href="#">See Edge Detail Options</a>	Essentials	<a href="#">See Essentials Wood Finish Options</a>	N None CTEC23 Power Center Top CTEC24 Power Center Top (See chart above)	<a href="#">See Metal Finish Color Options</a>
		Artisan	④ Wood Finish <a href="#">See Artisan Wood Finish Options</a>		

① Solid Surface Model #	② Top Surface Selection	③ Electrical Cut Out	④ Metal Color
Solid Surface (LKS)	<a href="#">See Solid Surface Top Surface Selection Options</a>	N None CTEC23 Power Center Top CTEC24 Power Center Top (See chart above)	<a href="#">See Metal Finish Color Options</a>

LOK-CONFERENCE

Description

Hive Table with T Base  
at Bar Height

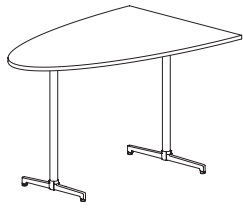

Laminate Tables  
"LKT" Models

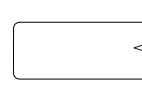

Eased Edge (R3)

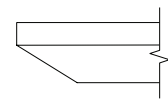

Reverse Bevel Edge (K9)

LAMI	D	W	H	CTN WT	CU FT	1 Model	Standard Tier 1	Graded In Tier 2	Standard Tier 1	Graded In Tier 2
		48	72	42	138	101	LKT4872-42HVT	\$2,746	\$2,800	\$3,355

Features:

- price reflects complete table - top and base
- ships KD in multiple cartons
- model includes adjustable glide

Options:

- specify power/charging option, see below for options and upcharges

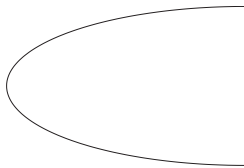

top shape

LOK - CONFERENCE

To Order Specify

1 Laminate Model #	2 Edge Detail	3 Laminate Selection	3a PVC Edge Color	4 Electrical
Laminate (LKT)	<a href="#">See Edge Detail Options</a>	<a href="#">See Laminate Selection</a>	<a href="#">See PVC Edge Color Options</a>	N None CT2 Dual Power Center Top (See chart on next page) CU1 Single Power Underside <b>5 Metal Finish</b> <a href="#">See Metal Finish Color Options</a>

Model Number Breakdown

LKT4872-42HVT					
LK	T	4872	42	HV	T
LOK	Laminate	48" x 72"	Height	Hive Top Shape	T base

Description

Hive Table with T Base  
at Bar Height  
(continued)

Veneer Tables  
"LKV" Models

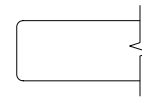

Eased Edge (R3)

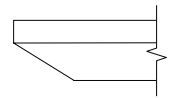

Reverse Bevel Edge (K9)

VEN.	D	W	H	CTN WT	CU FT	① Model	Essentials		Artisan	
	48	72	42	138	101	LKV4872-42HVT	\$3,455		\$3,729	
								\$3,763		\$4,007

Electrical Options and Upcharges

CT2	
Dual Power Center Top - Black	CT2BL - add \$1,773
Dual Power Center Top - White	CT2WH - add \$1,773
CU1	
Single Power Underside - Black	CU11C - add \$690
Single Power Underside with Wireless Charging - Black	CU11CW - add \$1,651

**Note: Order power infeed that best fits application.**

To Order, Specify:

① Veneer Model #	② Edge Detail	③ Wood Collection	④ Top Wood Finish	⑤ Electrical	⑥ Metal Color
Veneer (LKV)	<a href="#">See Edge Detail Options</a>	Essentials	<a href="#">See Essentials Wood Finish Options</a>	N None CT2 Dual Power Center Top CU1 Single Power Underside (See chart above)	<a href="#">See Metal Finish Color Options</a>
		Artisan	④ Top Wood Finish <a href="#">See Artisan Wood Finish Options</a>		

LOK- CONFERENCE

Description	D	W	H	CTN WT	CU FT	① Model	Laminate	Essentials Veneer	Artisan Veneer
Closed Storage Credenza	20	72	29	343	32	LKT2072-29L777	\$4,035		
	20	72	29	343	32	LKV2072-29L777		\$5,158	\$5,672
	20	60	29	237	28	LKT2060-29L777	\$3,824		
	20	60	29	237	28	LKV2060-29L777		\$4,870	\$5,353



**Features:**

- model comes with finished top, profiled top available to order separately, see page 444-445
- each compartment has one adjustable shelf
- back access grommet standard at top of each compartment
- door pulls match metal finish selected for column

**Options:**

- locking doors available, specify and add \$474

Closed/Open Storage Credenza	20	72	29	339	32	LKT2072-29L707	\$3,867		
	20	72	29	339	32	LKV2072-29L707		\$4,945	\$5,439
	20	60	29	230	28	LKT2060-29L707	\$3,666		
	20	60	29	230	28	LKV2060-29L707		\$4,664	\$5,131

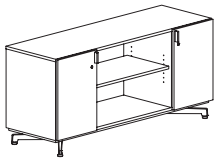

**Features:**

- model comes with finished top, profiled top available to order separately, see page 444-445
- each compartment has one adjustable shelf
- back access grommet standard at top of each compartment
- door pulls match metal finish selected for column

**Options:**

- locking doors available, specify and add \$316

LOK - CONFERENCE

**To Order Specify**

Laminate Model #	② Laminate Selection	③ PVC Edge Color
Laminate (LKT)	<a href="#">See Laminate Selection</a>	<a href="#">See PVC Edge Color Options</a>

**Model Number Breakdown**

LKT2060-29L777				
LK	T	2060	29	L777
LOK	Laminate	20"x60"	Height	Door Configuration

Description	D	W	H	CTN WT	CU FT	① Model	Laminate	Essentials Veneer	Artisan Veneer
Closed Storage Credenza at Counter Height	20	72	36	362	38	LKT2072-36L777	\$4,402		
	20	72	36	362	38	LKV2072-36L777		\$5,621	\$6,183
	20	60	36	303	34	LKT2060-36L777	\$4,170		
	20	60	36	303	34	LKV2060-36L777		\$5,305	\$5,837



**Features:**

- model comes with finished top, profiled top available to order separately, see page 444-445
- each compartment has one adjustable shelf
- back access grommet standard at top of each compartment
- door pulls match metal finish selected for column

**Options:**

- locking doors available, specify and add \$474

Closed/Open Storage Credenza at Counter Height	20	72	36	355	38	LKT2072-36L707	\$4,221		
	20	72	36	355	38	LKV2072-36L707		\$5,392	\$5,931
	20	60	36	296	34	LKT2060-36L707	\$3,998		
	20	60	36	296	34	LKV2060-36L707		\$5,086	\$5,592

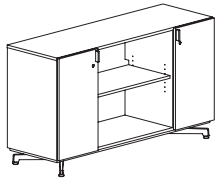

**Features:**

- model comes with finished top, profiled top available to order separately, see page 444-445
- each compartment has one adjustable shelf
- back access grommet standard at top of each compartment
- door pulls match metal finish selected for column

**Options:**

- locking doors available, specify and add \$316

**To Order Specify**

① Veneer Model #	② Wood Collection	③ Wood Finish
Veneer (LKV)	Essentials	<a href="#">See Essentials Wood Finish Options</a>
	Artisan	③ Wood Finish <a href="#">See Artisan Wood Finish Options</a>

Description

Credenza Cabinet Top



Laminate Tables  
"LKT" Models

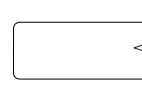

Eased Edge (R3)

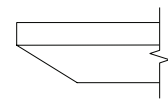

Reverse Bevel Edge (K9)

LAMINATE	D	W	H	CTN WT	CU FT	① Model	Standard Tier 1	Graded In Tier 2	Standard Tier 1	Graded In Tier 2
	20	72	1 3/16	55	8	LKT2072TT	\$657	\$684	\$1,241	\$1,264
	20	60	1 3/16	47	7	LKT2060TT	\$581	\$602	\$1,157	\$1,177

Features:

- edge profile on approach side
- placed on top of storage credenza

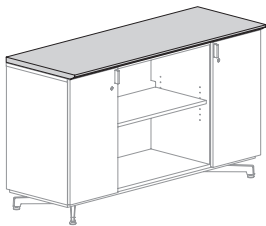

LOK - CONFERENCE

To Order Specify

① Laminate Model #	② Edge Detail	③ Laminate Selection	④ PVC Edge Color
Laminate (LKT)	<a href="#">See Edge Detail Options</a>	<a href="#">See Laminate Selection</a>	<a href="#">See PVC Edge Color Options</a> N None CT2 Dual Power Center Top CU2 Dual Power Underside CT2U1 Dual Power Center Top with Underside (See chart on next page)

[See Metal Finish Color Options](#)

Model Number Breakdown

LKT2072TT			
LK	T	2072	TT
LOK	Laminate	20" x 72"	Rectangular Top Shape

Description

Credenza Cabinet Top  
(continued)

Veneer Tables  
"LKV" Models

Solid Surface Tables  
"LKS" Models

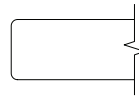

Eased Edge (R3)

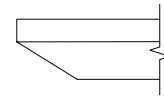

Reverse Bevel Edge (K9)

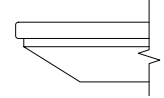

Reverse Bevel Edge (K7)

	D	W	H	CTN WT	CU FT	① Model	Veneer Tables "LKV" Models		Solid Surface Tables "LKS" Models		
							Essentials	Artisan	Essentials	Artisan	Standard
VENEER	20	72	1 3/16	55	8	LKV2072TT	\$1,014	\$1,145	\$1,262	\$1,379	--
	20	60	1 3/16	47	7	LKV2060TT	\$931	\$1,040	\$1,175	\$1,268	--
SOL SURF	20	72	1 3/16	55	8	LKS2072TT	--	--	--	--	\$2,785
	20	60	1 3/16	47	7	LKS2060TT	--	--	--	--	\$2,529

To Order Specify

① Veneer Model #	② Edge Detail	③ Wood Collection	④ Wood Finish
Veneer (LKV)	<a href="#">See Edge Detail Options</a>	Essentials	<a href="#">See Essentials Wood Finish Options</a>
		Artisan	④ Wood Finish <a href="#">See Artisan Wood Finish Options</a>

① Solid Surface Model #	② Top Surface Selection
Solid Surface (LKS)	<a href="#">See Solid Surface Top Surface Selection Options</a>

LOK- CONFERENCE

Description	D	W	H	CTN WT	CU FT	① Model	List Price
-------------	---	---	---	-----------	----------	---------	------------

<b>3 Prong Plug - 110 Power Infeed</b>				1	1	AP72	\$357
--	--	--	--	---	---	------	-------

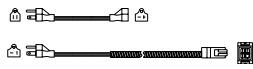

- Features:**
- 72" plug power infeed
  - 20 amps/110 volts max
  - 3 prong plug - 15 amp adapter plug included
  - single circuit use only

<b>Hardwire Power Infeed</b>				1	1	HP72	\$290
------------------------------	--	--	--	---	---	------	-------



- Features:**
- 72" hardwire power infeed
  - 20 amps/120 volts max
  - single or double circuit
  - electrical contractor responsible for connection to building power source

<b>Quick Disconnect Power Infeed</b>				1	1	MP72	\$267
--------------------------------------	--	--	--	---	---	------	-------



- Features:**
- must be used with QD1
  - 72" modular power infeed
  - 20 amps/120 volts max
  - single or double circuit

<b>Quick Disconnect Wall Outlet</b>				1	1	QD1	\$137
-------------------------------------	--	--	--	---	---	-----	-------

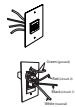

- Features:**
- must be used with MP72
  - works for both single or double circuit
  - 20 amps/120 volts max
  - electrical contractor responsible for connection to building power source

<b>Vertical Wire Manager</b>	1/2	2 1/4	33	1	1	AVL33	\$154
	1/2	2 1/4	25	1	1	AVL25	\$117
	1/2	2 1/4	22	1	1	AVL20	\$95
	1/2	2 1/4	17	1	1	AVL17	\$90



- Features:**
- field installed
  - use AVL33 for 42"h tables with disk base
  - use AVL25 for 42"h tables
  - use AVL20 for 36"h tables
  - use AVL17 for 29"h tables

- Options:**
- specify plastic color, Black (B) or Silver (S)

<b>Flexible Vertical Wire Manager</b>	1 1/2	1 1/2	45	4	1	45VWM	\$146
---------------------------------------	-------	-------	----	---	---	-------	-------



- Features:**
- black plastic
  - field installed to bottom of table top, with screws provided
  - wire manager is 1 1/2" diameter
  - weighted base is 4" diameter
  - length can be adjusted by removing individual discs as required

LOK - CONFERENCE

Description	D	W	H	CTN WT	CU FT	Model	List Price
<b>Power Strip</b>	1 ½	1 ¾	8	3	1	GP9ACP1-0212	\$103

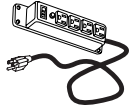

- Features:**
- power surge with 10' cord
  - four electrical outlets
  - includes switch
  - field installed

<b>Wire Management Velcro Straps</b>	1 ¾	3 ½	¼	1	1	04WVS	\$63
--------------------------------------	-----	-----	---	---	---	-------	------

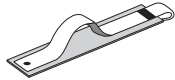

- Features:**
- black, set of 4
  - field installed to bottom of table top, with adhesive tape provided

<b>Cable Management Clips</b>	2 ⅝	3 ¾	1 ⅝	1	1	0304CMC	\$61
-------------------------------	-----	-----	-----	---	---	---------	------

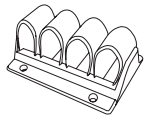

- Features:**
- black plastic
  - installed to bottom of table top
  - four retention loops

<b>Floor Mount Glide</b>	3	2 ¼	½	1	1	LKB516-18ANCHOR	\$47
--------------------------	---	-----	---	---	---	-----------------	------

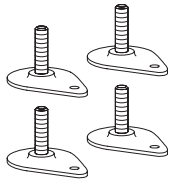

- Features:**
- field installed glides for mounting table base to floor
  - ¼" diameter hole in the glide for mounting
  - set of 4
  - table can be leveled before attached to floor
  - floor attachment hardware provided by installer
  - glide threads ⅜"-16

<b>Wire Management Tray</b>	7 ½	45	3	8	2	GP9WMT1-0845	\$300
	7 ½	35	3	6	1	GP9WMT1-0835	\$253
	7 ½	25	3	4	1	GP9WMT1-0825	\$205

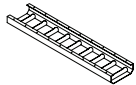

- Features:**
- silver powder-coated finish
  - four hanging brackets (CI2C00)

<b>Wire Manager Trough</b>	2 ½	36	2 ½	4	1	36WCT	\$169
	2 ½	24	2 ½	3	1	24WCT	\$154
	2 ½	12	2 ½	2	1	12WCT	\$132

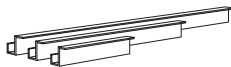

- Features:**
- black plastic
  - field installed to bottom of table top, with screws provided

**Accessories/ Keyboard/ Tasklights**

For an additional list of electrical units, grommets, keyboards, wire management, monitor arms & telecom jacks, please see our [accessories price list](#)

Contact your customer service representative for specific questions regarding which units can be used with Lok Conferencing.

