

# pricelist

effective January 19, 2026

# LOK

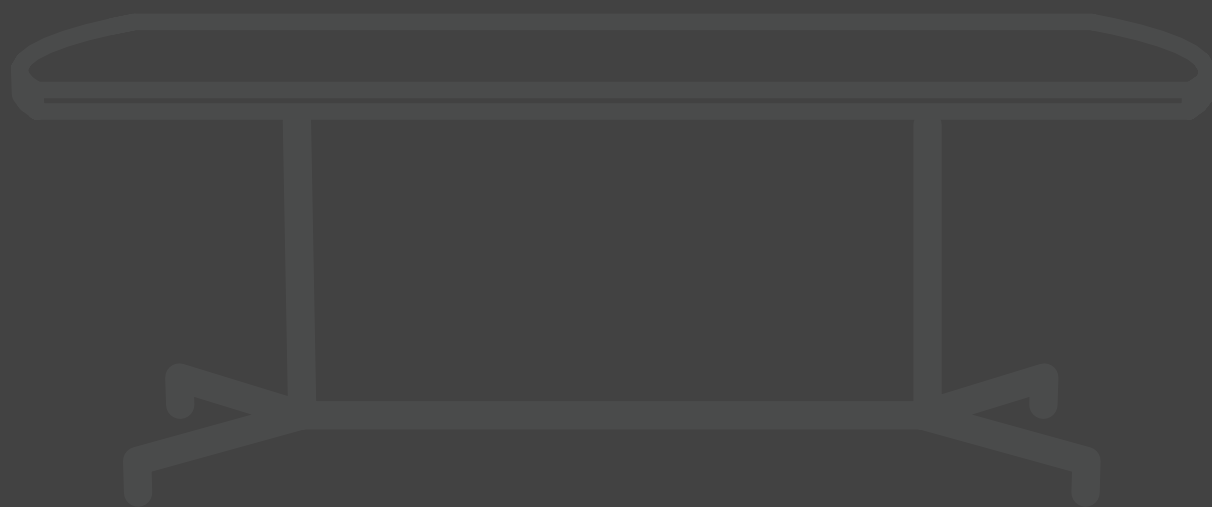

## JSI Price Lists

### Tables + Casegoods

[Bourne Tables](#)  
[Brogan](#)  
[Copilot](#)  
[Draft](#)  
[Finale](#)  
[Native](#)  
[Nosh](#)  
[Prost](#)  
[Reef](#)  
[Romy](#)  
[Traditional](#)  
[Trail](#)  
[Walden](#)  
[Wellington](#)  
[Accessories](#)

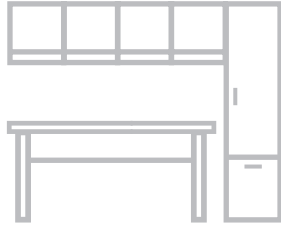

### Anthology

[Anthology](#)



### Lok

[Training Tables](#)  
[Teamwork Tables](#)  
[Conference Tables](#)  
[Occasional Tables](#)

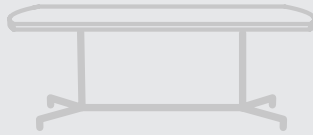

### Flux

[Private Office](#)

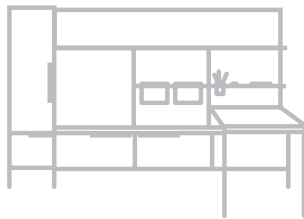

### Vision

[Casegoods](#)  
[Tables](#)



### Seating

<a href="#">Americana</a>	<a href="#">Newton</a>
<a href="#">Arwyn</a>	<a href="#">Oxley</a>
<a href="#">BeSpace</a>	<a href="#">Pillow</a>
<a href="#">Boston</a>	<a href="#">Poet</a>
<a href="#">Bourne Seating</a>	<a href="#">Protocol</a>
<a href="#">Bryn</a>	<a href="#">Proxy</a>
<a href="#">Caav</a>	<a href="#">Ramona</a>
<a href="#">Collective Motion</a>	<a href="#">Ria</a>
<a href="#">Connect</a>	<a href="#">Sosa</a>
<a href="#">Cosgrove</a>	<a href="#">Teekan</a>
<a href="#">Finn</a>	<a href="#">Totem</a>
<a href="#">Finn Nu</a>	<a href="#">Wink</a>
<a href="#">Garvey R5</a>	
<a href="#">Gatsby</a>	
<a href="#">Harbor</a>	
<a href="#">Henley</a>	
<a href="#">Hoopz</a>	
<a href="#">Indie</a>	
<a href="#">Jude</a>	
<a href="#">Knox</a>	
<a href="#">Mackey</a>	
<a href="#">Madison</a>	
<a href="#">Millie</a>	
<a href="#">Moto</a>	



### Healthcare

[Seating](#)  
[Kindera](#)  
[Satisse](#)  
[Somna](#)  
[Scroll](#)  
[Casework](#)  
[Forge](#)

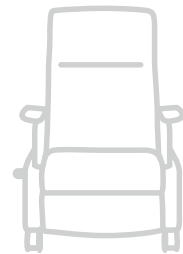

## Environmental Mission

Our vision and goal is a sustaining supplier, manufacturer and customer for the long term protection and preservation of our environment for future generations.

### MISSION

To achieve this vision, we are dedicated to ensuring the health and wellbeing of all of our partners, reducing negative impact on the environment, and maintaining price structure by increasing efficiencies and reducing consumption.

JSI, and it's parent company, is an internal manufacturer and has been an environmentally conscious organization for more than 80 years.

We are proud to use wood as our primary sustainable material resource and all corporate policies and procedures support the efforts to "recover, recycle, reuse, repurpose, reduce, refuse, and re-engineer". In doing this, we are committed to the conservation of the environment and its natural resources as well as encouraging our suppliers and customers to do the same. A goal of a "Sustainable Partnership", supplier, manufacturer and customer, is essential for the long term protection preservation and sustainability of our environment for future generations.

### LOCATION

Our manufacturing facilities are located in the center of Southern Indiana. With our diverse product offering and manufacturing capabilities, we provide a single source for all of your project needs allowing you to conserve our fossil fuels and reduce greenhouse gases.

### PACKAGING

We place emphasis on the minimal use of disposable packaging while still providing adequate protection to the finished product. Our corrugated packaging is recyclable, reusable, and up to 100% recycled content. We reuse or recycle more than 175 tons of corrugated material annually.

### REGULATORY

All of our manufacturing facilities are in compliance with applicable OSHA regulations and meet or exceed all applicable DEM and EPA regulations for air emissions, storm water and hazardous waste disposal.

### MANUFACTURING FACILITIES

Our manufacturing facilities are geared toward eco-efficiency and are encouraged to continually improve and conserve. Solid wood not used in the direct manufacturing process is recovered for the operation of our dry kilns, thus reducing greenhouse gases, the use of fossil fuels, and the burden of waste placed on landfills. Composite panels not used in the direct manufacturing process are ground and sold for use as animal bedding and boiler fuel. In addition to other energy savings techniques, our manufacturing facilities use high efficient lighting, make use of power factor capacitors, and encourage all to conserve and reduce energy consumption and water usage. Condensation pumps are used to aid in water conservation as well as extending boiler life.

### MANUFACTURING PROCESSES

Our finish processes utilize efficient spray guns and proper spray techniques to reduce wasted material. Excess finish material, solvents, and waste are recycled. Many of the assembly processes use water based glues that contain no hazardous ingredients.

### TEXTILES

Many of our fabric options utilize up to 100% recycled content. Our leather alternative program includes selections that contain no toxic materials, plasticizers, heavy metals, or formaldehyde and have a 100% biodegradable back cloth. Some of the available panel fabric used, if discarded is a biological nutrient for the soil. Most of the components (foam, batting, and polycord) used in upholstered products are recyclable. Excess fabrics and leathers not utilized in the upholstery process go to recyclers and local charities for additional use.

### WOOD

Wood is the most diverse, most process friendly, and most widely utilized natural resource in mankind's history. No other natural resource can match the environmental advantages of wood, including being renewable, recyclable, natural, carbon negative, and biodegradable. Utilizing the sun's energy, trees grow and remove carbon dioxide from the air while giving off oxygen to benefit the entire planet. Approximately 49% of wood's dry weight is carbon and harvesting mature trees in a sustainable forest, which has slowed in the absorption of carbon dioxide, allows the photosynthetic cycle to continue at full optimization and allow for the carbon to remain sequestered. We are proud to use wood as our primary "sustainable" renewable resource.

### WOOD OPTIONS

Many environmentally friendly solid wood and engineered wood options are available for quote, including: Lyptus®, Plyboo®, reclaimed woods, agricultural and post-consumer waste fiber products, etc.

### INDOOR AIR QUALITY

Our goal is to reduce the impact our products will have on the indoor air quality. We practice the latest technologies and utilize a third party to assure we meet this goal. GreenGuard, one of the leaders in IAQ certification, continues to certify our product offering with UL2818-GreenGuard Indoor Air Quality certification.

### PARTNERSHIPS

BIFMA  
*Business and Institutional Furniture Manufacturer Association*  
 USGBC  
*United States Green Building Council*  
 IIDA  
*International Interior Design Association*  
 FSC  
*Forest Stewardship Council - Forestland*  
 UL GreenGuard  
*Indiana Department of Natural Resources - Division of Forestry - Classified Forest, Wildlands Program*

**Lifetime Warranty**

JSI warrants to the original purchaser that each piece of furniture will be free from defects in workmanship, given normal use and care for as long as the original customer owns and uses the product. Normal use is defined as the equivalent of a single shift, 40-hour work week.

JSI will, at its option, repair or replace with comparable product within the terms of the warranty.

**Exceptions to Warranty:**

**12 Years (from date of purchase)**

- Wood Seating
- Seating Controls
- Pneumatic Cylinders
- Laminate Surfaces
- Veneer Surfaces
- Solid Surface Components
- Somna, Kindera, Satisse and Forge in multi-shift environment except components as specifically identified below

**10 Years (from date of purchase)**

- Recliner Mechanisms and Associated Levelers (regardless of shift usage)

**5 Years (from date of purchase)**

- Casters (including recliner central locking)
- Glides (including MagLinx™)
- Electric Height Adjustable Bases
- Task Lights
- Mesh/Knit Materials
- Electrical Components
- Foam
- Recliner Heat Components

**This Warranty Does Not Cover:**

- Natural variations in color, grain or texture of wood and other covering materials over which JSI has no control
- Normal wear, color fastness, shrinkage, puddling, wrinkling and stretching of upholsteries including fabric, vinyl, leather and other textiles. This warranty does not cover any defects that may arise in the use of COM or COL upholstery materials. Textile manufacturer’s warranty will apply.
- Damages resulting from transportation, improper assembly, installation, handling, accident, user modification attachments, misuse, or neglect of product care.
- Damage resulting from extreme climate conditions
- Finish damages resulting from normal wear and tear, improper maintenance, water damage, exposure to sunlight, extreme high or low humidity or temperature, or other acts of nature.
- Damage created by loading file drawers with anything other than hanging folders.
- Use of any unauthorized non-JSI components for use in the place of JSI components, including but not limited to worksurfaces, bases, brackets, or other essential components.

Replacement components are warranted for a duration of 2 years or for the remaining duration of the initial warranty, whichever extends further.

Textile supplier’s warranty will apply. Given the diverse range of cleaning agents used by various facilities, it is advisable to conduct testing on each textile choice using the facility’s designated cleaning techniques prior to placing an order.

JSI makes no expressed or implied warranties to any product and, in particular, makes no warranty of merchantability of fitness for any particular purpose. JSI will not be liable for any consequential or incidental damages under this warranty.

**Unique Characteristic of Natural Woods and Veneers**

JSI uses high quality wood and veneer harvested from sustainably managed forests. Every tree has unique and defining characteristics, like fingerprints. These characteristics can be defined by differences in color, grain configuration, and textures. These characteristics will be more noticeable if the product has a clear or lighter finish.

JSI uses select beech, cherry, maple, oak and walnut cut wood products to produce the desired look of our furniture products.

Maple and Cherry species have a higher degree of uneven distribution of grain, small color streaks, and pin knots.

At JSI, we take care of selecting woods and veneers that are used in our products. With this in mind, we hope you appreciate the beauty of each tree’s fingerprints. Products will not be replaced due to these natural characteristics.

Veneers can be sliced in a variety of ways to create unique patterns. JSI uses several different patterns, as shown below.

**Flat (Plain) Cut** as shown



**Quarter Sliced** as shown

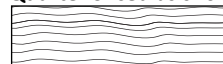

**Double Cut** as shown



**Rift Cut** as shown



**Double Cut**

The Double Cut veneer is a processed product that has at least two cuttings to create the final veneers. These cuts of veneer strands are dyed and layered into a block to create variation of patterns from a very tight grain pattern to an exotic figure grain pattern.

JSI offers two collection of veneer, our Essentials and Artisan Collections.

**Essentials**

The Essentials Collection allows users to specify beautiful veneers, without sacrificing budget, providing grain patterns and hues for maximum material flexibility and style range.

**Artisan**

The Artisan Collection provides a curated selection of finishes expressing an elevated style and contemporary nature.

**Laminates (Veneer Series)**

An alternative HPL (Higher Pressure Laminate) laminate work surface can be specified on most of our casegood product lines. The specification pages will also list the available coordinating finishes.

**Laminate Series**

JSI laminate series offer a full laminated product with imprinted grain to hide finger prints and provide durability. The worksurface tops are HPL (High Pressure Laminate) or TFL (Thermal Fused Laminate). TFL is used on the product’s chassis.

An overview of finishes and laminates appear on page IV, detailing which species each veneer finish is applied to.

**Series Material Offering**

Select finishes, species and materiality are available on a per series offering, with JSI curating the correct palette offering for the series intent. Please refer to each series feature highlights within the product pages to identify the material, species, grain patterns and finishes available for that specific series.

### JSI Core Materials

For projects requiring similar finishes across multiple series, JSI recommends using our Core Materials program. Finishes in this group are offered throughout the vast majority\* of JSI products in the three main material categories Essentials and Artisan Veneer, Laminate and Solid Maple, in a spectrum of light to dark.

\*note: not applicable to all series, for example BeSpace only offers clear veneer finish.

### Finish - Top Coat

To reduce hazardous formaldehyde emissions, we use our proprietary specially designed top coat, DuraTex™. It significantly reduces hazardous formaldehyde emissions and helps improve indoor air quality.

### Finish - Color/Stains

A wide range of stains are available to bring out the beautiful characteristics of each wood species. We coordinate finish color between our veneer stains and solid lumber stains; however, not all may be a perfect match. The stains are continually reviewed for accuracy of color, as well as a constant monitoring of the latest color trends in the furniture market.

### Finish - Matching

Due to the natural characteristics of wood, environmental effects, and material upgrades, JSI cannot guarantee exact finish matches on existing furniture previously ordered.

If an exact match is required to accompany existing furniture, it must be specified at the time of order placement, so specific internal procedures can be followed to ensure a proper and acceptable finish match. We reserve the right to change our finish formula at any time to improve safety, quality, and appearance. Unless a finish match for existing furniture is requested at the time of ordering, we accept no liability for finish that may not match the existing furniture from prior orders.

Solid lumber may inherently have mineral streaks, pits, and various other natural occurrences. Care is taken in selecting the solid lumber to coordinate with the requested finish on our veneer products. This internal selection process is subject to availability of solid lumber parts.

### Finish Sheen

All casegood veneer finishes are standard in 35-sheen, with the exception of Raven, which is only offered in 15-sheen. All other finishes are available in 15-sheen, with a 5% upcharge, per model.

### Custom/Special Finishes

JSI, upon request, will accommodate special finishes. A written request is required to proceed with custom finish orders. A sample reference is required for first-time matches and must be included with the written request.

There is a charge of **\$412 list per order** for any non-standard wood finish.

Orders will be entered noting the special finish. A sample match will be provided to the customer. Written approval is needed before the finish process can be started. Delays in approval may have an impact on lead times.

Every effort will be made to create the requested match; however, an acceptable match may not be possible because of natural variations of wood. These natural variations can also cause minor differences in the final finish product.

Use standard pricing and option pricing for each line item with a special finish, unless additional modifications have been specified. For items available in both Essential and Artisan veneers, apply the Essentials pricing.

### Samples

Samples of standard wood finishes, paints colors, metal colors, and standard laminate are available upon request. The fastest way for requests to be filled is by using our website. See below for options to request samples.

Website – [jsifurniture.com](http://jsifurniture.com) (click the resource tab)  
 JSI Sales representatives  
 Phone – 800.457.4511 – Customer Service  
 Email – [customerservice@jaspergroup.us.com](mailto:customerservice@jaspergroup.us.com)

### Veneer Finish and Laminate Overview

Designator	Finish	Veneer Collection	Veneer Species	Laminate	Core Program
BAR	Barrel	Artisan	White Oak- Double Cut	n/a	N
BRK	Brickdust	Essentials	Cherry	HPL & TFL	Y
BUF	Buff	Artisan	White Oak- Double Cut	n/a	N
CSK	Cask	Essentials	Walnut	HPL & TFL	Y
CND	Cinder	Artisan	White Oak- Double Cut	n/a	N
CLY	Clay	Essentials	Cherry	HPL & TFL	Y
EGR	Egret	Artisan	White Oak- Double Cut	HPL & TFL	N
FAW	Fawn	Essentials	Linear - Double Cut	HPL & TFL	Y
FLX	Flax	Essentials	Maple	n/a	N
FLN	Flint	Essentials	Linear - Double Cut	HPL & TFL	Y
LOF	Loft	Essentials	Linear - Double Cut	HPL & TFL	Y
MES	Mesa	Essentials	Cherry	HPL & TFL	Y
MIN	Mineral	Essentials	White Oak- Double Cut	HPL & TFL	Y
MCH	Mocha	Essentials	Walnut	HPL & TFL	Y
OBK	Outback	Essentials	Cherry	HPL & TFL	Y
PIL	Pilsner	Essentials	Maple	HPL & TFL	Y
RAV	Raven	Artisan	Black Oak	n/a	N
RYE	Rye	Artisan	White Oak- Double Cut	n/a	N
SAB	Sable	Artisan	White Oak- Double Cut	n/a	N
SAD	Saddle	Artisan	White Oak- Double Cut	n/a	N
SIE	Sienna	Essentials	Walnut	n/a	N
TRF	Truffle	Essentials	Walnut	n/a	N
UMB	Umber	Essentials	Walnut	HPL & TFL	Y
VAL	Valley	Essentials	Linear - Double Cut	HPL & TFL	Y



### Pricing

Prices found in this document or on our website are list prices in U.S. dollars for standard product delivery to one destination. Prices do not include storage, installation, or taxes. Possession of this price list does not constitute an offer to sell. Orders can only be received from approved authorized JSI dealers.

Prices and product information in this document, as well as our website, are subject to change without notice. Reference website for most up to date product offering and pricing.

In our ongoing efforts to minimize ancillary charges. JSI does not include these fees in any calculations for dealer participation fees or commissions in any form. Ancillary charges include but are not limited to special finish charges, special laminate charges and handling fees. When calculating your dealer participation fee or commission earned, please include product lines only and exclude any ancillary charges. Should you have any questions, please call our office for clarification.

### Orders

Detailed specification pages are available in the price list at the beginning of each series.

Additional information may be obtained by consulting the Customer Service Department or our website.

Indicate shipping address if different from billing address.

Send Orders To:

US Mail – JSI  
225 Clay Street  
Jasper, IN 47546  
Fax – 812-482-1548  
Email – orders@jaspergroup.us.com

JSI reserves the right to make changes in dimensions, styles, or specifications if we believe these changes will improve the safety, quality, or appearance of the product.

Acceptance of orders will be subject to credit approval, barring any acts of governments, or any other causes beyond our control (e.g. strikes, fire, embargo of materials, etc).

### Product Modifications

While we offer a wide range of products to accommodate many possible solutions, we also recognize the needs for our products to be modified from our standard offering.

In the series introduction section of each product, we address modification options for that series.

To see if the desired modification is possible, please contact our Customer Service Department for a quote. Note that order quantities and material availability can affect the quote. Additional information may be requested to fully quote modifications.

### Order Acknowledgments

All orders will be acknowledged promptly upon entry of a clean order. The acknowledgment will show how the order was entered, ship date and any other information pertinent to the order. It is the purchaser's responsibility to verify all the information on the acknowledgment carefully and notify us immediately, in writing, of any discrepancies.

Every reasonable effort is made to ship as acknowledged; however, the acknowledged ship date is approximate. Company will generally ship within five (5) working days of the acknowledged ship date. If a firm ship date is necessary, customer must inform company at time of order and company will make all reasonable efforts to meet each customer's request. Acknowledged shipping dates are contingent upon the force majeure conditions contained in these terms and conditions.

### Cancellations and Changes

All orders are considered firm and are not subject to cancellation or change without approval from JSI. All approved changes are subject to additional charges and revised lead times

### Quickship

JSI offers select Vision models, with select options, in our Quickship program. These items ship within 10 business days after receipt of a clean, credit approved purchase order. Items should be placed on order separate from standard lead time models.

Product for up to 10 offices or 10 tables can be included on a single Quickship order. Available capacity is filled by orders as they are received. If normal 10 day Quickship is not available because capacity has been filled, you will be immediately notified by JSI customer service. Changes and cancellations to Quickship orders are not allowed under any circumstances, nor are modifications to the pre-determined Quickship offering. Limit one order per project.

### Delivery

Our freight policy consists of prepaid freight to the 48 contiguous states; all other shipments are prepaid to port of exit ONLY. JSI reserves the right to select the appropriate carrier and shipment routes, most shipments are on freight carriers that are dedicated furniture specialists. Standard deliveries require a DOCK that can accommodate 75 foot trucks. Ownership and inspection of product is the responsibility of the buyer upon pickup by the freight carrier. Pricing in this book is for standard delivery only. Standard delivery does not include non-dock delivery, inside delivery, residential delivery or installation of product. Fees and changes for non-standard deliveries are listed below.

### Shipping Destination

Changes to ship to locations may not occur within seven days prior to the ship date, however, in atypical situations a **\$268 change fee** will be applied to accommodate additional carrier fees.

### Standard Delivery Time

Between 8 AM and 3 PM Monday through Friday. Special delivery requests can be subject to additional fees to accommodate requests.

### No Touch Freight

Our freight is considered "no touch". Therefore, customers are to be prepared to unload freight from inside the truck prior to arrival. In the instance that a driver must unload the shipment, driver assists fees will apply (see fees below).

### On-Site Deliveries

Shipments to the installation site, and time deliveries are available on full truckloads or slightly less, at no additional charge. Shipments or timed deliveries for smaller shipments may not be available, or if available may require an additional charge.

### Detention Fees

- Carriers are given two-hour maximum time allotment to unload for one-stop truckloads.
  - Carriers are given one hour maximum time allotment to unload for multi-stop truckloads
- \*Detention fees apply after allotted unloading time and will be at buyer's expense.

### Fees

Orders of less than \$1,000 net . . . . . \$100 net per order  
 (If order is UPS shippable, the handling fee is waived and customer is invoiced for exact shipping charges.)  
 Weekday deliveries outside of standard delivery times . . . \$332 net  
 Weekend deliveries (Saturday or Sunday) . . . . . \$655 net  
 Driver Assist . . . . . \$100 net  
 Jobsite Non-Dock Delivery . . . . . \$167 net per truck  
 Inside Delivery (first floor inside only)- no installation or carton removal . . . . . \$278 net minimum 7% of net price  
 NO RESIDENTIAL DELIVERIES

### Warehouse/Storage Fees

Additional storage time with a provided two-week approved notice is calculated at 3% per month of the product amount or per day.

### Please be Advised

- Reconsignment fees are the responsibility of the buyer.
- Any charges arising from failure to meet shipment, re-routing while in transit or carrier storage charges are the responsibility of the buyer.
- Contact Customer Service to inquire about skidding of products, special crating of products and product installation. These requests must be approved by JSI and made at the time of order.
- Carriers have the right to refuse delivery to a specified location if it conflicts with their liability policy.

### Freight Damage

JSI products are packed in cartons and meet or exceed existing codes for furniture and seating products. All shipments are delivered to the carrier in good condition and our liability ceases thereafter. If delivery arrives short or damaged, contact Customer Service immediately to file a claim. In the event of concealed damage, notify Customer Service and request immediate inspection. Failure to file a claim within 15 days after receipt of merchandise constitutes acceptance and a waiver of any such claims. Please inspect merchandise immediately upon receipt, otherwise there is no recourse. Keep all cartons and packing material, discarding these materials may negate your claim.

Storage of product in areas of uncontrolled humidity and temperature may cause damage to the product and void the JSI warranty.

### Repairs

JSI will not issue credit allowance for any type of repairs without prior written consent.

Sales order, product model numbers, and reason for repair will be expected in order to process the repair request. A digital photo will help to expedite the request. JSI reserves the right to recommend solutions for repair.

### Replacement Parts

Obtain information and pricing on replacement parts by contacting Customer Service. Please have the model number available when requesting replacement parts. Additional information may be required to ensure proper replacement parts.

### Returns

JSI products are made to order and may not be returned for credit. No merchandise may be returned to JSI without a signed Return Good Authorization (RGA) form issued by our Customer Service Department. RGA's will be considered for the following reasons:

1. Manufacturing defect (validated by JSI representative).
2. JSI order processing error.
3. Shipping error.
4. Mis-marked cartons.
5. Duplicate shipments.

Liability for defective merchandise shall be limited to replacement or repair.

If you have questions as to whether your reason for return qualifies for consideration, please contact Customer Service. At the discretion of JSI, returns on stocked items may be considered with the following stipulations:

1. 60% restocking fee.
2. All return freight charges must be prepaid by dealer.
3. Product was never removed from the original carton.
4. Product must be returned within 30 days of RGA issue date.
5. Credit will not be issued if product returned is damaged.
6. Under no circumstances can we accept COD (Cash on Delivery) returns. Any such shipment will be refused.

**Please note most models on Quickship are produced on demand and cannot be returned. Modified, special or custom-built product is not eligible for return.**

### Fire Retardancy

All JSI upholstered components comply with California Bureau of Home Furnishings and Thermal Insulation-Technical Bulletin 117-2013 issued by State of California Department of Consumer Affairs. This standard requires upholstered furniture to be safer from the hazards associated with smolder ignition in all four (4) categories of materials, as applicable.

Compliance with more stringent codes may require special manufacturing considerations and upcharges.

### California Technical Bulletin 133 (CAL 133)

JSI uses a barrier material between the foam cushioning and the upholstery cover in order to comply with CAL 133. The standard upcharge on products specified to comply with CAL 133 is **\$88 list per yard** of textile.

JSI has performed a series of full scale fire tests on samples- representing worst case scenarios of upholstered units- to comply with the requirements of the state of California Technical Bulletin 133 (CAL 133). Products in compliance are labeled in accordance of the standards.

Some product designs and fabric cannot be combined to comply with CAL 133. Because of this, we reserve the right to reject any request for an upholstery cover, including COM, textile may not contain olefin or product style that we feel may compromise the integrity or safety of a product specified to comply with CAL 133.

Contact Customer Service for a quote if you require laboratory certification that a specific product and upholstery combination WILL PASS CAL 133. The quotation will include testing, video, and transportation charges plus the list cost of the sample.

Our standard lead time will apply to products that do not require certification. Allow an additional six weeks over the standard lead time for products that need actual laboratory certification.

The end user, specifier and/or dealer have the responsibility to make sure all products specified will meet the flammability and safety codes of the jurisdiction where the products will be located and used.



### Flame Spread

All JSI may be required to comply with the requirements of Flame Spread based on ASTM standards/NFPA Life Safety Codes and general public knowledge are as follows:

- Solid Wood- Class C
- Topcoats- Class A
- Carded Fabric- Class A
- Composite Panels- Class C
- Laminate- Class B

Plastics- According to the NFPA, the lack of stability of plastics under high temperature conditions and inherit combustibility have eliminated the use of plastics for applications requiring a flame spread rating.

Also be advised that improvements may be attained in certain instances with the addition of chemicals which may add additional costs, chemical exposure and/or compromise the integrity of the product.

### Textile Carded Programs

JSI is proud to partner with Maharam, Momentum, Spradling, Stinson, Ultrafabrics, Camira and Cortina Leather. Please refer to our website for our standard patterns, along with the current grade.

<https://www.jsifurniture.com/finishes-and-materials/textiles>

### Textile Grade-In Programs

For the convenience of our specifiers, we offer an extensive graded in program. Please reference our website for the most up to date information on our graded in program.

<https://www.jsifurniture.com/resources/textile-partner-info/overview/>

For additional specifications on the pattern or to order memo samples, please contact the textile suppliers directly:

- Arc Com [www.arc-com.com](http://www.arc-com.com)
- Camira [www.camirafabrics.com](http://www.camirafabrics.com)
- DesignTex [www.designtex.com](http://www.designtex.com)
- Maharam [www.maharam.com](http://www.maharam.com)
- Mayer [www.mayerfabrics.com](http://www.mayerfabrics.com)
- Momentum [www.themomgroup.com](http://www.themomgroup.com)
- Spradling [www.spradlinggroup.com](http://www.spradlinggroup.com)
- Stinson [www.cfstinson.com](http://www.cfstinson.com)
- Ultrafabrics [www.ultrafabricsllc.com](http://www.ultrafabricsllc.com)
- Cortina Leather [www.cortinaleathers.com](http://www.cortinaleathers.com)

Any textile not graded in or pre-approved for COM/COL will require application test approval prior to order entry and shipment of fabric or leather to JSI. For current JSI grades and application status by series visit [www.jsifurniture.com](http://www.jsifurniture.com) Resources > Graded-In + COM; [Graded-In + COM](#).

Indicate on purchase order if JSI is to order the fabric.

Grades and availability of fabric are subject to change without notice. Changes could include but are not limited to price increase, discontinued patterns, discontinued colors, etc. See [www.jsifurniture.com](http://www.jsifurniture.com) for up to date information.

Many textiles have repeats and the additional yardage required has been factored in for textiles ordered through the JSI Carded and Grade-In Programs. We reserve the right not to match textiles with a horizontal or vertical repeat greater than 17". Additional charges may apply for textile being applied with special instructions.

Some fabric thickness or stiffness may cause issue with proper upholstering of tackable wall panels or upholstery privacy screens. Please contact customer service with concerns on the fabric thickness for these items.

### COM/COL Address

**JSI**  
**Attn: COM/COL Department**  
**Receiving B**  
**Dock 71**  
**201 East Martin St.**  
**Orleans, IN 47452**

Tag: Dealer Name / Purchase Order #

### General COM Fabric/COL Hide Policy

Refer to the COM/COL Price Columns for list prices.

All yardage requirements listed in the price list are based upon 54" plain non-directional material. Additional yardage may be required based on fabric repeat and matching.

All square footage requirements for COL are based on an average hide size of 50 square feet.

Contact Customer Service for any of the following conditions:

- + approval of COM/COL to be used (see policy on the next page)
- + fabric repeats greater than 3"
- + fabric less than 54" wide
- + leather hides smaller than 50 square feet
- + special application requirements request

When requesting information from Customer Service on COM/COL please supply the following information:

- + model number and quantity of the product the COM/COL will be applied
- + COM/COL textile supplier's name
- + name of pattern and color of the textile
- + any special application request

Visit [www.jsifurniture.com](http://www.jsifurniture.com) Resources > Graded-In + COM to see if the textile has already been approved. If there is no record for this particular textile then a Memo Sample will be required.

JSI takes no responsibility when additional materials must be ordered.

### COM Fabric Repeat Guide

Roll Width	Plain Fabric	1" - 5" Repeat	6" - 10" Repeat	11" - 15" Repeat	16"- 20" Repeat	21" - 30" Repeat	31" - 40" Repeat	41" - 50" Repeat
54"	0%	10%	15%	20%	25%	30%	40%	50%
53" to 51"	15%	20%	25%	30%	35%	40%	50%	60%
50" to 48"	30%	35%	40%	45%	50%	55%	70%	90%
47" to 36"	60%	65%	70%	75%	80%	85%	100%	120%

The percentage represents the additional fabric yardage that needs to be added to the COM yardage. Contact Customer Service for repeats greater than 50".

All COM/COL must meet applicable codes and regulations, including TB117-2013. By selecting COM/COL, customer certifies that the material meets such codes. JSI assumes no responsibility for the applicable codes and regulation regarding flammability rating and safety rating of any COM/COL.

JSI cannot be held responsible for receipt of defective fabrics, as we apply all COM as first quality goods.

We can take no responsibility for tailoring, wear-ability or application of COM/COL textiles. Any warranty claims for the COM/COL Textile materials will fall to the original vendor of the textile, not JSI.

### COM Fabric/COL Hide Process for JSI Seating

General COM Fabric and COL Hide Policy also apply.

JSI will approve or disapprove COM/COL on all products. An approval of a textile from JSI makes no claim that performance, durability or tailoring of COM/COL will result in satisfactory upholstery. Every effort will be made to meet customer's expectation, but fabrics/leathers have unforeseen inherent characteristics that may limit JSI's ability to deliver a well tailored product.

### Approval COM Textile/COL Hide Process for Seating

#### Follow the Steps Below:

1. Send a Memo Sample of the COM/COL (recommended memo be at least 4" x 4")  
 JSI  
 Attn: COM/COL Approval Department  
 201 East Martin Street  
 Receiving B, Dock 71  
 Orleans, IN 47452
2. Call our Customer Service Department at 812-482-3204 to request an electronic version of approval form.

### Guide Order Form for COM and COL

Please send sample to:  
 JSI  
 Attn: COM/COL Approval Depart.  
 201 East Martin St.  
 Receiving B, Dock 71  
 Orleans, IN 47452

① **Order Information:**

**Quote #:** \_\_\_\_\_ **Purchase Order #:** \_\_\_\_\_

**Customer Service:** \_\_\_\_\_

**Dealer Name/Project Name:** \_\_\_\_\_

**Contact:** \_\_\_\_\_

**Address:** \_\_\_\_\_

**Phone:** \_\_\_\_\_ **Email:** \_\_\_\_\_

**Model Number(s) Receiving COM / COL:** \_\_\_\_\_

Please forward a copy of this form to your JSI CSR for record keeping

② **Select off the bolt application: (Check one of the boxes)**

Up the roll (standard on most seating)     Railroaded

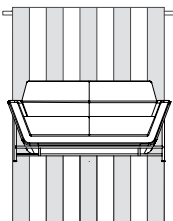
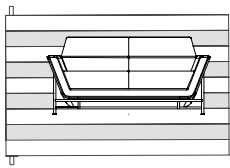
③ **Additional information:** \_\_\_\_\_

④

Attach sample here.

JSI will review and test as needed all requests. You will be notified as soon as results are documented by our review personnel. JSI reserves the right to reject any COM/COL on our products. We will provide COM/COL explanation of any unapproved textile whenever possible.

## Custom Options

### Wood Laser Engraved Back

Many of our seating models are available with a custom wood laser engraved back. University seals, logos, unique designs, or any type of graphic can be designed into the seating back for a custom creation. Copyright approval may be required. Consult JSI Customer Service for pricing and artwork specifications. Artwork must be submitted as a JPG or PDF file.



### Wood Laser Engraved Back General Pricing

\* must order plain back when choosing these options

For Artwork 4" x 4" or Less	\$63 list per chair
For Artwork Less than 6" x 6"	\$111 list per chair
For Artwork Larger than 6" x 6"	Call For Pricing

For orders fewer than 50 pieces, add \$170 list per design, per order. This pricing reflects etching (leaving the wood dark). If additional painted colors are added to artwork please call customer service for pricing.

A \$150 list set-up fee applies.

## Care and Maintenance

### Care and Maintenance

#### Care of Upholstery Surfaces

Cleanability will vary based on the fabric type. For best results, a professional service is recommended. Dirt and crumbs may be gently brushed or vacuumed off. Spills should be wiped up immediately with a cloth. Vinyl textiles can be cleaned with warm soapy water and then wiped down with a warm damp cloth. For more details on any JSI carded fabric and vinyl, please visit our website at [jsifurniture.com](http://jsifurniture.com) or consult the back of the appropriate swatch card for cleaning codes and any specific instructions. For COM materials, consult with the individual textile manufacturer for cleaning codes and any specific instructions pertaining to your particular fabric.

#### Maintenance of Mechanical Parts

Clean any lint or debris from the moving parts of the base mechanisms. Mechanisms have been designed and tested to not require lubrication under normal conditions; however, lubricant can be used if needed.

#### Care of Wood Edges and Veneer Surfaces

Clean all surfaces frequently with water dampened soft cloth, moving the cloth with the grain direction. Immediately remove any liquids that come in contact with wood surfaces with a blotting action to absorb liquid. Buff dry. Lift objects to move them, never pull them across the finished surface. For an additional safeguard, use a protective surface pad. This will ensure a lasting finish by protecting your furniture from possible damage caused by pens, cups and sharp objects. Avoid exposure of furniture to extremes of heat and cold, or to wide humidity variances. Avoid exposure of furniture to strong sunlight. Avoid exposure of furniture to harsh solvents such as nail polish remover, acetates, etc., as it will cause finish deterioration. If using a protective glass top, place spacer pads under the glass top to allow the wood to breathe.

#### Care of Metal Finishes

Wash your powder-coated item at least one every six months. Use soft rags only - No abrasives. For stubborn stains and grease marks, use soap and water mixture. Combine 1 gallon of water and 1 cup of the neutral detergent in the bucket. Mix it up by swirling one of the rags around in it. Wipe down the powder coat with a rag that has been dampened with the cleaning solution. Do not scrub, but use gentle, repetitive pressure to remove any built-up grime. Rinse the powder coat off with a rag dampened with clear, clean water. Do not spray it down, but rather wipe it off with the rag. You may need to do this several times to get all the soap off. Wipe the powder coat down with a clean dry rag. This will prevent streaking and spotting.

#### Care of Frosted Glass

Use a clean, dry lint free cloth to wipe the surface. Follow with warm water and a clean rag; no soap or chemicals. Wipe dry with a clean, dry lint free cloth. Cleaning the frosted side is not recommended, if desired to clean use the above method but do not spray the water on the frosted side, use a clean rag. Please allow 48 hours for the frosted side to dry and not to show cloudiness.

### Tempered Glass Information

JSI is aware of occasional occurrences of spontaneous glass breakage in various furniture products. Tempered glass makes it stronger and if it breaks, will cause it to break into many small pieces of “cubes” rather than sharp and potentially dangerous shards.

Glass breakage in furniture may occur for a variety of reasons. Tempered glass is particularly prone to breakage from damage (scratches, nicks, etc.) that may occur during shipping, handling, installation, use or maintenance. Exposure to rapid changes in temperature or concentrated temperature zones may also cause breakage.

Tempered glass may also break due to a specific type of imperfection or “inclusion” that occurs within the glass when manufactured. When this condition exists glass breakage may occur without any obvious cause. This is often referred to as “spontaneous” breakage but is a very isolated occurrence in the glass industry.

#### Care of Dry Erase Boards

Erase after every use to eliminate ghosting. Clean weekly with a Dry Erase Cleaner. Avoid the use of orange and red Dry Erase Markers. Follow manufacturers cleaning instructions for the eraser. If ghosting or staining remains use a small amount of rubbing alcohol on a clean, soft towel to remove.

#### Care of Solid Surface

Although liquids cannot penetrate Solid Surface, it is best to wipe up spills as they occur. Generally, a damp microfiber cloth used with a standard household kitchen spray should remove most stains.

For most residues, all you need to clean your Solid Surface countertops is a warm soapy water, ammonia-based household cleaner or a dedicated countertop cleaner. Do avoid window cleaners; however, as they can leave a waxy build-up that dulls the surface. Always clean using a circular motion.

Film will build up on countertops if water is left to dry on the surface. This film will dull the countertop surface, making the finish appear blotchy and uneven. To prevent film build-up, it is very important to wipe the countertop completely dry immediately after spills and cleaning.

Some color of Solid Surface may require more frequent cleaning to maintain a uniform finish. Darker colors tend to require more attention than lighter colors. Over time, even with proper care, your countertop will acquire a sheen. Dark colors may show light scratches more readily.

## Specification Tools

JSI products are manufactured to order and provide a multitude of options to address your individual customer needs. As you process your order do not forget to include all the necessary information to allow the order entry process to be completed. Please see the order checklist at the beginning of every series.

JSI Customer Service edits every order for complete information. If details are not included with the purchase order, Customer Service will contact you to answer these questions. If information is not completed in a timely manner it will delay the entry process and could affect your product delivery date. To avoid delay in order entry and potential delay in delivery of your order, please double check the line items to ensure all selections have been completed.

To ensure completion of details on your purchase order, electronic catalogs and specification tools have been developed to aid in the process. These electronic tools include:

**20-20 GIZA Studio and 20-20 CAP Studio** software offers state-of-the-art design, specification, photo-realistic rendering and three-dimensional visualization capabilities for configurable products in the commercial interior design markets. 20-20 GIZA Studio and 20-20 CAP Studio are available for all JSI Casework and Seating products, in 2D and 3D graphics and the Specifier Catalog. Updates are made monthly reflecting any changes that occurred. To be sure the most up to date information is provided on orders, users of this software program are responsible to update their catalogs.

**CET Designer, by Configura** is an all-in-one software solution for space planning and configuration of products. The intuitive workflow guides you through entire process from idea to reality- supporting every step of the sales process

**GSA Advantage** is a Federal Government electronic catalog site offered to assist GSA customers in specifying and pricing JSI product. Listed at this site are all contract items and prices under GSA Contract # GS-28F-0030U.

Our JSI website [jsifurniture.com](http://jsifurniture.com) provides many tools to assist in the design and order selection. Included in the site are downloadable images, typicals, product symbols, brochures, contact information, price lists, sales representative locations, warranty and environmental information.

# GSA Terms and Conditions



## Contract Holder

Contract # GS-28F-0030U

### Maximum Order

\$250,000 net

### Geographic Coverage

48 contiguous states and Washington D.C.

### Point of Production

Jasper, Dubois County, Indiana  
Orleans, Orange County, Indiana

### Discount

Discount 61.6%\* off list.

\*Discount for Walden and Wellington is 61.71% off list.

### Discount Quantity

Walden and Wellington only  
\$300,000 to \$350,000 Net = 0.5%  
\$350,001 to \$400,000 Net = 1%  
\$400,001 to \$450,000 Net = 1.5%

### Prompt Payment Terms

1% 15 - net 30 days from date of invoice.

### Government purchase cards are accepted at or below the micro-purchase threshold

### Government purchase cards are accepted above the micro-purchase threshold

### Foreign Terms

Not applicable.

### Time of Delivery

30-75 days after receipt of order, 90 days maximum.

### Expedited Delivery

Contact Customer Service 800-457-4511

### Overnight and 2-day Delivery

Not applicable.

### Urgent Requirements

Contact Customer Service 800-457-4511

### F.O.B. Points

F.O.B. destination, freight prepaid and allowed to 48 contiguous states and Washington D.C. excludes special delivery requirements.

In addition to the standard terms and conditions, the following terms and conditions apply to GSA contract.

### Contract Number

GS-28F-0030U

### Contract Period

June 24, 2013 - June 24, 2028

### Statement of Intended Use

The furniture covered by special item number 33721 Office Furniture shall comply with the requirements defined in purchase description 3QSAB 09-608. All furniture offered under this SIN shall be GSA Chassis Grade 1, 2, 3 or NA, GSA Drawer Grade 1, 2, 3, 4 or NA, Design A B or C, as defined in 3QSAB 09-608.

### Description of Special Item Number SIN #33721

### Cooperative Purchasing

No

### Set Aside

No

### FSC/PSC Code

7125

### NAICS 337211 Wood Office Furniture Manufacturing 1000 employees

Includes all furniture placed in an office, such as chairs, desks, etc. In addition, ancillary services are included, however services performed shall not be the primary purpose of the work ordered.

### Lowest Price Model

SIN #	Model Number	Net Price
33721	VS-LBRKT-20	\$28.03



## GSA Terms and Conditions

### Ordering Address

Jasper Seating Company, Inc. d/b/a JSI  
Attn: Participating Dealer  
225 Clay Street  
Jasper, IN 47546  
Fax: 812-482-1548  
Phone: 800-457-4511  
Email: orders@jaspergroup.us.com

### Order Procedures:

Per contract

### Payment Address

JSI  
225 Clay Street  
Jasper, IN 47546

### Warranty Provision

Limited Lifetime

### Export Package Charges

Quoted on project-by-project basis.

### Terms of Government Commercial Credit Card Acceptance

Accepted.

### Rental, Maintenance, and Repair

Not applicable.

### Terms and Conditions of installation

12% of net purchase order for installation services up to \$250,000.00 of net purchase price.

### Terms and conditions of repair parts, etc.

See warranty.

### List of service and distribution points

Contact Customer Service 800-457-4511.

### List of participating dealers

Contact Customer Service 800-457-4511.

### Preventive Maintenance

N/A

### Environmental Attributes

GreenGuard Certified and recycled wood waste and fabric remnants

### Section 508 Compliance

N/A

### DUNS #

00-636-7767

### CCR and SAMS Registration

Jasper Seating Company, Inc. is registered  
Cage Code #31881  
Federal ID #35-0420370  
UEI #DDJ2GKQM7M84

### Product Modifications

We willingly accept customers' modifications to standard products. See product modification information by series at the start of each series under the "Product Modification" sections. If there is a modification you desire that is not listed in this section, please call Customer Service for a modification quote/price

### Acceptance, Modification, Assignment

By placing this order for furniture, material or other products (sometimes collectively referred to as "goods"), customer agrees to these terms and conditions which shall prevail over inconsistent provisions in any other form or document of customer. No change or modification shall be applicable unless set forth in writing and signed by company. Neither this order nor any interest therein shall be assigned by customer except with the prior written consent of company.

### Payment

Customer agrees to pay to company the amount indicated on the invoice, 1% 15 days, net 30 days from date of invoice (U.S. funds only), for goods ordered. Interest will be charged after 30 days from the date of invoice at the rate of one and a half percent (1.5%) per month. International sales will require additional payment arrangements. No goods shall be sold on consignment or conditional sales basis. Payment for the goods delivered hereunder shall constitute acceptance thereof.

### Attorneys' Fees

Customer shall be responsible for all expenses and cost in connection with the enforcement by company of these terms and conditions and the cost of collection (including the fees of any collection agencies to whom the customer's account may be referred), plus reasonable attorneys' fees (which attorneys' fees shall not be less than 25% of the amount due, unless a lower amount is specified by applicable law).

### Remedies

The remedies herein reserved shall be cumulative, and additional to any other or further remedies provided in law or equity. No waiver of a breach of any provision of these terms and conditions shall constitute waiver of any other breach or of such provision.

### Insolvency

Company may forthwith cancel this order in the event of the happening of any of the following or any other comparable event: insolvency of the customer, the filing of a voluntary petition in bankruptcy, the filing of any involuntary petition to have customer declared bankrupt provided it is not vacated within thirty (30) days from the date of filing, the appointment of a receiver or trustee for customer provided such appointment is not vacated within thirty (30) days from the date of such appointment, or the execution by customer of an assignment for the benefit of creditors.

## GSA Terms and Conditions

### Limitation of Liability

The Company shall not under any circumstances be liable to the customer, owner of the goods or any third party for special, indirect, incidental, or consequential damages, including, without limitation, loss of profits or revenues, loss or damage to other property or equipment, cost of capital or of purchased or replacement goods, or expense, delay, or inconvenience caused by or arising from the purchase, sale, use, repair or inability to use the goods or by any performance or non-performance under, or breach of, these terms and conditions. The Company's sole liability for any defective goods shall be its repair or its replacement pursuant to the express warranties set forth above, or if amended, as applicable at the time of manufacture or repair of the goods. Some states do not allow the exclusion or limitation of incidental or consequential damages, so the above limitations or exclusion may not apply to all customers. Any action resulting from any breach on the part of company as to the goods or services delivered here under must be commenced within one year after the cause of action has occurred.

### Returns and Allowances

Reasonable touch-up and deluxing is the dealer's responsibility. The Company will not make allowances for trip or delivery charges, but will only make allowance for actual work performed to correct manufacturing defects. Allowances maybe authorized only by a company officer. It is the responsibility of the field sales representative to inspect any defective merchandise and make suggestions and recommendations as to the proper disposition. Field personnel cannot obligate or bind the company by definite agreement, without final authorization by a company officer. Company will not accept automatic charge backs which do not have prior authorization. All defects must be called to the company's attention upon arrival at the customer's "ship to" destination. To initiate any type of claim or request for parts, it is imperative to have the model number or fabric number, which may be located on the tag attached to the frame of the unit. Authorization for return to the company via a return goods authorization. Company will not issue credit allowances for any repairs without company's prior consent. Under no circumstances shall the company accept COD (cash on delivery) returns, and any such shipment will be refused.

### Security Agreement

The Company may require and customer shall grant a security interest in goods sold pursuant to any credit the company may extend to the customer.

### Governing Law

All disputes between the parties, whether or not arising out of these terms and conditions, will be governed by the laws of the state of Indiana. Customer agrees to submit to the jurisdiction of and agrees all lawsuits relating to any disputes between the customer and the company will be brought only in a state court located in Dubois County, Indiana or the United States District Court for the Southern District of Indiana. The customer hereby waives the right to a trial by jury in any action, proceeding, claim, or counterclaim whether in contract or tort, at law or in equity, arising out of or relating in any way to these terms and conditions and all other disputes between the parties.

### Mitigation

If the company repossesses the goods prior to payment by the customer of all amounts due hereunder, the company may sell the goods, as is, where is, free and clear of all rights of the customer at either public or private sales, and apply the net proceeds (after deducting expenses of repossession and sale) to the obligation of customer hereunder. The customer may dispose of the goods in any commercially reasonable place and manner and the customer waives any notice of time, place and manner of sale.

### Integration

This order for goods, including these terms and conditions, along with any credit application, invoice, statement, dealer contract, acknowledgment, bill of lading (and any exhibits, addenda or amendments thereto) of which this order may be a part, constitutes the sole and complete agreement between the company and the customer with respect to the purchase of the goods.

### Dimensions/Specifications/Finishes

All dimensions are approximate and may vary due to the upholstery technique of each craftsman. If exact dimensions are required, it is necessary for the customer to state such specifications with the order. Detailed specifications sheets are available for each series of goods, and customer should consult the company's customer service department for these specification sheets. Company reserves the right to make changes in dimensions, style, or specifications if company believes these changes will improve the goods' quality or appearance. Company reserves the right to substitute hardwoods due to availability at production. Due to the natural characteristics of wood, environmental effects, and material upgrades, the company cannot guarantee exact finish matches on existing goods previously ordered from company. If an exact match to customer's existing goods is required, it must be specified so that the proper procedures can be followed to ensure an acceptable finish. Company will accept no liability for the finish if this procedure isn't followed. Company reserves the right to make changes in a finish formula if company believes the change will improve the quality or appearance of company's goods.

### Company's Performance of Its Obligation

The production and delivery of the goods to the extent delayed or hindered or prevented from the performance by reason of natural disasters, acts of god, strikes, lockouts, labor troubles, inability to procure materials, casualties, failure of power, restrictive governmental laws or regulations, riots, insurrections, acts of terrorism, war or other reason of a like nature not the fault of the company shall excuse for the period of the delay the company's performance and the period for the performance shall be extended for a period equivalent to the period of such delay.

## Training - Table of Contents



Training



Teamwork



Conference



Lounge

### Lok - Training

#### Product Information

Training Overview . . . . .	3
Tables Shapes & Sizes . . . . .	4
Laminate Specifications . . . . .	5
Base Styles - Features . . . . .	6
Nesting Details . . . . .	7
Modesty Details . . . . .	8-9
Screen Details . . . . .	10-11
Electrical Planning - Options . . . . .	12-13
How To Specify . . . . .	14-15

#### Pricing Pages

Training Table Tops . . . . .	16-37
Bases . . . . .	17-63
Modesty Panels . . . . .	64-66
Privacy Screens . . . . .	67
Portable Slide On Screens . . . . .	68-69
Instructor Stations . . . . .	70-71
Podiums . . . . .	72
Mobile & Fixed Screens . . . . .	73
ECONO Electrical . . . . .	74-75
LINK Electrical . . . . .	76-77
Wire Management . . . . .	78
Accessories . . . . .	79

## Training - Overview



rectangular  
pages 22-26



trapezoid  
pages 28

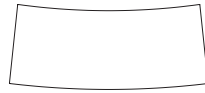

lecture  
pages 30

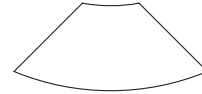

crescent  
pages 32

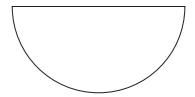

half round  
pages 34

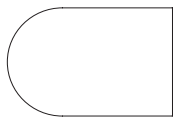

bullet  
pages 36

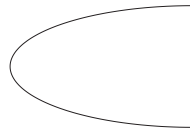

hive  
pages 37

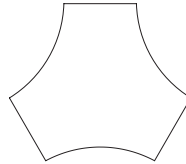

intersect  
pages 38



huddle  
pages 39

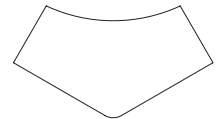

one twenty  
pages 40

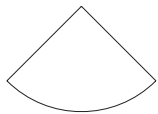

quarter round  
pages 42

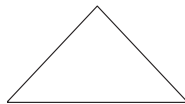

wedge link  
pages 43

## Training - Top Shapes

Lok offers 12 training table top shapes. Tables are available in 29" and are always laminate. Compatible bases are: T Base, Cantilever T Base or In Line. Seating capacity below assumes that only one side is used.

LOK - TRAINING



rectangular

29"h

- 20" x 36" Seats 1
- 20" x 48" Seats 1
- 20" x 60" Seats 2
- 20" x 66" Seats 2
- 20" x 72" Seats 3
- 20" x 84" Seats 3
- 20" x 96" Seats 4
- 24" x 36" Seats 1
- 24" x 48" Seats 1
- 24" x 60" Seats 2
- 24" x 66" Seats 2
- 24" x 72" Seats 3
- 24" x 84" Seats 3
- 24" x 96" Seats 4
- 30" x 36" Seats 1
- 30" x 48" Seats 1
- 30" x 60" Seats 2
- 30" x 72" Seats 3
- 30" x 84" Seats 3
- 30" x 96" Seats 4



trapezoid

29"h

- 24" x 48" Seats 1
- 30" x 48" Seats 1



lecture

29"h

- 24" x 48" Seats 1
- 24" x 60" Seats 2
- 30" x 48" Seats 1
- 30" x 60" Seats 2

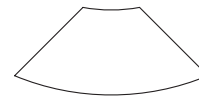

crescent

29"h

- 24" x 48" Seats 1
- 30" x 48" Seats 1

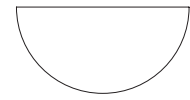

half round

29"h

- 24" x 48" Seats 2
- 30" x 60" Seats 2

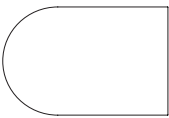

bullet

29"h

- 30" x 60" Seats 4
- 30" x 66" Seats 4
- 30" x 72" Seats 5
- 36" x 60" Seats 4
- 36" x 66" Seats 5
- 36" x 72" Seats 5
- 48" x 72" Seats 6

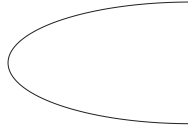

hive

29"h

- 30" x 60" Seats 4
- 30" x 66" Seats 4
- 30" x 72" Seats 5
- 36" x 60" Seats 4
- 36" x 66" Seats 5
- 36" x 72" Seats 5
- 48" x 72" Seats 6

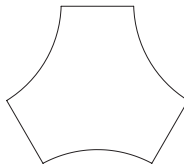

intersect

29"h

- 24" x 60" Seats 6
- 30" x 60" Seats 6

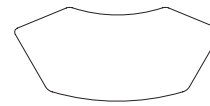

huddle

29"h

- 30" x 72" Seats 6
- 36" x 84" Seats 6

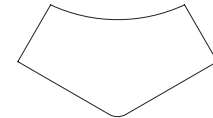

one twenty

29"h

- 42" x 73" Seats 4
- 45" x 84" Seats 4

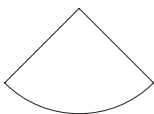

quarter round

29"h

- 24" Seats 1
- 30" Seats 1

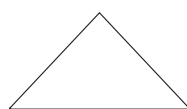

wedge link

29"h

- 24" Seats 1
- 30" Seats 1

## Training - Surface Materials

### Laminate Tops

Lok training table worksurfaces are offered in both TFL (Thermal Fused Laminate) and HPL (High Pressure Laminate).

The tops are 1 3/8" thick, 3 ply balanced construction.

**HPL** - Particle board core, HPL face and a phenolic backer sheet complete the balanced construction.

**TFL** - Particle board core, TFL thermally fused face and matching backer complete the balanced construction.

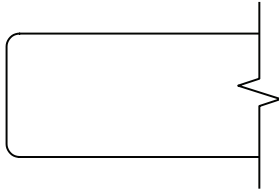

### Eased Edge (R3)

PVC

### Standard PVC Edge Colors

JSI supports 26 standard PVC edge colors listed below. These coordinate with our Standard TFL and HPL (T1) Laminates.

When selecting a Standard TFL or HPL 1 Laminate, the coordinating PVC edge color is automatically applied. When selecting a Graded-In Laminate (HPL 2), you will be prompted to choose between one of those 26 PVC edge colors to be applied to the edge.

<b>ALB</b>	Alabaster	<b>MES</b>	Mesa
<b>BEL</b>	Belair	<b>MIN</b>	Mineral
<b>BLK</b>	Black	<b>MCH</b>	Mocha
<b>BRK</b>	Brickdust	<b>OBK</b>	Outback
<b>BBL</b>	Bridal Blanco	<b>PIL</b>	Pilsner
<b>CSK</b>	Cask	<b>PIN</b>	Pinnacle Walnut
<b>CLY</b>	Clay	<b>SHD</b>	Shadow
<b>DWH</b>	Designer White	<b>SLG</b>	Slate Grey
<b>EGR</b>	Egret	<b>UMB</b>	Umber
<b>FAW</b>	Fawn	<b>VAL</b>	Valley
<b>FLN</b>	Flint	<b>WAL</b>	Walnut Heights
<b>FLO</b>	Florence Walnut	<b>WEA</b>	Weathered Ash
<b>LOF</b>	Loft	<b>ZEN</b>	Zen Grey

### Standard Laminates

JSI Standard Laminate program consists of 26 solid and wood grain patterns, and establish our standard TFL and HPL (T1) laminate pricing. Each has a coordinating PVC edge color that is automatically used with the Standard Laminates.

#### Wood Grain Laminate

<b>BEL</b>	Belair	<b>MIN</b>	Mineral
<b>BRK</b>	Brickdust	<b>MCH</b>	Mocha
<b>CSK</b>	Cask	<b>OBK</b>	Outback
<b>CLY</b>	Clay	<b>PIL</b>	Pilsner
<b>EGR</b>	Egret	<b>PIN</b>	Pinnacle Walnut
<b>FAW</b>	Fawn	<b>UMB</b>	Umber
<b>FLN</b>	Flint	<b>VAL</b>	Valley
<b>FLO</b>	Florence Walnut	<b>WAL</b>	Walnut Heights
<b>LOF</b>	Loft	<b>WEA</b>	Weathered Ash
<b>MES</b>	Mesa		

#### Solid Laminate

<b>ALB</b>	Alabaster
<b>BLK</b>	Black
<b>BBL</b>	Bridal Blanco
<b>DWH</b>	Designer White
<b>SHD</b>	Shadow
<b>SLG</b>	Slate Grey
<b>ZEN</b>	Zen Grey

See pages 456-461 for Tier 2 Laminates.

## Training - Base Styles

Lok provides a choice selection of bases in both function and aesthetics to serve a variety of needs. The training offering includes: T-base, Cantilever T-Base, and In-Line T-Base

LOK - TRAINING

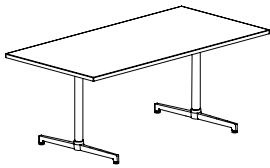

### T-Base

- models offered in fixed leg with glide or caster, tilt with caster, or 9 pin adjustable height leg
- compatible with the following top shapes: bullet, crescent, half round, lecture, rectangular, trapezoid, intersect, huddle, hive, one-twenty
- base finish - select single metal finish or two-tone metal finish. See options listed below.

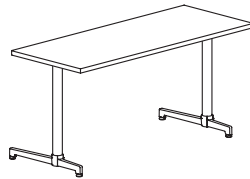

### Cantilever T-Base

- models offered in fixed leg with glide or caster, tilt with caster, or 9 pin adjustable height leg
- compatible with the following top shapes: crescent, half round, lecture, rectangular, trapezoid
- base finish - select single metal finish or two-tone metal finish. See options listed below.

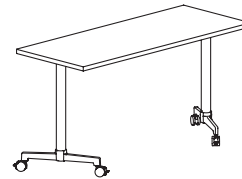

### In-Line T-Base

- available in 29" h leg with caster
- compatible with the following top shapes: crescent, half round, lecture, rectangular, trapezoid
- base finish - select single metal finish or two-tone metal finish. See options listed below.
- allows tables to nest inline
- not available on 30" d rectangular tops

### Single Metal Finish

- ABZ** Aged Bronze Feet & Post
- ASL** Arctic Silver Feet & Post
- BWH** Bright White Feet & Post
- GLD** Gold Feet & Post
- PEW** Pewter Feet & Post
- MBK** Matte Black Feet & Post
- SBZ** Soft Bronze Feet & Post
- SNK** Soft Nickel Feet & Post

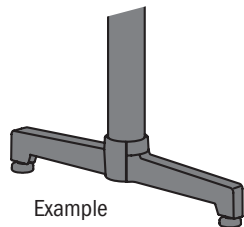

Example

### Two - Tone Metal Finish

Two - Tone Aesthetics can be achieved by specifying Polished Aluminum on the foot and a contrasting finish on the post

#### Polished Aluminum Feet

- ABZ** Aged Bronze Post
- ASL** Arctic Silver Post
- BWH** Bright White Post
- GLD** Gold Post
- PEW** Pewter Post
- MBK** Matte Black Post
- SBZ** Soft Bronze Post
- SNK** Soft Nickel Post

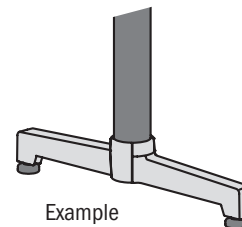

Example

### 9-Pin Adjustable Height

Pin adjustment located on column offers the ability to adjust tables from 26" to 34" high.

Easy operation by pushing in spring loaded latch pins, slide to desired height position and release pins to lock into place.

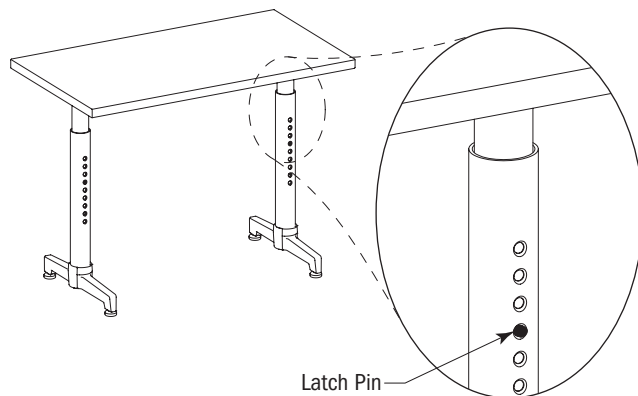

Latch Pin

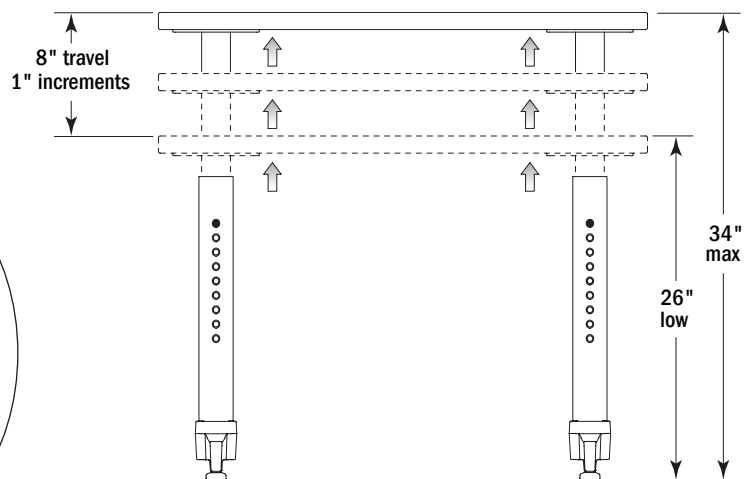

## Training - Nesting/Space Planning

### Lok In line and Offset Nesting

- adapt to ever changing multi-purpose areas, providing reconfigurability
- modularity, flexibility and ease of use by a single individual with single paddle release
- tilt and lock in position for easy nested storage
- T-Base & Cantilever T-Base allows nesting applications with the offset spacing, while In Line nesting is achieved by the In Line T-Base
- offset or in line nesting limit storage space required to move the tables out of the way
- compact tilted tables easily move to another location
- wire management clips are incorporated into the horizontal top cross beam in 48" or wider tables

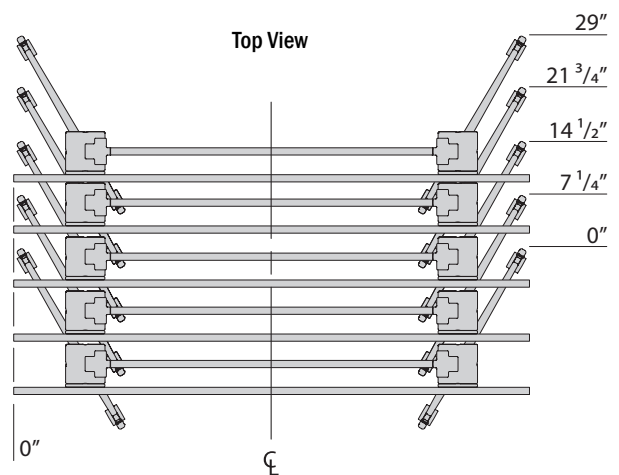
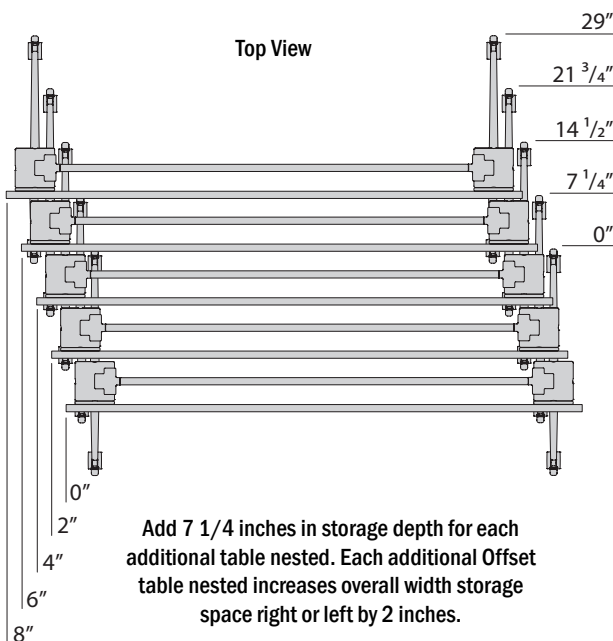
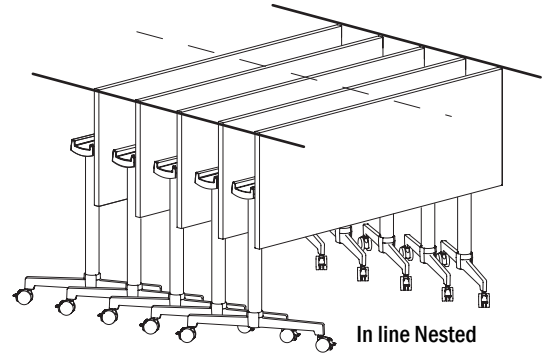
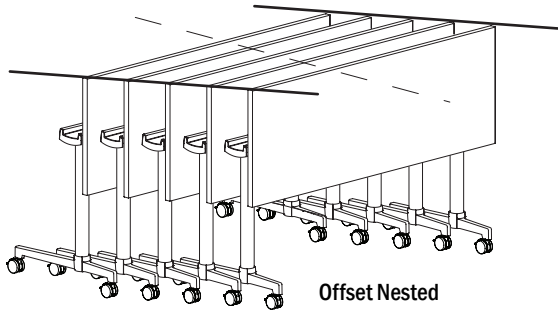
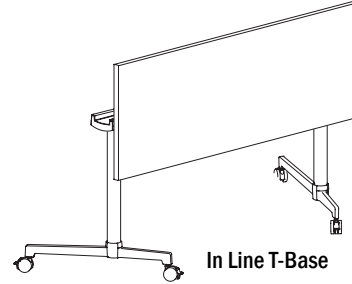
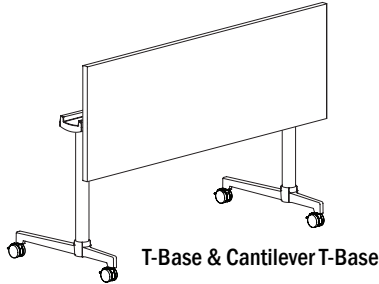

## Training - Modesty Panels

### Modesty Panels

Full table width panels provide user 9" of privacy and conceal electrical components and wire channels.

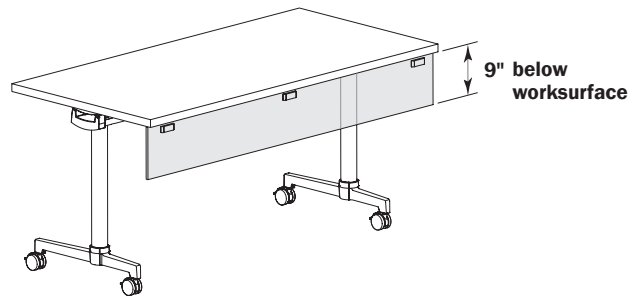
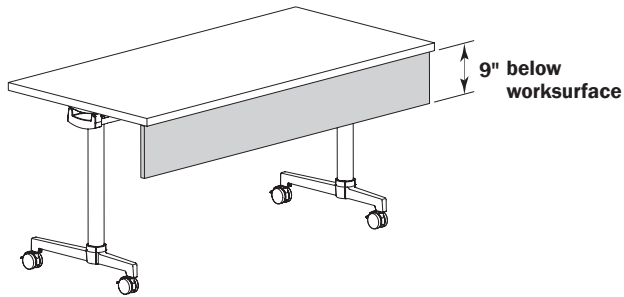

#### Laminate

- 3/4" thick
- 21 standard TFL or Tier 1 HPL with matching PVC edge
- additional graded in laminates, select from standard PVC edges
- supported with concealed hinge or support brackets
- 5/8" space provided between top edge of modesty panel and bottom surface of top to route electrical wires from top of table to under side

#### Frosted Acrylic

- 1/4" two sided frosted acrylic
- acrylic panels supported with hinge or bracket with powder-coated cover plate to conceal support hardware
- 5/8" space provided between top edge of modesty panel and bottom surface of top to route electrical wires from top of table to under side
- specify trim cap Aged Bronze, Arctic Silver, Gold, Pewter, Matte Black, Soft Bronze, Soft Nickel

## 3 Attachment Methods

Acrylic and laminate modesty panels can be specified with 3 different attachment methods. Select from Hinged, Removable, or Fixed - see pages 70-72.

### 1 Hinged Modesty Panels with Tilt Table Option

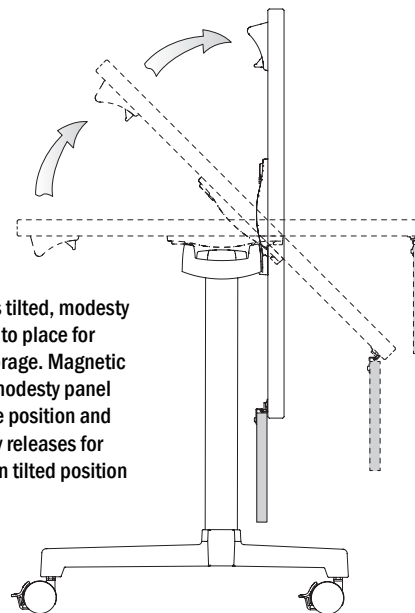
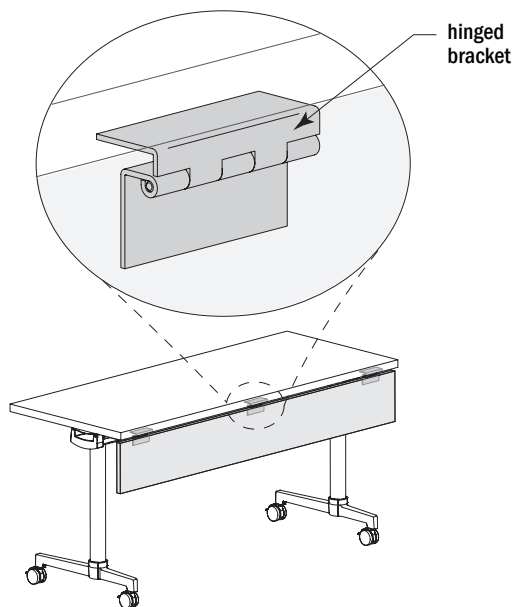

When table is tilted, modesty panel folds into place for organized storage. Magnetic hinge holds modesty panel vertical in use position and automatically releases for self-storage in tilted position

Hinged Modesty Panels allows for table nesting

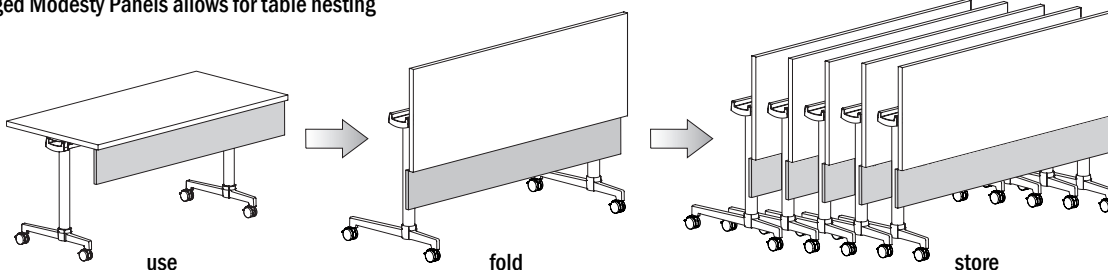

# Training - Modesty Panel Attachment Methods

## 2 Removable Modesty Panels with Tilt Table Option

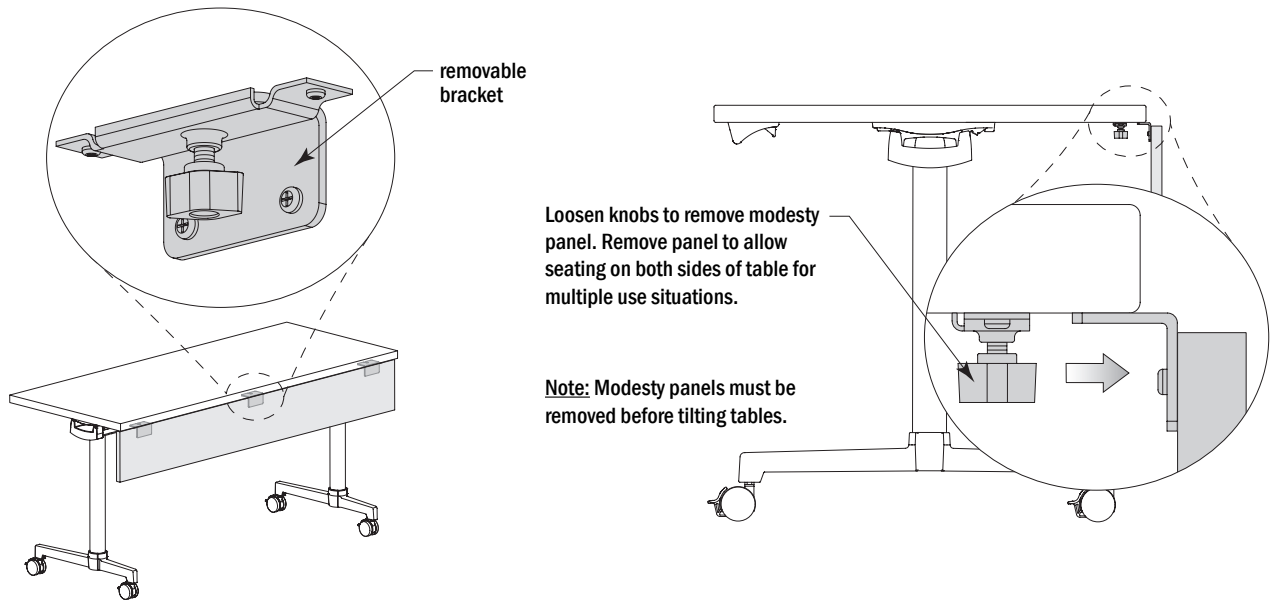

Removable modesty panels allows for single and dual users and storage

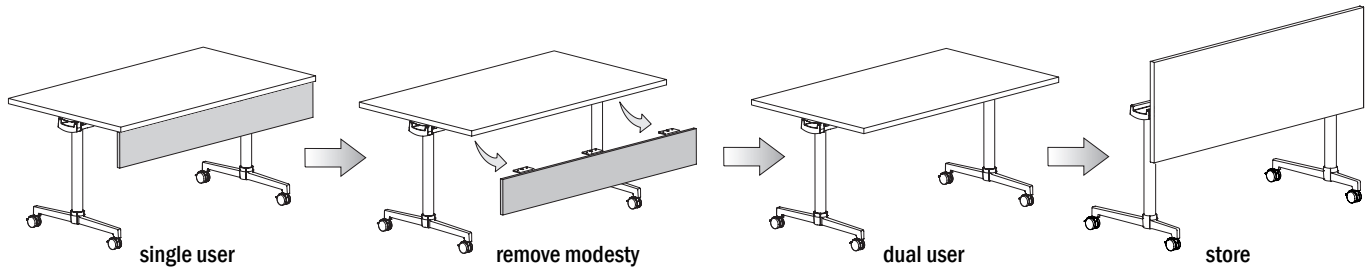

## 3 Fixed Modesty Panels

Fixed modesty panels are intended to always be attached and should not be specified in conjunction with tilt top tables.

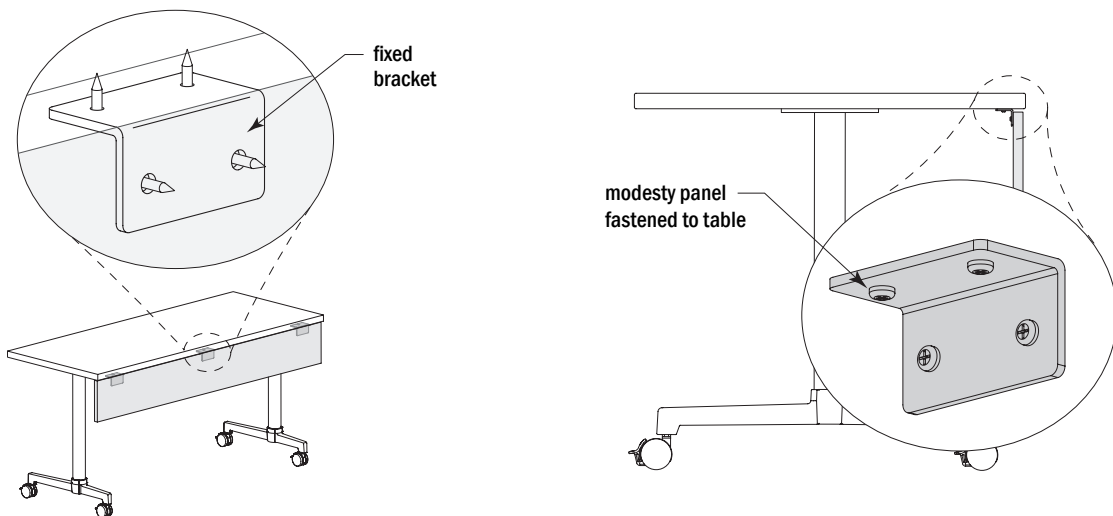

## Training - Screens

### Portable Slide-On Divider Screen

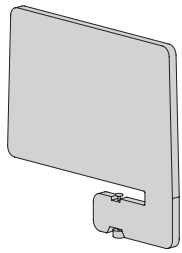

Portable divider panel divides space between seats and acoustic materials muffles sound in high traffic areas

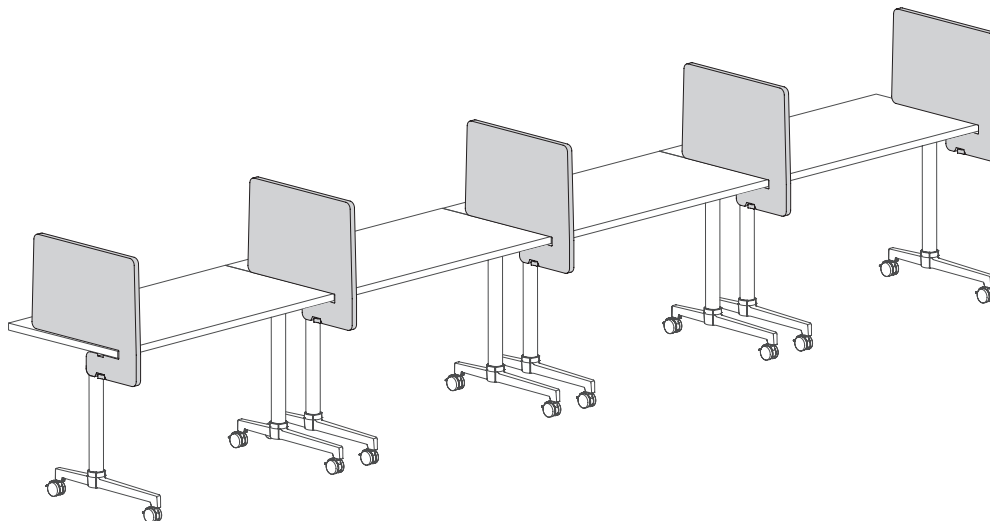
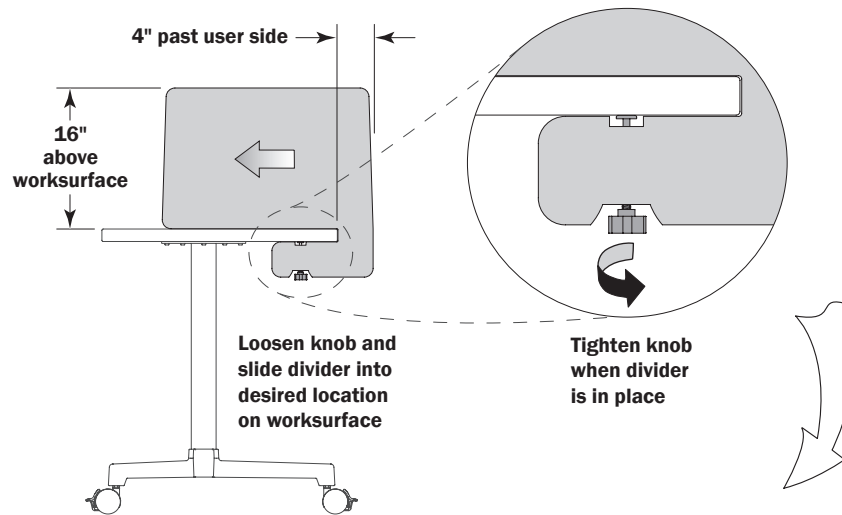

#### Acoustic

- screen provides 16" above and 4" user side concealment
- 1" tackable acoustic 100% polyester screens in silver or ash grey
  - acoustic rating: 0.45 - 0.90 NRC
  - fire rating: ASTM-E84 / class A
  - colorfastness to light: AACC 16.3 option 3 color change @ 20AFU = 4.5
  - vacuum to remove dust, remove spills immediately using a clean damp cloth or with soap and water
  - carpet or fabric cleaner can be used for difficult spills - always test on an inconspicuous area first
- easily repositioned by user to divide space or as end of table privacy
- can be secured to any surface 1 ¼" - 1 ½" thickness and 20" or greater depth
- knob on underside of table temporarily clamps screen in position for easy repositioning

#### HPL

- particle board core
- HPL laminate surfaces - JSI standards
- matching PVC edge

#### Markerboard

- plywood core
- white marker HPL surfaces
- white PVC edge

#### Magnetic Markerboard

- plywood core
- white magnetic marker HPL surfaces
- white PVC edge

# Training - Screens

## Privacy Panel Screens

Full width panel to provide user privacy concealing electrical components, wire channels and equipment on table top. Screens provide 8 1/2" below and 14" above top concealment

Privacy Panel

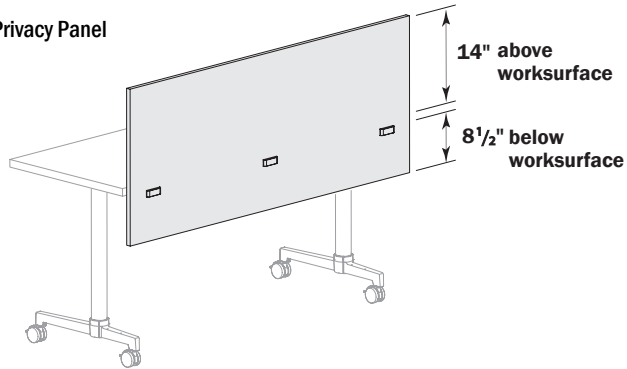

Privacy Acrylic Panel

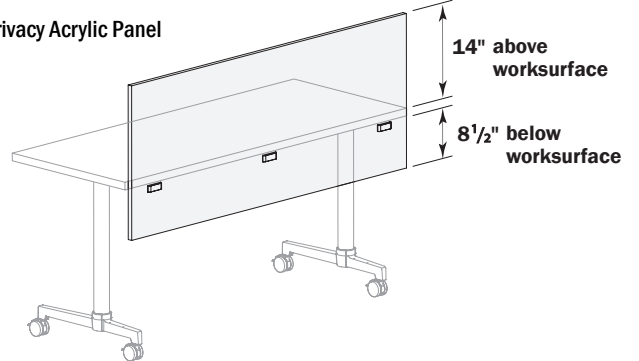

### Acoustic

- 1/2" tackable acoustic 100% polyester screens in silver or ash grey
  - acoustic rating: 0.45 - 0.90 NRC
  - fire rating: ASTM-E84 / class A
  - colorfastness to light: AACC 16.3 option 3 color change @ 20AFU = 4.5
  - vacuum to remove dust, remove spills immediately using a clean damp cloth or with soap and water
  - carpet or fabric cleaner can be used for difficult spills - always test on an inconspicuous area first

### Acrylic

- 1/4" two sided frosted acrylic

Privacy Panel Colors	
ASH	Ash Grey
SIL	Silver Grey

### Screen Mounting

- screens supported by brackets with powder coated cover plates fastened to underside of top
- mounting brackets can be fastened out for routing cables to underside of top or to install monitor arm
- screens available for approach and end of table applications
- linking kits available for shared privacy screen application between two tables approach or end applications
- screens must be removed before tilting

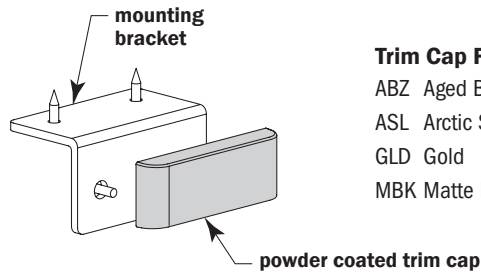

### Trim Cap Finishes

- ABZ Aged Bronze
- ASL Arctic Silver
- GLD Gold
- MBK Matte Black
- PEW Pewter
- SBZ Soft Bronze
- SNK Soft Nickel

## Training - Electrical - LINK System

### Overview

LINK has in-surface 110 power with USB A charging. Non-direction/non-sequential power cables plug together with red, green, white and black terminal connections. Configure with single or dual circuit units to maximize power flexibility. LINK provides three power infeed models; NEMA 15amp or 20amp three prong plug single circuit, quick disconnect or hardwire to support single or dual circuit applications.

- two 110 power and dual USB type A charging
- Metal unit - black or white color selection
- Non-directional/non-sequential power
- Three building power connection infeed models to select from
- Up to eight duplex devices per infeed circuit

### Components included when LINK Power selected:

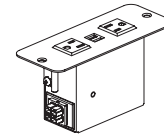

Top Unit x 1

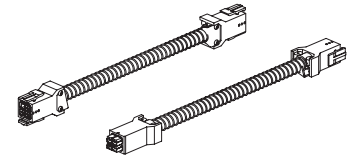

Jumper x 2

- 1 - female to female
- 1 - female to male

Above quantity shows when C (Center) is specified.

When L (Left) / R (Right) are specified, the quantity is double.  
Top Unit x 2 and Jumper x 3

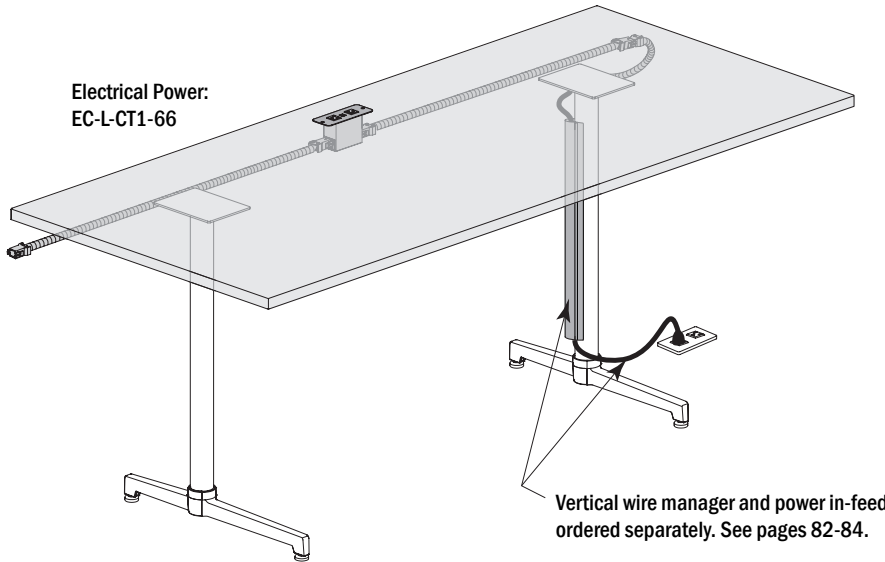

Electrical Power:  
EC-L-CT1-66

Vertical wire manager and power in-feed ordered separately. See pages 82-84.

### Electrical

Power Packages are measured and located out from the center of the table. Shown on rectangular tops, these dimensions are the same from center regardless of table shape. Power in-feed is specified separately to support building electrical connection.

#### LINK Components:

Ganged Tables	Power In-Feed	Power Centers	Jumpers
<b>48" - 96" Tables - CT1</b>			
8	1	8	16
7	1	7	14
6	1	6	12
5	1	5	10
4	1	4	8
3	1	3	6
2	1	2	4
1	1	1	2
<b>66" - 96" Tables - LRT2</b>			
4	1	8	12
3	1	6	9
2	1	4	6
1	1	2	3

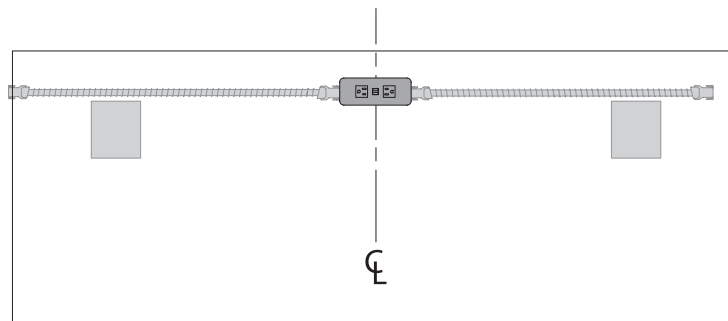

L-CT1-C0 - Single Power in Center Location on top cutout locations

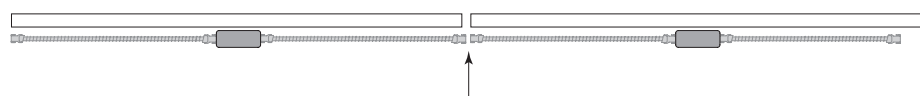

Jumper connection at edge of tables.

# Training - Electrical - ECONO System

## Overview

ECONO electrical system allows up to eight duplex power modules to be daisy-chained together (non-direction/non-sequential) and powered from a single power in-feed. The number of power modules connected is limited to the maximum allowed under UL Standard 962. If too many are connected, the control module disconnects all power to the system and signals red. Power is restored to the system after the extra power module(s) are disconnected, which is indicated by a green light. Econo will not work with GFI or GFCI - Ground Fault Circuit Interrupter Wall or Floor Outlets.

- Two 110 power and two data openings
- Single circuit power with 12 amp total system
- Plastic unit with retractable lid - black or grey color selection
- Over-current protection
- Up to eight duplex devices per infeed

Electrical Power  
EC-E-CT1-66

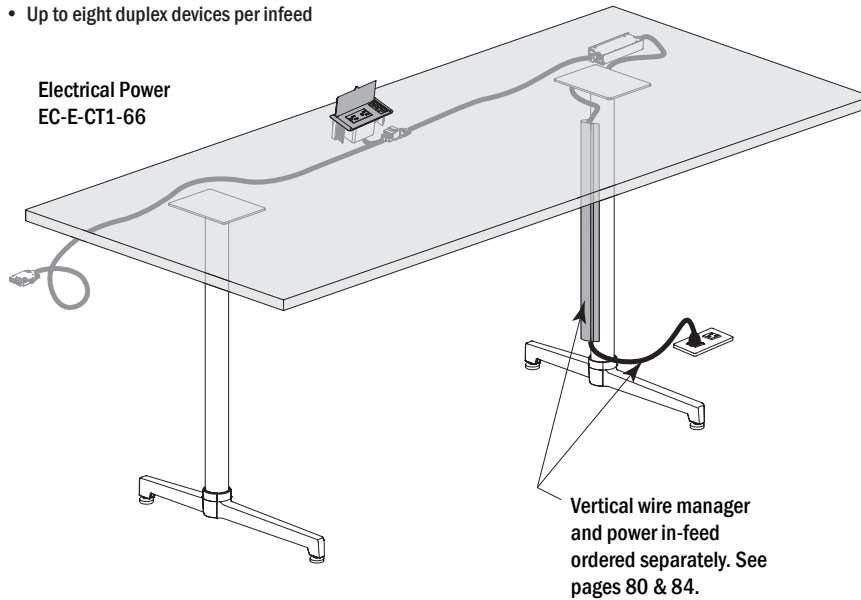

### Components included when ECONO Power selected:

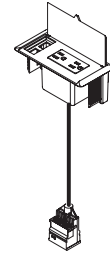

Top Unit x 1



Jumper x 1

Above quantity shows when C (Center) is specified.

When L (Left) / R (Right) are specified, the quantity is double.  
Top Unit x 2 and Jumper x 2

## Electrical

Power is measured and located out from the center of the table. Shown on rectangular tops, these dimensions are the same from center regardless of table shape. Power in-feed is specified separately to support building electrical connection.

### ECONO Components:

Ganged Tables	Power In-Feed	Power Centers	Jumpers
---------------	---------------	---------------	---------

#### 48" - 96" Tables - CT1

8	1	8	8
7	1	7	7
6	1	6	6
5	1	5	5
4	1	4	4
3	1	3	3
2	1	2	2
1	1	1	1

#### 66" - 96" Tables - LRT2

4	1	8	8
3	1	6	6
2	1	4	4
1	1	2	2

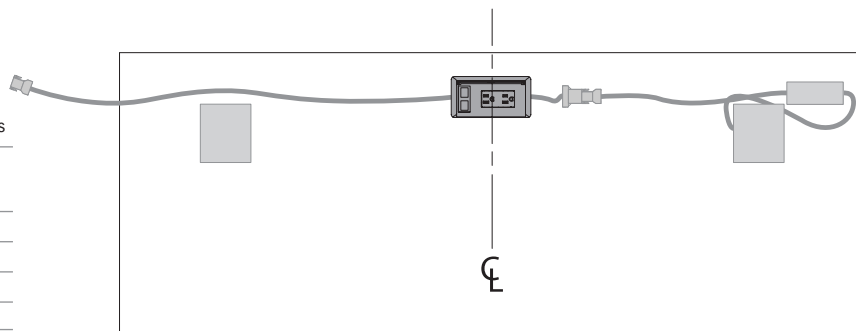

E-CT1-CO - Single Power in Center Location on top cutout locations

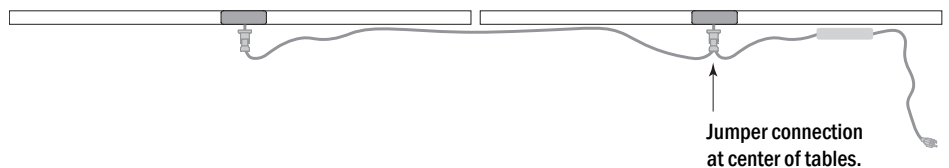

## Training - Cantilever Tilt Specifying

### Overview

Lok Training was created with the simple a la carte, select of top, base, electrical, and screens. Pages with tops list all the necessary details to determine your budget with page references to guide you to the detail selections, including all the available options, colors and finishes. Build it your way in 5 easy steps!

**1. Specify Top**

- a. power cut out (optional)
- b. link (optional)

**2. Specify Base**

**3. Specify Modesty Panel**

- a. (optional)

**4. Specify Electrical**

- a. (optional) - not shown below

**5. Specify Accessories**

- a. (optional) - not shown below

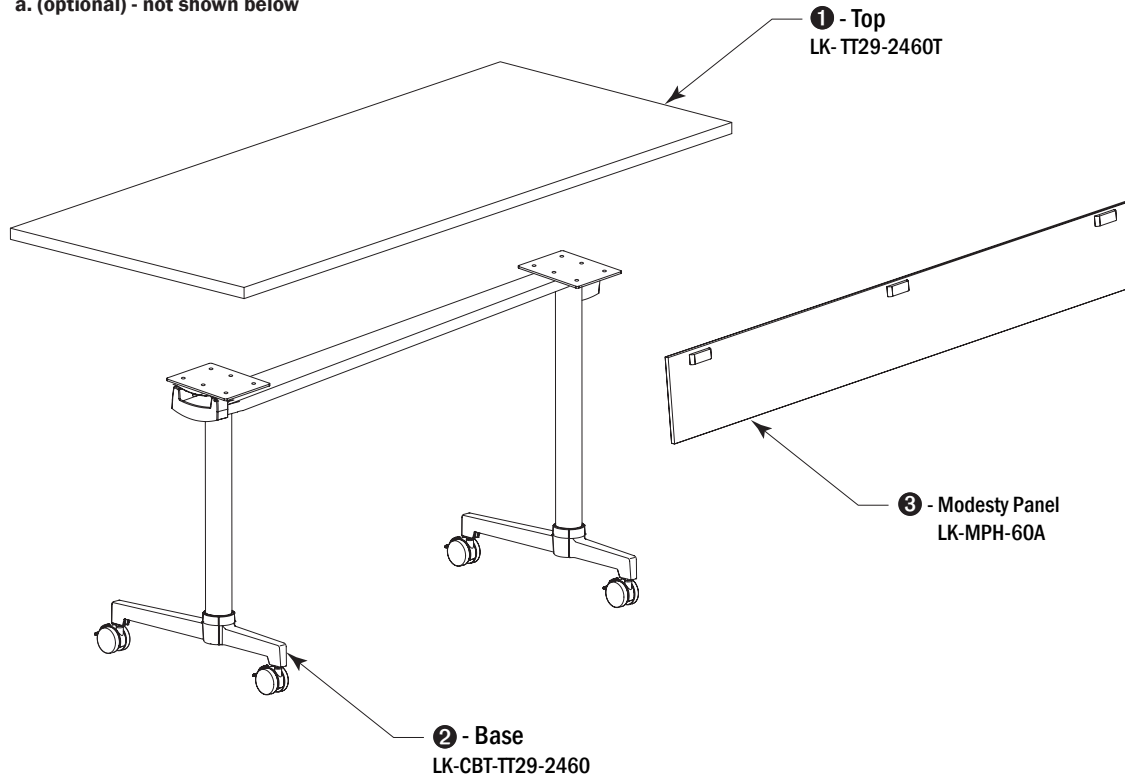

### Model Number Breakdown

**1 - Top**

LK-TT29-2460T

LK	TT	29	2460	T	
Lok Designator	Top Shape - Rectangular	Table Height - 29"	Top Size - 24" x 60"	Top Material - Laminate	

**2 - Base**

LK-CBT-TT29-2460

LK	CBT	TT	29	2460	
Lok Designator	Base Type - Cantilever T-Base Tilt (with casters option)	29" Table Height	Table Height - 29"	Top Size - 24" x 60"	

**3 - Modesty Panel**

LK-MPH-60A

LK	MP	H	60	A	
Lok Designator	Panel Type - Modesty	Function - Hinged	Panel Size - 60"	Panel Material - Frosted Acrylic	

## Training - Fixed T Specifying

### Overview

Lok Training table offer the many configurations and room layouts to support todays diverse learning environments. When planning a space, select the size and shape tops that best fit the space you are planning. Then select the base type that supports the function the space requires, static setting with T-Base and glides, additional knee space with cantilever T-base, easy reconfiguration by adding casters, compact storage with offset or inline tilt/nest, special height considerations with pin height adjustment.

1. Specify Top
  - a. power cut out (optional)
  - b. link (optional)
2. Specify Base
3. Specify Modesty Panel
  - a. (optional)
4. Specify Electrical
  - a. (optional) - not shown below
5. Specify Accessories
  - a. (optional) - not shown below

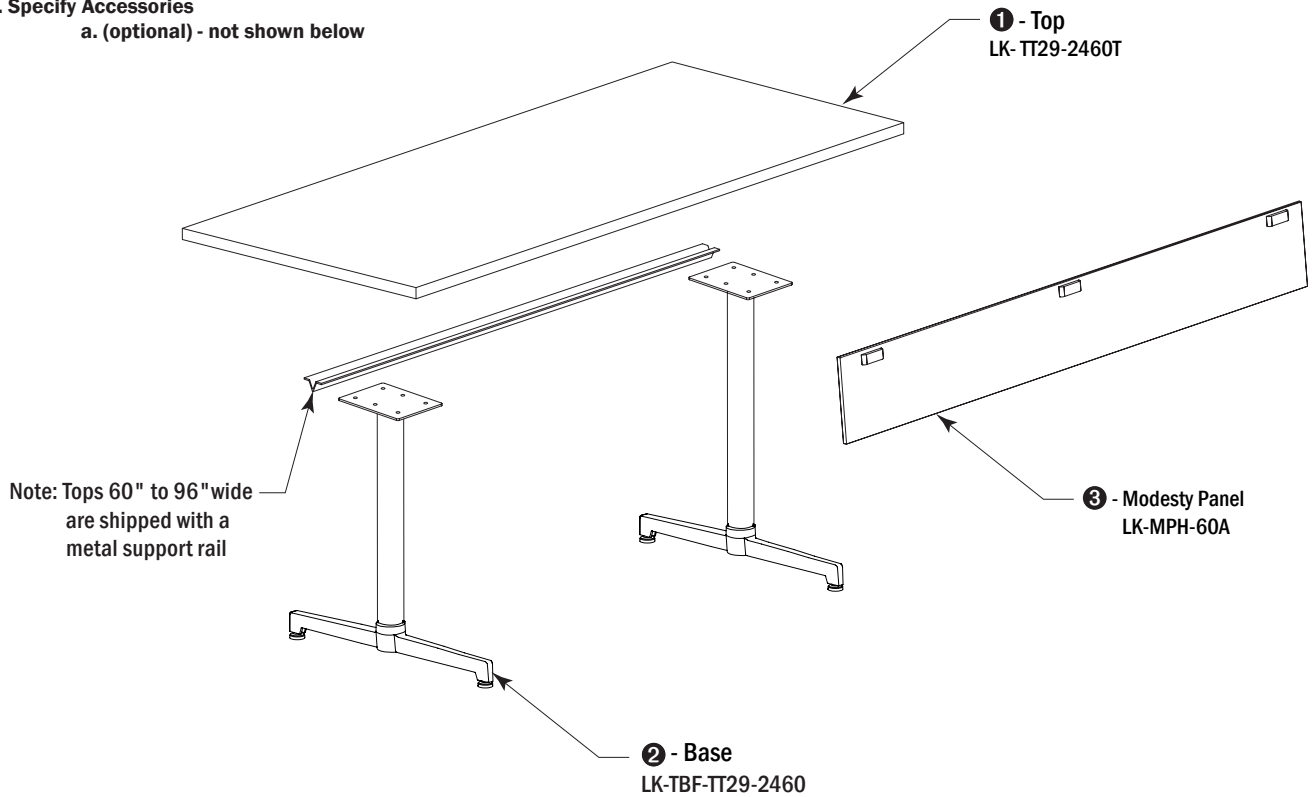

### Model Number Breakdown

#### 1 - Top

LK-TT29-2460T					
LK	TT	29	2460	T	
Lok Designator	Top Shape - Rectangular	Table Height - 29"	Top Size - 24" x 60"	Top Material - Laminate	

#### 2 - Base

LK-TBF-TT29-2460					
LK	TBF	TT	29	2460	
Lok Designator	Base Type - Fixed T-Base (standard with glides)	29" Table Height	Table Height - 29"	Top Size - 24" x 60"	

#### 3 - Modesty Panel

LK-MPH-60A					
LK	MP	H	60	A	
Lok Designator	Panel Type - Modesty	Function - Hinged	Panel Size - 60"	Panel Material - Frosted Acrylic	

Description

Rectangular Training Top

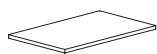

top shape

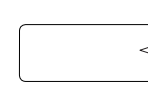

Eased Edge (R3)

D	W	H	CTN WT	CU FT	① Model	TFL	Standard	Graded In
							HPL 1	HPL 2
20	36	29	22	2	LK-TT29-2036T	\$273	\$368	\$384
24	36	29	26	2	LK-TT29-2436T	\$308	\$394	\$415
30	36	29	33	3	LK-TT29-3036T	\$322	\$437	\$462
20	48	29	29	2	LK-TT29-2048T	\$308	\$424	\$444
24	48	29	35	3	LK-TT29-2448T	\$350	\$460	\$486
30	48	29	43	3	LK-TT29-3048T	\$368	\$517	\$549

LAMINATE  
LOK - TRAINING

**Table Components: (order separately)**

- base, modesty panel, electrical, and privacy screens sold and ship separately
- specify power option, see below
- optional set of (2) linking bracket, specify and add an additional \$66 list

**Electrical Options/Cutout Locations:**

- specify power cutout and indicate if Link or Econo System will be used
- reference drawing below for approximate location

**CT1 : Single Power Center Top Cutout Location**

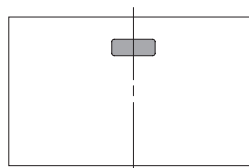

(36"- 48" wide)

**To Order Specify**

① Model #	②a Laminate Selection	②b PVC Edge Color	③ Electrical
Model (LK)	<a href="#">See Laminate Selection</a>	<a href="#">See PVC Edge Color Options</a>	N None L-CT1-CO Link System - Center Top Single Power Cutout E-CT1-CO Econo System - Center Top Single Power Cutout

**Model Number Breakdown**

LK-TT29-2036T					
LK	TT	29	2036	T	
LOK	Rectangular Top Shape	Height	20" x 36"	Laminate	

## Training Table Bases

Select base preference below to go with corresponding Top. **Note:** Base depth and width must match Top depth (D) and width (W).

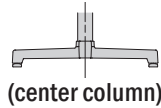

### T-Bases

(center column)

#### Fixed

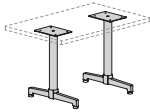

T-Base Fixed

Width	Model	List Price
36"	LK-TBF-TT29-2036	+\$533
	LK-TBF-TT29-2436	+\$562
	LK-TBF-TT29-3036	+\$597
48"	LK-TBF-TT29-2048	+\$533
	LK-TBF-TT29-2448	+\$562
	LK-TBF-TT29-3048	+\$597

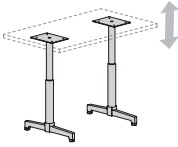

T-Base Adjustable

Width	Model	List Price
36"	LK-TBA-TT29-2036	+\$655
	LK-TBA-TT29-2436	+\$685
	LK-TBA-TT29-3036	+\$718
48"	LK-TBA-TT29-2048	+\$655
	LK-TBA-TT29-2448	+\$685
	LK-TBA-TT29-3048	+\$718

#### Tilt

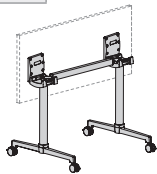

T-Base Tilt

Width	Model	List Price
36"	LK-TBT-TT29-2036	+\$931
	LK-TBT-TT29-2436	+\$960
	LK-TBT-TT29-3036	+\$997
48"	LK-TBT-TT29-2048	+\$1,066
	LK-TBT-TT29-2448	+\$1,093
	LK-TBT-TT29-3048	+\$1,129

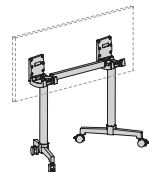

Inline T-Base

Width	Model	List Price
48"	LK-IBT-TT29-2048	+\$976
	LK-IBT-TT29-2448	+\$976

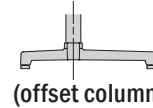

### Cantilever T-Bases

(offset column)

#### Fixed

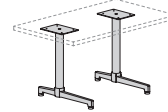

Cantilever T-Base Fixed

Width	Model	List Price
36"	LK-CBF-TT29-2036	+\$549
	LK-CBF-TT29-2436	+\$564
	LK-CBF-TT29-3036	+\$594
48"	LK-CBF-TT29-2048	+\$549
	LK-CBF-TT29-2448	+\$564
	LK-CBF-TT29-3048	+\$594

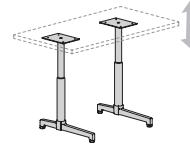

Cantilever T-Base Adj.

Width	Model	List Price
36"	LK-CBA-TT29-2036	+\$670
	LK-CBA-TT29-2436	+\$688
	LK-CBA-TT29-3036	+\$715
48"	LK-CBA-TT29-2048	+\$670
	LK-CBA-TT29-2448	+\$688
	LK-CBA-TT29-3048	+\$715

#### Tilt

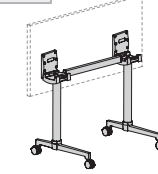

Cantilever T-Base Tilt

Width	Model	List Price
36"	LK-CBT-TT29-2036	+\$963
	LK-CBT-TT29-2436	+\$978
	LK-CBT-TT29-3036	+\$1,008
48"	LK-CBT-TT29-2048	+\$1,096
	LK-CBT-TT29-2448	+\$1,113
	LK-CBT-TT29-3048	+\$1,142

See pages 6-7 for additional information on Lok Bases.

See pages 38-44 on how to order/specify Lok Bases for Rectangular Tops, including caster color options.

## Training Table Modesty Panels

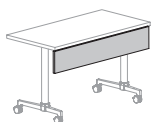

Fixed Modesty

Material	Model	Standard List	Graded In HPL 2
Acrylic	LK-MPF-36A	+\$339	--
	LK-MPF-48A	+\$380	--
TFL	LK-MPF-36T	+\$183	--
	LK-MPF-48T	+\$192	--
HPL	LK-MPF-36H	+\$266	+\$276
	LK-MPF-48H	+\$282	+\$295

**Note:** Fixed modesty panels are intended to always be attached to top and should not be specified in conjunction with Tilt T-Bases.

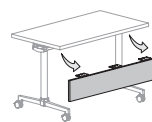

Removable Modesty

Material	Model	Standard List	Graded In HPL 2
Acrylic	LK-MPR-36A	+\$381	--
	LK-MPR-48A	+\$420	--
TFL	LK-MPR-36T	+\$224	--
	LK-MPR-48T	+\$232	--
HPL	LK-MPR-36H	+\$306	+\$317
	LK-MPR-48H	+\$324	+\$336

**Note:** Removable modesty panels when used with Tilt T-bases must be removed before tilting table.

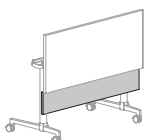

Hinged Modesty

Material	Model	Standard List	Graded In HPL 2
Acrylic	LK-MPH-36A	+\$362	--
	LK-MPH-48A	+\$417	--
TFL	LK-MPH-36T	+\$223	--
	LK-MPH-48T	+\$231	--
HPL	LK-MPH-36H	+\$305	+\$315
	LK-MPH-48H	+\$323	+\$335

**Note:** Hinged modesty panels are intended to be used with Tilt T-Bases for tilting and table nesting. Not to be specified with Fixed T-Bases.

See pages 8-9 for additional information on Lok Modesty Panels.

See pages 64-66 on how to order/specify Lok Modesty Panels.

Description

Rectangular Training Top



top shape

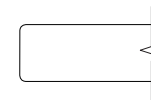

Eased Edge (R3)

D	W	H	CTN WT	CU FT	① Model	TFL	Standard	Graded In
							HPL 1	HPL 2
20	60	29	36	3	LK-TT29-2060T	\$339	\$473	\$500
24	60	29	43	3	LK-TT29-2460T	\$393	\$518	\$552
30	60	29	54	4	LK-TT29-3060T	\$414	\$589	\$626
20	66	29	39	3	LK-TT29-2066T	\$391	\$501	\$529
24	66	29	47	4	LK-TT29-2466T	\$469	\$554	\$591
30	66	29	60	5	LK-TT29-3066T	\$493	\$639	\$682
20	72	29	43	3	LK-TT29-2072T	\$412	\$528	\$561
24	72	29	52	4	LK-TT29-2472T	\$490	\$581	\$622
30	72	29	65	5	LK-TT29-3072T	\$517	\$669	\$715

Table Components: (order separately)

- base, modesty panel, electrical, and privacy screens sold and ship separately
- specify power option, see below
- optional set of (2) linking bracket, specify and add an additional \$66 list

Electrical Options/Cutout Locations:

- specify power cutout and indicate if Link or Econo System will be used
- reference drawing below for approximate location

CT1 : Single Power Center Top Cutout Location

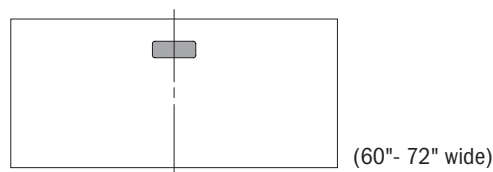

LRT2 : Dual Power Left/Right Top Cutout Location

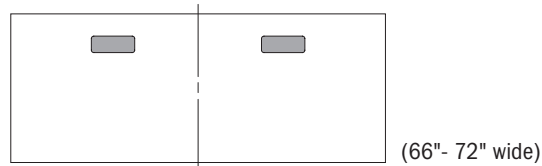

To Order Specify

① Model #	②a Laminate Selection	②b PVC Edge Color	③ Electrical
Model (LK)	<a href="#">See Laminate Selection</a>	<a href="#">See PVC Edge Color Options</a>	N None L-CT1-CO Link System - Center Top Single Power Cutout E-CT1-CO Econo System - Center Top Single Power Cutout L-LRT2-CO Link System - Left/Right Top Dual Power Cutout E-LRT2-CO Econo System - Left/Right Top Dual Power Cutout

Model Number Breakdown

LK-TT29-2060T					
LK	TT	29	2060	T	
LOK	Rectangular Top Shape	Height	20" x 60"	Laminate	

**Training Table Bases**

Select base preference below to go with corresponding Top. **Note:** Base depth and width must match Top depth (D) and width (W).

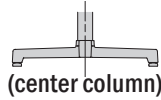

**T-Bases**

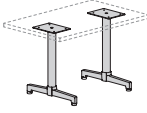
Fixed	Width	Model	List Price
 <b>T-Base Fixed</b>	60"	LK-TBF-TT29-2060	+\$595
		LK-TBF-TT29-2460	+\$623
		LK-TBF-TT29-3060	+\$657
	66"	LK-TBF-TT29-2066	+\$595
		LK-TBF-TT29-2466	+\$623
		LK-TBF-TT29-3066	+\$657
	72"	LK-TBF-TT29-2072	+\$605
		LK-TBF-TT29-2472	+\$634
		LK-TBF-TT29-3072	+\$669

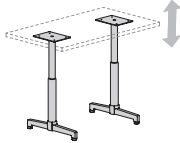

**T-Base Adjustable**

Width	Model	List Price
60"	LK-TBA-TT29-2060	+\$716
	LK-TBA-TT29-2460	+\$745
	LK-TBA-TT29-3060	+\$781
66"	LK-TBA-TT29-2066	+\$716
	LK-TBA-TT29-2466	+\$745
	LK-TBA-TT29-3066	+\$781
72"	LK-TBA-TT29-2072	+\$727
	LK-TBA-TT29-2472	+\$757
	LK-TBA-TT29-3072	+\$792

**Tilt**

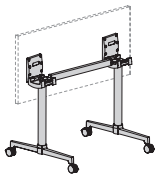

**T-Base Tilt**

Width	Model	List Price
60"	LK-TBT-TT29-2060	+\$1,082
	LK-TBT-TT29-2460	+\$1,111
	LK-TBT-TT29-3060	+\$1,145
66"	LK-TBT-TT29-2066	+\$1,082
	LK-TBT-TT29-2466	+\$1,111
	LK-TBT-TT29-3066	+\$1,145
72"	LK-TBT-TT29-2072	+\$1,113
	LK-TBT-TT29-2472	+\$1,144
	LK-TBT-TT29-3072	+\$1,178

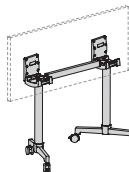

**Inline T-Base**

Width	Model	List Price
60"	LK-IBT-TT29-2060	+\$1,111
	LK-IBT-TT29-2460	+\$1,111
66"	LK-IBT-TT29-2066	+\$1,111
	LK-IBT-TT29-2466	+\$1,111
72"	LK-IBT-TT29-2072	+\$1,127
	LK-IBT-TT29-2472	+\$1,127

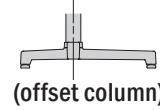

**Cantilever T-Bases**

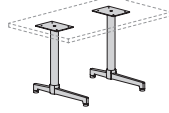
Fixed	Width	Model	List Price
 <b>Cantilever T-Base Fixed</b>	60"	LK-CBF-TT29-2060	+\$608
		LK-CBF-TT29-2460	+\$625
		LK-CBF-TT29-3060	+\$655
	66"	LK-CBF-TT29-2066	+\$608
		LK-CBF-TT29-2466	+\$625
		LK-CBF-TT29-3066	+\$655
	72"	LK-CBF-TT29-2072	+\$620
		LK-CBF-TT29-2472	+\$637
		LK-CBF-TT29-3072	+\$665

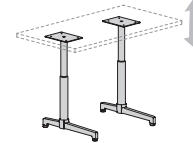

**Cantilever T-Base Adj.**

Width	Model	List Price
60"	LK-CBA-TT29-2060	+\$732
	LK-CBA-TT29-2460	+\$747
	LK-CBA-TT29-3060	+\$778
66"	LK-CBA-TT29-2066	+\$732
	LK-CBA-TT29-2466	+\$747
	LK-CBA-TT29-3066	+\$778
72"	LK-CBA-TT29-2072	+\$742
	LK-CBA-TT29-2472	+\$759
	LK-CBA-TT29-3072	+\$787

**Tilt**

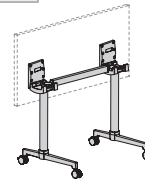

**Cantilever T-Base Tilt**

Width	Model	List Price
60"	LK-CBT-TT29-2060	+\$1,112
	LK-CBT-TT29-2460	+\$1,129
	LK-CBT-TT29-3060	+\$1,158
66"	LK-CBT-TT29-2066	+\$1,112
	LK-CBT-TT29-2466	+\$1,129
	LK-CBT-TT29-3066	+\$1,158
72"	LK-CBT-TT29-2072	+\$1,145
	LK-CBT-TT29-2472	+\$1,160
	LK-CBT-TT29-3072	+\$1,190

See pages 6-7 for additional information on Lok Bases.

See pages 38-44 on how to order/specify Lok Bases for Rectangular Tops, including caster color options.

**Training Table Modesty Panels**

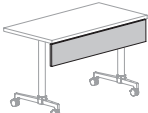
 <b>Fixed Modesty</b>	Material	Model	Standard List	Graded In HPL 2
	Acrylic	LK-MPF-60A	+\$465	--
LK-MPF-66A		+\$497	--	
LK-MPF-72A		+\$524	--	
TFL	LK-MPF-60T	+\$216	--	
	LK-MPF-66T	+\$222	--	
	LK-MPF-72T	+\$225	--	
HPL	LK-MPF-60H	+\$318	+\$333	
	LK-MPF-66H	+\$327	+\$343	
	LK-MPF-72H	+\$337	+\$352	

**Note:** Fixed modesty panels are intended to always be attached to top and should not be specified in conjunction with Tilt T-Bases.

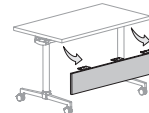
 <b>Removable Modesty</b>	Material	Model	Standard List	Graded In HPL 2
	Acrylic	LK-MPR-60A	+\$526	--
LK-MPR-66A		+\$558	--	
LK-MPR-72A		+\$583	--	
TFL	LK-MPR-60T	+\$278	--	
	LK-MPR-66T	+\$282	--	
	LK-MPR-72T	+\$287	--	
HPL	LK-MPR-60H	+\$380	+\$393	
	LK-MPR-66H	+\$388	+\$405	
	LK-MPR-72H	+\$398	+\$416	

**Note:** Removable modesty panels when used with Tilt T-bases must be removed before tilting table.

See pages 8-9 for additional information on Lok Modesty Panels.

See pages 64-66 on how to order/specify Lok Modesty Panels.

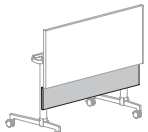
 <b>Hinged Modesty</b>	Material	Model	Standard List	Graded In HPL 2
	Acrylic	LK-MPH-60A	+\$521	--
LK-MPH-66A		+\$556	--	
LK-MPH-72A		+\$578	--	
TFL	LK-MPH-60T	+\$268	--	
	LK-MPH-66T	+\$273	--	
	LK-MPH-72T	+\$278	--	
HPL	LK-MPH-60H	+\$371	+\$385	
	LK-MPH-66H	+\$381	+\$395	
	LK-MPH-72H	+\$389	+\$407	

**Note:** Hinged modesty panels are intended to be used with Tilt T-Bases for tilting and table nesting. Not to be specified with Fixed T-Bases.

Description

Rectangular Training Top

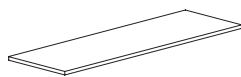

top shape

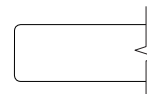

Eased Edge (R3)

D	W	H	CTN WT	CU FT	① Model	TFL	Standard	Graded In
							HPL 1	HPL 2
20	84	29	51	4	LK-TT29-2084T	\$438	\$589	\$625
24	84	29	61	4	LK-TT29-2484T	\$517	\$648	\$693
30	84	29	76	5	LK-TT29-3084T	\$539	\$740	\$795
20	96	29	58	4	LK-TT29-2096T	\$456	\$639	\$680
24	96	29	69	5	LK-TT29-2496T	\$536	\$709	\$758
30	96	29	86	6	LK-TT29-3096T	\$562	\$812	\$875

LAMINATE  
LOK - TRAINING

**Table Components: (order separately)**

- base, modesty panel, electrical, and privacy screens sold and ship separately
- specify power option, see below
- optional set of (2) linking bracket, specify and add an additional \$66 list

**Electrical Options/Cutout Locations:**

- specify power cutout and indicate if Link or Econo System will be used
- reference drawing below for approximate location

**CT1 : Single Power Center Top Cutout Location**

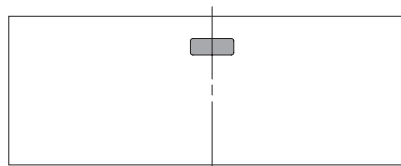

(84"- 96" wide)

**LRT2 : Dual Power Left/Right Top Cutout Location**

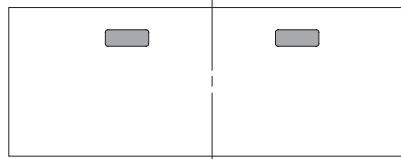

(84"- 96" wide)

**To Order Specify**

① Model #	②a Laminate Selection	②b PVC Edge Color	③ Electrical
Model (LK)	<a href="#">See Laminate Selection</a>	<a href="#">See PVC Edge Color Options</a>	N None L-CT1-CO Link System - Center Top Single Power Cutout E-CT1-CO Econo System - Center Top Single Power Cutout L-LRT2-CO Link System - Left/Right Top Dual Power Cutout E-LRT2-CO Econo System - Left/Right Top Dual Power Cutout

**Model Number Breakdown**

LK-TT29-2084T				
LK	TT	29	2084	T
LOK	Rectangular Top Shape	Height	20" x 84"	Laminate

## Training Table Bases

Select base preference below to go with corresponding Top. Note: Base depth and width must match Top depth (D) and width (W).

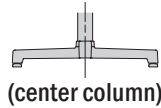

### T-Bases

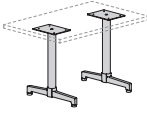
Fixed	Width	Model	List Price
 T-Base Fixed	84"	LK-TBF-TT29-2084	+\$605
		LK-TBF-TT29-2484	+\$634
		LK-TBF-TT29-3084	+\$669
	96"	LK-TBF-TT29-2096	+\$625
		LK-TBF-TT29-2496	+\$655
		LK-TBF-TT29-3096	+\$690

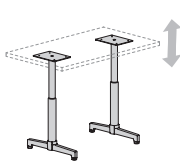

### T-Base Adjustable

Width	Model	List Price
84"	LK-TBA-TT29-2084	+\$727
	LK-TBA-TT29-2484	+\$757
	LK-TBA-TT29-3084	+\$792
96"	LK-TBA-TT29-2096	+\$747
	LK-TBA-TT29-2496	+\$778
	LK-TBA-TT29-3096	+\$812

### Tilt

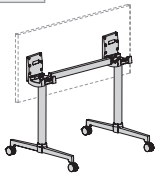

### T-Base Tilt

Width	Model	List Price
84"	LK-TBT-TT29-2084	+\$1,113
	LK-TBT-TT29-2484	+\$1,144
	LK-TBT-TT29-3084	+\$1,178
96"	LK-TBT-TT29-2096	+\$1,175
	LK-TBT-TT29-2496	+\$1,203
	LK-TBT-TT29-3096	+\$1,235

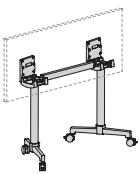

### Inline T-Base

Width	Model	List Price
84"	LK-IBT-TT29-2084	+\$1,159
	LK-IBT-TT29-2484	+\$1,159
96"	LK-IBT-TT29-2096	+\$1,220
	LK-IBT-TT29-2496	+\$1,220

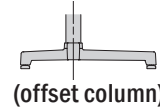

### Cantilever T-Bases

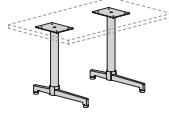
Fixed	Width	Model	List Price
 Cantilever T-Base Fixed	84"	LK-CBF-TT29-2084	+\$620
		LK-CBF-TT29-2484	+\$637
		LK-CBF-TT29-3084	+\$665
	96"	LK-CBF-TT29-2096	+\$642
		LK-CBF-TT29-2496	+\$657
		LK-CBF-TT29-3096	+\$686

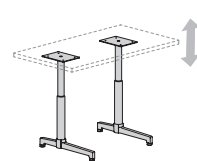

### Cantilever T-Base Adj.

Width	Model	List Price
84"	LK-CBA-TT29-2084	+\$742
	LK-CBA-TT29-2484	+\$759
	LK-CBA-TT29-3084	+\$787
96"	LK-CBA-TT29-2096	+\$763
	LK-CBA-TT29-2496	+\$781
	LK-CBA-TT29-3096	+\$808

### Tilt

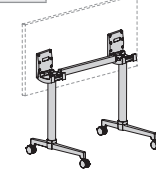

### Cantilever T-Base Tilt

Width	Model	List Price
84"	LK-CBT-TT29-2084	+\$1,145
	LK-CBT-TT29-2484	+\$1,160
	LK-CBT-TT29-3084	+\$1,190
96"	LK-CBT-TT29-2096	+\$1,206
	LK-CBT-TT29-2496	+\$1,222
	LK-CBT-TT29-3096	+\$1,250

See pages 6-7 for additional information on Lok Bases.

See pages 38-44 on how to order/specify Lok Bases for Rectangular Tops, including caster color options.

## Training Table Modesty Panels

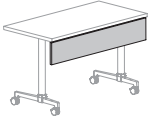
 Fixed Modesty	Material	Model	Standard List	Graded In HPL 2
	Acrylic	LK-MPF-84A	+\$577	--
		LK-MPF-96A	+\$631	--
	TFL	LK-MPF-84T	+\$234	--
		LK-MPF-96T	+\$242	--
	HPL	LK-MPF-84H	+\$357	+\$375
LK-MPF-96H		+\$374	+\$397	

Note: Fixed modesty panels are intended to always be attached to top and should not be specified in conjunction with Tilt T-Bases.

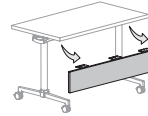
 Removable Modesty	Material	Model	Standard List	Graded In HPL 2
	Acrylic	LK-MPR-84A	+\$640	--
		LK-MPR-96A	+\$692	--
	TFL	LK-MPR-84T	+\$296	--
		LK-MPR-96T	+\$303	--
	HPL	LK-MPR-84H	+\$418	+\$437
LK-MPR-96H		+\$435	+\$459	

Note: Removable modesty panels when used with Tilt T-bases must be removed before tilting table.

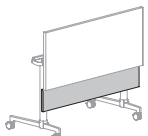
 Hinged Modesty	Material	Model	Standard List	Graded In HPL 2
	Acrylic	LK-MPH-84A	+\$633	--
		LK-MPH-96A	+\$686	--
	TFL	LK-MPH-84T	+\$287	--
		LK-MPH-96T	+\$296	--
	HPL	LK-MPH-84H	+\$409	+\$429
LK-MPH-96H		+\$429	+\$452	

Note: Hinged modesty panels are intended to be used with Tilt T-Bases for tilting and table nesting. Not to be specified with Fixed T-Bases.

See pages 8-9 for additional information on Lok Modesty Panels.

See pages 64-66 on how to order/specify Lok Modesty Panels.

Description

Trapezoid Training Top

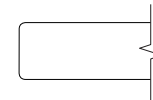
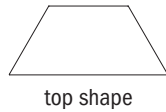
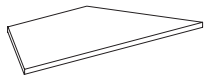

Eased Edge (R3)

D	W	H	CTN WT	CU FT	① Model	TFL	Standard	Graded In
							HPL 1	HPL 2
24	48	29	35	3	LK-TZ29-2448T	\$399	\$518	\$529
30	48	29	43	3	LK-TZ29-3048T	\$420	\$579	\$596

Table Components: (order separately)

- base, modesty panel, electrical, and privacy screens sold and ship separately
- specify power option, see below
- optional set of (2) linking bracket, specify and add an additional \$66 list

Electrical Options/Cutout Locations:

- specify power cutout and indicate if Link or Econo System will be used
- reference drawing below for approximate location

CT1 : Single Power Center Top Cutout Location

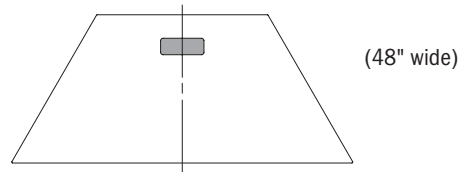

To Order Specify

① Model #	②a Laminate Selection	②b PVC Edge Color	③ Electrical
Model (LK)	<a href="#">See Laminate Selection</a>	<a href="#">See PVC Edge Color Options</a>	N None L-CT1-CO Link System - Center Top Single Power Cutout E-CT1-CO Econo System - Center Top Single Power Cutout

Model Number Breakdown

LK-TZ29-2448T					
LK	TZ	29	2448	T	
LOK	Trapezoid Top Shape	Height	24" x 48"	Laminate	

## Training Table Bases

Select base preference below to go with corresponding Top. Note: Base depth and width must match Top depth (D) and width (W).

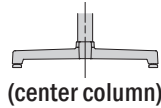

**T-Bases**  
(center column)

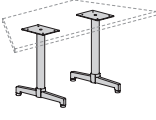
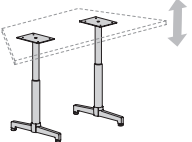
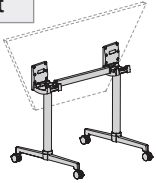
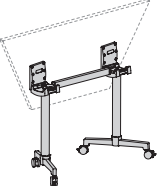
Fixed			
	Width	Model	List Price
 <b>T-Base Fixed</b>	48"	LK-TBF-TZ29-2448	+\$562
		LK-TBF-TZ29-3048	+\$597
Tilt			
	Width	Model	List Price
 <b>T-Base Adjustable</b>	48"	LK-TBA-TZ29-2448	+\$685
		LK-TBA-TZ29-3048	+\$718
Tilt			
	Width	Model	List Price
 <b>T-Base Tilt</b>	48"	LK-TBT-TZ29-2448	+\$1,093
		LK-TBT-TZ29-3048	+\$1,129
Tilt			
	Width	Model	List Price
 <b>Inline T-Base</b>	48"	LK-IBT-TZ29-2448	+\$976
		LK-IBT-TZ29-3048	+\$1,012

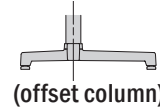

**Cantilever T-Bases**  
(offset column)

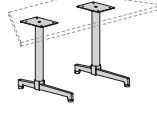
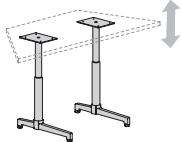
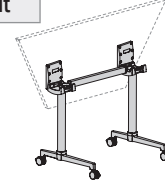
Fixed			
	Width	Model	List Price
 <b>Cantilever T-Base Fixed</b>	48"	LK-CBF-TZ29-2448	+\$564
		LK-CBF-TZ29-3048	+\$594
Tilt			
	Width	Model	List Price
 <b>Cantilever T-Base Adj.</b>	48"	LK-CBA-TZ29-2448	+\$688
		LK-CBA-TZ29-3048	+\$715
Tilt			
	Width	Model	List Price
 <b>Cantilever T-Base Tilt</b>	48"	LK-CBT-TZ29-2448	+\$1,113
		LK-CBT-TZ29-3048	+\$1,142

See pages 6-7 for additional information on Lok Bases.

See pages 46-49 on how to order/specify Lok Bases for Trapezoid Tops, including caster color options.

## Training Table Modesty Panels

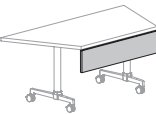
	Material	Model	Standard List	Graded In HPL 2
 <b>Fixed Modesty</b>	Acrylic	LK-MPF-26A	+\$336	--
		LK-MPF-30A	+\$337	--
	TFL	LK-MPF-26T	+\$177	--
		LK-MPF-30T	+\$180	--
	HPL	LK-MPF-26H	+\$263	+\$270
		LK-MPF-30H	+\$264	+\$272

Note: Fixed modesty panels are intended to always be attached to top and should not be specified in conjunction with Tilt T-Bases.

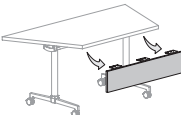
	Material	Model	Standard List	Graded In HPL 2
 <b>Removable Modesty</b>	Acrylic	LK-MPR-26A	+\$376	--
		LK-MPR-30A	+\$379	--
	TFL	LK-MPR-26T	+\$220	--
		LK-MPR-30T	+\$222	--
	HPL	LK-MPR-26H	+\$303	+\$312
		LK-MPR-30H	+\$304	+\$313

Note: Removable modesty panels when used with Tilt T-bases must be removed before tilting table.

	Material	Model	Standard List	Graded In HPL 2
 <b>Hinged Modesty</b>	Acrylic	LK-MPH-26A	+\$358	--
		LK-MPH-30A	+\$359	--
	TFL	LK-MPH-26T	+\$220	--
		LK-MPH-30T	+\$222	--
	HPL	LK-MPH-26H	+\$302	+\$311
		LK-MPH-30H	+\$303	+\$312

Note: Hinged modesty panels are intended to be used with Tilt T-Bases for tilting and table nesting. Not to be specified with Fixed T-Bases.

See pages 8-9 for additional information on Lok Modesty Panels.

See pages 64-66 on how to order/specify Lok Modesty Panels.

LOK - TRAINING

Description

Lecture Training Top

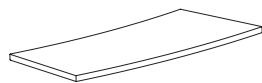

top shape

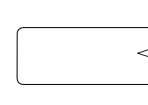

Eased Edge (R3)

D	W	H	CTN WT	CU FT	① Model	TFL	Standard	Graded In
							HPL 1	HPL 2
24	48	29	35	3	LK-LC29-2448T	\$407	\$538	\$553
30	48	29	43	3	LK-LC29-3048T	\$524	\$601	\$617
24	60	29	43	3	LK-LC29-2460T	\$455	\$607	\$624
30	60	29	54	4	LK-LC29-3060T	\$598	\$685	\$704

LAMINATE

Table Components: (order separately)

- base, modesty panel, electrical, and privacy screens sold and ship separately
- specify power option, see below
- optional set of (2) linking bracket, specify and add an additional \$66 list

Electrical Options/Cutout Locations:

- specify power cutout and indicate if Link or Econo System will be used
- reference drawing below for approximate location

CT1 : Single Power Center Top Cutout Location

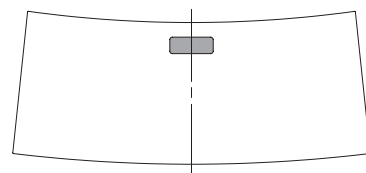

(48", 60" wide)

To Order Specify

① Model #	②a Laminate Selection	②b PVC Edge Color	③ Electrical
Model (LK)	<a href="#">See Laminate Selection</a>	<a href="#">See PVC Edge Color Options</a>	N None L-CT1-CO Link System - Center Top Single Power Cutout E-CT1-CO Econo System - Center Top Single Power Cutout

Model Number Breakdown

LK-LC29-2448T					
LK	LC	29	2448	T	
LOK	Lecture Top Shape	Height	24" x 48"	Laminate	

## Training Table Bases

Select base preference below to go with corresponding Top. Note: Base depth and width must match Top depth (D) and width (W).

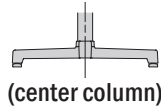

### T-Bases

(center column)

Fixed		Width	Model	List Price
 T-Base Fixed	48"	60"	LK-TBF-LC29-2448	+\$578
			LK-TBF-LC29-3048	+\$614
	60"	60"	LK-TBF-LC29-2460	+\$623
			LK-TBF-LC29-3060	+\$657

Adjustable		Width	Model	List Price
 T-Base Adjustable	48"	60"	LK-TBA-LC29-2448	+\$701
			LK-TBA-LC29-3048	+\$737
	60"	60"	LK-TBA-LC29-2460	+\$745
			LK-TBA-LC29-3060	+\$781

Tilt		Width	Model	List Price
 T-Base Tilt	48"	60"	LK-TBT-LC29-2448	+\$1,111
			LK-TBT-LC29-3048	+\$1,146
	60"	60"	LK-TBT-LC29-2460	+\$1,127
			LK-TBT-LC29-3060	+\$1,160

Inline		Width	Model	List Price
 Inline T-Base	48"	60"	LK-IBT-LC29-2448	+\$976
			LK-IBT-LC29-3048	+\$1,012
	60"	60"	LK-IBT-LC29-2460	+\$1,111
			LK-IBT-LC29-3060	+\$1,146

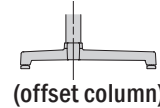

### Cantilever T-Bases

Fixed		Width	Model	List Price
 Cantilever T-Base Fixed	48"	60"	LK-CBF-LC29-2448	+\$564
			LK-CBF-LC29-3048	+\$609
	60"	60"	LK-CBF-LC29-2460	+\$608
			LK-CBF-LC29-3060	+\$655

Adjustable		Width	Model	List Price
 Cantilever T-Base Adj.	48"	60"	LK-CBA-LC29-2448	+\$688
			LK-CBA-LC29-3048	+\$733
	60"	60"	LK-CBA-LC29-2460	+\$732
			LK-CBA-LC29-3060	+\$778

Tilt		Width	Model	List Price
 Cantilever T-Base Tilt	48"	60"	LK-CBT-LC29-2448	+\$1,129
			LK-CBT-LC29-3048	+\$1,142
	60"	60"	LK-CBT-LC29-2460	+\$1,113
			LK-CBT-LC29-3060	+\$1,158

See pages 6-7 for additional information on Lok Bases.

See pages 50-53 on how to order/specify Lok Bases for Lecture Tops, including caster color options.

## Training Table Modesty Panels

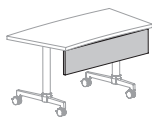

Fixed Modesty

Material	Model	List Price
Acrylic	LK-MPF-48A	+\$380
	LK-MPF-60A	+\$465

Note: Fixed modesty panels are intended to always be attached to top and should not be specified in conjunction with Tilt T-Bases.

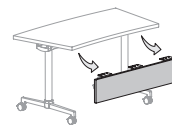

Removable Modesty

Material	Model	List Price
Acrylic	LK-MPR-48A	+\$420
	LK-MPR-60A	+\$526

Note: Removable modesty panels when used with Tilt T-bases must be removed before tilting table.

See pages 8-9 for additional information on Lok Modesty Panels.

See pages 64-66 on how to order/specify Lok Modesty Panels.

Description

Crescent Training Top

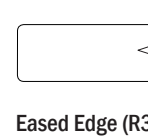
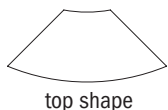
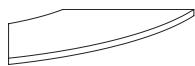

Eased Edge (R3)

LAM

LOK - TRAINING

D	W	H	CTN WT	CU FT	① Model	TFL	Standard	Graded In
							HPL 1	HPL 2
24	48	29	35	3	LK-CR29-2448T	\$415	\$560	\$574
30	48	29	43	3	LK-CR29-3048T	\$529	\$622	\$639

**Table Components: (order separately)**

- base, electrical, and privacy screens sold and ship separately
- top does not accommodate modesty panel
- specify power option, see below
- optional set of (2) linking bracket, specify and add an additional \$66 list

**Electrical Options/Cutout Locations:**

- specify power cutout and indicate if Link or Econo System will be used
- reference drawing below for approximate location

**CT1 : Single Power Center Top Cutout Location**

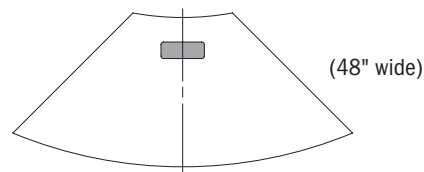

**To Order Specify**

① Model #	②a Laminate Selection	②b PVC Edge Color	③ Electrical
Model (LK)	<a href="#">See Laminate Selection</a>	<a href="#">See PVC Edge Color Options</a>	N None L-CT1-CO Link System - Center Top Single Power Cutout E-CT1-CO Econo System - Center Top Single Power Cutout

**Model Number Breakdown**

LK-CR29-2448T					
LK	CR	29	2448	T	
LOK	Crescent Top Shape	Height	24" x 48"	Laminate	

## Training Table Bases

Select base preference below to go with corresponding Top. Note: Base depth and width must match Top depth (D) and width (W).



### T-Bases

(center column)

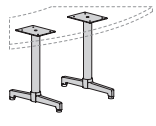
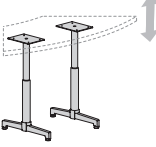
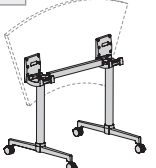
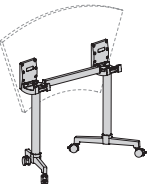
Fixed			
	Width	Model	List Price
 <b>T-Base Fixed</b>	48"	LK-TBF-CR29-2448	+\$562
		LK-TBF-CR29-3048	+\$597
Adjustable			
	Width	Model	List Price
 <b>T-Base Adjustable</b>	48"	LK-TBA-CR29-2448	+\$685
		LK-TBA-CR29-3048	+\$718
Tilt			
	Width	Model	List Price
 <b>T-Base Tilt</b>	48"	LK-TBT-CR29-2448	+\$1,093
		LK-TBT-CR29-3048	+\$1,129
Inline			
	Width	Model	List Price
 <b>Inline T-Base</b>	48"	LK-IBT-CR29-2448	+\$976
		LK-IBT-CR29-3048	+\$1,012

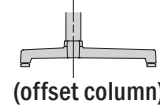

### Cantilever T-Bases

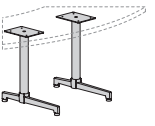
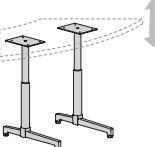
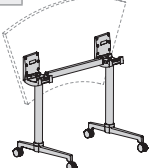
Fixed			
	Width	Model	List Price
 <b>Cantilever T-Base Fixed</b>	48"	LK-CBF-CR29-2448	+\$564
		LK-CBF-CR29-3048	+\$594
Adjustable			
	Width	Model	List Price
 <b>Cantilever T-Base Adj.</b>	48"	LK-CBA-CR29-2448	+\$688
		LK-CBA-CR29-3048	+\$715
Tilt			
	Width	Model	List Price
 <b>Cantilever T-Base Tilt</b>	48"	LK-CBT-CR29-2448	+\$1,113
		LK-CBT-CR29-3048	+\$1,142

See pages 6-7 for additional information on Lok Bases.

See pages 54-57 on how to order/specify Lok Bases for Crescent Tops, including caster color options.

**Note:** Standard Training Table Modesty Panels are not available for Crescent Top shaped tables

Description

Half Round Training Top



top shape

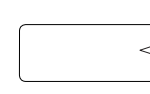

Eased Edge (R3)

D	W	H	CTN WT	CU FT	① Model	TFL	Standard	Graded In
							HPL 1	HPL 2
24	48	29	35	3	LK-HR29-2448T	\$409	\$518	\$518
30	60	29	54	4	LK-HR29-3060T	\$525	\$579	\$579

Table Components: (order separately)

- base, modesty panel, electrical, and privacy screens sold and ship separately
- specify power option or power jumper, see below
- optional set of (2) linking bracket, specify and add an additional \$66 list

Electrical Options/Cutout Locations:

- specify power cutout and indicate if Link or Econo System will be used
- reference drawing below for approximate location

CT1 : Single Power Center Top Cutout Location

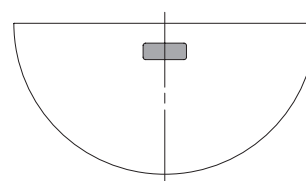

(48"- 60" wide)

To Order Specify

① Model #	②a Laminate Selection	②b PVC Edge Color	③ Electrical
Model (LK)	<a href="#">See Laminate Selection</a>	<a href="#">See PVC Edge Color Options</a>	N None L-CT1-CO Link System - Center Top Single Power Cutout E-CT1-CO Econo System - Center Top Single Power Cutout

Model Number Breakdown

LK-HR29-2448T					
LK	HR	29	2448	T	
LOK	Half Round Top Shape	Height	24" x 48"	Laminate	

## Training Table Bases

Select base preference below to go with corresponding Top. Note: Base depth and width must match Top depth (D) and width (W).

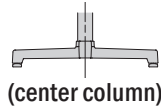

**T-Bases**  
(center column)

Fixed		Width	Model	List Price
	T-Base Fixed	48"	LK-TBF-HR29-2448	+\$562
		60"	LK-TBF-HR29-3060	+\$657
Adjustable		Width	Model	List Price
	T-Base Adjustable	48"	LK-TBA-HR29-2448	+\$685
		60"	LK-TBA-HR29-3060	+\$781
Tilt		Width	Model	List Price
	T-Base Tilt	48"	LK-TBT-HR29-2448	+\$976
		60"	LK-TBT-HR29-3060	+\$1,146
	Inline T-Base	48"	LK-IBT-HR29-2448	+\$976
		60"	LK-IBT-HR29-3060	+\$1,146

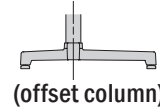

**Cantilever T-Bases**  
(offset column)

Fixed		Width	Model	List Price
	Cantilever T-Base Fixed	48"	LK-CBF-HR29-2448	+\$549
		60"	LK-CBF-HR29-3060	+\$655
Adjustable		Width	Model	List Price
	Cantilever T-Base Adj.	48"	LK-CBA-HR29-2448	+\$670
		60"	LK-CBA-HR29-3060	+\$778
Tilt		Width	Model	List Price
	Cantilever T-Base Tilt	48"	LK-CBT-HR29-2448	+\$978
		60"	LK-CBT-HR29-3060	+\$1,142

See pages 6-7 for additional information on Lok Bases.

See pages 58-61 on how to order/specify Lok Bases for Half Round Tops, including caster color options.

## Training Table Modesty Panels

	Material	Model	Standard List	Graded In HPL 2
	Acrylic	LK-MPF-48A	+\$380	--
		LK-MPF-60A	+\$465	--
	TFL	LK-MPF-48T	+\$192	--
		LK-MPF-60T	+\$216	--
	HPL	LK-MPF-48H	+\$282	+\$295
		LK-MPF-60H	+\$318	+\$333

Note: Fixed modesty panels are intended to always be attached to top and should not be specified in conjunction with Tilt T-Bases.

	Material	Model	Standard List	Graded In HPL 2
	Acrylic	LK-MPR-48A	+\$420	--
		LK-MPR-60A	+\$526	--
	TFL	LK-MPR-48T	+\$232	--
		LK-MPR-60T	+\$278	--
	HPL	LK-MPR-48H	+\$324	+\$336
		LK-MPR-60H	+\$380	+\$393

Note: Removable modesty panels when used with Tilt T-bases must be removed before tilting table.

	Material	Model	Standard List	Graded In HPL 2
	Acrylic	LK-MPH-48A	+\$417	--
		LK-MPH-60A	+\$521	--
	TFL	LK-MPH-48T	+\$231	--
		LK-MPH-60T	+\$268	--
	HPL	LK-MPH-48H	+\$323	+\$335
		LK-MPH-60H	+\$371	+\$385

Note: Hinged modesty panels are intended to be used with Tilt T-Bases for tilting and table nesting. Not to be specified with Fixed T-Bases.

See pages 8-9 for additional information on Lok Modesty Panels.

See pages 64-66 on how to order/specify Lok Modesty Panels.

Description

Bullet Training Top

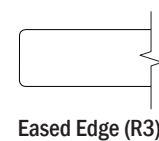
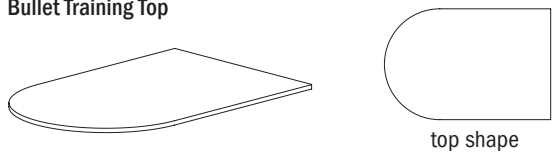

D	W	H	CTN WT	CU FT	① Model	TFL	Standard	Graded In
							HPL 1	HPL 2
30	60	29	54	4	LK-BU29-3060T	\$455	\$607	\$624
36	60	29	61	5	LK-BU29-3660T	\$608	\$711	\$768
30	66	29	58	4	LK-BU29-3066T	\$497	\$649	\$677
36	66	29	67	5	LK-BU29-3666T	\$634	\$740	\$798
30	72	29	61	5	LK-BU29-3072T	\$533	\$682	\$731
36	72	29	73	6	LK-BU29-3672T	\$698	\$821	\$862
48	72	29	96	7	LK-BU29-4872T	\$794	\$927	\$1,002

LOK - TRAINING LAMINATE

Table Components: (order separately)

- base, electrical, and privacy screens sold and ship separately
- optional set of (2) linking bracket, specify and add an additional \$66 list
- specify power option, see below for options

Electrical Options/Cutout Locations:

- specify power cutout
- reference drawing below for approximate location

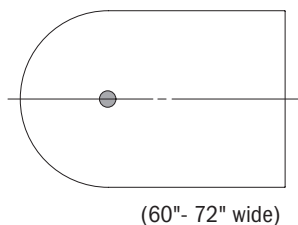

Select base preference below to go with corresponding Top.

**Note:** Base depth and width must match Top depth (D) and width (W).

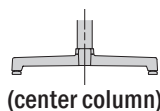

(center column)

Fixed

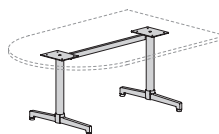

T-Base Fixed

T-Bases

Width	Model	List Price
60"	LK-TBF-BU29-3060	+\$657
	LK-TBF-BU29-3660	+\$697
66"	LK-TBF-BU29-3066	+\$657
	LK-TBF-BU29-3666	+\$697
72"	LK-TBF-BU29-3072	+\$669
	LK-TBF-BU29-3672	+\$709
	LK-TBF-BU29-4872	+\$709

See intro page 6 for additional information on Lok Bases, including base color options.

See pricing page 62 on how to order/specify Lok Bases for Bullet Tops, including caster color options.

To Order Specify

① Model #	②a Laminate Selection	②b PVC Edge Color	③ Electrical
Model (LK)	<a href="#">See Laminate Selection</a>	<a href="#">See PVC Edge Color Options</a>	N None CTEC23-CO Electrical Cutout for EC23 CTEC24-CO Electrical Cutout for EC24

Model Number Breakdown

LK-BU29-3060T					
LK	BU	29	3060	T	
LOK	Bullet Top Shape	Height	30" x 60"	Laminate	

Description

Hive Training Top

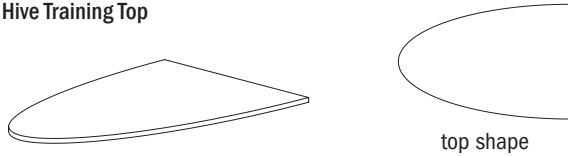

top shape

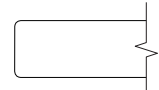

Eased Edge (R3)

LAMINATE	W	D	H	CTN WT	CU FT	① Model	TFL	Standard HPL 1	Graded In HPL 2
		30	60	29	54	4	LK-HV29-3060T	\$457	\$609
	36	60	29	61	5	LK-HV29-3660T	\$610	\$713	\$770
	30	66	29	58	4	LK-HV29-3066T	\$499	\$651	\$679
	36	66	29	67	5	LK-HV29-3666T	\$637	\$742	\$801
	30	72	29	61	5	LK-HV29-3072T	\$535	\$685	\$733
	36	72	29	73	6	LK-HV29-3672T	\$700	\$824	\$864
	48	72	29	96	7	LK-HV29-4872T	\$797	\$931	\$1,005

Table Components: (order separately)

- base, electrical, and privacy screens sold and ship separately
- optional set of (2) ganging bracket, specify and add an additional \$66 list
- specify power option, see below for options

Electrical Options/Cutout Locations:

- specify power cutout
- reference drawing below for approximate location

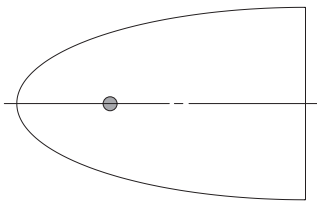

(60"- 72" wide)

Select base preference below to go with corresponding Top.

Note: Base depth and width must match Top depth (D) and width (W).

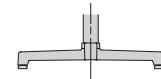

(center column)

Fixed

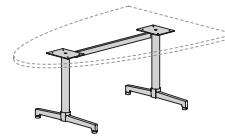

T-Base Fixed

T-Bases

Width	Model	List Price
60"	LK-TBF-HV29-3060	+\$657
	LK-TBF-HV29-3660	+\$697
66"	LK-TBF-HV29-3066	+\$657
	LK-TBF-HV29-3666	+\$697
72"	LK-TBF-HV29-3072	+\$669
	LK-TBF-HV29-3672	+\$697
	LK-TBF-HV29-4872	+\$697

See page 6 for additional information on Lok Bases.

See page 62 on how to order/specify Lok Bases for Hive Tops, including caster color options.

To Order Specify

① Model #	②a Laminate Selection	②b PVC Edge Color	③ Electrical
Model (LK)	<a href="#">See Laminate Selection</a>	<a href="#">See PVC Edge Color Options</a>	N None CTEC23-CO Electrical Cutout for EC23 CTEC24-CO Electrical Cutout for EC24

Model Number Breakdown

LK-HV29-3060T					
LK	HV	29	3060	T	
LOK	Hive Top Shape	Height	30" x 60"	Laminate	

Description

Intersect Training Top

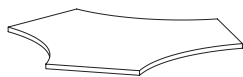

top shape

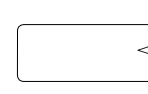

Eased Edge (R3)

LAM

LOK - TRAINING

D	W	H	CTN WT	CU FT	1 Model	TFL	Standard HPL 1	Graded In HPL 2
24	60	29	88	7	LK-IN29-2460T	\$664	\$960	\$1,040
30	60	29	96	7	LK-IN29-3060T	\$668	\$965	\$1,043

Table Components: (order separately)

- base, electrical, and privacy screens sold and ship separately
- specify power option, see below
- optional set of (2) linking bracket, specify and add an additional \$66 list

Electrical Options/Cutout Locations:

- specify power cutout
- reference drawing below for approximate location

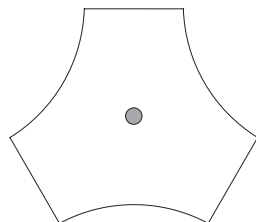

(60" wide)

Select base preference below to go with corresponding Top.

**Note:** Base depth and width must match Top depth (D) and width (W).

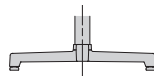

(center column)

Fixed

T-Bases

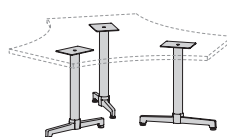

T-Base Fixed

Width	Model	List Price
60"	LK-TBF-IN29-2460	+\$837
	LK-TBF-IN29-3060	+\$837

See intro page 6 for additional information on Lok Bases, including base color options.

See pricing page 63 on how to order/specify Lok Bases for Intersect Tops, including caster color options.

To Order Specify

1 Model #	2a Laminate Selection	2b PVC Edge Color	3 Electrical
Model (LK)	<a href="#">See Laminate Selection</a>	<a href="#">See PVC Edge Color Options</a>	N None CTEC23-CO Electrical Cutout for EC23 CTEC24-CO Electrical Cutout for EC24

Model Number Breakdown

LK-IN29-2460T				
LK	IN	29	2460	T
LOK	Intersect Top Shape	Height	24" x 60"	Laminate

Description

Huddle Training Top

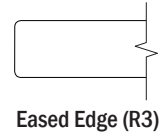
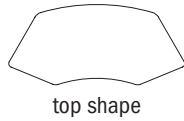

W	D	H	CTN WT	CU FT	① Model	TFL	Standard	Graded In
							HPL 1	HPL 2
30	72	29	65	5	LK-HU29-3072T	\$533	\$682	\$731
36	84	29	91	6	LK-HU29-3684T	\$774	\$848	\$914

Table Components: (order separately)

- base and electrical sold and ship separately
- specify power option, see below
- optional set of (2) linking bracket, specify and add an additional \$66 list

Electrical Options/Cutout Locations:

- specify power cutout and indicate if Link or Econo System will be used
- reference drawing below for approximate location

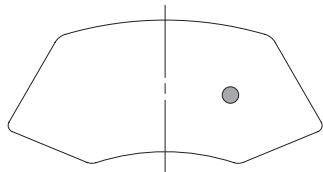

(72"- 84" wide)

Select base preference below to go with corresponding Top.

**Note:** Base depth and width must match Top depth (D) and width (W).

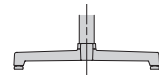

(center column)

Fixed

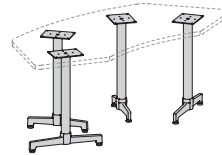

T-Base Fixed

T-Bases

Width	Model	List Price
72"	LK-TBF-HU29-3072	+\$1,091
84"	LK-TBF-HU29-3684	+\$1,091

See page 6 for additional information on Lok Bases.

See page 63 on how to order/specify Lok Bases for Huddle Tops, including caster color options.

To Order Specify

① Model #	②a Laminate Selection	②b PVC Edge Color	③ Electrical
Model (LK)	<a href="#">See Laminate Selection</a>	<a href="#">See PVC Edge Color Options</a>	N None CTEC23-CO Electrical Cutout for EC23 CTEC24-CO Electrical Cutout for EC24

Model Number Breakdown

LK-HU29-3072T					
LK	HU	29	3072	T	
LOK	Huddle Top Shape	Height	30" x 72"	Laminate	

Description

One-twenty Training Top

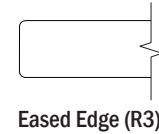
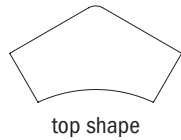
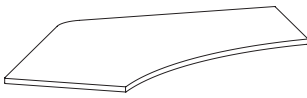

D	W	H	CTN WT	CU FT	① Model	TFL	Standard	Graded In
							HPL 1	HPL 2
42	72	29	81	6	LK-YG29-4272T	\$771	\$851	\$918
45	84	29	95	8	LK-YG29-4584T	\$801	\$980	\$1,064

**Table Components: (order separately)**

- base, modesty panel, electrical, and privacy screens sold and ship separately
- specify power option, see below

**Options:**

- optional set of (2) linking bracket, specify and add an additional \$66 list

**Electrical Options/Cutout Locations:**

- specify power cutout and indicate if Link or Econo System will be used
- reference drawing below for approximate location

**CT1 : Single Power Center Top**

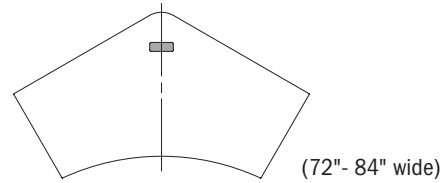

**LRT2 : Dual Power Left/Right Top**

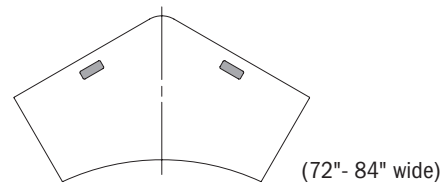

**To Order Specify**

① Model #	②a Laminate Selection	②b PVC Edge Color	③ Electrical
Model (LK)	<a href="#">See Laminate Selection</a>	<a href="#">See PVC Edge Color Options</a>	N None L-CT1-CO Link System - Center Top Single Power Cutout E-CT1-CO Econo System - Center Top Single Power Cutout L-LRT2-CO Link System - Left/Right Top Dual Power Cutout E-LRT2-CO Econo System - Left/Right Top Dual Power Cutout

**Model Number Breakdown**

LK-YG29-4272T					
LK	YG	29	4272	T	
LOK	One-twenty Top Shape	Height	42" x 72"	Laminate	

## Training Table Bases

Select base preference below to go with corresponding Top. Note: Base depth and width must match Top depth (D) and width (W).



**T-Bases**

(center column)

**Fixed**

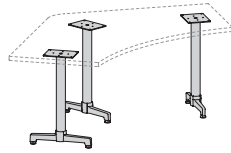

**T-Base Fixed**

Width	Model	List Price
72"	LK-TBF-YG29-4272	+\$794
84"	LK-TBF-YG29-4584	+\$794

## Training Table Modesty Panels

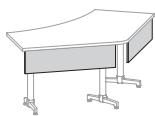

**Fixed Modesty**

Material	Model	Standard List	Graded In HPL 2
Acrylic	LK-MPF-36A	+\$339	--
	LK-MPF-42A	+\$376	--
TFL	LK-MPF-36T	+\$183	--
	LK-MPF-42T	+\$189	--
HPL	LK-MPF-36H	+\$266	+\$276
	LK-MPF-42H	+\$280	+\$292

Note: Fixed modesty panels are intended to always be attached to top and should not be specified in conjunction with Tilt T-Bases.



**Removable Modesty**

Material	Model	Standard List	Graded In HPL 2
Acrylic	LK-MPR-36A	+\$381	--
	LK-MPR-42A	+\$417	--
TFL	LK-MPR-36T	+\$224	--
	LK-MPR-42T	+\$230	--
HPL	LK-MPR-36H	+\$306	+\$317
	LK-MPR-42H	+\$322	+\$334

Note: Removable modesty panels when used with Tilt T-bases must be removed before tilting table.

See pages 8-9 for additional information on Lok Modesty Panels.

See pages 64-66 on how to order/specify Lok Modesty Panels.

Description

Quarter Round Training Top

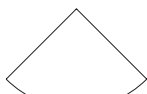

top shape

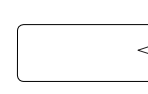

Eased Edge (R3)

D	W	H	CTN WT	CU FT	❶ Model	TFL	Standard	Graded In
							HPL 1	HPL 2
24			15	2	LK-Q90-24T	\$336	\$404	\$409
30			22	2	LK-Q90-30T	\$360	\$472	\$482

Features:

- electrical sold and ship separately
- base not required; flat plates included - use for attachment between two tables

Options:

- power continued from adjacent tables with jumper; specify no (PJN) or yes Link(PJY-L) - add \$125 list or Econo(PJY-E) - add \$140 list

LAM  
LOK - TRAINING

To Order Specify

❶ Model #	❷a Laminate Selection	❷b PVC Edge Color	❸ Electrical
Model (LK)	<a href="#">See Laminate Selection</a>	<a href="#">See PVC Edge Color Options</a>	PJY-L LINK System Jumper PJY-E ECONO System Jumper

Model Number Breakdown

LK-Q90-24T					
LK	Q	90	24	T	
LOK	Quarter Round Top Shape	90° Quarter Round	24" Depth	Laminate	

Wedge LinkTraining Top

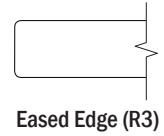
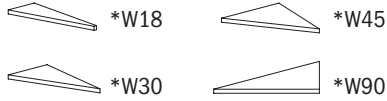

LAMINATE	D	W	H	CTN WT	CU FT	① Model	TFL	Standard HPL 1	Graded In HPL 2
		24			6	1	LK-W18-24T	\$246	\$303
	30			7	1	LK-W18-30T	\$260	\$329	\$333
	24			7	1	LK-W30-24T	\$264	\$324	\$327
	30			9	1	LK-W30-30T	\$289	\$362	\$365
	24			9	1	LK-W45-24T	\$283	\$357	\$360
	30			11	2	LK-W45-30T	\$323	\$407	\$414
	24			13	2	LK-W90-24T	\$312	\$384	\$388
	30			17	2	LK-W90-30T	\$338	\$453	\$460

Features:

- electrical sold and ship separately
- base not required; flat plates included - use for attachment between two tables

Options:

- power continued from adjacent tables with jumper; specify no (PJN) or yes Link(PJY-L) - add \$125 list or Econo(PJY-E) -add \$140 list

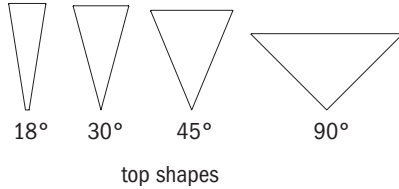

To Order Specify

① Model #	②a Laminate Selection	②b PVC Edge Color	③ Electrical
Model (LK)	<a href="#">See Laminate Selection</a>	<a href="#">See PVC Edge Color Options</a>	PJY-L LINK System Jumper PJY-E ECONO System Jumper

Model Number Breakdown

LK-W18-24T				
LK	W	18	24	T
LOK	Wedge Top Shape	18° Wedge	24" Depth	Laminate

LOK - TRAINING

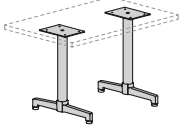
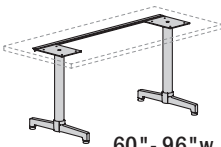
Description	D	W	H	CTN WT	CU FT	1 Model	List Price
 <p>36" &amp; 48" w</p>	20	36	29	22	4	LK-TBF-TT29-2036	\$533
	24	36	29	23	5	LK-TBF-TT29-2436	\$562
	30	36	29	24	7	LK-TBF-TT29-3036	\$597
	20	48	29	22	4	LK-TBF-TT29-2048	\$533
	24	48	29	23	5	LK-TBF-TT29-2448	\$562
	30	48	29	24	7	LK-TBF-TT29-3048	\$597
 <p>60" - 96" w includes a metal support rail</p>	20	60	29	26	5	LK-TBF-TT29-2060	\$595
	24	60	29	27	6	LK-TBF-TT29-2460	\$623
	30	60	29	28	8	LK-TBF-TT29-3060	\$657
	20	66	29	26	5	LK-TBF-TT29-2066	\$595
	24	66	29	27	6	LK-TBF-TT29-2466	\$623
	30	66	29	28	8	LK-TBF-TT29-3066	\$657
	20	72	29	27	5	LK-TBF-TT29-2072	\$605
	24	72	29	28	6	LK-TBF-TT29-2472	\$634
	30	72	29	29	8	LK-TBF-TT29-3072	\$669
	20	84	29	27	5	LK-TBF-TT29-2084	\$605
	24	84	29	28	6	LK-TBF-TT29-2484	\$634
	30	84	29	29	8	LK-TBF-TT29-3084	\$669
	20	96	29	28	6	LK-TBF-TT29-2096	\$625
	24	96	29	29	7	LK-TBF-TT29-2496	\$655
	30	96	29	30	9	LK-TBF-TT29-3096	\$690

**Features:**



- bases include all necessary field assembly hardware

**Options:**

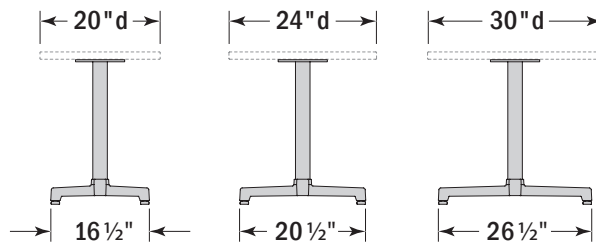
- specify Glide (G) or Caster(C) - choice of Black(BL) or White/Grey (WG) Caster; add \$47 list for casters
- specify metal finish, see below for options and two-tone capabilities

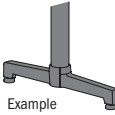
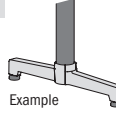

**To Order Specify**

1 Model #	2 Feet & Post Finish	Dual Finish	3 Glides or Casters
Lok (LK)	<a href="#">See Feet &amp; Post Finish Options</a>  <p>Example</p>	<b>2a Feet Finish</b> <a href="#">See Feet Finish Options</a> <b>2b Post Finish</b> <a href="#">See Post Finish Options</a>  <p>Example</p>	<b>G Glides</b>  Standard (no upcharge) <b>C Casters</b> - BL Black +\$47 - WG White w/Grey Wheels +\$47

LK-TBF-TT29-3072					
LK	TBF	TT	29	3072	
LOK	T-Base Fixed	Rectangular Top Shape	Height	Used on 30" x 72" Tops	

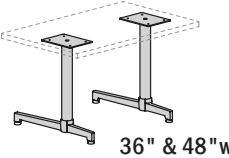
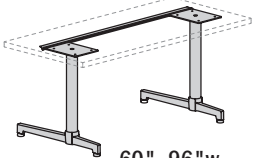
Description	D	W	H	CTN WT	CU FT	① Model	List Price
Cantilever Fixed T-Base for Rectangular Top	20	36	29	22	4	LK-CBF-TT29-2036	\$549
	24	36	29	23	5	LK-CBF-TT29-2436	\$564
	30	36	29	24	7	LK-CBF-TT29-3036	\$594
 36" & 48" w	20	48	29	22	4	LK-CBF-TT29-2048	\$549
	24	48	29	23	5	LK-CBF-TT29-2448	\$564
	30	48	29	24	7	LK-CBF-TT29-3048	\$594
	20	60	29	26	5	LK-CBF-TT29-2060	\$608
	24	60	29	27	6	LK-CBF-TT29-2460	\$625
	30	60	29	28	8	LK-CBF-TT29-3060	\$655
	20	66	29	26	5	LK-CBF-TT29-2066	\$608
	24	66	29	27	6	LK-CBF-TT29-2466	\$625
	30	66	29	28	8	LK-CBF-TT29-3066	\$655
 60" - 96" w includes a metal support rail	20	72	29	27	5	LK-CBF-TT29-2072	\$620
	24	72	29	28	6	LK-CBF-TT29-2472	\$637
	30	72	29	29	8	LK-CBF-TT29-3072	\$665
	20	84	29	27	5	LK-CBF-TT29-2084	\$620
	24	84	29	28	6	LK-CBF-TT29-2484	\$637
	30	84	29	29	8	LK-CBF-TT29-3084	\$665
	20	96	29	28	6	LK-CBF-TT29-2096	\$642
	24	96	29	29	7	LK-CBF-TT29-2496	\$657
	30	96	29	30	9	LK-CBF-TT29-3096	\$686



**Features:**

- bases include all necessary field assembly hardware

**Options:**

- specify metal finish, see below for options and two-tone capabilities
- specify Glide (G) or Caster (C) - choice of Black (BL) or White/Grey (WG) Caster; add \$47 list for casters

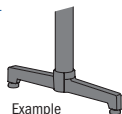
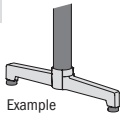
**To Order Specify**

① Model #	② Feet & Post Finish	Dual Finish	③ Glides or Casters
Lok (LK)	<a href="#">See Feet &amp; Post Finish Options</a>  Example	<b>2a Feet Finish</b> <a href="#">See Feet Finish Options</a> <b>2b Post Finish</b> <a href="#">See Post Finish Options</a>  Example	<b>G Glides</b>  Standard (no upcharge) <b>C Casters</b> - BL Black +\$47 - WG White w/Grey Wheels +\$47

LK-CBF-TT29-3072					
LK	CBF	TT	29	3072	
LOK	Cantilever T-Base Fixed	Rectangular Top Shape	Height	Used on 30" x 72" Tops	

LOK - TRAINING

LOK - TRAINING

Description	D	W	H	CTN WT	CU FT	① Model	List Price
Adjustable T Base for Rectangular Top 36" & 48" w	20	36	29	22	4	LK-TBA-TT29-2036	\$655
	24	36	29	23	5	LK-TBA-TT29-2436	\$685
	30	36	29	24	7	LK-TBA-TT29-3036	\$718
	20	48	29	22	4	LK-TBA-TT29-2048	\$655
	24	48	29	23	5	LK-TBA-TT29-2448	\$685
	30	48	29	24	7	LK-TBA-TT29-3048	\$718
	20	60	29	26	5	LK-TBA-TT29-2060	\$716
	24	60	29	27	6	LK-TBA-TT29-2460	\$745
	30	60	29	28	8	LK-TBA-TT29-3060	\$781
60" - 96" w includes a metal support rail	20	66	29	26	5	LK-TBA-TT29-2066	\$716
	24	66	29	27	6	LK-TBA-TT29-2466	\$745
	30	66	29	28	8	LK-TBA-TT29-3066	\$781
	20	72	29	27	5	LK-TBA-TT29-2072	\$727
	24	72	29	28	6	LK-TBA-TT29-2472	\$757
	30	72	29	29	8	LK-TBA-TT29-3072	\$792
	20	84	29	27	5	LK-TBA-TT29-2084	\$727
	24	84	29	28	6	LK-TBA-TT29-2484	\$757
	30	84	29	29	8	LK-TBA-TT29-3084	\$792
	20	96	29	28	6	LK-TBA-TT29-2096	\$747
	24	96	29	29	7	LK-TBA-TT29-2496	\$778
	30	96	29	30	9	LK-TBA-TT29-3096	\$812

**Features:**

- pin adjustment base provides range of 26"-34"
- bases include all necessary field assembly hardware

**Options:**

- specify metal finish, see below for options and two-tone capabilities

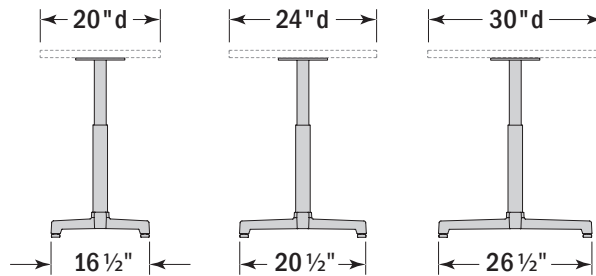

**To Order Specify**

① Model #	② Feet & Post Finish	Dual Finish		G Glides
Lok (LK)	<a href="#">See Feet &amp; Post Finish Options</a> Example	②a Feet Finish <a href="#">See Feet Finish Options</a>	②b Post Finish <a href="#">See Post Finish Options</a> Example	Standard (no upcharge)

LK-TBA-TT29-3072				
LK	TBA	TT	29	3072
LOK	T-Base Adjustable	Rectangular Top Shape	Height	Used on 30" x 72" Tops

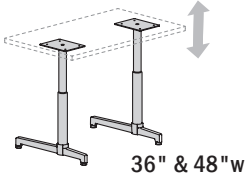
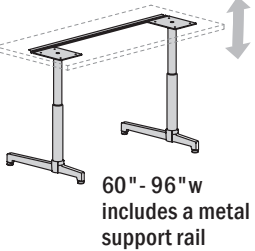
Description	D	W	H	CTN WT	CU FT	① Model	List Price
 <p>36" &amp; 48" w</p>	20	36	29	22	4	LK-CBA-TT29-2036	\$670
	24	36	29	23	5	LK-CBA-TT29-2436	\$688
	30	36	29	24	7	LK-CBA-TT29-3036	\$715
	20	48	29	22	4	LK-CBA-TT29-2048	\$670
	24	48	29	23	5	LK-CBA-TT29-2448	\$688
	30	48	29	24	7	LK-CBA-TT29-3048	\$715
 <p>60" - 96" w includes a metal support rail</p>	20	60	29	26	5	LK-CBA-TT29-2060	\$732
	24	60	29	27	6	LK-CBA-TT29-2460	\$747
	30	60	29	28	8	LK-CBA-TT29-3060	\$778
	20	66	29	26	5	LK-CBA-TT29-2066	\$732
	24	66	29	27	6	LK-CBA-TT29-2466	\$747
	30	66	29	28	8	LK-CBA-TT29-3066	\$778
	20	72	29	27	5	LK-CBA-TT29-2072	\$742
	24	72	29	28	6	LK-CBA-TT29-2472	\$759
	30	72	29	29	8	LK-CBA-TT29-3072	\$787
	20	84	29	27	5	LK-CBA-TT29-2084	\$742
	24	84	29	28	6	LK-CBA-TT29-2484	\$759
	30	84	29	29	8	LK-CBA-TT29-3084	\$787
20	96	29	28	6	LK-CBA-TT29-2096	\$763	
24	96	29	29	7	LK-CBA-TT29-2496	\$781	
30	96	29	30	9	LK-CBA-TT29-3096	\$808	



**Features:**

- pin adjustment base provides range of 26"-34"
- bases include all necessary field assembly hardware

**Options:**

- specify metal finish, see below for options and two-tone capabilities

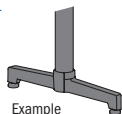
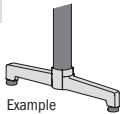
**To Order Specify**

① Model #	② Feet & Post Finish	Dual Finish		G Glides
Lok (LK)	<a href="#">See Feet &amp; Post Finish Options</a>  <p>Example</p>	<b>2a Feet Finish</b> <a href="#">See Feet Finish Options</a>	<b>2b Post Finish</b> <a href="#">See Post Finish Options</a>  <p>Example</p>	 Standard (no upcharge)

LK-CBA-TT29-3072					
LK	CBA	TT	29	3072	
LOK	Cantilever T-Base Adjustable	Rectangular Top Shape	Height	Used on 30" x 72" Tops	

LOK - TRAINING

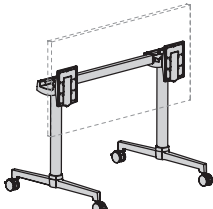
Description	D	W	H	CTN WT	CU FT	1 Model	List Price
Tilt T Base for Rectangular Top	20	36	29	27	5	LK-TBT-TT29-2036	\$931
	24	36	29	28	6	LK-TBT-TT29-2436	\$960
	30	36	29	28	8	LK-TBT-TT29-3036	\$997
	20	48	29	28	6	LK-TBT-TT29-2048	\$1,066
	24	48	29	29	7	LK-TBT-TT29-2448	\$1,093
	30	48	29	30	9	LK-TBT-TT29-3048	\$1,129
	20	60	29	29	6	LK-TBT-TT29-2060	\$1,082
	24	60	29	30	7	LK-TBT-TT29-2460	\$1,111
	30	60	29	31	9	LK-TBT-TT29-3060	\$1,145
	20	66	29	31	9	LK-TBT-TT29-2066	\$1,082
	24	66	29	30	7	LK-TBT-TT29-2466	\$1,111
	30	66	29	29	6	LK-TBT-TT29-3066	\$1,145
	20	72	29	30	6	LK-TBT-TT29-2072	\$1,113
	24	72	29	31	7	LK-TBT-TT29-2472	\$1,144
	30	72	29	32	9	LK-TBT-TT29-3072	\$1,178
	20	84	29	30	6	LK-TBT-TT29-2084	\$1,113
	24	84	29	31	7	LK-TBT-TT29-2484	\$1,144
	30	84	29	32	9	LK-TBT-TT29-3084	\$1,178
	20	96	29	32	6	LK-TBT-TT29-2096	\$1,175
	24	96	29	32	7	LK-TBT-TT29-2496	\$1,203
	30	96	29	33	9	LK-TBT-TT29-3096	\$1,235

**Features:**



- base nests in offset position when top is tilted
- bases include all necessary field assembly hardware

**Options:**

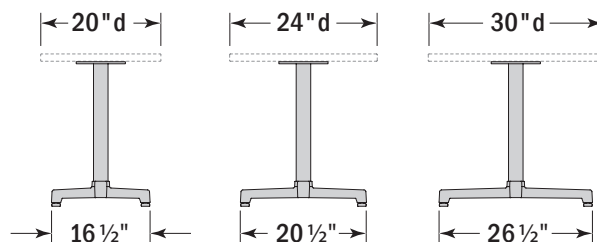
- specify Black (BL) or White/Grey (WG) Caster
- specify metal finish, see below for options and two-tone capabilities

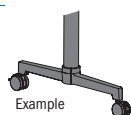
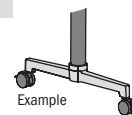

**To Order Specify**

1 Model #	2 Feet & Post Finish	Dual Finish	3 Casters
Lok (LK)	<a href="#">See Feet &amp; Post Finish Options</a> 	<b>2a Feet Finish</b> <a href="#">See Feet Finish Options</a> <b>2b Post Finish</b> <a href="#">See Post Finish Options</a> 	<b>C Casters - Standard (no upcharge)</b> - BL Black      - WG White w/ Grey Wheels  

LK-TBT-TT29-3072					
LK	TBT	TT	29	3072	
LOK	T-Base Tilt	Rectangular Top Shape	Height	Used on 30" x 72" Tops	

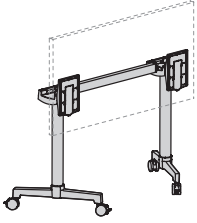
Description	D	W	H	CTN WT	CU FT	① Model	List Price
Inline Tilt T-Base for Rectangular Top 	20	48	29	28	6	LK-IBT-TT29-2048	\$976
	24	48	29	28	6	LK-IBT-TT29-2448	\$976
	20	60	29	29	7	LK-IBT-TT29-2060	\$1,111
	24	60	29	29	7	LK-IBT-TT29-2460	\$1,111
	20	66	29	29	7	LK-IBT-TT29-2066	\$1,111
	24	66	29	29	7	LK-IBT-TT29-2466	\$1,111
	20	72	29	30	7	LK-IBT-TT29-2072	\$1,127
	24	72	29	30	7	LK-IBT-TT29-2472	\$1,127
	20	84	29	31	7	LK-IBT-TT29-2084	\$1,159
	24	84	29	31	7	LK-IBT-TT29-2484	\$1,159
	20	96	29	32	7	LK-IBT-TT29-2096	\$1,220
	24	96	29	32	7	LK-IBT-TT29-2496	\$1,220



**Features:**

- base nests in inline position when top is tilted
- bases include all necessary field assembly hardware

**Options:**

- specify Black (BL) or White/Grey (WG) Caster
- specify metal finish, see below for options and two-tone capabilities

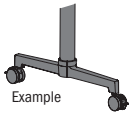
**To Order Specify**

① Model #	② Feet & Post Finish	Dual Finish		③ Casters	
Lok (LK)	<a href="#">See Feet &amp; Post Finish Options</a>  Example	<b>2a Feet Finish</b> <a href="#">See Feet Finish Options</a>	<b>2b Post Finish</b> <a href="#">See Post Finish Options</a>	<b>C Casters - Standard (no upcharge)</b> - BL Black 	- WG White w/Grey Wheels 
<b>LK-IBT-TT29-2472</b>					
LK	IBT	TT	29	2472	
LOK	Inline T-Base Tilt	Rectangular Top Shape	Height	Used on 24" x 72" Tops	

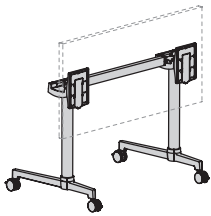
Description	D	W	H	CTN WT	CU FT	① Model	List Price
Cantilever Tilt T-Base for Rectangular Top	20	36	29	27	5	LK-CBT-TT29-2036	\$963
	24	36	29	28	6	LK-CBT-TT29-2436	\$978
	30	36	29	28	8	LK-CBT-TT29-3036	\$1,008
	20	48	29	28	6	LK-CBT-TT29-2048	\$1,096
	24	48	29	29	7	LK-CBT-TT29-2448	\$1,113
	30	48	29	30	9	LK-CBT-TT29-3048	\$1,142
	20	60	29	29	6	LK-CBT-TT29-2060	\$1,112
	24	60	29	30	7	LK-CBT-TT29-2460	\$1,129
	30	60	29	31	9	LK-CBT-TT29-3060	\$1,158
	20	66	29	29	6	LK-CBT-TT29-2066	\$1,112
	24	66	29	30	7	LK-CBT-TT29-2466	\$1,129
	30	66	29	31	9	LK-CBT-TT29-3066	\$1,158
	20	72	29	30	6	LK-CBT-TT29-2072	\$1,145
	24	72	29	31	7	LK-CBT-TT29-2472	\$1,160
	30	72	29	32	9	LK-CBT-TT29-3072	\$1,190
	20	84	29	30	6	LK-CBT-TT29-2084	\$1,145
	24	84	29	31	7	LK-CBT-TT29-2484	\$1,160
	30	84	29	32	9	LK-CBT-TT29-3084	\$1,190
	20	96	29	32	6	LK-CBT-TT29-2096	\$1,206
	24	96	29	32	7	LK-CBT-TT29-2496	\$1,222
	30	96	29	33	9	LK-CBT-TT29-3096	\$1,250



**Features:**

- base nests in offset position when top is tilted
- bases include all necessary field assembly hardware

**Options:**

- specify Black (BL) or White/Grey (WG) Caster
- specify metal finish, see below for options and two-tone capabilities

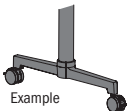
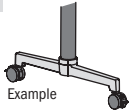
**To Order Specify**

① Model #	② Feet & Post Finish	Dual Finish	③ Casters
Lok (LK)	<a href="#">See Feet &amp; Post Finish Options</a> 	<b>2a Feet Finish</b> <a href="#">See Feet Finish Options</a> <b>2b Post Finish</b> <a href="#">See Post Finish Options</a> 	<b>C Casters - Standard (no upcharge)</b> - BL Black      - WG White w/ Grey Wheels 

LK-CBT-TT29-3072					
LK	CBT	TT	29	3072	
LOK	Cantilever T-Base Tilt	Rectangular Top Shape	Height	Used on 30" x 72" Tops	

Page left intentionally blank

Description	D	W	H	CTN WT	CU FT	① Model	List Price
Fixed T Base for Trapezoid Top	24	48	29	23	5	LK-TBF-TZ29-2448	\$562
	30	48	29	24	7	LK-TBF-TZ29-3048	\$597

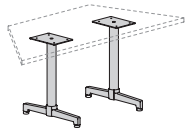

**Features:**

- specify Glide (G) or Caster(C) -choice of Black(BL) or White/Grey (WG) Caster; add \$47 list for casters

**Options:**

- bases include all necessary field assembly hardware
- specify metal finish, see below for options and two-tone capabilities

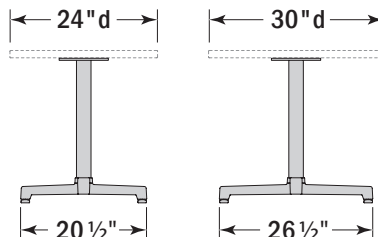

Cantilever Fixed T-Base for Trapezoid Top	24	48	29	23	5	LK-CBF-TZ29-2448	\$564
	30	48	29	24	7	LK-CBF-TZ29-3048	\$594

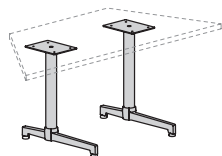





**Features:**

- specify Glide (G) or Caster(C) -choice of Black(BL) or White/Grey (WG) Caster; add \$47 list for casters

**Options:**

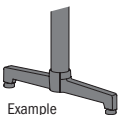
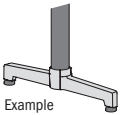
- bases include all necessary field assembly hardware
- specify metal finish, see below for options and two-tone capabilities

**To Order Specify**

① Model #	② Feet & Post Finish	Dual Finish		③ Glides or Casters		
Lok (LK)	<a href="#">See Feet &amp; Post Finish Options</a>  Example	2a Feet Finish <a href="#">See Feet Finish Options</a>	2b Post Finish <a href="#">See Post Finish Options</a>  Example	G Glides  Standard (no upcharge)	C Casters - BL Black  +\$47	- WG White w/Grey Wheels  +\$47

LK-TBF-TZ29-3072					
LK	TBF	TZ	29	3072	
LOK	T-Base Fixed	Trapezoid Top Shape	Height	Used on 30" x 72" Tops	

Description	D	W	H	CTN WT	CU FT	① Model	List Price
Adjustable T Base for Trapezoid Top	24	48	29	23	5	LK-TBA-TZ29-2448	\$685
	30	48	29	24	7	LK-TBA-TZ29-3048	\$718

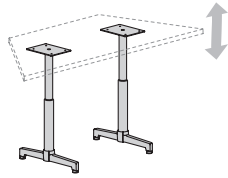

**Features:**

- pin adjustment base provides range of 26"-34"
- ADA Compliant
- bases include all necessary field assembly hardware

**Options:**

- specify metal finish, see below for options and two-tone capabilities

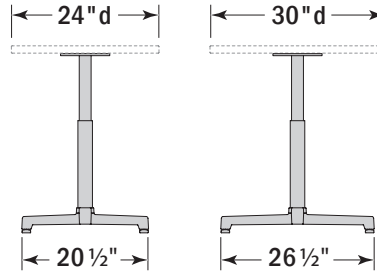

Description	D	W	H	CTN WT	CU FT	① Model	List Price
Cantilever Adjustable T-Base for Trapezoid Top	24	48	29	23	5	LK-CBA-TZ29-2448	\$688
	30	48	29	24	7	LK-CBA-TZ29-3048	\$715

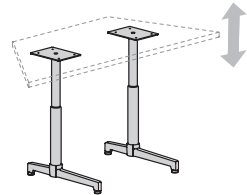

**Features:**



- pin adjustment base provides range of 26"-34"
- ADA Compliant
- bases include all necessary field assembly hardware

**Options:**

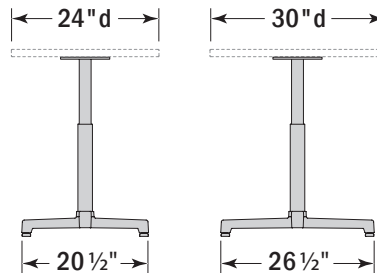
- specify metal finish, see below for options and two-tone capabilities

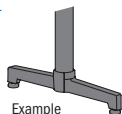

**To Order Specify**

① Model #	② Feet & Post Finish	Dual Finish		G Glides
Lok (LK)	<a href="#">See Feet &amp; Post Finish Options</a>  <p>Example</p>	<b>2a Feet Finish</b> <a href="#">See Feet Finish Options</a>	<b>2b Post Finish</b> <a href="#">See Post Finish Options</a>	 Standard (no upcharge)

LK-TBF-TZ29-3072					
LK	TBA	TZ	29	3072	
LOK	T-Base Adjustable	Trapezoid Top Shape	Height	Used on 30" x 72" Tops	

Description	D	W	H	CTN WT	CU FT	1 Model	List Price
Tilt T Base for Trapezoid Top	24	48	29	29	7	LK-TBT-TZ29-2448	\$1,093
	30	48	29	30	9	LK-TBT-TZ29-3048	\$1,129

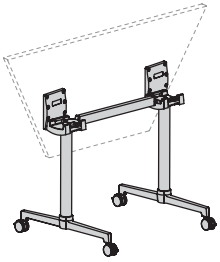

**Features:**

- base nests in offset position when top is tilted
- bases include all necessary field assembly hardware

**Options:**

- specify Black (BL) or White/Grey (WG) Caster
- specify metal finish, see below for options and two-tone capabilities

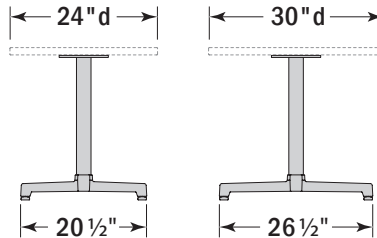

Inline Tilt T-Base for Trapezoid Top	24	48	29	27	6	LK-IBT-TZ29-2448	\$976
	30	48	29	28	8	LK-IBT-TZ29-3048	\$1,012

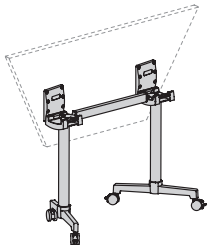



**Features:**

- base nests in inline position when top is tilted
- bases include all necessary field assembly hardware

**Options:**

- specify metal finish, see below for options and two-tone capabilities
- specify Black (BL) or White/Grey (WG) Caster

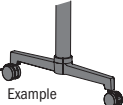
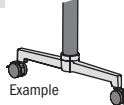
**To Order Specify**

1 Model #	2 Feet & Post Finish	Dual Finish		3 Casters
Lok (LK)	<a href="#">See Feet &amp; Post Finish Options</a> 	<b>2a Feet Finish</b> <a href="#">See Feet Finish Options</a>	<b>2b Post Finish</b> <a href="#">See Post Finish Options</a> 	<b>C Casters - Standard (no upcharge)</b> - BL Black      - WG White w/ Grey Wheels 

LK-TBT-TZ29-3048					
LK	TBT	TZ	29	3048	
LOK	T-Base Tilt	Trapezoid Top Shape	Height	Used on 30" x 48" Tops	

Description	D	W	H	CTN WT	CU FT	① Model	List Price
Cantilever Tilt T-Base for Trapezoid Top	24	48	29	29	7	LK-CBT-TZ29-2448	\$1,113
	30	48	29	30	9	LK-CBT-TZ29-3048	\$1,142

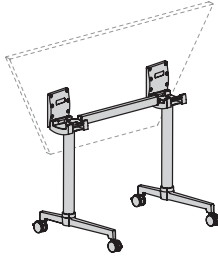

**Features:**



- base nests in offset position when top is tilted
- bases include all necessary field assembly hardware

**Options:**

- specify Black (BL) or White/Grey (WG) Caster
- specify metal finish, see below for options and two-tone capabilities

LOK - TRAINING

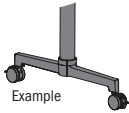
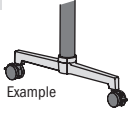
**To Order Specify**

① Model #	② Feet & Post Finish	Dual Finish		③ Casters
Lok (LK)	<a href="#">See Feet &amp; Post Finish Options</a> 	<b>2a Feet Finish</b> <a href="#">See Feet Finish Options</a>	<b>2b Post Finish</b> <a href="#">See Post Finish Options</a> 	<b>C Casters - Standard (no upcharge)</b> - BL Black      - WG White w/Grey Wheels 

LK-CBT-TZ29-2448					
LK	CBT	TZ	29	2448	
LOK	Cantilever Tilt T-Base	Trapezoid Top Shape	Height	Used on 24" x 48" Tops	

Description	D	W	H	CTN WT	CU FT	① Model	List Price
Fixed T Base for Lecture Top	24	48	29	23	5	LK-TBF-LC29-2448	\$578
	30	48	29	24	7	LK-TBF-LC29-3048	\$614
	24	60	29	27	6	LK-TBF-LC29-2460	\$623
	30	60	29	28	8	LK-TBF-LC29-3060	\$657

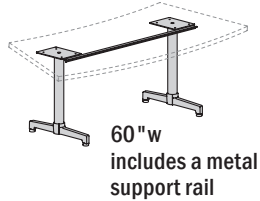
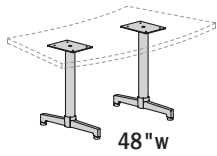

**Features:**

- bases include all necessary field assembly hardware

**Options:**

- specify metal finish, see below for options and two-tone capabilities
- specify Glide (G) or Caster(C) -choice of Black(BL) or White/Grey (WG) Caster; add \$47 list for casters

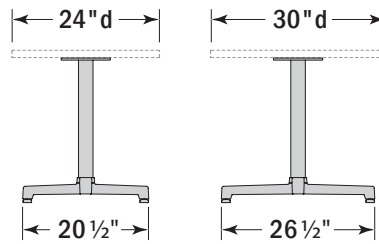

Description	D	W	H	CTN WT	CU FT	① Model	List Price
Cantilever Fixed T-Base for Lecture Top	24	48	29	22	4	LK-CBF-LC29-2448	\$564
	30	48	29	24	7	LK-CBF-LC29-3048	\$609
	24	60	29	26	5	LK-CBF-LC29-2460	\$608
	30	60	29	28	8	LK-CBF-LC29-3060	\$655

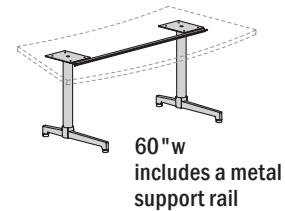
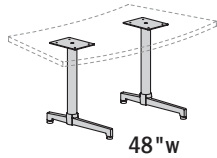

**Features:**

- bases include all necessary field assembly hardware

**Options:**

- specify metal finish, see below for options and two-tone capabilities
- specify Glide (G) or Caster(C) - choice of Black(BL) or White/Grey (WG) Caster; add \$47 list for casters

**To Order Specify**

① Model #	② Feet & Post Finish	Dual Finish	③ Glides or Casters										
Lok (LK)	<a href="#">See Feet &amp; Post Finish Options</a> <p>Example</p>	<table border="1"> <tr> <th>2a Feet Finish</th> <th>2b Post Finish</th> </tr> <tr> <td> <a href="#">See Feet Finish Options</a> </td> <td> <a href="#">See Post Finish Options</a> </td> </tr> </table> <p>Example</p>	2a Feet Finish	2b Post Finish	<a href="#">See Feet Finish Options</a>	<a href="#">See Post Finish Options</a>	<table border="1"> <tr> <th>G Glides</th> <th>C Casters</th> <th>- WG White w/Grey Wheels</th> </tr> <tr> <td> <p>Standard (no upcharge)</p> </td> <td> <p>+ \$47</p> </td> <td> <p>+ \$47</p> </td> </tr> </table>	G Glides	C Casters	- WG White w/Grey Wheels	<p>Standard (no upcharge)</p>	<p>+ \$47</p>	<p>+ \$47</p>
2a Feet Finish	2b Post Finish												
<a href="#">See Feet Finish Options</a>	<a href="#">See Post Finish Options</a>												
G Glides	C Casters	- WG White w/Grey Wheels											
<p>Standard (no upcharge)</p>	<p>+ \$47</p>	<p>+ \$47</p>											

LK-CBF-LC29-3072					
LK	CBF	LC	29	3060	
LOK	T-Base Fixed	Lecture Top Shape	Height	Used on 30" x 72" Tops	

Description	D	W	H	CTN WT	CU FT	① Model	List Price
Adjustable T Base for Lecture Top	24	48	29	23	5	LK-TBA-LC29-2448	\$701
	30	48	29	24	7	LK-TBA-LC29-3048	\$737
	24	60	29	27	6	LK-TBA-LC29-2460	\$745
	30	60	29	28	8	LK-TBA-LC29-3060	\$781

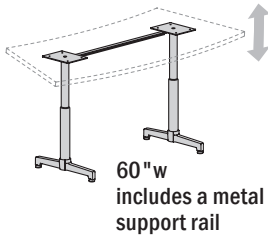
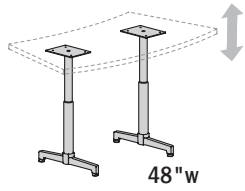

**Features:**

- pin adjustment base provides range of 26"-34"
- ADA Compliant
- bases include all necessary field assembly hardware

**Options:**

- specify metal finish, see below for options and two-tone capabilities

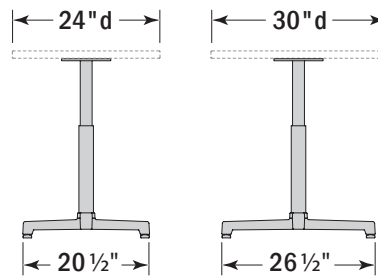

Description	D	W	H	CTN WT	CU FT	Model	List Price
Cantilever Adjustable T-Base for Lecture Top	24	48	29	22	4	LK-CBA-LC29-2448	\$688
	30	48	29	24	7	LK-CBA-LC29-3048	\$733
	24	60	29	26	5	LK-CBA-LC29-2460	\$732
	30	60	29	28	8	LK-CBA-LC29-3060	\$778

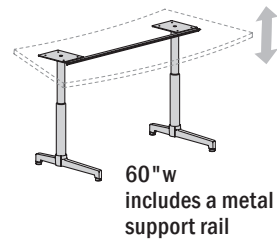
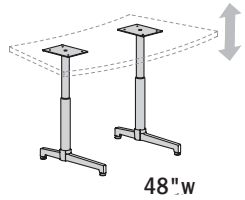

**Features:**

- pin adjustment base provides range of 26"-34"
- ADA Compliant
- bases include all necessary field assembly hardware

**Options:**

- specify metal finish, see below for options and two-tone capabilities

**To Order Specify**

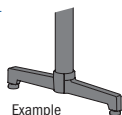
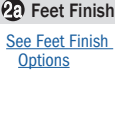
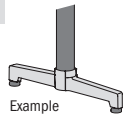
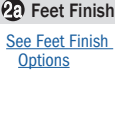
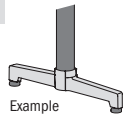
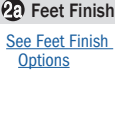
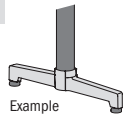
① Model #	② Feet & Post Finish	Dual Finish				
Lok (LK)	<a href="#">See Feet &amp; Post Finish Options</a> 	<table border="0"> <tr> <td> <b>2a Feet Finish</b>  <a href="#">See Feet Finish Options</a> </td> <td> <b>2b Post Finish</b>  <a href="#">See Post Finish Options</a> </td> </tr> <tr> <td></td> <td></td> </tr> </table>	<b>2a Feet Finish</b> <a href="#">See Feet Finish Options</a>	<b>2b Post Finish</b> <a href="#">See Post Finish Options</a>		
<b>2a Feet Finish</b> <a href="#">See Feet Finish Options</a>	<b>2b Post Finish</b> <a href="#">See Post Finish Options</a>					
						

LK-CBA-LC29-3060					
LK	CBA	LC	29	3060	
LOK	Cantilever T-Base Adjustable	Lecture Top Shape	Height	Used on 30" x 60" Tops	

Description	D	W	H	CTN WT	CU FT	① Model	List Price
Tilt T Base for Lecture Top	24	48	29	29	7	LK-TBT-LC29-2448	\$1,111
	30	48	29	30	9	LK-TBT-LC29-3048	\$1,146
	24	60	29	30	7	LK-TBT-LC29-2460	\$1,127
	30	60	29	31	9	LK-TBT-LC29-3060	\$1,160

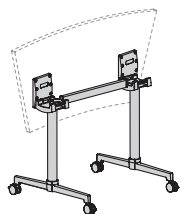

**Features:**

- base nests in offset position when top is tilted
- bases include all necessary field assembly hardware

**Options:**

- specify metal finish, see below for options and two-tone capabilities

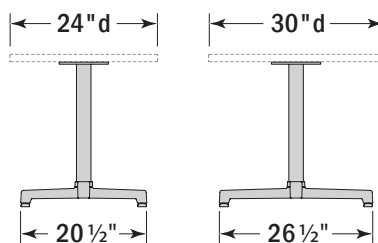

Description	D	W	H	CTN WT	CU FT	① Model	List Price
Inline Tilt T-Base for Lecture Top	24	48	29	28	6	LK-IBT-LC29-2448	\$976
	30	48	29	28	8	LK-IBT-LC29-3048	\$1,012
	24	60	29	29	7	LK-IBT-LC29-2460	\$1,111
	30	60	29	30	9	LK-IBT-LC29-3060	\$1,146

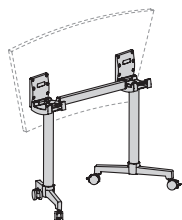



**Features:**

- base nests in inline position when top is tilted
- bases include all necessary field assembly hardware

**Options:**

- specify metal finish, see below for options and two-tone capabilities
- specify Black (BL) or White/Grey (WG) Caster

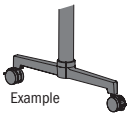
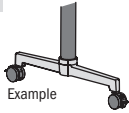
**To Order Specify**

① Model #	② Feet & Post Finish	Dual Finish	③ Casters
Lok (LK)	<a href="#">See Feet &amp; Post Finish Options</a> 	<b>2a Feet Finish</b> <a href="#">See Feet Finish Options</a> <b>2b Post Finish</b> <a href="#">See Post Finish Options</a> 	<b>C Casters - Standard (no upcharge)</b> - BL Black      - WG White w/ Grey Wheels 

LK-TBF-TT29-3072					
LK	TBF	TT	29	3072	
LOK	T-Base Fixed	Rectangular Top Shape	Height	Used on 30" x 72" Tops	

Description	D	W	H	CTN WT	CU FT	❶ Model	List Price
Cantilever Tilt T-Base for Lecture Top	24	48	29	29	7	LK-CBT-LC29-2448	\$1,129
	30	48	29	30	9	LK-CBT-LC29-3048	\$1,142
	24	60	29	30	7	LK-CBT-LC29-2460	\$1,113
	30	60	29	31	9	LK-CBT-LC29-3060	\$1,158

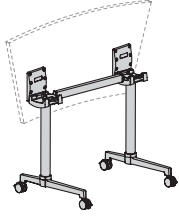



**Features:**

- bases include all necessary field assembly hardware
- specify metal finish, see below for options and two-tone capabilities

**Options:**

- specify Black (BL) or White/Grey (WG) Caster

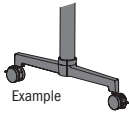
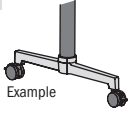
**To Order Specify**

❶ Model #	❷ Feet & Post Finish	Dual Finish		❸ Casters
Lok (LK)	<a href="#">See Feet &amp; Post Finish Options</a> 	<b>2a Feet Finish</b> <a href="#">See Feet Finish Options</a>	<b>2b Post Finish</b> <a href="#">See Post Finish Options</a> 	<b>C Casters - Standard (no upcharge)</b> - BL Black      - WG White w/ Grey Wheels  

<b>LK-TBF-TT29-3072</b>					
LK	TBA	TT	29	3072	
LOK	T-Base Adjustable	Rectangular Top Shape	Height	Used on 30" x 72" Tops	

Description	D	W	H	CTN WT	CU FT	1 Model	List Price
Fixed T Base for Crescent Top	24	48	29	23	5	LK-TBF-CR29-2448	\$562
	30	48	29	24	7	LK-TBF-CR29-3048	\$597

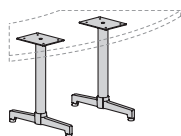

**Features:**

- bases include all necessary field assembly hardware

**Options:**

- specify metal finish, see below for options and two-tone capabilities
- specify Glide (G) or Caster(C) - choice of Black(BL) or White/Grey (WG) Caster; add \$47 list for casters

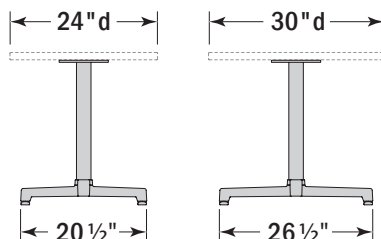

Cantilever Fixed T-Base for Crescent Top	24	48	29	23	5	LK-CBF-CR29-2448	\$564
	30	48	29	24	7	LK-CBF-CR29-3048	\$594

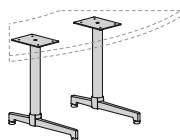

**Features:**

- bases include all necessary field assembly hardware

**Options:**

- specify metal finish, see below for options and two-tone capabilities
- specify Glide (G) or Caster(C) - choice of Black(BL) or White/Grey (WG) Caster; add \$47 list for casters

**To Order Specify**

1 Model #	2 Feet & Post Finish	Dual Finish		3 Glides or Casters		
Lok (LK)	<a href="#">See Feet &amp; Post Finish Options</a>  Example	2a Feet Finish <a href="#">See Feet Finish Options</a>	2b Post Finish <a href="#">See Post Finish Options</a>  Example	G Glides  Standard (no upcharge)	C Casters - BL Black +\$47 	- WG White w/Grey Wheels +\$47 

LK-TBF-TT29-3072					
LK	TBF	TT	29	3072	
LOK	T-Base Fixed	Rectangular Top Shape	Height	Used on 30" x 72" Tops	

Description	D	W	H	CTN WT	CU FT	① Model	List Price
Adjustable T Base for Crescent Top	24	48	29	23	5	LK-TBA-CR29-2448	\$685
	30	48	29	24	7	LK-TBA-CR29-3048	\$718

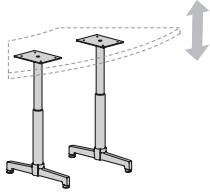

**Features:**

- pin adjustment base provides range of 26"-34"
- ADA Compliant
- bases include all necessary field assembly hardware

**Options:**

- specify metal finish, see below for options and two-tone capabilities

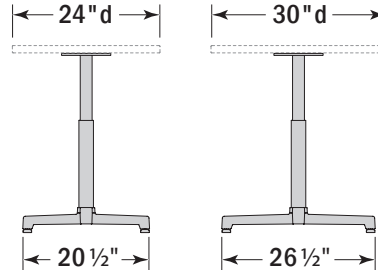

Cantilever Adjustable T-Base for Crescent Top	24	48	29	23	5	LK-CBA-CR29-2448	\$688
	30	48	29	24	7	LK-CBA-CR29-3048	\$715

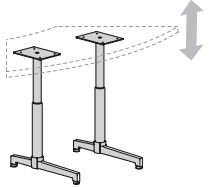

**Features:**

- pin adjustment base provides range of 26"-34"
- ADA Compliant
- bases include all necessary field assembly hardware

**Options:**

- specify metal finish, see below for options and two-tone capabilities

**To Order Specify**

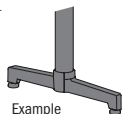
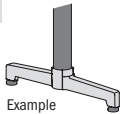
① Model #	② Feet & Post Finish	Dual Finish	
Lok (LK)	<a href="#">See Feet &amp; Post Finish Options</a>  <p>Example</p>	<b>2a Feet Finish</b> <a href="#">See Feet Finish Options</a>	<b>2b Post Finish</b> <a href="#">See Post Finish Options</a>  <p>Example</p>

LK-TBF-TT29-3072					
LK	TBA	TT	29	3072	
LOK	T-Base Adjustable	Rectangular Top Shape	Height	Used on 30" x 72" Tops	

Description	D	W	H	CTN WT	CU FT	1 Model	List Price
Tilt T Base for Crescent Top	24	48	29	29	7	LK-TBT-CR29-2448	\$1,093
	30	48	29	30	9	LK-TBT-CR29-3048	\$1,129

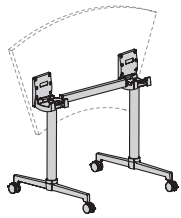

**Features:**

- base nests in offset position when top is tilted
- bases include all necessary field assembly hardware

**Options:**

- specify metal finish, see below for options and two-tone capabilities

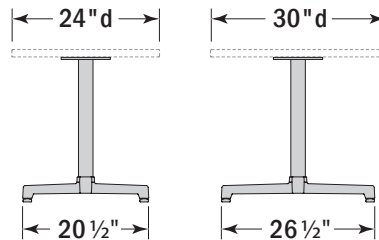

Description	D	W	H	CTN WT	CU FT	1 Model	List Price
Inline Tilt T-Base for Crescent Top	24	48	29	28	6	LK-IBT-CR29-2448	\$976
	30	48	29	28	8	LK-IBT-CR29-3048	\$1,012

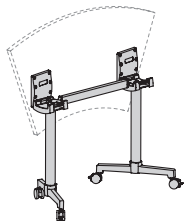



**Features:**

- base nests in inline position when top is tilted
- bases include all necessary field assembly hardware

**Options:**

- specify metal finish, see below for options and two-tone capabilities
- specify Black (BL) or White/Grey (WG) Caster

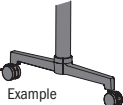
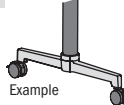
**To Order Specify**

1 Model #	2 Feet & Post Finish	Dual Finish	3 Casters
Lok (LK)	<a href="#">See Feet &amp; Post Finish Options</a> 	<b>2a Feet Finish</b> <a href="#">See Feet Finish Options</a> <b>2b Post Finish</b> <a href="#">See Post Finish Options</a> 	<b>C Casters - Standard (no upcharge)</b> - BL Black      - WG White w/ Grey Wheels 

LK-TBF-TT29-3072					
LK	TBF	TT	29	3072	
LOK	T-Base Fixed	Rectangular Top Shape	Height	Used on 30" x 72" Tops	

Description	D	W	H	CTN WT	CU FT	① Model	List Price
Cantilever Tilt T-Base for Crescent Top	24	48	29	29	7	LK-CBT-CR29-2448	\$1,113
	30	48	29	30	9	LK-CBT-CR29-3048	\$1,142

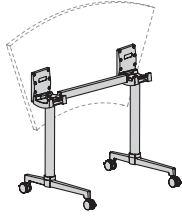

**Features:**



- bases include all necessary field assembly hardware
- specify metal finish, see below for options and two-tone capabilities

**Options:**

- specify Black (BL) or White/Grey (WG) Caster

LOK - TRAINING

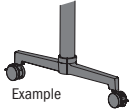
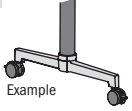
**To Order Specify**

① Model #	② Feet & Post Finish	Dual Finish		③ Casters
Lok (LK)	<a href="#">See Feet &amp; Post Finish Options</a> 	<b>2a Feet Finish</b> <a href="#">See Feet Finish Options</a>	<b>2b Post Finish</b> <a href="#">See Post Finish Options</a> 	<b>C Casters - Standard (no upcharge)</b> - BL Black      - WG White w/ Grey Wheels 

LK-TBF-TT29-3072					
LK	TBA	TT	29	3072	
LOK	T-Base Adjustable	Rectangular Top Shape	Height	Used on 30" x 72" Tops	

Description	D	W	H	CTN WT	CU FT	① Model	List Price
Fixed T Base for Half Round Top	24	48	29	23	5	LK-TBF-HR29-2448	\$562
	30	60	29	28	8	LK-TBF-HR29-3060	\$657

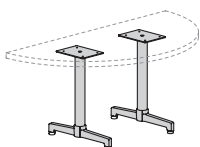

**Features:**

- bases include all necessary field assembly hardware

**Options:**

- specify metal finish, see below for options and two-tone capabilities
- specify Glide (G) or Caster(C) - choice of Black(BL) or White/Grey (WG) Caster; add \$47 list for casters

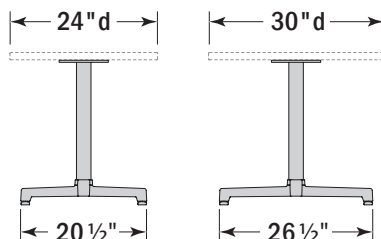

Cantilever Fixed T-Base for Half Round Top	24	48	29	23	5	LK-CBF-HR29-2448	\$549
	30	60	29	28	8	LK-CBF-HR29-3060	\$655

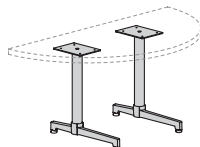





**Features:**

- bases include all necessary field assembly hardware

**Options:**

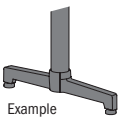
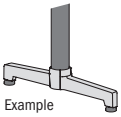
- specify metal finish, see below for options and two-tone capabilities
- specify Glide (G) or Caster(C) - choice of Black(BL) or White/Grey (WG) Caster; add \$47 list for casters

**To Order Specify**

① Model #	② Feet & Post Finish	Dual Finish		③ Glides or Casters		
Lok (LK)	<a href="#">See Feet &amp; Post Finish Options</a>  <p>Example</p>	<b>2a Feet Finish</b> <a href="#">See Feet Finish Options</a>	<b>2b Post Finish</b> <a href="#">See Post Finish Options</a>  <p>Example</p>	<b>G Glides</b>  Standard (no upcharge)	<b>C Casters</b> - BL Black +\$47 	- WG White w/Grey Wheels +\$47 

LK-TBF-TT29-3072					
LK	TBF	TT	29	3072	
LOK	T-Base Fixed	Rectangular Top Shape	Height	Used on 30" x 72" Tops	

Description	D	W	H	CTN WT	CU FT	① Model	List Price
Adjustable T Base for Half Round Top	24	48	29	23	5	LK-TBA-HR29-2448	\$685
	30	60	29	28	8	LK-TBA-HR29-3060	\$781

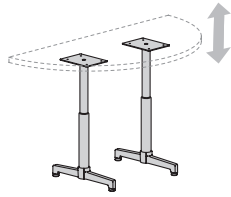

**Features:**

- pin adjustment base provides range of 26"-34"
- ADA Compliant
- bases include all necessary field assembly hardware

**Options:**

- specify metal finish, see below for options and two-tone capabilities

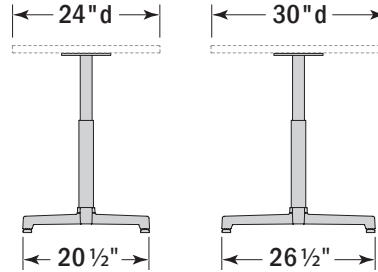

Description	D	W	H	CTN WT	CU FT	① Model	List Price
Cantilever Adjustable T-Base for Half Round Top	24	48	29	23	5	LK-CBA-HR29-2448	\$670
	30	60	29	28	8	LK-CBA-HR29-3060	\$778

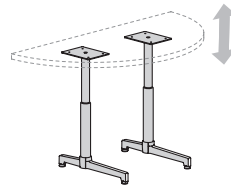

**Features:**

- pin adjustment base provides range of 26"-34"
- ADA Compliant
- bases include all necessary field assembly hardware

**Options:**

- specify metal finish, see below for options and two-tone capabilities

**To Order Specify**

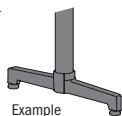
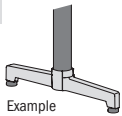
① Model #	② Feet & Post Finish	Dual Finish	
Lok (LK)	<a href="#">See Feet &amp; Post Finish Options</a>  <p>Example</p>	<b>2a Feet Finish</b> <a href="#">See Feet Finish Options</a>	<b>2b Post Finish</b> <a href="#">See Post Finish Options</a>  <p>Example</p>

LK-TBF-TT29-3072					
LK	TBA	TT	29	3072	
LOK	T-Base Adjustable	Rectangular Top Shape	Height	Used on 30" x 72" Tops	

Description	D	W	H	CTN WT	CU FT	1 Model	List Price
Tilt T Base for Half Round Top	24	48	29	28	6	LK-TBT-HR29-2448	\$976
	30	60	29	30	9	LK-TBT-HR29-3060	\$1,146

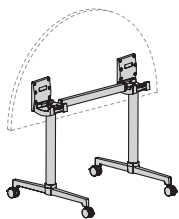

**Features:**

- base nests in offset position when top is tilted
- bases include all necessary field assembly hardware

**Options:**

- specify metal finish, see below for options and two-tone capabilities

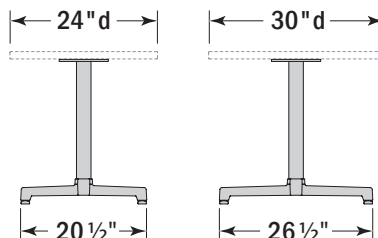

Description	D	W	H	CTN WT	CU FT	1 Model	List Price
Inline Tilt T-Base for Half Round Top	24	48	29	28	6	LK-IBT-HR29-2448	\$976
	30	60	29	30	9	LK-IBT-HR29-3060	\$1,146

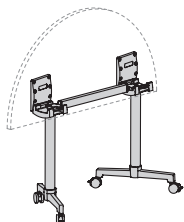



**Features:**

- base nests in inline position when top is tilted
- bases include all necessary field assembly hardware

**Options:**

- specify metal finish, see below for options and two-tone capabilities
- specify Black (BL) or White/Grey (WG) Caster

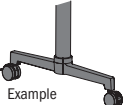
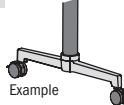
**To Order Specify**

1 Model #	2 Feet & Post Finish	Dual Finish		3 Casters
Lok (LK)	<a href="#">See Feet &amp; Post Finish Options</a> 	<a href="#">2a Feet Finish</a> <a href="#">See Feet Finish Options</a>	<a href="#">2b Post Finish</a> <a href="#">See Post Finish Options</a> 	C Casters - Standard (no upcharge) - BL Black      - WG White w/ Grey Wheels 

LK-TBF-TT29-3072					
LK	TBF	TT	29	3072	
LOK	T-Base Fixed	Rectangular Top Shape	Height	Used on 30" x 72" Tops	

Description	D	W	H	CTN WT	CU FT	① Model	List Price
Cantilever Tilt T-Base for Half Round Top	24	48	29	28	6	LK-CBT-HR29-2448	\$978
	30	60	29	30	9	LK-CBT-HR29-3060	\$1,142

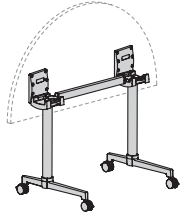

**Features:**

- bases include all necessary field assembly hardware
- specify metal finish, see below for options and two-tone capabilities

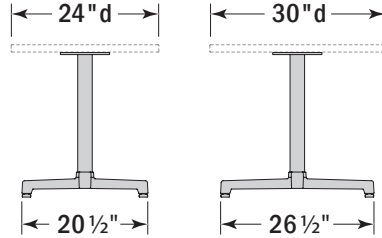

**Options:**

- specify Black (BL) or White/Grey (WG) Caster

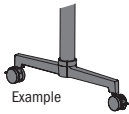
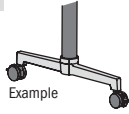

LOK - TRAINING

**To Order Specify**

① Model #	② Feet & Post Finish	Dual Finish		③ Casters
Lok (LK)	<a href="#">See Feet &amp; Post Finish Options</a> 	<b>2a Feet Finish</b> <a href="#">See Feet Finish Options</a>	<b>2b Post Finish</b> <a href="#">See Post Finish Options</a> 	<b>C Casters - Standard (no upcharge)</b> - BL Black      - WG White w/Grey Wheels 

LK-TBF-TT29-3072						
LK	TBA	TT	29	3072		
LOK	T-Base Adjustable	Rectangular Top Shape	Height	Used on 30" x 72" Tops		

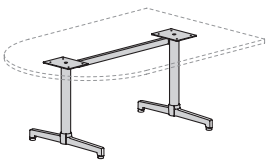
Description	D	W	H	CTN WT	CU FT	① Model	List Price
	30	60	29	28	8	LK-TBF-BU29-3060	\$657
	36	60	29	29	8	LK-TBF-BU29-3660	\$697
	30	66	29	28	8	LK-TBF-BU29-3066	\$657
	36	66	29	29	8	LK-TBF-BU29-3666	\$697
	30	72	29	29	8	LK-TBF-BU29-3072	\$669
	36	72	29	29	8	LK-TBF-BU29-3672	\$709
	48	72	29	29	8	LK-TBF-BU29-4872	\$709

**Features:**

- bases include all necessary top support and field assembly hardware

**Options:**

- specify metal finish, see below for options and two-tone capabilities
- specify Glide (G) or Caster(C) - choice of Black(BL) or White/Grey (WG) Caster; add \$47 list for casters

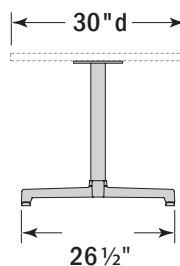

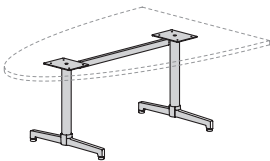
Description	D	W	H	CTN WT	CU FT	① Model	List Price
	30	60	29	28	8	LK-TBF-HV29-3060	\$657
	36	60	29	29	8	LK-TBF-HV29-3660	\$697
	30	66	29	28	8	LK-TBF-HV29-3066	\$657
	36	66	29	29	8	LK-TBF-HV29-3666	\$697
	30	72	29	29	8	LK-TBF-HV29-3072	\$669
	36	72	29	29	8	LK-TBF-HV29-3672	\$697
	48	72	29	29	8	LK-TBF-HV29-4872	\$697

**Features:**



- specify metal finish, see below for options and two-tone capabilities

**Options:**

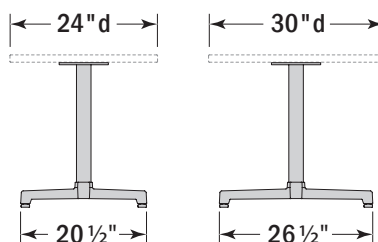
- specify metal finish, see below for options and two-tone capabilities
- specify Glide (G) or Caster(C) - choice of Black(BL) or White/Grey (WG) Caster; add \$47 list for casters

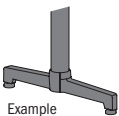
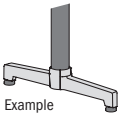

**To Order Specify**

① Model #	② Feet & Post Finish	Dual Finish	③ Glides or Casters
Lok (LK)	<a href="#">See Feet &amp; Post Finish Options</a>  Example	2a Feet Finish <a href="#">See Feet Finish Options</a> 2b Post Finish <a href="#">See Post Finish Options</a>  Example	G Glides  Standard (no upcharge) C Casters - BL Black +\$47 - WG White w/Grey Wheels +\$47 

LK-TBF-TT29-3072					
LK	TBF	TT	29	3072	
LOK	T-Base Fixed	Rectangular Top Shape	Height	Used on 30" x 72" Tops	

Description	D	W	H	CTN WT	CU FT	① Model	List Price
Fixed T Base for Huddle Top	30	72	29	45	9	LK-TBF-HU29-3072	\$1,091
	36	84	29	45	9	LK-TBF-HU29-3684	\$1,091

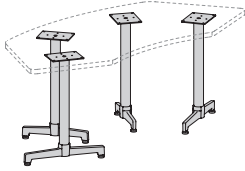

**Features:**

- bases include all necessary top support and field assembly hardware

**Options:**

- specify metal finish, see below for options and two-tone capabilities
- specify Glide (G) or Caster(C) - choice of Black(BL) or White/Grey (WG) Caster; add \$90 list for casters

Fixed T Base for One-twenty Top	42	72	29	33	7	LK-TBF-YG29-4272	\$794
	45	84	29	33	7	LK-TBF-YG29-4584	\$794

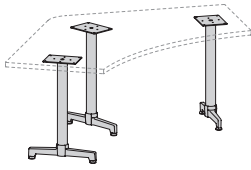

**Features:**

- bases include all necessary top support and field assembly hardware

**Options:**

- specify metal finish, see below for options and two-tone capabilities
- specify Glide (G) or Caster(C) - choice of Black(BL) or White/Grey (WG) Caster; add \$67 list for casters

Fixed T Base for Intersect Top	24	60	29	35	8	LK-TBF-IN29-2460	\$837
	30	60	29	35	8	LK-TBF-IN29-3060	\$837

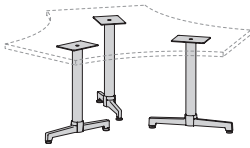

**Features:**

- bases include all necessary top support and field assembly hardware

**Options:**

- specify metal finish, see below for options and two-tone capabilities
- specify Glide (G) or Caster(C) - choice of Black(BL) or White/Grey (WG) Caster; add \$67 list for casters

**To Order Specify**

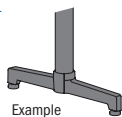
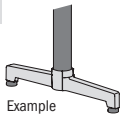
① Model #	② Feet & Post Finish	Dual Finish	
Lok (LK)	<a href="#">See Feet &amp; Post Finish Options</a>  <p>Example</p>	<b>2a Feet Finish</b> <a href="#">See Feet Finish Options</a>	<b>2b Post Finish</b> <a href="#">See Post Finish Options</a>  <p>Example</p>

LK-TBF-TT29-3072					
LK	TBA	TT	29	3072	
LOK	T-Base Adjustable	Rectangular Top Shape	Height	Used on 30" x 72" Tops	

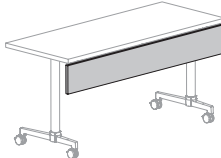
Description	D	W	H	CTN WT	CU FT	① Model	TFL	Standard	Graded In
								HPL 1	HPL 2
 Fixed Laminate Modesty Panel	¾	26	8	10	2	LK-MPF-26T	\$177		
	¾	26	8	10	2	LK-MPF-26H		\$263	\$270
	¾	30	8	10	2	LK-MPF-30T	\$180		
	¾	30	8	10	2	LK-MPF-30H		\$264	\$272
	¾	36	8	10	2	LK-MPF-36T	\$183		
	¾	36	8	10	2	LK-MPF-36H		\$266	\$276
	¾	42	8	10	3	LK-MPF-42T	\$189		
	¾	42	8	10	3	LK-MPF-42H		\$280	\$292
	¾	48	8	10	3	LK-MPF-48T	\$192		
	¾	48	8	10	3	LK-MPF-48H		\$282	\$295
	¾	60	8	11	3	LK-MPF-60T	\$216		
	¾	60	8	11	3	LK-MPF-60H		\$318	\$333
	¾	66	8	12	3	LK-MPF-66T	\$222		
	¾	66	8	12	3	LK-MPF-66H		\$327	\$343
	¾	72	8	12	4	LK-MPF-72T	\$225		
	¾	72	8	12	4	LK-MPF-72H		\$337	\$352
	¾	84	8	14	4	LK-MPF-84T	\$234		
	¾	84	8	14	4	LK-MPF-84H		\$357	\$375
	¾	96	8	15	5	LK-MPF-96T	\$242		
	¾	96	8	15	5	LK-MPF-96H		\$374	\$397

**Features:**

- not intended to be used on a table with tilt bases.

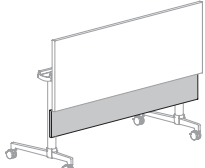
Description	D	W	H	CTN WT	CU FT	① Model	TFL	Standard	Graded In
								HPL 1	HPL 2
 Hinged Laminate Modesty Panel	¾	26	8	10	2	LK-MPH-26T	\$220		
	¾	26	8	10	2	LK-MPH-26H		\$302	\$311
	¾	30	8	10	2	LK-MPH-30T	\$222		
	¾	30	8	10	2	LK-MPH-30H		\$303	\$312
	¾	36	8	10	2	LK-MPH-36T	\$223		
	¾	36	8	10	2	LK-MPH-36H		\$305	\$315
	¾	48	8	10	3	LK-MPH-48T	\$231		
	¾	48	8	10	3	LK-MPH-48H		\$323	\$335
	¾	60	8	11	3	LK-MPH-60T	\$268		
	¾	60	8	11	3	LK-MPH-60H		\$371	\$385
	¾	66	8	12	3	LK-MPH-66T	\$273		
	¾	66	8	12	3	LK-MPH-66H		\$381	\$395
	¾	72	8	12	4	LK-MPH-72T	\$278		
	¾	72	8	12	4	LK-MPH-72H		\$389	\$407
	¾	84	8	14	4	LK-MPH-84T	\$287		
	¾	84	8	14	4	LK-MPH-84H		\$409	\$429
	¾	96	8	15	5	LK-MPH-96T	\$296		
	¾	96	8	15	5	LK-MPH-96H		\$429	\$452

**Features:**

- not intended to be used on a table with fixed bases.
- magnetic hinge holds modesty panel in vertical position
- magnetic hinge releases for self-storage when table is tilted

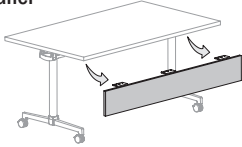
Description	D	W	H	CTN WT	CU FT	① Model	TFL	Standard	Graded In
								HPL 1	HPL 2
Removable Laminate Modesty Panel 	¾	26	8	10	2	LK-MPR-26T	\$220		
	¾	26	8	10	2	LK-MPR-26H		\$303	\$312
	¾	30	8	10	2	LK-MPR-30T	\$222		
	¾	30	8	10	2	LK-MPR-30H		\$304	\$313
	¾	36	8	10	2	LK-MPR-36T	\$224		
	¾	36	8	10	2	LK-MPR-36H		\$306	\$317
	¾	42	8	10	3	LK-MPR-42T	\$230		
	¾	42	8	10	3	LK-MPR-42H		\$322	\$334
	¾	48	8	10	3	LK-MPR-48T	\$232		
	¾	48	8	10	3	LK-MPR-48H		\$324	\$336
	¾	60	8	11	3	LK-MPR-60T	\$278		
	¾	60	8	11	3	LK-MPR-60H		\$380	\$393
	¾	66	8	12	3	LK-MPR-66T	\$282		
	¾	66	8	12	3	LK-MPR-66H		\$388	\$405
	¾	72	8	12	4	LK-MPR-72T	\$287		
	¾	72	8	12	4	LK-MPR-72H		\$398	\$416
	¾	84	8	14	4	LK-MPR-84T	\$296		
	¾	84	8	14	4	LK-MPR-84H		\$418	\$437
	¾	96	8	15	5	LK-MPR-96T	\$303		
	¾	96	8	15	5	LK-MPR-96H		\$435	\$459

**Features:**

- when selecting removable modesty panels on a tilt training table, modesty must be removed prior to tilting

**To Order Specify**

① Model #	②a Laminate Selection	②b PVC Edge Color
Model (LK)	<a href="#">See Laminate Selection</a>	<a href="#">See PVC Edge Color Options</a>

**Model Number Breakdown**

LK-MPF-48H				
LK	MPF	48	H	
LOK	Modesty Panel Fixed	48" Wide	HPL Laminate	

LOK - TRAINING

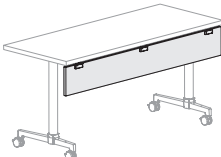
Description	D	W	H	CTN WT	CU FT	① Model	List Price
	¼	26	8	10	2	LK-MPF-26A	\$336
	¼	30	8	10	2	LK-MPF-30A	\$337
	¼	36	8	10	2	LK-MPF-36A	\$339
	¼	42	8	10	3	LK-MPF-42A	\$376
	¼	48	8	10	3	LK-MPF-48A	\$380
	¼	60	8	11	3	LK-MPF-60A	\$465
	¼	66	8	12	3	LK-MPF-66A	\$497
	¼	72	8	12	4	LK-MPF-72A	\$524
	¼	84	8	14	4	LK-MPF-84A	\$577
	¼	96	8	15	5	LK-MPF-96A	\$631

**Features:**

- not intended to be used on a table with tilt bases.

**Options:**

- specify trim cap; Matte Black (MBK), Pewter (PEW), Arctic Silver (ASL), Soft Nickel (SNK)

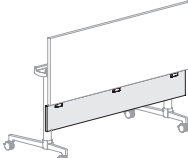
Description	D	W	H	CTN WT	CU FT	① Model	List Price
	¼	26	8	10	2	LK-MPH-26A	\$358
	¼	30	8	10	2	LK-MPH-30A	\$359
	¼	36	8	10	2	LK-MPH-36A	\$362
	¼	48	8	10	3	LK-MPH-48A	\$417
	¼	60	8	11	3	LK-MPH-60A	\$521
	¼	66	8	12	3	LK-MPH-66A	\$556
	¼	72	8	12	4	LK-MPH-72A	\$578
	¼	84	8	14	4	LK-MPH-84A	\$633
	¼	96	8	15	5	LK-MPH-96A	\$686

**Features:**

- not intended to be used on a table with fixed bases.
- magnetic hinge holds modesty panel in vertical position

**Options:**

- specify trim cap; Matte Black (MBK), Pewter (PEW), Arctic Silver (ASL), Soft Nickel (SNK)

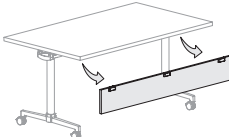
Description	D	W	H	CTN WT	CU FT	① Model	List Price
	¼	26	8	10	2	LK-MPR-26A	\$376
	¼	30	8	10	2	LK-MPR-30A	\$379
	¼	36	8	10	2	LK-MPR-36A	\$381
	¼	42	8	10	3	LK-MPR-42A	\$417
	¼	48	8	10	3	LK-MPR-48A	\$420
	¼	60	8	11	3	LK-MPR-60A	\$526
	¼	66	8	12	3	LK-MPR-66A	\$558
	¼	72	8	12	4	LK-MPR-72A	\$583
	¼	84	8	14	4	LK-MPR-84A	\$640
	¼	96	8	15	5	LK-MPR-96A	\$692

**Features:**

- when selecting removable modesty panels on a tilt training table, modesty must be removed prior to tilting

**Options:**

- specify trim cap; Matte Black (MBK), Pewter (PEW), Arctic Silver (ASL), Soft Nickel (SNK)

**To Order Specify**

① Model #	② Trim Cap Finish
Lok (LK)	<a href="#">See Trim Cap Finish Options</a> 

**Model Number Breakdown**

LK-MPF-48A				
LK	MPF	48	A	
LOK	Modesty Panel Fixed	48" Wide	Acrylic	

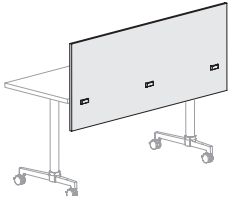
Description	D	W	H	CTN WT	CU FT	① Model	List Price
 Acoustic Privacy Screen	½	20	23 ¾	10	2	LK-PSP-2024P	\$427
	½	24	23 ¾	10	2	LK-PSP-2424P	\$473
	½	30	23 ¾	10	2	LK-PSP-3024P	\$554
	½	36	23 ¾	10	4	LK-PSP-3624P	\$561
	½	42	23 ¾	10	4	LK-PSP-4224P	\$728
	½	48	23 ¾	10	5	LK-PSP-4824P	\$735
	½	60	23 ¾	10	6	LK-PSP-6024P	\$1,252
	½	66	23 ¾	10	7	LK-PSP-6624P	\$1,255
	½	72	23 ¾	10	7	LK-PSP-7224P	\$1,260
	½	84	23 ¾	10	8	LK-PSP-8424P	\$1,268
½	96	23 ¾	10	9	LK-PSP-9624P	\$1,278	

**Features:**

- when adding privacy screen on tilting training table, privacy screen must be removed prior to tilting
- acoustic privacy screen can only be installed on straight edge of tables
- 13 ¾" height above surface

**Options:**

- specify Ash Grey (ASH) or Silver Grey (SIL)

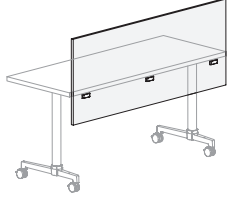
Description	D	W	H	CTN WT	CU FT	① Model	List Price
 Frosted Acrylic Privacy Screen	¼	20	23 ¾	10	3	LK-PSP-2024A	\$411
	¼	24	23 ¾	10	3	LK-PSP-2424A	\$452
	¼	30	23 ¾	10	3	LK-PSP-3024A	\$512
	¼	36	23 ¾	10	3	LK-PSP-3624A	\$573
	¼	42	23 ¾	10	4	LK-PSP-4224A	\$652
	¼	48	23 ¾	10	5	LK-PSP-4824A	\$696
	¼	60	23 ¾	10	6	LK-PSP-6024A	\$855
	¼	66	23 ¾	10	7	LK-PSP-6624A	\$914
	¼	72	23 ¾	10	7	LK-PSP-7224A	\$976
	¼	84	23 ¾	10	8	LK-PSP-8424A	\$1,101
¼	96	23 ¾	10	9	LK-PSP-9624A	\$1,225	

**Features:**

- when adding privacy screen on tilting training table, privacy screen must be removed prior to tilting
- acrylic privacy screen can be installed on rectangular, crescent or lecture tables
- 13 ¾" height above surface

**Options:**

- specify trim cap; Matte Black (MBK), Pewter (PEW), Arctic Silver (ASL)

**Model Number Breakdown**

LK-PSP-4824A					
LK	PSP	48	24	A	
LOK	Privacy Screen Panel	48" Wide	24" Height	Acrylic	

Description	D	W	H	CTN WT	CU FT	① Model	List Price
Acoustic Portable Slide On Screen	1	24	21½	10	2	GP-PSO-2422P	\$873
	1	28	29½	14	3	GP-PSO-2830P	\$1,151

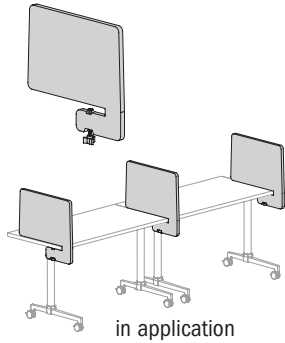

**Features:**

- works with any surface material
- works in any location, with the exception of where tilt release paddle is located on tilting tables
- GP-PSO-2422P - 16" height above surface; GP-PSO-2830P - 24" height above surface
- GP-PSO-2830P - not for use with surfaces 20" depth

**Options:**

- Specify Ash Grey (ASH) or Silver Grey (SIL)

Markerboard Portable Slide On Screen	1	28	29½	26	3	GP-PSO-2830MB	\$1,005
---	---	----	-----	----	---	---------------	---------

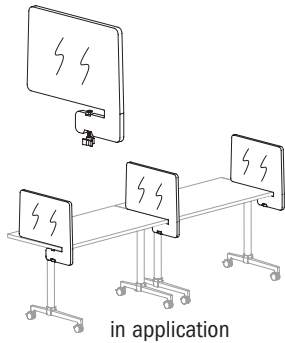

**Features:**

- works with any surface material
- works in any location, with the exception of where tilt release paddle is located on tilting tables
- not for use with surfaces 20" depth
- white marker laminate surfaces with white PVC edges
- 24" height above surface

**Model Number Breakdown**

GP-PSO-2830MB						
GP	PSO	28	30	MB		
General Product	Portable Screen On	28" Wide	30" Height	Markerboard		

Description	D	W	H	CTN WT	CU FT	❶ Model	List Price
HPL Portable Slide On Screen	1	28	29½	26	3	GP-PSO-2830H	\$1,059

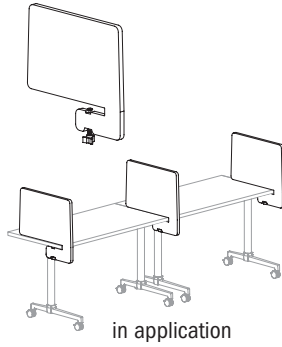

**Features:**

- works with any surface material
- works in any location, with the exception of where tilt release paddle is located on tilting tables
- 24" height above surface
- not for use with surfaces 20" depth

**Options:**

- specify standard JSI laminates with matching PVC edges, [see page 5](#)

**Model Number Breakdown**

GP-PSO-2830H					
GP	PSO	28	30	H	
General Product	Portable Screen On	28" Wide	30" Height	HPL	

LOK - TRAINING

Description	D	W	H	CTN WT	CU FT	① Model	TFL	Standard HPL 1
Rounded Arc Rectangular	26	66	42	51	38	LK-29IRL0-2666RT	\$2,439	\$2,613
Instructor Mobile Station Left with T Base	26	66	42	51	38	LK-29IRRO-2666RT	\$2,439	\$2,613
	26	66	42	51	38	LK-29IRL7-2666RT	\$2,604	\$2,777
	26	66	42	51	38	LK-29IRR7-2666RT	\$2,604	\$2,777
	26	72	42	56	41	LK-29IRL0-2672RT	\$2,453	\$2,636
	26	72	42	56	41	LK-29IRRO-2672RT	\$2,453	\$2,636
	26	72	42	56	41	LK-29IRL7-2672RT	\$2,617	\$2,801
	26	72	42	56	41	LK-29IRR7-2672RT	\$2,617	\$2,801

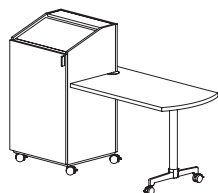
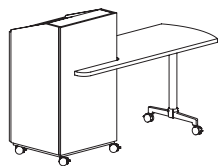

LK-29IRL7-2666RT  
(door unit, left)

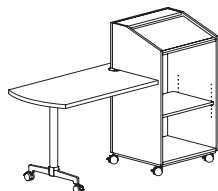

LK-29IRRO-2666RT  
(open unit, right)

**Features:**

- price reflects complete station
- ships KD in multiple cartons
- one adjustable shelf in podium
- cable routing opening at back of podium slanted surface
- wire access grommets in surface of top, as well as side and bottom panel of podium
- hand of model dictates what side the podium is located from user side
- models ending in OT have open compartment, models ending in 7T have a door.
- table surface is at 29" high
- contact customer service for graded in HPL on worksurface pricing
- podium is always TFL

**Options:**

- order 48" fixed or removable modesty panel separately
- specify Podium grommet; None (GN) or tablet and cup holder grommets (GY) add \$101 list
- specify power option; see below

**Laminate Tops "LKT" Models**

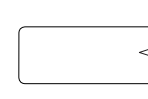

Eased Edge (R3)

**To Order Specify**

① Model #	②a Laminate Selection	②b PVC Edge Color	③ Grommet
Model (LK)	<a href="#">See Laminate Selection</a>	<a href="#">See PVC Edge Color Options</a>	GN No Grommet
			GY Tablet and Cup Holder Grommet
			④ Electrical
			N No Cutout
			CTEC23-CO EC23 - Cut Out Center of Top
			CTEC24-CO EC24 - Cut Out Center of Top
			⑤ Caster
			C Caster
			- BL Black Caster
			- WG White Caster w/ Grey Wheels
			⑥ Metal Finish
			<a href="#">See Metal Finish Color Options</a>

**Model Number Breakdown**

LK-29IRL0-2672RT								
LK	29	IR	L	0	26	72	R	T
LOK	Height	Rectangular Instructor Top	Left	Open Compartment	Depth	Wide	Rounded Arc	Laminate

Description	D	W	H	CTN WT	CU FT	① Model	TFL	Standard HPL 1
Interactive Instructor Mobile Station Left with T Base	31	66	42	52	44	LK-29IIL0-3166T	\$2,528	\$2,677
	31	66	42	52	44	LK-29IIR0-3166T	\$2,528	\$2,677
	31	66	42	52	44	LK-29IIL7-3166T	\$2,693	\$2,842
	31	66	42	52	44	LK-29IIR7-3166T	\$2,693	\$2,842
	31	72	42	57	48	LK-29IIL0-3172T	\$2,542	\$2,705
	31	72	42	57	48	LK-29IIR0-3172T	\$2,542	\$2,705
	31	72	42	57	48	LK-29IIL7-3172T	\$2,707	\$2,869
	31	72	42	57	48	LK-29IIR7-3172T	\$2,707	\$2,869

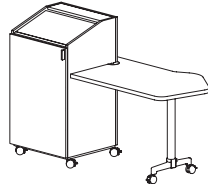
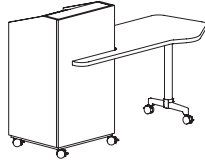

LK-29IIL7-3166T (door unit, left)

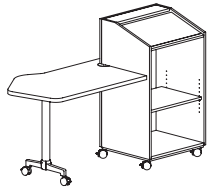

LK-29IIR0-3166T (open unit, right)

**Features:**

- price reflects complete station
- ships KD in multiple cartons
- one adjustable shelf in podium
- cable routing opening at back of podium slanted surface
- wire access grommets in surface of top, as well as side and bottom panel of podium
- hand of model dictates what side the podium is located from user side
- models ending in OT have open compartment, models ending in 7T have a door.
- table surface is at 29" high
- contact customer service for graded in HPL on worksurface pricing
- podium is always TFL

**Options:**

- order 48" fixed or removable modesty panel separately
- specify Podium grommet; None (GN) or tablet and cup holder grommets (GY) add \$101 list
- specify power option; see below

**Laminate Tops "LKT" Models**

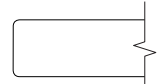

Eased Edge (R3)

**To Order Specify**

① Model #	②a Laminate Selection	②b PVC Edge Color	③ Grommet
Model (LK)	<a href="#">See Laminate Selection</a>	<a href="#">See PVC Edge Color Options</a>	<p>GN No Grommet GY Tablet and Cup Holder Grommet</p> <p><b>④ Electrical</b></p> <p>N No Cutout CTEC23-CO EC23 - Cut Out Center of Top CTEC24-CO EC24 - Cut Out Center of Top</p> <p><b>⑤ Caster</b></p> <p>C Caster - BL Black Caster - WG White Caster w/Grey Wheels</p> <p><b>⑥ Metal Finish</b></p> <p><a href="#">See Metal Finish Color Options</a></p>

**Model Number Breakdown**

LK-29IIL0-3172T							
LK	29	II	L	7	26	72	T
LOK	Height	Interactive Instructor Top	Left	Door Unit	Depth	Wide	Laminate

Description	D	W	H	CTN WT	CU FT	① Model	List Price
Mobile Podium Open	22	24	42	18	19	LK-PDO-2224	\$1,654
	22	24	42	18	19	LK-PDL-2224	\$1,818
	22	24	42	18	19	LK-PDR-2224	\$1,818

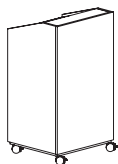

**Features:**

- one adjustable shelf
- wire access grommet in bottom panel
- cable routing opening at back of slanted surface

**Options:**

- specify grommet; None (GN) or tablet and cup holder grommets (GY) add \$101 list
- specify caster color option, Black (BL) or White with Grey Wheels (WG)

LOK - TRAINING

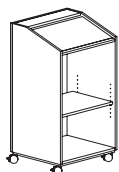

LK-PDO-2224  
(open unit)

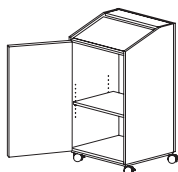

LK-PDR-2224  
(door unit, right)

Description	D	W	H	CTN WT	CU FT	① Model	TFL	Standard	Graded In
								HPL 1	HPL 2
Adjustable Mobile Stand	22	24	29	36	14	LK-29ISA-2224T	\$1,878	\$1,987	\$2,001

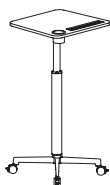

**Features:**

- pneumatic height adjustment range 29" - 41"
- inner column of adjustable table base will be silver

**Options:**

- specify caster color option, Black (BL) or White with Grey Wheels (WG)
- specify grommet; None (GN) or tablet and cup holder grommets (GY) add \$101 list

**To Order Specify**

① Model #	② Chasis	③ Grommet	④ Caster	⑤ Metal Finish
Model (LK)	<a href="#">See Laminate Selection</a>	GN No Grommet GY Tablet and Cup Holder Grommet	C Caster - BL Black Caster - WG White Caster w/Grey Wheels	<a href="#">See Metal Finish Color Options</a>

**Model Number Breakdown**

LK-PDL-2224					
LK	PD	L	22	24	
Lok	Podium	Left	22" Depth	24" Wide	

Description	D	W	H	CTN WT	CU FT	① Model	List Price
Marker Board Mobile Screen	27	36	72	75	13	LKB-MS-3672M	\$1,824
	27	48	72	95	16	LKB-MS-4872M	\$2,070

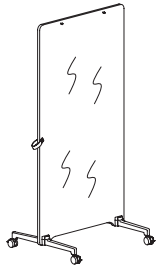

**Features:**

- marker board HPL on both surfaces
- capable for hanging flip charts on both sides

**Options:**

- specify caster color option, Black (BL) or White caster with Grey (WG)

Mobile Laminate Screen	27	36	72	75	13	LKB-MS-3672T	\$1,199
	27	48	72	95	16	LKB-MS-4872T	\$1,262

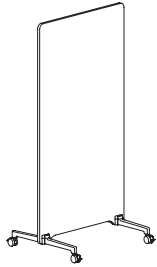

**Features:**

- laminate on both surfaces, [see page 5](#)

**Options:**

- specify caster color option, Black (BL) or White caster with Grey (WG)

Fixed Laminate Screen	27	36	72	75	13	LKB-FS-3672T	\$1,076
	27	48	72	95	16	LKB-FS-4872T	\$1,146

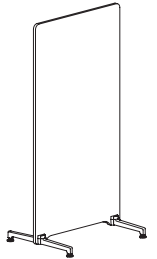

**Features:**

- laminate on both surfaces, [see page 5](#)
- black leveling glides

**Model Number Breakdown**

LKB-MS-3672M						
LKB	MS	36	72	M		
Lok	Mobile Screen	36" Wide	72" Height	Markerboard		

ECONO Power

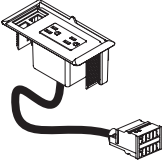
Description	D	W	H	CTN WT	CU FT	① Model	List Price
	36			4	1	EC-E-CT1-36	\$294
	48			4	1	EC-E-CT1-48	\$300
	60			4	1	EC-E-CT1-60	\$302
	66			4	1	EC-E-CT1-66	\$306
	72			5	1	EC-E-CT1-72	\$308
	84			5	1	EC-E-CT1-84	\$321
	96			5	1	EC-E-CT1-96	\$324

cables included:  
1 male-to-male



Features:

- (1) econo electrical unit to be placed in top of surface
- use in conjunction with other econo electrical items
- table link bracket MUST be used in conjunction with electrical to meet code requirements
- data jack openings only accepts Type 2 jacks - two .58 x .76 hole openings (customer supplied)
- must order power infeed separately

	66			7	1	EC-E-LRT2-66	\$585
	72			7	1	EC-E-LRT2-72	\$585
	84			8	1	EC-E-LRT2-84	\$585
	96			8	1	EC-E-LRT2-96	\$589

cables included:  
2 male-to-male

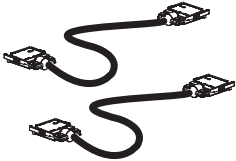

Features:

- (2) econo electrical unit to be placed in top of surface
- use in conjunction with other econo electrical items
- data jack openings accepts Type 2 jacks - two .58 x .76 hole openings (customer supplied)
- must order power infeed separately

Options:

- specify color black (BL) or grey (SG)

3 Prong Plug - 110 Power Smart-box Infeed for Econo System				1	1	EC-PI-E-72A	\$574
--	--	--	--	---	---	-------------	-------

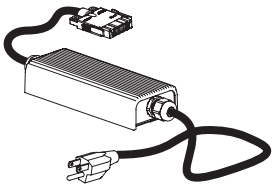

Features:

- 72" plug power infeed
- 20 amps/110 volts max
- 3 prong plug - 15 amp adapter plug
- single circuit use only
- use in conjunction with other econo electrical items

Electrical Jumper for Econo System	84			3	1	EC-E-J-84	\$140
------------------------------------	----	--	--	---	---	-----------	-------



Features:

- use to jump power around a corner configuration
- one male and one female H-block cable end

male

female

Data Jacks for ECONO

Description	D	W	H	CTN WT	CU FT	① Model	List Price
Telecom Phone Jack - Type 2				1	1	TCP201	\$76

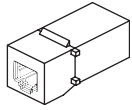

- Features:**
- RJ-11 phone jack
  - for use with Econo system

Telecom Data Jack - Type 2				1	1	TCP202	\$99
----------------------------	--	--	--	---	---	--------	------

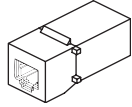

- Features:**
- CAT6-RJ45 data jack
  - for use with Econo system

TCP201 and TCP202 telecom jacks to be used with ECONO system

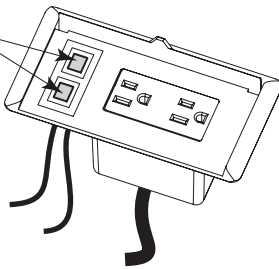

Corded Power

Description	D	W	H	CTN WT	CU FT	① Model	List Price
Moire Power Unit	3 3/8	3 3/8	2	5	1	EC23	\$532

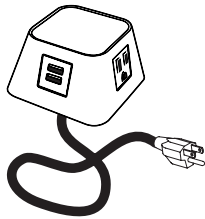

- Features:**
- three 110 outlets
  - dual USB-A charging ports
  - 72" 3-prong - 15amp plug power feed
  - 15amp/110 volt

- Options:**
- specify Black(BL) or White(WH)

Node Power Unit	3 3/8	3 3/8	3/8	5	1	EC24	\$425
-----------------	-------	-------	-----	---	---	------	-------

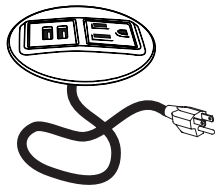

- Features:**
- one 110 outlet
  - dual USB-A charging ports
  - 72" 3-prong - 15amp plug power feed
  - 15amp/110 volt

- Options:**
- specify Black(BL) or White(WH)

Power Strip	1 1/2	1 7/8	8	3	1	GP9ACP1-0212	\$103
-------------	-------	-------	---	---	---	--------------	-------

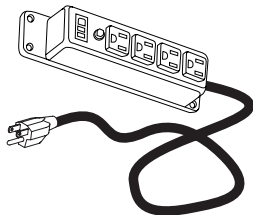

- Features:**
- power surge with 10" cord
  - four electrical outlets
  - includes switch
  - field installed
  - use in conjunction with other econo electrical items

LINK Power

Description	D	W	H	CTN WT	CU FT	① Model	List Price
Electrical CT1 for Link	36			4	1	EC-L-CT1-36	\$650
	48			4	1	EC-L-CT1-48	\$661
	60			4	1	EC-L-CT1-60	\$675
	66			4	1	EC-L-CT1-66	\$680
	72			5	1	EC-L-CT1-72	\$686
	84			5	1	EC-L-CT1-84	\$700
	96			5	1	EC-L-CT1-96	\$713

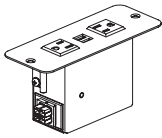

cables included:  
1 female-to-female  
1 male-to-female

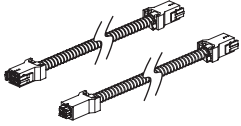

Features:

- (1) link electrical unit to be placed in top of surface
- use in conjunction with other link electrical items
- table link bracket MUST be used in conjunction with electrical to meet code requirements

Options:

- specify circuit (C1 or C2); specify color black (BL) or white (WH)
- must order power infeed separately

Electrical LRT2 for Link	66			7	1	EC-L-LRT2-66	\$1,191
	72			7	1	EC-L-LRT2-72	\$1,186
	84			8	1	EC-L-LRT2-84	\$1,197
	96			8	1	EC-L-LRT2-96	\$1,211

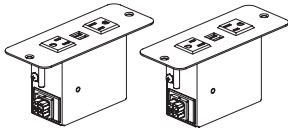

cables included:  
2 female-to-female  
1 male-to-female

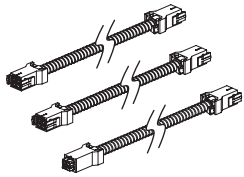

Features:

- (2) link electrical unit to be placed in top of surface
- use in conjunction with other link electrical items
- circuit 1 - 8 units can be connected on 3 prong infeed
- circuit 1 & 2 - 16 units (8) circuit 1 & (8) circuit 2 on hardwire or quick disconnect infeed options

Options:

- specify circuit (C1 or C2); specify color black (BL) or white (WH)
- must order power infeed separately

3 Prong Plug - 110 Power Infeed for Link System	72			1	1	EC-PI-L-72-A	\$301
---	----	--	--	---	---	--------------	-------

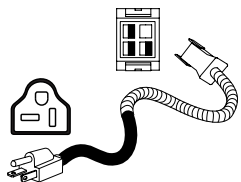

plug included:  
15 amp adapter

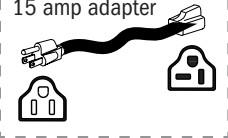

Features:

- 72" plug power infeed
- 20 amps/110 volts max
- 3 prong plug - 15 amp adapter plug
- single circuit use only
- use in conjunction with other link electrical items

Quick Disconnect Power Infeed for Link System				1	1	EC-PI-L-72-QD	\$252
---	--	--	--	---	---	---------------	-------

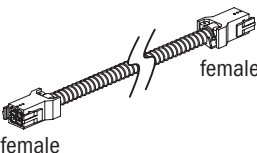

Features:

- must be used with QD1
- 72" modular power infeed
- 20 amps/120 volts max
- works for both single or double circuit
- use in conjunction with other link electrical items

LINK Power

Description	D	W	H	CTN WT	CU FT	❶ Model	List Price
Quick Disconnect Wall Outlet for Link System				1	1	EC-L-QD1	\$129

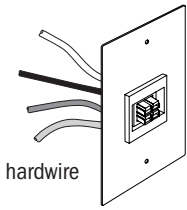

Features:

- must be used with MP72
- works for both single or double circuit
- 20 amps/120 volts max
- electrical contractor responsible for connection to building power source
- use in conjunction with other link electrical items

Hardwire Power Infeed for Link System	72			1	1	EC-PI-L-72-H	\$196
---------------------------------------	----	--	--	---	---	--------------	-------

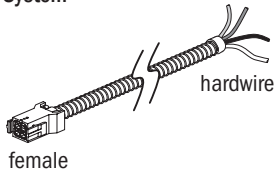

Features:

- 72" hardwire power infeed
- 20 amps/120 volts max
- single or two circuit
- electrical contractor responsible for connection to building power source
- use in conjunction with other link electrical items

Electrical Jumper for Link System	12			2	1	EC-L-J-12	\$125
-----------------------------------	----	--	--	---	---	-----------	-------

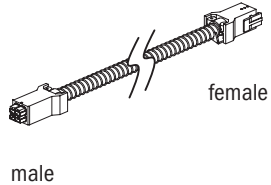

Features:

- use to jump power around a corner configuration
- use with Link EC-L-3W 3 way electrical connector when additional cable is required
- one male and one female cable end

3 way electrical connector for Link System				1	1	EC-L-3W	\$200
--	--	--	--	---	---	---------	-------

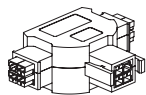

Features:

- branches power for infeed or T-connection
- two male and one female connector plugs
- may require repositioning of jumper cables

Wire Management

Description	D	W	H	CTN WT	CU FT	① Model	List Price
Vertical Wire Manager	2	2 ¼	17	1	1	AVL17	\$90
	2	2 ¼	22	1	1	AVL20	\$95
	2	2 ¼	25	1	1	AVL25	\$117

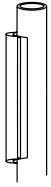

**Features:**

- field installed
- use AVL17 for 29" h tables
- use AVL20 for 36" h tables
- use AVL25 for 42" h tables

**Options:**

- specify plastic color, Black (B) or Silver (S)

Flexible Vertical Wire Manager	1 ½	1 ½	45	4	1	45VWM	\$146
--------------------------------	-----	-----	----	---	---	-------	-------



**Features:**

- black plastic
- field installed to bottom of table top, with screws provided
- wire manager is 1 ½" diameter
- weighted base is 4" diameter
- length can be adjusted by removing individual discs as required

Wire Management Velcro Straps	1 ¾	3 ½	¼	1	1	04WVS	\$63
-------------------------------	-----	-----	---	---	---	-------	------

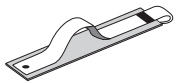

**Features:**

- black, set of 4
- field installed to bottom of table top, with adhesive tape provided

Cable Management Clips	2 ⅝	3 ¾	1 ⅝	1	1	0304CMC	\$61
------------------------	-----	-----	-----	---	---	---------	------

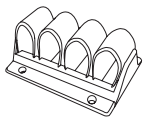

**Features:**

- black plastic
- installed to bottom of table top
- four retention loops

Wire Manager Trough	2 ½	12	2 ½	2	1	12WCT	\$132
	2 ½	24	2 ½	3	1	24WCT	\$154
	2 ½	36	2 ½	4	1	36WCT	\$169

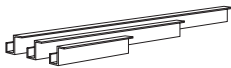

**Features:**

- black plastic
- field installed to bottom of table top, with screws provided

Wire Management Tray	7 ½	25	3	4	1	GP9WMT1-0825	\$205
	7 ½	35	3	6	1	GP9WMT1-0835	\$253
	7 ½	45	3	8	2	GP9WMT1-0845	\$300

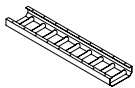

**Features:**

- silver powder-coated finish
- four hanging brackets (CI2C00)

Description	D	W	H	CTN WT	CU FT	① Model	List Price
Table Link Bracket	2 ¾	3	7	1	1	LKB03TBL-LINK	\$66

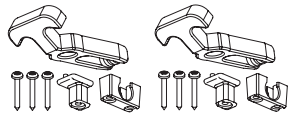

**Features:**

- includes set of 2 brackets with attachment hardware
- can be installed on ends and approach edges of tables
- field installed
- MUST be used tables specifying electrical

Screen Link Bracket	1 ¾	2 ¾	1 ½	1	1	LKB03SCN-LINK	\$81
---------------------	-----	-----	-----	---	---	---------------	------

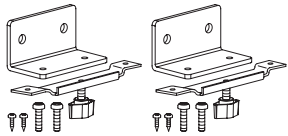

**Features:**

- links two tables along one edge with screen between tables
- set of 2 with attachment hardware
- field installed

Floor Mount Glide	3	2 ¼	½	1	1	LKB38-16ANCHOR	\$45
-------------------	---	-----	---	---	---	----------------	------

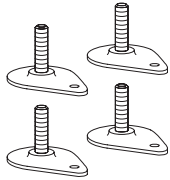

**Features:**

- field installed glides for mounting table base to floor
- ¼" diameter hole in the glide for mounting
- set of 4
- replaces standard leveling glide
- note: floor mounting hardware to be supplied by installer

Single Monitor Arm	4	11	10	9	1	GP5901MA	\$761
--------------------	---	----	----	---	---	----------	-------

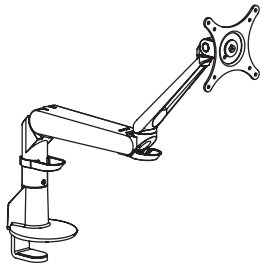

**Features:**

- one-touch reposition monitor adjustment
- tension adjustment at each joint
- flat panel mount rotates for portrait or landscape viewing
- edge mount installation from above surface
- cable management routes cables below monitor arm
- quick install VESA mount adapter

**Options:**

- specify Black (B) or Silver (S)

**Accessories/ Keyboard/ Tasklights**

For an additional list of electrical units, grommets, keyboards, wire management, monitor arms & telecom jacks, please see our [accessories price list](#)

Contact your customer service representative for specific questions regarding which units can be used with Lok Training.

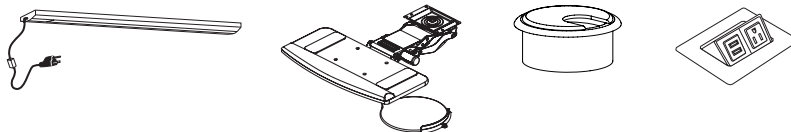

Page left intentionally blank



Training



Teamwork



Conference



Lounge

LOK - TEAMWORK

**Lok - Teamwork**

**Product Information**

Teamwork Overview . . . . . 86  
 Tables Shapes & Sizes . . . . . 88-91  
 Laminate Specifications . . . . . 92  
 Veneer Specifications . . . . . 93  
 Base Styles - Features . . . . . 94  
 Electrical Planning - Options . . . . . 95

**Pricing Pages**

Teamwork Tables at Working Height . . . 96-129  
 Teamwork Tables at Counter Height . . . 130-133  
 Teamwork Tables at Bar Height . . . . 134-167  
 Electrical . . . . . 168-169

## Teamwork - Overview



**rectangular**  
29"H - Pages 68, 72  
36"H - Pages 116, 120  
42"H - Pages 164, 168



**rounded rectangular**  
29"H - Pages 70, 74  
36"H - Pages 118, 122  
42"H - Pages 166, 170



**arc rectangular**  
29"H - Pages 76  
36"H - Pages 124  
42"H - Pages 172



**rounded arc rectangular**  
29"H - Pages 78  
36"H - Pages 126  
42"H - Pages 174



**racetrack**  
29"H - Pages 80  
36"H - Pages 128  
42"H - Pages 176

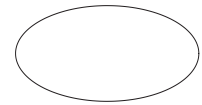

**oval**  
29"H - Pages 82  
36"H - Pages 130  
42"H - Pages 178

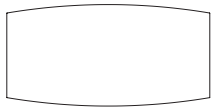

**boat**  
29"H - Pages 84  
36"H - Pages 132  
42"H - Pages 180

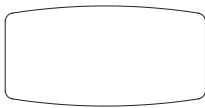

**rounded boat**  
29"H - Pages 86  
36"H - Pages 134  
42"H - Pages 182

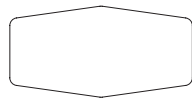

**rounded double chevron**  
29"H - Pages 88  
36"H - Pages 136  
42"H - Pages 184

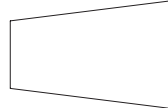

**taper**  
29"H - Pages 90  
36"H - Pages 138  
42"H - Pages 186

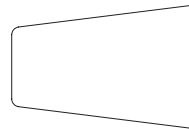

**rounded taper**  
29"H - Pages 92  
36"H - Pages 138  
42"H - Pages 184

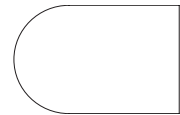

**bullet**  
29"H - Pages 94  
36"H - Pages 142  
42"H - Pages 190

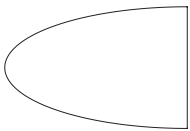

**hive**  
29"H - Pages 96  
36"H - Pages 144  
42"H - Pages 192

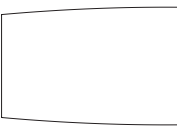

**wedge**  
29"H - Pages 112  
36"H - Pages 160  
42"H - Pages 208

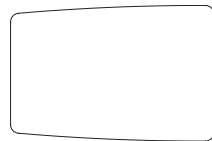

**rounded wedge**  
29"H - Pages 114  
36"H - Pages 162  
42"H - Pages 210

## Teamwork - Top Shapes

Lok offers 24 teamwork table top shapes. Tables are available in 29", 36" or 42" high and in laminate or veneer. Compatible bases are: T Base or X Base



rectangular

29"h

- 36" x 60" Seats 4
- 36" x 66" Seats 6
- 36" x 72" Seats 6
- 42" x 72" Seats 6
- 48" x 72" Seats 6

36"h

- 36" x 60" Seats 4
- 36" x 66" Seats 6
- 36" x 72" Seats 6
- 42" x 72" Seats 6
- 48" x 72" Seats 6

42"h

- 36" x 60" Seats 4
- 36" x 66" Seats 6
- 36" x 72" Seats 6
- 42" x 72" Seats 6
- 48" x 72" Seats 6



rounded rectangular

29"h

- 36" x 60" Seats 4
- 36" x 66" Seats 6
- 36" x 72" Seats 6
- 42" x 72" Seats 6
- 48" x 72" Seats 6

36"h

- 36" x 60" Seats 4
- 36" x 66" Seats 6
- 36" x 72" Seats 6
- 42" x 72" Seats 6
- 48" x 72" Seats 6

42"h

- 36" x 60" Seats 4
- 36" x 66" Seats 6
- 36" x 72" Seats 6
- 42" x 72" Seats 6
- 48" x 72" Seats 6



arc rectangular

29"h

- 36" x 60" Seats 4
- 36" x 66" Seats 6
- 36" x 72" Seats 6
- 42" x 72" Seats 6
- 48" x 72" Seats 6

36"h

- 36" x 60" Seats 4
- 36" x 66" Seats 6
- 36" x 72" Seats 6
- 42" x 72" Seats 6
- 48" x 72" Seats 6

42"h

- 36" x 60" Seats 4
- 36" x 66" Seats 6
- 36" x 72" Seats 6
- 42" x 72" Seats 6
- 48" x 72" Seats 6



rounded arc rectangular

29"h

- 36" x 60" Seats 4
- 36" x 66" Seats 6
- 36" x 72" Seats 6
- 42" x 72" Seats 6
- 48" x 72" Seats 6

36"h

- 36" x 60" Seats 4
- 36" x 66" Seats 6
- 36" x 72" Seats 6
- 42" x 72" Seats 6
- 48" x 72" Seats 6

42"h

- 36" x 60" Seats 4
- 36" x 66" Seats 6
- 36" x 72" Seats 6
- 42" x 72" Seats 6
- 48" x 72" Seats 6



racetrack

29"h

- 36" x 60" Seats 4
- 36" x 66" Seats 6
- 36" x 72" Seats 6
- 42" x 72" Seats 6
- 48" x 72" Seats 6

36"h

- 36" x 60" Seats 4
- 36" x 66" Seats 6
- 36" x 72" Seats 6
- 42" x 72" Seats 6
- 48" x 72" Seats 6

42"h

- 36" x 60" Seats 4
- 36" x 66" Seats 6
- 36" x 72" Seats 6
- 42" x 72" Seats 6
- 48" x 72" Seats 6

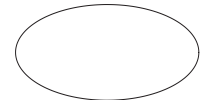

oval

29"h

- 36" x 72" Seats 6

36"h

- 36" x 72" Seats 6

42"h

- 36" x 72" Seats 6

## Teamwork - Top Shapes

Lok offers 24 teamwork table top shapes. Tables are available in 29", 36" or 42" high and in laminate or veneer. Compatible bases are: T Base or X Base

LOK - TEAMWORK

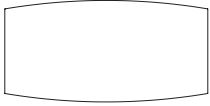

**boat**  
29"h  
36" x 60" Seats 4  
36" x 66" Seats 6  
36" x 72" Seats 6  
42" x 72" Seats 6  
48" x 72" Seats 6

36"h  
36" x 60" Seats 4  
36" x 66" Seats 6  
36" x 72" Seats 6  
42" x 72" Seats 6  
48" x 72" Seats 6

42"h  
36" x 60" Seats 4  
36" x 66" Seats 6  
36" x 72" Seats 6  
42" x 72" Seats 6  
48" x 72" Seats 6

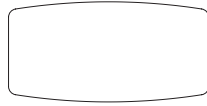

**rounded boat**  
29"h  
36" x 60" Seats 4  
36" x 66" Seats 6  
36" x 72" Seats 6  
42" x 72" Seats 6  
48" x 72" Seats 6

36"h  
36" x 60" Seats 4  
36" x 66" Seats 6  
36" x 72" Seats 6  
42" x 72" Seats 6  
48" x 72" Seats 6

42"h  
36" x 60" Seats 4  
36" x 66" Seats 6  
36" x 72" Seats 6  
42" x 72" Seats 6  
48" x 72" Seats 6

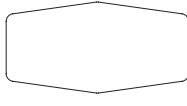

**rounded double chevron**  
29"h  
36" x 60" Seats 4  
36" x 72" Seats 6  
42" x 72" Seats 6  
48" x 72" Seats 6

36"h  
36" x 60" Seats 4  
36" x 72" Seats 6  
42" x 72" Seats 6  
48" x 72" Seats 6

42"h  
36" x 60" Seats 4  
36" x 72" Seats 6  
42" x 72" Seats 6  
48" x 72" Seats 6

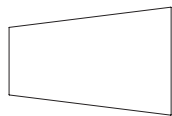

**taper**  
29"h  
48" x 72" Seats 6

36"h  
48" x 72" Seats 6

42"h  
48" x 72" Seats 6

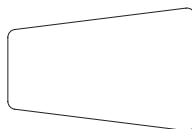

**rounded taper**  
29"h  
48" x 72" Seats 6

36"h  
48" x 72" Seats 6

42"h  
48" x 72" Seats 6

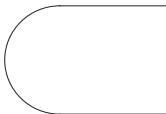

**bullet**  
29"h  
48" x 72" Seats 6

36"h  
48" x 72" Seats 6

42"h  
48" x 72" Seats 6

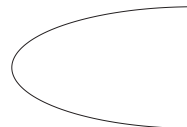

**hive**  
29"h  
48" x 72" Seats 6

36"h  
48" x 72" Seats 6

42"h  
48" x 72" Seats 6

## Teamwork - Top Shapes cont.

Lok offers 24 teamwork table top shapes. Tables are available in 29", 36" or 42" high and in laminate or veneer. Compatible bases are: T Base or X Base

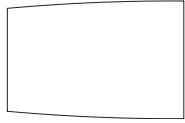

wedge

29"h

48" x 72" Seats 6

36"h

48" x 72" Seats 6

42"h

48" x 72" Seats 6

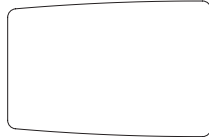

rounded wedge

29"h

48" x 72" Seats 6

36"h

48" x 72" Seats 6

42"h

48" x 72" Seats 6

## Teamwork - Materials

### Laminate Tops

HPL tops are 1 3/16" thick, 3 ply balanced construction. The laminate face is horizontal grade high pressure laminate. Particle board core and a phenolic backer sheet complete the balanced construction.

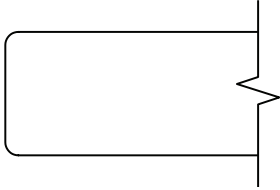

**Eased Edge (R3)**  
PVC

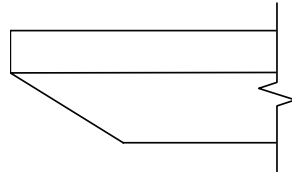

**Reverse Bevel (K9)**  
PVC on painted top of painted MDF

### Standard PVC Edge Colors

JSI supports 26 standard PVC edge colors listed below. These coordinate with our Standard (Tier1) Laminates.

When selecting a Standard (Tier 1) Laminate, the coordinating PVC edge color is automatically applied. When selecting a Graded-In Laminate (Tier 2), you will be prompted to choose one these 26 PVC edge colors to be applied to the edge.

<b>ALB</b> Alabaster	<b>MES</b> Mesa
<b>BEL</b> Belair	<b>MIN</b> Mineral
<b>BLK</b> Black	<b>MCH</b> Mocha
<b>BRK</b> Brickdust	<b>OBK</b> Outback
<b>BBL</b> Bridal Blanco	<b>PIL</b> Pilsner
<b>CSK</b> Cask	<b>PIN</b> Pinnacle Walnut
<b>CLY</b> Clay	<b>SHD</b> Shadow
<b>DWH</b> Designer White	<b>SLG</b> Slate Grey
<b>EGR</b> Egret	<b>UMB</b> Umber
<b>FAW</b> Fawn	<b>VAL</b> Valley
<b>FLN</b> Flint	<b>WAL</b> Walnut Heights
<b>FLO</b> Florence Walnut	<b>WEA</b> Weathered Ash
<b>LOF</b> Loft	<b>ZEN</b> Zen Grey

### Standard Laminates

JSI Standard Laminate program consists of 26 solid and wood grain patterns, and establish our Tier 1 laminate pricing. Each has a coordinating PVC edge color that is automatically used with the Standard Laminates.

#### Wood Grain Laminate

<b>BEL</b> Belair	<b>MIN</b> Mineral
<b>BRK</b> Brickdust	<b>MCH</b> Mocha
<b>CSK</b> Cask	<b>OBK</b> Outback
<b>CLY</b> Clay	<b>PIL</b> Pilsner
<b>EGR</b> Egret	<b>PIN</b> Pinnacle Walnut
<b>FAW</b> Fawn	<b>UMB</b> Umber
<b>FLN</b> Flint	<b>VAL</b> Valley
<b>FLO</b> Florence Walnut	<b>WLH</b> Walnut Heights
<b>LOF</b> Loft	<b>WEA</b> Weathered Ash
<b>MES</b> Mesa	

#### Solid Laminate

<b>ALB</b> Alabaster
<b>BLK</b> Black
<b>BBL</b> Bridal Blanco
<b>DWH</b> Designer White
<b>SHD</b> Shadow
<b>SLG</b> Slate Grey
<b>ZEN</b> Zen Grey

## Teamwork - Materials cont.

### Veneer Tops

Tops are 1 3/16" thick, 5-ply balanced construction with particle board core. Standard Tier 1 Essentials veneer is book matched for cherry, maple, walnut and black oak veneer. Standard Tier 2 veneer is Artisan.

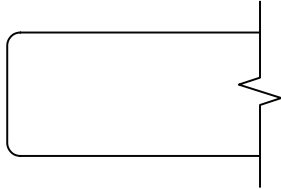

**Eased Edge (R3)**  
Internal Lumber Band

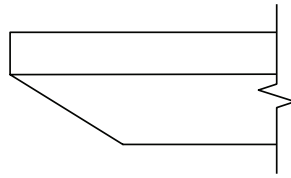

**Reverse Bevel (K9)**  
Veneer Band on Stained MDF

### Finish - Stain/Colors

#### ESS Essentials Veneer Collection

BRK	Brickdust	MIN	Mineral
CSK	Cask	MCH	Mocha
CLY	Clay	OBK	Outback
FAW	Fawn	PIL	Pilsner
FLX	Flax	SIE	Sienna
FLN	Flint	TRF	Truffle
LOF	Loft	UMB	Umber
MES	Mesa	VAL	Valley

#### ART Artisan Veneer Collection

BAR	Barrel	RAV	Raven
BUF	Buff	RYE	Rye
CND	Cinder	SAB	Sable
EGR	Egret	SAD	Saddle

#### Protective Top Coat

DuraTex™ offers exceptional hardness along with abrasion and impact resistance, it has been formulated to eliminate hazardous and harmful gases that are normally associated with wood finish.

#### DuraTex™ Features

**Safety** - Significantly reduces hazardous formaldehyde emissions which help improve the quality of the of the indoor air we breathe.

**Quality** - Developed to be tough and durable with special attention to appearance. The DuraTex™ finish preserves the natural beauty of wood.

**Durability** - Designed to meet a wide range of demanding performance and environmental standards to withstand even the highest wear and tear.

#### Finish Sheen

All veneer finishes are standard in 35-sheen, with the exception of Raven. Raven is only offered in 15-sheen. All other finishes can have their sheen modified with a 15% upcharge added to the list price of each item.

#### Custom/Special Finishes

JSI, upon request, will accommodate special finishes. A written request is required to proceed with custom finish orders. A sample reference is required for first-time matches and must be included with the written request.

There is a one-time charge of **\$412 list per order** for any non-standard wood finish.

Orders will be entered noting the special finish. A sample match will be provided to the customer. Written approval is needed before the finish process can be started. Delays in approval may have an impact on lead times.

Every effort will be made to create the requested match; however, an acceptable match may not be possible because of natural variations of wood. These natural variations can also cause minor differences in the final finish product.

Use standard pricing and option pricing for each line item with a special finish, unless additional modifications have been specified. For items available in both Essential and Artisan veneers, apply the Essentials pricing.

## Teamwork - Base Styles

Lok provides a choice selection of bases in both function and aesthetics to serve a variety of needs. The teamwork offering includes: T-base and X-base

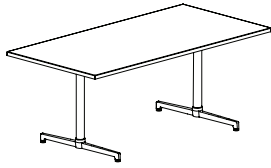

### T-Base

- available in 29" with options of glide or caster
- available in 36"h and 42"h only in glides
- compatible with the following top shapes: arc rectangular, boat, boomerang, bullet, double chevron, hive, home base, huddle, intersect, one-twenty, racetrack, rectangular, taper, wedge
- base finish - select single metal finish or two-tone metal finish. See options listed below.

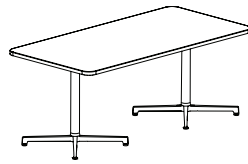

### X-Base

- available in 16", 29"h, 36"h or 42"h only in glides.
- compatible with the following top shapes: rectangular, round, square, squircle
- base finish - select single metal finish or two-tone metal finish. See options listed below.

### Single Metal Finish

- ABZ** Aged Bronze Feet & Post
- ASL** Arctic Silver Feet & Post
- GLD** Gold Feet & Post
- PEW** Pewter Feet & Post
- MBK** Matte Black Feet & Post
- SBZ** Soft Bronze Feet & Post
- SNK** Soft Nickel Feet & Post

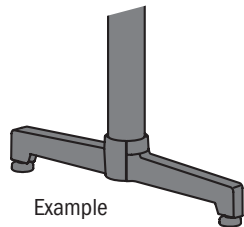

Example

### Two - Tone Metal Finish

Two-Tone Aesthetics can be achieved by specifying Polished Aluminum on the foot and a contrasting finish on the post

#### Polished Aluminum Feet

- ABZ** Aged Bronze Post
- ASL** Arctic Silver Post
- GLD** Gold Post
- PEW** Pewter Post
- MBK** Matte Black Post
- SBZ** Soft Bronze Post
- SNK** Soft Nickel Post

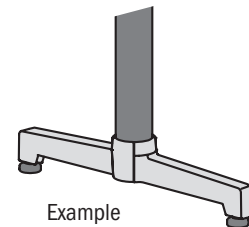

Example

### Power/Charging Options

Lok offers the ability to place power and charging options in the center of select tables. Select your choice of EC23 or EC24, available in black and white.

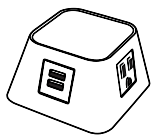

#### Moire - EC23

- Three 110 outlets
- Dual USB port with 72" power cord
- Black (B) or White (W)

select CTEC23 for cutout in worksurfaces



#### Node - EC24

- One 110 outlet
- Dual USB port with 72" power cord
- Black (B) or White (W)

select CTEC24 for cutout in worksurfaces

Cut outs are located in the center of each table. See below for representation or location.

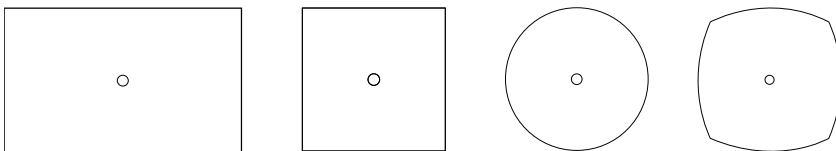

## Teamwork - Electrical

### Electrical Overview

Lok provides several packages to choose from for your electrical needs. Choose solutions for top surface power, underneath outlets, wireless charging, or a combination.

Specifying an electrical package eliminates your need to calculate additional components, as all units and necessary jumpers will ship with your table. You will only need to determine which power in-feed best suits your needs and order separately.

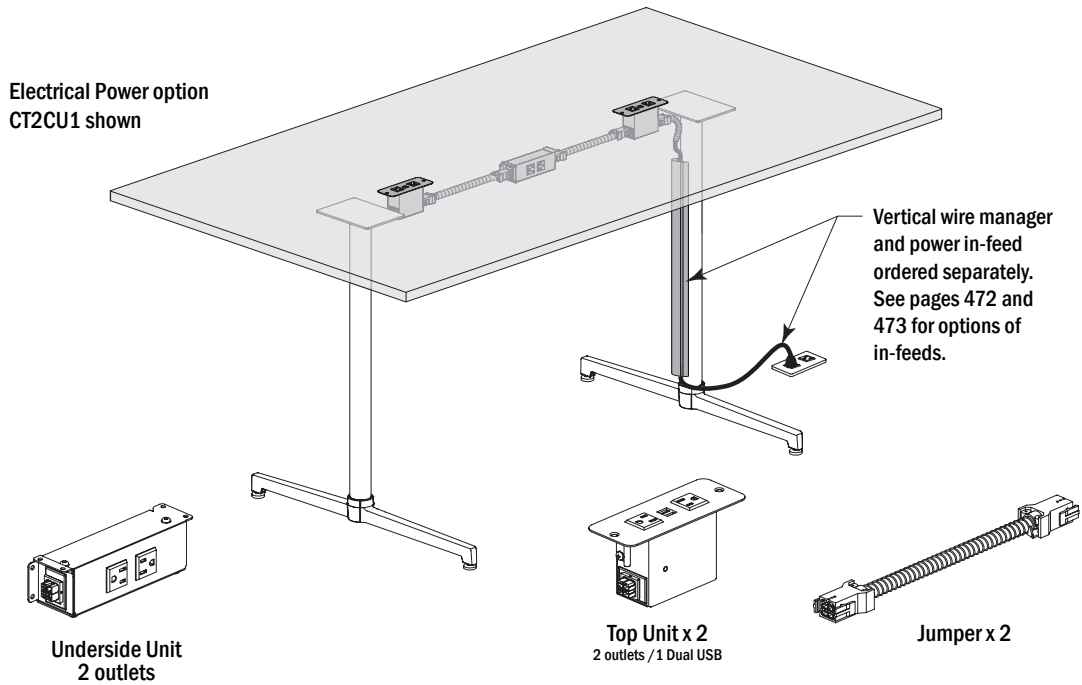

LOK - TEAMWORK

### Electrical

Power and Charging Packages are measured and located out from the center of the table. Shown on rectangular tops, these dimensions are the same from center regardless of table shape (ie huddle, boomerang, etc.). Power in-feed is specified separately to support building electrical connection.

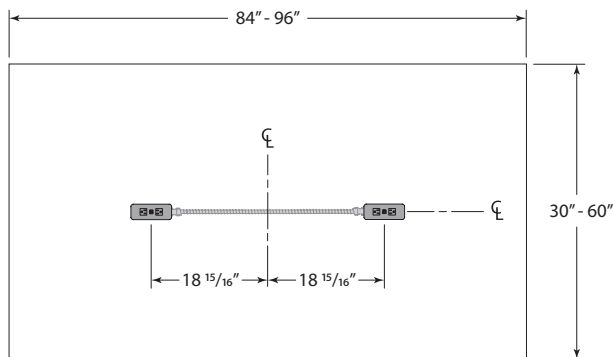

CT2 - Dual Power Top of Surface

Description

Rectangular Table with T Base at Working Height

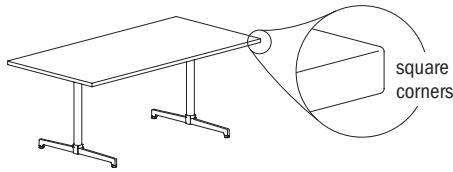

Laminate Tables "LKT" Models

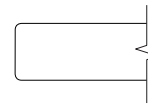

Eased Edge (R3)

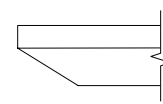

Reverse Bevel Edge (K9)

LAMINATE	D	W	H	CTN WT	CU FT	Model	Standard Tier 1	Graded In Tier 2	Standard Tier 1	Graded In Tier 2
	48	72	29	148	71	LKT4872-29TTT	\$2,566	\$2,621	\$3,209	\$3,263
	42	72	29	143	63	LKT4272-29TTT	\$2,443	\$2,490	\$3,069	\$3,116
	36	72	29	132	56	LKT3672-29TTT	\$2,230	\$2,315	\$2,792	\$2,875
	36	66	29	123	51	LKT3666-29TTT	\$2,150	\$2,230	\$2,711	\$2,792
	36	60	29	115	46	LKT3660-29TTT	\$2,056	\$2,131	\$2,614	\$2,689

Features:

- price reflects complete table - top and base
- ships KD in multiple cartons

Options:

- specify power/charging option, see below for options and upcharges
- specify glide (G) or caster (C) -choice of black (BL) or white/grey casters (WG)



top shape

LOK - TEAMWORK

To Order Specify

1 Laminate Model #	2 Edge Detail	3 Laminate Selection	3a PVC Edge Color	4 Electrical
Laminate (LKT)	<a href="#">See Edge Detail Options</a>	<a href="#">See Laminate Selection</a>	<a href="#">See PVC Edge Color Options</a>	N None CT2 Dual Power Center Top (See chart on next page) CU1 Single Power Underside <b>5 Foot/Caster</b> G Glide C Caster - BL Black Caster - WG White Caster w/Grey Wheels <b>6 Metal Finish</b> <a href="#">See Metal Finish Color Options</a>

Model Number Breakdown

LKT4872-29TTT					
LK	T	4872	29	TT	T
LOK	Laminate	48" x 72"	Height	Rectangular Top Shape	T base

Description

Rectangular Table with T Base  
at Working Height  
(continued)

Veneer Tables  
"LKV" Models

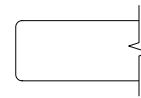

Eased Edge (R3)

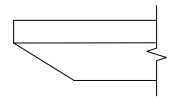

Reverse Bevel Edge (K9)

VENEER	D	W	H	CTN WT	CU FT	① Model	Eased Edge (R3)		Reverse Bevel Edge (K9)	
							Essentials	Artisan	Essentials	Artisan
	48	72	29	148	71	LKV4872-29TTT	\$2,957	\$3,243	\$3,269	\$3,532
	42	72	29	143	63	LKV4272-29TTT	\$2,824	\$3,079	\$3,125	\$3,355
	36	72	29	132	56	LKV3672-29TTT	\$2,605	\$2,852	\$2,820	\$3,063
	36	66	29	123	51	LKV3666-29TTT	\$2,551	\$2,779	\$2,760	\$2,984
	36	60	29	115	46	LKV3660-29TTT	\$2,474	\$2,688	\$2,677	\$2,887

LOK - TEAMWORK

Electrical Options and Upcharges

CT2	
Dual Power Center Top - Black	CT2BL - add \$1,773
Dual Power Center Top - White	CT2WH - add \$1,773
CU1	
Single Power Underside - Black	CU11C - add \$690
Single Power Underside with Wireless Charging - Black	CU11CW - add \$1,651

**Note: Order power infeed that best fits application**

To Order, Specify:

① Veneer Model #	② Edge Detail	③ Wood Collection	④ Top Wood Finish	⑤ Electrical	⑥ Base - Foot/Caster	⑦ Metal Color
Veneer (LKV)	<a href="#">See Edge Detail Options</a>	Essentials	<a href="#">See Essentials Top Wood Finish Options</a>	N None CT2 Dual Power Center Top CU1 Single Power Underside (See chart above)	G Glide C Caster - BL Black Caster - WG White Caster with Grey Wheels	<a href="#">See Metal Finish Color Options</a>
		Artisan	④ Top Wood Finish <a href="#">See Artisan Top Wood Finish Options</a>			

Description

Rounded Rectangular Table with T Base at Working Height

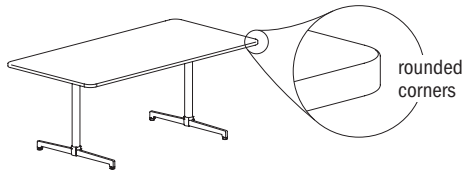

Laminate Tables  
"LKT" Models

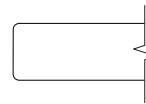

Eased Edge (R3)

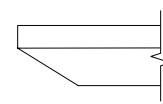

Reverse Bevel Edge (K9)

D	W	H	CTN WT	CU FT	① Model	Eased Edge (R3)		Reverse Bevel Edge (K9)	
						Standard Tier 1	Graded In Tier 2	Standard Tier 1	Graded In Tier 2
48	72	29	148	71	LKT4872-29TTRT	\$2,642	\$2,696	\$3,281	\$3,339
42	72	29	143	63	LKT4272-29TTRT	\$2,514	\$2,559	\$3,139	\$3,188
36	72	29	132	56	LKT3672-29TTRT	\$2,352	\$2,440	\$2,913	\$2,999
36	66	29	123	51	LKT3666-29TTRT	\$2,280	\$2,360	\$2,841	\$2,923
36	60	29	115	46	LKT3660-29TTRT	\$2,194	\$2,269	\$2,756	\$2,833

LAMINATE

Features:

- price reflects complete table - top and base
- ships KD in multiple cartons

Options:

- specify power/charging option, see below for options and upcharges
- specify glide (G) or caster (C) -choice of black (BL) or white/grey casters (WG)



top shape

LOK - TEAMWORK

To Order Specify

① Laminate Model #	② Edge Detail	③ Laminate Selection	④ PVC Edge Color	⑤ Electrical
Laminate (LKT)	<a href="#">See Edge Detail Options</a>	<a href="#">See Laminate Selection</a>	<a href="#">See PVC Edge Color Options</a>	N None CT2 Dual Power Center Top (See chart on next page) CU1 Single Power Underside <b>⑤ Foot/Caster</b> G Glide C Caster - BL Black Caster - WG White Caster w/Grey Wheels <b>⑥ Metal Finish</b> <a href="#">See Metal Finish Color Options</a>

Model Number Breakdown

LKT4872-29TTRT						
LK	T	4872	29	TT	R	T
LOK	Laminate	48" x 72"	Height	Rectangular Top Shape	Rounded Corner	T base

Description

Rounded Rectangular Table with T Base at Working Height (continued)

Veneer Tables "LKV" Models

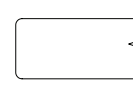

Eased Edge (R3)

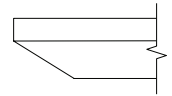

Reverse Bevel Edge (K9)

VENEER	D	W	H	CTN WT	CU FT	Model	Essentials	Artisan	Essentials	Artisan
	48	72	29	148	71	LKV4872-29TTRT	\$3,034	\$3,319	\$3,345	\$3,608
42	72	29	143	63	LKV4272-29TTRT	\$2,896	\$3,150	\$3,193	\$3,425	
36	72	29	132	56	LKV3672-29TTRT	\$2,800	\$3,059	\$2,905	\$3,151	
36	66	29	123	51	LKV3666-29TTRT	\$2,741	\$2,984	\$2,846	\$3,070	
36	60	29	115	46	LKV3660-29TTRT	\$2,659	\$2,887	\$2,759	\$2,969	

LOK - TEAMWORK

Electrical Options and Upcharges

CT2	
Dual Power Center Top - Black	CT2BL - add \$1,773
Dual Power Center Top - White	CT2WH - add \$1,773
CU1	
Single Power Underside - Black	CU11C - add \$690
Single Power Underside with Wireless Charging - Black	CU11CW - add \$1,651

**Note: Order power infeed that best fits application**

To Order, Specify:

1 Veneer Model #	2 Edge Detail	3 Wood Collection	4 Top Wood Finish	5 Electrical	6 Base - Foot/Caster	7 Metal Color
Veneer (LKV)	<a href="#">See Edge Detail Options</a>	Essentials	<a href="#">See Essentials Top Wood Finish Options</a>	N None CT2 Dual Power Center Top CU1 Single Power Underside (See chart above)	G Glide C Caster - BL Black Caster - WG White Caster with Grey Wheels	<a href="#">See Metal Finish Color Options</a>
		Artisan	<b>4 Top Wood Finish</b> <a href="#">See Artisan Top Wood Finish Options</a>			

Description

Rectangular Table with X Base at Working Height

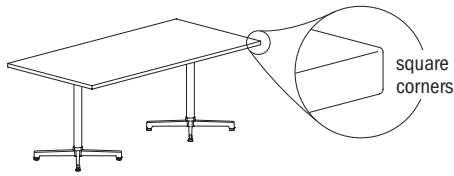

Laminate Tables "LKT" Models

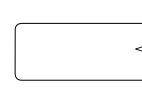

Eased Edge (R3)

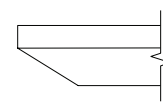

Reverse Bevel Edge (K9)

LAMINATE	D	W	H	CTN WT	CU FT	Model	Standard Tier 1	Graded In Tier 2	Standard Tier 1	Graded In Tier 2
		48	72	29	163	71	LKT4872-29TTX	\$3,311	\$3,365	\$3,954
	42	72	29	147	63	LKT4272-29TTX	\$3,188	\$3,237	\$3,815	\$3,864
	36	72	29	130	55	LKT3672-29TTX	\$2,918	\$3,004	\$3,478	\$3,563

Features:

- price reflects complete table - top and base
- ships KD in multiple cartons

Options:

- specify power/charging option, see below for options and upcharges



top shape

LOK - TEAMWORK

To Order Specify

1 Laminates Model #	2 Edge Detail	3 Laminates Selection	3a PVC Edge Color	4 Electrical
Laminates (LKT)	<a href="#">See Edge Detail Options</a>	<a href="#">See Laminates Selection</a>	<a href="#">See PVC Edge Color Options</a>	N None CT2 Dual Power Center Top (See chart on next page) CU1 Single Power Underside <b>5 Metal Finish</b> <a href="#">See Metal Finish Color Options</a>

Model Number Breakdown

LKT4872-29TTX					
LK	T	4872	29	TT	X
LOK	Laminates	48" x 72"	Height	Rectangular Top Shape	X base

Description

Rectangular Table with X Base  
at Working Height  
(continued)

Veneer Tables  
"LKV" Models

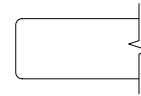

Eased Edge (R3)

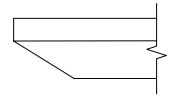

Reverse Bevel Edge (K9)

VENEER	D	W	H	CTN WT	CU FT	① Model	Essentials	Artisan	Essentials	Artisan
	48	72	29	163	71	LKV4872-29TTX	\$3,706	\$3,991	\$4,015	\$4,280
42	72	29	147	63	LKV4272-29TTX	\$3,571	\$3,823	\$3,870	\$4,103	
36	72	29	130	55	LKV3672-29TTX	\$3,295	\$3,544	\$3,510	\$3,752	

LOK - TEAMWORK

Electrical Options and Upcharges

CT2	
Dual Power Center Top - Black	CT2BL - add \$1,773
Dual Power Center Top - White	CT2WH - add \$1,773
CU1	
Single Power Underside - Black	CU11C - add \$690
Single Power Underside with Wireless Charging - Black	CU11CW - add \$1,651

**Note: Order power infeed that best fits application**

To Order, Specify:

① Veneer Model #	② Edge Detail	③ Wood Collection	④ Top Wood Finish	⑤ Electrical	⑥ Metal Color
Veneer (LKV)	<a href="#">See Edge Detail Options</a>	Essentials	<a href="#">See Essentials Top Wood Finish Options</a>	N None CT2 Dual Power Center Top CU1 Single Power Underside (See chart above)	<a href="#">See Metal Finish Color Options</a>
		Artisan	④ Top Wood Finish <a href="#">See Artisan Top Wood Finish Options</a>		

Description

Rounded Rectangular Table with X Base at Working Height

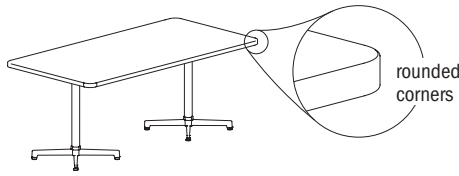

Laminate Tables  
"LKT" Models

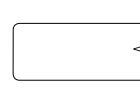

Eased Edge (R3)

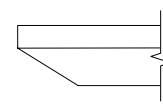

Reverse Bevel Edge (K9)

LAMINATE	D	W	H	CTN WT	CU FT	Model	Standard Tier 1	Graded In Tier 2	Standard Tier 1	Graded In Tier 2
		48	72	29	163	71	LKT4872-29TTRX	\$3,388	\$3,442	\$4,028
	42	72	29	147	63	LKT4272-29TTRX	\$3,257	\$3,306	\$3,884	\$3,931
	36	72	29	125	55	LKT3672-29TTRX	\$3,042	\$3,127	\$3,602	\$3,686

Features:

- price reflects complete table - top and base
- ships KD in multiple cartons

Options:

- specify power/charging option, see below for options and upcharges



top shape

LOK - TEAMWORK

To Order Specify

1 Laminite Model #	2 Edge Detail	3 Laminite Selection	3a PVC Edge Color	4 Electrical
Laminite (LKT)	<a href="#">See Edge Detail Options</a>	<a href="#">See Laminite Selection</a>	<a href="#">See PVC Edge Color Options</a>	N None CT2 Dual Power Center Top (See chart on next page) CU1 Single Power Underside <b>5 Metal Finish</b> <a href="#">See Metal Finish Color Options</a>

Model Number Breakdown

LKT4872-29TTRX						
LK	T	4872	29	TT	R	X
LOK	Laminite	48" x 72"	Height	Rectangular Top Shape	Rounded Corner	X base

Description

Rounded Rectangular Table with X Base at Working Height (continued)

Veneer Tables "LKV" Models

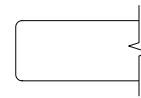

Eased Edge (R3)

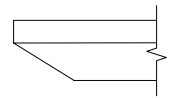

Reverse Bevel Edge (K9)

VENEER	D	W	H	CTN WT	CU FT	① Model	Eased Edge (R3)		Reverse Bevel Edge (K9)	
							Essentials	Artisan	Essentials	Artisan
	48	72	29	163	71	LKV4872-29TTRX	\$3,777	\$4,063	\$4,090	\$4,356
	42	72	29	147	63	LKV4272-29TTRX	\$3,641	\$3,896	\$3,939	\$4,172
	36	72	29	130	55	LKV3672-29TTRX	\$3,529	\$3,790	\$3,638	\$3,882

LOK - TEAMWORK

Electrical Options and Upcharges

CT2	
Dual Power Center Top - Black	CT2BL - add \$1,773
Dual Power Center Top - White	CT2WH - add \$1,773
CU1	
Single Power Underside - Black	CU11C - add \$690
Single Power Underside with Wireless Charging - Black	CU11CW - add \$1,651

**Note: Order power infeed that best fits application**

To Order, Specify:

① Veneer Model #	② Edge Detail	③ Wood Collection	④ Top Wood Finish	⑤ Electrical	⑥ Metal Color
Veneer (LKV)	<a href="#">See Edge Detail Options</a>	Essentials	<a href="#">See Essentials Top Wood Finish Options</a>	N None CT2 Dual Power Center Top CU1 Single Power Underside (See chart above)	<a href="#">See Metal Finish Color Options</a>
		Artisan	④ Top Wood Finish <a href="#">See Artisan Top Wood Finish Options</a>		

Description

Arc Rectangular Table with T Base at Working Height

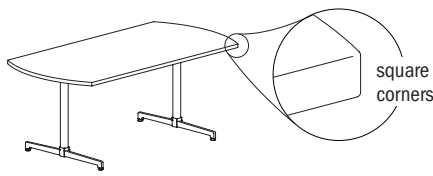

Laminate Tables "LKT" Models

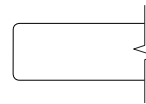

Eased Edge (R3)

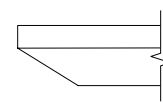

Reverse Bevel Edge (K9)

D	W	H	CTN WT	CU FT	Model	Eased Edge (R3)		Reverse Bevel Edge (K9)	
						Standard Tier 1	Graded In Tier 2	Standard Tier 1	Graded In Tier 2
48	72	29	148	71	LKT4872-29ART	\$2,518	\$2,568	\$3,127	\$3,179
42	72	29	140	63	LKT4272-29ART	\$2,396	\$2,440	\$2,990	\$3,035
36	72	29	128	56	LKT3672-29ART	\$2,241	\$2,321	\$2,774	\$2,857
36	66	29	119	51	LKT3666-29ART	\$2,172	\$2,246	\$2,706	\$2,783
36	60	29	110	46	LKT3660-29ART	\$2,091	\$2,161	\$2,624	\$2,696

LAMINATE

Features:

- price reflects complete table - top and base
- ships KD in multiple cartons

Options:

- specify power/charging option, see below for options and upcharges
- specify glide (G) or caster (C) -choice of black (BL) or white/grey casters (WG)



top shape

LOK - TEAMWORK

To Order Specify

1 Laminate Model #	2 Edge Detail	3 Laminate Selection	3a PVC Edge Color	4 Electrical
Laminate (LKT)	<a href="#">See Edge Detail Options</a>	<a href="#">See Laminate Selection</a>	<a href="#">See PVC Edge Color Options</a>	N None CT2 Dual Power Center Top (See chart on next page) CU1 Single Power Underside <b>5 Foot/Caster</b> G Glide C Caster - BL Black Caster - WG White Caster w/Grey Wheels <b>6 Metal Finish</b> <a href="#">See Metal Finish Color Options</a>

Model Number Breakdown

LKT4872-29ART					
LK	T	4872	29	AR	T
LOK	Laminate	48" x 72"	Height	Arc Rectangular Top Shape	T base

Description

Arc Rectangular Table with T Base at Working Height (continued)

Veneer Tables "LKV" Models

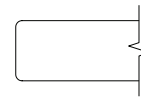

Eased Edge (R3)

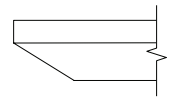

Reverse Bevel Edge (K9)

D	W	H	CTN WT	CU FT	Model	Eased Edge (R3)		Reverse Bevel Edge (K9)	
						Essentials	Artisan	Essentials	Artisan
48	72	29	148	71	LKV4872-29ART	\$3,223	\$3,480	\$3,514	\$3,744
42	72	29	140	63	LKV4272-29ART	\$3,092	\$3,341	\$3,372	\$3,591
36	72	29	128	56	LKV3672-29ART	\$2,963	\$3,195	\$3,225	\$3,436
36	66	29	119	51	LKV3666-29ART	\$2,856	\$3,084	\$3,112	\$3,312
36	60	29	110	46	LKV3660-29ART	\$2,792	\$3,013	\$3,042	\$3,239

VENEER

LOK - TEAMWORK

Electrical Options and Upcharges

CT2	
Dual Power Center Top - Black	CT2BL - add \$1,773
Dual Power Center Top - White	CT2WH - add \$1,773
CU1	
Single Power Underside - Black	CU11C - add \$690
Single Power Underside with Wireless Charging - Black	CU11CW - add \$1,651

**Note: Order power infeed that best fits application**

To Order, Specify:

1 Veneer Model #	2 Edge Detail	3 Wood Collection	4 Top Wood Finish	5 Electrical	6 Base - Foot/Caster	7 Metal Color
Veneer (LKV)	<a href="#">See Edge Detail Options</a>	Essentials	<a href="#">See Essentials Top Wood Finish Options</a>	N None CT2 Dual Power Center Top CU1 Single Power Underside (See chart above)	G Glide C Caster - BL Black Caster - WG White Caster with Grey Wheels	<a href="#">See Metal Finish Color Options</a>
		Artisan	4 Top Wood Finish <a href="#">See Artisan Top Wood Finish Options</a>			

Description

Rounded Arc Rectangular Table with T Base at Working Height

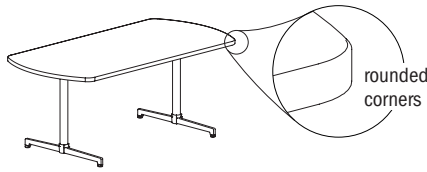

Laminate Tables  
"LKT" Models

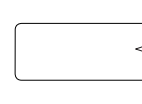

Eased Edge (R3)

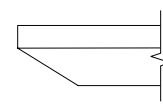

Reverse Bevel Edge (K9)

LAMINATE	D	W	H	CTN WT	CU FT	Model	Standard Tier 1	Graded In Tier 2	Standard Tier 1	Graded In Tier 2
		48	72	29	148	71	LKT4872-29ARRT	\$2,518	\$2,568	\$3,127
	42	72	29	140	63	LKT4272-29ARRT	\$2,396	\$2,440	\$2,990	\$3,035
	36	72	29	128	56	LKT3672-29ARRT	\$2,241	\$2,321	\$2,774	\$2,857
	36	66	29	119	51	LKT3666-29ARRT	\$2,172	\$2,246	\$2,706	\$2,783
	36	60	29	110	46	LKT3660-29ARRT	\$2,091	\$2,161	\$2,624	\$2,696

Features:

- price reflects complete table - top and base
- ships KD in multiple cartons

Options:

- specify power/charging option, see below for options and upcharges
- specify glide (G) or caster (C) -choice of black (BL) or white/grey casters (WG)

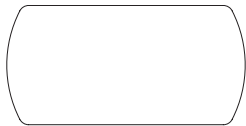

top shape

LOK - TEAMWORK

To Order Specify

1 Laminate Model #	2 Edge Detail	3 Laminate Selection	3a PVC Edge Color	4 Electrical
Laminate (LKT)	<a href="#">See Edge Detail Options</a>	<a href="#">See Laminate Selection</a>	<a href="#">See PVC Edge Color Options</a>	N None CT2 Dual Power Center Top (See chart on next page) CU1 Single Power Underside <b>5 Foot/Caster</b> G Glide C Caster - BL Black Caster - WG White Caster w/Grey Wheels <b>6 Metal Finish</b> <a href="#">See Metal Finish Color Options</a>

Model Number Breakdown

LKT4872-29ARRT						
LK	T	4872	29	AR	R	T
LOK	Laminate	48" x 72"	Height	Arc Rectangular Top Shape	Rounded Corner	T base

Description

Rounded Arc Rectangular Table with T Base at Working Height (continued)

Veneer Tables "LKV" Models

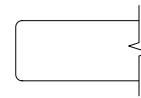

Eased Edge (R3)

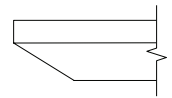

Reverse Bevel Edge (K9)

D	W	H	CTN WT	CU FT	① Model	Eased Edge (R3)		Reverse Bevel Edge (K9)	
						Essentials	Artisan	Essentials	Artisan
48	72	29	148	71	LKV4872-29ARRT	\$3,223	\$3,480	\$3,514	\$3,744
42	72	29	140	63	LKV4272-29ARRT	\$3,092	\$3,341	\$3,372	\$3,591
36	72	29	128	56	LKV3672-29ARRT	\$2,963	\$3,195	\$3,225	\$3,436
36	66	29	119	51	LKV3666-29ARRT	\$2,856	\$3,084	\$3,112	\$3,312
36	60	29	110	46	LKV3660-29ARRT	\$2,792	\$3,013	\$3,042	\$3,239

VENEER

LOK - TEAMWORK

Electrical Options and Upcharges

CT2	
Dual Power Center Top - Black	CT2BL - add \$1,773
Dual Power Center Top - White	CT2WH - add \$1,773
CU1	
Single Power Underside - Black	CU11C - add \$690
Single Power Underside with Wireless Charging - Black	CU11CW - add \$1,651

**Note: Order power infeed that best fits application**

To Order, Specify:

① Veneer Model #	② Edge Detail	③ Wood Collection	④ Top Wood Finish	⑤ Electrical	⑥ Base - Foot/Caster	⑦ Metal Color
Veneer (LKV)	<a href="#">See Edge Detail Options</a>	Essentials	<a href="#">See Essentials Top Wood Finish Options</a>	N None CT2 Dual Power Center Top CU1 Single Power Underside (See chart above)	G Glide C Caster - BL Black Caster - WG White Caster with Grey Wheels	<a href="#">See Metal Finish Color Options</a>
		Artisan	④ Top Wood Finish <a href="#">See Artisan Top Wood Finish Options</a>			

Description

Racetrack Table with T Base at Working Height

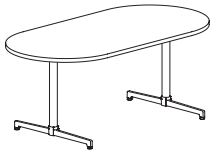

Laminate Tables  
"LKT" Models

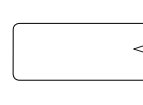

Eased Edge (R3)

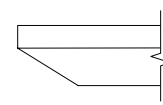

Reverse Bevel Edge (K9)

D	W	H	CTN WT	CU FT	Model	Eased Edge (R3)		Reverse Bevel Edge (K9)	
						Standard Tier 1	Graded In Tier 2	Standard Tier 1	Graded In Tier 2
48	72	29	135	71	LKT4872-29RKT	\$2,518	\$2,568	\$3,127	\$3,179
42	72	29	133	63	LKT4272-29RKT	\$2,396	\$2,440	\$2,990	\$3,035
36	72	29	122	56	LKT3672-29RKT	\$2,241	\$2,321	\$2,774	\$2,857
36	66	29	113	51	LKT3666-29RKT	\$2,172	\$2,246	\$2,706	\$2,783
36	60	29	104	46	LKT3660-29RKT	\$2,091	\$2,161	\$2,624	\$2,696

LAMINATE

Features:

- price reflects complete table - top and base
- ships KD in multiple cartons

Options:

- specify power/charging option, see below for options and upcharges
- specify glide (G) or caster (C) -choice of black (BL) or white/grey casters (WG)

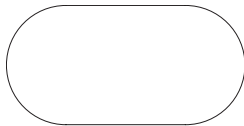

top shape

LOK - TEAMWORK

To Order Specify

1 Laminate Model #	2 Edge Detail	3 Laminate Selection	3a PVC Edge Color	4 Electrical
Laminate (LKT)	<a href="#">See Edge Detail Options</a>	<a href="#">See Laminate Selection</a>	<a href="#">See PVC Edge Color Options</a>	N None CT2 Dual Power Center Top (See chart on next page) CU1 Single Power Underside <b>5 Foot/Caster</b> G Glide C Caster - BL Black Caster - WG White Caster w/Grey Wheels <b>6 Metal Finish</b> <a href="#">See Metal Finish Color Options</a>

Model Number Breakdown

LKT4872-29RKT					
LK	T	4872	29	RK	T
LOK	Laminate	48" x 72"	Height	Racetrack Top Shape	T base

Description

Racetrack Table with T Base  
at Working Height  
(continued)

Veneer Tables  
"LKV" Models

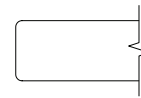

Eased Edge (R3)

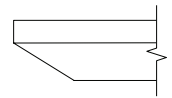

Reverse Bevel Edge (K9)

D	W	H	CTN WT	CU FT	① Model	Eased Edge (R3)		Reverse Bevel Edge (K9)	
						Essentials	Artisan	Essentials	Artisan
48	72	29	135	71	LKV4872-29RKT	\$3,223	\$3,480	\$3,514	\$3,744
42	72	29	133	63	LKV4272-29RKT	\$3,092	\$3,341	\$3,372	\$3,591
36	72	29	122	56	LKV3672-29RKT	\$2,963	\$3,195	\$3,225	\$3,436
36	66	29	113	51	LKV3666-29RKT	\$2,856	\$3,084	\$3,112	\$3,312
36	60	29	104	46	LKV3660-29RKT	\$2,701	\$2,915	\$2,943	\$3,132

VENEER

LOK - TEAMWORK

Electrical Options and Upcharges

CT2	
Dual Power Center Top - Black	CT2BL - add \$1,773
Dual Power Center Top - White	CT2WH - add \$1,773
CU1	
Single Power Underside - Black	CU11C - add \$690
Single Power Underside with Wireless Charging - Black	CU11CW - add \$1,651

**Note: Order power infeed that best fits application**

To Order, Specify:

① Veneer Model #	② Edge Detail	③ Wood Collection	④ Top Wood Finish	⑤ Electrical	⑥ Base - Foot/Caster	⑦ Metal Color
Veneer (LKV)	<a href="#">See Edge Detail Options</a>	Essentials	<a href="#">See Essentials Top Wood Finish Options</a>	N None CT2 Dual Power Center Top CU1 Single Power Underside (See chart above)	G Glide C Caster - BL Black Caster - WG White Caster with Grey Wheels	<a href="#">See Metal Finish Color Options</a>
		Artisan	④ Top Wood Finish <a href="#">See Artisan Top Wood Finish Options</a>			

Description

Oval Table with T Base at Working Height

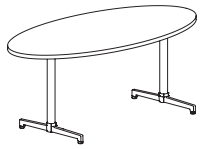

Laminate Tables  
"LKT" Models

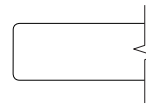

Eased Edge (R3)

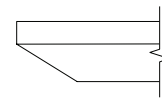

Reverse Bevel Edge (K9)

LAMI	D	W	H	CTN WT	CU FT	Model	Standard Tier 1	Graded In Tier 2	Standard Tier 1	Graded In Tier 2
		36	72	29	110	56	LKT3672-290VT	\$2,241	\$2,321	\$2,774

Features:

- price reflects complete table - top and base
- ships KD in multiple cartons

Options:

- specify power option and or charging option, see below for options and upcharges
- specify glide (always black) or caster; Black (BL) or White with Grey Wheels (WG)

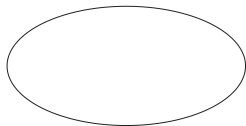

top shape

LOK - TEAMWORK

To Order Specify

1 Laminate Model #	2 Edge Detail	3 Laminate Selection	3a PVC Edge Color	4 Electrical
Laminate (LKT)	<a href="#">See Edge Detail Options</a>	<a href="#">See Laminate Selection</a>	<a href="#">See PVC Edge Color Options</a>	N None CT2 Dual Power Center Top (See chart on next page) CU1 Single Power Underside <b>5 Foot/Caster</b> G Glide C Caster - BL Black Caster - WG White Caster w/Grey Wheels <b>6 Metal Finish</b> <a href="#">See Metal Finish Color Options</a>

Model Number Breakdown

LKT3672-290VT					
LK	T	3672	29	OV	T
LOK	Laminate	36" x 72"	Height	Oval Top Shape	T base

Description

Oval Table with T Base at Working Height (continued)

Veneer Tables "LKV" Models

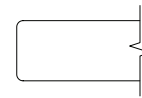

Eased Edge (R3)

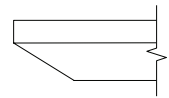

Reverse Bevel Edge (K9)

VEN.	D	W	H	CTN WT	CU FT	① Model	Essentials		Artisan	
							Essentials	Artisan	Essentials	Artisan
	36	72	29	110	56	LKV3672-29OVT	\$2,772	\$2,994	\$3,023	\$3,217

LOK - TEAMWORK

Electrical Options and Upcharges

CT2	
Dual Power Center Top - Black	CT2BL - add \$1,773
Dual Power Center Top - White	CT2WH - add \$1,773
CU1	
Single Power Underside - Black	CU11C - add \$690
Single Power Underside with Wireless Charging - Black	CU11CW - add \$1,651

**Note: Order power infeed that best fits application**

To Order, Specify:

① Veneer Model #	② Edge Detail	③ Wood Collection	④ Top Wood Finish	⑤ Electrical	⑥ Base - Foot/Caster	⑦ Metal Color
Veneer (LKV)	<a href="#">See Edge Detail Options</a>	Essentials	<a href="#">See Essentials Top Wood Finish Options</a>	N None CT2 Dual Power Center Top CU1 Single Power Underside (See chart above)	G Glide C Caster - BL Black Caster - WG White Caster with Grey Wheels	<a href="#">See Metal Finish Color Options</a>
		Artisan	④ Top Wood Finish <a href="#">See Artisan Top Wood Finish Options</a>			

Description

Boat Table with T Base at Working Height

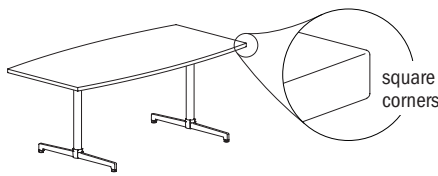

Laminate Tables "LKT" Models

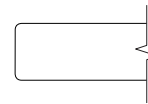

Eased Edge (R3)

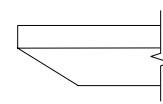

Reverse Bevel Edge (K9)

LAMINATE	D	W	H	CTN WT	CU FT	Model	Standard Tier 1	Graded In Tier 2	Standard Tier 1	Graded In Tier 2
		48	72	29	145	71	LKT4872-29BTT	\$2,518	\$2,568	\$3,127
	42	72	29	142	63	LKT4272-29BTT	\$2,396	\$2,440	\$2,990	\$3,035
	36	72	29	128	56	LKT3672-29BTT	\$2,241	\$2,321	\$2,774	\$2,857
	36	66	29	119	51	LKT3666-29BTT	\$2,172	\$2,246	\$2,706	\$2,783
	36	60	29	111	46	LKT3660-29BTT	\$2,091	\$2,161	\$2,624	\$2,696

Features:

- price reflects complete table - top and base
- ships KD in multiple cartons

Options:

- specify power/charging option, see below for options and upcharges
- specify glide (G) or caster (C) -choice of black (BL) or white/grey casters (WG)

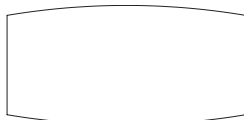

top shape

LOK - TEAMWORK

To Order Specify

1 Laminate Model #	2 Edge Detail	3 Laminate Selection	3a PVC Edge Color	4 Electrical
Laminate (LKT)	<a href="#">See Edge Detail Options</a>	<a href="#">See Laminate Selection</a>	<a href="#">See PVC Edge Color Options</a>	N None CT2 Dual Power Center Top (See chart on next page) CU1 Single Power Underside <b>5 Foot/Caster</b> G Glide C Caster - BL Black Caster - WG White Caster w/Grey Wheels <b>6 Metal Finish</b> <a href="#">See Metal Finish Color Options</a>

Model Number Breakdown

LKT4872-29BTT					
LK	T	4872	29	BT	T
LOK	Laminate	48" x 72"	Height	Boat Top Shape	T base

Description

Boat Table with T Base at Working Height (continued)

Veneer Tables "LKV" Models

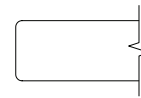

Eased Edge (R3)

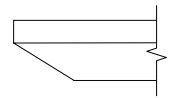

Reverse Bevel Edge (K9)

VENEER	D	W	H	CTN WT	CU FT	Model	Eased Edge (R3)		Reverse Bevel Edge (K9)	
							Essentials	Artisan	Essentials	Artisan
	48	72	29	145	71	LKV4872-29BTT	\$3,223	\$3,480	\$3,514	\$3,744
	42	72	29	145	71	LKV4272-29BTT	\$3,092	\$3,341	\$3,372	\$3,591
	36	72	29	142	63	LKV3672-29BTT	\$2,963	\$3,195	\$3,225	\$3,436
	36	66	29	128	56	LKV3666-29BTT	\$2,856	\$3,084	\$3,112	\$3,312
	36	60	29	119	46	LKV3660-29BTT	\$2,792	\$3,013	\$3,042	\$3,239

LOK - TEAMWORK

Electrical Options and Upcharges

CT2	
Dual Power Center Top - Black	CT2BL - add \$1,773
Dual Power Center Top - White	CT2WH - add \$1,773
CU1	
Single Power Underside - Black	CU11C - add \$690
Single Power Underside with Wireless Charging - Black	CU11CW - add \$1,651

**Note: Order power infeed that best fits application**

To Order, Specify:

1 Veneer Model #	2 Edge Detail	3 Wood Collection	4 Top Wood Finish	5 Electrical	6 Base - Foot/Caster	7 Metal Color
Veneer (LKV)	<a href="#">See Edge Detail Options</a>	Essentials	<a href="#">See Essentials Top Wood Finish Options</a>	N None CT2 Dual Power Center Top CU1 Single Power Underside (See chart above)	G Glide C Caster - BL Black Caster - WG White Caster with Grey Wheels	<a href="#">See Metal Finish Color Options</a>
		Artisan	<b>4 Top Wood Finish</b> <a href="#">See Artisan Top Wood Finish Options</a>			

Description

Rounded Boat Table with T Base at Working Height

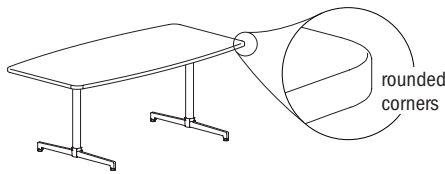

Laminate Tables "LKT" Models

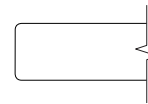

Eased Edge (R3)

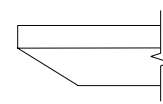

Reverse Bevel Edge (K9)

LAMINATE	D	W	H	CTN WT	CU FT	Model	Standard Tier 1	Graded In Tier 2	Standard Tier 1	Graded In Tier 2
		48	72	29	145	71	LKT4872-29BTRT	\$2,518	\$2,568	\$3,127
	42	72	29	142	63	LKT4272-29BTRT	\$2,396	\$2,440	\$2,990	\$3,035
	36	72	29	128	56	LKT3672-29BTRT	\$2,241	\$2,321	\$2,774	\$2,857
	36	66	29	119	51	LKT3666-29BTRT	\$2,172	\$2,246	\$2,706	\$2,783
	36	60	29	111	46	LKT3660-29BTRT	\$2,091	\$2,161	\$2,624	\$2,696

Features:

- price reflects complete table - top and base
- ships KD in multiple cartons

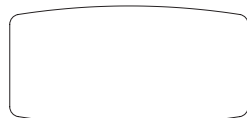

top shape

Options:

- specify power/charging option, see below for options and upcharges
- specify glide (G) or caster (C) - choice of black (BL) or white/grey casters (WG)

LOK - TEAMWORK

To Order Specify

1 Laminate Model #	2 Edge Detail	3 Laminate Selection	3a PVC Edge Color	4 Electrical
Laminate (LKT)	<a href="#">See Edge Detail Options</a>	<a href="#">See Laminate Selection</a>	<a href="#">See PVC Edge Color Options</a>	N None CT2 Dual Power Center Top (See chart on next page) CU1 Single Power Underside <b>5 Foot/Caster</b> G Glide C Caster - BL Black Caster - WG White Caster w/Grey Wheels <b>6 Metal Finish</b> <a href="#">See Metal Finish Color Options</a>

Model Number Breakdown

LKT4872-29BTRT						
LK	T	4872	29	BT	R	T
LOK	Laminate	48" x 72"	Height	Boat Top Shape	Rounded Corner	T base

Description

Rounded Boat Table with T Base at Working Height (continued)

Veneer Tables "LKV" Models

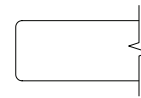

Eased Edge (R3)

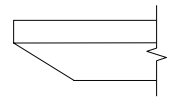

Reverse Bevel Edge (K9)

VENEER	D	W	H	CTN WT	CU FT	① Model	Eased Edge (R3)		Reverse Bevel Edge (K9)	
							Essentials	Artisan	Essentials	Artisan
	48	72	29	145	71	LKV4872-29BTRT	\$3,223	\$3,480	\$3,514	\$3,744
	42	72	29	142	63	LKV4272-29BTRT	\$3,092	\$3,341	\$3,372	\$3,591
	36	72	29	128	56	LKV3672-29BTRT	\$2,963	\$3,195	\$3,225	\$3,436
	36	66	29	119	51	LKV3666-29BTRT	\$2,856	\$3,084	\$3,112	\$3,312
	36	60	29	111	46	LKV3660-29BTRT	\$2,792	\$3,013	\$3,042	\$3,239

LOK - TEAMWORK

Electrical Options and Upcharges

CT2	
Dual Power Center Top - Black	CT2BL - add \$1,773
Dual Power Center Top - White	CT2WH - add \$1,773
CU1	
Single Power Underside - Black	CU11C - add \$690
Single Power Underside with Wireless Charging - Black	CU11CW - add \$1,651

**Note: Order power infeed that best fits application**

To Order, Specify:

① Veneer Model #	② Edge Detail	③ Wood Collection	④ Top Wood Finish	⑤ Electrical	⑥ Base - Foot/Caster	⑦ Metal Color
Veneer (LKV)	<a href="#">See Edge Detail Options</a>	Essentials	<a href="#">See Essentials Top Wood Finish Options</a>	N None CT2 Dual Power Center Top CU1 Single Power Underside (See chart above)	G Glide C Caster - BL Black Caster - WG White Caster with Grey Wheels	<a href="#">See Metal Finish Color Options</a>
		Artisan	④ Top Wood Finish <a href="#">See Artisan Top Wood Finish Options</a>			

Description

Rounded Double Chevron Table with T Base at Working Height

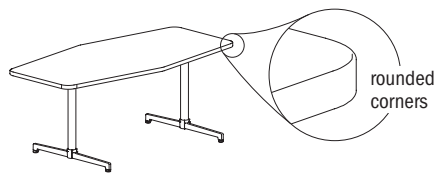

Laminate Tables "LKT" Models

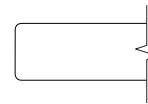

Eased Edge (R3)

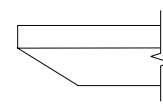

Reverse Bevel Edge (K9)

LAMINATE

D	W	H	CTN WT	CU FT	Model	Eased Edge (R3)		Reverse Bevel Edge (K9)	
						Standard Tier 1	Graded In Tier 2	Standard Tier 1	Graded In Tier 2
48	72	29	148	71	LKT4872-29DCRT	\$2,518	\$2,568	\$3,127	\$3,179
48	60	29	138	60	LKT4860-29DCRT	\$2,225	\$2,268	\$2,818	\$2,863
42	72	29	133	63	LKT4272-29DCRT	\$2,396	\$2,440	\$2,990	\$3,035
42	60	29	123	52	LKT4260-29DCRT	\$2,119	\$2,157	\$2,706	\$2,743
36	72	29	107	56	LKT3672-29DCRT	\$2,241	\$2,321	\$2,774	\$2,857
36	60	29	101	46	LKT3660-29DCRT	\$2,061	\$2,096	\$2,639	\$2,672

Features:

- price reflects complete table - top and base
- ships KD in multiple cartons

Options:

- specify power/charging option, see below for options and upcharges
- specify glide (G) or caster (C) - choice of black (BL) or white/grey casters (WG)

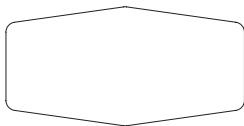

top shape

LOK - TEAMWORK

To Order Specify

1 Laminate Model #	2 Edge Detail	3 Laminate Selection	3a PVC Edge Color	4 Electrical
Laminate (LKT)	<a href="#">See Edge Detail Options</a>	<a href="#">See Laminate Selection</a>	<a href="#">See PVC Edge Color Options</a>	N None CT2 Dual Power Center Top (See chart on next page) CU1 Single Power Underside <b>5 Foot/Caster</b> G Glide C Caster - BL Black Caster - WG White Caster w/Grey Wheels <b>6 Metal Finish</b> <a href="#">See Metal Finish Color Options</a>

Model Number Breakdown

LKT4872-29DCRT						
LK	T	4872	29	DC	R	T
LOK	Laminate	48" x 72"	Height	Double Chevron Top Shape	Rounded Corner	T base

Description

Rounded Double Chevron Table with T Base  
at Working Height  
(continued)

Veneer Tables  
"LKV" Models

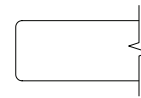

Eased Edge (R3)

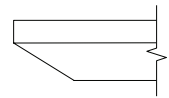

Reverse Bevel Edge (K9)

D	W	H	CTN WT	CU FT	① Model	Eased Edge (R3)		Reverse Bevel Edge (K9)	
						Essentials	Artisan	Essentials	Artisan
48	72	29	148	71	LKV4872-29DCRT	\$3,223	\$3,480	\$3,514	\$3,744
48	60	29	138	60	LKV4860-29DCRT	\$2,923	\$3,156	\$3,186	\$3,392
42	72	29	133	63	LKV4272-29DCRT	\$3,092	\$3,341	\$3,372	\$3,591
42	60	29	123	52	LKV4260-29DCRT	\$2,810	\$3,035	\$3,064	\$3,263
36	72	29	107	56	LKV3672-29DCRT	\$2,772	\$2,994	\$3,023	\$3,217
36	60	29	101	46	LKV3660-29DCRT	\$2,601	\$2,809	\$2,838	\$3,019

VENEER

LOK - TEAMWORK

Electrical Options and Upcharges

CT2	
Dual Power Center Top - Black	CT2BL - add \$1,773
Dual Power Center Top - White	CT2WH - add \$1,773
CU1	
Single Power Underside - Black	CU11C - add \$690
Single Power Underside with Wireless Charging - Black	CU11CW - add \$1,651

**Note: Order power infeed that best fits application**

To Order, Specify:

① Veneer Model #	② Edge Detail	③ Wood Collection	④ Top Wood Finish	⑤ Electrical	⑥ Base - Foot/Caster	⑦ Metal Color
Veneer (LKV)	<a href="#">See Edge Detail Options</a>	Essentials	<a href="#">See Essentials Top Wood Finish Options</a>	N None CT2 Dual Power Center Top CU1 Single Power Underside (See chart above)	G Glide C Caster - BL Black Caster - WG White Caster with Grey Wheels	<a href="#">See Metal Finish Color Options</a>
		Artisan	④ Top Wood Finish <a href="#">See Artisan Top Wood Finish Options</a>			

Description

Taper Table with T Base at Working Height

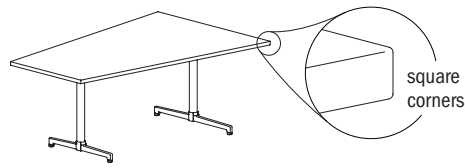

Laminate Tables "LKT" Models

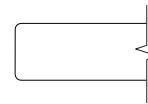

Eased Edge (R3)

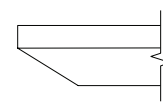

Reverse Bevel Edge (K9)

LAMI	D	W	H	CTN WT	CU FT	Model	Standard Tier 1	Graded In Tier 2	Standard Tier 1	Graded In Tier 2
		48	72	29	140	71	LKT4872-29TPT	\$3,127	\$3,180	\$3,737

Features:

- price reflects complete table - top and base
- ships KD in multiple cartons

Options:

- specify power/charging option, see below for options and upcharges
- specify glide (G) or caster (C) - choice of black (BL) or white/grey casters (WG)

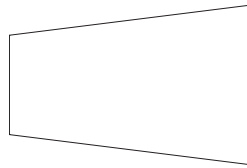

top shape

LOK - TEAMWORK

To Order Specify

1 Laminate Model #	2 Edge Detail	3 Laminate Selection	3a PVC Edge Color	4 Electrical
Laminate (LKT)	<a href="#">See Edge Detail Options</a>	<a href="#">See Laminate Selection</a>	<a href="#">See PVC Edge Color Options</a>	N None CT2 Dual Power Center Top (See chart on next page) CU1 Single Power Underside <b>5 Foot/Caster</b> G Glide C Caster - BL Black Caster - WG White Caster w/Grey Wheels <b>6 Metal Finish</b> <a href="#">See Metal Finish Color Options</a>

Model Number Breakdown

LKT4872-29TPT					
LK	T	4872	29	TP	T
LOK	Laminate	48" x 72"	Height	Taper Top Shape	T base

Description

Taper Table with T Base at Working Height (continued)

Veneer Tables "LKV" Models

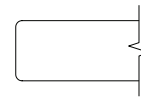

Eased Edge (R3)

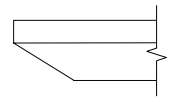

Reverse Bevel Edge (K9)

VEN.	D	W	H	CTN WT	CU FT	① Model	Essentials		Artisan	
	48	72	29	140	71	LKV4872-29TPT	\$3,837		\$4,140	
									\$4,181	\$4,452

LOK - TEAMWORK

Electrical Options and Upcharges

CT2	
Dual Power Center Top - Black	CT2BL - add \$1,773
Dual Power Center Top - White	CT2WH - add \$1,773
CU1	
Single Power Underside - Black	CU11C - add \$690
Single Power Underside with Wireless Charging - Black	CU11CW - add \$1,651

**Note: Order power infeed that best fits application**

To Order, Specify:

① Veneer Model #	② Edge Detail	③ Wood Collection	④ Top Wood Finish	⑤ Electrical	⑥ Base - Foot/Caster	⑦ Metal Color
Veneer (LKV)	<a href="#">See Edge Detail Options</a>	Essentials	<a href="#">See Essentials Top Wood Finish Options</a>	N None CT2 Dual Power Center Top CU1 Single Power Underside (See chart above)	G Glide C Caster - BL Black Caster - WG White Caster with Grey Wheels	<a href="#">See Metal Finish Color Options</a>
		Artisan	④ Top Wood Finish <a href="#">See Artisan Top Wood Finish Options</a>			

Description

Rounded Taper Table with T Base at Working Height

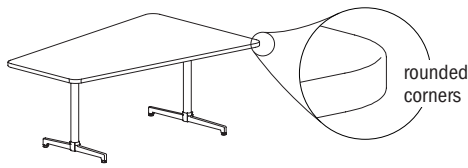

Laminate Tables "LKT" Models

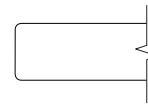

Eased Edge (R3)

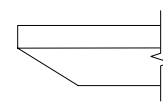

Reverse Bevel Edge (K9)

LAMI	D	W	H	CTN WT	CU FT	Model	Standard Tier 1	Graded In Tier 2	Standard Tier 1	Graded In Tier 2
		48	72	29	140	71	LKT4872-29TPRT	\$3,127	\$3,180	\$3,737

Features:

- price reflects complete table - top and base
- ships KD in multiple cartons

Options:

- specify power/charging option, see below for options and upcharges
- specify glide (G) or caster (C) -choice of black (BL) or white/grey casters (WG)

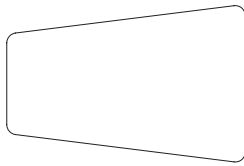

top shape

LOK - TEAMWORK

To Order Specify

1 Laminate Model #	2 Edge Detail	3 Laminate Selection	3a PVC Edge Color	4 Electrical
Laminate (LKT)	<a href="#">See Edge Detail Options</a>	<a href="#">See Laminate Selection</a>	<a href="#">See PVC Edge Color Options</a>	N None CT2 Dual Power Center Top (See chart on next page) CU1 Single Power Underside <b>5 Foot/Caster</b> G Glide C Caster - BL Black Caster - WG White Caster w/Grey Wheels <b>6 Metal Finish</b> <a href="#">See Metal Finish Color Options</a>

Model Number Breakdown

LKT4872-29TPRT						
LK	T	4872	29	TP	R	T
LOK	Laminate	48" x 72"	Height	Taper Top Shape	Rounded Corner	T base

Description

Rounded Taper Table with T Base at Working Height (continued)

Veneer Tables "LKV" Models

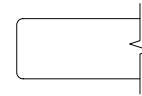

Eased Edge (R3)

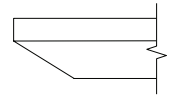

Reverse Bevel Edge (K9)

VEN.	D	W	H	CTN WT	CU FT	① Model	Essentials		Artisan	
							Essentials	Artisan	Essentials	Artisan
	48	72	29	140	71	LKV4872-29TPRT	\$3,837	\$4,140	\$4,181	\$4,452

LOK - TEAMWORK

Electrical Options and Upcharges

CT2	
Dual Power Center Top - Black	CT2BL - add \$1,773
Dual Power Center Top - White	CT2WH - add \$1,773
CU1	
Single Power Underside - Black	CU11C - add \$690
Single Power Underside with Wireless Charging - Black	CU11CW - add \$1,651

**Note: Order power infeed that best fits application**

To Order, Specify:

① Veneer Model #	② Edge Detail	③ Wood Collection	④ Top Wood Finish	⑤ Electrical	⑥ Base - Foot/Caster	⑦ Metal Color
Veneer (LKV)	<a href="#">See Edge Detail Options</a>	Essentials	<a href="#">See Essentials Top Wood Finish Options</a>	N None CT2 Dual Power Center Top CU1 Single Power Underside (See chart above)	G Glide C Caster - BL Black Caster - WG White Caster with Grey Wheels	<a href="#">See Metal Finish Color Options</a>
		Artisan	④ Top Wood Finish <a href="#">See Artisan Top Wood Finish Options</a>			

Description

Wedge Table with T Base  
at Working Height

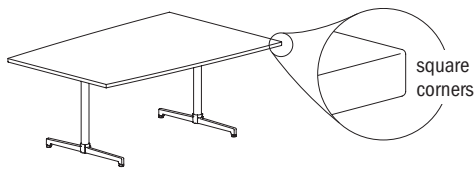

Laminate Tables  
"LKT" Models

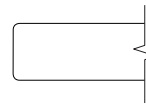

Eased Edge (R3)

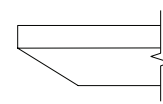

Reverse Bevel Edge (K9)

LAMI	D	W	H	CTN WT	CU FT	Model	Standard Tier 1	Graded In Tier 2	Standard Tier 1	Graded In Tier 2
		48	72	29	127	71	LKT4872-29WDT	\$3,503	\$3,555	\$4,113

Features:

- price reflects complete table - top and base
- ships KD in multiple cartons

Options:

- specify power/charging option, see below for options and upcharges
- specify glide (G) or caster (C) - choice of black (BL) or white/grey casters (WG)

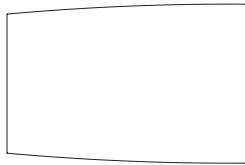

top shape

LOK - TEAMWORK

To Order Specify

1 Laminate Model #	2 Edge Detail	3 Laminate Selection	3a PVC Edge Color	4 Electrical
Laminate (LKT)	<a href="#">See Edge Detail Options</a>	<a href="#">See Laminate Selection</a>	<a href="#">See PVC Edge Color Options</a>	N None CT2 Dual Power Center Top (See chart on next page) CU1 Single Power Underside <b>5 Foot/Caster</b> G Glide C Caster - BL Black Caster - WG White Caster w/Grey Wheels <b>6 Metal Finish</b> <a href="#">See Metal Finish Color Options</a>

Model Number Breakdown

LKT4872-29WDT					
LK	T	4872	29	WD	T
LOK	Laminate	48" x 72"	Height	Wedge Top Shape	T base

Description

Wedge Table with T Base  
at Working Height  
(continued)

Veneer Tables  
"LKV" Models

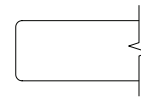

Eased Edge (R3)

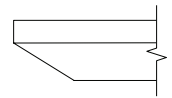

Reverse Bevel Edge (K9)

VEN.	D	W	H	CTN WT	CU FT	① Model	Eased Edge (R3)		Reverse Bevel Edge (K9)	
							Essentials	Artisan	Essentials	Artisan
	48	72	29	124	71	LKV4872-29WDT	\$4,212	\$4,545	\$4,587	\$4,886

LOK - TEAMWORK

Electrical Options and Upcharges

CT2	
Dual Power Center Top - Black	CT2BL - add \$1,773
Dual Power Center Top - White	CT2WH - add \$1,773
CU1	
Single Power Underside - Black	CU11C - add \$690
Single Power Underside with Wireless Charging - Black	CU11CW - add \$1,651

**Note: Order power infeed that best fits application**

To Order, Specify:

① Veneer Model #	② Edge Detail	③ Wood Collection	④ Top Wood Finish	⑤ Electrical	⑥ Base - Foot/Caster	⑦ Metal Color
Veneer (LKV)	<a href="#">See Edge Detail Options</a>	Essentials	<a href="#">See Essentials Top Wood Finish Options</a>	N None CT2 Dual Power Center Top CU1 Single Power Underside (See chart above)	G Glide C Caster - BL Black Caster - WG White Caster with Grey Wheels	<a href="#">See Metal Finish Color Options</a>
		Artisan	④ Top Wood Finish <a href="#">See Artisan Top Wood Finish Options</a>			

Description

Wedge Table with T Base  
at Working Height

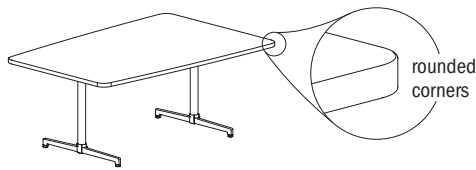

Laminate Tables  
"LKT" Models

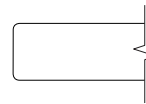

Eased Edge (R3)

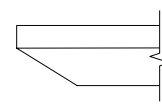

Reverse Bevel Edge (K9)

LAMI	D	W	H	CTN WT	CU FT	Model	Standard Tier 1	Graded In Tier 2	Standard Tier 1	Graded In Tier 2
		48	72	29	156	71	LKT4872-29WDRT	\$2,518	\$2,568	\$3,127

Features:

- price reflects complete table - top and base
- ships KD in multiple cartons

Options:

- specify power/charging option, see below for options and upcharges
- specify glide (G) or caster (C) - choice of black (BL) or white/grey casters (WG)

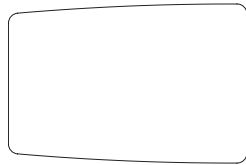

top shape

LOK - TEAMWORK

To Order Specify

1 Laminate Model #	2 Edge Detail	3 Laminate Selection	3a PVC Edge Color	4 Electrical
Laminate (LKT)	<a href="#">See Edge Detail Options</a>	<a href="#">See Laminate Selection</a>	<a href="#">See PVC Edge Color Options</a>	N None CT2 Dual Power Center Top (See chart on next page) CU1 Single Power Underside <b>5 Foot/Caster</b> G Glide C Caster - BL Black Caster - WG White Caster w/Grey Wheels <b>6 Metal Finish</b> <a href="#">See Metal Finish Color Options</a>

Model Number Breakdown

LKT4872-29WDRT						
LK	T	4872	29	WD	R	T
LOK	Laminate	48" x 72"	Height	Wedge Top Shape	Rounded Corner	T base

Description

Wedge Table with T Base  
at Working Height  
(continued)

Veneer Tables  
"LKV" Models

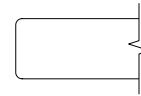

Eased Edge (R3)

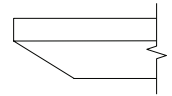

Reverse Bevel Edge (K9)

VEN.	D	W	H	CTN WT	CU FT	① Model	Eased Edge (R3)		Reverse Bevel Edge (K9)	
							Essentials	Artisan	Essentials	Artisan
	48	72	29	156	71	LKV4872-29WDRT	\$3,223	\$3,480	\$3,514	\$3,744

LOK - TEAMWORK

Electrical Options and Upcharges

CT2	
Dual Power Center Top - Black	CT2BL - add \$1,773
Dual Power Center Top - White	CT2WH - add \$1,773
CU1	
Single Power Underside - Black	CU11C - add \$690
Single Power Underside with Wireless Charging - Black	CU11CW - add \$1,651

**Note: Order power infeed that best fits application**

To Order, Specify:

① Veneer Model #	② Edge Detail	③ Wood Collection	④ Top Wood Finish	⑤ Electrical	⑥ Base - Foot/Caster	⑦ Metal Color
Veneer (LKV)	<a href="#">See Edge Detail Options</a>	Essentials	<a href="#">See Essentials Top Wood Finish Options</a>	N None CT2 Dual Power Center Top CU1 Single Power Underside (See chart above)	G Glide C Caster - BL Black Caster - WG White Caster with Grey Wheels	<a href="#">See Metal Finish Color Options</a>
		Artisan	④ Top Wood Finish <a href="#">See Artisan Top Wood Finish Options</a>			

Description

Bullet Table with T Base at Working Height

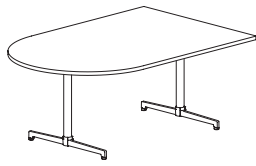

Laminate Tables "LKT" Models

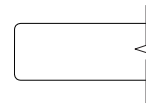

Eased Edge (R3)

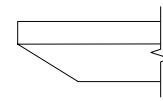

Reverse Bevel Edge (K9)

LAMI	D	W	H	CTN WT	CU FT	Model	Standard Tier 1	Graded In Tier 2	Standard Tier 1	Graded In Tier 2
		48	72	29	153	71	LKT4872-29BUT	\$2,518	\$2,568	\$3,127

Features:

- price reflects complete table - top and base
- ships KD in multiple cartons

Options:

- specify power/charging option, see below for options and upcharges
- specify glide (G) or caster (C) - choice of black (BL) or white/grey casters (WG)

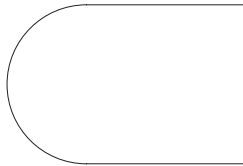

top shape

LOK - TEAMWORK

To Order Specify

1 Laminate Model #	2 Edge Detail	3 Laminate Selection	3a PVC Edge Color	4 Electrical
Laminate (LKT)	<a href="#">See Edge Detail Options</a>	<a href="#">See Laminate Selection</a>	<a href="#">See PVC Edge Color Options</a>	N None CT2 Dual Power Center Top (See chart on next page) CU1 Single Power Underside <b>5 Foot/Caster</b> G Glide C Caster - BL Black Caster - WG White Caster w/Grey Wheels <b>6 Metal Finish</b> <a href="#">See Metal Finish Color Options</a>

Model Number Breakdown

LKT4872-29BUT					
LK	T	4872	29	BU	T
LOK	Laminate	48" x 72"	Height	Bullet Top Shape	T base

Description

Bullet Table with T Base  
at Working Height  
(continued)

Veneer Tables  
"LKV" Models

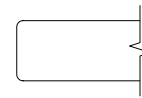

Eased Edge (R3)

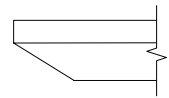

Reverse Bevel Edge (K9)

VEN.	D	W	H	CTN WT	CU FT	① Model	Essentials		Artisan	
							Essentials	Artisan	Essentials	Artisan
	48	72	29	153	71	LKV4872-29BUT	\$3,223	\$3,480	\$3,514	\$3,744

LOK - TEAMWORK

Electrical Options and Upcharges

CT2	
Dual Power Center Top - Black	CT2BL - add \$1,773
Dual Power Center Top - White	CT2WH - add \$1,773
CU1	
Single Power Underside - Black	CU11C - add \$690
Single Power Underside with Wireless Charging - Black	CU11CW - add \$1,651

**Note: Order power infeed that best fits application**

To Order, Specify:

① Veneer Model #	② Edge Detail	③ Wood Collection	④ Top Wood Finish	⑤ Electrical	⑥ Base - Foot/Caster	⑦ Metal Color
Veneer (LKV)	<a href="#">See Edge Detail Options</a>	Essentials	<a href="#">See Essentials Top Wood Finish Options</a>	N None CT2 Dual Power Center Top CU1 Single Power Underside (See chart above)	G Glide C Caster - BL Black Caster - WG White Caster with Grey Wheels	<a href="#">See Metal Finish Color Options</a>
		Artisan	④ Top Wood Finish <a href="#">See Artisan Top Wood Finish Options</a>			

Description

Hive Table with T Base at Working Height

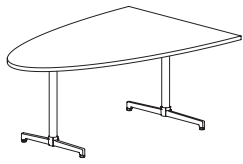

Laminate Tables  
"LKT" Models

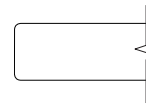

Eased Edge (R3)

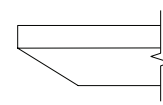

Reverse Bevel Edge (K9)

LAMI	D	W	H	CTN WT	CU FT	Model	Standard Tier 1	Graded In Tier 2	Standard Tier 1	Graded In Tier 2
		48	72	29	135	71	LKT4872-29HVT	\$2,518	\$2,568	\$3,127

Features:

- price reflects complete table - top and base
- ships KD in multiple cartons

Options:

- specify power/charging option, see below for options and upcharges
- specify glide (G) or caster (C) - choice of black (BL) or white/grey casters (WG)

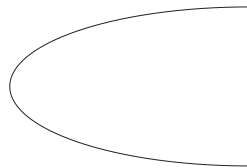

top shape

LOK - TEAMWORK

To Order Specify

1 Laminate Model #	2 Edge Detail	3 Laminate Selection	3a PVC Edge Color	4 Electrical
Laminate (LKT)	<a href="#">See Edge Detail Options</a>	<a href="#">See Laminate Selection</a>	<a href="#">See PVC Edge Color Options</a>	N None CT2 Dual Power Center Top (See chart on next page) CU1 Single Power Underside <b>5 Foot/Caster</b> G Glide C Caster - BL Black Caster - WG White Caster w/Grey Wheels <b>6 Metal Finish</b> <a href="#">See Metal Finish Color Options</a>

Model Number Breakdown

LKT4872-29HVT					
LK	T	4872	29	HV	T
LOK	Laminate	48" x 72"	Height	Hive Top Shape	T base

Description

Hive Table with T Base at Working Height (continued)

Veneer Tables "LKV" Models

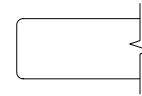

Eased Edge (R3)

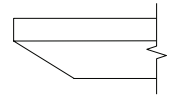

Reverse Bevel Edge (K9)

VEN.	D	W	H	CTN WT	CU FT	① Model	Essentials		Artisan	
							Essentials	Artisan	Essentials	Artisan
	48	72	29	135	71	LKV4872-29HVT	\$3,223	\$3,480	\$3,514	\$3,744

LOK - TEAMWORK

Electrical Options and Upcharges

CT2	
Dual Power Center Top - Black	CT2BL - add \$1,773
Dual Power Center Top - White	CT2WH - add \$1,773
CU1	
Single Power Underside - Black	CU11C - add \$690
Single Power Underside with Wireless Charging - Black	CU11CW - add \$1,651

**Note: Order power infeed that best fits application**

To Order, Specify:

① Veneer Model #	② Edge Detail	③ Wood Collection	④ Top Wood Finish	⑤ Electrical	⑥ Base - Foot/Caster	⑦ Metal Color
Veneer (LKV)	<a href="#">See Edge Detail Options</a>	Essentials	<a href="#">See Essentials Top Wood Finish Options</a>	N None CT2 Dual Power Center Top CU1 Single Power Underside (See chart above)	G Glide C Caster - BL Black Caster - WG White Caster with Grey Wheels	<a href="#">See Metal Finish Color Options</a>
		Artisan	④ Top Wood Finish <a href="#">See Artisan Top Wood Finish Options</a>			

Description

Rectangular Table with T Base at Counter Height

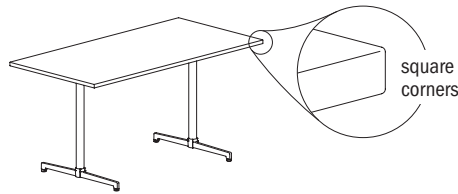

Laminate Tables  
"LKT" Models

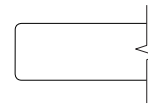

Eased Edge (R3)

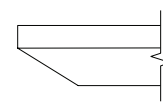

Reverse Bevel Edge (K9)

D	W	H	CTN WT	CU FT	Model	Eased Edge (R3)		Reverse Bevel Edge (K9)	
						Standard Tier 1	Graded In Tier 2	Standard Tier 1	Graded In Tier 2
48	72	36	144	87	LKT4872-36TTT	\$2,783	\$2,840	\$3,424	\$3,478
42	72	36	146	77	LKT4272-36TTT	\$2,658	\$2,708	\$3,288	\$3,335
36	72	36	135	66	LKT3672-36TTT	\$2,407	\$2,491	\$2,969	\$3,055
36	66	36	126	62	LKT3666-36TTT	\$2,333	\$2,407	\$2,889	\$2,969
36	60	36	135	57	LKT3660-36TTT	\$2,233	\$2,309	\$2,796	\$2,866

LAMINATE

Features:

- price reflects complete table - top and base
- ships KD in multiple cartons
- model includes adjustable glide

Options:

- specify power option and or charging option, see below for options and upcharges

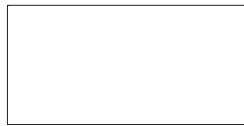

top shape

LOK - TEAMWORK

To Order Specify

1 Laminate Model #	2 Edge Detail	3 Laminate Selection	3a PVC Edge Color	4 Electrical
Laminate (LKT)	<a href="#">See Edge Detail Options</a>	<a href="#">See Laminate Selection</a>	<a href="#">See PVC Edge Color Options</a>	N None CT2 Dual Power Center Top (See chart on next page) CU1 Single Power Underside <b>5 Metal Finish</b> <a href="#">See Metal Finish Color Options</a>

Model Number Breakdown

LKT4872-36TTT					
LK	T	4872	36	TT	T
LOK	Laminate	48" x 72"	Height	Rectangular Top Shape	T base

Description

Rectangular Table with T Base at Counter Height  
(continued)

Veneer Tables  
"LKV" Models

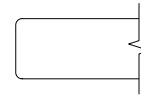

Eased Edge (R3)

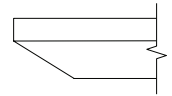

Reverse Bevel Edge (K9)

VENEER	D	W	H	CTN WT	CU FT	① Model	Eased Edge (R3)		Reverse Bevel Edge (K9)	
							Essentials	Artisan	Essentials	Artisan
	48	72	36	140	87	LKV4872-36TTT	\$3,177	\$3,464	\$3,485	\$3,754
	42	72	36	146	77	LKV4272-36TTT	\$3,045	\$3,298	\$3,342	\$3,572
	36	72	36	135	66	LKV3672-36TTT	\$2,781	\$3,028	\$2,999	\$3,240
	36	66	36	126	62	LKV3666-36TTT	\$2,728	\$2,957	\$2,938	\$3,162
	36	60	36	135	57	LKV3660-36TTT	\$2,652	\$2,866	\$2,854	\$3,063

LOK - TEAMWORK

Electrical Options and Upcharges

CT2	
Dual Power Center Top - Black	CT2BL - add \$1,773
Dual Power Center Top - White	CT2WH - add \$1,773
CU1	
Single Power Underside - Black	CU11C - add \$690
Single Power Underside with Wireless Charging - Black	CU11CW - add \$1,651

**Note: Order power infeed that best fits application**

To Order, Specify:

① Veneer Model #	② Edge Detail	③ Wood Collection	④ Top Wood Finish	⑤ Electrical	⑥ Metal Color
Veneer (LKV)	<a href="#">See Edge Detail Options</a>	Essentials	<a href="#">See Essentials Top Wood Finish Options</a>	N None CT2 Dual Power Center Top CU1 Single Power Underside (See chart above)	<a href="#">See Metal Finish Color Options</a>
		Artisan	④ Top Wood Finish <a href="#">See Artisan Top Wood Finish Options</a>		

Description

Rounded Rectangular Table with T Base at Counter Height

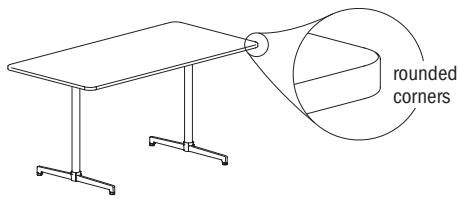

Laminate Tables  
"LKT" Models

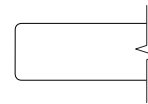

Eased Edge (R3)

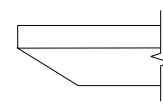

Reverse Bevel Edge (K9)

D	W	H	CTN WT	CU FT	Model	Eased Edge (R3)		Reverse Bevel Edge (K9)	
						Standard Tier 1	Graded In Tier 2	Standard Tier 1	Graded In Tier 2
48	72	36	144	87	LKT4872-36TTRT	\$2,858	\$2,915	\$3,501	\$3,555
42	72	36	136	77	LKT4272-36TTRT	\$2,729	\$2,777	\$3,356	\$3,404
36	72	36	135	66	LKT3672-36TTRT	\$2,530	\$2,614	\$3,091	\$3,178
36	66	36	126	62	LKT3666-36TTRT	\$2,457	\$2,536	\$3,019	\$3,101
36	60	36	135	57	LKT3660-36TTRT	\$2,369	\$2,447	\$2,931	\$3,009

LAMINATE

Features:

- price reflects complete table - top and base
- ships KD in multiple cartons
- model includes adjustable glide

Options:

- specify power option and or charging option, see below for options and upcharges



top shape

LOK - TEAMWORK

To Order Specify

1 Laminate Model #	2 Edge Detail	3 Laminate Selection	3a PVC Edge Color	4 Electrical
Laminate (LKT)	<a href="#">See Edge Detail Options</a>	<a href="#">See Laminate Selection</a>	<a href="#">See PVC Edge Color Options</a>	N None CT2 Dual Power Center Top (See chart on next page) CU1 Single Power Underside <b>5 Metal Finish</b> <a href="#">See Metal Finish Color Options</a>

Model Number Breakdown

LKT4872-36TTRT						
LK	T	4872	36	TT	R	T
LOK	Laminate	48" x 72"	Height	Rectangular Top Shape	Rounded Corner	T base

Description

Rounded Rectangular Table with T Base at Counter Height (continued)

Veneer Tables "LKV" Models

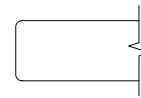

Eased Edge (R3)

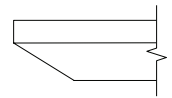

Reverse Bevel Edge (K9)

VENEER	D	W	H	CTN WT	CU FT	① Model	Essentials	Artisan	Essentials	Artisan
	48	72	36	144	87	LKV4872-36TTRT	\$3,253	\$3,540	\$3,562	\$3,828
42	72	36	146	77	LKV4272-36TTRT	\$3,114	\$3,365	\$3,415	\$3,644	
36	72	36	135	66	LKV3672-36TTRT	\$2,977	\$3,238	\$3,086	\$3,332	
36	66	36	126	62	LKV3666-36TTRT	\$2,864	\$3,068	\$3,145	\$3,326	
36	60	36	135	57	LKV3660-36TTRT	\$2,840	\$3,063	\$2,936	\$3,147	

LOK - TEAMWORK

Electrical Options and Upcharges

CT2	
Dual Power Center Top - Black	CT2BL - add \$1,773
Dual Power Center Top - White	CT2WH - add \$1,773
CU1	
Single Power Underside - Black	CU11C - add \$690
Single Power Underside with Wireless Charging - Black	CU11CW - add \$1,651

**Note: Order power infeed that best fits application**

To Order, Specify:

① Veneer Model #	② Edge Detail	③ Wood Collection	④ Top Wood Finish	⑤ Electrical	⑥ Metal Color
Veneer (LKV)	<a href="#">See Edge Detail Options</a>	Essentials	<a href="#">See Essentials Top Wood Finish Options</a>	N None CT2 Dual Power Center Top CU1 Single Power Underside (See chart above)	<a href="#">See Metal Finish Color Options</a>
		Artisan	④ Top Wood Finish <a href="#">See Artisan Top Wood Finish Options</a>		

Description

Rectangular Table with X Base at Counter Height

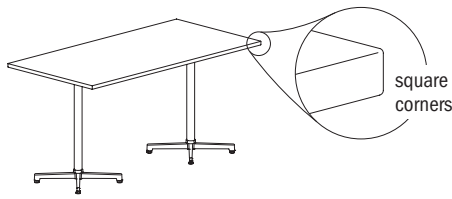

Laminate Tables  
"LKT" Models

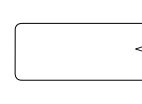

Eased Edge (R3)

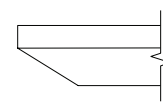

Reverse Bevel Edge (K9)

LAMINATE	D	W	H	CTN WT	CU FT	1 Model	Standard Tier 1	Graded In Tier 2	Standard Tier 1	Graded In Tier 2
		48	72	36	165	87	LKT4872-36TTX	\$3,415	\$3,468	\$4,053
	42	72	36	150	77	LKT4272-36TTX	\$3,288	\$3,335	\$3,915	\$3,962
	36	72	36	133	67	LKT3672-36TTX	\$3,097	\$3,180	\$3,657	\$3,743

Features:

- price reflects complete table - top and base
- ships KD in multiple cartons
- model includes adjustable glide

Options:

- specify power option and or charging option, see below for options and upcharges

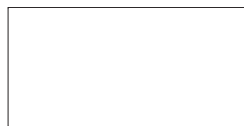

top shape

LOK - TEAMWORK

To Order Specify

1 Laminates Model #	2 Edge Detail	3 Laminates Selection	3a PVC Edge Color	4 Electrical
Laminates (LKT)	<a href="#">See Edge Detail Options</a>	<a href="#">See Laminates Selection</a>	<a href="#">See PVC Edge Color Options</a>	N None CT2 Dual Power Center Top (See chart on next page) CU1 Single Power Underside <b>5 Metal Finish</b> <a href="#">See Metal Finish Color Options</a>

Model Number Breakdown

LKT4872-36TTX					
LK	T	4872	36	TT	X
LOK	Laminates	48" x 72"	Height	Rectangular Top Shape	X base

Description

Rectangular Table with X Base at Counter Height  
(continued)

Veneer Tables  
"LKV" Models

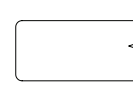

Eased Edge (R3)

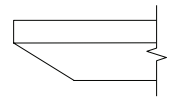

Reverse Bevel Edge (K9)

VENEER	D	W	H	CTN WT	CU FT	① Model	Essentials	Artisan	Essentials	Artisan
		48	72	36	165	87	LKV4872-36TTX	\$3,805	\$4,090	\$4,115
	42	72	36	150	77	LKV4272-36TTX	\$3,671	\$3,925	\$3,969	\$4,204
	36	72	36	133	67	LKV3672-36TTX	\$3,471	\$3,718	\$3,686	\$3,928

LOK - TEAMWORK

Electrical Options and Upcharges

CT2	
Dual Power Center Top - Black	CT2BL - add \$1,773
Dual Power Center Top - White	CT2WH - add \$1,773
CU1	
Single Power Underside - Black	CU11C - add \$690
Single Power Underside with Wireless Charging - Black	CU11CW - add \$1,651

**Note: Order power infeed that best fits application**

To Order, Specify:

① Veneer Model #	② Edge Detail	③ Wood Collection	④ Top Wood Finish	⑤ Electrical	⑥ Metal Color
Veneer (LKV)	<a href="#">See Edge Detail Options</a>	Essentials	<a href="#">See Essentials Top Wood Finish Options</a>	N None CT2 Dual Power Center Top CU1 Single Power Underside (See chart above)	<a href="#">See Metal Finish Color Options</a>
		Artisan	④ Top Wood Finish <a href="#">See Artisan Top Wood Finish Options</a>		

Description

Rounded Rectangular Table with X Base at Counter Height

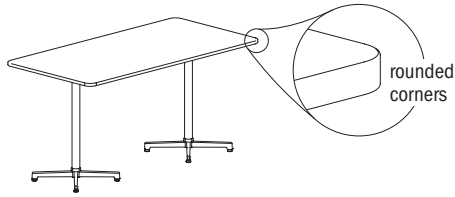

Laminate Tables  
"LKT" Models

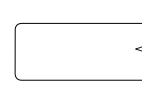

Eased Edge (R3)

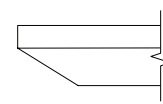

Reverse Bevel Edge (K9)

LAMINATE	D	W	H	CTN WT	CU FT	1 Model	Standard Tier 1	Graded In Tier 2	Standard Tier 1	Graded In Tier 2
		48	72	36	165	87	LKT4872-36TTRX	\$3,485	\$3,545	\$4,129
	42	72	36	150	77	LKT4272-36TTRX	\$3,189	\$3,238	\$3,816	\$3,866
	36	72	36	133	67	LKT3672-36TTRX	\$3,218	\$3,304	\$3,777	\$3,867

Features:

- price reflects complete table - top and base
- ships KD in multiple cartons
- model includes adjustable glide

Options:

- specify power option and or charging option, see below for options and upcharges



top shape

LOK - TEAMWORK

To Order Specify

1 Laminate Model #	2 Edge Detail	3 Laminate Selection	3a PVC Edge Color	4 Electrical
Laminate (LKT)	<a href="#">See Edge Detail Options</a>	<a href="#">See Laminate Selection</a>	<a href="#">See PVC Edge Color Options</a>	N None CT2 Dual Power Center Top (See chart on next page) CU1 Single Power Underside <b>5 Metal Finish</b> <a href="#">See Metal Finish Color Options</a>

Model Number Breakdown

LKT4872-36TTRX						
LK	T	4872	36	TT	R	X
LOK	Laminate	48" x 72"	Height	Rectangular Top Shape	Rounded Corner	X base

Description

Rounded Rectangular Table with X Base at Counter Height (continued)

Veneer Tables  
"LKV" Models

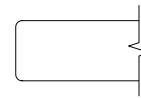

Eased Edge (R3)

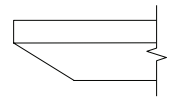

Reverse Bevel Edge (K9)

VENEER	D	W	H	CTN WT	CU FT	① Model	Essentials	Artisan	Essentials	Artisan
		48	72	36	165	87	LKV4872-36TTRX	\$3,879	\$4,168	\$4,189
	42	72	36	150	77	LKV4272-36TTRX	\$3,572	\$3,828	\$3,871	\$4,104
	36	72	36	133	67	LKV3672-36TTRX	\$3,710	\$3,968	\$3,816	\$4,060

LOK - TEAMWORK

Electrical Options and Upcharges

CT2	
Dual Power Center Top - Black	CT2BL - add \$1,773
Dual Power Center Top - White	CT2WH - add \$1,773
CU1	
Single Power Underside - Black	CU11C - add \$690
Single Power Underside with Wireless Charging - Black	CU11CW - add \$1,651

**Note: Order power infeed that best fits application**

To Order, Specify:

① Veneer Model #	② Edge Detail	③ Wood Collection	④ Top Wood Finish	⑤ Electrical	⑥ Metal Color
Veneer (LKV)	<a href="#">See Edge Detail Options</a>	Essentials	<a href="#">See Essentials Top Wood Finish Options</a>	N None CT2 Dual Power Center Top CU1 Single Power Underside (See chart above)	<a href="#">See Metal Finish Color Options</a>
		Artisan	④ Top Wood Finish <a href="#">See Artisan Top Wood Finish Options</a>		

Description

Arc Rectangular Table with T Base at Counter Height

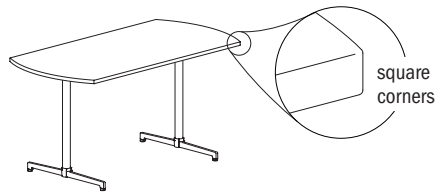

Laminate Tables  
"LKT" Models

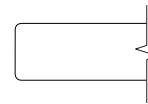

Eased Edge (R3)

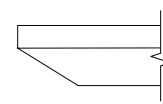

Reverse Bevel Edge (K9)

D	W	H	CTN WT	CU FT	Model	Eased Edge (R3)		Reverse Bevel Edge (K9)	
						Standard Tier 1	Graded In Tier 2	Standard Tier 1	Graded In Tier 2
48	72	36	153	87	LKT4872-36ART	\$2,724	\$2,777	\$3,334	\$3,388
42	72	36	140	78	LKT4272-36ART	\$2,599	\$2,647	\$3,196	\$3,243
36	72	36	131	66	LKT3672-36ART	\$2,410	\$2,493	\$2,944	\$3,026
36	66	36	122	62	LKT3666-36ART	\$2,341	\$2,417	\$2,875	\$2,951
36	60	36	131	57	LKT3660-36ART	\$2,259	\$2,333	\$2,795	\$2,865

LAMINATE

Features:

- price reflects complete table - top and base
- ships KD in multiple cartons
- model includes adjustable glide

Options:

- specify power option and or charging option, see below for options and upcharges

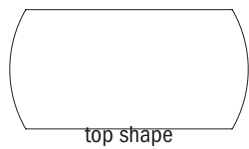

LOK - TEAMWORK

To Order Specify

1 Laminate Model #	2 Edge Detail	3 Laminate Selection	3a PVC Edge Color	4 Electrical
Laminate (LKT)	<a href="#">See Edge Detail Options</a>	<a href="#">See Laminate Selection</a>	<a href="#">See PVC Edge Color Options</a>	N None CT2 Dual Power Center Top (See chart on next page) CU1 Single Power Underside <b>5 Metal Finish</b> <a href="#">See Metal Finish Color Options</a>

Model Number Breakdown

LKT4872-36ART					
LK	T	4872	36	AR	T
LOK	Laminate	48" x 72"	Height	Arc Rectangular Top Shape	T base

Description

Arc Rectangular Table with T Base at Counter Height  
(continued)

Veneer Tables  
"LKV" Models

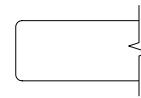

Eased Edge (R3)

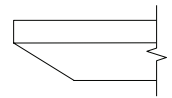

Reverse Bevel Edge (K9)

D	W	H	CTN WT	CU FT	① Model	Eased Edge (R3)		Reverse Bevel Edge (K9)	
						Essentials	Artisan	Essentials	Artisan
48	72	36	153	87	LKV4872-36ART	\$3,431	\$3,706	\$3,737	\$3,982
42	72	36	140	78	LKV4272-36ART	\$3,301	\$3,563	\$3,599	\$3,831
36	72	36	131	66	LKV3672-36ART	\$3,168	\$3,422	\$3,455	\$3,678
36	66	36	122	62	LKV3666-36ART	\$3,063	\$3,308	\$3,340	\$3,555
36	60	36	131	57	LKV3660-36ART	\$2,995	\$3,237	\$3,265	\$3,477

VENEER

LOK - TEAMWORK

Electrical Options and Upcharges

CT2	
Dual Power Center Top - Black	CT2BL - add \$1,773
Dual Power Center Top - White	CT2WH - add \$1,773
CU1	
Single Power Underside - Black	CU11C - add \$690
Single Power Underside with Wireless Charging - Black	CU11CW - add \$1,651

**Note: Order power infeed that best fits application**

To Order, Specify:

① Veneer Model #	② Edge Detail	③ Wood Collection	④ Top Wood Finish	⑤ Electrical	⑥ Metal Color
Veneer (LKV)	<a href="#">See Edge Detail Options</a>	Essentials	<a href="#">See Essentials Top Wood Finish Options</a>	N None CT2 Dual Power Center Top CU1 Single Power Underside (See chart above)	<a href="#">See Metal Finish Color Options</a>
		Artisan	④ Top Wood Finish <a href="#">See Artisan Top Wood Finish Options</a>		

Description

Rounded Arc Rectangular Table with T Base at Counter Height

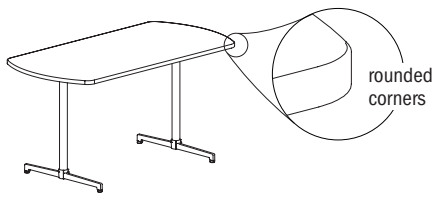

Laminate Tables "LKT" Models

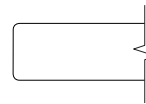

Eased Edge (R3)

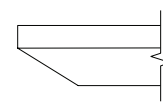

Reverse Bevel Edge (K9)

LAMINATE	D	W	H	CTN WT	CU FT	1 Model	Standard Tier 1	Graded In Tier 2	Standard Tier 1	Graded In Tier 2
		48	72	36	153	87	LKT4872-36ARRT	\$2,724	\$2,777	\$3,334
	42	72	36	140	78	LKT4272-36ARRT	\$2,599	\$2,647	\$3,196	\$3,243
	36	72	36	131	66	LKT3672-36ARRT	\$2,410	\$2,493	\$2,944	\$3,026
	36	66	36	122	62	LKT3666-36ARRT	\$2,341	\$2,417	\$2,875	\$2,951
	36	60	36	131	57	LKT3660-36ARRT	\$2,259	\$2,333	\$2,795	\$2,865

Features:

- price reflects complete table - top and base
- ships KD in multiple cartons
- model includes adjustable glide

Options:

- specify power option and or charging option, see below for options and upcharges

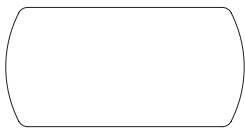

top shape

LOK - TEAMWORK

To Order Specify

1 Laminate Model #	2 Edge Detail	3 Laminate Selection	3a PVC Edge Color	4 Electrical
Laminate (LKT)	<a href="#">See Edge Detail Options</a>	<a href="#">See Laminate Selection</a>	<a href="#">See PVC Edge Color Options</a>	N None CT2 Dual Power Center Top (See chart on next page) CU1 Single Power Underside <b>5 Metal Finish</b> <a href="#">See Metal Finish Color Options</a>

Model Number Breakdown

LKT4872-36ARRT						
LK	T	4872	36	AR	R	T
LOK	Laminate	48" x 72"	Height	Arc Rectangular Top Shape	Rounded Corner	T base

Description

Rounded Arc Rectangular Table with T Base at Counter Height (continued)

Veneer Tables "LKV" Models

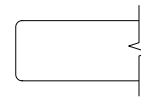

Eased Edge (R3)

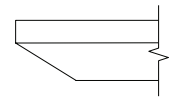

Reverse Bevel Edge (K9)

VENEER	D	W	H	CTN WT	CU FT	Model	Essentials	Artisan	Essentials	Artisan
		48	72	36	153	87	LKV4872-36ARRT	\$3,431	\$3,706	\$3,737
	42	72	36	140	78	LKV4272-36ARRT	\$3,301	\$3,563	\$3,599	\$3,831
	36	72	36	131	66	LKV3672-36ARRT	\$3,168	\$3,422	\$3,455	\$3,678
	36	66	36	122	62	LKV3666-36ARRT	\$3,063	\$3,308	\$3,340	\$3,555
	36	60	36	131	57	LKV3660-36ARRT	\$2,995	\$3,237	\$3,265	\$3,477

LOK - TEAMWORK

Electrical Options and Upcharges

CT2	
Dual Power Center Top - Black	CT2BL - add \$1,773
Dual Power Center Top - White	CT2WH - add \$1,773
CU1	
Single Power Underside - Black	CU11C - add \$690
Single Power Underside with Wireless Charging - Black	CU11CW - add \$1,651

**Note: Order power infeed that best fits application**

To Order, Specify:

1 Veneer Model #	2 Edge Detail	3 Wood Collection	4 Top Wood Finish	5 Electrical	6 Metal Color
Veneer (LKV)	<a href="#">See Edge Detail Options</a>	Essentials	<a href="#">See Essentials Top Wood Finish Options</a>	N None CT2 Dual Power Center Top CU1 Single Power Underside (See chart above)	<a href="#">See Metal Finish Color Options</a>
		Artisan	<b>4 Top Wood Finish</b> <a href="#">See Artisan Top Wood Finish Options</a>		

Description

Racetrack Table with T Base at Counter Height



Laminate Tables  
"LKT" Models

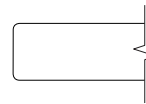

Eased Edge (R3)

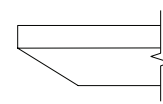

Reverse Bevel Edge (K9)

LAMINATE	D	W	H	CTN WT	CU FT	1 Model	Standard Tier 1	Graded In Tier 2	Standard Tier 1	Graded In Tier 2
		42	72	36	136	77	LKT4272-36RKT	\$2,599	\$2,647	\$3,196
	36	72	36	125	66	LKT3672-36RKT	\$2,410	\$2,493	\$2,944	\$3,026
	36	66	36	117	62	LKT3666-36RKT	\$2,341	\$2,417	\$2,875	\$2,951
	36	60	36	125	57	LKT3660-36RKT	\$2,259	\$2,333	\$2,795	\$2,865

Features:

- price reflects complete table - top and base
- ships KD in multiple cartons
- model includes adjustable glide

Options:

- specify power option and or charging option, see below for options and upcharges

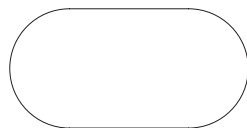

top shape

LOK - TEAMWORK

To Order Specify

1 Laminate Model #	2 Edge Detail	3 Laminate Selection	3a PVC Edge Color	4 Electrical
Laminate (LKT)	<a href="#">See Edge Detail Options</a>	<a href="#">See Laminate Selection</a>	<a href="#">See PVC Edge Color Options</a>	N None CT2 Dual Power Center Top (See chart on next page) CU1 Single Power Underside <b>5 Metal Finish</b> <a href="#">See Metal Finish Color Options</a>

Model Number Breakdown

LKT4272-36RKT					
LK	T	4272	36	RK	T
LOK	Laminate	42" x 72"	Height	Racetrack Top Shape	T base

133.9 Lok

Description

Racetrack Table with T Base at Counter Height  
(continued)

Veneer Tables  
"LKV" Models

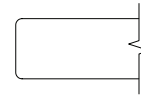

Eased Edge (R3)

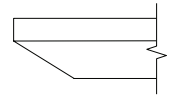

Reverse Bevel Edge (K9)

VENEER	D	W	H	CTN WT	CU FT	① Model	Essentials	Artisan	Essentials	Artisan
		48	72	36	144	87	LKV4872-36RKT	\$3,431	\$3,706	\$3,737
	36	72	36	125	66	LKV3672-36RKT	\$3,168	\$3,422	\$3,455	\$3,678
	36	66	36	117	62	LKV3666-36RKT	\$3,063	\$3,308	\$3,340	\$3,555
	36	60	36	125	57	LKV3660-36RKT	\$2,995	\$3,237	\$3,265	\$3,477

LOK - TEAMWORK

Electrical Options and Upcharges

CT2	
Dual Power Center Top - Black	CT2BL - add \$1,773
Dual Power Center Top - White	CT2WH - add \$1,773
CU1	
Single Power Underside - Black	CU11C - add \$690
Single Power Underside with Wireless Charging - Black	CU11CW - add \$1,651

**Note: Order power infeed that best fits application**

To Order, Specify:

① Veneer Model #	② Edge Detail	③ Wood Collection	④ Top Wood Finish	⑤ Electrical	⑥ Metal Color
Veneer (LKV)	<a href="#">See Edge Detail Options</a>	Essentials	<a href="#">See Essentials Top Wood Finish Options</a>	N None CT2 Dual Power Center Top CU1 Single Power Underside (See chart above)	<a href="#">See Metal Finish Color Options</a>
		Artisan	④ Top Wood Finish <a href="#">See Artisan Top Wood Finish Options</a>		

Description

Oval Table with T Base at Counter Height



Laminate Tables  
"LKT" Models

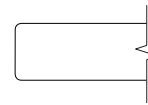

Eased Edge (R3)

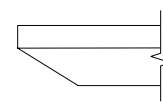

Reverse Bevel Edge (K9)

LAMI	D	W	H	CTN WT	CU FT	1 Model	Standard Tier 1	Graded In Tier 2	Standard Tier 1	Graded In Tier 2
		36	72	36	113	67	LKT3672-360VT	\$2,410	\$2,493	\$2,944

Features:

- price reflects complete table - top and base
- ships KD in multiple cartons
- model includes adjustable glide

Options:

- specify power option and or charging option, see below for options and upcharges

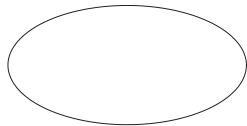

top shape

LOK - TEAMWORK

To Order Specify

1 Laminate Model #	2 Edge Detail	3 Laminate Selection	3a PVC Edge Color	4 Electrical
Laminate (LKT)	<a href="#">See Edge Detail Options</a>	<a href="#">See Laminate Selection</a>	<a href="#">See PVC Edge Color Options</a>	N None CT2 Dual Power Center Top (See chart on next page) CU1 Single Power Underside <b>5 Metal Finish</b> <a href="#">See Metal Finish Color Options</a>

Model Number Breakdown

LKT3672-360VT					
LK	T	3672	36	OV	T
LOK	Laminate	36" x 72"	Height	Oval Top Shape	T base

Description

Oval Table with T Base at Counter Height  
(continued)

Veneer Tables  
"LKV" Models

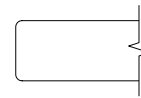

Eased Edge (R3)

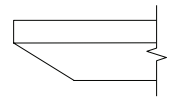

Reverse Bevel Edge (K9)

VEN.	D	W	H	CTN WT	CU FT	① Model	Eased Edge (R3)		Reverse Bevel Edge (K9)	
							Essentials	Artisan	Essentials	Artisan
	36	72	36	113	67	LKV3672-360VT	\$2,977	\$3,216	\$3,243	\$3,456

LOK - TEAMWORK

Electrical Options and Upcharges

CT2	
Dual Power Center Top - Black	CT2BL - add \$1,773
Dual Power Center Top - White	CT2WH - add \$1,773
CU1	
Single Power Underside - Black	CU11C - add \$690
Single Power Underside with Wireless Charging - Black	CU11CW - add \$1,651

**Note: Order power infeed that best fits application**

To Order, Specify:

① Veneer Model #	② Edge Detail	③ Wood Collection	④ Top Wood Finish	⑤ Electrical	⑥ Metal Color
Veneer (LKV)	<a href="#">See Edge Detail Options</a>	Essentials	<a href="#">See Essentials Top Wood Finish Options</a>	N None CT2 Dual Power Center Top CU1 Single Power Underside (See chart above)	<a href="#">See Metal Finish Color Options</a>
		Artisan	④ Top Wood Finish <a href="#">See Artisan Top Wood Finish Options</a>		

Description

Boat Table with T Base at Counter Height

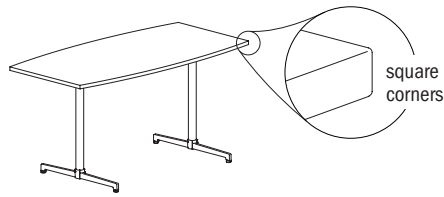

Laminate Tables  
"LKT" Models

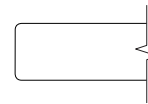

Eased Edge (R3)

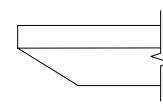

Reverse Bevel Edge (K9)

LAMINATE	D	W	H	CTN WT	CU FT	1 Model	Standard Tier 1	Graded In Tier 2	Standard Tier 1	Graded In Tier 2
	48	72	36	156	87	LKT4872-36BTT	\$2,724	\$2,777	\$3,334	\$3,388
	42	72	36	107	87	LKT4272-36BTT	\$2,599	\$2,647	\$3,196	\$3,243
	36	72	36	130	66	LKT3672-36BTT	\$2,410	\$2,493	\$2,944	\$3,026
	36	66	36	122	62	LKT3666-36BTT	\$2,341	\$2,417	\$2,875	\$2,951
	36	60	36	130	57	LKT3660-36BTT	\$2,259	\$2,333	\$2,795	\$2,865

Features:

- price reflects complete table - top and base
- ships KD in multiple cartons
- model includes adjustable glide

Options:

- specify power option and or charging option, see below for options and upcharges



top shape

LOK - TEAMWORK

To Order Specify

1 Laminate Model #	2 Edge Detail	3 Laminate Selection	3a PVC Edge Color	4 Electrical
Laminate (LKT)	<a href="#">See Edge Detail Options</a>	<a href="#">See Laminate Selection</a>	<a href="#">See PVC Edge Color Options</a>	N None CT2 Dual Power Center Top (See chart on next page) CU1 Single Power Underside <b>5 Metal Finish</b> <a href="#">See Metal Finish Color Options</a>

Model Number Breakdown

LKT4872-36BTT					
LK	T	4872	36	BT	T
LOK	Laminate	48" x 72"	Height	Boat Top Shape	T base

Description

Boat Table with T Base at Counter Height  
(continued)

Veneer Tables  
"LKV" Models

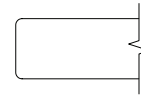

Eased Edge (R3)

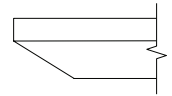

Reverse Bevel Edge (K9)

D	W	H	CTN WT	CU FT	① Model	Eased Edge (R3)		Reverse Bevel Edge (K9)	
						Essentials	Artisan	Essentials	Artisan
48	72	36	156	87	LKV4872-36BTT	\$3,431	\$3,706	\$3,737	\$3,982
42	72	36	143	78	LKV4272-36BTT	\$3,301	\$3,563	\$3,599	\$3,831
36	72	36	130	66	LKV3672-36BTT	\$3,168	\$3,422	\$3,455	\$3,678
36	66	36	122	62	LKV3666-36BTT	\$3,063	\$3,308	\$3,340	\$3,555
36	60	36	130	57	LKV3660-36BTT	\$2,995	\$3,237	\$3,265	\$3,477

VENEER

LOK - TEAMWORK

Electrical Options and Upcharges

CT2	
Dual Power Center Top - Black	CT2BL - add \$1,773
Dual Power Center Top - White	CT2WH - add \$1,773
CU1	
Single Power Underside - Black	CU11C - add \$690
Single Power Underside with Wireless Charging - Black	CU11CW - add \$1,651

**Note: Order power infeed that best fits application**

To Order, Specify:

① Veneer Model #	② Edge Detail	③ Wood Collection	④ Top Wood Finish	⑤ Electrical	⑥ Metal Color
Veneer (LKV)	<a href="#">See Edge Detail Options</a>	Essentials	<a href="#">See Essentials Top Wood Finish Options</a>	N None CT2 Dual Power Center Top CU1 Single Power Underside (See chart above)	<a href="#">See Metal Finish Color Options</a>
		Artisan	④ Top Wood Finish <a href="#">See Artisan Top Wood Finish Options</a>		

Description

Rounded Boat Table with T Base at Counter Height

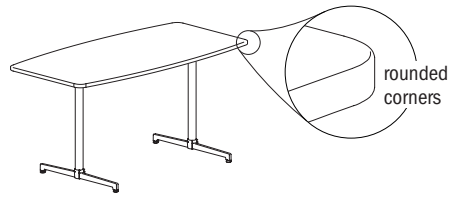

Laminate Tables  
"LKT" Models

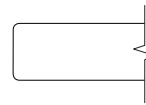

Eased Edge (R3)

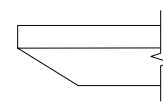

Reverse Bevel Edge (K9)

D	W	H	CTN WT	CU FT	① Model	Eased Edge (R3)		Reverse Bevel Edge (K9)	
						Standard Tier 1	Graded In Tier 2	Standard Tier 1	Graded In Tier 2
48	72	36	156	87	LKT4872-36BTRT	\$2,724	\$2,777	\$3,334	\$3,388
42	72	36	143	78	LKT4272-36BTRT	\$2,599	\$2,647	\$3,196	\$3,243
36	72	36	130	66	LKT3672-36BTRT	\$2,410	\$2,493	\$2,944	\$3,026
36	66	36	122	62	LKT3666-36BTRT	\$2,341	\$2,417	\$2,875	\$2,951
36	60	36	130	57	LKT3660-36BTRT	\$2,259	\$2,333	\$2,795	\$2,865

LAMINATE

Features:

- price reflects complete table - top and base
- ships KD in multiple cartons
- model includes adjustable glide

Options:

- specify power option and or charging option, see below for options and upcharges



top shape

LOK - TEAMWORK

To Order Specify

① Laminate Model #	② Edge Detail	③ Laminate Selection	④ PVC Edge Color	⑤ Electrical
Laminate (LKT)	<a href="#">See Edge Detail Options</a>	<a href="#">See Laminate Selection</a>	<a href="#">See PVC Edge Color Options</a>	N None CT2 Dual Power Center Top (See chart on next page) CU1 Single Power Underside <b>⑤ Metal Finish</b> <a href="#">See Metal Finish Color Options</a>

Model Number Breakdown

LKT3048-29TTT						
LK	T	4872	36	BT	R	T
LOK	Laminate	48" x 72"	Height	Boat Top Shape	Rounded Corner	T base

Description

Rounded Boat Table with T Base at Counter Height  
(continued)

Veneer Tables  
"LKV" Models

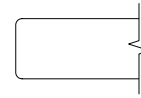

Eased Edge (R3)

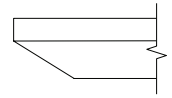

Reverse Bevel Edge (K9)

VENEER	D	W	H	CTN WT	CU FT	① Model	Essentials	Artisan	Essentials	Artisan
		48	72	36	156	87	LKV4872-36BTRT	\$3,431	\$3,706	\$3,737
	42	72	36	143	78	LKV4272-36BTRT	\$3,301	\$3,563	\$3,599	\$3,831
	36	72	36	130	66	LKV3672-36BTRT	\$3,168	\$3,422	\$3,455	\$3,678
	36	66	36	122	62	LKV3666-36BTRT	\$3,063	\$3,308	\$3,340	\$3,555
	36	60	36	130	57	LKV3660-36BTRT	\$2,995	\$3,237	\$3,265	\$3,477

LOK - TEAMWORK

Electrical Options and Upcharges

CT2	
Dual Power Center Top - Black	CT2BL - add \$1,773
Dual Power Center Top - White	CT2WH - add \$1,773
CU1	
Single Power Underside - Black	CU11C - add \$690
Single Power Underside with Wireless Charging - Black	CU11CW - add \$1,651

**Note: Order power infeed that best fits application**

To Order, Specify:

① Veneer Model #	② Edge Detail	③ Wood Collection	④ Top Wood Finish	⑤ Electrical	⑥ Metal Color
Veneer (LKV)	<a href="#">See Edge Detail Options</a>	Essentials	<a href="#">See Essentials Top Wood Finish Options</a>	N None CT2 Dual Power Center Top CU1 Single Power Underside (See chart above)	<a href="#">See Metal Finish Color Options</a>
		Artisan	④ Top Wood Finish <a href="#">See Artisan Top Wood Finish Options</a>		

Description

Rounded Double Chevron Table with T Base at Counter Height

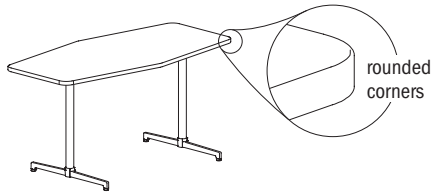

Laminate Tables "LKT" Models

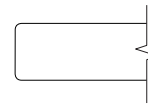

Eased Edge (R3)

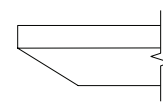

Reverse Bevel Edge (K9)

LAMINATE

D	W	H	CTN WT	CU FT	Model	Eased Edge (R3)		Reverse Bevel Edge (K9)	
						Standard Tier 1	Graded In Tier 2	Standard Tier 1	Graded In Tier 2
48	72	36	150	87	LKT4872-36DCRT	\$2,724	\$2,777	\$3,334	\$3,388
48	60	36	131	74	LKT4860-36DCRT	\$2,520	\$2,563	\$3,115	\$3,158
42	72	36	136	77	LKT4272-36DCRT	\$2,599	\$2,647	\$3,196	\$3,243
42	60	36	119	65	LKT4260-36DCRT	\$2,415	\$2,455	\$3,002	\$3,041
36	72	36	122	66	LKT3672-36DCRT	\$2,410	\$2,493	\$2,944	\$3,026
36	60	36	122	57	LKT3660-36DCRT	\$2,259	\$2,333	\$2,795	\$2,865

Features:

- price reflects complete table - top and base
- ships KD in multiple cartons
- model includes adjustable glide

Options:

- specify power option and or charging option, see below for options and upcharges

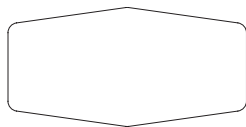

top shape

LOK - TEAMWORK

To Order Specify

1 Laminate Model #	2 Edge Detail	3 Laminate Selection	3a PVC Edge Color	4 Electrical
Laminate (LKT)	<a href="#">See Edge Detail Options</a>	<a href="#">See Laminate Selection</a>	<a href="#">See PVC Edge Color Options</a>	N None CT2 Dual Power Center Top (See chart on next page) CU1 Single Power Underside <b>5 Metal Finish</b> <a href="#">See Metal Finish Color Options</a>

Model Number Breakdown

LKT4872-36DCRT						
LK	T	4872	36	DC	R	T
LOK	Laminate	48" x 72"	Height	Double Chevron Top Shape	Rounded Corner	T base

Description

Rounded Double Chevron Table with T Base at Counter Height (continued)

Veneer Tables  
"LKV" Models

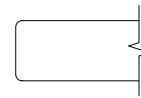

Eased Edge (R3)

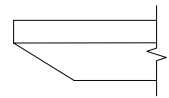

Reverse Bevel Edge (K9)

D	W	H	CTN WT	CU FT	① Model	Eased Edge (R3)		Reverse Bevel Edge (K9)	
						Essentials	Artisan	Essentials	Artisan
48	72	36	150	87	LKV4872-36DCRT	\$3,431	\$3,706	\$3,737	\$3,982
48	60	36	131	74	LKV4860-36DCRT	\$3,217	\$3,473	\$3,508	\$3,732
42	72	36	136	77	LKV4272-36DCRT	\$3,301	\$3,563	\$3,599	\$3,831
	60	36	119	65	LKV4260-36DCRT	\$3,108	\$3,355	\$3,388	\$3,606
36	72	36	122	66	LKV3672-36DCRT	\$3,125	\$3,375	\$3,404	\$3,626
36	60	36	122	57	LKV3660-36DCRT	\$2,950	\$3,188	\$3,217	\$3,425

VENEER

LOK - TEAMWORK

Electrical Options and Upcharges

CT2	
Dual Power Center Top - Black	CT2BL - add \$1,773
Dual Power Center Top - White	CT2WH - add \$1,773
CU1	
Single Power Underside - Black	CU11C - add \$690
Single Power Underside with Wireless Charging - Black	CU11CW - add \$1,651

**Note: Order power infeed that best fits application**

To Order, Specify:

① Veneer Model #	② Edge Detail	③ Wood Collection	④ Top Wood Finish	⑤ Electrical	⑥ Metal Color
Veneer (LKV)	<a href="#">See Edge Detail Options</a>	Essentials	<a href="#">See Essentials Top Wood Finish Options</a>	N None CT2 Dual Power Center Top CU1 Single Power Underside (See chart above)	<a href="#">See Metal Finish Color Options</a>
		Artisan	④ Top Wood Finish <a href="#">See Artisan Top Wood Finish Options</a>		

Description

Taper Table with T Base at Counter Height

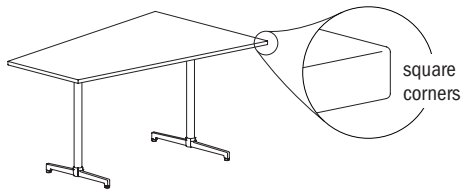

Laminate Tables  
"LKT" Models

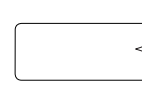

Eased Edge (R3)

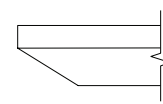

Reverse Bevel Edge (K9)

LAMI	D	W	H	CTN WT	CU FT	1 Model	Standard Tier 1	Graded In Tier 2	Standard Tier 1	Graded In Tier 2
		48	72	36	140	87	LKT4872-36TPT	\$2,736	\$2,792	\$3,346

Features:

- price reflects complete table - top and base
- ships KD in multiple cartons
- model includes adjustable glide

Options:

- specify power option and or charging option, see below for options and upcharges

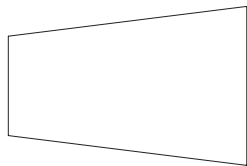

top shape

LOK - TEAMWORK

To Order Specify

1 Laminate Model #	2 Edge Detail	3 Laminate Selection	3a PVC Edge Color	4 Electrical
Laminate (LKT)	<a href="#">See Edge Detail Options</a>	<a href="#">See Laminate Selection</a>	<a href="#">See PVC Edge Color Options</a>	N None CT2 Dual Power Center Top (See chart on next page) CU1 Single Power Underside <b>5 Metal Finish</b> <a href="#">See Metal Finish Color Options</a>

Model Number Breakdown

LKT4872-36TPT					
LK	T	4872	36	TP	T
LOK	Laminate	48" x 72"	Height	Taper Top Shape	T base

Description

Taper Table with T Base at Counter Height  
(continued)

Veneer Tables  
"LKV" Models

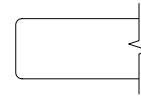

Eased Edge (R3)

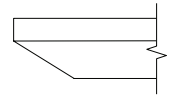

Reverse Bevel Edge (K9)

VEN.	D	W	H	CTN WT	CU FT	① Model	Eased Edge (R3)		Reverse Bevel Edge (K9)	
							Essentials	Artisan	Essentials	Artisan
	48	72	36	140	87	LKV4872-36TPT	\$3,444	\$3,721	\$3,755	\$3,999

LOK - TEAMWORK

Electrical Options and Upcharges

CT2	
Dual Power Center Top - Black	CT2BL - add \$1,773
Dual Power Center Top - White	CT2WH - add \$1,773
CU1	
Single Power Underside - Black	CU11C - add \$690
Single Power Underside with Wireless Charging - Black	CU11CW - add \$1,651

**Note: Order power infeed that best fits application**

To Order, Specify:

① Veneer Model #	② Edge Detail	③ Wood Collection	④ Top Wood Finish	⑤ Electrical	⑥ Metal Color
Veneer (LKV)	<a href="#">See Edge Detail Options</a>	Essentials	<a href="#">See Essentials Top Wood Finish Options</a>	N None CT2 Dual Power Center Top CU1 Single Power Underside (See chart above)	<a href="#">See Metal Finish Color Options</a>
		Artisan	④ Top Wood Finish <a href="#">See Artisan Top Wood Finish Options</a>		

Description

Rounded Taper Table with T Base at Counter Height

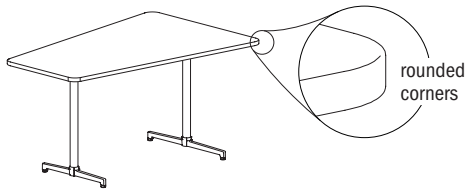

Laminate Tables  
"LKT" Models

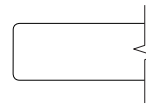

Eased Edge (R3)

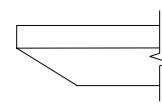

Reverse Bevel Edge (K9)

LAMI	D	W	H	CTN WT	CU FT	Model	Standard Tier 1	Graded In Tier 2	Standard Tier 1	Graded In Tier 2
		48	72	36	140	87	LKT4872-36TPRT	\$2,736	\$2,792	\$3,346

Features:

- price reflects complete table - top and base
- ships KD in multiple cartons
- model includes adjustable glide

Options:

- specify power option and or charging option, see below for options and upcharges

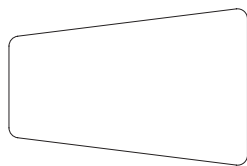

top shape

LOK - TEAMWORK

To Order Specify

1 Laminate Model #	2 Edge Detail	3 Laminate Selection	3a PVC Edge Color	4 Electrical
Laminate (LKT)	<a href="#">See Edge Detail Options</a>	<a href="#">See Laminate Selection</a>	<a href="#">See PVC Edge Color Options</a>	N None CT2 Dual Power Center Top (See chart on next page) CU1 Single Power Underside <b>5 Metal Finish</b> <a href="#">See Metal Finish Color Options</a>

Model Number Breakdown

LKT4872-36TPRT						
LK	T	4872	36	TP	R	T
LOK	Laminate	48" x 72"	Height	Taper Top Shape	Rounded Corner	T base

Description

Rounded Taper Table with T Base at Counter Height  
(continued)

Veneer Tables  
"LKV" Models

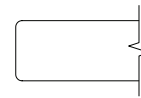

Eased Edge (R3)

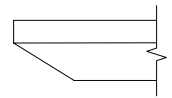

Reverse Bevel Edge (K9)

VEN.	D	W	H	CTN WT	CU FT	① Model	Eased Edge (R3)		Reverse Bevel Edge (K9)	
							Essentials	Artisan	Essentials	Artisan
	48	72	36	140	87	LKV4872-36TPRT	\$3,444	\$3,721	\$3,755	\$3,999

LOK - TEAMWORK

Electrical Options and Upcharges

CT2	
Dual Power Center Top - Black	CT2BL - add \$1,773
Dual Power Center Top - White	CT2WH - add \$1,773
CU1	
Single Power Underside - Black	CU11C - add \$690
Single Power Underside with Wireless Charging - Black	CU11CW - add \$1,651

**Note: Order power infeed that best fits application**

To Order, Specify:

① Veneer Model #	② Edge Detail	③ Wood Collection	④ Top Wood Finish	⑤ Electrical	⑥ Metal Color
Veneer (LKV)	<a href="#">See Edge Detail Options</a>	Essentials	<a href="#">See Essentials Top Wood Finish Options</a>	N None CT2 Dual Power Center Top CU1 Single Power Underside (See chart above)	<a href="#">See Metal Finish Color Options</a>
		Artisan	④ Top Wood Finish <a href="#">See Artisan Top Wood Finish Options</a>		

Description

Bullet Table with T Base at Counter Height

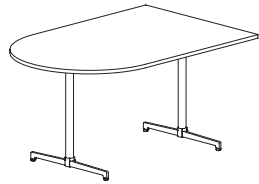

Laminate Tables  
"LKT" Models

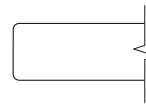

Eased Edge (R3)

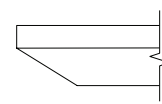

Reverse Bevel Edge (K9)

LAMI	D	W	H	CTN WT	CU FT	① Model	Standard Tier 1	Graded In Tier 2	Standard Tier 1	Graded In Tier 2
		48	72	36	154	87	LKT4872-36BUT	\$2,724	\$2,777	\$3,334

Features:

- price reflects complete table - top and base
- ships KD in multiple cartons
- model includes adjustable glide

Options:

- specify power option and or charging option, see below for options and upcharges

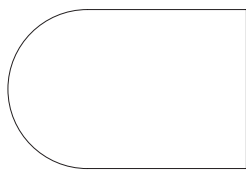

top shape

LOK - TEAMWORK

To Order Specify

① Laminate Model #	② Edge Detail	③ Laminate Selection	④ PVC Edge Color	⑤ Electrical
Laminate (LKT)	<a href="#">See Edge Detail Options</a>	<a href="#">See Laminate Selection</a>	<a href="#">See PVC Edge Color Options</a>	N None CT2 Dual Power Center Top (See chart on next page) CU1 Single Power Underside <b>⑤ Metal Finish</b> <a href="#">See Metal Finish Color Options</a>

Model Number Breakdown

LKT4872-36BUT					
LK	T	4872	36	BU	T
LOK	Laminate	48" x 72"	Height	Bullet Top Shape	T base

Description

Bullet Table with T Base at Counter Height  
(continued)

Veneer Tables  
"LKV" Models

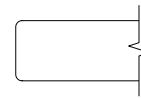

Eased Edge (R3)

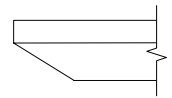

Reverse Bevel Edge (K9)

VEN.	D	W	H	CTN WT	CU FT	① Model	Eased Edge (R3)		Reverse Bevel Edge (K9)	
							Essentials	Artisan	Essentials	Artisan
	48	72	36	154	87	LKV4872-36BUT	\$3,431	\$3,706	\$3,737	\$3,982

LOK - TEAMWORK

Electrical Options and Upcharges

CT2	
Dual Power Center Top - Black	CT2BL - add \$1,773
Dual Power Center Top - White	CT2WH - add \$1,773
CU1	
Single Power Underside - Black	CU11C - add \$690
Single Power Underside with Wireless Charging - Black	CU11CW - add \$1,651

**Note: Order power infeed that best fits application**

To Order, Specify:

① Veneer Model #	② Edge Detail	③ Wood Collection	④ Top Wood Finish	⑤ Electrical	⑥ Metal Color
Veneer (LKV)	<a href="#">See Edge Detail Options</a>	Essentials	<a href="#">See Essentials Top Wood Finish Options</a>	N None CT2 Dual Power Center Top CU1 Single Power Underside (See chart above)	<a href="#">See Metal Finish Color Options</a>
		Artisan	④ Top Wood Finish <a href="#">See Artisan Top Wood Finish Options</a>		

Description

Hive Table with T Base at Counter Height

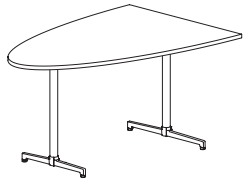

Laminate Tables  
"LKT" Models

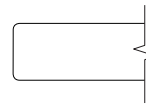

Eased Edge (R3)

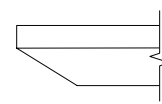

Reverse Bevel Edge (K9)

LAMI	D	W	H	CTN WT	CU FT	Model	Standard Tier 1	Graded In Tier 2	Standard Tier 1	Graded In Tier 2
		48	72	36	135	87	LKT4872-36HVT	\$2,724	\$2,777	\$3,334

Features:

- price reflects complete table - top and base
- ships KD in multiple cartons
- model includes adjustable glide

Options:

- specify power option and or charging option, see below for options and upcharges

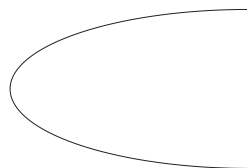

top shape

LOK - TEAMWORK

To Order Specify

1 Laminate Model #	2 Edge Detail	3 Laminate Selection	3a PVC Edge Color	4 Electrical
Laminate (LKT)	<a href="#">See Edge Detail Options</a>	<a href="#">See Laminate Selection</a>	<a href="#">See PVC Edge Color Options</a>	N None CT2 Dual Power Center Top (See chart on next page) CU1 Single Power Underside <b>5 Metal Finish</b> <a href="#">See Metal Finish Color Options</a>

Model Number Breakdown

LKT4872-36HVT					
LK	T	4872	36	HV	T
LOK	Laminate	48" x 72"	Height	Hive Top Shape	T base

Description

Hive Table with T Base at Counter Height  
(continued)

Veneer Tables  
"LKV" Models

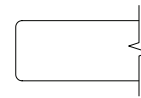

Eased Edge (R3)

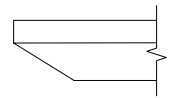

Reverse Bevel Edge (K9)

VEN.	D	W	H	CTN WT	CU FT	① Model	Essentials		Artisan	
	48	72	36	135	87	LKV4872-36HVT	\$3,431		\$3,706	
									\$3,737	\$3,982

LOK - TEAMWORK

Electrical Options and Upcharges

CT2	
Dual Power Center Top - Black	CT2BL - add \$1,773
Dual Power Center Top - White	CT2WH - add \$1,773
CU1	
Single Power Underside - Black	CU11C - add \$690
Single Power Underside with Wireless Charging - Black	CU11CW - add \$1,651

**Note: Order power infeed that best fits application**

To Order, Specify:

① Veneer Model #	② Edge Detail	③ Wood Collection	④ Top Wood Finish	⑤ Electrical	⑥ Metal Color
Veneer (LKV)	<a href="#">See Edge Detail Options</a>	Essentials	<a href="#">See Essentials Top Wood Finish Options</a>	N None CT2 Dual Power Center Top CU1 Single Power Underside (See chart above)	<a href="#">See Metal Finish Color Options</a>
		Artisan	④ Top Wood Finish <a href="#">See Artisan Top Wood Finish Options</a>		

Description

Intersect Table with T Base at Counter Height



Laminate Tables  
"LKT" Models

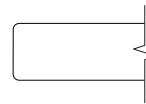

Eased Edge (R3)

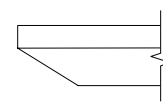

Reverse Bevel Edge (K9)

LAMINATE	D	W	H	CTN WT	CU FT	Model	Standard Tier 1	Graded In Tier 2	Standard Tier 1	Graded In Tier 2
		30	60	36	118	48	LKT3060-36INT	\$2,464	\$2,493	\$3,034
	24	60	36	113	40	LKT2460-36INT	\$2,409	\$2,430	\$2,966	\$2,990

Features:

- price reflects complete table - top and base
- ships KD in multiple cartons
- model includes adjustable glide

Options:

- specify power option; None (N), add \$594 for EC23 (CTEC23), add \$474 for EC24 (CTEC24)

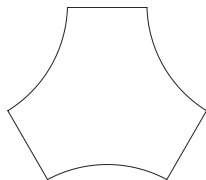

top shape

LOK - TEAMWORK

To Order Specify

Laminate Model #	2 Edge Detail	3 Laminate Selection	3a PVC Edge Color	4 Electrical
Laminate (LKT)	<a href="#">See Edge Detail Options</a>	<a href="#">See Laminate Selection</a>	<a href="#">See PVC Edge Color Options</a>	N None CTEC23 Power Center Top (See chart on next page) CTEC24 Power Center Top <b>5 Metal Finish</b> <a href="#">See Metal Finish Color Options</a>

Model Number Breakdown

LKT3060-36INT					
LK	T	3060	36	IN	T
LOK	Laminate	30" x 60"	Height	Intersect Top Shape	T base

Description

Intersect Table with T Base at Counter Height  
(continued)

Veneer Tables  
"LKV" Models

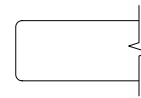

Eased Edge (R3)

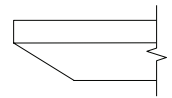

Reverse Bevel Edge (K9)

VENEER	D	W	H	CTN WT	CU FT	① Model	Essentials	Artisan	Essentials	Artisan
	30	60	36	118	48	LKV3060-36INT	\$3,147	\$3,398	\$3,429	\$3,653
24	60	36	113	40	LKV2460-36INT	\$3,092	\$3,340	\$3,372	\$3,590	

LOK - TEAMWORK

Electrical Options and Upcharges

CTEC23	
EC23 Power Center Top - Black	CTEC23BL - add \$594
EC23 Power Center Top - White	CTEC23WH - add \$594
CTEC24	
EC24 Power Center Top - Black	CTEC43BL - add \$474
EC24 Power Center Top - White	CTEC43WH - add \$474

**Note: Order power infeed that best fits application**

To Order, Specify:

① Veneer Model #	② Edge Detail	③ Wood Collection	④ Top Wood Finish	⑤ Electrical	⑥ Metal Color
Veneer (LKV)	<a href="#">See Edge Detail Options</a>	Essentials	<a href="#">See Essentials Top Wood Finish Options</a>	N None CTEC23 Power Center Top CTEC24 Power Center Top (See chart above)	<a href="#">See Metal Finish Color Options</a>
		Artisan	④ Top Wood Finish <a href="#">See Artisan Top Wood Finish Options</a>		

Description

One-Twenty Table with T Base at Counter Height

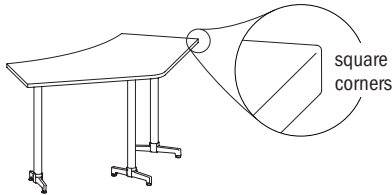

Laminate Tables  
"LKT" Models

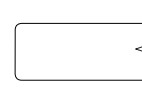

Eased Edge (R3)

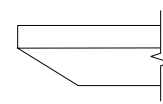

Reverse Bevel Edge (K9)

LAMINATE	D	W	H	CTN WT	CU FT	1 Model	Standard Tier 1	Graded In Tier 2	Standard Tier 1	Graded In Tier 2
		45	84	36	118	94	LKT4584-36YGT	\$3,591	\$3,651	\$4,213
	42	73	36	107	78	LKT4273-36YGT	\$3,110	\$3,156	\$3,710	\$3,755

Features:

- price reflects complete table - top and base
- ships KD in multiple cartons
- model includes adjustable glide

Options:

- specify power option and or charging option, see below for options and upcharges

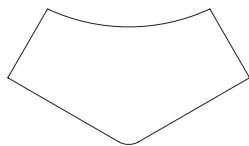

top shape

LOK - TEAMWORK

To Order Specify

1 Laminata Model #	2 Edge Detail	3 Laminate Selection	3a PVC Edge Color	4 Electrical
Laminata (LKT)	<a href="#">See Edge Detail Options</a>	<a href="#">See Laminate Selection</a>	<a href="#">See PVC Edge Color Options</a>	<p>N None</p> <p>CT1 Single Power Center Top</p> <p>CU1 Single Power Underside</p> <p>CT1U1 Single Power Center Top</p> <p>LRT2 Dual Power Left/Right</p> <p>LRT2CU1 Dual Power Left/Right Top w/Underside</p> <p>(See chart on next page)</p>
				<p>5 Metal Finish</p> <p><a href="#">See Metal Finish Color Options</a></p>

Model Number Breakdown

LKT4584-36YGT					
LK	T	4584	36	YG	T
LOK	Laminata	45" x 84"	Height	One-Twenty Top Shape	T base

Description

One-Twenty Table with T Base at Counter Height  
(continued)

Veneer Tables  
"LKV" Models

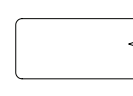

Eased Edge (R3)

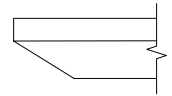

Reverse Bevel Edge (K9)

VENEER	D	W	H	CTN WT	CU FT	① Model	Essentials	Artisan	Essentials	Artisan
	45	84	36	118	94	LKV4584-36YGT	\$4,076	\$4,402	\$4,442	\$4,728
42	73	36	107	78	LKV4273-36YGT	\$3,813	\$4,117	\$4,154	\$4,425	

Electrical Options and Upcharges

	73 - 84 wide	
	Circuit 1	Circuit 2
<b>CT1</b>		
Single Power Center Top - Black	CT11CBL - add \$846	CT12CBL - add \$846
Single Power Center Top - White	CT11CWH - add \$846	CT12CWH - add \$846
<b>CU1</b>		
Single Power Underside - Black	CU11C - add \$853	CU12C - add \$853
Single Power Underside with Wireless Charging - Black	CU11CW - add \$1,843	CU12CW - add \$1,843
<b>CT1U1</b>		
Single Power Center Top - Black with Underside	CT1U1-1CBL - add \$1,599	CT1U1-2CBL - add \$1,599
Single Power Center Top - White with Underside	CT1U1-1CWH - add \$1,599	CT1U1-2CWH - add \$1,599
Single Power Center Top - Black with Wireless Charging	CT1U1-1CWBL - add \$2,558	CT1U1-2CWBL - add \$2,558
Single Power Center Top - White with Wireless Charging	CT1U1-1CWHW - add \$2,558	CT1U1-2CWHW - add \$2,558
<b>LRT2CU1</b>		
Dual Power Left/Right Top with Underside - Black	LRT2CU1-1CBL - add \$2,978	LRT2CU1-2CBL - add \$2,978
Dual Power Left/Right Top with Underside - White	LRT2CU1-1CWH - add \$2,978	LRT2CU1-2CWH - add \$2,978
Dual Power Left/Right Top - Black with Underside & Wireless Charging	LRT2CU1-1CWBL - add \$3,938	LRT2CU1-2CWBL - add \$3,938
Dual Power Left/Right Top - White with Underside & Wireless Charging	LRT2CU1-1CWHW - add \$3,938	LRT2CU1-2CWHW - add \$3,938
<b>LRT2</b>		
Dual Power Left/Right Top - Black	LRT2-1CBL - add \$1,447	LRT2-2CBL - add \$1,447
Dual Power Left/Right Top - White	LRT2-1CWH - add \$1,447	LRT2-2CWH - add \$1,447

LOK - TEAMWORK

**Note: Order power infeed that best fits application**

To Order, Specify:

① Veneer Model #	② Edge Detail	③ Wood Collection	④ Top Wood Finish	⑤ Electrical	⑥ Metal Color
Veneer (LKV)	<a href="#">See Edge Detail Options</a>	Essentials	<a href="#">See Essentials Top Wood Finish Options</a>	N None CT1 Single Power Center Top CU1 Single Power Underside CT1U1 Single Power Center Top LRT2 Dual Power Left/Right LRT2CU1 Dual Power Left/Right Top with Underside (See chart above)	<a href="#">See Metal Finish Color Options</a>
		Artisan	④ Top Wood Finish <a href="#">See Artisan Top Wood Finish Options</a>		

Description

Rounded One-Twenty Table with T Base at Counter Height

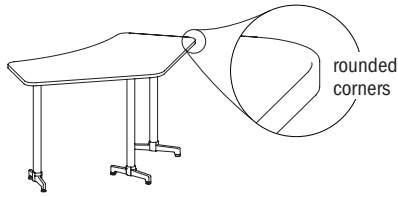

Laminate Tables "LKT" Models

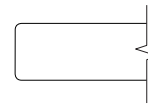

Eased Edge (R3)

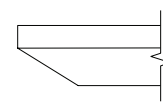

Reverse Bevel Edge (K9)

LAMINATE	D	W	H	CTN WT	CU FT	1 Model	Standard Tier 1	Graded In Tier 2	Standard Tier 1	Graded In Tier 2
		45	84	36	118	94	LKT4584-36YGRT	\$3,591	\$3,651	\$4,213
	42	73	36	107	78	LKT4273-36YGRT	\$3,110	\$3,156	\$3,710	\$3,755

Features:

- price reflects complete table - top and base
- ships KD in multiple cartons
- model includes adjustable glide

Options:

- specify power option and or charging option, see below for options and upcharges

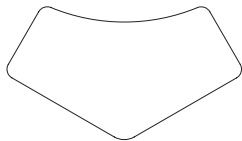

top shape

LOK - TEAMWORK

To Order Specify

1 Laminate Model #	2 Edge Detail	3 Laminate Selection	3a PVC Edge Color	4 Electrical
Laminate (LKT)	<a href="#">See Edge Detail Options</a>	<a href="#">See Laminate Selection</a>	<a href="#">See PVC Edge Color Options</a>	N None CT2 Dual Power Center Top (See chart on next page) CU1 Single Power Underside <b>5 Metal Finish</b> <a href="#">See Metal Finish Color Options</a>

Model Number Breakdown

LKT4584-36YGRT						
LK	T	4584	36	YG	R	T
LOK	Laminate	45" x 84"	Height	One-Twenty Top Shape	Rounded Corner	T base

Description

Rounded One-twenty Table with T Base at Counter Height (continued)

Veneer Tables "LKV" Models

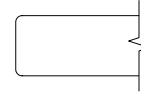

Eased Edge (R3)

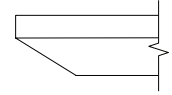

Reverse Bevel Edge (K9)

VENEER	D	W	H	CTN WT	CU FT	Model	Essentials	Artisan	Essentials	Artisan
	45	84	36	118	94	LKV4584-36YGRT	\$4,076	\$4,402	\$4,442	\$4,728
42	73	36	107	78	LKV4273-36YGRT	\$3,813	\$4,117	\$4,154	\$4,425	

Electrical Options and Upcharges

	73 - 84 wide	
	Circuit 1	Circuit 2
<b>CT1</b>		
Single Power Center Top - Black	CT11CBL - add \$846	CT12CBL - add \$846
Single Power Center Top - White	CT11CWH - add \$846	CT12CWH - add \$846
<b>CU1</b>		
Single Power Underside - Black	CU11C - add \$853	CU12C - add \$853
Single Power Underside with Wireless Charging - Black	CU11CW - add \$1,843	CU12CW - add \$1,843
<b>CT1U1</b>		
Single Power Center Top - Black with Underside	CT1U1-1CBL - add \$1,599	CT1U1-2CBL - add \$1,599
Single Power Center Top - White with Underside	CT1U1-1CWH - add \$1,599	CT1U1-2CWH - add \$1,599
Single Power Center Top - Black with Wireless Charging	CT1U1-1CWBL - add \$2,558	CT1U1-2CWBL - add \$2,558
Single Power Center Top - White with Wireless Charging	CT1U1-1CWHW - add \$2,558	CT1U1-2CWHW - add \$2,558
<b>LRT2CU1</b>		
Dual Power Left/Right Top with Underside - Black	LRT2CU1-1CBL - add \$2,978	LRT2CU1-2CBL - add \$2,978
Dual Power Left/Right Top with Underside - White	LRT2CU1-1CWH - add \$2,978	LRT2CU1-2CWH - add \$2,978
Dual Power Left/Right Top - Black with Underside & Wireless Charging	LRT2CU1-1CWBL - add \$3,938	LRT2CU1-2CWBL - add \$3,938
Dual Power Left/Right Top - White with Underside & Wireless Charging	LRT2CU1-1CWHW - add \$3,938	LRT2CU1-2CWHW - add \$3,938
<b>LRT2</b>		
Dual Power Left/Right Top - Black	LRT2-1CBL - add \$1,447	LRT2-2CBL - add \$1,447
Dual Power Left/Right Top - White	LRT2-1CWH - add \$1,447	LRT2-2CWH - add \$1,447

LOK - TEAMWORK

Note: Order power infeed that best fits application

To Order, Specify:

1 Veneer Model #	2 Edge Detail	3 Wood Collection	4 Top Wood Finish	5 Electrical	6 Metal Color
Veneer (LKV)	<a href="#">See Edge Detail Options</a>	Essentials	<a href="#">See Essentials Top Wood Finish Options</a>	N None CT1 Single Power Center Top CU1 Single Power Underside CT1U1 Single Power Center Top LRT2 Dual Power Left/Right LRT2CU1 Dual Power Left/Right with Underside (See chart above)	<a href="#">See Metal Finish Color Options</a>
		Artisan	<b>4 Top Wood Finish</b> <a href="#">See Artisan Top Wood Finish Options</a>		

Description

Home Base Table with X Base at Counter Height



Laminate Tables  
"LKT" Models

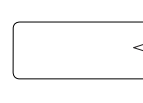

Eased Edge (R3)

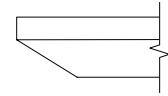

Reverse Bevel Edge (K9)

LAMINATE	D	W	H	CTN WT	CU FT	① Model	Standard Tier 1	Graded In Tier 2	Standard Tier 1	Graded In Tier 2
		30	36	36	75	30	LKT3036-36HBX	\$1,721	\$1,762	\$2,268
	24	30	36	59	21	LKT2430-36HBX	\$1,463	\$1,477	\$2,007	\$2,022

Features:

- price reflects complete table - top and base
- ships KD in multiple cartons
- model includes adjustable glide

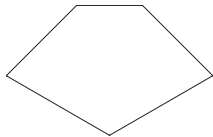

top shape

LOK - TEAMWORK

To Order Specify

① Laminate Model #	② Edge Detail	③ Laminate Selection	④ PVC Edge Color	⑤ Metal Finish
Laminate (LKT)	<a href="#">See Edge Detail Options</a>	<a href="#">See Laminate Selection</a>	<a href="#">See PVC Edge Color Options</a>	<a href="#">See Metal Finish Color Options</a>

Model Number Breakdown

LKT3036-36HBX					
LK	T	3036	36	HB	X
LOK	Laminate	30" x 36"	Height	Home Base Top Shape	X base

133.33 Lok

Description

Home Base Table with X Base at Counter Height  
(continued)

Veneer Tables  
"LKV" Models

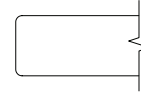

Eased Edge (R3)

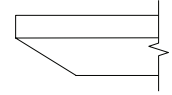

Reverse Bevel Edge (K9)

VENEER	D	W	H	CTN WT	CU FT	① Model	Eased Edge (R3)		Reverse Bevel Edge (K9)	
							Essentials	Artisan	Essentials	Artisan
	30	36	36	75	30	LKV3036-36HBX	\$2,253	\$2,436	\$2,455	\$2,613
	24	30	36	59	21	LKV2430-36HBX	\$2,116	\$2,286	\$2,309	\$2,457

LOK-TEAMWORK

To Order, Specify:

① Veneer Model #	② Edge Detail	③ Wood Collection	④ Top Wood Finish	⑤ Metal Color
Veneer (LKV)	<a href="#">See Edge Detail Options</a>	Essentials	<a href="#">See Essentials Top Wood Finish Options</a>	<a href="#">See Metal Finish Color Options</a>
		Artisan	④ Top Wood Finish <a href="#">See Artisan Top Wood Finish Options</a>	

Description

Boomerang Table - Left with T Base at Counter Height

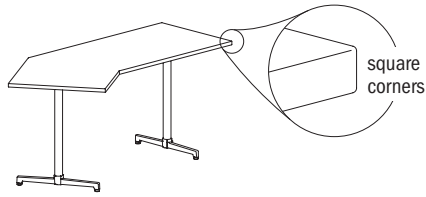

Laminate Tables "LKT" Models

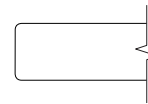

Eased Edge (R3)

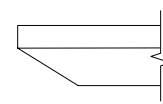

Reverse Bevel Edge (K9)

LAMINATE	D	W	H	CTN WT	CU FT	Model	Standard Tier 1	Graded In Tier 2	Standard Tier 1	Graded In Tier 2
		36	84	36	139	78	LKT3684-36BMLT	\$3,103	\$3,154	\$3,767
	36	84	36	139	78	LKT3684-36BMRT	\$3,103	\$3,154	\$3,767	\$3,817
	30	84	36	121	66	LKT3084-36BMLT	\$2,655	\$2,691	\$3,237	\$3,273
	30	84	36	121	66	LKT3084-36BMRT	\$2,655	\$2,691	\$3,237	\$3,273

Features:

- price reflects complete table - top and base
- ships KD in multiple cartons
- model includes adjustable glide

Options:

- specify power option and or charging option, see below for options and upcharges

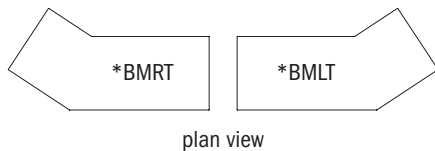

plan view

LOK - TEAMWORK

To Order Specify

1 Laminate Model #	2 Edge Detail	3 Laminate Selection	3a PVC Edge Color	4 Electrical
Laminate (LKT)	<a href="#">See Edge Detail Options</a>	<a href="#">See Laminate Selection</a>	<a href="#">See PVC Edge Color Options</a>	<p>4 Electrical</p> <p>N None      CT1U1 Single Power Center Top                      CT1 Single Power Center Top      LRT2 Dual Power Left/Right                      CU1 Single Power Underside      LRT2CU1 Dual Power Left/Right Top w/Underside                      (See chart on next page)</p> <p>5 Metal Finish</p> <p><a href="#">See Metal Finish Color Options.</a></p>

Model Number Breakdown

LKT3684-36BMLT					
LK	T	3684	36	BML	T
LOK	Laminate	36" x 84"	Height	Boomerang Left Top Shape	T base

Description

Boomerang Table - Left with T Base  
at Counter Height (continued)

Veneer Tables  
"LKV" Models

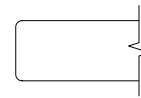

Eased Edge (R3)

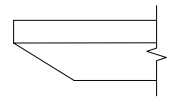

Reverse Bevel Edge (K9)

VENEER	D	W	H	CTN WT	CU FT	① Model	Essentials	Artisan	Essentials	Artisan
		36	84	36	139	78	LKV3684-36BMLT	\$3,955	\$4,268	\$4,310
	36	84	36	139	78	LKV3684-36BMRT	\$3,955	\$4,268	\$4,310	\$4,587
	30	84	36	121	66	LKV3084-36BMLT	\$3,463	\$3,736	\$3,771	\$4,015
	30	84	36	121	66	LKV3084-36BMRT	\$3,463	\$3,736	\$3,771	\$4,015

Electrical Options and Upcharges

	73 - 84 wide	
	Circuit 1	Circuit 2
<b>CT1</b>		
Single Power Center Top - Black	CT11CBL - add \$846	CT12CBL - add \$846
Single Power Center Top - White	CT11CWH - add \$846	CT12CWH - add \$846
<b>CU1</b>		
Single Power Underside - Black	CU11C - add \$853	CU12C - add \$853
Single Power Underside with Wireless Charging - Black	CU11CW - add \$1,843	CU12CW - add \$1,843
<b>CT1U1</b>		
Single Power Center Top - Black with Underside	CT1U1-1CBL - add \$1,599	CT1U1-2CBL - add \$1,599
Single Power Center Top - White with Underside	CT1U1-1CWH - add \$1,599	CT1U1-2CWH - add \$1,599
Single Power Center Top - Black with Wireless Charging	CT1U1-1CWBL - add \$2,558	CT1U1-2CWBL - add \$2,558
Single Power Center Top - White with Wireless Charging	CT1U1-1CWHW - add \$2,558	CT1U1-2CWHW - add \$2,558
<b>LRT2CU1</b>		
Dual Power Left/Right Top with Underside - Black	LRT2CU1-1CBL - add \$2,978	LRT2CU1-2CBL - add \$2,978
Dual Power Left/Right Top with Underside - White	LRT2CU1-1CWH - add \$2,978	LRT2CU1-2CWH - add \$2,978
Dual Power Left/Right Top - Black with Underside & Wireless Charging	LRT2CU1-1CWBL - add \$3,938	LRT2CU1-2CWBL - add \$3,938
Dual Power Left/Right Top - White with Underside & Wireless Charging	LRT2CU1-1CWHW - add \$3,938	LRT2CU1-2CWHW - add \$3,938
<b>LRT2</b>		
Dual Power Left/Right Top - Black	LRT2-1CBL - add \$1,447	LRT2-2CBL - add \$1,447
Dual Power Left/Right Top - White	LRT2-1CWH - add \$1,447	LRT2-2CWH - add \$1,447

LOK - TEAMWORK

Note: Order power infeed that best fits application

To Order, Specify:

① Veneer Model #	② Edge Detail	③ Wood Collection	④ Top Wood Finish	⑤ Electrical	⑥ Metal Color
Veneer (LKV)	<a href="#">See Edge Detail Options</a>	Essentials	<a href="#">See Essentials Top Wood Finish Options</a>	N None CT1 Single Power Center Top CU1 Single Power Underside CT1U1 Single Power Center Top LRT2 Dual Power Left/Right LRT2CU1 Dual Power Left/Right with Underside (See chart above)	<a href="#">See Metal Finish Color Options</a>
		Artisan	④ Top Wood Finish <a href="#">See Artisan Top Wood Finish Options</a>		

Description

Rounded Boomerang Table - Left with T Base at Counter Height

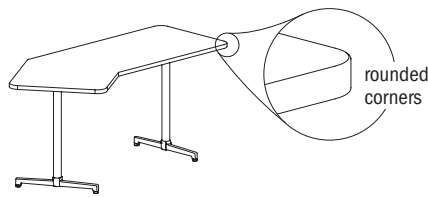

Laminate Tables "LKT" Models

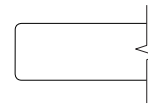

Eased Edge (R3)

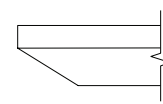

Reverse Bevel Edge (K9)

LAMINATE	D	W	H	CTN WT	CU FT	1 Model	Standard Tier 1	Graded In Tier 2	Standard Tier 1	Graded In Tier 2
		36	84	36	101	78	LKT3684-36BMLRT	\$3,103	\$3,154	\$3,767
	36	84	36	139	78	LKT3684-36BMRRT	\$3,103	\$3,154	\$3,767	\$3,817
	30	84	36	121	66	LKT3084-36BMLRT	\$2,655	\$2,691	\$3,237	\$3,273
	30	84	36	121	66	LKT3084-36BMRRT	\$2,655	\$2,691	\$3,237	\$3,273

Features:

- price reflects complete table - top and base
- ships KD in multiple cartons
- model includes adjustable glide

Options:

- specify power option and or charging option, see below for options and upcharges

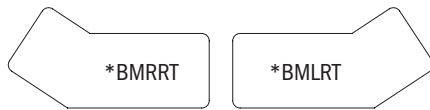

top shape

LOK - TEAMWORK

To Order Specify

1 Laminate Model #	2 Edge Detail	3 Laminate Selection	3a PVC Edge Color	4 Electrical
Laminate (LKT)	<a href="#">See Edge Detail Options</a>	<a href="#">See Laminate Selection</a>	<a href="#">See PVC Edge Color Options</a>	<p>4 Electrical</p> <p>N None                      CT1U1 Single Power Center Top                      CT1 Single Power Center Top      LRT2 Dual Power Left/Right                      CU1 Single Power Underside      LRT2CU1 Dual Power Left/Right Top w/Underside                      (See chart on next page)</p> <p>5 Metal Finish</p> <p><a href="#">See Metal Finish Color Options</a></p>

Model Number Breakdown

LKT3684-36BMLRT						
LK	T	3684	36	BML	R	T
LOK	Laminate	36" x 84"	Height	Boomerang Left Top Shape	Rounded Corner	T base

Description

Rounded Boomerang Table - Left with T Base at Counter Height (continued)

Veneer Tables  
"LKV" Models

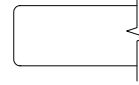

Eased Edge (R3)

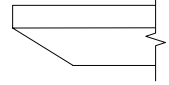

Reverse Bevel Edge (K9)

VENEER	D	W	H	CTN WT	CU FT	① Model	Essentials	Artisan	Essentials	Artisan
		36	84	36	143	78	LKV3684-36BMLRT	\$3,955	\$4,268	\$4,310
	36	84	36	139	78	LKV3684-36BMRRT	\$3,955	\$4,268	\$4,310	\$4,587
	30	84	36	101	66	LKV3084-36BMLRT	\$3,463	\$3,736	\$3,771	\$4,015
	30	84	36	121	66	LKV3084-36BMRRT	\$3,463	\$3,736	\$3,771	\$4,015

Electrical Options and Upcharges

	73 - 84 wide	
	Circuit 1	Circuit 2
<b>CT1</b>		
Single Power Center Top - Black	CT11CBL - add \$846	CT12CBL - add \$846
Single Power Center Top - White	CT11CWH - add \$846	CT12CWH - add \$846
<b>CU1</b>		
Single Power Underside - Black	CU11C - add \$853	CU12C - add \$853
Single Power Underside with Wireless Charging - Black	CU11CW - add \$1,843	CU12CW - add \$1,843
<b>CT1U1</b>		
Single Power Center Top - Black with Underside	CT1U1-1CBL - add \$1,599	CT1U1-2CBL - add \$1,599
Single Power Center Top - White with Underside	CT1U1-1CWH - add \$1,599	CT1U1-2CWH - add \$1,599
Single Power Center Top - Black with Wireless Charging	CT1U1-1CWBL - add \$2,558	CT1U1-2CWBL - add \$2,558
Single Power Center Top - White with Wireless Charging	CT1U1-1CWHW - add \$2,558	CT1U1-2CWHW - add \$2,558
<b>LRT2CU1</b>		
Dual Power Left/Right Top with Underside - Black	LRT2CU1-1CBL - add \$2,978	LRT2CU1-2CBL - add \$2,978
Dual Power Left/Right Top with Underside - White	LRT2CU1-1CWH - add \$2,978	LRT2CU1-2CWH - add \$2,978
Dual Power Left/Right Top - Black with Underside & Wireless Charging	LRT2CU1-1CWBL - add \$3,938	LRT2CU1-2CWBL - add \$3,938
Dual Power Left/Right Top - White with Underside & Wireless Charging	LRT2CU1-1CWHW - add \$3,938	LRT2CU1-2CWHW - add \$3,938
<b>LRT2</b>		
Dual Power Left/Right Top - Black	LRT2-1CBL - add \$1,447	LRT2-2CBL - add \$1,447
Dual Power Left/Right Top - White	LRT2-1CWH - add \$1,447	LRT2-2CWH - add \$1,447

LOK - TEAMWORK

**Note: Order power infeed that best fits application**

To Order, Specify:

① Veneer Model #	② Edge Detail	③ Wood Collection	④ Top Wood Finish	⑤ Electrical	⑥ Metal Color
Veneer (LKV)	<a href="#">See Edge Detail Options</a>	Essentials	<a href="#">See Essentials Top Wood Finish Options</a>	N None CT1 Single Power Center Top CU1 Single Power Underside CT1U1 Single Power Center Top LRT2 Dual Power Left/Right LRT2CU1 Dual Power Left/Right with Underside (See chart above)	<a href="#">See Metal Finish Color Options</a>
			Artisan		

Description

Wedge Table with T Base at Counter Height

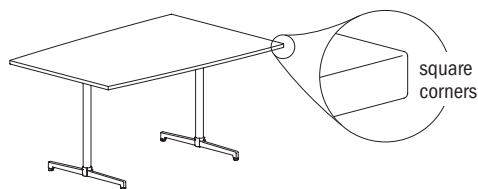

Laminate Tables  
"LKT" Models

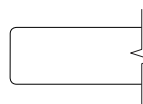

Eased Edge (R3)

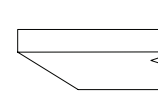

Reverse Bevel Edge (K9)

LAMI	D	W	H	CTN WT	CU FT	1 Model	Standard Tier 1	Graded In Tier 2	Standard Tier 1	Graded In Tier 2
		48	72	36	156	87	LKT4872-36WDT	\$2,724	\$2,777	\$3,334

Features:

- price reflects complete table - top and base
- ships KD in multiple cartons
- model includes adjustable glide

Options:

- specify power option and or charging option, see below for options and upcharges



top shape

LOK - TEAMWORK

To Order Specify

1 Laminate Model #	2 Edge Detail	3 Laminate Selection	3a PVC Edge Color	4 Electrical
Laminate (LKT)	<a href="#">See Edge Detail Options</a>	<a href="#">See Laminate Selection</a>	<a href="#">See PVC Edge Color Options</a>	N None CT2 Dual Power Center Top (See chart on next page) CU1 Single Power Underside <b>5 Metal Finish</b> <a href="#">See Metal Finish Color Options</a>

Model Number Breakdown

LKT4872-36WDT					
LK	T	4872	36	WD	T
LOK	Laminate	48" x 72"	Height	Wedge Top Shape	T base

Description

Wedge Table with T Base at Counter Height  
(continued)

Veneer Tables  
"LKV" Models

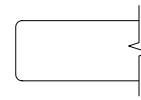

Eased Edge (R3)

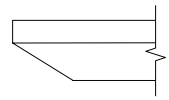

Reverse Bevel Edge (K9)

VEN.	D	W	H	CTN WT	CU FT	① Model	Essentials		Artisan	
							Essentials	Artisan	Essentials	Artisan
	48	72	36	156	87	LKV4872-36WDT	\$3,431	\$3,706	\$3,737	\$3,982

LOK - TEAMWORK

Electrical Options and Upcharges

CT2	
Dual Power Center Top - Black	CT2BL - add \$1,773
Dual Power Center Top - White	CT2WH - add \$1,773
CU1	
Single Power Underside - Black	CU11C - add \$690
Single Power Underside with Wireless Charging - Black	CU11CW - add \$1,651

**Note: Order power infeed that best fits application**

To Order, Specify:

① Veneer Model #	② Edge Detail	③ Wood Collection	④ Top Wood Finish	⑤ Electrical	⑥ Metal Color
Veneer (LKV)	<a href="#">See Edge Detail Options</a>	Essentials	<a href="#">See Essentials Top Wood Finish Options</a>	N None CT2 Dual Power Center Top CU1 Single Power Underside (See chart above)	<a href="#">See Metal Finish Color Options</a>
		Artisan	④ Top Wood Finish <a href="#">See Artisan Top Wood Finish Options</a>		

Description

Rounded Wedge Table with T Base at Counter Height

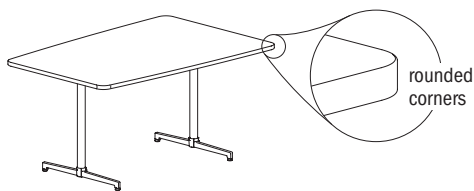

Laminate Tables  
"LKT" Models

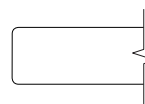

Eased Edge (R3)

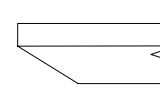

Reverse Bevel Edge (K9)

LAMI	D	W	H	CTN WT	CU FT	1 Model	Standard Tier 1	Graded In Tier 2	Standard Tier 1	Graded In Tier 2
		48	72	36	156	87	LKT4872-36WDRT	\$2,724	\$2,777	\$3,334

Features:

- price reflects complete table - top and base
- ships KD in multiple cartons
- model includes adjustable glide

Options:

- specify power option and or charging option, see below for options and upcharges



top shape

LOK - TEAMWORK

To Order Specify

1 Laminate Model #	2 Edge Detail	3 Laminate Selection	3a PVC Edge Color	4 Electrical
Laminate (LKT)	<a href="#">See Edge Detail Options</a>	<a href="#">See Laminate Selection</a>	<a href="#">See PVC Edge Color Options</a>	N None CT2 Dual Power Center Top (See chart on next page) CU1 Single Power Underside <b>5 Metal Finish</b> <a href="#">See Metal Finish Color Options</a>

Model Number Breakdown

LKT4872-36WDRT						
LK	T	4872	36	WD	R	T
LOK	Laminate	48" x 72"	Height	Wedge Top Shape	Rounded Corner	T base

Description

Rounded Wedge Table with T Base at Counter Height  
(continued)

Veneer Tables  
"LKV" Models

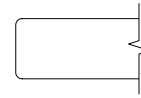

Eased Edge (R3)

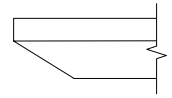

Reverse Bevel Edge (K9)

VEN.	D	W	H	CTN WT	CU FT	① Model	Essentials		Artisan	
	48	72	36	156	87	LKV4872-36WDRT	\$3,431		\$3,706	
									\$3,737	\$3,982

LOK - TEAMWORK

Electrical Options and Upcharges

CT2	
Dual Power Center Top - Black	CT2BL - add \$1,773
Dual Power Center Top - White	CT2WH - add \$1,773
CU1	
Single Power Underside - Black	CU11C - add \$690
Single Power Underside with Wireless Charging - Black	CU11CW - add \$1,651

**Note: Order power infeed that best fits application**

To Order, Specify:

① Veneer Model #	② Edge Detail	③ Wood Collection	④ Top Wood Finish	⑤ Electrical	⑥ Metal Color
Veneer (LKV)	<a href="#">See Edge Detail Options</a>	Essentials	<a href="#">See Essentials Top Wood Finish Options</a>	N None CT2 Dual Power Center Top CU1 Single Power Underside (See chart above)	<a href="#">See Metal Finish Color Options</a>
		Artisan	④ Top Wood Finish <a href="#">See Artisan Top Wood Finish Options</a>		

Description

Rectangular Table with T Base at Bar Height

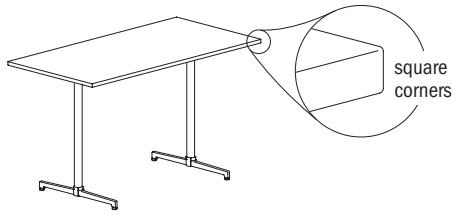

Laminate Tables  
"LKT" Models

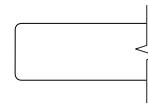

Eased Edge (R3)

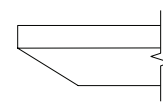

Reverse Bevel Edge (K9)

D	W	H	CTN WT	CU FT	Model	Eased Edge (R3)		Reverse Bevel Edge (K9)	
						Standard Tier 1	Graded In Tier 2	Standard Tier 1	Graded In Tier 2
48	72	42	164	101	LKT4872-42TTT	\$2,808	\$2,861	\$3,447	\$3,503
42	72	42	149	89	LKT4272-42TTT	\$2,683	\$2,732	\$3,310	\$3,358
36	72	42	139	77	LKT3672-42TTT	\$2,427	\$2,510	\$2,988	\$3,071
36	66	42	129	72	LKT3666-42TTT	\$2,349	\$2,427	\$2,907	\$2,988
36	60	42	121	66	LKT3660-42TTT	\$2,253	\$2,323	\$2,813	\$2,888

LAMINATE

Features:

- price reflects complete table - top and base
- ships KD in multiple cartons
- model includes adjustable glide

Options:

- specify power/charging option, see below for options and upcharges

LOK - TEAMWORK

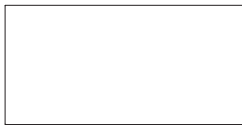

top shape

To Order Specify

1 Laminate Model #	2 Edge Detail	3 Laminate Selection	3a PVC Edge Color	4 Electrical
Laminate (LKT)	<a href="#">See Edge Detail Options</a>	<a href="#">See Laminate Selection</a>	<a href="#">See PVC Edge Color Options</a>	N None CT2 Dual Power Center Top (See chart on next page) CU1 Single Power Underside <b>5 Metal Finish</b> <a href="#">See Metal Finish Color Options</a>

Model Number Breakdown

LKT4872-42TTT					
LK	T	4872	42	TT	T
LOK	Laminate	48" x 72"	Height	Rectangular Top Shape	T base

Description

Rectangular Table with T Base at Bar Height  
(continued)

Veneer Tables  
"LKV" Models

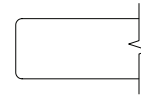

Eased Edge (R3)

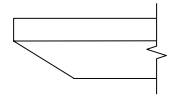

Reverse Bevel Edge (K9)

D	W	H	CTN WT	CU FT	① Model	Eased Edge (R3)		Reverse Bevel Edge (K9)	
						Essentials	Artisan	Essentials	Artisan
48	72	42	140	101	LKV4872-42TTT	\$3,200	\$3,484	\$3,511	\$3,774
42	72	42	149	89	LKV4272-42TTT	\$3,068	\$3,318	\$3,363	\$3,599
36	72	42	139	77	LKV3672-42TTT	\$2,801	\$3,049	\$3,018	\$3,258
36	66	42	129	72	LKV3666-42TTT	\$2,746	\$2,977	\$2,955	\$3,180
36	60	42	121	66	LKV3660-42TTT	\$2,673	\$2,888	\$2,871	\$3,080

VENEER

LOK - TEAMWORK

Electrical Options and Upcharges

CT2	
Dual Power Center Top - Black	CT2BL - add \$1,588
Dual Power Center Top - White	CT2WH - add \$1,588
CU1	
Single Power Underside - Black	CU11C - add \$618
Single Power Underside with Wireless Charging - Black	CU11CW - add \$1,479

**Note: Order power infeed that best fits application**

To Order, Specify:

① Veneer Model #	② Edge Detail	③ Wood Collection	④ Top Wood Finish	⑤ Electrical	⑥ Metal Color
Veneer (LKV)	<a href="#">See Edge Detail Options</a>	Essentials	<a href="#">See Essentials Top Wood Finish Options</a>	N None CT2 Dual Power Center Top CU1 Single Power Underside (See chart above)	<a href="#">See Metal Finish Color Options</a>
		Artisan	④ Top Wood Finish <a href="#">See Artisan Top Wood Finish Options</a>		

Description

Rounded Rectangular Table with T Base at Bar Height

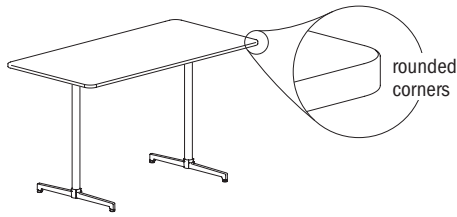

Laminate Tables  
"LKT" Models

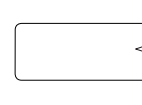

Eased Edge (R3)

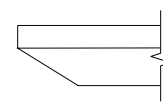

Reverse Bevel Edge (K9)

D	W	H	CTN WT	CU FT	① Model	Eased Edge (R3)		Reverse Bevel Edge (K9)	
						Standard Tier 1	Graded In Tier 2	Standard Tier 1	Graded In Tier 2
48	72	42	164	101	LKT4872-42TTRT	\$2,885	\$2,939	\$3,522	\$3,578
42	72	42	149	89	LKT4272-42TTRT	\$2,755	\$2,801	\$3,379	\$3,429
36	72	42	139	77	LKT3672-42TTRT	\$2,624	\$2,665	\$3,239	\$3,279
36	66	42	129	72	LKT3666-42TTRT	\$2,519	\$2,556	\$3,130	\$3,166
36	60	42	121	66	LKT3660-42TTRT	\$2,450	\$2,486	\$3,056	\$3,089

LAMINATE

Features:

- price reflects complete table - top and base
- ships KD in multiple cartons
- model includes adjustable glide

Options:

- specify power/charging option, see below for options and upcharges

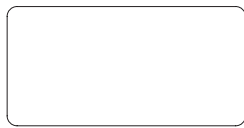

top shape

LOK - TEAMWORK

To Order Specify

① Laminate Model #	② Edge Detail	③ Laminate Selection	④ PVC Edge Color	⑤ Electrical
Laminate (LKT)	<a href="#">See Edge Detail Options</a>	<a href="#">See Laminate Selection</a>	<a href="#">See PVC Edge Color Options</a>	N None CT2 Dual Power Center Top (See chart on next page) CU1 Single Power Underside <b>⑤ Metal Finish</b> <a href="#">See Metal Finish Color Options</a>

Model Number Breakdown

LKT4872-42TTRT						
LK	T	4872	42	TT	R	T
LOK	Laminate	48" x 72"	Height	Rectangular Top Shape	Rounded Corner	T base

Description

Rounded Rectangular Table with T Base at Bar Height  
(continued)

Veneer Tables  
"LKV" Models

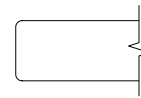

Eased Edge (R3)

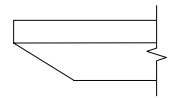

Reverse Bevel Edge (K9)

VENEER	D	W	H	CTN WT	CU FT	① Model	Essentials	Artisan	Essentials	Artisan
		48	72	42	164	101	LKV4872-42TTRT	\$3,273	\$3,561	\$3,586
	42	72	42	149	89	LKV4272-42TTRT	\$3,137	\$3,391	\$3,433	\$3,667
	36	72	42	139	77	LKV3672-42TTRT	\$2,997	\$3,256	\$3,103	\$3,348
	36	66	42	129	72	LKV3666-42TTRT	\$2,889	\$3,091	\$3,165	\$3,349
	36	60	42	121	66	LKV3660-42TTRT	\$2,857	\$3,080	\$2,951	\$3,164

LOK - TEAMWORK

Electrical Options and Upcharges

CT2	
Dual Power Center Top - Black	CT2BL - add \$1,588
Dual Power Center Top - White	CT2WH - add \$1,588
CU1	
Single Power Underside - Black	CU11C - add \$618
Single Power Underside with Wireless Charging - Black	CU11CW - add \$1,479

**Note: Order power infeed that best fits application**

To Order, Specify:

① Veneer Model #	② Edge Detail	③ Wood Collection	④ Top Wood Finish	⑤ Electrical	⑥ Metal Color
Veneer (LKV)	<a href="#">See Edge Detail Options</a>	Essentials	<a href="#">See Essentials Top Wood Finish Options</a>	N None CT2 Dual Power Center Top CU1 Single Power Underside (See chart above)	<a href="#">See Metal Finish Color Options</a>
		Artisan	④ Top Wood Finish <a href="#">See Artisan Top Wood Finish Options</a>		

Description

Rectangular Table with X Base at Bar Height

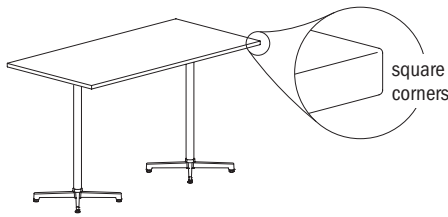

Laminate Tables  
"LKT" Models

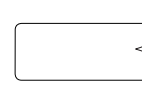

Eased Edge (R3)

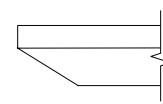

Reverse Bevel Edge (K9)

LAMINATE	D	W	H	CTN WT	CU FT	1 Model	Standard Tier 1	Graded In Tier 2	Standard Tier 1	Graded In Tier 2
		48	72	42	169	101	LKT4872-42TTX	\$3,423	\$3,478	\$4,061
	42	72	42	153	90	LKT4272-42TTX	\$3,299	\$3,346	\$3,925	\$3,973
	36	72	42	136	78	LKT3672-42TTX	\$3,115	\$3,200	\$3,677	\$3,761

Features:

- price reflects complete table - top and base
- ships KD in multiple cartons
- model includes adjustable glide

Options:

- specify power/charging option, see below for options and upcharges

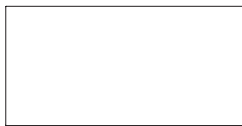

top shape

LOK - TEAMWORK

To Order Specify

1 Laminate Model #	2 Edge Detail	3 Laminate Selection	3a PVC Edge Color	4 Electrical
Laminate (LKT)	<a href="#">See Edge Detail Options</a>	<a href="#">See Laminate Selection</a>	<a href="#">See PVC Edge Color Options</a>	N None CT2 Dual Power Center Top (See chart on next page) CU1 Single Power Underside <b>5 Metal Finish</b> <a href="#">See Metal Finish Color Options</a>

Model Number Breakdown

LKT4872-42TTX					
LK	T	4872	42	TT	X
LOK	Laminate	48" x 72"	Height	Rectangular Top Shape	X base

Description

Rectangular Table with X Base at Bar Height  
(continued)

Veneer Tables  
"LKV" Models

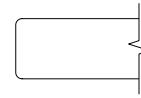

Eased Edge (R3)

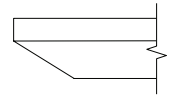

Reverse Bevel Edge (K9)

D	W	H	CTN WT	CU FT	① Model	Eased Edge (R3)		Reverse Bevel Edge (K9)	
						Essentials	Artisan	Essentials	Artisan
48	72	42	169	101	LKV4872-42TTX	\$3,815	\$4,103	\$4,127	\$4,391
42	72	42	153	90	LKV4272-42TTX	\$3,683	\$3,935	\$3,981	\$4,213
36	72	42	136	78	LKV3672-42TTX	\$3,491	\$3,736	\$3,707	\$3,947

VENEER

LOK - TEAMWORK

Electrical Options and Upcharges

CT2	
Dual Power Center Top - Black	CT2BL - add \$1,588
Dual Power Center Top - White	CT2WH - add \$1,588
CU1	
Single Power Underside - Black	CU11C - add \$618
Single Power Underside with Wireless Charging - Black	CU11CW - add \$1,479

**Note: Order power infeed that best fits application**

To Order, Specify:

① Veneer Model #	② Edge Detail	③ Wood Collection	④ Top Wood Finish	⑤ Electrical	⑥ Metal Color
Veneer (LKV)	<a href="#">See Edge Detail Options</a>	Essentials	<a href="#">See Essentials Top Wood Finish Options</a>	N None CT2 Dual Power Center Top CU1 Single Power Underside (See chart above)	<a href="#">See Metal Finish Color Options</a>
		Artisan	④ Top Wood Finish <a href="#">See Artisan Top Wood Finish Options</a>		

Description

Rectangular Table with X Base at Bar Height

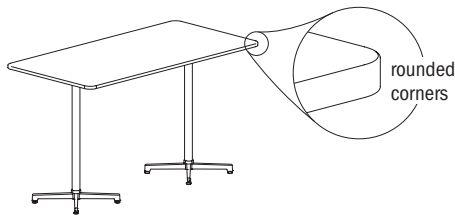

Laminate Tables  
"LKT" Models

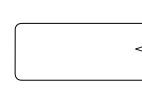

Eased Edge (R3)

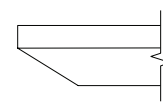

Reverse Bevel Edge (K9)

LAMINATE	D	W	H	CTN WT	CU FT	1 Model	Standard Tier 1	Graded In Tier 2	Standard Tier 1	Graded In Tier 2
		48	72	42	169	101	LKT4872-42TTRX	\$3,423	\$3,478	\$4,061
	42	72	42	153	90	LKT4272-42TTRX	\$3,299	\$3,346	\$3,925	\$3,973
	36	72	42	136	78	LKT3672-42TTRX	\$3,238	\$3,324	\$3,798	\$3,890

Features:

- price reflects complete table - top and base
- ships KD in multiple cartons
- model includes adjustable glide

Options:

- specify power/charging option, see below for options and upcharges



top shape

LOK - TEAMWORK

To Order Specify

1 Laminate Model #	2 Edge Detail	3 Laminate Selection	3a PVC Edge Color	4 Electrical
Laminate (LKT)	<a href="#">See Edge Detail Options</a>	<a href="#">See Laminate Selection</a>	<a href="#">See PVC Edge Color Options</a>	N None CT2 Dual Power Center Top (See chart on next page) CU1 Single Power Underside <b>5 Metal Finish</b> <a href="#">See Metal Finish Color Options</a>

Model Number Breakdown

LKT4872-42TTRX						
LK	T	4872	42	TT	R	X
LOK	Laminate	48" x 72"	Height	Rectangular Top Shape	Rounded Corner	X base

Description

Rectangular Table with X Base at Bar Height  
(continued)

Veneer Tables  
"LKV" Models

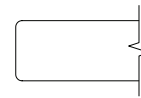

Eased Edge (R3)

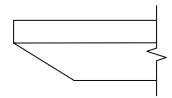

Reverse Bevel Edge (K9)

VENEER	D	W	H	CTN WT	CU FT	① Model	Essentials	Artisan	Essentials	Artisan
		48	72	42	169	101	LKV4872-42TTRX	\$3,815	\$4,103	\$4,127
	42	72	42	153	90	LKV4272-42TTRX	\$3,728	\$3,988	\$3,981	\$4,213
	36	72	42	136	78	LKV3672-42TTRX	\$3,683	\$3,935	\$3,836	\$4,081

LOK - TEAMWORK

Electrical Options and Upcharges

CT2	
Dual Power Center Top - Black	CT2BL - add \$1,588
Dual Power Center Top - White	CT2WH - add \$1,588
CU1	
Single Power Underside - Black	CU11C - add \$618
Single Power Underside with Wireless Charging - Black	CU11CW - add \$1,479

**Note: Order power infeed that best fits application**

To Order, Specify:

① Veneer Model #	② Edge Detail	③ Wood Collection	④ Top Wood Finish	⑤ Electrical	⑥ Metal Color
Veneer (LKV)	<a href="#">See Edge Detail Options</a>	Essentials	<a href="#">See Essentials Top Wood Finish Options</a>	N None CT2 Dual Power Center Top CU1 Single Power Underside (See chart above)	<a href="#">See Metal Finish Color Options</a>
		Artisan	④ Top Wood Finish <a href="#">See Artisan Top Wood Finish Options</a>		

Description

Arc Rectangular Table with T Base at Bar Height

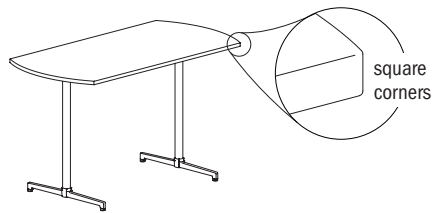

Laminate Tables  
"LKT" Models

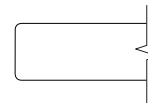

Eased Edge (R3)

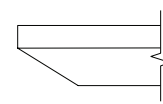

Reverse Bevel Edge (K9)

D	W	H	CTN WT	CU FT	① Model	Eased Edge (R3)		Reverse Bevel Edge (K9)	
						Standard Tier 1	Graded In Tier 2	Standard Tier 1	Graded In Tier 2
48	72	42	155	101	LKT4872-42ART	\$2,746	\$2,800	\$3,355	\$3,407
42	72	42	143	89	LKT4272-42ART	\$2,621	\$2,668	\$3,219	\$3,266
36	72	42	134	77	LKT3672-42ART	\$2,499	\$2,536	\$3,087	\$3,125
36	66	42	125	72	LKT3666-42ART	\$2,401	\$2,437	\$2,980	\$3,018
36	60	42	116	66	LKT3660-42ART	\$2,336	\$2,367	\$2,910	\$2,943

LAMINATE

Features:

- price reflects complete table - top and base
- ships KD in multiple cartons
- model includes adjustable glide

Options:

- specify power/charging option, see below for options and upcharges

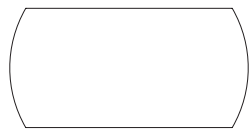

top shape

LOK - TEAMWORK

To Order Specify

① Laminate Model #	② Edge Detail	③ Laminate Selection	④ PVC Edge Color	⑤ Electrical
Laminate (LKT)	<a href="#">See Edge Detail Options</a>	<a href="#">See Laminate Selection</a>	<a href="#">See PVC Edge Color Options</a>	N None CT2 Dual Power Center Top (See chart on next page) CU1 Single Power Underside <b>⑤ Metal Finish</b> <a href="#">See Metal Finish Color Options</a>

Model Number Breakdown

LKT4872-42ART					
LK	T	4872	42	AR	T
LOK	Laminate	48" x 72"	Height	Arc Rectangular Top Shape	T base

Description

Arc Rectangular Table with T Base at Bar Height  
(continued)

Veneer Tables  
"LKV" Models

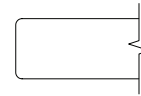

Eased Edge (R3)

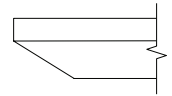

Reverse Bevel Edge (K9)

VENEER	D	W	H	CTN WT	CU FT	① Model	Essentials	Artisan	Essentials	Artisan
		48	72	42	155	101	LKV4872-42ART	\$3,455	\$3,729	\$3,763
	42	72	42	143	89	LKV4272-42ART	\$3,323	\$3,587	\$3,623	\$3,855
	36	72	42	134	77	LKV3672-42ART	\$3,191	\$3,446	\$3,477	\$3,705
	36	66	42	125	72	LKV3666-42ART	\$3,087	\$3,333	\$3,363	\$3,583
	36	60	42	116	66	LKV3660-42ART	\$2,685	\$2,861	\$2,943	\$3,103

LOK - TEAMWORK

Electrical Options and Upcharges

CT2	
Dual Power Center Top - Black	CT2BL - add \$1,588
Dual Power Center Top - White	CT2WH - add \$1,588
CU1	
Single Power Underside - Black	CU11C - add \$618
Single Power Underside with Wireless Charging - Black	CU11CW - add \$1,479

**Note: Order power infeed that best fits application**

To Order, Specify:

① Veneer Model #	② Edge Detail	③ Wood Collection	④ Top Wood Finish	⑤ Electrical	⑥ Metal Color
Veneer (LKV)	<a href="#">See Edge Detail Options</a>	Essentials	<a href="#">See Essentials Top Wood Finish Options</a>	N None CT2 Dual Power Center Top CU1 Single Power Underside (See chart above)	<a href="#">See Metal Finish Color Options</a>
		Artisan	④ Top Wood Finish <a href="#">See Artisan Top Wood Finish Options</a>		

Description

Rounded Arc Rectangular Table with T Base at Bar Height

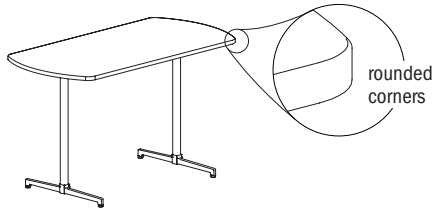

Laminate Tables  
"LKT" Models

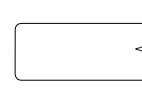

Eased Edge (R3)

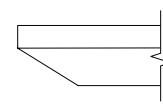

Reverse Bevel Edge (K9)

D	W	H	CTN WT	CU FT	Model	Eased Edge (R3)		Reverse Bevel Edge (K9)	
						Standard Tier 1	Graded In Tier 2	Standard Tier 1	Graded In Tier 2
48	72	42	155	101	LKT4872-42ARRT	\$2,746	\$2,800	\$3,355	\$3,407
42	72	42	143	89	LKT4272-42ARRT	\$2,621	\$2,668	\$3,219	\$3,266
36	72	42	134	77	LKT3672-42ARRT	\$2,499	\$2,536	\$3,087	\$3,125
36	66	42	125	72	LKT3666-42ARRT	\$2,401	\$2,437	\$2,980	\$3,018
36	60	42	116	66	LKT3660-42ARRT	\$2,336	\$2,367	\$2,910	\$2,943

LAMINATE

Features:

- price reflects complete table - top and base
- ships KD in multiple cartons
- model includes adjustable glide

Options:

- specify power/charging option, see below for options and upcharges

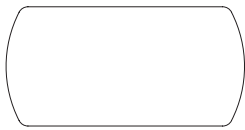

top shape

LOK - TEAMWORK

To Order Specify

1 Laminate Model #	2 Edge Detail	3 Laminate Selection	3a PVC Edge Color	4 Electrical
Laminate (LKT)	<a href="#">See Edge Detail Options</a>	<a href="#">See Laminate Selection</a>	<a href="#">See PVC Edge Color Options</a>	N None CT2 Dual Power Center Top (See chart on next page) CU1 Single Power Underside <b>5 Metal Finish</b> <a href="#">See Metal Finish Color Options</a>

Model Number Breakdown

LKT4872-42ARRT						
LK	T	4872	42	AR	R	T
LOK	Laminate	48" x 72"	Height	Arc Rectangular Top Shape	Rounded Corner	T base

Description

Rounded Arc Rectangular Table with T Base at Bar Height  
(continued)

Veneer Tables  
"LKV" Models

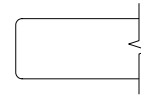

Eased Edge (R3)

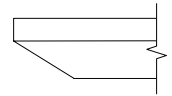

Reverse Bevel Edge (K9)

D	W	H	CTN WT	CU FT	① Model	Eased Edge (R3)		Reverse Bevel Edge (K9)	
						Essentials	Artisan	Essentials	Artisan
48	72	42	155	101	LKV4872-42ARRT	\$3,119	\$3,393	\$3,418	\$3,668
42	72	42	143	89	LKV4272-42ARRT	\$2,989	\$3,230	\$3,272	\$3,495
36	72	42	134	77	LKV3672-42ARRT	\$2,857	\$3,065	\$3,127	\$3,317
36	66	42	125	72	LKV3666-42ARRT	\$2,751	\$2,944	\$3,017	\$3,192
36	60	42	116	66	LKV3660-42ARRT	\$2,685	\$2,861	\$2,943	\$3,103

VENEER

LOK - TEAMWORK

Electrical Options and Upcharges

CT2	
Dual Power Center Top - Black	CT2BL - add \$1,588
Dual Power Center Top - White	CT2WH - add \$1,588
CU1	
Single Power Underside - Black	CU11C - add \$618
Single Power Underside with Wireless Charging - Black	CU11CW - add \$1,479

**Note: Order power infeed that best fits application**

To Order, Specify:

① Veneer Model #	② Edge Detail	③ Wood Collection	④ Top Wood Finish	⑤ Electrical	⑥ Metal Color
Veneer (LKV)	<a href="#">See Edge Detail Options</a>	Essentials	<a href="#">See Essentials Top Wood Finish Options</a>	N None CT2 Dual Power Center Top CU1 Single Power Underside (See chart above)	<a href="#">See Metal Finish Color Options</a>
		Artisan	④ Top Wood Finish <a href="#">See Artisan Top Wood Finish Options</a>		

Description

Racetrack Table with T Base at Bar Height



Laminate Tables "LKT" Models

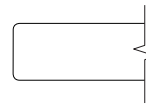

Eased Edge (R3)

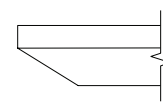

Reverse Bevel Edge (K9)

LAMINATE	D	W	H	CTN WT	CU FT	Model	Standard Tier 1	Graded In Tier 2	Standard Tier 1	Graded In Tier 2
		42	72	42	136	89	LKT4272-42RKT	\$2,621	\$2,668	\$3,219
	36	72	42	129	77	LKT3672-42RKT	\$2,499	\$2,536	\$3,087	\$3,125
	36	66	42	120	72	LKT3666-42RKT	\$2,401	\$2,437	\$2,980	\$3,018
	36	60	42	110	66	LKT3660-42RKT	\$2,336	\$2,367	\$2,910	\$2,943

Features:

- price reflects complete table - top and base
- ships KD in multiple cartons
- model includes adjustable glide

Options:

- specify power/charging option, see below for options and upcharges

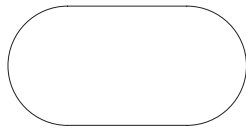

top shape

LOK - TEAMWORK

To Order Specify

1 Laminate Model #	2 Edge Detail	3 Laminate Selection	3a PVC Edge Color	4 Electrical
Laminate (LKT)	<a href="#">See Edge Detail Options</a>	<a href="#">See Laminate Selection</a>	<a href="#">See PVC Edge Color Options</a>	N None CT2 Dual Power Center Top (See chart on next page) CU1 Single Power Underside <b>5 Metal Finish</b> <a href="#">See Metal Finish Color Options</a>

Model Number Breakdown

LKT4872-42RKT					
LK	T	4872	42	RK	T
LOK	Laminate	48" x 72"	Height	Racetrack Top Shape	T base

Description

Racetrack Table with  
T Base at Bar Height  
(continued)

Veneer Tables  
"LKV" Models

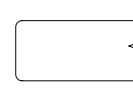

Eased Edge (R3)

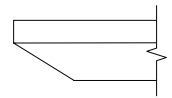

Reverse Bevel Edge (K9)

VENEER	D	W	H	CTN WT	CU FT	① Model	Eased Edge (R3)		Reverse Bevel Edge (K9)	
							Essentials	Artisan	Essentials	Artisan
	48	72	42	147	101	LKV4872-42RKT	\$3,455	\$3,729	\$3,763	\$4,007
	36	72	42	129	77	LKV3672-42RKT	\$3,191	\$3,446	\$3,477	\$3,705
	36	66	42	120	72	LKV3666-42RKT	\$3,087	\$3,333	\$3,363	\$3,583
	36	60	42	110	66	LKV3660-42RKT	\$3,019	\$3,262	\$3,293	\$3,505

LOK - TEAMWORK

Electrical Options and Upcharges

CT2	
Dual Power Center Top - Black	CT2BL - add \$1,588
Dual Power Center Top - White	CT2WH - add \$1,588
CU1	
Single Power Underside - Black	CU11C - add \$618
Single Power Underside with Wireless Charging - Black	CU11CW - add \$1,479

**Note: Order power infeed that best fits application**

To Order, Specify:

① Veneer Model #	② Edge Detail	③ Wood Collection	④ Top Wood Finish	⑤ Electrical	⑥ Metal Color
Veneer (LKV)	<a href="#">See Edge Detail Options</a>	Essentials	<a href="#">See Essentials Top Wood Finish Options</a>	N None CT2 Dual Power Center Top CU1 Single Power Underside (See chart above)	<a href="#">See Metal Finish Color Options</a>
		Artisan	④ Top Wood Finish <a href="#">See Artisan Top Wood Finish Options</a>		

Description

Oval Table with T Base at Bar Height



Laminate Tables "LKT" Models

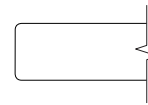

Eased Edge (R3)

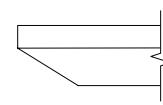

Reverse Bevel Edge (K9)

LAMI	D	W	H	CTN WT	CU FT	Model	Standard Tier 1	Graded In Tier 2	Standard Tier 1	Graded In Tier 2
		36	72	42	119	77	LKT3672-420VT	\$2,499	\$2,536	\$3,087

Features:

- price reflects complete table - top and base
- ships KD in multiple cartons
- model includes adjustable glide

Options:

- specify power/charging option, see below for options and upcharges

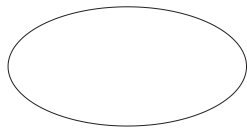

top shape

LOK - TEAMWORK

To Order Specify

1 Laminate Model #	2 Edge Detail	3 Laminate Selection	3a PVC Edge Color	4 Electrical
Laminate (LKT)	<a href="#">See Edge Detail Options</a>	<a href="#">See Laminate Selection</a>	<a href="#">See PVC Edge Color Options</a>	N None CT2 Dual Power Center Top (See chart on next page) CU1 Single Power Underside <b>5 Metal Finish</b> <a href="#">See Metal Finish Color Options</a>

Model Number Breakdown

LKT4272-42RKT					
LK	T	4272	42	OV	T
LOK	Laminate	42" x 72"	Height	Oval Top Shape	T base

Description

Oval Table with T Base at Bar Height  
(continued)

Veneer Tables  
"LKV" Models

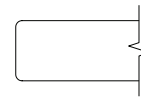

Eased Edge (R3)

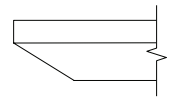

Reverse Bevel Edge (K9)

VEN.	D	W	H	CTN WT	CU FT	① Model	Essentials		Artisan	
							Essentials	Artisan	Essentials	Artisan
	36	72	42	119	77	LKV3672-42OVT	\$3,165	\$3,419	\$3,450	\$3,675

LOK - TEAMWORK

Electrical Options and Upcharges

CT2	
Dual Power Center Top - Black	CT2BL - add \$1,588
Dual Power Center Top - White	CT2WH - add \$1,588
CU1	
Single Power Underside - Black	CU11C - add \$618
Single Power Underside with Wireless Charging - Black	CU11CW - add \$1,479

**Note: Order power infeed that best fits application**

To Order, Specify:

① Veneer Model #	② Edge Detail	③ Wood Collection	④ Top Wood Finish	⑤ Electrical	⑥ Metal Color
Veneer (LKV)	<a href="#">See Edge Detail Options</a>	Essentials	<a href="#">See Essentials Top Wood Finish Options</a>	N None CT2 Dual Power Center Top CU1 Single Power Underside (See chart above)	<a href="#">See Metal Finish Color Options</a>
		Artisan	④ Top Wood Finish <a href="#">See Artisan Top Wood Finish Options</a>		

Description

Boat Table with T Base  
at Bar Height

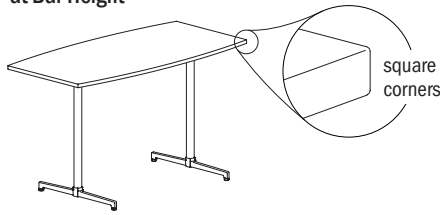

Laminate Tables  
"LKT" Models

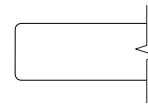

Eased Edge (R3)

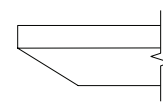

Reverse Bevel Edge (K9)

D	W	H	CTN WT	CU FT	Model	Eased Edge (R3)		Reverse Bevel Edge (K9)	
						Standard Tier 1	Graded In Tier 2	Standard Tier 1	Graded In Tier 2
48	72	42	159	101	LKT4872-42BTT	\$2,746	\$2,800	\$3,355	\$3,407
42	72	42	144	89	LKT4272-42BTT	\$2,621	\$2,668	\$3,219	\$3,266
36	72	42	133	77	LKT3672-42BTT	\$2,499	\$2,536	\$3,087	\$3,125
36	66	42	125	72	LKT3666-42BTT	\$2,401	\$2,437	\$2,980	\$3,018
36	60	42	117	66	LKT3660-42BTT	\$2,336	\$2,367	\$2,910	\$2,943

LAMINATE

Features:

- price reflects complete table - top and base
- ships KD in multiple cartons
- model includes adjustable glide

Options:

- specify power/charging option, see below for options and upcharges



top shape

LOK - TEAMWORK

To Order Specify

1 Laminate Model #	2 Edge Detail	3 Laminate Selection	3a PVC Edge Color	4 Electrical
Laminate (LKT)	<a href="#">See Edge Detail Options</a>	<a href="#">See Laminate Selection</a>	<a href="#">See PVC Edge Color Options</a>	N None CT2 Dual Power Center Top (See chart on next page) CU1 Single Power Underside <b>5 Metal Finish</b> <a href="#">See Metal Finish Color Options</a>

Model Number Breakdown

LKT4872-42BTT					
LK	T	4872	42	BT	T
LOK	Laminate	48" x 72"	Height	Boat Top Shape	T base

Description

Boat Table with T Base  
at Bar Height  
(continued)

Veneer Tables  
"LKV" Models



Eased Edge (R3)

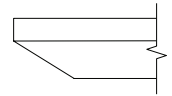

Reverse Bevel Edge (K9)

D	W	H	CTN WT	CU FT	① Model	Eased Edge (R3)		Reverse Bevel Edge (K9)	
						Essentials	Artisan	Essentials	Artisan
48	72	42	159	101	LKV4872-42BTT	\$3,455	\$3,729	\$3,763	\$4,007
42	72	42	144	89	LKV4272-42BTT	\$3,323	\$3,587	\$3,623	\$3,855
36	72	42	133	77	LKV3672-42BTT	\$3,191	\$3,446	\$3,477	\$3,705
36	66	42	125	72	LKV3666-42BTT	\$3,087	\$3,333	\$3,363	\$3,583
36	60	42	117	66	LKV3660-42BTT	\$3,019	\$3,262	\$3,293	\$3,505

VENEER

LOK - TEAMWORK

Electrical Options and Upcharges

CT2	
Dual Power Center Top - Black	CT2BL - add \$1,588
Dual Power Center Top - White	CT2WH - add \$1,588
CU1	
Single Power Underside - Black	CU11C - add \$618
Single Power Underside with Wireless Charging - Black	CU11CW - add \$1,479

**Note: Order power infeed that best fits application**

To Order, Specify:

① Veneer Model #	② Edge Detail	③ Wood Collection	④ Top Wood Finish	⑤ Electrical	⑥ Metal Color
Veneer (LKV)	<a href="#">See Edge Detail Options</a>	Essentials	<a href="#">See Essentials Top Wood Finish Options</a>	N None CT2 Dual Power Center Top CU1 Single Power Underside (See chart above)	<a href="#">See Metal Finish Color Options</a>
		Artisan	④ Top Wood Finish <a href="#">See Artisan Top Wood Finish Options</a>		

Description

Rounded Boat Table with T Base at Bar Height

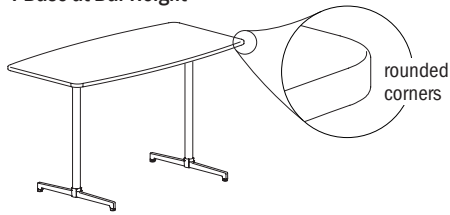

Laminate Tables "LKT" Models

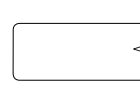

Eased Edge (R3)

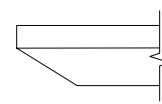

Reverse Bevel Edge (K9)

D	W	H	CTN WT	CU FT	Model	Eased Edge (R3)		Reverse Bevel Edge (K9)	
						Standard Tier 1	Graded In Tier 2	Standard Tier 1	Graded In Tier 2
48	72	42	159	101	LKT4872-42BTRT	\$2,746	\$2,800	\$3,355	\$3,407
42	72	42	144	89	LKT4272-42BTRT	\$2,621	\$2,668	\$3,219	\$3,266
36	72	42	133	77	LKT3672-42BTRT	\$2,499	\$2,536	\$3,087	\$3,125
36	66	42	125	72	LKT3666-42BTRT	\$2,401	\$2,437	\$2,980	\$3,018
36	60	42	117	66	LKT3660-42BTRT	\$2,336	\$2,367	\$2,910	\$2,943

LAMINATE

Features:

- price reflects complete table - top and base
- ships KD in multiple cartons
- model includes adjustable glide

Options:

- specify power/charging option, see below for options and upcharges

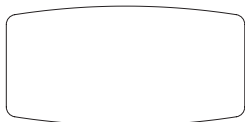

top shape

LOK - TEAMWORK

To Order Specify

1 Laminate Model #	2 Edge Detail	3 Laminate Selection	3a PVC Edge Color	4 Electrical
Laminate (LKT)	<a href="#">See Edge Detail Options</a>	<a href="#">See Laminate Selection</a>	<a href="#">See PVC Edge Color Options</a>	N None CT2 Dual Power Center Top (See chart on next page) CU1 Single Power Underside <b>5 Metal Finish</b> <a href="#">See Metal Finish Color Options</a>

Model Number Breakdown

LKT4872-42BTRT						
LK	T	4872	42	BT	R	T
LOK	Laminate	48" x 72"	Height	Boat Top Shape	Rounded Corner	T base

Description

Rounded Boat Table with  
T Base at Bar Height  
(continued)

Veneer Tables  
"LKV" Models

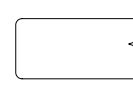

Eased Edge (R3)

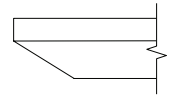

Reverse Bevel Edge (K9)

D	W	H	CTN WT	CU FT	① Model	Eased Edge (R3)		Reverse Bevel Edge (K9)	
						Essentials	Artisan	Essentials	Artisan
48	72	42	159	101	LKV4872-42BTRT	\$3,455	\$3,729	\$3,763	\$4,007
42	72	42	144	89	LKV4272-42BTRT	\$3,323	\$3,587	\$3,623	\$3,855
36	72	42	133	77	LKV3672-42BTRT	\$3,191	\$3,446	\$3,477	\$3,705
36	66	42	125	72	LKV3666-42BTRT	\$3,087	\$3,333	\$3,363	\$3,583
36	60	42	117	66	LKV3660-42BTRT	\$3,019	\$3,262	\$3,293	\$3,505

VENEER

LOK - TEAMWORK

Electrical Options and Upcharges

CT2	
Dual Power Center Top - Black	CT2BL - add \$1,588
Dual Power Center Top - White	CT2WH - add \$1,588
CU1	
Single Power Underside - Black	CU11C - add \$618
Single Power Underside with Wireless Charging - Black	CU11CW - add \$1,479

**Note: Order power infeed that best fits application**

To Order, Specify:

① Veneer Model #	② Edge Detail	③ Wood Collection	④ Top Wood Finish	⑤ Electrical	⑥ Metal Color
Veneer (LKV)	<a href="#">See Edge Detail Options</a>	Essentials	<a href="#">See Essentials Top Wood Finish Options</a>	N None CT2 Dual Power Center Top CU1 Single Power Underside (See chart above)	<a href="#">See Metal Finish Color Options</a>
		Artisan	④ Top Wood Finish <a href="#">See Artisan Top Wood Finish Options</a>		

Description

Rounded Double Chevron Table with T Base at Bar Height

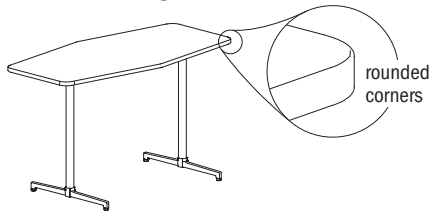

Laminate Tables  
"LKT" Models

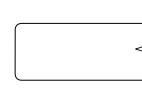

Eased Edge (R3)

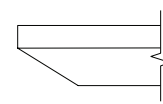

Reverse Bevel Edge (K9)

LAMINATE

D	W	H	CTN WT	CU FT	Model	Eased Edge (R3)		Reverse Bevel Edge (K9)	
						Standard Tier 1	Graded In Tier 2	Standard Tier 1	Graded In Tier 2
48	72	42	153	101	LKT4872-42DCRT	\$2,746	\$2,800	\$3,355	\$3,407
48	60	42	135	85	LKT4860-42DCRT	\$2,544	\$2,588	\$3,137	\$3,181
42	72	42	137	89	LKT4272-42DCRT	\$2,621	\$2,668	\$3,219	\$3,266
42	60	42	121	75	LKT4260-42DCRT	\$2,440	\$2,475	\$3,024	\$3,061
36	72	42	125	77	LKT3672-42DCRT	\$2,499	\$2,536	\$3,087	\$3,125
36	60	42	111	66	LKT3660-42DCRT	\$2,336	\$2,367	\$2,910	\$2,943

Features:

- price reflects complete table - top and base
- ships KD in multiple cartons
- model includes adjustable glide

Options:

- specify power/charging option, see below for options and upcharges

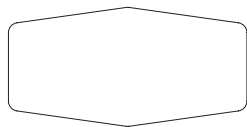

top shape

LOK - TEAMWORK

To Order Specify

1 Laminate Model #	2 Edge Detail	3 Laminate Selection	3a PVC Edge Color	4 Electrical
Laminate (LKT)	<a href="#">See Edge Detail Options</a>	<a href="#">See Laminate Selection</a>	<a href="#">See PVC Edge Color Options</a>	N None CT2 Dual Power Center Top (See chart on next page) CU1 Single Power Underside <b>5 Metal Finish</b> <a href="#">See Metal Finish Color Options</a>

Model Number Breakdown

LKT4872-42DCRT						
LK	T	4872	42	DC	R	T
LOK	Laminate	48" x 72"	Height	Double Chevron Top Shape	Rounded Corner	T base

Description

Rounded Double Chevron Table with  
T Base at Bar Height  
(continued)

Veneer Tables  
"LKV" Models

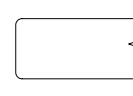

Eased Edge (R3)

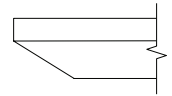

Reverse Bevel Edge (K9)

D	W	H	CTN WT	CU FT	① Model	Eased Edge (R3)		Reverse Bevel Edge (K9)	
						Essentials	Artisan	Essentials	Artisan
48	72	42	153	101	LKV4872-42DCRT	\$3,455	\$3,729	\$3,763	\$4,007
48	60	42	135	85	LKV4860-42DCRT	\$3,240	\$3,501	\$3,529	\$3,761
42	72	42	137	89	LKV4272-42DCRT	\$3,323	\$3,587	\$3,623	\$3,855
42	60	42	121	75	LKV4260-42DCRT	\$3,130	\$3,379	\$3,415	\$3,633
36	72	42	125	77	LKV3672-42DCRT	\$3,263	\$3,522	\$3,555	\$3,786
36	60	42	111	66	LKV3660-42DCRT	\$3,046	\$3,289	\$3,318	\$3,532

VENEER

LOK - TEAMWORK

Electrical Options and Upcharges

CT2	
Dual Power Center Top - Black	CT2BL - add \$1,588
Dual Power Center Top - White	CT2WH - add \$1,588
CU1	
Single Power Underside - Black	CU11C - add \$618
Single Power Underside with Wireless Charging - Black	CU11CW - add \$1,479

**Note: Order power infeed that best fits application**

To Order, Specify:

① Veneer Model #	② Edge Detail	③ Wood Collection	④ Top Wood Finish	⑤ Electrical	⑥ Metal Color
Veneer (LKV)	<a href="#">See Edge Detail Options</a>	Essentials	<a href="#">See Essentials Top Wood Finish Options</a>	N None CT2 Dual Power Center Top CU1 Single Power Underside (See chart above)	<a href="#">See Metal Finish Color Options</a>
		Artisan	④ Top Wood Finish <a href="#">See Artisan Top Wood Finish Options</a>		

Description

Taper Table with T Base at Bar Height

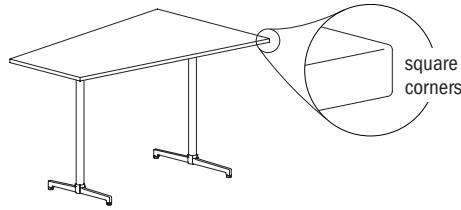

Laminate Tables "LKT" Models

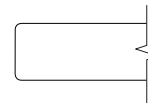

Eased Edge (R3)

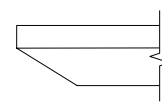

Reverse Bevel Edge (K9)

LAMI	D	W	H	CTN WT	CU FT	Model	Standard Tier 1	Graded In Tier 2	Standard Tier 1	Graded In Tier 2
		48	72	42	140	101	LKT4872-42TPT	\$2,760	\$2,810	\$3,370

Features:

- price reflects complete table - top and base
- ships KD in multiple cartons
- model includes adjustable glide

Options:

- specify power/charging option, see below for options and upcharges

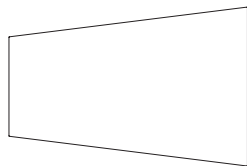

top shape

LOK - TEAMWORK

To Order Specify

1 Laminate Model #	2 Edge Detail	3 Laminate Selection	3a PVC Edge Color	4 Electrical
Laminate (LKT)	<a href="#">See Edge Detail Options</a>	<a href="#">See Laminate Selection</a>	<a href="#">See PVC Edge Color Options</a>	N None CT2 Dual Power Center Top (See chart on next page) CU1 Single Power Underside <b>5 Metal Finish</b> <a href="#">See Metal Finish Color Options</a>

Model Number Breakdown

LKT4872-42TPT					
LK	T	4872	42	TP	T
LOK	Laminate	48" x 72"	Height	Taper Top Shape	T base

Description

Taper Table with T Base  
at Bar Height  
(continued)

Veneer Tables  
"LKV" Models

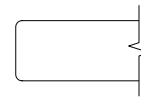

Eased Edge (R3)

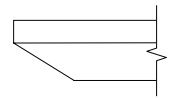

Reverse Bevel Edge (K9)

VEN.	D	W	H	CTN WT	CU FT	① Model	Eased Edge (R3)		Reverse Bevel Edge (K9)	
							Essentials	Artisan	Essentials	Artisan
	48	72	42	140	101	LKV4872-42TPT	\$3,467	\$3,744	\$3,776	\$4,023

LOK - TEAMWORK

Electrical Options and Upcharges

CT2	
Dual Power Center Top - Black	CT2BL - add \$1,588
Dual Power Center Top - White	CT2WH - add \$1,588
CU1	
Single Power Underside - Black	CU11C - add \$618
Single Power Underside with Wireless Charging - Black	CU11CW - add \$1,479

**Note: Order power infeed that best fits application**

To Order, Specify:

① Veneer Model #	② Edge Detail	③ Wood Collection	④ Top Wood Finish	⑤ Electrical	⑥ Metal Color
Veneer (LKV)	<a href="#">See Edge Detail Options</a>	Essentials	<a href="#">See Essentials Top Wood Finish Options</a>	N None CT2 Dual Power Center Top CU1 Single Power Underside (See chart above)	<a href="#">See Metal Finish Color Options</a>
		Artisan	④ Top Wood Finish <a href="#">See Artisan Top Wood Finish Options</a>		

Description

Rounded Taper Table with T Base at Bar Height

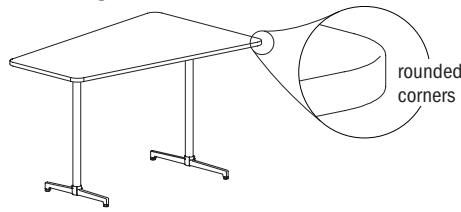

Laminate Tables "LKT" Models

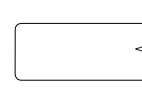

Eased Edge (R3)

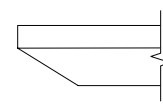

Reverse Bevel Edge (K9)

LAMI	D	W	H	CTN WT	CU FT	Model	Standard Tier 1	Graded In Tier 2	Standard Tier 1	Graded In Tier 2
		48	72	42	140	101	LKT4872-42TPRT	\$2,760	\$2,810	\$3,370

Features:

- price reflects complete table - top and base
- ships KD in multiple cartons
- model includes adjustable glide

Options:

- specify power/charging option, see below for options and upcharges

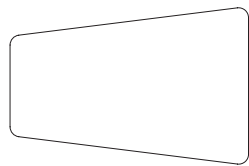

top shape

LOK - TEAMWORK

To Order Specify

1 Laminate Model #	2 Edge Detail	3 Laminate Selection	3a PVC Edge Color	4 Electrical
Laminate (LKT)	<a href="#">See Edge Detail Options</a>	<a href="#">See Laminate Selection</a>	<a href="#">See PVC Edge Color Options</a>	N None CT2 Dual Power Center Top (See chart on next page) CU1 Single Power Underside <b>5 Metal Finish</b> <a href="#">See Metal Finish Color Options</a>

Model Number Breakdown

LKT4872-42TPRT						
LK	T	4872	42	TP	R	T
LOK	Laminate	48" x 72"	Height	Taper Top Shape	Rounded Corner	T base

Description

Rounded Taper Table with T Base  
at Bar Height  
(continued)

Veneer Tables  
"LKV" Models

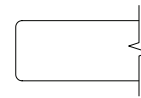

Eased Edge (R3)

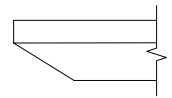

Reverse Bevel Edge (K9)

VEN.	D	W	H	CTN WT	CU FT	① Model	Eased Edge (R3)		Reverse Bevel Edge (K9)	
							Essentials	Artisan	Essentials	Artisan
	48	72	42	140	101	LKV4872-42TPRT	\$3,467	\$3,744	\$3,776	\$4,023

LOK - TEAMWORK

Electrical Options and Upcharges

CT2	
Dual Power Center Top - Black	CT2BL - add \$1,588
Dual Power Center Top - White	CT2WH - add \$1,588
CU1	
Single Power Underside - Black	CU11C - add \$618
Single Power Underside with Wireless Charging - Black	CU11CW - add \$1,479

**Note: Order power infeed that best fits application**

To Order, Specify:

① Veneer Model #	② Edge Detail	③ Wood Collection	④ Top Wood Finish	⑤ Electrical	⑥ Metal Color
Veneer (LKV)	<a href="#">See Edge Detail Options</a>	Essentials	<a href="#">See Essentials Top Wood Finish Options</a>	N None CT2 Dual Power Center Top CU1 Single Power Underside (See chart above)	<a href="#">See Metal Finish Color Options</a>
		Artisan	④ Top Wood Finish <a href="#">See Artisan Top Wood Finish Options</a>		

Description

Bullet Table with T Base at Bar Height

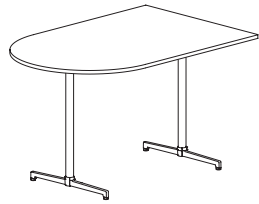

Laminate Tables "LKT" Models

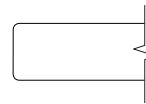

Eased Edge (R3)

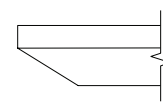

Reverse Bevel Edge (K9)

LAMI	D	W	H	CTN WT	CU FT	Model	Standard Tier 1	Graded In Tier 2	Standard Tier 1	Graded In Tier 2
		48	72	42	156	101	LKT4872-42BUT	\$2,746	\$2,800	\$3,355

Features:

- price reflects complete table - top and base
- ships KD in multiple cartons
- model includes adjustable glide

Options:

- specify power/charging option, see below for options and upcharges

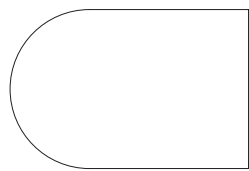

top shape

LOK - TEAMWORK

To Order Specify

1 Laminate Model #	2 Edge Detail	3 Laminate Selection	3a PVC Edge Color	4 Electrical
Laminate (LKT)	<a href="#">See Edge Detail Options</a>	<a href="#">See Laminate Selection</a>	<a href="#">See PVC Edge Color Options</a>	N None CT2 Dual Power Center Top (See chart on next page) CU1 Single Power Underside <b>5 Metal Finish</b> <a href="#">See Metal Finish Color Options</a>

Model Number Breakdown

LKT4872-42BUT					
LK	T	4872	42	BU	T
LOK	Laminate	48" x 72"	Height	Bullet Top Shape	T base

Description

Bullet Table with T Base  
at Bar Height  
(continued)

Veneer Tables  
"LKV" Models

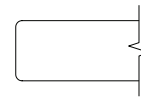

Eased Edge (R3)

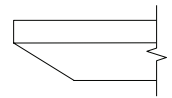

Reverse Bevel Edge (K9)

VEN.	D	W	H	CTN WT	CU FT	① Model	Essentials		Artisan	
							Essentials	Artisan	Essentials	Artisan
	48	72	42	156	101	LKV4872-42BUT	\$3,455	\$3,729	\$3,763	\$4,007

LOK - TEAMWORK

Electrical Options and Upcharges

CT2	
Dual Power Center Top - Black	CT2BL - add \$1,773
Dual Power Center Top - White	CT2WH - add \$1,773
CU1	
Single Power Underside - Black	CU11C - add \$690
Single Power Underside with Wireless Charging - Black	CU11CW - add \$1,651

**Note: Order power infeed that best fits application**

To Order, Specify:

① Veneer Model #	② Edge Detail	③ Wood Collection	④ Top Wood Finish	⑤ Electrical	⑥ Metal Color
Veneer (LKV)	<a href="#">See Edge Detail Options</a>	Essentials	<a href="#">See Essentials Top Wood Finish Options</a>	N None CT2 Dual Power Center Top CU1 Single Power Underside (See chart above)	<a href="#">See Metal Finish Color Options</a>
		Artisan	④ Top Wood Finish <a href="#">See Artisan Top Wood Finish Options</a>		

Description

Hive Table with T Base at Bar Height

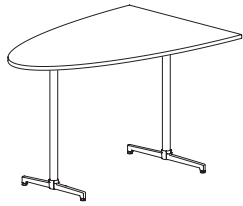

Laminate Tables "LKT" Models

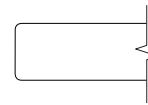

Eased Edge (R3)

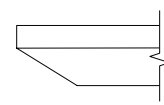

Reverse Bevel Edge (K9)

LAMI	D	W	H	CTN WT	CU FT	Model	Standard Tier 1	Graded In Tier 2	Standard Tier 1	Graded In Tier 2
		48	72	42	138	101	LKT4872-42HVT	\$2,746	\$2,800	\$3,355

Features:

- price reflects complete table - top and base
- ships KD in multiple cartons
- model includes adjustable glide

Options:

- specify power/charging option, see below for options and upcharges

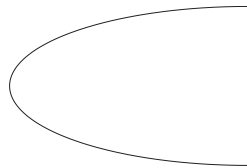

top shape

LOK - TEAMWORK

To Order Specify

1 Laminate Model #	2 Edge Detail	3 Laminate Selection	3a PVC Edge Color	4 Electrical
Laminate (LKT)	<a href="#">See Edge Detail Options</a>	<a href="#">See Laminate Selection</a>	<a href="#">See PVC Edge Color Options</a>	N None CT2 Dual Power Center Top (See chart on next page) CU1 Single Power Underside <b>5 Metal Finish</b> <a href="#">See Metal Finish Color Options</a>

Model Number Breakdown

LKT4872-42HVT					
LK	T	4872	42	HV	T
LOK	Laminate	48" x 72"	Height	Hive Top Shape	T base

Description

Hive Table with T Base  
at Bar Height  
(continued)

Veneer Tables  
"LKV" Models

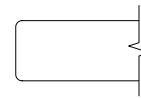

Eased Edge (R3)

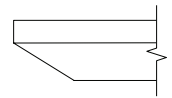

Reverse Bevel Edge (K9)

VEN.	D	W	H	CTN WT	CU FT	① Model	Essentials		Artisan	
							Essentials	Artisan	Essentials	Artisan
	48	72	42	138	101	LKV4872-42HVT	\$3,455	\$3,729	\$3,763	\$4,007

LOK - TEAMWORK

Electrical Options and Upcharges

CT2	
Dual Power Center Top - Black	CT2BL - add \$1,773
Dual Power Center Top - White	CT2WH - add \$1,773
CU1	
Single Power Underside - Black	CU11C - add \$690
Single Power Underside with Wireless Charging - Black	CU11CW - add \$1,651

**Note: Order power infeed that best fits application**

To Order, Specify:

① Veneer Model #	② Edge Detail	③ Wood Collection	④ Top Wood Finish	⑤ Electrical	⑥ Metal Color
Veneer (LKV)	<a href="#">See Edge Detail Options</a>	Essentials	<a href="#">See Essentials Top Wood Finish Options</a>	N None CT2 Dual Power Center Top CU1 Single Power Underside (See chart above)	<a href="#">See Metal Finish Color Options</a>
		Artisan	④ Top Wood Finish <a href="#">See Artisan Top Wood Finish Options</a>		

Description

Wedge Table with T Base  
at Bar Height

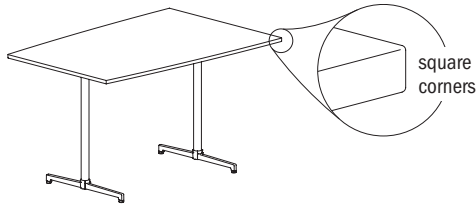

Laminate Tables  
"LKT" Models

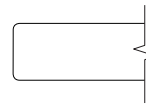

Eased Edge (R3)

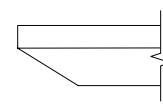

Reverse Bevel Edge (K9)

LAMI	D	W	H	CTN WT	CU FT	1 Model	Standard Tier 1	Graded In Tier 2	Standard Tier 1	Graded In Tier 2
		48	72	42	160	101	LKT4872-42WDT	\$2,746	\$2,800	\$3,355

Features:

- price reflects complete table - top and base
- ships KD in multiple cartons
- model includes adjustable glide

Options:

- specify power/charging option, see below for options and upcharges

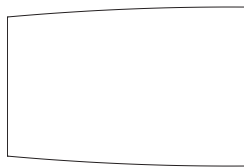

top shape

LOK - TEAMWORK

To Order Specify

1 Laminate Model #	2 Edge Detail	3 Laminate Selection	3a PVC Edge Color	4 Electrical
Laminate (LKT)	<a href="#">See Edge Detail Options</a>	<a href="#">See Laminate Selection</a>	<a href="#">See PVC Edge Color Options</a>	N None CT2 Dual Power Center Top (See chart on next page) CU1 Single Power Underside <b>5 Metal Finish</b> <a href="#">See Metal Finish Color Options</a>

Model Number Breakdown

LKT4872-42WDT					
LK	T	4872	42	WD	T
LOK	Laminate	48" x 72"	Height	Wedge Top Shape	T base

Description

Wedge Table with T Base  
at Bar Height  
(continued)

Veneer Tables  
"LKV" Models

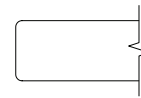

Eased Edge (R3)

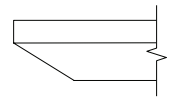

Reverse Bevel Edge (K9)

VEN.	D	W	H	CTN WT	CU FT	① Model	Eased Edge (R3)		Reverse Bevel Edge (K9)	
							Essentials	Artisan	Essentials	Artisan
	48	72	42	160	101	LKV4872-42WDT	\$3,455	\$3,729	\$3,763	\$4,007

LOK - TEAMWORK

Electrical Options and Upcharges

CT2	
Dual Power Center Top - Black	CT2BL - add \$1,588
Dual Power Center Top - White	CT2WH - add \$1,588
CU1	
Single Power Underside - Black	CU11C - add \$618
Single Power Underside with Wireless Charging - Black	CU11CW - add \$1,479

**Note: Order power infeed that best fits application**

To Order, Specify:

① Veneer Model #	② Edge Detail	③ Wood Collection	④ Top Wood Finish	⑤ Electrical	⑥ Metal Color
Veneer (LKV)	<a href="#">See Edge Detail Options</a>	Essentials	<a href="#">See Essentials Top Wood Finish Options</a>	N None CT2 Dual Power Center Top CU1 Single Power Underside (See chart above)	<a href="#">See Metal Finish Color Options</a>
		Artisan	④ Top Wood Finish <a href="#">See Artisan Top Wood Finish Options</a>		

Description

Rounded Wedge Table with T Base at Bar Height

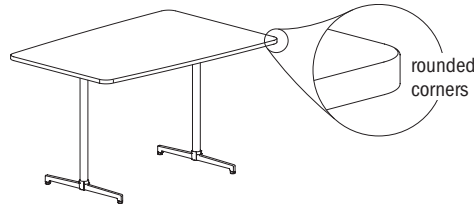

Laminate Tables "LKT" Models

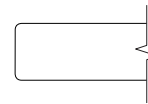

Eased Edge (R3)

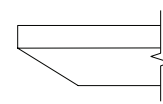

Reverse Bevel Edge (K9)

LAMI	D	W	H	CTN WT	CU FT	1 Model	Standard Tier 1	Graded In Tier 2	Standard Tier 1	Graded In Tier 2
		48	72	42	160	101	LKT4872-42WDRT	\$2,746	\$2,800	\$3,355

Features:

- price reflects complete table - top and base
- ships KD in multiple cartons
- model includes adjustable glide

Options:

- specify power/charging option, see below for options and upcharges

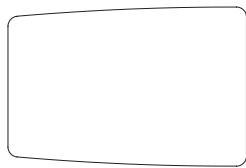

top shape

LOK - TEAMWORK

To Order Specify

1 Laminate Model #	2 Edge Detail	3 Laminate Selection	3a PVC Edge Color	4 Electrical
Laminate (LKT)	<a href="#">See Edge Detail Options</a>	<a href="#">See Laminate Selection</a>	<a href="#">See PVC Edge Color Options</a>	N None CT2 Dual Power Center Top (See chart on next page) CU1 Single Power Underside <b>5 Metal Finish</b> <a href="#">See Metal Finish Color Options</a>

Model Number Breakdown

LKT4872-42WDRT						
LK	T	4872	42	WD	R	T
LOK	Laminate	48" x 72"	Height	Wedge Top Shape	Rounded Corner	T base

Description

Rounded Wedge Table with  
T Base at Bar Height  
(continued)

Veneer Tables  
"LKV" Models

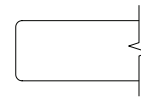

Eased Edge (R3)

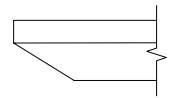

Reverse Bevel Edge (K9)

VEN.	D	W	H	CTN WT	CU FT	① Model	Eased Edge (R3)		Reverse Bevel Edge (K9)	
							Essentials	Artisan	Essentials	Artisan
	48	72	42	160	101	LKV4872-42WDRT	\$3,455	\$3,729	\$3,763	\$4,007

LOK - TEAMWORK

Electrical Options and Upcharges

CT2	
Dual Power Center Top - Black	CT2BL - add \$1,588
Dual Power Center Top - White	CT2WH - add \$1,588
CU1	
Single Power Underside - Black	CU11C - add \$618
Single Power Underside with Wireless Charging - Black	CU11CW - add \$1,479

**Note: Order power infeed that best fits application**

To Order, Specify:

① Veneer Model #	② Edge Detail	③ Wood Collection	④ Top Wood Finish	⑤ Electrical	⑥ Metal Color
Veneer (LKV)	<a href="#">See Edge Detail Options</a>	Essentials	<a href="#">See Essentials Top Wood Finish Options</a>	N None CT2 Dual Power Center Top CU1 Single Power Underside (See chart above)	<a href="#">See Metal Finish Color Options</a>
		Artisan	④ Top Wood Finish <a href="#">See Artisan Top Wood Finish Options</a>		

Description	D	W	H	CTN WT	CU FT	① Model	List Price
<b>3 Prong Plug - 110 Power Infeed</b>				1	1	AP72	\$357

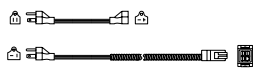

**Features:**

- 72" plug power infeed
- 20 amps/110 volts max
- 3 prong plug - 15 amp adapter plug included
- single circuit use only

<b>Hardwire Power Infeed</b>				1	1	HP72	\$290
------------------------------	--	--	--	---	---	------	-------



**Features:**

- 72" hardwire power infeed
- 20 amps/120 volts max
- single or double circuit
- electrical contractor responsible for connection to building power source

<b>Quick Disconnect Power Infeed</b>				1	1	MP72	\$267
--------------------------------------	--	--	--	---	---	------	-------



**Features:**

- must be used with QD1
- 72" modular power infeed
- 20 amps/120 volts max
- single or double circuit

<b>Quick Disconnect Wall Outlet</b>				1	1	QD1	\$137
-------------------------------------	--	--	--	---	---	-----	-------

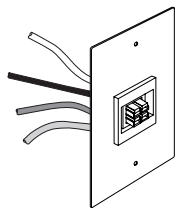

**Features:**

- must be used with MP72
- works for both single or double circuit
- 20 amps/120 volts max
- electrical contractor responsible for connection to building power source

<b>Vertical Wire Manager</b>	½	2 ¼	33	1	1	AVL33	\$154
	½	2 ¼	25	1	1	AVL25	\$117
	½	2 ¼	22	1	1	AVL20	\$95
	½	2 ¼	17	1	1	AVL17	\$90

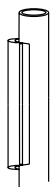

**Features:**

- field installed
- use AVL33 for 42"h tables with disk base
- use AVL25 for 42"h tables
- use AVL20 for 36"h tables
- use AVL17 for 29"h tables

**Options:**

- specify plastic color, Black (B) or Silver (S)

<b>Flexible Vertical Wire Manager</b>	1 ½	1 ½	45	4	1	45VWM	\$146
---------------------------------------	-----	-----	----	---	---	-------	-------



**Features:**

- black plastic
- field installed to bottom of table top, with screws provided
- wire manager is 1 ½" diameter
- weighted base is 4" diameter
- length can be adjusted by removing individual discs as required

Description	D	W	H	CTN WT	CU FT	① Model	List Price
<b>Power Strip</b>	1 ½	1 ¾	8	3	1	GP9ACP1-0212	\$103

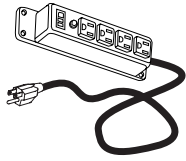

- Features:**
- power surge with 10" cord
  - four electrical outlets
  - includes switch
  - field installed

<b>Wire Management Velcro Straps</b>	1 ¾	3 ½	¼	1	1	04WVS	\$63
--------------------------------------	-----	-----	---	---	---	-------	------

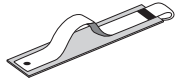

- Features:**
- black, set of 4
  - field installed to bottom of table top, with adhesive tape provided

<b>Cable Management Clips</b>	2 ⅝	3 ¾	1 ⅝	1	1	0304CMC	\$61
-------------------------------	-----	-----	-----	---	---	---------	------

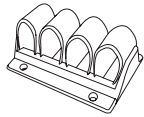

- Features:**
- black plastic
  - installed to bottom of table top
  - four retention loops

<b>Floor Mount Glide</b>	3	2 ¼	½	1	1	LKB516-18ANCHOR	\$47
--------------------------	---	-----	---	---	---	-----------------	------

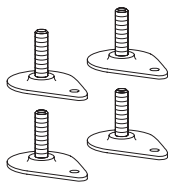

- Features:**
- field installed glides for mounting table base to floor
  - ¼" diameter hole in the glide for mounting
  - set of 4
  - table can be leveled before attached to floor
  - floor attachment hardware provided by installer
  - glide threads ⅜"-16

<b>Single Monitor Arm</b>	4	11	10	9	1	GP5901MA	\$761
---------------------------	---	----	----	---	---	----------	-------

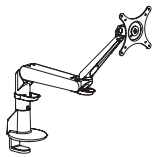

- Features:**
- one-touch reposition monitor adjustment
  - tension adjustment at each joint
  - flat panel mount rotates for portrait or landscape viewing
  - edge mount installation from above surface
  - cable management routes cables below monitor arm
  - specify Black (B) or Silver (S)
  - quick install VESA mount adapter

<b>Wire Management Tray</b>	7 ½	45	3	8	2	GP9WMT1-0845	\$300
	7 ½	35	3	6	1	GP9WMT1-0835	\$253
	7 ½	25	3	4	1	GP9WMT1-0825	\$205

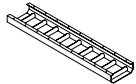

- Features:**
- silver powder-coated finish
  - four hanging brackets (CI2C00)

<b>Wire Manager Trough</b>	2 ½	36	2 ½	4	1	36WCT	\$169
	2 ½	24	2 ½	3	1	24WCT	\$154
	2 ½	12	2 ½	2	1	12WCT	\$132

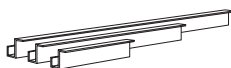

- Features:**
- black plastic
  - field installed to bottom of table top, with screws provided

**Accessories/ Keyboard/ Tasklights**

For an additional list of electrical units, grommets, keyboards, wire management, monitor arms & telecom jacks, please see our [accessories price list](#)

Contact your customer service representative for specific questions regarding which units can be used with Lok Teamwork.

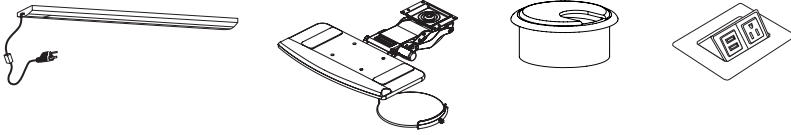

**Conference - Table of Contents**



Training



Teamwork



Conference



Lounge

**Lok - Conference**

**Product Information**

Conference Overview . . . . . 170  
 Tables Shapes & Sizes . . . . . 176-177  
 Laminate Specifications . . . . . 173  
 Veneer Specifications . . . . . 174  
 Solid Surface Specifications . . . . . 174  
 Base Styles - Features . . . . . 178  
 Electrical Planning - Options . . . . . 179-181

**Pricing Pages**

Conference Tables at Working Height . 182-295  
 Conference Tables at Counter Height . 296-349  
 Conference Tables at Bar Height . . . 350-403  
 Credenzas . . . . . 404-407  
 Electrical . . . . . 408-409

## Conference - Overview



rectangular  
29"H - Pages 222, 224, 226,  
234, 236, 238  
36"H - Pages 334, 338  
42"H - Pages 386, 390



rounded rectangular  
29"H - Pages 228, 230, 232,  
240, 242, 244  
36"H - Pages 336, 340  
42"H - Pages 388, 392

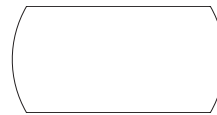

arc rectangular  
29"H - Pages 246, 248, 250  
258, 260, 262  
36"H - Pages 342, 346  
42"H - Pages 394, 398



rounded arc rectangular  
29"H - Pages 252, 254, 256  
264, 266, 268  
36"H - Pages 344, 348  
42"H - Pages 396, 400

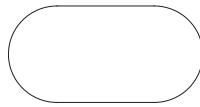

racetrack  
29"H - Pages 270, 272, 274  
36"H - Pages 350  
42"H - Pages 402

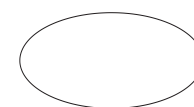

oval  
29"H - Pages 276, 278  
36"H - Pages 352  
42"H - Pages 404

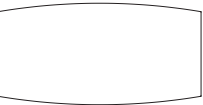

boat  
29"H - Pages 280, 282, 284  
292, 294, 296  
36"H - Pages 354, 356  
42"H - Pages 406, 408

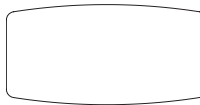

rounded boat  
29"H - Pages 286, 288, 290

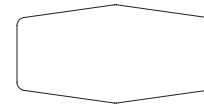

rounded double chevron  
29"H - Pages 298, 300  
36"H - Pages 358, 360  
42"H - Pages 410, 412

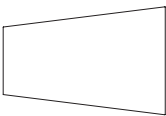

taper  
29"H - Pages 302, 304, 310, 312  
36"H - Pages 362, 366  
42"H - Pages 414, 418

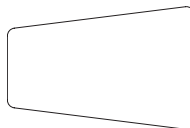

rounded taper  
29"H - Pages 306, 308, 314, 316  
36"H - Pages 364, 368  
42"H - Pages 416, 420

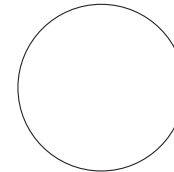

round  
29"H - Pages 318, 320  
36"H - Pages 370, 372  
42"H - Pages 422, 424

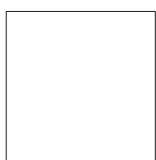

square  
29"H - Pages 322, 326  
36"H - Pages 374, 378  
42"H - Pages 426, 430

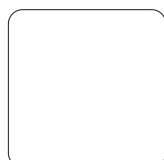

rounded square  
29"H - Pages 324, 328  
36"H - Pages 376, 378  
42"H - Pages 428, 432

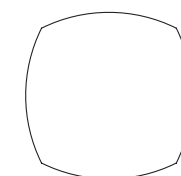

squircle  
29"H - Pages 330, 332  
36"H - Pages 382, 384  
42"H - Pages 434, 436

## Conference - Materials

### Laminate Tops

Lok conference table worksurfaces are offered in HPL (High Pressure Laminate) The tops are 1 3/16" thick, 3 ply balanced construction. Particle board core and a phenolic backer sheet complete the balanced construction.

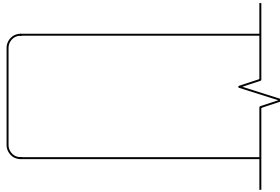

**Eased Edge (R3)**  
PVC

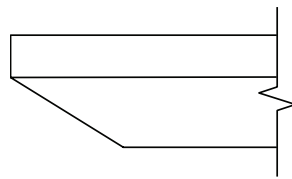

**Reverse Bevel (K9)**  
PVC on painted top of painted MDF

### Standard PVC Edge Colors

JSI supports 26 standard PVC edge colors listed below. These coordinate with our Standard (Tier1) Laminates.

When selecting a Standard (Tier 1) Laminate, the coordinating PVC edge color is automatically applied. When selecting a Graded-In Laminate (Tier 2 or 3), you will be prompted to choose one these 26 PVC edge colors to be applied to the edge.

<b>ALB</b> Alabaster	<b>MES</b> Mesa
<b>BEL</b> Belair	<b>MIN</b> Mineral
<b>BLK</b> Black	<b>MCH</b> Mocha
<b>BRK</b> Brickdust	<b>OBK</b> Outback
<b>BBL</b> Bridal Blanco	<b>PIL</b> Pilsner
<b>CSK</b> Cask	<b>PIN</b> Pinnacle Walnut
<b>CLY</b> Clay	<b>SHD</b> Shadow
<b>DWH</b> Designer White	<b>SLG</b> Slate Grey
<b>EGR</b> Egret	<b>UMB</b> Umber
<b>FAW</b> Fawn	<b>VAL</b> Valley
<b>FLN</b> Flint	<b>WAL</b> Walnut Heights
<b>FLO</b> Florence Walnut	<b>WEA</b> Weathered Ash
<b>LOF</b> Loft	<b>ZEN</b> Zen Grey

### Standard Laminates

JSI Standard Laminate program consists of 26 solid and wood grain patterns, and establish our Tier 1 laminate pricing. Each has a coordinating PVC edge color that is automatically used with the Standard Laminates.

#### Wood Grain Laminate

<b>BEL</b> Belair	<b>MIN</b> Mineral
<b>BRK</b> Brickdust	<b>MCH</b> Mocha
<b>CSK</b> Cask	<b>OBK</b> Outback
<b>CLY</b> Clay	<b>PIL</b> Pilsner
<b>EGR</b> Egret	<b>PIN</b> Pinnacle Walnut
<b>FAW</b> Fawn	<b>UMB</b> Umber
<b>FLN</b> Flint	<b>VAL</b> Valley
<b>FLO</b> Florence Walnut	<b>WAL</b> Walnut Heights
<b>LOF</b> Loft	<b>WEA</b> Weathered Ash
<b>MES</b> Mesa	

#### Solid Laminate

<b>ALB</b> Alabaster
<b>BLK</b> Black
<b>BBL</b> Bridal Blanco
<b>DWH</b> Designer White
<b>SHD</b> Shadow
<b>SLG</b> Slate Grey
<b>ZEN</b> Zen Grey

## Conference - Materials

### Veneer Tops

Tops are 1 3/8" thick, 5 ply balanced construction with particle board core. Standard Tier 1 veneer is essentials, book matched for cherry, maple, walnut and black oak veneer. Standard Tier 2 veneer is artisan.

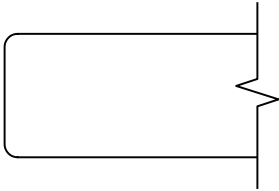

**Eased Edge (R3)**  
Internal Lumber Band

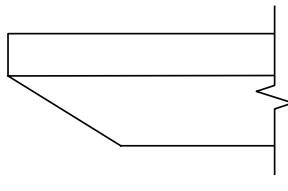

**Reverse Bevel (K9)**  
Veneer Band on Stained MDF

### Finish - Stain/Colors

#### ESS Essentials Veneer Collection

BRK	Brickdust	MIN	Mineral
CSK	Cask	MCH	Mocha
CLY	Clay	OBK	Outback
FAW	Fawn	PIL	Pilsner
FLX	Flax	SIE	Sienna
FLN	Flint	TRF	Truffle
LOF	Loft	UMB	Umber
MES	Mesa	VAL	Valley

#### ART Artisan Veneer Collection

BAR	Barrel	RAV	Raven
BUF	Buff	RYE	Rye
CND	Cinder	SAB	Sable
EGR	Egret	SAD	Saddle

#### Protective Top Coat

DuraTex™ offers exceptional hardness along with abrasion and impact resistance, it has been formulated to eliminate hazardous and harmful gases that are normally associated with wood finish.

#### DuraTex™ Features

**Safety** - Significantly reduces hazardous formaldehyde emissions which help improve the quality of the of the indoor air we breathe.  
**Quality** - Developed to be tough and durable with special attention to appearance. The DuraTex™ finish preserves the natural beauty of wood.  
**Durability** - Designed to meet a wide range of demanding performance and environmental standards to withstand even the highest wear and tear.

#### Finish Sheen

All veneer finishes are standard in 35-sheen, with the exception of Raven. Raven is only offered in 15-sheen. All other finishes can have their sheen modified with a 15% upcharge added to the list price of each item.

#### Custom/Special Finishes

JSI, upon request, will accommodate special finishes. A written request is required to proceed with custom finish orders. A sample reference is required for first-time matches and must be included with the written request.

There is a one-time charge of **\$412 list per order** for any non-standard wood finish.

Orders will be entered noting the special finish. A sample match will be provided to the customer. Written approval is needed before the finish process can be started. Delays in approval may have an impact on lead times.

Every effort will be made to create the requested match; however, an acceptable match may not be possible because of natural variations of wood. These natural variations can also cause minor differences in the final finish product.

Use standard pricing and option pricing for each line item with a special finish, unless additional modifications have been specified. For items available in both Essential and Artisan veneers, apply the Essentials pricing.

### Solid Surface Tops

Tops are 1 3/8" thick constructed of 1/2" thick Solid Surface on top of a 1 1/8" MDF sub top. Sub top has an under cut bevel profile and is painted in a coordinated color to match the Solid Surface.

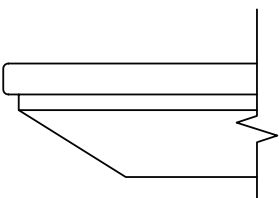

**Reverse Bevel Edge (K7)**  
Solid Surface over painted MDF

#### Standard Solid Surface

<b>ONX</b>	Black Onyx Mirage
<b>DWH</b>	Designer White
<b>HST</b>	Hot Stone
<b>SOG</b>	Soothing Grey

# Conference - Top Shapes

Lok offers 16 conference table top shapes. Tables are available in 29", 36" or 42" high and in laminate, veneer or solid surface. Compatible bases are: X Base, X4 Base, or Y Base.



rectangular

29"h

- 36" x 84" Seats 6
- 36" x 96" Seats 8
- 42" x 84" Seats 6
- 42" x 96" Seats 8
- 48" x 84" Seats 6
- 48" x 96" Seats 8
- 48" x 108" Seats 8
- 48" x 120" Seats 8
- 48" x 144" Seats 12
- 48" x 168" Seats 14
- 48" x 192" Seats 16
- 48" x 216" Seats 18
- 48" x 240" Seats 20
- 54" x 120" Seats 8
- 54" x 144" Seats 12
- 54" x 168" Seats 14
- 54" x 192" Seats 16
- 54" x 216" Seats 18
- 54" x 240" Seats 20
- 60" x 120" Seats 8
- 60" x 144" Seats 12
- 60" x 168" Seats 14
- 60" x 192" Seats 16
- 60" x 216" Seats 18
- 60" x 240" Seats 20

36"h

- 36" x 84" Seats 6
- 36" x 96" Seats 8
- 42" x 84" Seats 6
- 42" x 96" Seats 8
- 48" x 84" Seats 6
- 48" x 96" Seats 8

42"h

- 36" x 84" Seats 6
- 36" x 96" Seats 8
- 42" x 84" Seats 6
- 42" x 96" Seats 8
- 48" x 84" Seats 6
- 48" x 96" Seats 8



rounded rectangular

29"h

- 36" x 84" Seats 6
- 36" x 96" Seats 8
- 42" x 84" Seats 6
- 42" x 96" Seats 8
- 48" x 84" Seats 6
- 48" x 96" Seats 8
- 48" x 108" Seats 8
- 48" x 120" Seats 8
- 48" x 144" Seats 12
- 48" x 168" Seats 14
- 48" x 192" Seats 16
- 48" x 216" Seats 18
- 48" x 240" Seats 20
- 54" x 120" Seats 8
- 54" x 144" Seats 12
- 54" x 168" Seats 14
- 54" x 192" Seats 16
- 54" x 216" Seats 18
- 54" x 240" Seats 20
- 60" x 120" Seats 8
- 60" x 144" Seats 12
- 60" x 168" Seats 14
- 60" x 192" Seats 16
- 60" x 216" Seats 18
- 60" x 240" Seats 20

36"h

- 36" x 84" Seats 6
- 36" x 96" Seats 8
- 42" x 84" Seats 6
- 42" x 96" Seats 8
- 48" x 84" Seats 6
- 48" x 96" Seats 8

42"h

- 36" x 84" Seats 6
- 36" x 96" Seats 8
- 42" x 84" Seats 6
- 42" x 96" Seats 8
- 48" x 84" Seats 6
- 48" x 96" Seats 8



arc rectangular

29"h

- 36" x 84" Seats 6
- 36" x 96" Seats 8
- 42" x 84" Seats 6
- 42" x 96" Seats 8
- 48" x 84" Seats 6
- 48" x 96" Seats 8
- 48" x 108" Seats 8
- 48" x 120" Seats 8
- 48" x 144" Seats 12
- 48" x 168" Seats 14
- 48" x 192" Seats 16
- 48" x 216" Seats 18
- 48" x 240" Seats 20
- 54" x 120" Seats 8
- 54" x 144" Seats 12
- 54" x 168" Seats 14
- 54" x 192" Seats 16
- 54" x 216" Seats 18
- 54" x 240" Seats 20
- 60" x 120" Seats 8
- 60" x 144" Seats 12
- 60" x 168" Seats 14
- 60" x 192" Seats 16
- 60" x 216" Seats 18
- 60" x 240" Seats 20

36"h

- 36" x 84" Seats 6
- 36" x 96" Seats 8
- 42" x 84" Seats 6
- 42" x 96" Seats 8
- 48" x 84" Seats 6
- 48" x 96" Seats 8

42"h

- 36" x 84" Seats 6
- 36" x 96" Seats 8
- 42" x 84" Seats 6
- 42" x 96" Seats 8
- 48" x 84" Seats 6
- 48" x 96" Seats 8



rounded arc rectangular

29"h

- 36" x 84" Seats 6
- 36" x 96" Seats 8
- 42" x 84" Seats 6
- 42" x 96" Seats 8
- 48" x 84" Seats 6
- 48" x 96" Seats 8
- 48" x 108" Seats 8
- 48" x 120" Seats 8
- 48" x 144" Seats 12
- 48" x 168" Seats 14
- 48" x 192" Seats 16
- 48" x 216" Seats 18
- 48" x 240" Seats 20
- 54" x 120" Seats 8
- 54" x 144" Seats 12
- 54" x 168" Seats 14
- 54" x 192" Seats 16
- 54" x 216" Seats 18
- 54" x 240" Seats 20
- 60" x 120" Seats 8
- 60" x 144" Seats 12
- 60" x 168" Seats 14
- 60" x 192" Seats 16
- 60" x 216" Seats 18
- 60" x 240" Seats 20

36"h

- 36" x 84" Seats 6
- 36" x 96" Seats 8
- 42" x 84" Seats 6
- 42" x 96" Seats 8
- 48" x 84" Seats 6
- 48" x 96" Seats 8

42"h

- 36" x 84" Seats 6
- 36" x 96" Seats 8
- 42" x 84" Seats 6
- 42" x 96" Seats 8
- 48" x 84" Seats 6
- 48" x 96" Seats 8



racetrack

29"h

- 36" x 84" Seats 6
- 36" x 96" Seats 8
- 42" x 84" Seats 6
- 42" x 96" Seats 8
- 48" x 84" Seats 6
- 48" x 96" Seats 8
- 48" x 108" Seats 8
- 48" x 120" Seats 8
- 48" x 144" Seats 12
- 48" x 168" Seats 14
- 48" x 192" Seats 16
- 48" x 216" Seats 18
- 48" x 240" Seats 20
- 54" x 120" Seats 8
- 54" x 144" Seats 12
- 54" x 168" Seats 14
- 54" x 192" Seats 16
- 54" x 216" Seats 18
- 54" x 240" Seats 20
- 60" x 120" Seats 8
- 60" x 144" Seats 12
- 60" x 168" Seats 14
- 60" x 192" Seats 16
- 60" x 216" Seats 18
- 60" x 240" Seats 20

36"h

- 36" x 84" Seats 6
- 36" x 96" Seats 8
- 42" x 84" Seats 6
- 42" x 96" Seats 8
- 48" x 84" Seats 6
- 48" x 96" Seats 8

42"h

- 36" x 84" Seats 6
- 36" x 96" Seats 8
- 42" x 84" Seats 6
- 42" x 96" Seats 8
- 48" x 84" Seats 6
- 48" x 96" Seats 8



oval

29"h

- 42" x 84" Seats 6
- 48" x 96" Seats 8
- 54" x 108" Seats 8
- 60" x 120" Seats 10

36"h

- 42" x 84" Seats 6
- 48" x 96" Seats 8

42"h

- 42" x 84" Seats 6
- 48" x 96" Seats 8

## Conference - Top Shapes

Lok offers 15 conference table top shapes. Tables are available in 29", 36" or 42" high and in laminate, veneer or solid surface. Compatible bases are: X Base, X4 Base, or Y Base.

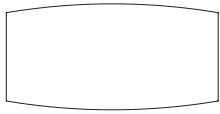

boat

29"h

- 36" x 84" Seats 6
- 36" x 96" Seats 8
- 42" x 84" Seats 6
- 42" x 96" Seats 8
- 48" x 84" Seats 6
- 48" x 96" Seats 8
- 48" x 108" Seats 8
- 48" x 120" Seats 8
- 48" x 144" Seats 12
- 48" x 168" Seats 14
- 48" x 192" Seats 16
- 48" x 216" Seats 18
- 48" x 240" Seats 20
- 54" x 120" Seats 8
- 54" x 144" Seats 12
- 54" x 168" Seats 14
- 54" x 192" Seats 16
- 54" x 216" Seats 18
- 54" x 240" Seats 20
- 60" x 120" Seats 8
- 60" x 144" Seats 12
- 60" x 168" Seats 14
- 60" x 192" Seats 16
- 60" x 216" Seats 18
- 60" x 240" Seats 20

36"h

- 36" x 84" Seats 6
- 36" x 96" Seats 8
- 42" x 84" Seats 6
- 42" x 96" Seats 8
- 48" x 84" Seats 6
- 48" x 96" Seats 8

42"h

- 36" x 84" Seats 6
- 36" x 96" Seats 8
- 42" x 84" Seats 6
- 42" x 96" Seats 8
- 48" x 84" Seats 6
- 48" x 96" Seats 8

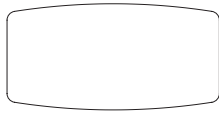

rounded boat

29"h

- 36" x 84" Seats 6
- 36" x 96" Seats 8
- 42" x 84" Seats 6
- 42" x 96" Seats 8
- 48" x 84" Seats 6
- 48" x 96" Seats 8
- 48" x 108" Seats 8
- 48" x 120" Seats 8
- 48" x 144" Seats 12
- 48" x 168" Seats 14
- 48" x 192" Seats 16
- 48" x 216" Seats 18
- 48" x 240" Seats 20
- 54" x 120" Seats 8
- 54" x 144" Seats 12
- 54" x 168" Seats 14
- 54" x 192" Seats 16
- 54" x 216" Seats 18
- 54" x 240" Seats 20
- 60" x 120" Seats 8
- 60" x 144" Seats 12
- 60" x 168" Seats 14
- 60" x 192" Seats 16
- 60" x 216" Seats 18
- 60" x 240" Seats 20

36"h

- 36" x 84" Seats 6
- 36" x 96" Seats 8
- 42" x 84" Seats 6
- 42" x 96" Seats 8
- 48" x 84" Seats 6
- 48" x 96" Seats 8

42"h

- 36" x 84" Seats 6
- 36" x 96" Seats 8
- 42" x 84" Seats 6
- 42" x 96" Seats 8
- 48" x 84" Seats 6
- 48" x 96" Seats 8

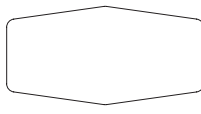

rounded double chevron

29"h

- 36" x 84" Seats 6
- 36" x 96" Seats 8
- 42" x 84" Seats 6
- 42" x 96" Seats 8
- 48" x 84" Seats 6
- 48" x 96" Seats 8

36"h

- 36" x 84" Seats 6
- 36" x 96" Seats 8
- 42" x 84" Seats 6
- 42" x 96" Seats 8
- 48" x 84" Seats 6
- 48" x 96" Seats 8

42"h

- 36" x 84" Seats 6
- 36" x 96" Seats 8
- 42" x 84" Seats 6
- 42" x 96" Seats 8
- 48" x 84" Seats 6
- 48" x 96" Seats 8

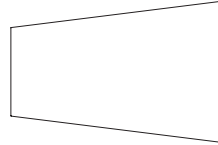

taper

29"h

- 54" x 96" Seats 8
- 60" x 120" Seats 10

36"h

- 54" x 96" Seats 8

42"h

- 54" x 96" Seats 8

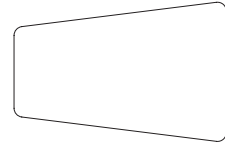

rounded taper

29"h

- 54" x 96" Seats 8
- 60" x 120" Seats 10

36"h

- 54" x 96" Seats 8

42"h

- 54" x 96" Seats 8

# Lok - Top Shapes

Lok offers 15 conference table top shapes. Tables are available in 29", 36" or 42" high and in laminate, veneer or solid surface. Compatible bases are: X Base, X4 Base, or Y Base.

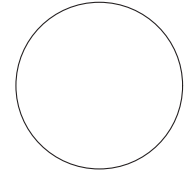

round  
29"h

30"	Seats 3
36"	Seats 4
42"	Seats 4
48"	Seats 4
54"	Seats 6
60"	Seats 8

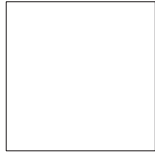

square  
29"h

30" x 30"	Seats 4
36" x 36"	Seats 4
42" x 42"	Seats 4
48" x 48"	Seats 4
54" x 54"	Seats 6
60" x 60"	Seats 8

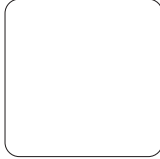

rounded square  
29"h

30" x 30"	Seats 4
36" x 36"	Seats 4
42" x 42"	Seats 4
48" x 48"	Seats 4
54" x 54"	Seats 6
60" x 60"	Seats 8

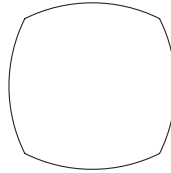

squircle  
29"h

30" x 30"	Seats 4
36" x 36"	Seats 4
42" x 42"	Seats 4
48" x 48"	Seats 4
54" x 54"	Seats 6
60" x 60"	Seats 8

36"h

30"	Seats 3
36"	Seats 4
42"	Seats 4
48"	Seats 4
54"	Seats 6
60"	Seats 8

36"h

30" x 30"	Seats 4
36" x 36"	Seats 4
42" x 42"	Seats 4
48" x 48"	Seats 4
54" x 54"	Seats 6
60" x 60"	Seats 8

36"h

30" x 30"	Seats 4
36" x 36"	Seats 4
42" x 42"	Seats 4
48" x 48"	Seats 4
54" x 54"	Seats 6
60" x 60"	Seats 8

36"h

30" x 30"	Seats 4
36" x 36"	Seats 4
42" x 42"	Seats 4
48" x 48"	Seats 4
54" x 54"	Seats 6
60" x 60"	Seats 8

42"h

30"	Seats 3
36"	Seats 4
42"	Seats 4
48"	Seats 4
54"	Seats 6
60"	Seats 8

42"h

30" x 30"	Seats 4
36" x 36"	Seats 4
42" x 42"	Seats 4
48" x 48"	Seats 4
54" x 54"	Seats 6
60" x 60"	Seats 8

42"h

30" x 30"	Seats 4
36" x 36"	Seats 4
42" x 42"	Seats 4
48" x 48"	Seats 4
54" x 54"	Seats 6
60" x 60"	Seats 8

42"h

30" x 30"	Seats 4
36" x 36"	Seats 4
42" x 42"	Seats 4
48" x 48"	Seats 4
54" x 54"	Seats 6
60" x 60"	Seats 8

## Conference - Base Styles

Lok provides a choice selection of bases in both function and aesthetics to serve a variety of needs. The conferencing offering includes: X-Base, Y Base and X4 base.

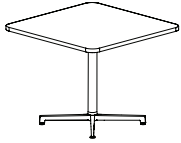

### X-Base

- available 29"h, 36"h or 42"h only in glides.
- compatible with the following top shapes: round, square or squircle
- base finish - select single metal finish or two-tone metal finish. See options listed below.
- power access version, with integrated wire management available with an upcharge

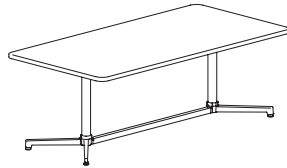

### Y Base

- available in 29"h, 36"h or 42"h only in glides.
- compatible with the following top shapes: arc rectangular, boat, double chevron, oval, racetrack, rectangular, round, square and taper
- base finish - select single metal finish or two-tone metal finish. See options listed below.

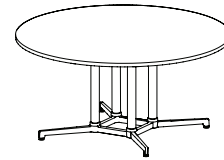

### X4 Base

- available in 29"h, 36"h or 42"h only in glides
- compatible with the following top shapes: round, square, and squircle
- base finish - select single metal finish or two-tone metal finish. See options listed below.

### Single Metal Finish

- ABZ** Aged Bronze Feet & Post
- ASL** Arctic Silver Feet & Post
- GLD** Gold Feet & Post
- PEW** Pewter Feet & Post
- MBK** Matte Black Feet & Post
- SBZ** Soft Bronze Feet & Post
- SNK** Soft Nickel Feet & Post

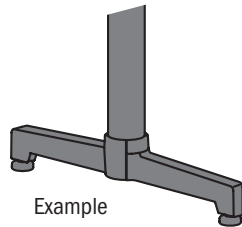

### Two - Tone Metal Finish

Two - Tone Aesthetics can be achieved by specifying Polished Aluminum on the foot and a contrasting finish on the post

#### Polished Aluminum Feet

- ABZ** Aged Bronze Post
- ASL** Arctic Silver Post
- GLD** Gold Post
- PEW** Pewter Post
- MBK** Matte Black Post
- SBZ** Soft Bronze Post
- SNK** Soft Nickel Post

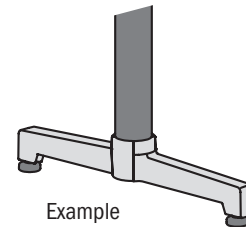

### Power/Charging Options

Lok offers the ability to place power and charging options in the center of select tables. Select your choice of EC23 or EC24, available in black and white.



#### Moire - EC23

- Three 110 outlets
- Dual USB port with 72" power cord
- Black (B) or White (W)

select CTEC23 for cutout in worksurfaces



#### Node - EC24

- One 110 outlet
- Dual USB port with 72" power cord
- Black (B) or White (W)

select CTEC24 for cutout in worksurfaces

Cut outs are located in the center of each table. See below for representation or location.

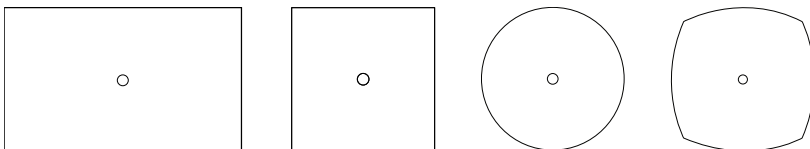

## Lok Product Information

### Electrical Overview

Lok provides several packages to choose from for your electrical needs. Choose solutions for top surface power, underneath outlets, wireless charging, or a combination.

Specifying an electrical package eliminates your need to calculate additional components, as all units and necessary jumpers will ship with your table. You will only need to determine which power in-feed best suits your needs and order separately.

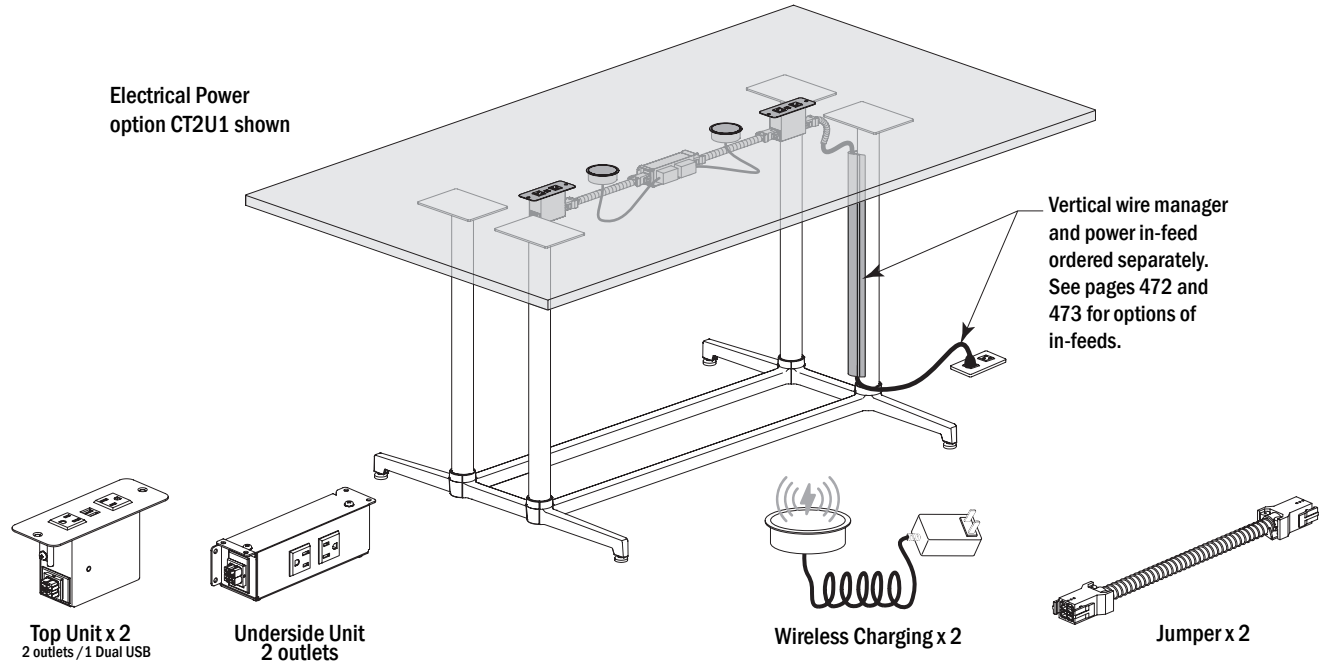

### Electrical - 1 Piece Tops

Power and Charging Packages are measured and located out from the center of the table. Shown on rectangular tops, these dimensions are the same from center regardless of table shape (ie chevron, boat, etc.). Power in-feed is specified separately to support building electrical connection.

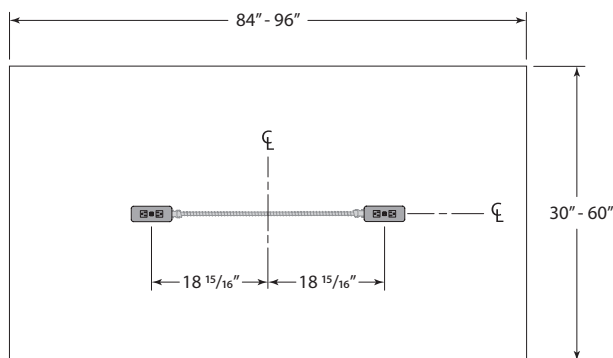
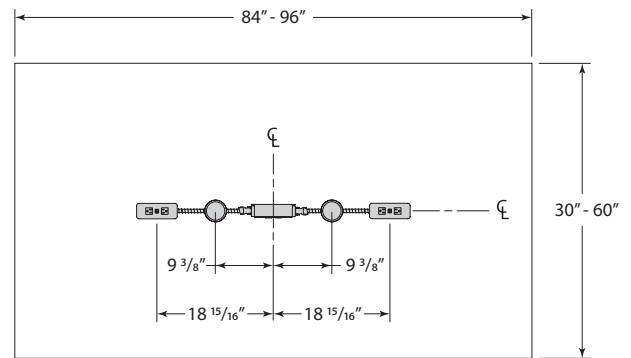
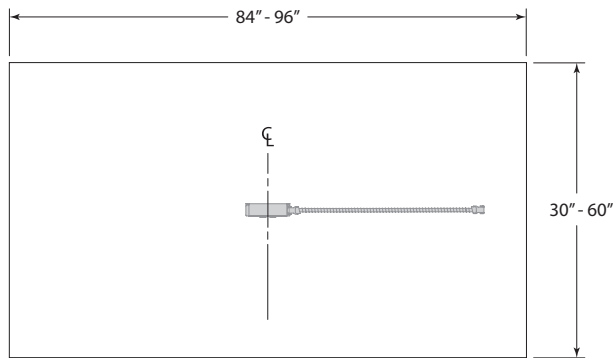

## Conference - Electrical

### Electrical - 2 Piece Tops

Power and Charging Packages are measured and located out from the center of the table. Shown on rectangular tops, these dimensions are the same from center regardless of table shape (ie chevron, boat, etc.). Power in-feed is specified separately to support building electrical connection.

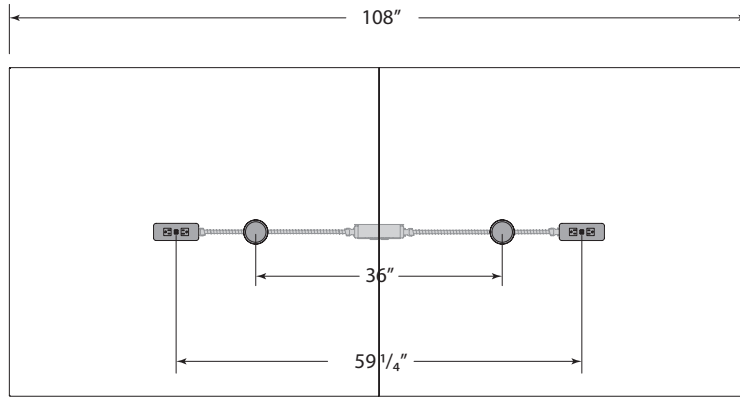

**CT2 - Dual Power Top with Underside and Two Wireless Charging**

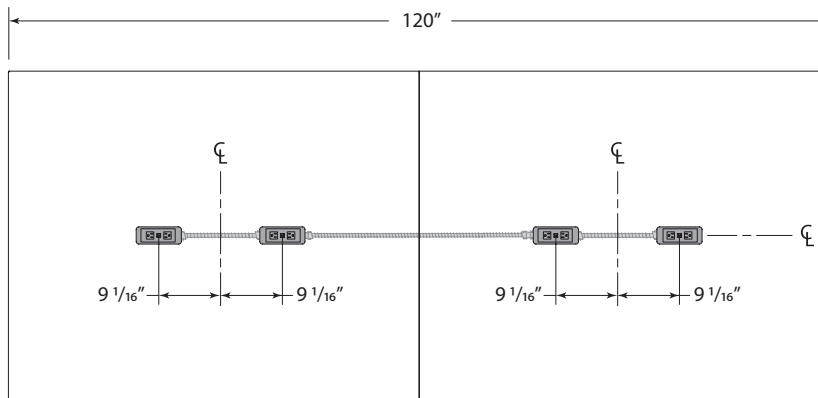

**CT4 - Four Power Top**

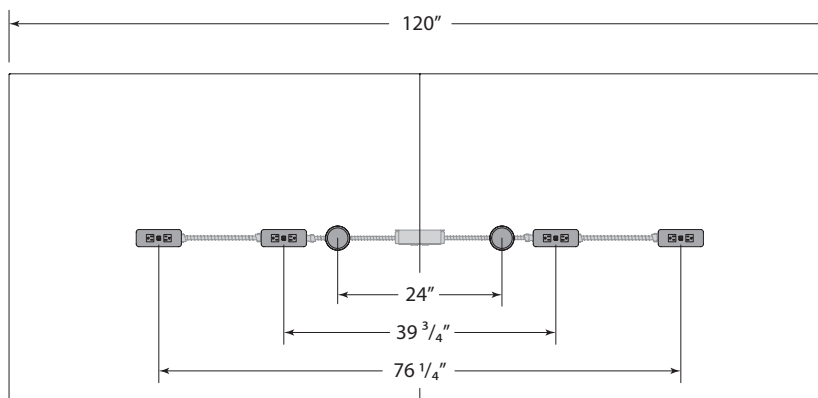

**CT4 - Four Power Top with Underside and Two Wireless Charging**

## Conference - Electrical

### Electrical - 3 Piece Tops

Power and Charging Packages are measured and located out from the center of the table. Shown on rectangular tops, these dimensions are the same from center regardless of table shape (ie chevron, boat, etc.). Power in-feed is specified separately to support building electrical connection.

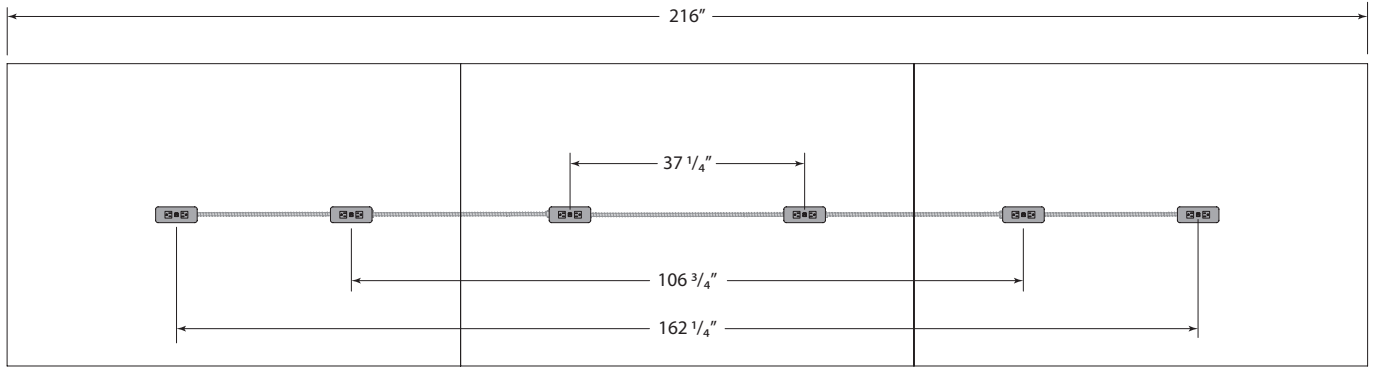

CT6 - Six Power Top

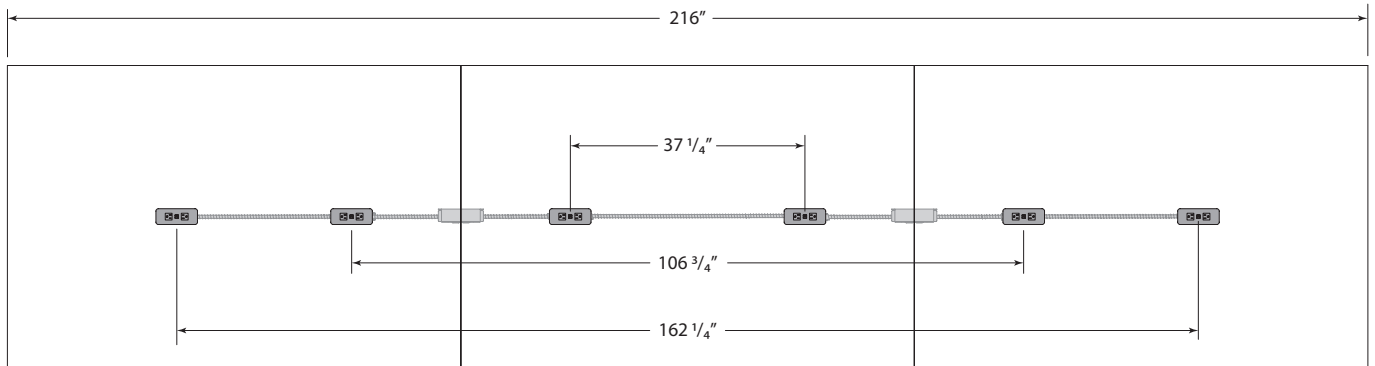

CT6 - Six Power Top

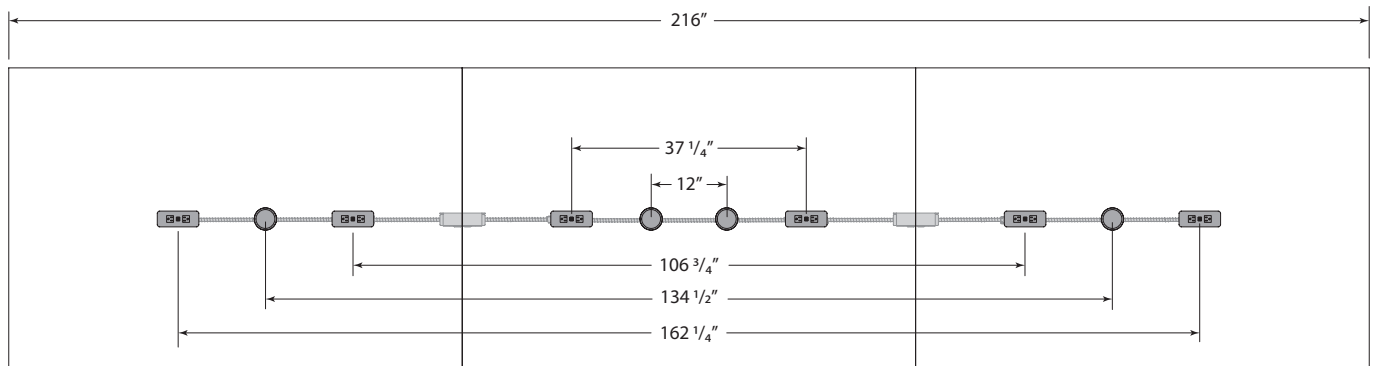

CT6 - Six Power Top with Dual Underside and Four Wireless Charging

LOK - CONFERENCE

Description

Rectangular 3pc Table with T Base at Working Height

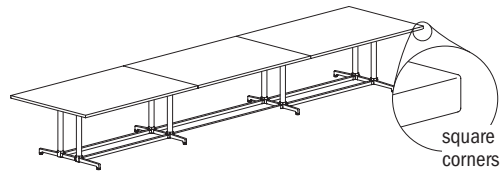

Laminate Tables "LKT" Models

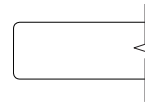

Eased Edge (R3)

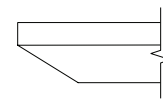

Reverse Bevel Edge (K9)

LAMINATE	D	W	H	CTN WT	CU FT	Model	Standard Tier 1	Graded In Tier 2	Standard Tier 1	Graded In Tier 2
		60	240	29	653	281	LKT60240-29TTT	\$12,049	\$12,247	\$12,887
	60	216	29	598	253	LKT60216-29TTT	\$10,110	\$10,285	\$10,908	\$11,084
	54	240	29	603	254	LKT54240-29TTT	\$9,695	\$9,872	\$10,488	\$10,666
	54	216	29	453	229	LKT54216-29TTT	\$9,123	\$9,283	\$9,885	\$10,043
	48	240	29	551	228	LKT48240-29TTT	\$9,245	\$9,403	\$9,997	\$10,154
	48	216	29	553	206	LKT48216-29TTT	\$8,709	\$8,851	\$9,433	\$9,575

Features:

- price reflects complete table - top and base
- ships KD in multiple cartons
- three piece top
- model includes adjustable glide

Options:

- specify power/charging option, see below for options and upcharges



top shape

LOK - CONFERENCE

To Order Specify

1 Laminate Model #	2 Edge Detail	3 Laminate Selection	4 PVC Edge Color	5 Electrical	6 Metal Color
Laminate (LKT)	<a href="#">See Edge Detail Options</a>	<a href="#">See Laminate Selection</a>	<a href="#">See PVC Edge Color Options</a>	N None CT6 Six Power Center Top CU2 Dual Power Underside CT6U2 Six Power Center Top with Underside (See chart on next page)	<a href="#">See Metal Finish Color Options</a>

Model Number Breakdown

LKT60240-29TTT					
LK	T	60240	29	TT	T
LOK	Laminate	60" x 240"	Height	Rectangular Top Shape	T base

Description

Rectangular 3pc Table with T Base at Working Height (continued)

Veneer Tables "LKV" Models

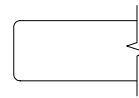

Eased Edge (R3)

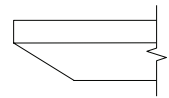

Reverse Bevel Edge (K9)

VENEER	D	W	H	CTN WT	CU FT	Model	Essentials	Artisan	Essentials	Artisan
		60	240	29	653	281	LKV60240-29TTT	\$18,756	\$20,255	\$20,441
	60	216	29	598	253	LKV60216-29TTT	\$16,497	\$17,815	\$17,982	\$19,151
	54	240	29	603	254	LKV54240-29TTT	\$15,866	\$17,179	\$16,631	\$17,877
	54	216	29	603	254	LKV54216-29TTT	\$14,732	\$15,895	\$15,435	\$16,540
	48	240	29	324	130	LKV48240-29TTT	\$13,697	\$14,853	\$14,388	\$15,481
	48	216	29	551	228	LKV48216-29TTT	\$13,850	\$14,872	\$14,486	\$15,453

Electrical Options and Upcharges

	216 - 240 wide
<b>CT6</b>	
Six Power Center Top - Black	CT6BL - add \$4,949
Six Power Center Top - White	CT6WH - add \$4,949
<b>CU2</b>	
Dual Power Underside - Black	CU2-1C - add \$1,298
Dual Power Underside with 4 Wireless Charging - Black	CU2-1CW - add \$3,278
<b>CT6U2</b>	
Six Power Center Top - Black with Dual Underside	CT6U2-BL - add \$5,748
Six Power Center Top - White with Dual Underside	CT6U2-WH - add \$5,748
Six Power Center Top- Black Dual Underside with 4 Wireless Charging	CT6U2-BLW2 - add \$7,668
Six Power Center Top- White Dual Underside with 4 Wireless Charging	CT6U2-WHW2 - add \$7,668

Note: Order power infeed that best fits application

To Order Specify

1 Veneer Model #	2 Edge Detail	3 Wood Collection	4 Wood Finish	5 Electrical	6 Metal Color
Veneer (LKV)	<a href="#">See Edge Detail Options</a>	Essentials	<a href="#">See Essentials Wood Finish Options</a>	N None CT6 Six Power Center Top CU2 Dual Power Underside CT6U2 Six Power Center Top with Underside (See chart above)	<a href="#">See Metal Finish Color Options</a>
		Artisan	<b>4 Wood Finish</b> <a href="#">See Artisan Wood Finish Options</a>		

LOK- CONFERENCE

Description

Rectangular 2pc Table with T Base at Working Height

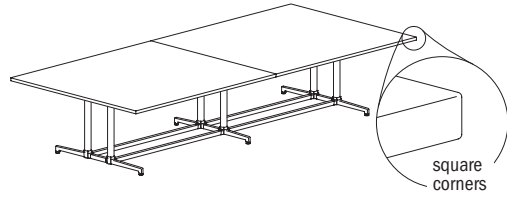

Laminate Tables "LKT" Models

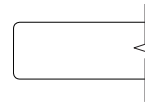

Eased Edge (R3)

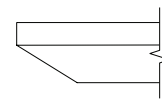

Reverse Bevel Edge (K9)

D	W	H	CTN WT	CU FT	Model	Eased Edge (R3)		Reverse Bevel Edge (K9)	
						Standard Tier 1	Graded In Tier 2	Standard Tier 1	Graded In Tier 2
60	192	29	513	226	LKT60192-29TTT	\$8,533	\$8,692	\$9,292	\$9,451
60	168	29	460	198	LKT60168-29TTT	\$7,978	\$8,117	\$8,700	\$8,839
60	144	29	405	169	LKT60144-29TTT	\$7,378	\$7,495	\$8,065	\$8,182
60	120	29	350	143	LKT60120-29TTT	\$6,413	\$6,509	\$7,061	\$7,163
LAMINATE									
54	192	29	472	204	LKT54192-29TTT	\$7,984	\$8,125	\$8,712	\$8,853
54	168	29	389	178	LKT54168-29TTT	\$7,234	\$7,356	\$7,930	\$8,054
54	144	29	375	154	LKT54144-29TTT	\$6,666	\$6,773	\$7,331	\$7,438
54	120	29	324	130	LKT54120-29TTT	\$6,032	\$6,122	\$6,662	\$6,751
48	192	29	432	183	LKT48192-29TTT	\$6,961	\$7,089	\$7,657	\$7,784
48	168	29	389	161	LKT48168-29TTT	\$6,476	\$6,588	\$7,141	\$7,254
48	144	29	344	139	LKT48144-29TTT	\$5,941	\$6,037	\$6,583	\$6,677
48	120	29	298	116	LKT48120-29TTT	\$5,342	\$5,422	\$5,954	\$6,032
48	108	29	275	105	LKT48108-29TTT	\$4,514	\$4,586	\$5,112	\$5,184

Features:

- price reflects complete table - top and base
- ships KD in multiple cartons
- two piece top
- model includes adjustable glide

· specify power/charging option, see below for options and upcharges

LOK - CONFERENCE



top shape

To Order Specify

1 Laminate Model #	2 Edge Detail	3 Laminate Selection	3a PVC Edge Color	4 Electrical	5 Metal Color
Laminate (LKT)	<a href="#">See Edge Detail Options</a>	<a href="#">See Laminate Selection</a>	<a href="#">See PVC Edge Color Options</a>	N None CT2 Dual Power Center Top CU2 Dual Power Underside CT2U1 Dual Power Center Top with Underside CT4U2 Four Power Center Top with Underside CT4 Four Power Center Top (See chart on next page)	<a href="#">See Metal Finish Color Options</a>

Model Number Breakdown

LKT60192-29TTT					
LK	T	60192	29	TT	T
LOK	Laminate	60" x 192"	Height	Rectangular Top Shape	T base

Description

Rectangular 2pc Table with T Base at Working Height (continued)

Veneer Tables "LKV" Models

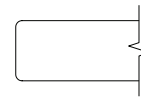

Eased Edge (R3)

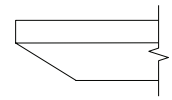

Reverse Bevel Edge (K9)

D	W	H	CTN WT	CU FT	Model	Eased Edge (R3)		Reverse Bevel Edge (K9)	
						Essentials	Artisan	Essentials	Artisan
60	192	29	513	226	LKV60192-29TTT	\$13,064	\$14,110	\$14,241	\$15,167
60	168	29	460	198	LKV60168-29TTT	\$12,028	\$12,990	\$13,108	\$13,959
60	144	29	460	198	LKV60144-29TTT	\$10,953	\$11,829	\$11,941	\$12,715
60	120	29	405	169	LKV60120-29TTT	\$9,670	\$10,444	\$10,540	\$11,226
54	192	29	453	204	LKV54192-29TTT	\$11,954	\$12,910	\$13,028	\$13,876
54	168	29	472	204	LKV54168-29TTT	\$12,230	\$13,207	\$13,328	\$14,196
54	144	29	389	178	LKV54144-29TTT	\$9,941	\$10,733	\$10,835	\$11,536
54	120	29	375	154	LKV54120-29TTT	\$8,878	\$9,588	\$9,677	\$10,304
48	192	29	553	206	LKV48192-29TTT	\$11,990	\$12,890	\$12,577	\$13,422
48	168	29	432	183	LKV48168-29TTT	\$9,846	\$10,622	\$10,380	\$11,108
48	144	29	389	161	LKV48144-29TTT	\$8,921	\$9,575	\$9,407	\$10,020
48	120	29	344	139	LKV48120-29TTT	\$7,935	\$8,470	\$8,369	\$8,870
48	108	29	298	116	LKV48108-29TTT	\$6,505	\$7,020	\$7,089	\$7,548

Electrical Options and Upcharges

CT2	108 wide	120 - 192 wide
Dual Power Center Top - Black	CT2BL - add \$1,837	n/a
Dual Power Center Top - White	CT2WH - add \$1,837	n/a
CU1		
Single Power Underside - Black	CU1-1C - add \$731	CU1-1C - add \$849
Single Power Underside with Wireless Charging - Black	CU1-1CW - add \$1,691	CU1-1CW - add \$1,776
CT2U1		
Dual Power Center Top - Black with Underside	CT2U1-BL - add \$2,235	n/a
Dual Power Center Top - White with Underside	CT2U1-WH - add \$2,235	n/a
Dual Power Center Top - Black with Wireless Charging	CT2U1-BLW2 - add \$3,194	n/a
Dual Power Center Top - White with Wireless Charging	CT2U1-WHW2 - add \$3,194	n/a

CT4U1	108 wide	120 - 192 wide
Four Power Center Top with Single Underside - Black	n/a	CT4U1-BL - add \$3,906
Four Power Center Top with Single Underside - White	n/a	CT4U1-WH - add \$3,906
Four Power Center Top - Black with Underside & Wireless Charging	n/a	CT4U1-BLW2 - add \$4,840
Four Power Center Top - White with Underside & Wireless Charging	n/a	CT4U1-WHW2 - add \$4,840
CT4		
Four Power Center Top - Black	n/a	CT4BL - add \$3,421
Four Power Center Top - White	n/a	CT4WH - add \$3,421

Note: Order power infeed that best fits application

To Order Specify

1 Veneer Model #	2 Edge Detail	3 Wood Collection	4 Wood Finish	5 Electrical	6 Metal Color
Veneer (LKV)	<a href="#">See Edge Detail Options</a>	Essentials	<a href="#">See Essentials Wood Finish Options</a>	N None CT2 Dual Power Center Top CU2 Dual Power Underside CT2U1 Dual Power Center Top with Underside CT4U2 Four Power Center Top with Underside CT4 Four Power Center Top	<a href="#">See Metal Finish Color Options</a>
		Artisan	4 Wood Finish <a href="#">See Artisan Wood Finish Options</a>		

LOK- CONFERENCE

Description

Rectangular Table with T Base at Working Height

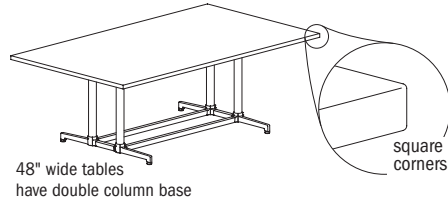

48" wide tables have double column base

LAMINATE

D	W	H	CTN WT	CU FT	Model
48	96	29	204	105	LKT4896-29TTT
48	84	29	204	83	LKT4884-29TTT
42	96	29	183	73	LKT4296-29TTT
42	84	29	164	72	LKT4284-29TTT
36	96	29	162	72	LKT3696-29TTT
36	84	29	151	64	LKT3684-29TTT

Laminate Tables "LKT" Models

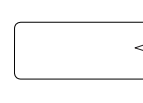

Eased Edge (R3)

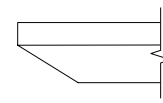

Reverse Bevel Edge (K9)

Eased Edge (R3)		Reverse Bevel Edge (K9)	
Standard Tier 1	Graded In Tier 2	Standard Tier 1	Graded In Tier 2
\$3,784	\$3,848	\$4,366	\$4,429
\$3,370	\$3,424	\$3,936	\$3,992
\$3,446	\$3,503	\$4,013	\$4,069
\$2,834	\$2,884	\$3,388	\$3,436
\$2,893	\$2,942	\$3,444	\$3,493
\$2,594	\$2,636	\$3,133	\$3,177

Features:

- price reflects complete table - top and base
- ships KD in multiple cartons
- one piece top
- model includes adjustable glide

Options:

- specify power/charging option, see below for options and upcharges

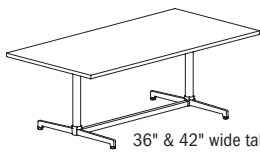

36" & 42" wide tables have single column base



top shape

LOK - CONFERENCE

To Order Specify

1 Laminite Model #	2 Edge Detail	3 Laminite Selection	3a PVC Edge Color	4 Electrical	5 Metal Color
Laminite (LKT)	<a href="#">See Edge Detail Options</a>	<a href="#">See Laminite Selection</a>	<a href="#">See PVC Edge Color Options</a>	N None CT2 Dual Power Center Top CU2 Dual Power Underside CT2U1 Dual Power Center Top with Underside (See chart on next page)	<a href="#">See Metal Finish Color Options</a>

Model Number Breakdown

LKT4896-29TTT					
LK	T	4896	29	TT	T
LOK	Laminite	48" x 96"	Height	Rectangular Top Shape	T base

Description

Rectangular Table with T Base  
at Working Height  
(continued)

Veneer Tables  
"LKV" Models

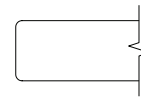

Eased Edge (R3)

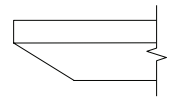

Reverse Bevel Edge (K9)

VENEER	D	W	H	CTN WT	CU FT	1 Model	Essentials	Artisan	Essentials	Artisan
		48	96	29	275	105	LKV4896-29TTT	\$5,297	\$5,716	\$5,678
	48	84	29	204	94	LKV4884-29TTT	\$4,817	\$5,178	\$5,172	\$5,506
	42	96	29	183	83	LKV4296-29TTT	\$5,779	\$6,244	\$6,299	\$6,707
	42	84	29	164	73	LKV4284-29TTT	\$4,399	\$4,749	\$4,794	\$5,105
	36	96	29	162	72	LKV3696-29TTT	\$3,912	\$4,222	\$4,262	\$4,537
	36	84	29	145	72	LKV3684-29TTT	\$3,667	\$3,960	\$3,999	\$4,258

Electrical Options and Upcharges

CT2	84 - 96 wide
Dual Power Center Top - Black	CT2BL - add \$1,837
Dual Power Center Top - White	CT2WH - add \$1,837
CU1	
Single Power Underside - Black	CU1-1C - add \$731
Single Power Underside with Wireless Charging - Black	CU1-1CW - add \$1,691
CT2U1	
Dual Power Center Top - Black with Single Underside	CT2U1-BL - add \$2,235
Dual Power Center Top - White with Single Underside	CT2U1-WH - add \$2,235
Dual Power Center Top - Black with Wireless Charging	CT2U1-BLW2 - add \$3,194
Dual Power Center Top - White with Wireless Charging	CT2U1-WHW2 - add \$3,194

Note: Order power infed that best fits application

To Order Specify

1 Veneer Model #	2 Edge Detail	3 Wood Collection	4 Wood Finish	5 Electrical	6 Metal Color
Veneer (LKV)	<a href="#">See Edge Detail Options</a>	Essentials	<a href="#">See Essentials Wood Finish Options</a>	N None CT2 Dual Power Center Top CU2 Dual Power Underside CT2U1 Dual Power Center Top with Underside (See chart above)	<a href="#">See Metal Finish Color Options</a>
		Artisan	4 Wood Finish <a href="#">See Artisan Wood Finish Options</a>		

Description

Rounded Rectangular 3pc Table with T Base at Working Height

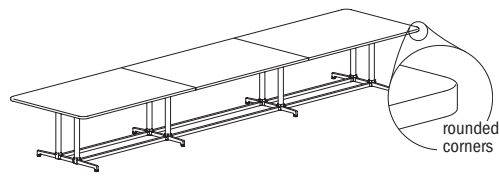

Laminate Tables "LKT" Models

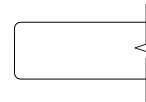

Eased Edge (R3)

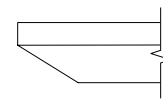

Reverse Bevel Edge (K9)

LAMINATE	D	W	H	CTN WT	CU FT	Model	Standard Tier 1	Graded In Tier 2	Standard Tier 1	Graded In Tier 2
		60	240	29	653	281	LKT60240-29TTRT	\$12,271	\$12,471	\$13,108
	60	216	29	598	253	LKT60216-29TTRT	\$10,460	\$10,636	\$11,260	\$11,438
	54	240	29	603	254	LKT54240-29TTRT	\$9,900	\$10,074	\$10,693	\$10,870
	54	216	29	453	229	LKT54216-29TTRT	\$9,309	\$9,470	\$10,073	\$10,232
	48	240	29	551	228	LKT48240-29TTRT	\$9,429	\$9,588	\$10,183	\$10,339
	48	216	29	553	206	LKT48216-29TTRT	\$8,341	\$8,484	\$9,068	\$9,210

Features:

- price reflects complete table - top and base
- ships KD in multiple cartons
- three piece top
- model includes adjustable glide

Options:

- specify power/charging option, see below for options and upcharges



top shape

LOK - CONFERENCE

To Order Specify

1 Laminate Model #	2 Edge Detail	3 Laminate Selection	3a PVC Edge Color	4 Electrical	5 Metal Color
Laminate (LKT)	<a href="#">See Edge Detail Options</a>	<a href="#">See Laminate Selection</a>	<a href="#">See PVC Edge Color Options</a>	N None CT6 Six Power Center Top CU2 Dual Power Underside CT6U2 Six Power Center Top with Underside (See chart on next page)	<a href="#">See Metal Finish Color Options</a>

Model Number Breakdown

LKT60240-29TTRT						
LK	T	60240	29	TT	R	T
LOK	Laminate	60" x 240"	Height	Rectangular Top Shape	Rounded Corner	T base

Description

Rounded Rectangular 3pc Table with T Base at Working Height (continued)

Veneer Tables "LKV" Models

Solid Surface Tables "LKS" Models

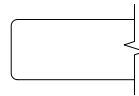

Eased Edge (R3)

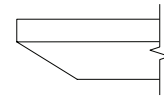

Reverse Bevel Edge (K9)

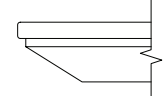

Reverse Bevel Edge (S7)

	D	W	H	CTN WT	CU FT	① Model	Veneer		Solid Surface		
							Essentials	Artisan	Essentials	Artisan	Standard
VENEER	60	240	29	653	281	LKV60240-29TTRT	\$19,086	\$20,613	\$20,803	\$22,155	--
	60	216	29	598	253	LKV60216-29TTRT	\$16,800	\$18,143	\$18,311	\$19,502	--
	54	240	29	603	254	LKV54240-29TTRT	\$16,169	\$17,479	\$16,932	\$18,176	--
	54	216	29	453	229	LKV54216-29TTRT	\$15,005	\$16,169	\$15,705	\$16,809	--
	48	240	29	551	228	LKV48240-29TTRT	\$15,170	\$16,325	\$15,864	\$16,954	--
	48	216	29	553	206	LKV48216-29TTRT	\$13,324	\$14,350	\$13,964	\$14,932	--
SOLID SURFACE	60	240	29	653	281	LKS60240-29TTRT	--	--	--	--	\$42,849
	60	216	29	598	253	LKS60216-29TTRT	--	--	--	--	\$38,729
	54	240	29	603	254	LKS54240-29TTRT	--	--	--	--	\$38,990
	54	216	29	453	229	LKS54216-29TTRT	--	--	--	--	\$35,281
	48	240	29	551	228	LKS48240-29TTRT	--	--	--	--	\$35,212
	48	216	29	553	206	LKS48216-29TTRT	--	--	--	--	\$31,136

Electrical Options and Upcharges

	216 - 240 wide
<b>CT6</b>	
Six Power Center Top - Black	CT6BL - add \$4,949
Six Power Center Top - White	CT6WH - add \$4,949
<b>CU2</b>	
Dual Power Underside - Black	CU2-1C - add \$1,298
Dual Power Underside with 4 Wireless Charging - Black	CU2-1CW - add \$3,278
<b>CT6U2</b>	
Six Power Center Top - Black with Dual Underside	CT6U2-BL - add \$5,748
Six Power Center Top - White with Dual Underside	CT6U2-WH - add \$5,748
Six Power Center Top - Black Dual Underside with 4 Wireless Charging	CT6U2-BLW2 - add \$7,668
Six Power Center Top - White Dual Underside with 4 Wireless Charging	CT6U2-WHW2 - add \$7,668

LOK - CONFERENCE

To Order Specify

Note: Order power infeed that best fits application, see page 408.

① Veneer Model #	② Edge Detail	③ Wood Collection	④ Wood Finish	⑤ Electrical	⑥ Metal Color
Veneer (LKV)	<a href="#">See Edge Detail Options</a>	Essentials	<a href="#">See Essentials Wood Finish Options</a>	N None CT6 Six Power Center Top CU2 Dual Power Underside CT6U2 Six Power Center Top with Underside (See chart above)	<a href="#">See Metal Finish Color Options</a>
		Artisan	④ Wood Finish <a href="#">See Artisan Wood Finish Options</a>		

① Solid Surface Model #	② Top Surface Selection	③ Electrical	④ Metal Color
Solid Surface (LKS)	<a href="#">See Solid Surface Top Surface Selection Options</a>	N None CT6 Six Power Center Top CU2 Dual Power Underside CT6U2 Six Power Center Top with Underside (See chart above)	<a href="#">See Metal Finish Color Options</a>

Description

Rounded Rectangular 2pc Table with T Base at Working Height

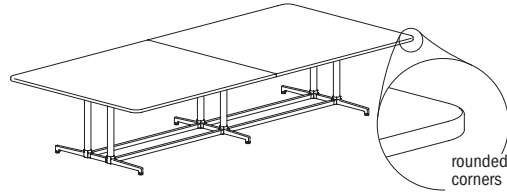

Laminate Tables "LKT" Models

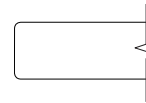

Eased Edge (R3)

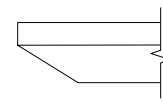

Reverse Bevel Edge (K9)

D	W	H	CTN WT	CU FT	Model	Eased Edge (R3)		Reverse Bevel Edge (K9)	
						Standard Tier 1	Graded In Tier 2	Standard Tier 1	Graded In Tier 2
60	192	29	513	226	LKT60192-29TTRT	\$8,547	\$8,708	\$9,307	\$9,465
60	168	29	460	198	LKT60168-29TTRT	\$7,977	\$8,115	\$8,699	\$8,838
60	144	29	405	169	LKT60144-29TTRT	\$7,360	\$7,478	\$8,048	\$8,165
60	120	29	350	143	LKT60120-29TTRT	\$6,526	\$6,623	\$7,176	\$7,275
54	192	29	472	204	LKT54192-29TTRT	\$8,133	\$8,277	\$8,861	\$9,004
54	168	29	389	178	LKT54168-29TTRT	\$7,367	\$7,493	\$8,065	\$8,187
54	144	29	375	154	LKT54144-29TTRT	\$6,787	\$6,895	\$7,452	\$7,558
54	120	29	324	130	LKT54120-29TTRT	\$6,081	\$6,169	\$6,708	\$6,798
48	192	29	432	183	LKT48192-29TTRT	\$7,097	\$7,224	\$7,793	\$7,918
48	168	29	389	161	LKT48168-29TTRT	\$6,598	\$6,708	\$7,264	\$7,375
48	144	29	344	139	LKT48144-29TTRT	\$6,053	\$6,147	\$6,691	\$6,787
48	120	29	298	116	LKT48120-29TTRT	\$5,439	\$5,518	\$6,051	\$6,130
48	108	29	275	105	LKT48108-29TTRT	\$4,609	\$4,678	\$5,202	\$5,274

LAMINATE

Features:

- price reflects complete table - top and base
- ships KD in multiple cartons
- two piece top
- model includes adjustable glide

Options:

- specify power/charging option, see below for options and upcharges

Electrical Options and Upcharges

	108 wide	120 - 192 wide
<b>CT2</b>		
Dual Power Center Top - Black	CT2BL - add \$1,837	n/a
Dual Power Center Top - White	CT2WH - add \$1,837	n/a
<b>CU1</b>		
Single Power Underside - Black	CU1-1C - add \$731	CU1-1C - add \$849
Single Power Underside with Wireless Charging - Black	CU1-1CW - add \$1,691	CU1-1CW - add \$1,776
<b>CT2U1</b>		
Dual Power Center Top - Black with Underside	CT2U1-BL - add \$2,235	n/a
Dual Power Center Top - White with Underside	CT2U1-WH - add \$2,235	n/a
Dual Power Center Top - Black with Wireless Charging	CT2U1-BLW2 - add \$3,194	n/a
Dual Power Center Top - White with Wireless Charging	CT2U1-WHW2 - add \$3,194	n/a

Note: Order power infeed that best fits application.

	108 wide	120 - 192 wide
<b>CT4U1</b>		
Four Power Center Top with Single Underside - Black	n/a	CT4U1-BL - add \$3,906
Four Power Center Top with Single Underside - White	n/a	CT4U1-WH - add \$3,906
Four Power Center Top - Black with Underside & Wireless Charging	n/a	CT4U1-BLW2 - add \$4,840
Four Power Center Top - White with Underside & Wireless Charging	n/a	CT4U1-WHW2 - add \$4,840
<b>CT4</b>		
Four Power Center Top - Black	n/a	CT4BL - add \$3,421
Four Power Center Top - White	n/a	CT4WH - add \$3,421

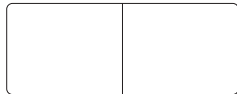

top shape

To Order Specify

1 Laminate Model #	2 Edge Detail	3 Laminate Selection	3a PVC Edge Color	4 Electrical	5 Metal Color
Laminate (LKT)	<a href="#">See Edge Detail Options</a>	<a href="#">See Laminate Selection</a>	<a href="#">See PVC Edge Color Options</a>	N None CT2 Dual Power Center Top CU2 Dual Power Underside CT2U1 Dual Power Center Top with Underside CT4U2 Four Power Center Top with Underside CT4 Four Power Center Top (See chart above)	<a href="#">See Metal Finish Color Options</a>

Model Number Breakdown

LKT60192-29TTRT						
LK	T	60192	29	TT	R	T
LOK	Laminate	60" x 192"	Height	Rectangular Top Shape	Rounded Corner	T base

LOK - CONFERENCE

Description

Rounded Rectangular 2pc Table with T Base at Working Height (continued)

Veneer Tables "LKV" Models

Solid Surface Tables "LKS" Models

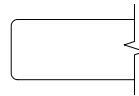

Eased Edge (R3)

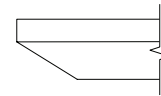

Reverse Bevel Edge (K9)

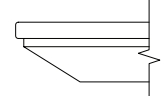

Reverse Bevel Edge (S7)

	D	W	H	CTN WT	CU FT	① Model	Veneer Tables "LKV" Models		Solid Surface Tables "LKS" Models			
							Essentials	Artisan	Essentials	Artisan	Standard	
VENEER	60	192	29	513	226	LKV60192-29TTRT	\$13,301	\$14,366	\$14,497	\$15,439	--	
	60	168	29	460	198	LKV60168-29TTRT	\$12,235	\$13,213	\$13,335	\$14,202	--	
	60	144	29	405	169	LKV60144-29TTRT	\$11,137	\$12,028	\$12,138	\$12,928	--	
	60	120	29	350	143	LKV60120-29TTRT	\$9,827	\$10,613	\$10,712	\$11,405	--	
	54	192	29	472	204	LKV54192-29TTRT	\$12,166	\$13,143	\$13,263	\$14,122	--	
	54	168	29	389	178	LKV54168-29TTRT	\$11,127	\$12,018	\$12,128	\$12,916	--	
	54	144	29	375	154	LKV54144-29TTRT	\$10,106	\$10,914	\$11,017	\$11,730	--	
	54	120	29	324	130	LKV54120-29TTRT	\$8,944	\$9,658	\$9,747	\$10,378	--	
	48	192	29	432	183	LKV48192-29TTRT	\$10,927	\$11,822	\$11,511	\$12,356	--	
	48	168	29	389	161	LKV48168-29TTRT	\$10,017	\$10,790	\$10,549	\$11,281	--	
	48	144	29	344	139	LKV48144-29TTRT	\$9,072	\$9,725	\$9,556	\$10,170	--	
	48	120	29	298	116	LKV48120-29TTRT	\$8,065	\$8,601	\$8,500	\$9,003	--	
	48	108	29	275	105	LKV48108-29TTRT	\$6,622	\$7,152	\$7,217	\$7,685	--	
	SOLID SURFACE	60	192	29	513	226	LKS60192-29TTRT	--	--	--	--	\$32,183
		60	168	29	460	198	LKS60168-29TTRT	--	--	--	--	\$28,438
		60	144	29	405	169	LKS60144-29TTRT	--	--	--	--	\$24,738
60		120	29	350	143	LKS60120-29TTRT	--	--	--	--	\$27,055	
54		192	29	472	204	LKS54192-29TTRT	--	--	--	--	\$29,137	
54		168	29	389	178	LKS54168-29TTRT	--	--	--	--	\$25,867	
54		144	29	375	154	LKS54144-29TTRT	--	--	--	--	\$22,540	
54		120	29	324	130	LKS54120-29TTRT	--	--	--	--	\$19,149	
48		192	29	432	183	LKS48192-29TTRT	--	--	--	--	\$26,347	
48		168	29	389	161	LKS48168-29TTRT	--	--	--	--	\$23,357	
48		144	29	344	139	LKS48144-29TTRT	--	--	--	--	\$20,391	
48		120	29	298	116	LKS48120-29TTRT	--	--	--	--	\$17,434	
48		108	29	275	105	LKS48108-29TTRT	--	--	--	--	\$15,926	

LOK- CONFERENCE

To Order Specify

① Veneer Model #	② Edge Detail	③ Wood Collection	④ Wood Finish	⑤ Electrical	⑥ Metal Color
Veneer (LKV)	<a href="#">See Edge Detail Options</a>	Essentials	<a href="#">See Essentials Wood Finish Options</a>	N None CT2 Dual Power Center Top CU2 Dual Power Underside CT2U1 Dual Power Center Top with Underside CT4U2 Four Power Center Top with Underside CT4 Four Power Center Top (See chart on previous page)	<a href="#">See Metal Finish Color Options</a>
		Artisan	④ Wood Finish <a href="#">See Artisan Wood Finish Options</a>		

① Solid Surface Model #	② Top Surface Selection	③ Electrical	④ Metal Color
Solid Surface (LKS)	<a href="#">See Solid Surface Top Surface Selection Options</a>	N None CT2 Dual Power Center Top CU2 Dual Power Underside CT2U1 Dual Power Center Top with Underside CT4U2 Four Power Center Top with Underside CT4 Four Power Center Top (See chart on previous page)	<a href="#">See Metal Finish Color Options</a>

## Description

Rounded Rectangular Table with T Base at Working Height

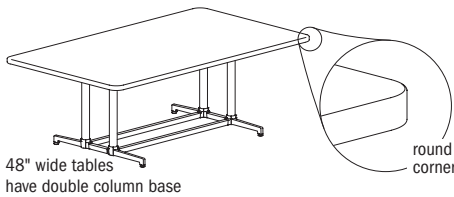

48" wide tables have double column base

LAMINATE

D	W	H	CTN WT	CU FT	Model
48	96	29	204	105	LKT4896-29TTRT
48	84	29	183	83	LKT4884-29TTRT
42	96	29	164	73	LKT4296-29TTRT
42	84	29	162	72	LKT4284-29TTRT
36	96	29	145	72	LKT3696-29TTRT
36	84	29	151	64	LKT3684-29TTRT

## Laminate Tables "LKT" Models

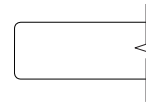

Eased Edge (R3)

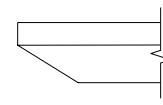

Reverse Bevel Edge (K9)

Standard Tier 1	Graded In Tier 2	Standard Tier 1	Graded In Tier 2
\$3,439	\$3,498	\$4,007	\$4,062
\$3,517	\$3,572	\$4,084	\$4,138
\$2,897	\$2,947	\$3,455	\$3,503
\$2,957	\$3,007	\$3,510	\$3,557
\$2,655	\$2,694	\$3,194	\$3,238

### Features:

- price reflects complete table - top and base
- ships KD in multiple cartons
- one piece top
- model includes adjustable glide

### Options:

- specify power/charging option, see below for options and upcharges

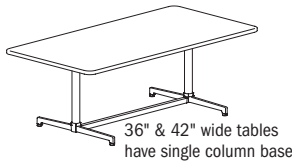

36" & 42" wide tables have single column base



top shape

LOK - CONFERENCE

## To Order Specify

1 Laminate Model #	2 Edge Detail	3 Laminate Selection	3a PVC Edge Color	4 Electrical	5 Metal Color
Laminate (LKT)	<a href="#">See Edge Detail Options</a>	<a href="#">See Laminate Selection</a>	<a href="#">See PVC Edge Color Options</a>	N None CT2 Dual Power Center Top CU2 Dual Power Underside CT2U1 Dual Power Center Top with Underside (See chart on next page)	<a href="#">See Metal Finish Color Options</a>

## Model Number Breakdown

LKT4896-29TTRT						
LK	T	4896	29	TT	R	T
LOK	Laminate	48" x 96"	Height	Rectangular Top Shape	Rounded Corner	T base

Description

Rounded Rectangular Table with T Base at Working Height (continued)

Veneer Tables "LKV" Models      Solid Surface Tables "LKS" Models

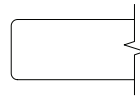

Eased Edge (R3)

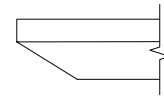

Reverse Bevel Edge (K9)

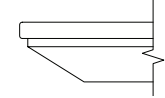

Reverse Bevel Edge (S7)

	D	W	H	CTN WT	CU FT	① Model	Veneer Tables "LKV" Models		Solid Surface Tables "LKS" Models		
							Essentials	Artisan	Essentials	Artisan	Standard
VENEER	48	96	29	204	105	LKV4896-29TTRT	\$5,378	\$5,796	\$5,762	\$6,146	--
	48	84	29	204	83	LKV4884-29TTRT	\$4,922	\$5,281	\$5,276	\$5,610	--
	42	96	29	183	83	LKV4296-29TTRT	\$5,256	\$5,678	\$5,729	\$6,100	--
	42	84	29	164	73	LKV4284-29TTRT	\$4,419	\$4,771	\$4,817	\$5,131	--
	36	96	29	162	72	LKV3696-29TTRT	\$4,001	\$4,320	\$4,359	\$4,644	--
	36	84	29	151	64	LKV3684-29TTRT	\$3,682	\$3,973	\$4,012	\$4,270	--
SOLID SURFACE	48	96	29	204	105	LKS4896-29TTRT	--	--	--	--	\$12,622
	48	84	29	183	83	LKS4884-29TTRT	--	--	--	--	\$11,205
	42	96	29	164	73	LKS4296-29TTRT	--	--	--	--	\$10,285
	42	84	29	162	72	LKS4284-29TTRT	--	--	--	--	\$9,066
	36	96	29	145	72	LKS3696-29TTRT	--	--	--	--	\$9,038
	36	84	29	151	64	LKS3684-29TTRT	--	--	--	--	\$8,146

Electrical Options and Upcharges

CT2	84 - 96 wide
Dual Power Center Top - Black	CT2BL - add \$1,837
Dual Power Center Top - White	CT2WH - add \$1,837
CU1	
Single Power Underside - Black	CU1-1C - add \$731
Single Power Underside with Wireless Charging - Black	CU1-1CW - add \$1,691
CT2U1	
Dual Power Center Top - Black with Single Underside	CT2U1-BL - add \$2,235
Dual Power Center Top - White with Single Underside	CT2U1-WH - add \$2,235
Dual Power Center Top - Black with Wireless Charging	CT2U1-BLW2 - add \$3,194
Dual Power Center Top - White with Wireless Charging	CT2U1-WHW2 - add \$3,194

LOK - CONFERENCE

Note: Order power infeed that best fits application

To Order Specify

① Veneer Model #	② Edge Detail	③ Wood Collection	④ Wood Finish	⑤ Electrical	⑥ Metal Color
Veneer (LKV)	<a href="#">See Edge Detail Options</a>	Essentials	<a href="#">See Essentials Wood Finish Options</a>	N None CT2 Dual Power Center Top CU2 Dual Power Underside CT2U1 Dual Power Center Top with Underside (See chart above)	<a href="#">See Metal Finish Color Options</a>
		Artisan	④ Wood Finish <a href="#">See Artisan Wood Finish Options</a>		

① Solid Surface Model #	② Top Surface Selection	③ Electrical	④ Metal Color
Solid Surface (LKS)	<a href="#">See Solid Surface Top Surface Selection Options</a>	N None CT2 Dual Power Center Top CU2 Dual Power Underside CT2U1 Dual Power Center Top with Underside (See chart above)	<a href="#">See Metal Finish Color Options</a>

Description

Rectangular Table 3pc with Y Base at Working Height

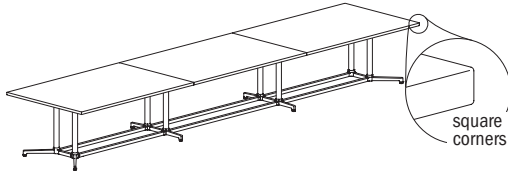

Laminate Tables  
"LKT" Models

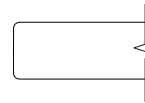

Eased Edge (R3)

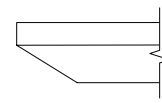

Reverse Bevel Edge (K9)

D	W	H	CTN WT	CU FT	Model	Eased Edge (R3)		Reverse Bevel Edge (K9)	
						Standard Tier 1	Graded In Tier 2	Standard Tier 1	Graded In Tier 2
60	240	29	653	281	LKT60240-29TTY	\$11,665	\$11,862	\$12,501	\$12,699
60	216	29	598	253	LKT60216-29TTY	\$9,703	\$9,879	\$10,500	\$10,679
54	240	29	584	254	LKT54240-29TTY	\$9,203	\$9,380	\$9,996	\$10,175
54	216	29	538	229	LKT54216-29TTY	\$8,221	\$8,381	\$8,983	\$9,141
48	240	29	545	228	LKT48240-29TTY	\$8,904	\$9,064	\$9,657	\$9,815
48	216	29	492	206	LKT48216-29TTY	\$7,791	\$7,932	\$8,514	\$8,657

LAMINATE

Features:

- price reflects complete table - top and base
- ships KD in multiple cartons
- three piece top
- model includes adjustable glide

Options:

- specify power/charging option, see below for options and upcharges



top shape

LOK - CONFERENCE

To Order Specify

1 Laminate Model #	2 Edge Detail	3 Laminate Selection	4 PVC Edge Color	5 Electrical	6 Metal Color
Laminate (LKT)	<a href="#">See Edge Detail Options</a>	<a href="#">See Laminate Selection</a>	<a href="#">See PVC Edge Color Options</a>	N None CT6 Six Power Center Top CU2 Dual Power Underside CT6U2 Six Power Center Top with Underside (See chart on next page)	<a href="#">See Metal Finish Color Options</a>

Model Number Breakdown

LKT60240-29TTY					
LK	T	60240	29	TT	Y
LOK	Laminate	60" x 240"	Height	Rectangular Top Shape	Y base

Description

Rectangular Table 3pc with Y Base at Working Height (continued)

Veneer Tables "LKV" Models

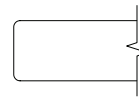

Eased Edge (R3)

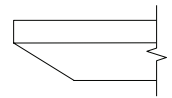

Reverse Bevel Edge (K9)

D	W	H	CTN WT	CU FT	① Model	Eased Edge (R3)		Reverse Bevel Edge (K9)		
						Essentials	Artisan	Essentials	Artisan	
60	240	29	653	281	LKV60240-29TTY	\$18,175	\$19,629	\$19,812	\$21,098	
60	216	29	598	253	LKV60216-29TTY	\$15,898	\$17,171	\$17,332	\$18,455	
VENEER	54	240	29	584	254	LKV54240-29TTY	\$15,140	\$16,454	\$15,904	\$17,152
	54	216	29	538	229	LKV54216-29TTY	\$13,423	\$14,587	\$14,124	\$15,229
	48	240	29	545	228	LKV48240-29TTY	\$14,404	\$15,562	\$15,097	\$16,191
	48	216	29	492	206	LKV48216-29TTY	\$12,538	\$13,564	\$13,178	\$14,147

Electrical Options and Upcharges

	216 - 240 wide
<b>CT6</b>	
Six Power Center Top - Black	CT6BL - add \$4,949
Six Power Center Top - White	CT6WH - add \$4,949
<b>CU2</b>	
Dual Power Underside - Black	CU2-1C - add \$1,298
Dual Power Underside with 4 Wireless Charging - Black	CU2-1CW - add \$3,278
<b>CT6U2</b>	
Six Power Center Top - Black with Dual Underside	CT6U2-BL - add \$5,748
Six Power Center Top - White with Dual Underside	CT6U2-WH - add \$5,748
Six Power Center Top- Black Dual Underside with 4 Wireless Charging	CT6U2-BLW2 - add \$7,668
Six Power Center Top- White Dual Underside with 4 Wireless Charging	CT6U2-WHW2 - add \$7,668

Note: Order power infeed that best fits application

To Order Specify

① Veneer Model #	② Edge Detail	③ Wood Collection	④ Wood Finish	⑤ Electrical	⑥ Metal Color
Veneer (LKV)	<a href="#">See Edge Detail Options</a>	Essentials	<a href="#">See Essentials Wood Finish Options</a>	N None CT6 Six Power Center Top CU2 Dual Power Underside CT6U2 Six Power Center Top with Underside (See chart above)	<a href="#">See Metal Finish Color Options</a>
		Artisan	④ Wood Finish <a href="#">See Artisan Wood Finish Options</a>		

LOK- CONFERENCE

Description

Rectangular 2pc Table with Y Base at Working Height

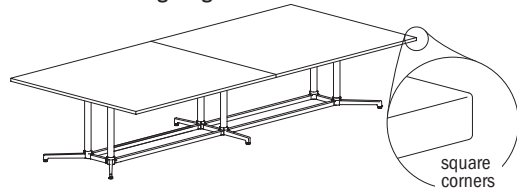

Laminate Tables "LKT" Models

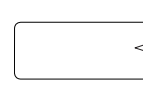

Eased Edge (R3)

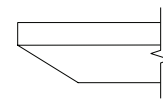

Reverse Bevel Edge (K9)

D	W	H	CTN WT	CU FT	Model	Eased Edge (R3)		Reverse Bevel Edge (K9)	
						Standard Tier 1	Graded In Tier 2	Standard Tier 1	Graded In Tier 2
60	192	29	513	226	LKT60192-29TTY	\$8,300	\$8,456	\$9,060	\$9,217
60	168	29	460	198	LKT60168-29TTY	\$7,725	\$7,866	\$8,451	\$8,589
60	144	29	345	169	LKT60144-29TTY	\$7,053	\$7,172	\$7,743	\$7,860
60	120	29	342	143	LKT60120-29TTY	\$6,224	\$6,324	\$6,876	\$6,972
LAMINATE									
54	192	29	462	204	LKT54192-29TTY	\$7,875	\$8,016	\$8,601	\$8,744
54	168	29	368	178	LKT54168-29TTY	\$7,011	\$7,136	\$7,705	\$7,830
54	144	29	365	154	LKT54144-29TTY	\$6,377	\$6,482	\$7,041	\$7,144
54	120	29	316	130	LKT54120-29TTY	\$5,847	\$5,934	\$6,477	\$6,565
48	192	29	422	183	LKT48192-29TTY	\$7,666	\$7,794	\$8,361	\$8,486
48	168	29	375	161	LKT48168-29TTY	\$6,204	\$6,312	\$6,869	\$6,980
48	144	29	333	139	LKT48144-29TTY	\$5,749	\$5,846	\$6,389	\$6,482
48	120	29	291	116	LKT48120-29TTY	\$5,198	\$5,277	\$5,809	\$5,888
48	108	29	269	105	LKT48108-29TTY	\$4,627	\$4,697	\$5,224	\$5,295

Features:

- price reflects complete table - top and base
- ships KD in multiple cartons
- two piece top
- model includes adjustable glide

Options:

- specify power/charging option, see below for options and upcharges

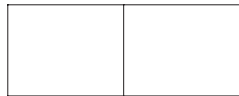

top shape

LOK - CONFERENCE

To Order Specify

1 Laminate Model #	2 Edge Detail	3 Laminate Selection	3a PVC Edge Color	4 Electrical	5 Metal Color
Laminate (LKT)	<a href="#">See Edge Detail Options</a>	<a href="#">See Laminate Selection</a>	<a href="#">See PVC Edge Color Options</a>	N None CT2 Dual Power Center Top CU2 Dual Power Underside CT2U1 Dual Power Center Top with Underside CT4U2 Four Power Center Top with Underside CT4 Four Power Center Top (See chart on next page)	<a href="#">See Metal Finish Color Options</a>

Model Number Breakdown

LKT60192-29TTY					
LK	T	60192	29	TT	Y
LOK	Laminate	60" x 192"	Height	Rectangular Top Shape	Y base

Description

Rectangular 2pc Table with Y Base at Working Height (continued)

Veneer Tables "LKV" Models

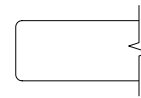

Eased Edge (R3)

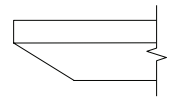

Reverse Bevel Edge (K9)

D	W	H	CTN WT	CU FT	Model	Essentials		Artisan		
						Essentials	Artisan	Essentials	Artisan	
60	192	29	513	226	LKV60192-29TTY	\$12,726	\$13,744	\$13,871	\$14,773	
60	168	29	460	198	LKV60168-29TTY	\$11,667	\$12,601	\$12,717	\$13,542	
60	144	29	345	169	LKV60144-29TTY	\$10,500	\$11,341	\$11,445	\$12,187	
60	120	29	342	143	LKV60120-29TTY	\$9,414	\$10,165	\$10,260	\$10,927	
VENEER	54	192	29	462	204	LKV54192-29TTY	\$11,798	\$12,744	\$12,860	\$13,697
	54	168	29	368	178	LKV54168-29TTY	\$10,626	\$11,476	\$11,583	\$12,335
	54	144	29	365	154	LKV54144-29TTY	\$9,539	\$10,302	\$10,398	\$11,074
	54	120	29	316	130	LKV54120-29TTY	\$8,629	\$9,318	\$9,404	\$10,014
48	192	29	422	183	LKV48192-29TTY	\$11,724	\$12,617	\$12,308	\$13,152	
48	168	29	375	161	LKV48168-29TTY	\$9,472	\$10,244	\$10,005	\$10,732	
48	144	29	333	139	LKV48144-29TTY	\$8,663	\$9,314	\$9,149	\$9,758	
48	120	29	291	116	LKV48120-29TTY	\$7,747	\$8,282	\$8,180	\$8,682	
48	108	29	269	105	LKV48108-29TTY	\$6,647	\$7,180	\$7,248	\$7,717	

Electrical Options and Upcharges

	120 - 192 wide
<b>CT4</b>	
Four Power Center Top - Black	CT4BL - add \$3,906
Four Power Center Top - White	CT4WH - add \$3,906
<b>CU1</b>	
Single Power Underside - Black	CU1-1C - add \$849
Single Power Underside with Wireless Charging - Black	CU1-1CW - add \$1,776
<b>CT4U1</b>	
Four Power Center Top with Underside - Black	CT4U1-BL - add \$3,906
Four Power Center Top with Underside - White	CT4U1-WH - add \$3,906
Four Power Center Top - Black with Underside & 2 Wireless Charging	CT4U1-BLW2 - add \$4,840
Four Power Center Top - White with Underside & 2 Wireless Charging	CT4U1-WHW2 - add \$4,840

Note: Order power infed that best fits application, see page 408.

To Order Specify

1 Veneer Model #	2 Edge Detail	3 Wood Collection	4 Wood Finish	5 Electrical	6 Metal Color
Veneer (LKV)	<a href="#">See Edge Detail Options</a>	Essentials	<a href="#">See Essentials Wood Finish Options</a>	N None CT2 Dual Power Center Top CU2 Dual Power Underside CT2U1 Dual Power Center Top with Underside CT4U2 Four Power Center Top with Underside CT4 Four Power Center Top	<a href="#">See Metal Finish Color Options</a>
		Artisan	<b>4 Wood Finish</b> <a href="#">See Artisan Wood Finish Options</a>		

LOK- CONFERENCE

Description

Rectangular Table with Y Base at Working Height

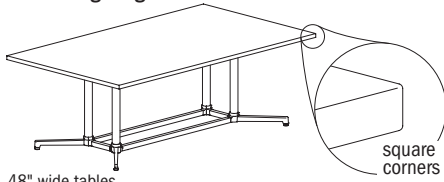

48" wide tables have double column base

LAMINATE	D	W	H	CTN WT	CU FT	Model	Laminate Tables "LKT" Models			
							Eased Edge (R3)		Reverse Bevel Edge (K9)	
							Standard Tier 1	Graded In Tier 2	Standard Tier 1	Graded In Tier 2
	48	96	29	225	105	LKT4896-29TTY	\$3,818	\$3,882	\$4,403	\$4,467
	48	84	29	333	83	LKT4884-29TTY	\$3,348	\$3,402	\$3,920	\$3,971
	42	96	29	174	83	LKT4296-29TTY	\$3,640	\$3,694	\$4,207	\$4,262
	42	84	29	174	72	LKT4284-29TTY	\$3,045	\$3,092	\$3,600	\$3,646
	36	96	29	152	72	LKT3696-29TTY	\$2,905	\$2,955	\$3,459	\$3,507
	36	84	29	156	64	LKT3684-29TTY	\$2,656	\$2,698	\$3,196	\$3,239

Features:

- price reflects complete table - top and base
- ships KD in multiple cartons
- one piece top
- model includes adjustable glide

Options:

- specify power/charging option, see below for options and upcharges

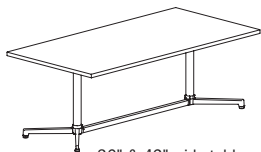

36" & 42" wide tables have single column base



top shape

LOK - CONFERENCE

To Order Specify

1 Laminite Model #	2 Edge Detail	3 Laminite Selection	3a PVC Edge Color	4 Electrical	5 Metal Color
Laminite (LKT)	<a href="#">See Edge Detail Options</a>	<a href="#">See Laminite Selection</a>	<a href="#">See PVC Edge Color Options</a>	N None CT2 Dual Power Center Top CU2 Dual Power Underside CT2U1 Dual Power Center Top with Underside (See chart on next page)	<a href="#">See Metal Finish Color Options</a>

Model Number Breakdown

LKT4896-29TTY					
LK	T	4896	29	TT	Y
LOK	Laminite	48" x 96"	Height	Rectangular Top Shape	Y base

Description

Rectangular Table with Y Base  
at Working Height  
(continued)

Veneer Tables  
"LKV" Models

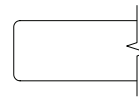

Eased Edge (R3)

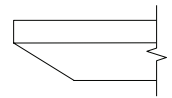

Reverse Bevel Edge (K9)

D	W	H	CTN WT	CU FT	① Model	Eased Edge (R3)		Reverse Bevel Edge (K9)	
						Essentials	Artisan	Essentials	Artisan
48	96	29	225	105	LKV4896-29TTY	\$5,328	\$5,744	\$5,708	\$6,094
48	84	29	333	83	LKV4884-29TTY	\$4,807	\$5,166	\$5,163	\$5,496
42	96	29	174	83	LKV4296-29TTY	\$5,411	\$5,846	\$5,898	\$6,282
	84	29	174	72	LKV4284-29TTY	\$4,597	\$4,964	\$5,010	\$5,334
36	96	29	152	72	LKV3696-29TTY	\$3,936	\$4,252	\$4,291	\$4,568
36	84	29	156	64	LKV3684-29TTY	\$3,683	\$3,975	\$4,014	\$4,274

Electrical Options and Upcharges

CT2	84 - 96 wide
Dual Power Center Top - Black	CT2BL - add \$1,837
Dual Power Center Top - White	CT2WH - add \$1,837
CU1	
Single Power Underside - Black	CU1-1C - add \$731
Single Power Underside with Wireless Charging - Black	CU1-1CW - add \$1,691
CT2U1	
Dual Power Center Top - Black with Single Underside	CT2U1-BL - add \$2,235
Dual Power Center Top - White with Single Underside	CT2U1-WH - add \$2,235
Dual Power Center Top - Black with Wireless Charging	CT2U1-BLW2 - add \$3,194
Dual Power Center Top - White with Wireless Charging	CT2U1-WHW2 - add \$3,194

Note: Order power infed that best fits application

To Order Specify

① Veneer Model #	② Edge Detail	③ Wood Collection	④ Wood Finish	⑤ Electrical	⑥ Metal Color
Veneer (LKV)	<a href="#">See Edge Detail Options</a>	Essentials	<a href="#">See Essentials Wood Finish Options</a>	N None CT2 Dual Power Center Top CU2 Dual Power Underside CT2U1 Dual Power Center Top with Underside (See chart above)	<a href="#">See Metal Finish Color Options</a>
		Artisan	④ Wood Finish <a href="#">See Artisan Wood Finish Options</a>		

## Description

Rounded Rectangular 3pc Table with Y Base at Working Height

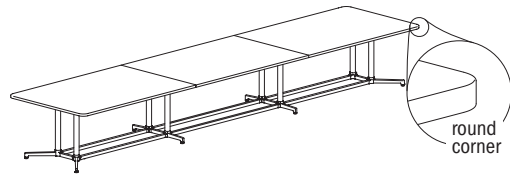

## Laminate Tables "LKT" Models

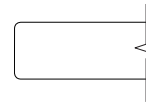

Eased Edge (R3)

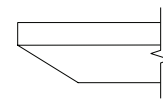

Reverse Bevel Edge (K9)

D	W	H	CTN WT	CU FT	① Model	Eased Edge (R3)		Reverse Bevel Edge (K9)	
						Standard Tier 1	Graded In Tier 2	Standard Tier 1	Graded In Tier 2
60	240	29	653	281	LKT60240-29TTRY	\$11,889	\$12,084	\$12,723	\$12,920
60	216	29	598	253	LKT60216-29TTRY	\$10,053	\$10,232	\$10,852	\$11,030
54	240	29	584	254	LKT54240-29TTRY	\$9,406	\$9,582	\$10,200	\$10,376
54	216	29	538	229	LKT54216-29TTRY	\$8,408	\$8,568	\$9,169	\$9,329
48	240	29	545	228	LKT48240-29TTRY	\$9,088	\$9,249	\$9,841	\$9,999
48	216	29	492	206	LKT48216-29TTRY	\$8,423	\$8,566	\$9,152	\$9,291

LAMINATE

### Features:

- price reflects complete table - top and base
- ships KD in multiple cartons
- three piece top
- model includes adjustable glide

### Options:

- specify power/charging option, see below for options and upcharges



top shape

LOK - CONFERENCE

## To Order Specify

① Laminate Model #	② Edge Detail	③ Laminate Selection	④ PVC Edge Color	⑤ Electrical	⑥ Metal Color
Laminate (LKT)	<a href="#">See Edge Detail Options</a>	<a href="#">See Laminate Selection</a>	<a href="#">See PVC Edge Color Options</a>	N None CT6 Six Power Center Top CU2 Dual Power Underside CT6U2 Six Power Center Top with Underside (See chart on next page)	<a href="#">See Metal Finish Color Options</a>

## Model Number Breakdown

LKT60240-29TTRY						
LK	T	60240	29	TT	R	Y
LOK	Laminate	60" x 240"	Height	Rectangular Top Shape	Rounded Corner	Y base

Description

Rounded Rectangular 3pc Table with Y Base at Working Height (continued)

Veneer Tables "LKV" Models

Solid Surface Tables "LKS" Models

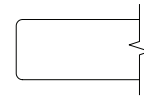

Eased Edge (R3)

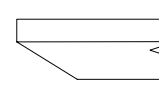

Reverse Bevel Edge (K9)

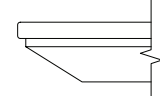

Reverse Bevel Edge (S7)

	D	W	H	CTN WT	CU FT	① Model	Veneer		Solid Surface		
							Essentials	Artisan	Essentials	Artisan	Standard
VENEER	60	240	29	653	281	LKV60240-29TTRY	\$18,509	\$19,989	\$20,175	\$21,485	--
	60	216	29	598	253	LKV60216-29TTRY	\$16,198	\$17,494	\$17,654	\$18,803	--
	54	240	29	584	254	LKV54240-29TTRY	\$15,440	\$16,755	\$16,203	\$17,449	--
	54	216	29	538	229	LKV54216-29TTRY	\$13,697	\$14,858	\$14,398	\$15,501	--
	48	240	29	545	228	LKV48240-29TTRY	\$14,674	\$15,830	\$15,364	\$16,459	--
	48	216	29	492	206	LKV48216-29TTRY	\$13,444	\$14,466	\$14,080	\$15,048	--
SOLID SURFACE	60	240	29	653	281	LKS60240-29TTRY	--	--	--	--	\$42,272
	60	216	29	598	253	LKS60216-29TTRY	--	--	--	--	\$38,130
	54	240	29	584	254	LKS54240-29TTRY	--	--	--	--	\$38,268
	54	216	29	538	229	LKS54216-29TTRY	--	--	--	--	\$33,974
	48	240	29	545	228	LKS48240-29TTRY	--	--	--	--	\$34,719
	48	216	29	492	206	LKS48216-29TTRY	--	--	--	--	\$31,253

Electrical Options and Upcharges

	216 - 240 wide
<b>CT6</b>	
Six Power Center Top - Black	CT6BL - add \$4,949
Six Power Center Top - White	CT6WH - add \$4,949
<b>CU2</b>	
Dual Power Underside - Black	CU2-1C - add \$1,298
Dual Power Underside with 4 Wireless Charging - Black	CU2-1CW - add \$3,278
<b>CT6U2</b>	
Six Power Center Top - Black with Dual Underside	CT6U2-BL - add \$5,748
Six Power Center Top - White with Dual Underside	CT6U2-WH - add \$5,748
Six Power Center Top - Black Dual Underside with 4 Wireless Charging	CT6U2-BLW2 - add \$7,668
Six Power Center Top - White Dual Underside with 4 Wireless Charging	CT6U2-WHW2 - add \$7,668

LOK - CONFERENCE

To Order Specify

Note: Order power infed that best fits application

① Veneer Model #	② Edge Detail	③ Wood Collection	④ Wood Finish	⑤ Electrical	⑥ Metal Color
Veneer (LKV)	<a href="#">See Edge Detail Options</a>	Essentials	<a href="#">See Essentials Wood Finish Options</a>	N None CT6 Six Power Center Top CU2 Dual Power Underside CT6U2 Six Power Center Top with Underside (See chart above)	<a href="#">See Metal Finish Color Options</a>
		Artisan	④ Wood Finish <a href="#">See Artisan Wood Finish Options</a>		

① Solid Surface Model #	② Top Surface Selection	③ Electrical	④ Metal Color
Solid Surface (LKS)	<a href="#">See Solid Surface Top Surface Selection Options</a>	N None CT6 Six Power Center Top CU2 Dual Power Underside CT6U2 Six Power Center Top with Underside (See chart above)	<a href="#">See Metal Finish Color Options</a>

Description

Rounded Rectangular 2pc Table with Y Base at Working Height

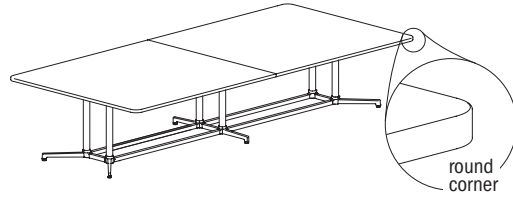

Laminate Tables "LKT" Models

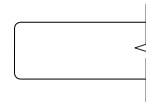

Eased Edge (R3)

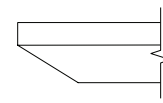

Reverse Bevel Edge (K9)

D	W	H	CTN WT	CU FT	Model	Eased Edge (R3)		Reverse Bevel Edge (K9)	
						Standard Tier 1	Graded In Tier 2	Standard Tier 1	Graded In Tier 2
60	192	29	513	226	LKT60192-29TTRY	\$8,315	\$8,471	\$9,074	\$9,230
60	168	29	460	198	LKT60168-29TTRY	\$7,724	\$7,862	\$8,448	\$8,588
60	144	29	345	169	LKT60144-29TTRY	\$7,037	\$7,155	\$7,723	\$7,841
60	120	29	342	143	LKT60120-29TTRY	\$6,338	\$6,436	\$6,990	\$7,089
54	192	29	462	204	LKT54192-29TTRY	\$8,024	\$8,165	\$8,753	\$8,893
54	168	29	368	178	LKT54168-29TTRY	\$7,144	\$7,270	\$7,841	\$7,965
54	144	29	365	154	LKT54144-29TTRY	\$6,497	\$6,601	\$7,162	\$7,264
54	120	29	316	130	LKT54120-29TTRY	\$5,953	\$6,040	\$6,584	\$6,673
48	192	29	422	183	LKT48192-29TTRY	\$7,802	\$7,931	\$8,498	\$8,623
48	168	29	375	161	LKT48168-29TTRY	\$6,328	\$6,436	\$6,994	\$7,102
48	144	29	333	139	LKT48144-29TTRY	\$5,860	\$5,955	\$6,501	\$6,596
48	120	29	291	116	LKT48120-29TTRY	\$5,296	\$5,376	\$5,908	\$5,986
48	108	29	269	105	LKT48108-29TTRY	\$4,718	\$4,790	\$5,316	\$5,386

LAMINATE

Features:

- price reflects complete table - top and base
- ships KD in multiple cartons
- two piece top
- model includes adjustable glide

Options:

- specify power/charging option, see below for options and upcharges



top shape

Electrical Options and Upcharges

	108 wide	120 - 192 wide
<b>CT2</b>		
Dual Power Center Top - Black	CT2BL - add \$1,837	n/a
Dual Power Center Top - White	CT2WH - add \$1,837	n/a
<b>CU1</b>		
Single Power Underside - Black	CU1-1C - add \$731	CU1-1C - add \$849
Single Power Underside with Wireless Charging - Black	CU1-1CW - add \$1,691	CU1-1CW - add \$1,776
<b>CT2U1</b>		
Dual Power Center Top - Black with Underside	CT2U1-BL - add \$2,235	n/a
Dual Power Center Top - White with Underside	CT2U1-WH - add \$2,235	n/a
Dual Power Center Top - Black with Wireless Charging	CT2U1-BLW2 - add \$3,194	n/a
Dual Power Center Top - White with Wireless Charging	CT2U1-WHW2 - add \$3,194	n/a

Note: Order power infeed that best fits application.

	108 wide	120 - 192 wide
<b>CT4U1</b>		
Four Power Center Top with Single Underside - Black	n/a	CT4U1-BL - add \$3,906
Four Power Center Top with Single Underside - White	n/a	CT4U1-WH - add \$3,906
Four Power Center Top - Black with Underside & Wireless Charging	n/a	CT4U1-BLW2 - add \$4,840
Four Power Center Top - White with Underside & Wireless Charging	n/a	CT4U1-WHW2 - add \$4,840
<b>CT4</b>		
Four Power Center Top - Black	n/a	CT4BL - add \$3,421
Four Power Center Top - White	n/a	CT4WH - add \$3,421

To Order Specify

1 Laminate Model #	2 Edge Detail	3 Laminate Selection	3a PVC Edge Color	4 Electrical	5 Metal Color
Laminate (LKT)	<a href="#">See Edge Detail Options</a>	<a href="#">See Laminate Selection</a>	<a href="#">See PVC Edge Color Options</a>	N None CT2 Dual Power Center Top CU2 Dual Power Underside CT2U1 Dual Power Center Top with Underside CT4U2 Four Power Center Top with Underside CT4 Four Power Center Top (See chart above)	<a href="#">See Metal Finish Color Options</a>

Model Number Breakdown

LKT60192-29TTRY						
LK	T	60192	29	TT	R	Y
LOK	Laminate	60" x 192"	Height	Rectangular Top Shape	Rounded Corner	Y base

Description

Rounded Rectangular 2pc Table with Y Base at Working Height (continued)

Veneer Tables "LKV" Models      Solid Surface Tables "LKS" Models

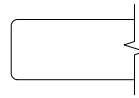

Eased Edge (R3)

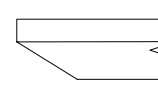

Reverse Bevel Edge (K9)

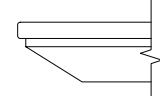

Reverse Bevel Edge (S7)

	D	W	H	CTN WT	CU FT	① Model	Veneer Tables		Solid Surface Tables		Standard	
							Essentials	Artisan	Essentials	Artisan		
VENEER	60	192	29	513	226	LKV60192-29TTRY	\$12,962	\$13,999	\$14,129	\$15,047	--	
	60	168	29	460	198	LKV60168-29TTRY	\$11,877	\$12,825	\$12,946	\$13,787	--	
	60	144	29	345	169	LKV60144-29TTRY	\$10,684	\$11,536	\$11,644	\$12,399	--	
	60	120	29	342	143	LKV60120-29TTRY	\$9,571	\$10,333	\$10,428	\$11,107	--	
	54	192	29	462	204	LKV54192-29TTRY	\$12,010	\$12,971	\$13,091	\$13,941	--	
	54	168	29	368	178	LKV54168-29TTRY	\$10,816	\$11,682	\$11,789	\$12,555	--	
	54	144	29	365	154	LKV54144-29TTRY	\$9,705	\$10,482	\$10,578	\$11,267	--	
	54	120	29	316	130	LKV54120-29TTRY	\$8,773	\$9,472	\$9,563	\$10,180	--	
	48	192	29	422	183	LKV48192-29TTRY	\$11,913	\$12,809	\$12,499	\$13,346	--	
	48	168	29	389	161	LKV48168-29TTRY	\$9,643	\$10,415	\$10,177	\$10,902	--	
	48	144	29	333	139	LKV48144-29TTRY	\$8,813	\$9,465	\$9,295	\$9,911	--	
	48	120	29	291	116	LKV48120-29TTRY	\$7,875	\$8,412	\$8,310	\$8,814	--	
	48	108	29	269	105	LKV48108-29TTRY	\$6,767	\$7,308	\$7,375	\$7,855	--	
	SOLID SURFACE	60	192	29	513	226	LKS60192-29TTRY	--	--	--	--	\$31,846
		60	168	29	460	198	LKS60168-29TTRY	--	--	--	--	\$28,074
		60	144	29	345	169	LKS60144-29TTRY	--	--	--	--	\$24,285
60		120	29	342	143	LKS60120-29TTRY	--	--	--	--	\$26,797	
54		192	29	462	204	LKS54192-29TTRY	--	--	--	--	\$28,979	
54		168	29	368	178	LKS54168-29TTRY	--	--	--	--	\$25,555	
54		144	29	365	154	LKS54144-29TTRY	--	--	--	--	\$22,143	
54		120	29	316	130	LKS54120-29TTRY	--	--	--	--	\$18,977	
48		192	29	422	183	LKS48192-29TTRY	--	--	--	--	\$27,334	
48		168	29	375	161	LKS48168-29TTRY	--	--	--	--	\$22,980	
48		144	29	333	139	LKS48144-29TTRY	--	--	--	--	\$20,132	
48		120	29	291	116	LKS48120-29TTRY	--	--	--	--	\$17,245	
48		108	29	269	105	LKS48108-29TTRY	--	--	--	--	\$16,071	

LOK- CONFERENCE

To Order Specify

① Veneer Model #	② Edge Detail	③ Wood Collection	④ Wood Finish	⑤ Electrical	⑥ Metal Color
Veneer (LKV)	<a href="#">See Edge Detail Options</a>	Essentials	<a href="#">See Essentials Wood Finish Options</a>	N None CT2 Dual Power Center Top CU2 Dual Power Underside CT2U1 Dual Power Center Top with Underside CT4U2 Four Power Center Top with Underside CT4 Four Power Center Top (See chart on previous page)	<a href="#">See Metal Finish Color Options</a>
		Artisan	④ Wood Finish <a href="#">See Artisan Wood Finish Options</a>		

① Solid Surface Model #	② Top Surface Selection	③ Electrical	④ Metal Color
Solid Surface (LKS)	<a href="#">See Solid Surface Top Surface Selection Options</a>	N None CT2 Dual Power Center Top CU2 Dual Power Underside CT2U1 Dual Power Center Top with Underside CT4U2 Four Power Center Top with Underside CT4 Four Power Center Top (See chart on previous page)	<a href="#">See Metal Finish Color Options</a>

## Description

Rounded Rectangular Table with Y Base at Working Height

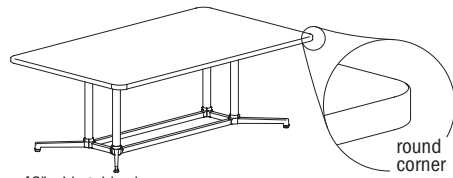

48" wide tables have double column base

D	W	H	CTN WT	CU FT	Model
48	96	29	225	105	LKT4896-29TTRY
48	84	29	333	83	LKT4884-29TTRY
42	96	29	174	83	LKT4296-29TTRY
42	84	29	174	72	LKT4284-29TTRY
36	96	29	152	72	LKT3696-29TTRY
36	84	29	156	64	LKT3684-29TTRY

LAMINATE

## Laminate Tables "LKT" Models

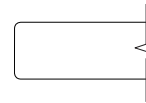

Eased Edge (R3)

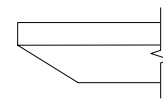

Reverse Bevel Edge (K9)

Standard Tier 1	Graded In Tier 2	Standard Tier 1	Graded In Tier 2
\$3,421	\$3,476	\$3,988	\$4,046
\$3,712	\$3,767	\$4,276	\$4,335
\$3,109	\$3,157	\$3,664	\$3,715
\$2,973	\$3,019	\$3,523	\$3,570
\$2,717	\$2,760	\$3,258	\$3,300

### Features:

- price reflects complete table - top and base
- ships KD in multiple cartons
- one piece top
- model includes adjustable glide

### Options:

- specify power/charging option, see below for options and upcharges

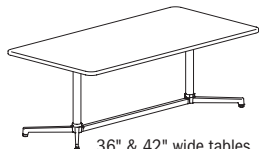

36" & 42" wide tables have single column base



top shape

LOK - CONFERENCE

## To Order Specify

1 Laminate Model #	2 Edge Detail	3 Laminate Selection	3a PVC Edge Color	4 Electrical	5 Metal Color
Laminate (LKT)	<a href="#">See Edge Detail Options</a>	<a href="#">See Laminate Selection</a>	<a href="#">See PVC Edge Color Options</a>	N None CT2 Dual Power Center Top CU2 Dual Power Underside CT2U1 Dual Power Center Top with Underside (See chart on next page)	<a href="#">See Metal Finish Color Options</a>

## Model Number Breakdown

LKT4896-29TTRY						
LK	T	4896	29	TT	R	Y
LOK	Laminate	48" x 96"	Height	Rectangular Top Shape	Rounded Corner	Y base

Description

Rounded Rectangular Table with Y Base at Working Height (continued)

Veneer Tables "LKV" Models

Solid Surface Tables "LKS" Models

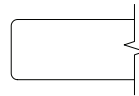

Eased Edge (R3)

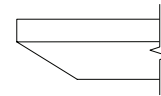

Reverse Bevel Edge (K9)

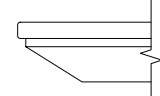

Reverse Bevel Edge (S7)

	D	W	H	CTN WT	CU FT	1 Model	Veneer Tables "LKV" Models		Solid Surface Tables "LKS" Models		
							Essentials	Artisan	Essentials	Artisan	Standard
VENEER	48	96	29	225	105	LKV4896-29TTRY	\$5,426	\$5,842	\$5,806	\$6,196	--
	48	84	29	333	83	LKV4884-29TTRY	\$4,895	\$5,254	\$5,250	\$5,585	--
	42	96	29	174	83	LKV4296-29TTRY	\$5,500	\$5,939	\$5,994	\$6,385	--
	42	84	29	174	72	LKV4284-29TTRY	\$4,678	\$5,051	\$5,098	\$5,430	--
	36	96	29	152	72	LKV3696-29TTRY	\$4,017	\$4,339	\$4,380	\$4,663	--
	36	84	29	156	64	LKV3684-29TTRY	\$3,758	\$4,058	\$4,094	\$4,359	--
SOLID SURFACE	48	96	29	225	105	LKS4896-29TTRY	--	--	--	--	\$12,669
	48	84	29	333	83	LKS4884-29TTRY	--	--	--	--	\$11,183
	42	96	29	174	83	LKS4296-29TTRY	--	--	--	--	\$10,528
	42	84	29	174	72	LKS4284-29TTRY	--	--	--	--	\$9,321
	36	96	29	152	72	LKS3696-29TTRY	--	--	--	--	\$9,052
	36	84	29	156	64	LKS3684-29TTRY	--	--	--	--	\$8,223

Electrical Options and Upcharges

CT2	84 - 96 wide
Dual Power Center Top - Black	CT2BL - add \$1,837
Dual Power Center Top - White	CT2WH - add \$1,837
CU1	
Single Power Underside - Black	CU1-1C - add \$731
Single Power Underside with Wireless Charging - Black	CU1-1CW - add \$1,691
CT2U1	
Dual Power Center Top - Black with Single Underside	CT2U1-BL - add \$2,235
Dual Power Center Top - White with Single Underside	CT2U1-WH - add \$2,235
Dual Power Center Top - Black with Wireless Charging	CT2U1-BLW2 - add \$3,194
Dual Power Center Top - White with Wireless Charging	CT2U1-WHW2 - add \$3,194

LOK - CONFERENCE

Note: Order power infeed that best fits application

To Order Specify

1 Veneer Model #	2 Edge Detail	3 Wood Collection	4 Wood Finish	5 Electrical	6 Metal Color
Veneer (LKV)	<a href="#">See Edge Detail Options</a>	Essentials	<a href="#">See Essentials Wood Finish Options</a>	N None CT2 Dual Power Center Top CU2 Dual Power Underside CT2U1 Dual Power Center Top with Underside (See chart above)	<a href="#">See Metal Finish Color Options</a>
		Artisan	4 Wood Finish <a href="#">See Artisan Wood Finish Options</a>		

1 Solid Surface Model #	2 Top Surface Selection	3 Electrical	4 Metal Color
Solid Surface (LKS)	<a href="#">See Solid Surface Top Surface Selection Options</a>	N None CT2 Dual Power Center Top CU2 Dual Power Underside CT2U1 Dual Power Center Top with Underside (See chart above)	<a href="#">See Metal Finish Color Options</a>

Description

Arc Rectangular 3pc Table with T Base at Working Height

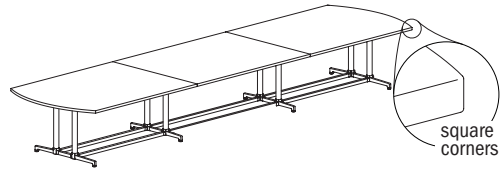

Laminate Tables  
"LKT" Models

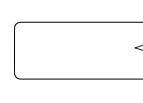

Eased Edge (R3)

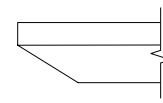

Reverse Bevel Edge (K9)

D	W	H	CTN WT	CU FT	Model	Eased Edge (R3)		Reverse Bevel Edge (K9)	
						Standard Tier 1	Graded In Tier 2	Standard Tier 1	Graded In Tier 2
60	240	29	648	281	LKT60240-29ART	\$12,271	\$12,471	\$13,108	\$13,305
60	216	29	593	253	LKT60216-29ART	\$10,460	\$10,636	\$11,260	\$11,438
54	240	29	598	254	LKT54240-29ART	\$9,900	\$10,074	\$10,693	\$10,870
54	216	29	549	229	LKT54216-29ART	\$9,380	\$9,539	\$10,143	\$10,302
48	240	29	548	228	LKT48240-29ART	\$9,429	\$9,588	\$10,183	\$10,339
48	216	29	549	206	LKT48216-29ART	\$8,341	\$8,484	\$9,068	\$9,210

LAMINATE

Features:

- price reflects complete table - top and base
- ships KD in multiple cartons
- three piece top
- model includes adjustable glide

Options:

- specify power/charging option, see below for options and upcharges



top shape

LOK - CONFERENCE

To Order Specify

1 Laminate Model #	2 Edge Detail	3 Laminate Selection	4 PVC Edge Color	5 Electrical	6 Metal Color
Laminate (LKT)	<a href="#">See Edge Detail Options</a>	<a href="#">See Laminate Selection</a>	<a href="#">See PVC Edge Color Options</a>	N None CT6 Six Power Center Top CU2 Dual Power Underside CT6U2 Six Power Center Top with Underside (See chart on next page)	<a href="#">See Metal Finish Color Options</a>

Model Number Breakdown

LKT60240-29ART					
LK	T	60240	29	TT	T
LOK	Laminate	60" x 240"	Height	Rectangular Top Shape	T base

Description

Arc Rectangular 3pc Table with T Base at Working Height (continued)

Veneer Tables "LKV" Models

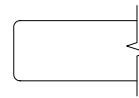

Eased Edge (R3)

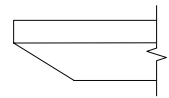

Reverse Bevel Edge (K9)

D	W	H	CTN WT	CU FT	Model	Eased Edge (R3)		Reverse Bevel Edge (K9)		
						Essentials	Artisan	Essentials	Artisan	
60	240	29	648	281	LKV60240-29ART	\$19,086	\$20,613	\$20,803	\$22,155	
60	216	29	593	253	LKV60216-29ART	\$16,800	\$18,143	\$18,311	\$19,502	
VENEER	54	240	29	598	254	LKV54240-29ART	\$16,169	\$17,479	\$16,932	\$18,176
	54	216	29	549	229	LKV54216-29ART	\$15,108	\$16,271	\$15,806	\$16,911
	48	240	29	548	228	LKV48240-29ART	\$15,170	\$16,325	\$15,864	\$16,954
	48	216	29	549	206	LKV48216-29ART	\$13,324	\$14,350	\$13,964	\$14,932

Electrical Options and Upcharges

	216 - 240 wide
<b>CT6</b>	
Six Power Center Top - Black	CT6BL - add \$4,949
Six Power Center Top - White	CT6WH - add \$4,949
<b>CU2</b>	
Dual Power Underside - Black	CU2-1C - add \$1,298
Dual Power Underside with 4 Wireless Charging - Black	CU2-1CW - add \$3,278
<b>CT6U2</b>	
Six Power Center Top - Black with Dual Underside	CT6U2-BL - add \$5,748
Six Power Center Top - White with Dual Underside	CT6U2-WH - add \$5,748
Six Power Center Top- Black Dual Underside with 4 Wireless Charging	CT6U2-BLW2 - add \$7,668
Six Power Center Top- White Dual Underside with 4 Wireless Charging	CT6U2-WHW2 - add \$7,668

Note: Order power infeed that best fits application

To Order Specify

1 Veneer Model #	2 Edge Detail	3 Wood Collection	4 Wood Finish	5 Electrical	6 Metal Color
Veneer (LKV)	<a href="#">See Edge Detail Options</a>	Essentials	<a href="#">See Essentials Wood Finish Options</a>	N None CT6 Six Power Center Top CU2 Dual Power Underside CT6U2 Six Power Center Top with Underside (See chart above)	<a href="#">See Metal Finish Color Options</a>
		Artisan	<b>4 Wood Finish</b> <a href="#">See Artisan Wood Finish Options</a>		

LOK- CONFERENCE

Description

Arc Rectangular 2pc Table with T Base at Working Height

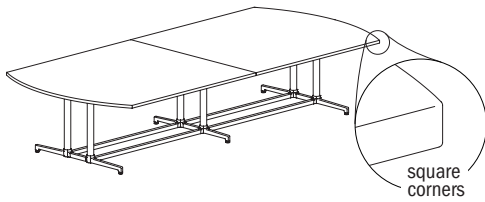

Laminate Tables "LKT" Models

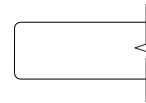

Eased Edge (R3)

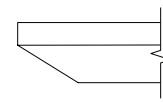

Reverse Bevel Edge (K9)

D	W	H	CTN WT	CU FT	Model	Eased Edge (R3)		Reverse Bevel Edge (K9)	
						Standard Tier 1	Graded In Tier 2	Standard Tier 1	Graded In Tier 2
60	192	29	507	226	LKT60192-29ART	\$8,547	\$8,708	\$9,307	\$9,465
60	168	29	453	198	LKT60168-29ART	\$7,977	\$8,115	\$8,699	\$8,838
60	144	29	396	169	LKT60144-29ART	\$7,360	\$7,478	\$8,048	\$8,165
60	120	29	339	143	LKT60120-29ART	\$6,526	\$6,623	\$7,176	\$7,275
LAMINATE									
54	192	29	467	204	LKT54192-29ART	\$8,133	\$8,277	\$8,861	\$9,004
54	168	29	389	178	LKT54168-29ART	\$7,367	\$7,493	\$8,065	\$8,187
54	144	29	368	154	LKT54144-29ART	\$6,787	\$6,895	\$7,452	\$7,558
54	120	29	316	130	LKT54120-29ART	\$6,081	\$6,169	\$6,708	\$6,798
48	192	29	429	183	LKT48192-29ART	\$7,097	\$7,224	\$7,793	\$7,918
48	168	29	385	161	LKT48168-29ART	\$6,598	\$6,708	\$7,264	\$7,375
48	144	29	339	139	LKT48144-29ART	\$6,053	\$6,147	\$6,691	\$6,787
48	120	29	293	116	LKT48120-29ART	\$5,439	\$5,518	\$6,051	\$6,130
48	108	29	270	105	LKT48108-29ART	\$4,609	\$4,678	\$5,202	\$5,274

Features:

- price reflects complete table - top and base
- ships KD in multiple cartons
- two piece top
- model includes adjustable glide

Options:

- specify power/charging option, see below for options and upcharges

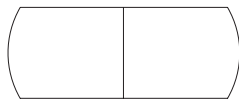

top shape

LOK - CONFERENCE

To Order Specify

1 Laminate Model #	2 Edge Detail	3 Laminate Selection	3a PVC Edge Color	4 Electrical	5 Metal Color
Laminate (LKT)	<a href="#">See Edge Detail Options</a>	<a href="#">See Laminate Selection</a>	<a href="#">See PVC Edge Color Options</a>	N None CT2 Dual Power Center Top CU2 Dual Power Underside CT2U1 Dual Power Center Top with Underside CT4U2 Four Power Center Top with Underside CT4 Four Power Center Top (See chart on next page)	<a href="#">See Metal Finish Color Options</a>

Model Number Breakdown

LKT60192-29ART					
LK	T	60192	29	TT	T
LOK	Laminate	60" x 192"	Height	Rectangular Top Shape	T base

Description

Arc Rectangular 2pc Table with T Base at Working Height (continued)

Veneer Tables "LKV" Models

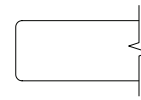

Eased Edge (R3)

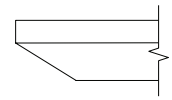

Reverse Bevel Edge (K9)

D	W	H	CTN WT	CU FT	Model	Eased Edge (R3)		Reverse Bevel Edge (K9)		
						Essentials	Artisan	Essentials	Artisan	
60	192	29	507	226	LKV60192-29ART	\$13,301	\$14,366	\$14,497	\$15,439	
60	168	29	453	198	LKV60168-29ART	\$12,235	\$13,213	\$13,335	\$14,202	
60	144	29	396	169	LKV60144-29ART	\$11,137	\$12,028	\$12,138	\$12,928	
60	120	29	339	143	LKV60120-29ART	\$9,827	\$10,613	\$10,712	\$11,405	
VENEER	54	192	29	467	204	LKV54192-29ART	\$12,166	\$13,143	\$13,263	\$14,122
	54	168	29	389	178	LKV54168-29ART	\$11,127	\$12,018	\$12,128	\$12,916
	54	144	29	368	154	LKV54144-29ART	\$10,106	\$10,914	\$11,017	\$11,730
	54	120	29	316	130	LKV54120-29ART	\$8,944	\$9,658	\$9,747	\$10,378
48	192	29	429	183	LKV48192-29ART	\$10,927	\$11,822	\$11,511	\$12,356	
48	168	29	385	161	LKV48168-29ART	\$10,017	\$10,790	\$10,549	\$11,281	
48	144	29	339	139	LKV48144-29ART	\$9,072	\$9,725	\$9,556	\$10,170	
48	120	29	293	116	LKV48120-29ART	\$8,065	\$8,601	\$8,500	\$9,003	
48	108	29	270	105	LKV48108-29ART	\$6,622	\$7,152	\$7,217	\$7,685	

Electrical Options and Upcharges

CT2	108 wide	120 - 192 wide
Dual Power Center Top - Black	CT2BL - add \$1,837	n/a
Dual Power Center Top - White	CT2WH - add \$1,837	n/a
CU1		
Single Power Underside - Black	CU1-1C - add \$731	CU1-1C - add \$849
Single Power Underside with Wireless Charging - Black	CU1-1CW - add \$1,691	CU1-1CW - add \$1,776
CT2U1		
Dual Power Center Top - Black with Underside	CT2U1-BL - add \$2,235	n/a
Dual Power Center Top - White with Underside	CT2U1-WH - add \$2,235	n/a
Dual Power Center Top - Black with Wireless Charging	CT2U1-BLW2 - add \$3,194	n/a
Dual Power Center Top - White with Wireless Charging	CT2U1-WHW2 - add \$3,194	n/a

CT4U1	108 wide	120 - 192 wide
Four Power Center Top with Single Underside - Black	n/a	CT4U1-BL - add \$3,906
Four Power Center Top with Single Underside - White	n/a	CT4U1-WH - add \$3,906
Four Power Center Top - Black with Underside & Wireless Charging	n/a	CT4U1-BLW2 - add \$4,840
Four Power Center Top - White with Underside & Wireless Charging	n/a	CT4U1-WHW2 - add \$4,840
CT4		
Four Power Center Top - Black	n/a	CT4BL - add \$3,421
Four Power Center Top - White	n/a	CT4WH - add \$3,421

Note: Order power infeed that best fits application

To Order Specify

1 Veneer Model #	2 Edge Detail	3 Wood Collection	4 Wood Finish	5 Electrical	6 Metal Color
Veneer (LKV)	<a href="#">See Edge Detail Options</a>	Essentials	<a href="#">See Essentials Wood Finish Options</a>	N None CT2 Dual Power Center Top CU2 Dual Power Underside CT2U1 Dual Power Center Top with Underside CT4U2 Four Power Center Top with Underside CT4 Four Power Center Top	<a href="#">See Metal Finish Color Options</a>
		Artisan	4 Wood Finish <a href="#">See Artisan Wood Finish Options</a>		

LOK - CONFERENCE

Description

Arc Rectangular Table with T Base at Working Height

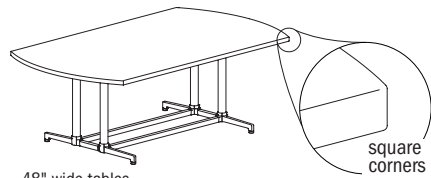

48" wide tables have double column base

D	W	H	CTN WT	CU FT	Model	Eased Edge (R3)		Reverse Bevel Edge (K9)	
						Standard Tier 1	Graded In Tier 2	Standard Tier 1	Graded In Tier 2
48	96	29	219	83	LKT4896-29ART	\$3,875	\$3,936	\$4,456	\$4,521
48	84	29	196	83	LKT4884-29ART	\$3,439	\$3,498	\$4,007	\$4,062
42	96	29	179	73	LKT4296-29ART	\$3,517	\$3,572	\$4,084	\$4,138
42	84	29	158	72	LKT4284-29ART	\$2,897	\$2,947	\$3,455	\$3,503
36	96	29	160	72	LKT3696-29ART	\$2,957	\$3,007	\$3,510	\$3,557
36	84	29	148	64	LKT3684-29ART	\$2,655	\$2,694	\$3,194	\$3,238

LAMINATE

Features:

- price reflects complete table - top and base
- ships KD in multiple cartons
- one piece top
- model includes adjustable glide

Options:

- specify power/charging option, see below for options and upcharges

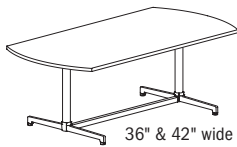

36" & 42" wide tables have single column base



top shape

LOK - CONFERENCE

To Order Specify

1 Laminata Model #	2 Edge Detail	3 Laminata Selection	3a PVC Edge Color	4 Electrical	5 Metal Color
Laminata (LKT)	<a href="#">See Edge Detail Options</a>	<a href="#">See Laminata Selection</a>	<a href="#">See PVC Edge Color Options</a>	N None CT2 Dual Power Center Top CU2 Dual Power Underside CT2U1 Dual Power Center Top with Underside (See chart on next page)	<a href="#">See Metal Finish Color Options</a>

Model Number Breakdown

LKT4896-29ART					
LK	T	4896	29	AR	T
LOK	Laminata	48" x 96"	Height	Arc Rectangular Top Shape	T base

Description

Arc Rectangular Table with T Base at Working Height (continued)

Veneer Tables "LKV" Models

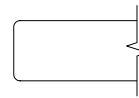

Eased Edge (R3)

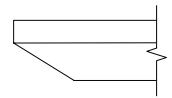

Reverse Bevel Edge (K9)

D	W	H	CTN WT	CU FT	Model	Eased Edge (R3)		Reverse Bevel Edge (K9)	
						Essentials	Artisan	Essentials	Artisan
48	96	29	219	83	LKV4896-29ART	\$5,395	\$5,810	\$5,776	\$6,168
48	84	29	196	83	LKV4884-29ART	\$4,922	\$5,281	\$5,276	\$5,610
42	96	29	179	73	LKV4296-29ART	\$5,256	\$5,678	\$5,729	\$6,100
42	84	29	158	72	LKV4284-29ART	\$4,419	\$4,771	\$4,817	\$5,131
36	96	29	160	72	LKV3696-29ART	\$4,001	\$4,320	\$4,359	\$4,644
36	84	29	148	64	LKV3684-29ART	\$3,682	\$3,973	\$4,012	\$4,270

VENEER

Electrical Options and Upcharges

CT2	84 - 96 wide
Dual Power Center Top - Black	CT2BL - add \$1,837
Dual Power Center Top - White	CT2WH - add \$1,837
CU1	
Single Power Underside - Black	CU1-1C - add \$731
Single Power Underside with Wireless Charging - Black	CU1-1CW - add \$1,691
CT2U1	
Dual Power Center Top - Black with Single Underside	CT2U1-BL - add \$2,235
Dual Power Center Top - White with Single Underside	CT2U1-WH - add \$2,235
Dual Power Center Top - Black with Wireless Charging	CT2U1-BLW2 - add \$3,194
Dual Power Center Top - White with Wireless Charging	CT2U1-WHW2 - add \$3,194

Note: Order power infed that best fits application

To Order Specify

1 Veneer Model #	2 Edge Detail	3 Wood Collection	4 Wood Finish	5 Electrical	6 Metal Color
Veneer (LKV)	<a href="#">See Edge Detail Options</a>	Essentials	<a href="#">See Essentials Wood Finish Options</a>	N None CT2 Dual Power Center Top CU2 Dual Power Underside CT2U1 Dual Power Center Top with Underside (See chart above)	<a href="#">See Metal Finish Color Options</a>
		Artisan	4 Wood Finish <a href="#">See Artisan Wood Finish Options</a>		

LOK - CONFERENCE

Description

Rounded Arc Rectangular 3pc Table with T Base at Working Height

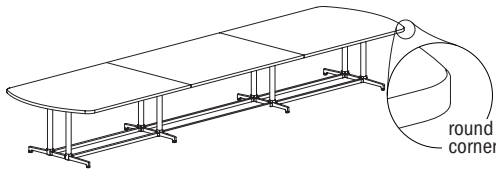

Laminate Tables  
"LKT" Models

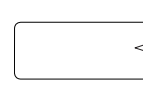

Eased Edge (R3)

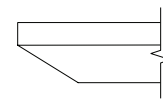

Reverse Bevel Edge (K9)

LAMINATE	D	W	H	CTN WT	CU FT	1 Model	Standard Tier 1	Graded In Tier 2	Standard Tier 1	Graded In Tier 2
		60	240	29	648	281	LKT60240-29ARRT	\$12,271	\$12,471	\$13,108
	60	216	29	593	253	LKT60216-29ARRT	\$10,460	\$10,636	\$11,260	\$11,438
	54	240	29	598	254	LKT54240-29ARRT	\$9,900	\$10,074	\$10,693	\$10,870
	54	216	29	549	229	LKT54216-29ARRT	\$9,309	\$9,470	\$10,073	\$10,232
	48	240	29	548	228	LKT48240-29ARRT	\$9,429	\$9,588	\$10,183	\$10,339
	48	216	29	549	206	LKT48216-29ARRT	\$8,341	\$8,484	\$9,068	\$9,210

Features:

- price reflects complete table - top and base
- ships KD in multiple cartons
- three piece top
- model includes adjustable glide

Options:

- specify power/charging option, see below for options and upcharges

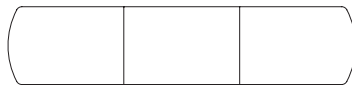

top shape

LOK - CONFERENCE

To Order Specify

1 Laminate Model #	2 Edge Detail	3 Laminate Selection	3a PVC Edge Color	4 Electrical	5 Metal Color
Laminate (LKT)	<a href="#">See Edge Detail Options</a>	<a href="#">See Laminate Selection</a>	<a href="#">See PVC Edge Color Options</a>	N None CT6 Six Power Center Top CU2 Dual Power Underside CT6U2 Six Power Center Top with Underside (See chart on next page)	<a href="#">See Metal Finish Color Options</a>

Model Number Breakdown

LKT60240-29ARRT						
LK	T	60240	29	AR	R	T
LOK	Laminate	60" x 240"	Height	Arc Rectangular Top Shape	Rounded Corner	T base

Description

Rounded Arc Rectangular 3pc Table with T Base at Working Height (continued)

Veneer Tables "LKV" Models

Solid Surface Tables "LKS" Models

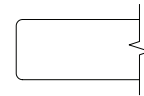

Eased Edge (R3)

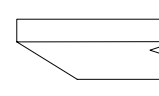

Reverse Bevel Edge (K9)

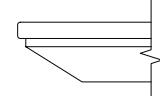

Reverse Bevel Edge (S7)

	D	W	H	CTN WT	CU FT	① Model	Veneer		Solid Surface		
							Essentials	Artisan	Essentials	Artisan	Standard
VENEER	60	240	29	648	281	LKV60240-29ARRT	\$19,086	\$20,613	\$20,803	\$22,155	--
	60	216	29	593	253	LKV60216-29ARRT	\$16,800	\$18,143	\$18,311	\$19,502	--
	54	240	29	598	254	LKV54240-29ARRT	\$16,169	\$17,479	\$16,932	\$18,176	--
	54	216	29	549	229	LKV54216-29ARRT	\$15,005	\$16,169	\$15,705	\$16,809	--
	48	240	29	548	228	LKV48240-29ARRT	\$15,170	\$16,325	\$15,864	\$16,954	--
	48	216	29	549	206	LKV48216-29ARRT	\$13,324	\$14,350	\$13,964	\$14,932	--
SOLID SURFACE	60	240	29	648	281	LKS60240-29ARRT	--	--	--	--	\$42,849
	60	216	29	593	253	LKS60216-29ARRT	--	--	--	--	\$38,729
	54	240	29	598	254	LKS54240-29ARRT	--	--	--	--	\$38,990
	54	216	29	549	229	LKS54216-29ARRT	--	--	--	--	\$35,281
	48	240	29	548	228	LKS48240-29ARRT	--	--	--	--	\$35,212
	48	216	29	549	206	LKS48216-29ARRT	--	--	--	--	\$31,136

Electrical Options and Upcharges

	216 - 240 wide
<b>CT6</b>	
Six Power Center Top - Black	CT6BL - add \$4,949
Six Power Center Top - White	CT6WH - add \$4,949
<b>CU2</b>	
Dual Power Underside - Black	CU2-1C - add \$1,298
Dual Power Underside with 4 Wireless Charging - Black	CU2-1CW - add \$3,278
<b>CT6U2</b>	
Six Power Center Top - Black with Dual Underside	CT6U2-BL - add \$5,748
Six Power Center Top - White with Dual Underside	CT6U2-WH - add \$5,748
Six Power Center Top - Black	CT6U2-BLW2 - add \$7,668
Dual Underside with 4 Wireless Charging	CT6U2-BLW2 - add \$7,668
Six Power Center Top - White	CT6U2-WHW2 - add \$7,668
Dual Underside with 4 Wireless Charging	CT6U2-WHW2 - add \$7,668

LOK - CONFERENCE

To Order Specify

Note: Order power infed that best fits application

① Veneer Model #	② Edge Detail	③ Wood Collection	④ Wood Finish	⑤ Electrical	⑥ Metal Color
Veneer (LKV)	<a href="#">See Edge Detail Options</a>	Essentials	<a href="#">See Essentials Wood Finish Options</a>	N None CT6 Six Power Center Top CU2 Dual Power Underside CT6U2 Six Power Center Top with Underside (See chart above)	<a href="#">See Metal Finish Color Options</a>
		Artisan	④ Wood Finish <a href="#">See Artisan Wood Finish Options</a>		

① Solid Surface Model #	② Top Surface Selection	③ Electrical	④ Metal Color
Solid Surface (LKS)	<a href="#">See Solid Surface Top Surface Selection Options</a>	N None CT6 Six Power Center Top CU2 Dual Power Underside CT6U2 Six Power Center Top with Underside (See chart above)	<a href="#">See Metal Finish Color Options</a>

Description

Rounded Arc Rectangular 2pc Table with T Base at Working Height

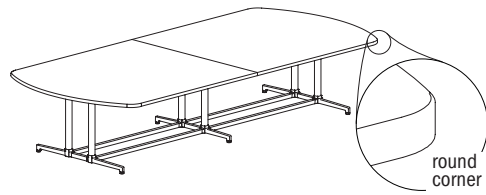

Laminate Tables "LKT" Models

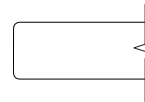

Eased Edge (R3)

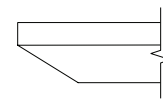

Reverse Bevel Edge (K9)

D	W	H	CTN WT	CU FT	Model	Eased Edge (R3)		Reverse Bevel Edge (K9)	
						Standard Tier 1	Graded In Tier 2	Standard Tier 1	Graded In Tier 2
60	192	29	507	226	LKT60192-29ARRT	\$8,547	\$8,708	\$9,307	\$9,465
60	168	29	453	198	LKT60168-29ARRT	\$7,977	\$8,115	\$8,699	\$8,838
60	144	29	396	169	LKT60144-29ARRT	\$7,360	\$7,478	\$8,048	\$8,165
60	120	29	339	143	LKT60120-29ARRT	\$6,526	\$6,623	\$7,176	\$7,275
54	192	29	467	204	LKT54192-29ARRT	\$8,133	\$8,277	\$8,861	\$9,004
54	168	29	389	178	LKT54168-29ARRT	\$7,367	\$7,493	\$8,065	\$8,187
54	144	29	368	154	LKT54144-29ARRT	\$6,787	\$6,895	\$7,452	\$7,558
54	120	29	316	130	LKT54120-29ARRT	\$6,081	\$6,169	\$6,708	\$6,798
48	192	29	429	183	LKT48192-29ARRT	\$7,097	\$7,224	\$7,793	\$7,918
48	168	29	385	161	LKT48168-29ARRT	\$6,598	\$6,708	\$7,264	\$7,375
48	144	29	339	139	LKT48144-29ARRT	\$6,952	\$7,045	\$7,589	\$7,684
48	120	29	293	116	LKT48120-29ARRT	\$5,439	\$5,518	\$6,051	\$6,130
48	108	29	270	105	LKT48108-29ARRT	\$4,609	\$4,678	\$5,202	\$5,274

LAMINATE

Features:

- price reflects complete table - top and base
- ships KD in multiple cartons
- two piece top
- model includes adjustable glide

Options:

- specify power/charging option, see below for options and upcharges

Electrical Options and Upcharges

	108 wide	120 - 192 wide
<b>CT2</b>		
Dual Power Center Top - Black	CT2BL - add \$1,837	n/a
Dual Power Center Top - White	CT2WH - add \$1,837	n/a
<b>CU1</b>		
Single Power Underside - Black	CU1-1C - add \$731	CU1-1C - add \$849
Single Power Underside with Wireless Charging - Black	CU1-1CW - add \$1,691	CU1-1CW - add \$1,776
<b>CT2U1</b>		
Dual Power Center Top - Black with Underside	CT2U1-BL - add \$2,235	n/a
Dual Power Center Top - White with Underside	CT2U1-WH - add \$2,235	n/a
Dual Power Center Top - Black with Wireless Charging	CT2U1-BLW2 - add \$3,194	n/a
Dual Power Center Top - White with Wireless Charging	CT2U1-WHW2 - add \$3,194	n/a

Note: Order power infeed that best fits application.

	108 wide	120 - 192 wide
<b>CT4U1</b>		
Four Power Center Top with Single Underside - Black	n/a	CT4U1-BL - add \$3,906
Four Power Center Top with Single Underside - White	n/a	CT4U1-WH - add \$3,906
Four Power Center Top - Black with Underside & Wireless Charging	n/a	CT4U1-BLW2 - add \$4,840
Four Power Center Top - White with Underside & Wireless Charging	n/a	CT4U1-WHW2 - add \$4,840
<b>CT4</b>		
Four Power Center Top - Black	n/a	CT4BL - add \$3,421
Four Power Center Top - White	n/a	CT4WH - add \$3,421



top shape

To Order Specify

1 Laminate Model #	2 Edge Detail	3 Laminate Selection	3a PVC Edge Color	4 Electrical	5 Metal Color
Laminate (LKT)	<a href="#">See Edge Detail Options</a>	<a href="#">See Laminate Selection</a>	<a href="#">See PVC Edge Color Options</a>	N None CT2 Dual Power Center Top CU2 Dual Power Underside CT2U1 Dual Power Center Top with Underside CT4U2 Four Power Center Top with Underside CT4 Four Power Center Top (See chart above)	<a href="#">See Metal Finish Color Options</a>

Model Number Breakdown

LKT60192-29ARRT						
LK	T	60192	29	AR	R	T
LOK	Laminate	60" x 192"	Height	Arc Rectangular Top Shape	Rounded Corner	T base

LOK - CONFERENCE

Description

Rounded Arc Rectangular 2pc  
Table with T Base at Working Height  
(continued)

Veneer Tables  
"LKV" Models

Solid Surface Tables  
"LKS" Models

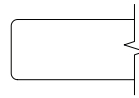

Eased Edge (R3)

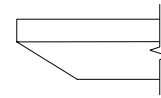

Reverse Bevel Edge (K9)

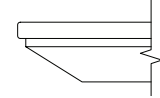

Reverse Bevel Edge (S7)

	D	W	H	CTN WT	CU FT	① Model	Veneer Tables "LKV" Models		Solid Surface Tables "LKS" Models			
							Essentials	Artisan	Essentials	Artisan	Standard	
VENEER	60	192	29	507	226	LKV60192-29ARRT	\$13,301	\$14,366	\$14,497	\$15,439	--	
	60	168	29	453	198	LKV60168-29ARRT	\$12,235	\$13,213	\$13,335	\$14,202	--	
	60	144	29	396	169	LKV60144-29ARRT	\$11,137	\$12,028	\$12,138	\$12,928	--	
	60	120	29	339	143	LKV60120-29ARRT	\$9,827	\$10,613	\$10,712	\$11,405	--	
	54	192	29	467	204	LKV54192-29ARRT	\$12,166	\$13,143	\$13,263	\$14,122	--	
	54	168	29	389	178	LKV54168-29ARRT	\$11,127	\$12,018	\$12,128	\$12,916	--	
	54	144	29	368	154	LKV54144-29ARRT	\$10,106	\$10,914	\$11,017	\$11,730	--	
	54	120	29	316	130	LKV54120-29ARRT	\$8,944	\$9,658	\$9,747	\$10,378	--	
	48	192	29	429	183	LKV48192-29ARRT	\$10,927	\$11,822	\$11,511	\$12,356	--	
	48	168	29	385	161	LKV48168-29ARRT	\$10,017	\$10,790	\$10,549	\$11,281	--	
	48	144	29	339	139	LKV48144-29ARRT	\$9,072	\$9,725	\$9,556	\$10,170	--	
	48	120	29	293	116	LKV48120-29ARRT	\$8,065	\$8,601	\$8,500	\$9,003	--	
	48	108	29	270	105	LKV48108-29ARRT	\$6,622	\$7,152	\$7,217	\$7,685	--	
	SOLID SURFACE	60	192	29	507	226	LKS60192-29ARRT	--	--	--	--	\$32,183
		60	168	29	453	198	LKS60168-29ARRT	--	--	--	--	\$28,438
		60	144	29	396	169	LKS60144-29ARRT	--	--	--	--	\$24,738
60		120	29	339	143	LKS60120-29ARRT	--	--	--	--	\$27,055	
54		192	29	467	204	LKS54192-29ARRT	--	--	--	--	\$29,137	
54		168	29	389	178	LKS54168-29ARRT	--	--	--	--	\$25,867	
54		144	29	368	154	LKS54144-29ARRT	--	--	--	--	\$22,540	
54		120	29	316	130	LKS54120-29ARRT	--	--	--	--	\$19,149	
48		192	29	429	183	LKS48192-29ARRT	--	--	--	--	\$26,347	
48		168	29	385	161	LKS48168-29ARRT	--	--	--	--	\$23,357	
48		144	29	339	139	LKS48144-29ARRT	--	--	--	--	\$20,391	
48		120	29	293	116	LKS48120-29ARRT	--	--	--	--	\$17,434	
48	108	29	270	105	LKS48108-29ARRT	--	--	--	--	\$15,926		

LOK- CONFERENCE

To Order Specify

① Veneer Model #	② Edge Detail	③ Wood Collection	④ Wood Finish	⑤ Electrical	⑥ Metal Color
Veneer (LKV)	<a href="#">See Edge Detail Options</a>	Essentials	<a href="#">See Essentials Wood Finish Options</a>	N None CT2 Dual Power Center Top CU2 Dual Power Underside CT2U1 Dual Power Center Top with Underside CT4U2 Four Power Center Top with Underside CT4 Four Power Center Top (See chart on previous page)	<a href="#">See Metal Finish Color Options</a>
		Artisan	④ Wood Finish <a href="#">See Artisan Wood Finish Options</a>		

① Solid Surface Model #	② Top Surface Selection	③ Electrical	④ Metal Color
Solid Surface (LKS)	<a href="#">See Solid Surface Top Surface Selection Options</a>	N None CT2 Dual Power Center Top CU2 Dual Power Underside CT2U1 Dual Power Center Top with Underside CT4U2 Four Power Center Top with Underside CT4 Four Power Center Top (See chart on previous page)	<a href="#">See Metal Finish Color Options</a>

Description

Rounded Arc Rectangular Table with T Base at Working Height

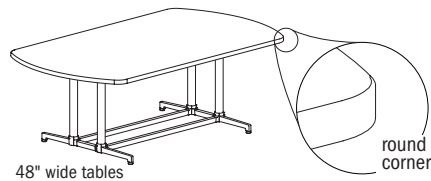

48" wide tables have double column base

D W H CTN WT CU FT **1** Model

LAMINATE

48	96	29	219	83	LKT4896-29ARRT
48	84	29	196	83	LKT4884-29ARRT
42	96	29	179	83	LKT4296-29ARRT
42	84	29	158	73	LKT4284-29ARRT
36	96	29	160	72	LKT3696-29ARRT
36	84	29	148	64	LKT3684-29ARRT

Laminate Tables "LKT" Models

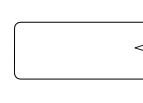

Eased Edge (R3)

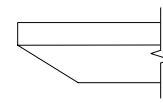

Reverse Bevel Edge (K9)

Eased Edge (R3)		Reverse Bevel Edge (K9)	
Standard Tier 1	Graded In Tier 2	Standard Tier 1	Graded In Tier 2
\$3,875	\$3,936	\$4,456	\$4,521
\$3,439	\$3,498	\$4,007	\$4,062
\$3,517	\$3,572	\$4,084	\$4,138
\$2,897	\$2,947	\$3,455	\$3,503
\$2,957	\$3,007	\$3,510	\$3,557
\$2,655	\$2,694	\$3,194	\$3,238

Features:

- price reflects complete table - top and base
- ships KD in multiple cartons
- one piece top
- model includes adjustable glide

Options:

- specify power/charging option, see below for options and upcharges

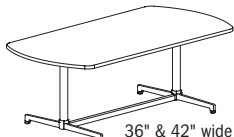

36" & 42" wide tables have single column base



top shape

LOK - CONFERENCE

To Order Specify

1 Laminate Model #	2 Edge Detail	3 Laminate Selection	3a PVC Edge Color	4 Electrical	5 Metal Color
Laminate (LKT)	<a href="#">See Edge Detail Options</a>	<a href="#">See Laminate Selection</a>	<a href="#">See PVC Edge Color Options</a>	N None CT2 Dual Power Center Top CU2 Dual Power Underside CT2U1 Dual Power Center Top with Underside (See chart on next page)	<a href="#">See Metal Finish Color Options</a>

Model Number Breakdown

LKT4896-29ARRT						
LK	T	4896	29	AR	R	T
LOK	Laminate	48" x 96"	Height	Arc Rectangular Top Shape	Rounded Corner	T base

Description

Rounded Arc Rectangular Table with T Base at Working Height (continued)

Veneer Tables "LKV" Models      Solid Surface Tables "LKS" Models

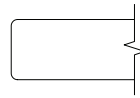

Eased Edge (R3)

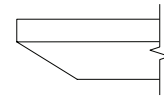

Reverse Bevel Edge (K9)

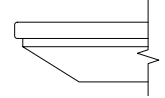

Reverse Bevel Edge (S7)

	D	W	H	CTN WT	CU FT	1 Model	Veneer Tables		Solid Surface Tables		
							Essentials	Artisan	Essentials	Artisan	Standard
VENEER	48	96	29	219	83	LKV4896-29ARRT	\$5,395	\$5,810	\$5,776	\$6,168	--
	48	84	29	196	83	LKV4884-29ARRT	\$4,922	\$5,281	\$5,276	\$5,610	--
	42	96	29	179	83	LKV4296-29ARRT	\$5,256	\$5,678	\$5,729	\$6,100	--
	42	84	29	158	73	LKV4284-29ARRT	\$4,419	\$4,771	\$4,817	\$5,131	--
	36	96	29	160	72	LKV3696-29ARRT	\$4,001	\$4,320	\$4,359	\$4,644	--
	36	84	29	148	64	LKV3684-29ARRT	\$3,682	\$3,973	\$4,012	\$4,270	--
SOLID SURFACE	48	96	29	219	83	LKS4896-29ARRT	--	--	--	--	\$12,641
	48	84	29	196	83	LKS4884-29ARRT	--	--	--	--	\$11,205
	42	96	29	179	83	LKS4296-29ARRT	--	--	--	--	\$10,285
	42	84	29	158	73	LKS4284-29ARRT	--	--	--	--	\$9,066
	36	96	29	160	72	LKS3696-29ARRT	--	--	--	--	\$9,038
	36	84	29	148	64	LKS3684-29ARRT	--	--	--	--	\$8,146

Electrical Options and Upcharges

CT2	84 - 96 wide
Dual Power Center Top - Black	CT2BL - add \$1,837
Dual Power Center Top - White	CT2WH - add \$1,837
CU1	
Single Power Underside - Black	CU1-1C - add \$731
Single Power Underside with Wireless Charging - Black	CU1-1CW - add \$1,691
CT2U1	
Dual Power Center Top - Black with Single Underside	CT2U1-BL - add \$2,235
Dual Power Center Top - White with Single Underside	CT2U1-WH - add \$2,235
Dual Power Center Top - Black with Wireless Charging	CT2U1-BLW2 - add \$3,194
Dual Power Center Top - White with Wireless Charging	CT2U1-WHW2 - add \$3,194

LOK - CONFERENCE

Note: Order power infeed that best fits application

To Order Specify

1 Veneer Model #	2 Edge Detail	3 Wood Collection	4 Wood Finish	5 Electrical	6 Metal Color
Veneer (LKV)	<a href="#">See Edge Detail Options</a>	Essentials	<a href="#">See Essentials Wood Finish Options</a>	N None CT2 Dual Power Center Top CU2 Dual Power Underside CT2U1 Dual Power Center Top with Underside (See chart above)	<a href="#">See Metal Finish Color Options</a>
		Artisan	4 Wood Finish <a href="#">See Artisan Wood Finish Options</a>		

1 Solid Surface Model #	2 Top Surface Selection	3 Electrical	4 Metal Color
Solid Surface (LKS)	<a href="#">See Solid Surface Top Surface Selection Options</a>	N None CT2 Dual Power Center Top CU2 Dual Power Underside CT2U1 Dual Power Center Top with Underside (See chart above)	<a href="#">See Metal Finish Color Options</a>

Description

Arc Rectangular 3pc Table with Y Base at Working Height

Laminate Tables "LKT" Models

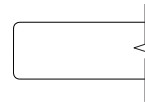
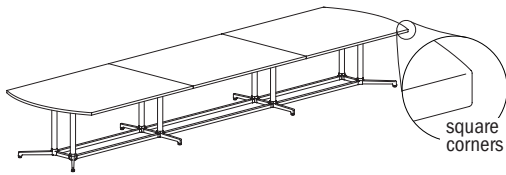

Eased Edge (R3)

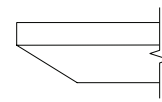

Reverse Bevel Edge (K9)

LAMINATE	D	W	H	CTN WT	CU FT	Model	Standard Tier 1	Graded In Tier 2	Standard Tier 1	Graded In Tier 2
		60	240	29	648	281	LKT60240-29ARY	\$11,889	\$12,084	\$12,723
	60	216	29	593	253	LKT60216-29ARY	\$10,053	\$10,232	\$10,852	\$11,030
	54	240	29	575	254	LKT54240-29ARY	\$9,406	\$9,582	\$10,200	\$10,376
	54	216	29	529	229	LKT54216-29ARY	\$8,408	\$8,568	\$9,169	\$9,329
	48	240	29	548	228	LKT48240-29ARY	\$9,088	\$9,249	\$9,841	\$9,999
	48	216	29	486	206	LKT48216-29ARY	\$8,423	\$8,566	\$9,152	\$9,291

Features:

- price reflects complete table - top and base
- ships KD in multiple cartons
- three piece top
- model includes adjustable glide

Options:

- specify power/charging option, see below for options and upcharges



top shape

LOK - CONFERENCE

To Order Specify

1 Laminate Model #	2 Edge Detail	3 Laminate Selection	4 PVC Edge Color	4 Electrical	5 Metal Color
Laminate (LKT)	<a href="#">See Edge Detail Options</a>	<a href="#">See Laminate Selection</a>	<a href="#">See PVC Edge Color Options</a>	N None CT6 Six Power Center Top CU2 Dual Power Underside CT6U2 Six Power Center Top with Underside (See chart on next page)	<a href="#">See Metal Finish Color Options</a>

Model Number Breakdown

LKT60240-29ARY					
LK	T	60240	29	AR	Y
LK	Laminate	60" x 240"	Height	Arc Rectangular Top Shape	Y base

Description

Arc Rectangular 3pc Table with Y Base at Working Height (continued)

Veneer Tables "LKV" Models

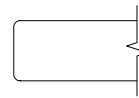

Eased Edge (R3)

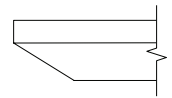

Reverse Bevel Edge (K9)

VENEER	D	W	H	CTN WT	CU FT	Model	Essentials	Artisan	Essentials	Artisan
		60	240	29	648	281	LKV60240-29ARY	\$18,509	\$19,989	\$20,175
	60	216	29	593	253	LKV60216-29ARY	\$16,198	\$17,494	\$17,654	\$18,803
	54	240	29	575	254	LKV54240-29ARY	\$15,440	\$16,755	\$16,203	\$17,449
	54	216	29	529	229	LKV54216-29ARY	\$13,697	\$14,858	\$14,398	\$15,501
	48	240	29	548	228	LKV48240-29ARY	\$14,674	\$15,830	\$15,364	\$16,459
	48	216	29	486	206	LKV48216-29ARY	\$13,444	\$14,466	\$14,080	\$15,048

Electrical Options and Upcharges

	216 - 240 wide
<b>CT6</b>	
Six Power Center Top - Black	CT6BL - add \$4,949
Six Power Center Top - White	CT6WH - add \$4,949
<b>CU2</b>	
Dual Power Underside - Black	CU2-1C - add \$1,298
Dual Power Underside with 4 Wireless Charging - Black	CU2-1CW - add \$3,278
<b>CT6U2</b>	
Six Power Center Top - Black with Dual Underside	CT6U2-BL - add \$5,748
Six Power Center Top - White with Dual Underside	CT6U2-WH - add \$5,748
Six Power Center Top - Black Dual Underside with 4 Wireless Charging	CT6U2-BLW2 - add \$7,668
Six Power Center Top - White Dual Underside with 4 Wireless Charging	CT6U2-WHW2 - add \$7,668

Note: Order power infeed that best fits application

To Order Specify

1 Veneer Model #	2 Edge Detail	3 Wood Collection	4 Wood Finish	5 Electrical	6 Metal Color
Veneer (LKV)	<a href="#">See Edge Detail Options</a>	Essentials	<a href="#">See Essentials Wood Finish Options</a>	N None CT6 Six Power Center Top CU2 Dual Power Underside CT6U2 Six Power Center Top with Underside (See chart above)	<a href="#">See Metal Finish Color Options</a>
		Artisan	<b>4 Wood Finish</b> <a href="#">See Artisan Wood Finish Options</a>		

LOK - CONFERENCE

Description

Arc Rectangular 2pc Table with Y Base at Working Height

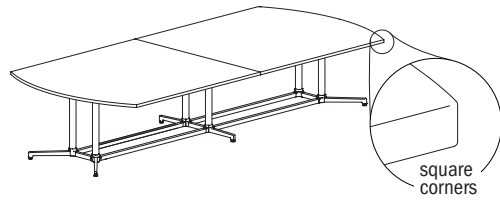

Laminate Tables "LKT" Models

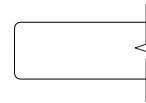

Eased Edge (R3)

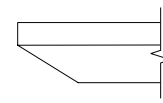

Reverse Bevel Edge (K9)

D	W	H	CTN WT	CU FT	Model	Eased Edge (R3)		Reverse Bevel Edge (K9)	
						Standard Tier 1	Graded In Tier 2	Standard Tier 1	Graded In Tier 2
60	192	29	507	226	LKT60192-29ARY	\$9,253	\$9,413	\$10,012	\$10,173
60	168	29	453	198	LKT60168-29ARY	\$7,724	\$7,862	\$8,448	\$8,588
60	144	29	333	169	LKT60144-29ARY	\$7,037	\$7,155	\$7,723	\$7,841
60	120	29	300	143	LKT60120-29ARY	\$6,338	\$6,436	\$6,990	\$7,089
LAMINATE									
54	192	29	454	204	LKT54192-29ARY	\$8,024	\$8,165	\$8,753	\$8,893
54	168	29	360	178	LKT54168-29ARY	\$7,144	\$7,270	\$7,841	\$7,965
54	144	29	357	154	LKT54144-29ARY	\$6,497	\$6,601	\$7,162	\$7,264
54	120	29	308	130	LKT54120-29ARY	\$5,953	\$6,040	\$6,584	\$6,673
48	192	29	416	183	LKT48192-29ARY	\$7,802	\$7,931	\$8,498	\$8,623
48	168	29	369	161	LKT48168-29ARY	\$6,328	\$6,436	\$6,994	\$7,102
48	144	29	327	139	LKT48144-29ARY	\$5,860	\$5,955	\$6,501	\$6,596
48	120	29	285	116	LKT48120-29ARY	\$5,296	\$5,376	\$5,908	\$5,986
48	108	29	263	105	LKT48108-29ARY	\$4,718	\$4,790	\$5,316	\$5,386

Features:

- price reflects complete table - top and base
- ships KD in multiple cartons
- two piece top
- model includes adjustable glide

Options:

- specify power/charging option, see below for options and upcharges



top shape

LOK - CONFERENCE

To Order Specify

1 Laminate Model #	2 Edge Detail	3 Laminate Selection	3a PVC Edge Color	4 Electrical	5 Metal Color
Laminate (LKT)	<a href="#">See Edge Detail Options</a>	<a href="#">See Laminate Selection</a>	<a href="#">See PVC Edge Color Options</a>	N None CT2 Dual Power Center Top CU2 Dual Power Underside CT2U1 Dual Power Center Top with Underside CT4U2 Four Power Center Top with Underside CT4 Four Power Center Top (See chart on next page)	<a href="#">See Metal Finish Color Options</a>

Model Number Breakdown

LKT60192-29ARY					
LK	T	60192	29	AR	Y
LOK	Laminate	60" x 192"	Height	Arc Rectangular Top Shape	Y base

Description

Arc Rectangular 2pc Table with Y Base at Working Height (continued)

Veneer Tables "LKV" Models

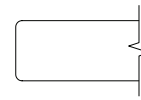

Eased Edge (R3)

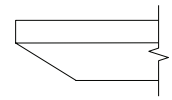

Reverse Bevel Edge (K9)

D	W	H	CTN WT	CU FT	Model	Eased Edge (R3)		Reverse Bevel Edge (K9)	
						Essentials	Artisan	Essentials	Artisan
60	192	29	507	226	LKV60192-29ARY	\$14,325	\$15,470	\$15,614	\$16,628
60	168	29	453	198	LKV60168-29ARY	\$11,877	\$12,825	\$12,946	\$13,787
60	144	29	333	169	LKV60144-29ARY	\$10,684	\$11,536	\$11,644	\$12,399
60	120	29	300	143	LKV60120-29ARY	\$9,571	\$10,333	\$10,428	\$11,107
54	192	29	454	204	LKV54192-29ARY	\$12,010	\$12,971	\$13,091	\$13,941
54	168	29	360	178	LKV54168-29ARY	\$10,816	\$11,682	\$11,789	\$12,555
54	144	29	357	154	LKV54144-29ARY	\$9,705	\$10,482	\$10,578	\$11,267
54	120	29	308	130	LKV54120-29ARY	\$8,773	\$9,472	\$9,563	\$10,180
48	192	29	416	183	LKV48192-29ARY	\$11,913	\$12,809	\$12,499	\$13,346
48	168	29	369	161	LKV48168-29ARY	\$9,643	\$10,415	\$10,177	\$10,902
48	144	29	327	139	LKV48144-29ARY	\$8,813	\$9,465	\$9,295	\$9,911
48	120	29	285	116	LKV48120-29ARY	\$7,875	\$8,412	\$8,310	\$8,814
48	108	29	263	105	LKV48108-29ARY	\$6,767	\$7,308	\$7,375	\$7,855

Electrical Options and Upcharges

CT2	108 wide	120 - 192 wide
Dual Power Center Top - Black	CT2BL - add \$1,837	n/a
Dual Power Center Top - White	CT2WH - add \$1,837	n/a
CU1		
Single Power Underside - Black	CU1-1C - add \$731	CU1-1C - add \$849
Single Power Underside with Wireless Charging - Black	CU1-1CW - add \$1,691	CU1-1CW - add \$1,776
CT2U1		
Dual Power Center Top - Black with Underside	CT2U1-BL - add \$2,235	n/a
Dual Power Center Top - White with Underside	CT2U1-WH - add \$2,235	n/a
Dual Power Center Top - Black with Wireless Charging	CT2U1-BLW2 - add \$3,194	n/a
Dual Power Center Top - White with Wireless Charging	CT2U1-WHW2 - add \$3,194	n/a

CT4U1	108 wide	120 - 192 wide
Four Power Center Top with Single Underside - Black	n/a	CT4U1-BL - add \$3,906
Four Power Center Top with Single Underside - White	n/a	CT4U1-WH - add \$3,906
Four Power Center Top - Black with Underside & Wireless Charging	n/a	CT4U1-BLW2 - add \$4,840
Four Power Center Top - White with Underside & Wireless Charging	n/a	CT4U1-WHW2 - add \$4,840
CT4		
Four Power Center Top - Black	n/a	CT4BL - add \$3,421
Four Power Center Top - White	n/a	CT4WH - add \$3,421

Note: Order power infeed that best fits application

To Order Specify

1 Veneer Model #	2 Edge Detail	3 Wood Collection	4 Wood Finish	5 Electrical	6 Metal Color
Veneer (LKV)	<a href="#">See Edge Detail Options</a>	Essentials	<a href="#">See Essentials Wood Finish Options</a>	N None CT2 Dual Power Center Top CU2 Dual Power Underside CT2U1 Dual Power Center Top with Underside CT4U2 Four Power Center Top with Underside CT4 Four Power Center Top	<a href="#">See Metal Finish Color Options</a>
		Artisan	4 Wood Finish <a href="#">See Artisan Wood Finish Options</a>		

LOK - CONFERENCE

## Description

Arc Rectangular Table with Y Base at Working Height

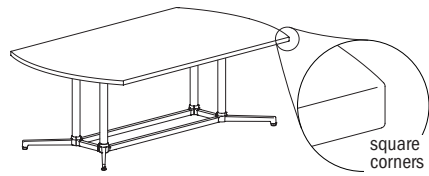

48" wide tables have double column base

D W H CTN WT CU FT **1 Model**

LAMINATE

D	W	H	CTN WT	CU FT	1 Model
48	96	29	218	105	LKT4896-29ARY
48	84	29	333	83	LKT4884-29ARY
42	96	29	169	83	LKT4296-29ARY
42	84	29	636	281	LKT4284-29ARY
36	96	29	636	281	LKT3696-29ARY
36	84	29	648	281	LKT3684-29ARY

## Laminate Tables "LKT" Models

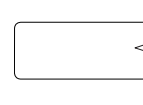

Eased Edge (R3)

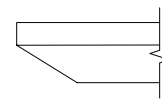

Reverse Bevel Edge (K9)

Standard Tier 1	Graded In Tier 2	Standard Tier 1	Graded In Tier 2
\$3,421	\$3,476	\$3,988	\$4,046
\$3,712	\$3,767	\$4,276	\$4,335
\$3,109	\$3,157	\$3,664	\$3,715
\$3,023	\$3,069	\$3,572	\$3,622
\$2,717	\$2,760	\$3,258	\$3,300

### Features:

- price reflects complete table - top and base
- ships KD in multiple cartons
- one piece top
- model includes adjustable glide

### Options:

- specify power/charging option, see below for options and upcharges

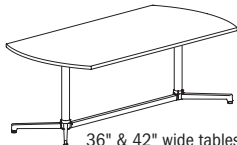

36" & 42" wide tables have single column base



top shape

LOK - CONFERENCE

## To Order Specify

1 Laminate Model #	2 Edge Detail	3 Laminate Selection	3a PVC Edge Color	4 Electrical	5 Metal Color
Laminate (LKT)	<a href="#">See Edge Detail Options</a>	<a href="#">See Laminate Selection</a>	<a href="#">See PVC Edge Color Options</a>	N None CT2 Dual Power Center Top CU2 Dual Power Underside CT2U1 Dual Power Center Top with Underside (See chart on next page)	<a href="#">See Metal Finish Color Options</a>

## Model Number Breakdown

LKT4896-29ARY					
LK	T	4896	29	AR	Y
LOK	Laminate	48" x 96"	Height	Arc Rectangular Top Shape	Y base

Description

Arc Rectangular Table with Y Base at Working Height (continued)

Veneer Tables "LKV" Models

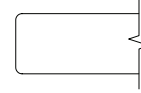

Eased Edge (R3)

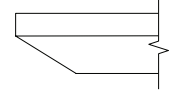

Reverse Bevel Edge (K9)

D	W	H	CTN WT	CU FT	Model	Eased Edge (R3)		Reverse Bevel Edge (K9)		
						Essentials	Artisan	Essentials	Artisan	
48	96	29	218	105	LKV4896-29ARY	\$5,426	\$5,842	\$5,806	\$6,196	
48	84	29	333	83	LKV4884-29ARY	\$4,895	\$5,254	\$5,250	\$5,585	
VENEER	42	96	29	169	83	LKV4296-29ARY	\$5,500	\$5,939	\$5,994	\$6,385
	42	84	29	636	281	LKV4284-29ARY	\$4,678	\$5,051	\$5,098	\$5,430
	36	96	29	636	281	LKV3696-29ARY	\$4,080	\$4,404	\$4,444	\$4,734
	36	84	29	648	281	LKV3684-29ARY	\$3,758	\$4,058	\$4,094	\$4,359

Electrical Options and Upcharges

CT2	84 - 96 wide
Dual Power Center Top - Black	CT2BL - add \$1,837
Dual Power Center Top - White	CT2WH - add \$1,837
CU1	
Single Power Underside - Black	CU1-1C - add \$731
Single Power Underside with Wireless Charging - Black	CU1-1CW - add \$1,691
CT2U1	
Dual Power Center Top - Black with Single Underside	CT2U1-BL - add \$2,235
Dual Power Center Top - White with Single Underside	CT2U1-WH - add \$2,235
Dual Power Center Top - Black with Wireless Charging	CT2U1-BLW2 - add \$3,194
Dual Power Center Top - White with Wireless Charging	CT2U1-WHW2 - add \$3,194

Note: Order power infed that best fits application

To Order Specify

1 Veneer Model #	2 Edge Detail	3 Wood Collection	4 Wood Finish	5 Electrical	6 Metal Color
Veneer (LKV)	<a href="#">See Edge Detail Options</a>	Essentials	<a href="#">See Essentials Wood Finish Options</a>	N None CT2 Dual Power Center Top CU2 Dual Power Underside CT2U1 Dual Power Center Top with Underside (See chart above)	<a href="#">See Metal Finish Color Options</a>
		Artisan	<b>4 Wood Finish</b> <a href="#">See Artisan Wood Finish Options</a>		

LOK - CONFERENCE

Description

Rounded Arc Rectangular 3pc Table with Y Base at Working Height

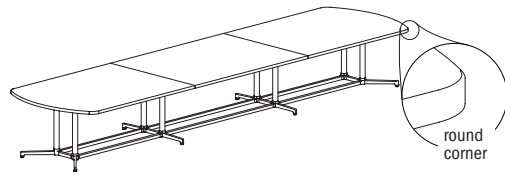

Laminate Tables  
"LKT" Models

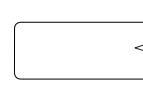

Eased Edge (R3)

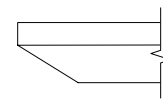

Reverse Bevel Edge (K9)

LAMINATE	D	W	H	CTN WT	CU FT	Model	Standard Tier 1	Graded In Tier 2	Standard Tier 1	Graded In Tier 2
		60	240	29	648	281	LKT60240-29ARRY	\$11,889	\$12,084	\$12,723
	60	216	29	593	253	LKT60216-29ARRY	\$10,053	\$10,232	\$10,852	\$11,030
	54	240	29	575	254	LKT54240-29ARRY	\$9,406	\$9,582	\$10,200	\$10,376
	54	216	29	529	229	LKT54216-29ARRY	\$8,408	\$8,568	\$9,169	\$9,329
	48	240	29	548	228	LKT48240-29ARRY	\$9,088	\$9,249	\$9,841	\$9,999
	48	216	29	486	206	LKT48216-29ARRY	\$8,423	\$8,566	\$9,152	\$9,291

Features:

- price reflects complete table - top and base
- ships KD in multiple cartons
- three piece top
- model includes adjustable glide

Options:

- specify power/charging option, see below for options and upcharges



top shape

LOK - CONFERENCE

To Order Specify

1 Laminate Model #	2 Edge Detail	3 Laminate Selection	3a PVC Edge Color	4 Electrical	5 Metal Color
Laminate (LKT)	<a href="#">See Edge Detail Options</a>	<a href="#">See Laminate Selection</a>	<a href="#">See PVC Edge Color Options</a>	N None CT6 Six Power Center Top CU2 Dual Power Underside CT6U2 Six Power Center Top with Underside (See chart on next page)	<a href="#">See Metal Finish Color Options</a>

Model Number Breakdown

LKT60240-29ARRY						
LK	T	60240	29	AR	R	Y
LOK	Laminate	60" x 240"	Height	Arc Rectangular Top Shape	Rounded Corner	Y base

Description

Rounded Arc Rectangular 3pc Table with Y Base at Working Height (continued)

Veneer Tables "LKV" Models

Solid Surface Tables "LKS" Models

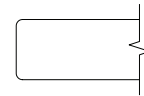

Eased Edge (R3)

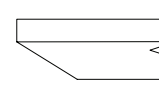

Reverse Bevel Edge (K9)

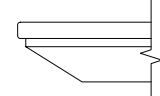

Reverse Bevel Edge (S7)

	D	W	H	CTN WT	CU FT	① Model	Veneer		Solid Surface		
							Essentials	Artisan	Essentials	Artisan	Standard
VENEER	60	240	29	648	281	LKV60240-29ARRY	\$18,509	\$19,989	\$20,175	\$21,485	--
	60	216	29	593	253	LKV60216-29ARRY	\$16,198	\$17,494	\$17,654	\$18,803	--
	54	240	29	575	254	LKV54240-29ARRY	\$15,440	\$16,755	\$16,203	\$17,449	--
	54	216	29	529	229	LKV54216-29ARRY	\$13,697	\$14,858	\$14,398	\$15,501	--
	48	240	29	548	228	LKV48240-29ARRY	\$14,674	\$15,830	\$15,364	\$16,459	--
	48	216	29	486	206	LKV48216-29ARRY	\$13,444	\$14,466	\$14,080	\$15,048	--
SOLID SURFACE	60	240	29	648	281	LKS60240-29ARRY	--	--	--	--	\$42,272
	60	216	29	593	253	LKS60216-29ARRY	--	--	--	--	\$38,130
	54	240	29	575	254	LKS54240-29ARRY	--	--	--	--	\$38,268
	54	216	29	529	229	LKS54216-29ARRY	--	--	--	--	\$33,974
	48	240	29	548	228	LKS48240-29ARRY	--	--	--	--	\$34,719
	48	216	29	486	206	LKS48216-29ARRY	--	--	--	--	\$31,253

Electrical Options and Upcharges

	216 - 240 wide
<b>CT6</b>	
Six Power Center Top - Black	CT6BL - add \$4,949
Six Power Center Top - White	CT6WH - add \$4,949
<b>CU2</b>	
Dual Power Underside - Black	CU2-1C - add \$1,298
Dual Power Underside with 4 Wireless Charging - Black	CU2-1CW - add \$3,278
<b>CT6U2</b>	
Six Power Center Top - Black with Dual Underside	CT6U2-BL - add \$5,748
Six Power Center Top - White with Dual Underside	CT6U2-WH - add \$5,748
Six Power Center Top - Black Dual Underside with 4 Wireless Charging	CT6U2-BLW2 - add \$7,668
Six Power Center Top - White Dual Underside with 4 Wireless Charging	CT6U2-WHW2 - add \$7,668

LOK - CONFERENCE

To Order Specify

Note: Order power infed that best fits application

① Veneer Model #	② Edge Detail	③ Wood Collection	④ Wood Finish	⑤ Electrical	⑥ Metal Color
Veneer (LKV)	<a href="#">See Edge Detail Options</a>	Essentials	<a href="#">See Essentials Wood Finish Options</a>	N None CT6 Six Power Center Top CU2 Dual Power Underside CT6U2 Six Power Center Top with Underside (See chart above)	<a href="#">See Metal Finish Color Options</a>
		Artisan	④ Wood Finish <a href="#">See Artisan Wood Finish Options</a>		

① Solid Surface Model #	② Top Surface Selection	③ Electrical	④ Metal Color
Solid Surface (LKS)	<a href="#">See Solid Surface Top Surface Selection Options</a>	N None CT6 Six Power Center Top CU2 Dual Power Underside CT6U2 Six Power Center Top with Underside (See chart above)	<a href="#">See Metal Finish Color Options</a>

Description

Rounded Arc Rectangular 2pc Table with Y Base at Working Height

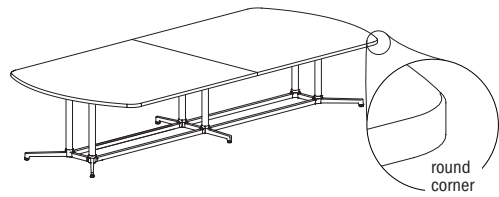

Laminate Tables "LKT" Models

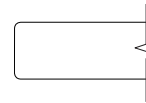

Eased Edge (R3)

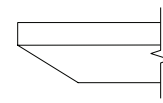

Reverse Bevel Edge (K9)

LAMINATE	D	W	H	CTN WT	CU FT	Model	Standard Tier 1	Graded In Tier 2	Standard Tier 1	Graded In Tier 2
		60	192	29	507	226	LKT60192-29ARRY	\$8,315	\$8,471	\$9,074
	60	168	29	453	198	LKT60168-29ARRY	\$7,724	\$7,862	\$8,448	\$8,588
	60	144	29	333	169	LKT60144-29ARRY	\$7,037	\$7,155	\$7,723	\$7,841
	60	120	29	330	143	LKT60120-29ARRY	\$6,338	\$6,436	\$6,990	\$7,089
	54	192	29	454	204	LKT54192-29ARRY	\$8,024	\$8,165	\$8,753	\$8,893
	54	168	29	360	178	LKT54168-29ARRY	\$7,144	\$7,270	\$7,841	\$7,965
	54	144	29	357	154	LKT54144-29ARRY	\$6,497	\$6,601	\$7,162	\$7,264
	54	120	29	308	130	LKT54120-29ARRY	\$5,953	\$6,040	\$6,584	\$6,673
	48	192	29	416	183	LKT48192-29ARRY	\$7,802	\$7,931	\$8,498	\$8,623
	48	168	29	369	161	LKT48168-29ARRY	\$6,328	\$6,436	\$6,994	\$7,102
	48	144	29	327	139	LKT48144-29ARRY	\$5,860	\$5,955	\$6,501	\$6,596
	48	120	29	285	116	LKT48120-29ARRY	\$5,296	\$5,376	\$5,908	\$5,986
	48	108	29	263	105	LKT48108-29ARRY	\$4,622	\$4,692	\$5,220	\$5,289

Features:

- price reflects complete table - top and base
- ships KD in multiple cartons
- two piece top
- model includes adjustable glide

Options:

- specify power/charging option, see below for options and upcharges

Electrical Options and Upcharges

	108 wide	120 - 192 wide
<b>CT2</b>		
Dual Power Center Top - Black	CT2BL - add \$1,837	n/a
Dual Power Center Top - White	CT2WH - add \$1,837	n/a
<b>CU1</b>		
Single Power Underside - Black	CU1-1C - add \$731	CU1-1C - add \$849
Single Power Underside with Wireless Charging - Black	CU1-1CW - add \$1,691	CU1-1CW - add \$1,776
<b>CT2U1</b>		
Dual Power Center Top - Black with Underside	CT2U1-BL - add \$2,235	n/a
Dual Power Center Top - White with Underside	CT2U1-WH - add \$2,235	n/a
Dual Power Center Top - Black with Wireless Charging	CT2U1-BLW2 - add \$3,194	n/a
Dual Power Center Top - White with Wireless Charging	CT2U1-WHW2 - add \$3,194	n/a

Note: Order power infeed that best fits application.

	108 wide	120 - 192 wide
<b>CT4U1</b>		
Four Power Center Top with Single Underside - Black	n/a	CT4U1-BL - add \$3,906
Four Power Center Top with Single Underside - White	n/a	CT4U1-WH - add \$3,906
Four Power Center Top - Black with Underside & Wireless Charging	n/a	CT4U1-BLW2 - add \$4,840
Four Power Center Top - White with Underside & Wireless Charging	n/a	CT4U1-WHW2 - add \$4,840
<b>CT4</b>		
Four Power Center Top - Black	n/a	CT4BL - add \$3,421
Four Power Center Top - White	n/a	CT4WH - add \$3,421

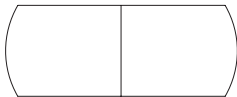

top shape

To Order Specify

1 Laminate Model #	2 Edge Detail	3 Laminate Selection	3a PVC Edge Color	4 Electrical	5 Metal Color
Laminate (LKT)	<a href="#">See Edge Detail Options</a>	<a href="#">See Laminate Selection</a>	<a href="#">See PVC Edge Color Options</a>	N None CT2 Dual Power Center Top CU2 Dual Power Underside CT2U1 Dual Power Center Top with Underside CT4U2 Four Power Center Top with Underside CT4 Four Power Center Top (See chart above)	<a href="#">See Metal Finish Color Options</a>

Model Number Breakdown

LKT60192-29ARRY						
LK	T	60192	29	AR	R	Y
LOK	Laminate	60" x 192"	Height	Arc Rectangular Top Shape	Rounded Corner	Y base

LOK - CONFERENCE

Description

Rounded Arc Rectangular 2pc Table with Y Base at Working Height (continued)

Veneer Tables "LKV" Models      Solid Surface Tables "LKS" Models

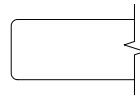

Eased Edge (R3)

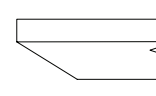

Reverse Bevel Edge (K9)

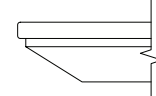

Reverse Bevel Edge (S7)

	D	W	H	CTN WT	CU FT	1 Model	Veneer		Solid Surface		Standard	
							Essentials	Artisan	Essentials	Artisan		
VENEER	60	192	29	507	226	LKV60192-29ARRY	\$12,962	\$13,999	\$14,129	\$15,047	--	
	60	168	29	453	198	LKV60168-29ARRY	\$11,877	\$12,825	\$12,946	\$13,787	--	
	60	144	29	333	169	LKV60144-29ARRY	\$10,684	\$11,536	\$11,644	\$12,399	--	
	60	120	29	330	143	LKV60120-29ARRY	\$9,571	\$10,333	\$10,428	\$11,107	--	
	54	192	29	454	204	LKV54192-29ARRY	\$12,010	\$12,971	\$13,091	\$13,941	--	
	54	168	29	360	178	LKV54168-29ARRY	\$10,816	\$11,682	\$11,789	\$12,555	--	
	54	144	29	357	154	LKV54144-29ARRY	\$9,705	\$10,482	\$10,578	\$11,267	--	
	54	120	29	308	130	LKV54120-29ARRY	\$8,773	\$9,472	\$9,563	\$10,180	--	
	48	192	29	416	183	LKV48192-29ARRY	\$11,913	\$12,809	\$12,499	\$13,346	--	
	48	168	29	385	161	LKV48168-29ARRY	\$9,643	\$10,415	\$10,177	\$10,902	--	
	48	144	29	327	139	LKV48144-29ARRY	\$8,813	\$9,465	\$9,295	\$9,911	--	
	48	120	29	285	116	LKV48120-29ARRY	\$7,875	\$8,412	\$8,310	\$8,814	--	
	48	108	29	263	105	LKV48108-29ARRY	\$6,643	\$7,172	\$7,242	\$7,709	--	
	SOLID SURFACE	60	192	29	507	226	LKS60192-29ARRY	--	--	--	--	\$31,846
		60	168	29	453	198	LKS60168-29ARRY	--	--	--	--	\$28,074
		60	144	29	333	169	LKS60144-29ARRY	--	--	--	--	\$24,285
60		120	29	330	143	LKS60120-29ARRY	--	--	--	--	\$26,797	
54		192	29	454	204	LKS54192-29ARRY	--	--	--	--	\$28,979	
54		168	29	360	178	LKS54168-29ARRY	--	--	--	--	\$25,555	
54		144	29	357	154	LKS54144-29ARRY	--	--	--	--	\$22,143	
54		120	29	308	130	LKS54120-29ARRY	--	--	--	--	\$18,977	
48		192	29	416	183	LKS48192-29ARRY	--	--	--	--	\$27,334	
48		168	29	369	161	LKS48168-29ARRY	--	--	--	--	\$22,980	
48		144	29	327	139	LKS48144-29ARRY	--	--	--	--	\$20,132	
48		120	29	285	116	LKS48120-29ARRY	--	--	--	--	\$17,245	
48		108	29	263	105	LKS48108-29ARRY	--	--	--	--	\$15,944	

LOK- CONFERENCE

To Order Specify

1 Veneer Model #	2 Edge Detail	3 Wood Collection	4 Wood Finish	5 Electrical	6 Metal Color
Veneer (LKV)	<a href="#">See Edge Detail Options</a>	Essentials	<a href="#">See Essentials Wood Finish Options</a>	N None CT2 Dual Power Center Top CU2 Dual Power Underside CT2U1 Dual Power Center Top with Underside CT4U2 Four Power Center Top with Underside CT4 Four Power Center Top (See chart on previous page)	<a href="#">See Metal Finish Color Options</a>
		Artisan	4 Wood Finish <a href="#">See Artisan Wood Finish Options</a>		

1 Solid Surface Model #	2 Top Surface Selection	3 Electrical	4 Metal Color
Solid Surface (LKS)	<a href="#">See Solid Surface Top Surface Selection Options</a>	N None CT2 Dual Power Center Top CU2 Dual Power Underside CT2U1 Dual Power Center Top with Underside CT4U2 Four Power Center Top with Underside CT4 Four Power Center Top (See chart on previous page)	<a href="#">See Metal Finish Color Options</a>

## Description

Rounded Arc Rectangular Table with Y Base at Working Height

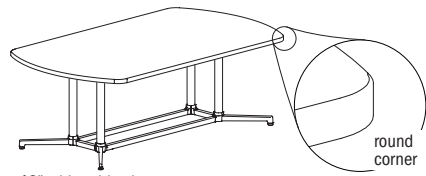

48" wide tables have double column base

D	W	H	CTN WT	CU FT	Model
---	---	---	--------	-------	-------

48	96	29	218	105	LKT4896-29ARRY
48	84	29	333	83	LKT4884-29ARRY
42	96	29	169	83	LKT4296-29ARRY
42	84	29	174	72	LKT4284-29ARRY
36	96	29	156	72	LKT3696-29ARRY
36	84	29	152	64	LKT3684-29ARRY

LAMINATE

## Laminate Tables "LKT" Models

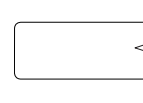

Eased Edge (R3)

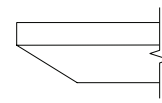

Reverse Bevel Edge (K9)

Standard Tier 1	Graded In Tier 2	Standard Tier 1	Graded In Tier 2
\$3,421	\$3,476	\$3,988	\$4,046
\$3,712	\$3,767	\$4,276	\$4,335
\$3,109	\$3,157	\$3,664	\$3,715
\$3,023	\$3,069	\$3,572	\$3,622
\$2,717	\$2,760	\$3,258	\$3,300

### Features:

- price reflects complete table - top and base
- ships KD in multiple cartons
- one piece top
- model includes adjustable glide

### Options:

- specify power/charging option, see below for options and upcharges



36" & 42" wide tables have single column base



top shape

LOK - CONFERENCE

## To Order Specify

1 Laminate Model #	2 Edge Detail	3 Laminate Selection	3a PVC Edge Color	4 Electrical	5 Metal Color
Laminate (LKT)	<a href="#">See Edge Detail Options</a>	<a href="#">See Laminate Selection</a>	<a href="#">See PVC Edge Color Options</a>	N None CT2 Dual Power Center Top CU2 Dual Power Underside CT2U1 Dual Power Center Top with Underside (See chart on next page)	<a href="#">See Metal Finish Color Options</a>

## Model Number Breakdown

LKT4896-29ARRY						
LK	T	4896	29	AR	R	Y
LOK	Laminate	48" x 96"	Height	Arc Rectangular Top Shape	Rounded Corner	Y base

Description

Rounded Arc Rectangular Table with Y Base at Working Height (continued)

Veneer Tables "LKV" Models      Solid Surface Tables "LKS" Models

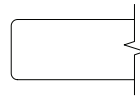

Eased Edge (R3)

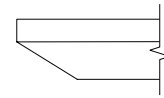

Reverse Bevel Edge (K9)

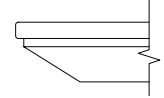

Reverse Bevel Edge (S7)

	D	W	H	CTN WT	CU FT	① Model	Veneer		Solid Surface		
							Essentials	Artisan	Essentials	Artisan	Standard
VENEER	48	96	29	218	105	LKV4896-29ARRY	\$5,426	\$5,842	\$5,806	\$6,196	--
	48	84	29	333	83	LKV4884-29ARRY	\$4,895	\$5,254	\$5,250	\$5,585	--
	42	96	29	169	83	LKV4296-29ARRY	\$5,500	\$5,939	\$5,994	\$6,385	--
	42	84	29	174	72	LKV4284-29ARRY	\$4,678	\$5,051	\$5,098	\$5,430	--
	36	96	29	156	72	LKV3696-29ARRY	\$4,080	\$4,404	\$4,444	\$4,734	--
	36	84	29	152	64	LKV3684-29ARRY	\$3,758	\$4,058	\$4,094	\$4,359	--
SOLID SURFACE	48	96	29	218	105	LKS4896-29ARRY	--	--	--	--	\$12,669
	48	84	29	333	73	LKS4884-29ARRY	--	--	--	--	\$11,183
	42	96	29	169	83	LKS4296-29ARRY	--	--	--	--	\$10,528
	42	84	29	174	72	LKS4284-29ARRY	--	--	--	--	\$9,321
	36	96	29	156	72	LKS3696-29ARRY	--	--	--	--	\$9,114
	36	84	29	152	64	LKS3684-29ARRY	--	--	--	--	\$8,223

Electrical Options and Upcharges

CT2	84 - 96 wide
Dual Power Center Top - Black	CT2BL - add \$1,837
Dual Power Center Top - White	CT2WH - add \$1,837
CU1	
Single Power Underside - Black	CU1-1C - add \$731
Single Power Underside with Wireless Charging - Black	CU1-1CW - add \$1,691
CT2U1	
Dual Power Center Top - Black with Single Underside	CT2U1-BL - add \$2,235
Dual Power Center Top - White with Single Underside	CT2U1-WH - add \$2,235
Dual Power Center Top - Black with Wireless Charging	CT2U1-BLW2 - add \$3,194
Dual Power Center Top - White with Wireless Charging	CT2U1-WHW2 - add \$3,194

LOK - CONFERENCE

Note: Order power infeed that best fits application

To Order Specify

① Veneer Model #	② Edge Detail	③ Wood Collection	④ Wood Finish	⑤ Electrical	⑥ Metal Color
Veneer (LKV)	<a href="#">See Edge Detail Options</a>	Essentials	<a href="#">See Essentials Wood Finish Options</a>	N None CT2 Dual Power Center Top CU2 Dual Power Underside CT2U1 Dual Power Center Top with Underside (See chart above)	<a href="#">See Metal Finish Color Options</a>
		Artisan	④ Wood Finish <a href="#">See Artisan Wood Finish Options</a>		

① Solid Surface Model #	② Top Surface Selection	③ Electrical	④ Metal Color
Solid Surface (LKS)	<a href="#">See Solid Surface Top Surface Selection Options</a>	N None CT2 Dual Power Center Top CU2 Dual Power Underside CT2U1 Dual Power Center Top with Underside (See chart above)	<a href="#">See Metal Finish Color Options</a>

Description

Racetrack 3pc Table with Y Base at Working Height

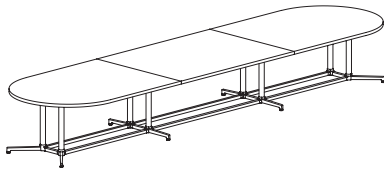

Laminate Tables  
"LKT" Models

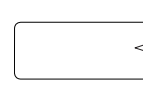

Eased Edge (R3)

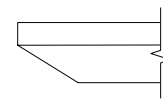

Reverse Bevel Edge (K9)

D	W	H	CTN WT	CU FT	① Model	Eased Edge (R3)		Reverse Bevel Edge (K9)	
						Standard Tier 1	Graded In Tier 2	Standard Tier 1	Graded In Tier 2
60	240	29	636	281	LKT60240-29RKY	\$11,889	\$12,084	\$12,723	\$12,920
60	216	29	584	253	LKT60216-29RKY	\$10,053	\$10,232	\$10,852	\$11,030
54	240	29	561	254	LKT54240-29RKY	\$9,406	\$9,582	\$10,200	\$10,376
54	216	29	515	229	LKT54216-29RKY	\$8,355	\$8,514	\$9,119	\$9,276
48	240	29	517	228	LKT48240-29RKY	\$8,447	\$8,602	\$9,200	\$9,357
48	216	29	474	206	LKT48216-29RKY	\$7,931	\$8,071	\$8,655	\$8,800

LAMINATE

Features:

- price reflects complete table - top and base
- ships KD in multiple cartons
- three piece top
- model includes adjustable glide

Options:

- specify power/charging option, see below for options and upcharges



top shape

LOK - CONFERENCE

To Order Specify

① Laminate Model #	② Edge Detail	③ Laminate Selection	④ PVC Edge Color	⑤ Electrical	⑥ Metal Color
Laminate (LKT)	<a href="#">See Edge Detail Options</a>	<a href="#">See Laminate Selection</a>	<a href="#">See PVC Edge Color Options</a>	N None CT6 Six Power Center Top CU2 Dual Power Underside CT6U2 Six Power Center Top with Underside (See chart on next page)	<a href="#">See Metal Finish Color Options</a>

Model Number Breakdown

LKT60240-29RKY					
LK	T	60240	29	RK	Y
LOK	Laminate	60" x 240"	Height	Racetrack Top Shape	Y base

Description

Racetrack 3pc Table with Y Base at Working Height (continued)

Veneer Tables "LKV" Models

Solid Surface Tables "LKS" Models

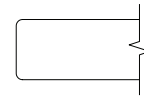

Eased Edge (R3)

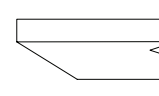

Reverse Bevel Edge (K9)

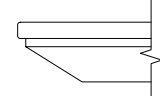

Reverse Bevel Edge (S7)

	D	W	H	CTN WT	CU FT	① Model	Veneer		Solid Surface		
							Essentials	Artisan	Essentials	Artisan	Standard
VENEER	60	240	29	636	281	LKV60240-29RKY	\$18,509	\$19,989	\$20,175	\$21,485	--
	60	216	29	584	253	LKV60216-29RKY	\$16,198	\$17,494	\$17,654	\$18,803	--
	54	240	29	561	254	LKV54240-29RKY	\$15,440	\$16,755	\$16,203	\$17,449	--
	54	216	29	515	229	LKV54216-29RKY	\$13,619	\$14,781	\$14,320	\$15,425	--
	48	240	29	517	228	LKV48240-29RKY	\$13,743	\$14,899	\$14,434	\$15,529	--
	48	216	29	474	206	LKV48216-29RKY	\$12,741	\$13,765	\$13,376	\$14,344	--
SOLID SURFACE	60	240	29	636	281	LKS60240-29RKY	--	--	--	--	\$42,272
	60	216	29	584	253	LKS60216-29RKY	--	--	--	--	\$38,130
	54	240	29	561	254	LKS54240-29RKY	--	--	--	--	\$38,268
	54	216	29	515	229	LKS54216-29RKY	--	--	--	--	\$33,897
	48	240	29	517	228	LKS48240-29RKY	--	--	--	--	\$33,786
	48	216	29	474	206	LKS48216-29RKY	--	--	--	--	\$30,549

Electrical Options and Upcharges

	216 - 240 wide
<b>CT6</b>	
Six Power Center Top - Black	CT6BL - add \$4,949
Six Power Center Top - White	CT6WH - add \$4,949
<b>CU2</b>	
Dual Power Underside - Black	CU2-1C - add \$1,298
Dual Power Underside with 4 Wireless Charging - Black	CU2-1CW - add \$3,278
<b>CT6U2</b>	
Six Power Center Top - Black with Dual Underside	CT6U2-BL - add \$5,748
Six Power Center Top - White with Dual Underside	CT6U2-WH - add \$5,748
Six Power Center Top - Black Dual Underside with 4 Wireless Charging	CT6U2-BLW2 - add \$7,668
Six Power Center Top - White Dual Underside with 4 Wireless Charging	CT6U2-WHW2 - add \$7,668

LOK - CONFERENCE

To Order Specify

Note: Order power infeced that best fits application

① Veneer Model #	② Edge Detail	③ Wood Collection	④ Wood Finish	⑤ Electrical	⑥ Metal Color
Veneer (LKV)	<a href="#">See Edge Detail Options</a>	Essentials	<a href="#">See Essentials Wood Finish Options</a>	N None CT6 Six Power Center Top CU2 Dual Power Underside CT6U2 Six Power Center Top with Underside (See chart above)	<a href="#">See Metal Finish Color Options</a>
		Artisan	④ Wood Finish <a href="#">See Artisan Wood Finish Options</a>		

① Solid Surface Model #	② Top Surface Selection	③ Electrical	④ Metal Color
Solid Surface (LKS)	<a href="#">See Solid Surface Top Surface Selection Options</a>	N None CT6 Six Power Center Top CU2 Dual Power Underside CT6U2 Six Power Center Top with Underside (See chart above)	<a href="#">See Metal Finish Color Options</a>

Description

Racetrack 2pc Table with Y Base at Working Height

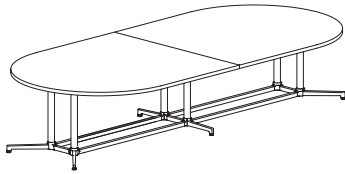

Laminate Tables "LKT" Models

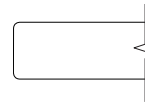

Eased Edge (R3)

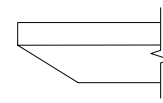

Reverse Bevel Edge (K9)

LAMINATE	D	W	H	CTN WT	CU FT	Model	Standard Tier 1	Graded In Tier 2	Standard Tier 1	Graded In Tier 2
	60	192	29	511	226	LKT60192-29RKY	\$8,183	\$8,341	\$8,945	\$9,102
	60	168	29	449	198	LKT60168-29RKY	\$7,724	\$7,862	\$8,448	\$8,588
60	144	29	315	169	LKT60144-29RKY	\$6,873	\$6,990	\$7,559	\$7,676	
60	120	29	313	143	LKT60120-29RKY	\$6,252	\$6,351	\$6,904	\$7,002	
54	192	29	439	204	LKT54192-29RKY	\$7,907	\$8,049	\$8,632	\$8,776	
54	168	29	343	178	LKT54168-29RKY	\$7,042	\$7,166	\$7,737	\$7,860	
54	144	29	294	154	LKT54144-29RKY	\$6,390	\$6,499	\$7,053	\$7,163	
54	120	29	294	130	LKT54120-29RKY	\$5,867	\$5,954	\$6,497	\$6,587	
48	192	29	403	183	LKT48192-29RKY	\$6,790	\$6,914	\$7,484	\$7,611	
48	168	29	356	161	LKT48168-29RKY	\$6,175	\$6,286	\$6,841	\$6,953	
48	144	29	314	139	LKT48144-29RKY	\$5,608	\$5,703	\$6,250	\$6,344	
48	120	29	273	116	LKT48120-29RKY	\$5,200	\$5,281	\$5,810	\$5,893	
48	108	29	250	105	LKT48108-29RKY	\$4,572	\$4,644	\$5,167	\$5,241	

Features:

- price reflects complete table - top and base
- ships KD in multiple cartons
- two piece top
- model includes adjustable glide

Options:

- specify power/charging option, see below for options and upcharges



top shape

Electrical Options and Upcharges

	108 wide	120 - 192 wide
<b>CT2</b>		
Dual Power Center Top - Black	CT2BL - add \$1,837	n/a
Dual Power Center Top - White	CT2WH - add \$1,837	n/a
<b>CU1</b>		
Single Power Underside - Black	CU1-1C - add \$731	CU1-1C - add \$849
Single Power Underside with Wireless Charging - Black	CU1-1CW - add \$1,691	CU1-1CW - add \$1,776
<b>CT2U1</b>		
Dual Power Center Top - Black with Underside	CT2U1-BL - add \$2,235	n/a
Dual Power Center Top - White with Underside	CT2U1-WH - add \$2,235	n/a
Dual Power Center Top - Black with Wireless Charging	CT2U1-BLW2 - add \$3,194	n/a
Dual Power Center Top - White with Wireless Charging	CT2U1-WHW2 - add \$3,194	n/a

Note: Order power infeed that best fits application.

	108 wide	120 - 192 wide
<b>CT4U1</b>		
Four Power Center Top with Single Underside - Black	n/a	CT4U1-BL - add \$3,906
Four Power Center Top with Single Underside - White	n/a	CT4U1-WH - add \$3,906
Four Power Center Top - Black with Underside & Wireless Charging	n/a	CT4U1-BLW2 - add \$4,840
Four Power Center Top - White with Underside & Wireless Charging	n/a	CT4U1-WHW2 - add \$4,840
<b>CT4</b>		
Four Power Center Top - Black	n/a	CT4BL - add \$3,421
Four Power Center Top - White	n/a	CT4WH - add \$3,421

To Order Specify

1 Laminate Model #	2 Edge Detail	3 Laminate Selection	3a PVC Edge Color	4 Electrical	5 Metal Color
Laminate (LKT)	<a href="#">See Edge Detail Options</a>	<a href="#">See Laminate Selection</a>	<a href="#">See PVC Edge Color Options</a>	N None CT2 Dual Power Center Top CU2 Dual Power Underside CT2U1 Dual Power Center Top with Underside CT4U2 Four Power Center Top with Underside CT4 Four Power Center Top (See chart above)	<a href="#">See Metal Finish Color Options</a>

Model Number Breakdown

LKT60192-29RKY					
LK	T	60192	29	RK	Y
LOK	Laminate	60" x 192"	Height	Racetrack Top Shape	Y base

Description

Racetrack 2pc Table with Y  
Base at Working Height  
(continued)

Veneer Tables  
"LKV" Models

Solid Surface Tables  
"LKS" Models

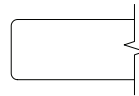

Eased Edge (R3)

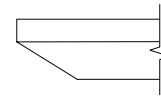

Reverse Bevel Edge (K9)

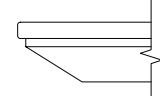

Reverse Bevel Edge (S7)

	D	W	H	CTN WT	CU FT	① Model	Veneer Tables		Solid Surface Tables			
							Essentials	Artisan	Essentials	Artisan	Standard	
VENEER	60	192	29	511	226	LKV60192-29RKY	\$14,137	\$15,268	\$15,407	\$16,408	--	
	60	168	29	449	198	LKV60168-29RKY	\$11,877	\$12,825	\$12,946	\$13,787	--	
	60	144	29	315	169	LKV60144-29RKY	\$10,452	\$11,288	\$11,392	\$12,133	--	
	60	120	29	313	143	LKV60120-29RKY	\$9,449	\$10,204	\$10,300	\$10,970	--	
	54	192	29	439	204	LKV54192-29RKY	\$11,844	\$12,790	\$12,907	\$13,746	--	
	54	168	29	343	178	LKV54168-29RKY	\$10,667	\$11,522	\$11,628	\$12,383	--	
	54	144	29	294	154	LKV54144-29RKY	\$9,563	\$10,325	\$10,421	\$11,099	--	
	54	120	29	294	130	LKV54120-29RKY	\$8,654	\$9,344	\$9,433	\$10,045	--	
	48	192	29	403	183	LKV48192-29RKY	\$10,492	\$11,389	\$11,078	\$11,921	--	
	48	168	29	356	161	LKV48168-29RKY	\$9,433	\$10,208	\$9,968	\$10,694	--	
	48	144	29	314	139	LKV48144-29RKY	\$8,473	\$9,127	\$8,958	\$9,571	--	
	48	120	29	273	116	LKV48120-29RKY	\$7,749	\$8,283	\$8,182	\$8,684	--	
	48	108	29	250	105	LKV48108-29RKY	\$6,581	\$7,102	\$7,168	\$7,635	--	
	SOLID SURFACE	60	192	29	511	226	LKS60192-29RKY	--	--	--	--	\$31,653
		60	168	29	449	198	LKS60168-29RKY	--	--	--	--	\$28,074
		60	144	29	315	169	LKS60144-29RKY	--	--	--	--	\$24,055
60		120	29	313	143	LKS60120-29RKY	--	--	--	--	\$26,680	
54		192	29	439	204	LKS54192-29RKY	--	--	--	--	\$28,815	
54		168	29	343	178	LKS54168-29RKY	--	--	--	--	\$25,410	
54		144	29	294	154	LKS54144-29RKY	--	--	--	--	\$21,999	
54		120	29	294	130	LKS54120-29RKY	--	--	--	--	\$18,862	
48		192	29	403	183	LKS48192-29RKY	--	--	--	--	\$25,911	
48		168	29	356	161	LKS48168-29RKY	--	--	--	--	\$22,772	
48		144	29	314	139	LKS48144-29RKY	--	--	--	--	\$19,794	
48		120	29	273	116	LKS48120-29RKY	--	--	--	--	\$17,116	
48		108	29	250	105	LKS48108-29RKY	--	--	--	--	\$15,881	

LOK- CONFERENCE

To Order Specify

① Veneer Model #	② Edge Detail	③ Wood Collection	④ Wood Finish	⑤ Electrical	⑥ Metal Color
Veneer (LKV)	<a href="#">See Edge Detail Options</a>	Essentials	<a href="#">See Essentials Wood Finish Options</a>	N None CT2 Dual Power Center Top CU2 Dual Power Underside CT2U1 Dual Power Center Top with Underside CT4U2 Four Power Center Top with Underside CT4 Four Power Center Top (See chart on previous page)	<a href="#">See Metal Finish Color Options</a>
		Artisan	④ Wood Finish <a href="#">See Artisan Wood Finish Options</a>		

① Solid Surface Model #	② Top Surface Selection	③ Electrical	④ Metal Color
Solid Surface (LKS)	<a href="#">See Solid Surface Top Surface Selection Options</a>	N None CT2 Dual Power Center Top CU2 Dual Power Underside CT2U1 Dual Power Center Top with Underside CT4U2 Four Power Center Top with Underside CT4 Four Power Center Top (See chart on previous page)	<a href="#">See Metal Finish Color Options</a>

Description

Racetrack Table with Y Base at Working Height

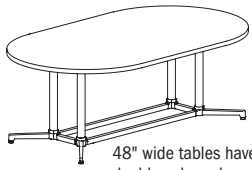

48" wide tables have double column base

Laminate Tables "LKT" Models

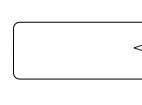

Eased Edge (R3)

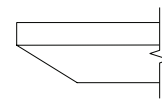

Reverse Bevel Edge (K9)

LAMINATE	D	W	H	CTN WT	CU FT	Model	Eased Edge (R3)		Reverse Bevel Edge (K9)	
							Standard Tier 1	Graded In Tier 2	Standard Tier 1	Graded In Tier 2
		48	96	29	207	105	LKT4896-29RKY	\$3,898	\$3,960	\$4,479
	48	84	29	315	83	LKT4884-29RKY	\$3,421	\$3,476	\$3,988	\$4,046
	42	96	29	161	83	LKT4296-29RKY	\$3,712	\$3,767	\$4,276	\$4,335
	42	84	29	161	72	LKT4284-29RKY	\$3,109	\$3,157	\$3,664	\$3,715
	36	96	29	150	72	LKT3696-29RKY	\$2,973	\$3,019	\$3,523	\$3,570
	36	84	29	146	64	LKT3684-29RKY	\$2,717	\$2,760	\$3,258	\$3,300

Features:

- price reflects complete table - top and base
- ships KD in multiple cartons
- one piece top
- model includes adjustable glide

Options:

- specify power/charging option, see below for options and upcharges

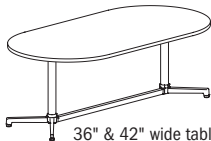

36" & 42" wide tables have single column base



top shape

LOK - CONFERENCE

To Order Specify

1 Laminite Model #	2 Edge Detail	3 Laminite Selection	3a PVC Edge Color	4 Electrical	5 Metal Color
Laminite (LKT)	<a href="#">See Edge Detail Options</a>	<a href="#">See Laminite Selection</a>	<a href="#">See PVC Edge Color Options</a>	N None CT2 Dual Power Center Top CU2 Dual Power Underside CT2U1 Dual Power Center Top with Underside (See chart on next page)	<a href="#">See Metal Finish Color Options</a>

Model Number Breakdown

LKT4896-29RKY					
LK	T	4896	29	RK	Y
LOK	Laminite	48" x 96"	Height	Racetrack Top Shape	Y base

Description

Racetrack Table with Y Base  
at Working Height  
(continued)

Veneer Tables  
"LKV" Models

Solid Surface Tables  
"LKS" Models

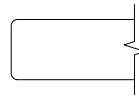

Eased Edge (R3)

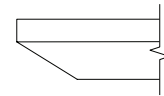

Reverse Bevel Edge (K9)

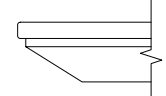

Reverse Bevel Edge (S7)

	D	W	H	CTN WT	CU FT	① Model	Veneer Tables "LKV" Models		Solid Surface Tables "LKS" Models		
							Essentials	Artisan	Essentials	Artisan	Standard
VENEER	48	96	29	207	105	LKV4896-29RKY	\$5,426	\$5,842	\$5,806	\$6,196	--
	48	84	29	315	83	LKV4884-29RKY	\$4,895	\$5,254	\$5,250	\$5,585	--
	42	96	29	161	83	LKV4296-29RKY	\$5,500	\$5,939	\$5,994	\$6,385	--
	42	84	29	161	72	LKV4284-29RKY	\$4,678	\$5,051	\$5,098	\$5,430	--
	36	96	29	150	72	LKV3696-29RKY	\$4,017	\$4,339	\$4,380	\$4,663	--
	36	84	29	146	64	LKV3684-29RKY	\$3,758	\$4,058	\$4,094	\$4,359	--
SOLID SURFACE	48	96	29	207	105	LKS4896-29RKY	--	--	--	--	\$12,669
	48	84	29	315	83	LKS4884-29RKY	--	--	--	--	\$11,183
	42	96	29	161	83	LKS4296-29RKY	--	--	--	--	\$10,528
	42	84	29	161	72	LKS4284-29RKY	--	--	--	--	\$9,321
	36	96	29	150	72	LKS3696-29RKY	--	--	--	--	\$9,052
	36	84	29	146	64	LKS3684-29RKY	--	--	--	--	\$8,223

Electrical Options and Upcharges

CT2	84 - 96 wide
Dual Power Center Top - Black	CT2BL - add \$1,837
Dual Power Center Top - White	CT2WH - add \$1,837
CU1	
Single Power Underside - Black	CU1-1C - add \$731
Single Power Underside with Wireless Charging - Black	CU1-1CW - add \$1,691
CT2U1	
Dual Power Center Top - Black with Single Underside	CT2U1-BL - add \$2,235
Dual Power Center Top - White with Single Underside	CT2U1-WH - add \$2,235
Dual Power Center Top - Black with Wireless Charging	CT2U1-BLW2 - add \$3,194
Dual Power Center Top - White with Wireless Charging	CT2U1-WHW2 - add \$3,194

LOK - CONFERENCE

Note: Order power infeed that best fits application

To Order Specify

① Veneer Model #	② Edge Detail	③ Wood Collection	④ Wood Finish	⑤ Electrical	⑥ Metal Color
Veneer (LKV)	<a href="#">See Edge Detail Options</a>	Essentials	<a href="#">See Essentials Wood Finish Options</a>	N None CT2 Dual Power Center Top CU2 Dual Power Underside CT2U1 Dual Power Center Top with Underside (See chart above)	<a href="#">See Metal Finish Color Options</a>
		Artisan	④ Wood Finish <a href="#">See Artisan Wood Finish Options</a>		

① Solid Surface Model #	② Top Surface Selection	③ Electrical	④ Metal Color
Solid Surface (LKS)	<a href="#">See Solid Surface Top Surface Selection Options</a>	N None CT2 Dual Power Center Top CU2 Dual Power Underside CT2U1 Dual Power Center Top with Underside (See chart above)	<a href="#">See Metal Finish Color Options</a>

Description

Oval 2pc Table with Y Base at Working Height

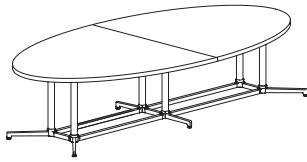

Laminate Tables "LKT" Models

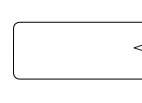

Eased Edge (R3)

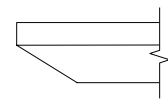

Reverse Bevel Edge (K9)

LAMINATE	D	W	H	CTN WT	CU FT	Model	Eased Edge (R3)		Reverse Bevel Edge (K9)	
							Standard Tier 1	Graded In Tier 2	Standard Tier 1	Graded In Tier 2
	60	120	29	294	130	LKT60120-290VY	\$6,200	\$6,298	\$6,851	\$6,951
54	108	29	222	117	LKT54108-290VY	\$4,858	\$4,937	\$5,471	\$5,552	

Features:

- price reflects complete table - top and base
- ships KD in multiple cartons
- two piece top
- model includes adjustable glide

Options:

- specify power/charging option, see below for options and upcharges

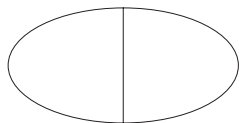

top shape

LOK - CONFERENCE

To Order Specify

1 Laminate Model #	2 Edge Detail	3 Laminate Selection	3a PVC Edge Color	4 Electrical	5 Metal Color
Laminate (LKT)	<a href="#">See Edge Detail Options</a>	<a href="#">See Laminate Selection</a>	<a href="#">See PVC Edge Color Options</a>	N None CT2 Dual Power Center Top CU2 Dual Power Underside CT2U1 Dual Power Center Top with Underside CT4U2 Four Power Center Top with Underside CT4 Four Power Center Top (See chart above)	<a href="#">See Metal Finish Color Options</a>

Model Number Breakdown

LKT60120-290VY					
LK	T	60120	29	OV	Y
LOK	Laminate	60" x 120"	Height	Oval Top Shape	Y base

Description

Oval 2pc Table with Y Base at Working Height (continued)

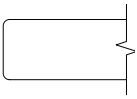
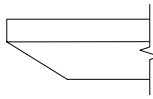
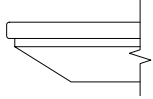
		Veneer Tables "LKV" Models				Solid Surface Tables "LKS" Models					
		 <p>Eased Edge (R3)</p>		 <p>Reverse Bevel Edge (K9)</p>		 <p>Reverse Bevel Edge (S7)</p>					
	D	W	H	CTN WT	CU FT	Model	Essentials	Artisan	Essentials	Artisan	Standard
VENEER	60	120	29	294	130	LKV60120-290VY	\$9,380	\$10,129	\$10,222	\$10,888	--
	54	108	29	222	117	LKV54108-290VY	\$7,287	\$7,833	\$7,725	\$8,237	--
SOL. SURF.	60	120	29	294	130	LKS60120-290VY	--	--	--	--	\$26,607
	54	108	29	222	117	LKS54108-290VY	--	--	--	--	\$21,480

Electrical Options and Upcharges

CT2	108 wide	120 - 192 wide
Dual Power Center Top - Black	CT2BL - add \$1,837	n/a
Dual Power Center Top - White	CT2WH - add \$1,837	n/a
CU1		
Single Power Underside - Black	CU1-1C - add \$731	CU1-1C - add \$849
Single Power Underside with Wireless Charging - Black	CU1-1CW - add \$1,691	CU1-1CW - add \$1,776
CT2U1		
Dual Power Center Top - Black with Underside	CT2U1-BL - add \$2,235	n/a
Dual Power Center Top - White with Underside	CT2U1-WH - add \$2,235	n/a
Dual Power Center Top - Black with Wireless Charging	CT2U1-BLW2 - add \$3,194	n/a
Dual Power Center Top - White with Wireless Charging	CT2U1-WHW2 - add \$3,194	n/a

CT4U1	108 wide	120 - 192 wide
Four Power Center Top with Single Underside - Black	n/a	CT4U1-BL - add \$3,906
Four Power Center Top with Single Underside - White	n/a	CT4U1-WH - add \$3,906
Four Power Center Top - Black with Underside & Wireless Charging	n/a	CT4U1-BLW2 - add \$4,840
Four Power Center Top - White with Underside & Wireless Charging	n/a	CT4U1-WHW2 - add \$4,840
CT4		
Four Power Center Top - Black	n/a	CT4BL - add \$3,421
Four Power Center Top - White	n/a	CT4WH - add \$3,421

Note: Order power infed that best fits application, see page 408.

To Order Specify

1 Veneer Model #	2 Edge Detail	3 Wood Collection	4 Wood Finish	5 Electrical	6 Metal Color
Veneer (LKV)	<a href="#">See Edge Detail Options</a>	Essentials	<a href="#">See Essentials Wood Finish Options</a>	N None CT2 Dual Power Center Top CU2 Dual Power Underside CT2U1 Dual Power Center Top with Underside CT4U2 Four Power Center Top with Underside CT4 Four Power Center Top (See chart on previous page)	<a href="#">See Metal Finish Color Options</a>
		Artisan	4 Wood Finish <a href="#">See Artisan Wood Finish Options</a>		

1 Solid Surface Model #	2 Top Surface Selection	3 Electrical	4 Metal Color
Solid Surface (LKS)	<a href="#">See Solid Surface Top Surface Selection Options</a>	N None CT2 Dual Power Center Top CU2 Dual Power Underside CT2U1 Dual Power Center Top with Underside CT4U2 Four Power Center Top with Underside CT4 Four Power Center Top (See chart on previous page)	<a href="#">See Metal Finish Color Options</a>

LOK - CONFERENCE

Description

Oval Table with Y Base at Working Height

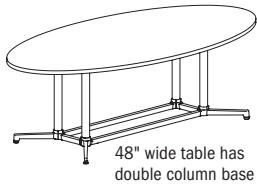

Laminate Tables "LKT" Models

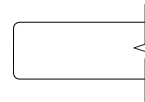

Eased Edge (R3)

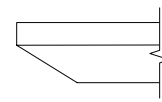

Reverse Bevel Edge (K9)

LAMINATE	D	W	H	CTN WT	CU FT	1 Model	Eased Edge (R3)		Reverse Bevel Edge (K9)	
							Standard Tier 1	Graded In Tier 2	Standard Tier 1	Graded In Tier 2
	48	96	29	186	105	LKT4896-290VY	\$3,809	\$3,874	\$4,391	\$4,454
42	84	29	147	72	LKT4284-290VY	\$3,109	\$3,157	\$3,664	\$3,715	

Features:

- price reflects complete table - top and base
- ships KD in multiple cartons
- one piece top
- model includes adjustable glide

Options:

- specify power/charging option, see below for options and upcharges

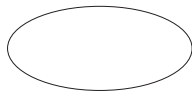
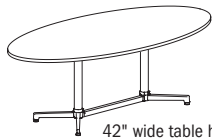

top shape

LOK - CONFERENCE

To Order Specify

1 Laminite Model #	2 Edge Detail	3 Laminite Selection	3a PVC Edge Color	4 Electrical	5 Metal Color
Laminite (LKT)	<a href="#">See Edge Detail Options</a>	<a href="#">See Laminite Selection</a>	<a href="#">See PVC Edge Color Options</a>	N None CT2 Dual Power Center Top CU2 Dual Power Underside CT2U1 Dual Power Center Top with Underside (See chart on next page)	<a href="#">See Metal Finish Color Options</a>

Model Number Breakdown

LKT4896-290VY					
LK	T	4896	29	OV	Y
LOK	Laminite	48" x 96"	Height	Oval Top Shape	Y base

Description

Oval Table with Y Base at Working Height (continued)

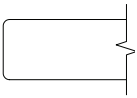
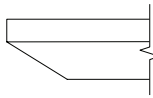
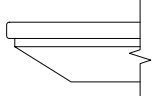
		Veneer Tables "LKV" Models				Solid Surface Tables "LKS" Models					
		 <p>Eased Edge (R3)</p>		 <p>Reverse Bevel Edge (K9)</p>		 <p>Reverse Bevel Edge (S7)</p>					
	D	W	H	CTN WT	CU FT	Model	Essentials	Artisan	Essentials	Artisan	Standard
VENEER	48	96	29	186	105	LKV4896-290VY	\$5,313	\$5,729	\$5,693	\$6,083	--
	42	84	29	147	72	LKV4284-290VY	\$4,678	\$5,051	\$5,098	\$5,430	--
SOL SURF	48	96	29	186	105	LKS4896-290VY	--	--	--	--	\$12,556
	42	84	29	147	72	LKS4284-290VY	--	--	--	--	\$9,321

Electrical Options and Upcharges

CT2	84 - 96 wide
Dual Power Center Top - Black	CT2BL - add \$1,837
Dual Power Center Top - White	CT2WH - add \$1,837
CU1	
Single Power Underside - Black	CU1-1C - add \$731
Single Power Underside with Wireless Charging - Black	CU1-1CW - add \$1,691
CT2U1	
Dual Power Center Top - Black with Single Underside	CT2U1-BL - add \$2,235
Dual Power Center Top - White with Single Underside	CT2U1-WH - add \$2,235
Dual Power Center Top - Black with Wireless Charging	CT2U1-BLW2 - add \$3,194
Dual Power Center Top - White with Wireless Charging	CT2U1-WHW2 - add \$3,194

LOK - CONFERENCE

Note: Order power infeed that best fits application

To Order Specify

1 Veneer Model #	2 Edge Detail	3 Wood Collection	4 Wood Finish	5 Electrical	6 Metal Color
Veneer (LKV)	<a href="#">See Edge Detail Options</a>	Essentials	<a href="#">See Essentials Wood Finish Options</a>	N None CT2 Dual Power Center Top CU2 Dual Power Underside CT2U1 Dual Power Center Top with Underside (See chart above)	<a href="#">See Metal Finish Color Options</a>
		Artisan	4 Wood Finish <a href="#">See Artisan Wood Finish Options</a>		
1 Solid Surface Model #	2 Top Surface Selection	3 Electrical		4 Metal Color	
Solid Surface (LKS)	<a href="#">See Solid Surface Top Surface Selection Options</a>	N None CT2 Dual Power Center Top CU2 Dual Power Underside (See chart above) CT2U1 Dual Power Center Top with Underside		<a href="#">See Metal Finish Color Options</a>	

Description

Boat 3pc Table with T Base at Working Height

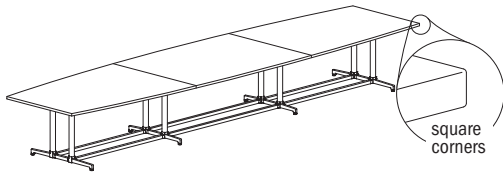

Laminate Tables "LKT" Models

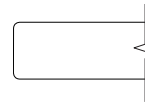

Eased Edge (R3)

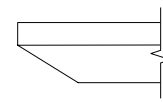

Reverse Bevel Edge (K9)

D	W	H	CTN WT	CU FT	Model	Eased Edge (R3)		Reverse Bevel Edge (K9)	
						Standard Tier 1	Graded In Tier 2	Standard Tier 1	Graded In Tier 2
60	240	29	636	281	LKT60240-29BTT	\$12,271	\$12,471	\$13,108	\$13,305
60	216	29	584	253	LKT60216-29BTT	\$10,460	\$10,636	\$11,260	\$11,438
54	240	29	586	254	LKT54240-29BTT	\$9,900	\$10,074	\$10,693	\$10,870
54	216	29	538	229	LKT54216-29BTT	\$9,309	\$9,470	\$10,073	\$10,232
48	240	29	534	228	LKT48240-29BTT	\$9,429	\$9,588	\$10,183	\$10,339
48	216	29	538	206	LKT48216-29BTT	\$8,341	\$8,484	\$9,068	\$9,210

Features:

- price reflects complete table - top and base
- ships KD in multiple cartons
- three piece top
- model includes adjustable glide

Options:

- specify power/charging option, see below for options and upcharges



top shape

LOK - CONFERENCE

To Order Specify

1 Laminate Model #	2 Edge Detail	3 Laminate Selection	4 PVC Edge Color	4 Electrical	5 Metal Color
Laminate (LKT)	<a href="#">See Edge Detail Options</a>	<a href="#">See Laminate Selection</a>	<a href="#">See PVC Edge Color Options</a>	N None CT6 Six Power Center Top CU2 Dual Power Underside CT6U2 Six Power Center Top with Underside (See chart on next page)	<a href="#">See Metal Finish Color Options</a>

Model Number Breakdown

LKT60240-29BTT					
LK	T	60240	29	BT	T
LOK	Laminate	60" x 240"	Height	Boat Top Shape	T base

Description

Boat 3pc Table with T Base  
at Working Height  
(continued)

Veneer Tables  
"LKV" Models

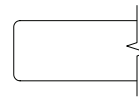

Eased Edge (R3)

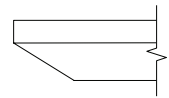

Reverse Bevel Edge (K9)

D	W	H	CTN WT	CU FT	① Model	Eased Edge (R3)		Reverse Bevel Edge (K9)		
						Essentials	Artisan	Essentials	Artisan	
60	240	29	636	281	LKV60240-29BTT	\$19,086	\$20,613	\$20,803	\$22,155	
60	216	29	584	253	LKV60216-29BTT	\$16,800	\$18,143	\$18,311	\$19,502	
VENEER	54	240	29	586	254	LKV54240-29BTT	\$16,169	\$17,479	\$16,932	\$18,176
	54	216	29	538	229	LKV54216-29BTT	\$15,005	\$16,169	\$15,705	\$16,809
	48	240	29	534	228	LKV48240-29BTT	\$15,170	\$16,325	\$15,864	\$16,954
	48	216	29	538	206	LKV48216-29BTT	\$13,324	\$14,350	\$13,964	\$14,932

Electrical Options and Upcharges

	216 - 240 wide
<b>CT6</b>	
Six Power Center Top - Black	CT6BL - add \$4,949
Six Power Center Top - White	CT6WH - add \$4,949
<b>CU2</b>	
Dual Power Underside - Black	CU2-1C - add \$1,298
Dual Power Underside with 4 Wireless Charging - Black	CU2-1CW - add \$3,278
<b>CT6U2</b>	
Six Power Center Top - Black with Dual Underside	CT6U2-BL - add \$5,748
Six Power Center Top - White with Dual Underside	CT6U2-WH - add \$5,748
Six Power Center Top - Black Dual Underside with 4 Wireless Charging	CT6U2-BLW2 - add \$7,668
Six Power Center Top - White Dual Underside with 4 Wireless Charging	CT6U2-WHW2 - add \$7,668

Note: Order power infeed that best fits application

To Order Specify

① Veneer Model #	② Edge Detail	③ Wood Collection	④ Wood Finish	⑤ Electrical	⑥ Metal Color
Veneer (LKV)	<a href="#">See Edge Detail Options</a>	Essentials	<a href="#">See Essentials Wood Finish Options</a>	N None CT6 Six Power Center Top CU2 Dual Power Underside CT6U2 Six Power Center Top with Underside (See chart above)	<a href="#">See Metal Finish Color Options</a>
		Artisan	<b>④ Wood Finish</b> <a href="#">See Artisan Wood Finish Options</a>		

LOK - CONFERENCE

Description

Boat 2pc Table with T Base at Working Height

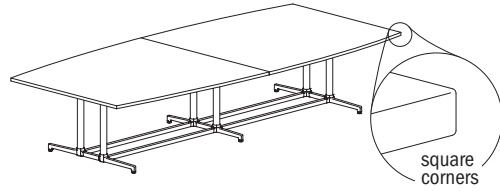

Laminate Tables "LKT" Models

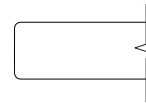

Eased Edge (R3)

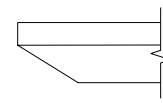

Reverse Bevel Edge (K9)

D	W	H	CTN WT	CU FT	Model	Eased Edge (R3)		Reverse Bevel Edge (K9)	
						Standard Tier 1	Graded In Tier 2	Standard Tier 1	Graded In Tier 2
60	192	29	511	226	LKT60192-29BTT	\$8,547	\$8,708	\$9,307	\$9,465
60	168	29	449	198	LKT60168-29BTT	\$7,977	\$8,115	\$8,699	\$8,838
60	144	29	395	169	LKT60144-29BTT	\$7,360	\$7,478	\$8,048	\$8,165
60	120	29	342	143	LKT60120-29BTT	\$6,526	\$6,623	\$7,176	\$7,275
54	192	29	459	204	LKT54192-29BTT	\$8,133	\$8,277	\$8,861	\$9,004
54	168	29	377	178	LKT54168-29BTT	\$7,367	\$7,493	\$8,065	\$8,187
54	144	29	365	154	LKT54144-29BTT	\$6,787	\$6,895	\$7,452	\$7,558
54	120	29	316	130	LKT54120-29BTT	\$6,081	\$6,169	\$6,708	\$6,798
48	192	29	419	183	LKT48192-29BTT	\$7,097	\$7,224	\$7,793	\$7,918
48	168	29	377	161	LKT48168-29BTT	\$6,598	\$6,708	\$7,264	\$7,375
48	144	29	334	139	LKT48144-29BTT	\$6,053	\$6,147	\$6,691	\$6,787
48	120	29	290	116	LKT48120-29BTT	\$5,439	\$5,518	\$6,051	\$6,130
48	108	29	268	105	LKT48108-29BTT	\$4,609	\$4,678	\$5,202	\$5,274

LAMINATE

Features:

- price reflects complete table - top and base
- ships KD in multiple cartons
- two piece top
- model includes adjustable glide

Options:

- specify power/charging option, see below for options and upcharges



top shape

LOK - CONFERENCE

To Order Specify

1 Laminate Model #	2 Edge Detail	3 Laminate Selection	3a PVC Edge Color	4 Electrical	5 Metal Color
Laminate (LKT)	<a href="#">See Edge Detail Options</a>	<a href="#">See Laminate Selection</a>	<a href="#">See PVC Edge Color Options</a>	N None CT2 Dual Power Center Top CU2 Dual Power Underside CT2U1 Dual Power Center Top with Underside CT4U2 Four Power Center Top with Underside CT4 Four Power Center Top (See chart on next page)	<a href="#">See Metal Finish Color Options</a>

Model Number Breakdown

LKT60192-29BTT					
LK	T	60192	29	BT	T
LOK	Laminate	60" x 192"	Height	Boat Top Shape	T base

Description

Boat 2pc Table with  
T Base at Working Height  
(continued)

Veneer Tables  
"LKV" Models

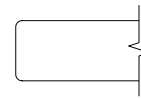

Eased Edge (R3)

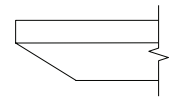

Reverse Bevel Edge (K9)

D	W	H	CTN WT	CU FT	① Model	Eased Edge (R3)		Reverse Bevel Edge (K9)		
						Essentials	Artisan	Essentials	Artisan	
60	192	29	511	226	LKV60192-29BTT	\$13,301	\$14,366	\$14,497	\$15,439	
60	168	29	449	198	LKV60168-29BTT	\$12,235	\$13,213	\$13,335	\$14,202	
60	144	29	395	169	LKV60144-29BTT	\$11,137	\$12,028	\$12,138	\$12,928	
60	120	29	342	143	LKV60120-29BTT	\$9,827	\$10,613	\$10,712	\$11,405	
VENEER	54	192	29	459	204	LKV54192-29BTT	\$12,166	\$13,143	\$13,263	\$14,122
	54	168	29	377	178	LKV54168-29BTT	\$11,127	\$12,018	\$12,128	\$12,916
	54	144	29	365	154	LKV54144-29BTT	\$10,106	\$10,914	\$11,017	\$11,730
	54	120	29	316	130	LKV54120-29BTT	\$8,944	\$9,658	\$9,747	\$10,378
48	192	29	419	183	LKV48192-29BTT	\$10,927	\$11,822	\$11,511	\$12,356	
48	168	29	377	161	LKV48168-29BTT	\$10,017	\$10,790	\$10,549	\$11,281	
48	144	29	334	139	LKV48144-29BTT	\$9,072	\$9,725	\$9,556	\$10,170	
48	120	29	290	116	LKV48120-29BTT	\$8,065	\$8,601	\$8,500	\$9,003	
48	108	29	268	105	LKV48108-29BTT	\$6,622	\$7,152	\$7,217	\$7,685	

Electrical Options and Upcharges

	108 wide	120 - 192 wide
<b>CT2</b>		
Dual Power Center Top - Black	CT2BL - add \$1,837	n/a
Dual Power Center Top - White	CT2WH - add \$1,837	n/a
<b>CU1</b>		
Single Power Underside - Black	CU1-1C - add \$731	CU1-1C - add \$849
Single Power Underside with Wireless Charging - Black	CU1-1CW - add \$1,691	CU1-1CW - add \$1,776
<b>CT2U1</b>		
Dual Power Center Top - Black with Underside	CT2U1-BL - add \$2,235	n/a
Dual Power Center Top - White with Underside	CT2U1-WH - add \$2,235	n/a
Dual Power Center Top - Black with Wireless Charging	CT2U1-BLW2 - add \$3,194	n/a
Dual Power Center Top - White with Wireless Charging	CT2U1-WHW2 - add \$3,194	n/a

	108 wide	120 - 192 wide
<b>CT4U1</b>		
Four Power Center Top with Single Underside - Black	n/a	CT4U1-BL - add \$3,906
Four Power Center Top with Single Underside - White	n/a	CT4U1-WH - add \$3,906
Four Power Center Top - Black with Underside & Wireless Charging	n/a	CT4U1-BLW2 - add \$4,840
Four Power Center Top - White with Underside & Wireless Charging	n/a	CT4U1-WHW2 - add \$4,840
<b>CT4</b>		
Four Power Center Top - Black	n/a	CT4BL - add \$3,421
Four Power Center Top - White	n/a	CT4WH - add \$3,421

Note: Order power infeed that best fits application

To Order Specify

① Veneer Model #	② Edge Detail	③ Wood Collection	④ Wood Finish	⑤ Electrical	⑥ Metal Color
Veneer (LKV)	<a href="#">See Edge Detail Options</a>	Essentials	<a href="#">See Essentials Wood Finish Options</a>	N None CT2 Dual Power Center Top CU2 Dual Power Underside CT2U1 Dual Power Center Top with Underside CT4U2 Four Power Center Top with Underside CT4 Four Power Center Top	<a href="#">See Metal Finish Color Options</a>
		Artisan	④ Wood Finish <a href="#">See Artisan Wood Finish Options</a>		

LOK- CONFERENCE

Description

Boat Table with T Base at Working Height

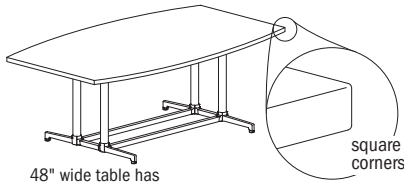

48" wide table has double column base

Laminate Tables "LKT" Models

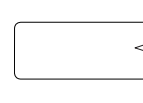

Eased Edge (R3)

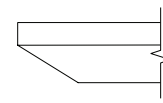

Reverse Bevel Edge (K9)

LAMINATE

D	W	H	CTN WT	CU FT	Model	Eased Edge (R3)		Reverse Bevel Edge (K9)	
						Standard Tier 1	Graded In Tier 2	Standard Tier 1	Graded In Tier 2
48	96	29	219	83	LKT4896-29BTT	\$3,875	\$3,936	\$4,456	\$4,521
48	84	29	198	83	LKT4884-29BTT	\$3,439	\$3,498	\$4,007	\$4,062
42	96	29	177	73	LKT4296-29BTT	\$3,517	\$3,572	\$4,084	\$4,138
42	84	29	158	72	LKT4284-29BTT	\$2,897	\$2,947	\$3,455	\$3,503
36	96	29	156	72	LKT3696-29BTT	\$2,957	\$3,007	\$3,510	\$3,557
36	84	29	146	64	LKT3684-29BTT	\$2,655	\$2,694	\$3,194	\$3,238

Features:

- price reflects complete table - top and base
- ships KD in multiple cartons
- one piece top
- model includes adjustable glide

Options:

- specify power/charging option, see below for options and upcharges

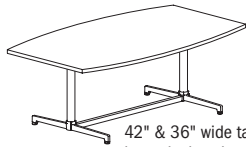

42" & 36" wide tables have single column base



top shape

LOK - CONFERENCE

To Order Specify

1 Laminate Model #	2 Edge Detail	3 Laminate Selection	3a PVC Edge Color	4 Electrical	5 Metal Color
Laminate (LKT)	<a href="#">See Edge Detail Options</a>	<a href="#">See Laminate Selection</a>	<a href="#">See PVC Edge Color Options</a>	N None CT2 Dual Power Center Top CU2 Dual Power Underside CT2U1 Dual Power Center Top with Underside (See chart on next page)	<a href="#">See Metal Finish Color Options</a>

Model Number Breakdown

LKT4896-29BTT					
LK	T	4896	29	BT	T
LOK	Laminate	48" x 96"	Height	Boat Top Shape	T base

Description

Boat Table with T Base at Working Height (continued)

Veneer Tables "LKV" Models

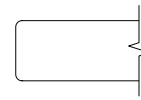

Eased Edge (R3)

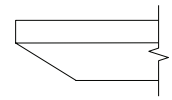

Reverse Bevel Edge (K9)

D	W	H	CTN WT	CU FT	① Model	Eased Edge (R3)		Reverse Bevel Edge (K9)	
						Essentials	Artisan	Essentials	Artisan
48	96	29	219	83	LKV4896-29BTT	\$5,395	\$5,810	\$5,776	\$6,168
48	84	29	198	83	LKV4884-29BTT	\$4,922	\$5,281	\$5,276	\$5,610
42	96	29	177	73	LKV4296-29BTT	\$5,256	\$5,678	\$5,729	\$6,100
	84	29	158	72	LKV4284-29BTT	\$4,419	\$4,771	\$4,817	\$5,131
36	96	29	156	72	LKV3696-29BTT	\$4,001	\$4,320	\$4,359	\$4,644
36	84	29	146	64	LKV3684-29BTT	\$3,682	\$3,973	\$4,012	\$4,270

VENEER

Electrical Options and Upcharges

CT2	84 - 96 wide
Dual Power Center Top - Black	CT2BL - add \$1,837
Dual Power Center Top - White	CT2WH - add \$1,837
CU1	
Single Power Underside - Black	CU1-1C - add \$731
Single Power Underside with Wireless Charging - Black	CU1-1CW - add \$1,691
CT2U1	
Dual Power Center Top - Black with Single Underside	CT2U1-BL - add \$2,235
Dual Power Center Top - White with Single Underside	CT2U1-WH - add \$2,235
Dual Power Center Top - Black with Wireless Charging	CT2U1-BLW2 - add \$3,194
Dual Power Center Top - White with Wireless Charging	CT2U1-WHW2 - add \$3,194

Note: Order power infed that best fits application

To Order Specify

① Veneer Model #	② Edge Detail	③ Wood Collection	④ Wood Finish	⑤ Electrical	⑥ Metal Color
Veneer (LKV)	<a href="#">See Edge Detail Options</a>	Essentials	<a href="#">See Essentials Wood Finish Options</a>	N None CT2 Dual Power Center Top CU2 Dual Power Underside CT2U1 Dual Power Center Top with Underside (See chart above)	<a href="#">See Metal Finish Color Options</a>
		Artisan	④ Wood Finish <a href="#">See Artisan Wood Finish Options</a>		

LOK - CONFERENCE

Description

Rounded Boat 3pc Table with T Base at Working Height

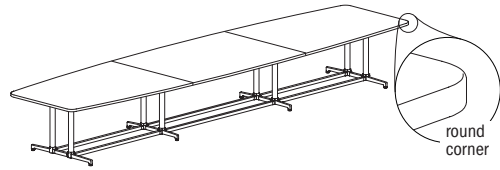

Laminate Tables  
"LKT" Models

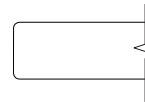

Eased Edge (R3)

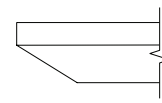

Reverse Bevel Edge (K9)

LAMINATE	D	W	H	CTN WT	CU FT	1 Model	Standard Tier 1	Graded In Tier 2	Standard Tier 1	Graded In Tier 2
		60	240	29	636	281	LKT60240-29BTRT	\$12,271	\$12,471	\$13,108
	60	216	29	584	253	LKT60216-29BTRT	\$10,460	\$10,636	\$11,260	\$11,438
	54	240	29	586	254	LKT54240-29BTRT	\$9,900	\$10,074	\$10,693	\$10,870
	54	216	29	538	229	LKT54216-29BTRT	\$9,309	\$9,470	\$10,073	\$10,232
	48	240	29	534	228	LKT48240-29BTRT	\$9,429	\$9,588	\$10,183	\$10,339
	48	216	29	538	206	LKT48216-29BTRT	\$8,341	\$8,484	\$9,068	\$9,210

Features:

- price reflects complete table - top and base
- ships KD in multiple cartons
- three piece top
- model includes adjustable glide

Options:

- specify power/charging option, see below for options and upcharges



top shape

LOK - CONFERENCE

To Order Specify

1 Laminate Model #	2 Edge Detail	3 Laminate Selection	3a PVC Edge Color	4 Electrical	5 Metal Color
Laminate (LKT)	<a href="#">See Edge Detail Options</a>	<a href="#">See Laminate Selection</a>	<a href="#">See PVC Edge Color Options</a>	N None CT6 Six Power Center Top CU2 Dual Power Underside CT6U2 Six Power Center Top with Underside (See chart on next page)	<a href="#">See Metal Finish Color Options</a>

Model Number Breakdown

LKT60240-29BTRT						
LK	T	60240	29	BT	R	T
LOK	Laminate	60" x 240"	Height	Boat Top Shape	Rounded Corner	T base

Description

Rounded Boat 3pc Table with T Base at Working Height (continued)

Veneer Tables "LKV" Models

Solid Surface Tables "LKS" Models

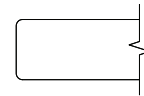

Eased Edge (R3)

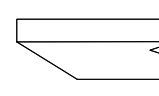

Reverse Bevel Edge (K9)

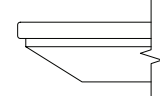

Reverse Bevel Edge (S7)

	D	W	H	CTN WT	CU FT	① Model	Veneer		Solid Surface		
							Essentials	Artisan	Essentials	Artisan	Standard
VENEER	60	240	29	636	281	LKV60240-29BTRT	\$19,086	\$20,613	\$20,803	\$22,155	--
	60	216	29	584	253	LKV60216-29BTRT	\$16,800	\$18,143	\$18,311	\$19,502	--
	54	240	29	586	254	LKV54240-29BTRT	\$16,169	\$17,479	\$16,932	\$18,176	--
	54	216	29	538	229	LKV54216-29BTRT	\$15,005	\$16,169	\$15,705	\$16,809	--
	48	240	29	534	228	LKV48240-29BTRT	\$15,170	\$16,325	\$15,864	\$16,954	--
	48	216	29	538	206	LKV48216-29BTRT	\$13,324	\$14,350	\$13,964	\$14,932	--
SOLID SURFACE	60	240	29	636	281	LKS60240-29BTRT	--	--	--	--	\$42,849
	60	216	29	584	253	LKS60216-29BTRT	--	--	--	--	\$38,729
	54	240	29	586	254	LKS54240-29BTRT	--	--	--	--	\$38,990
	54	216	29	538	229	LKS54216-29BTRT	--	--	--	--	\$35,281
	48	240	29	534	228	LKS48240-29BTRT	--	--	--	--	\$35,212
	48	216	29	538	206	LKS48216-29BTRT	--	--	--	--	\$31,136

Electrical Options and Upcharges

	216 - 240 wide
<b>CT6</b>	
Six Power Center Top - Black	CT6BL - add \$4,949
Six Power Center Top - White	CT6WH - add \$4,949
<b>CU2</b>	
Dual Power Underside - Black	CU2-1C - add \$1,298
Dual Power Underside with 4 Wireless Charging - Black	CU2-1CW - add \$3,278
<b>CT6U2</b>	
Six Power Center Top - Black with Dual Underside	CT6U2-BL - add \$5,748
Six Power Center Top - White with Dual Underside	CT6U2-WH - add \$5,748
Six Power Center Top - Black Dual Underside with 4 Wireless Charging	CT6U2-BLW2 - add \$7,668
Six Power Center Top - White Dual Underside with 4 Wireless Charging	CT6U2-WHW2 - add \$7,668

LOK - CONFERENCE

To Order Specify

Note: Order power infed that best fits application

① Veneer Model #	② Edge Detail	③ Wood Collection	④ Wood Finish	⑤ Electrical	⑥ Metal Color
Veneer (LKV)	<a href="#">See Edge Detail Options</a>	Essentials	<a href="#">See Essentials Wood Finish Options</a>	N None CT6 Six Power Center Top CU2 Dual Power Underside CT6U2 Six Power Center Top with Underside (See chart above)	<a href="#">See Metal Finish Color Options</a>
		Artisan	④ Wood Finish <a href="#">See Artisan Wood Finish Options</a>		

① Solid Surface Model #	② Top Surface Selection	③ Electrical	④ Metal Color
Solid Surface (LKS)	<a href="#">See Solid Surface Top Surface Selection Options</a>	N None CT6 Six Power Center Top CU2 Dual Power Underside CT6U2 Six Power Center Top with Underside (See chart above)	<a href="#">See Metal Finish Color Options</a>

Description

Rounded Boat 2pc Table with T Base at Working Height

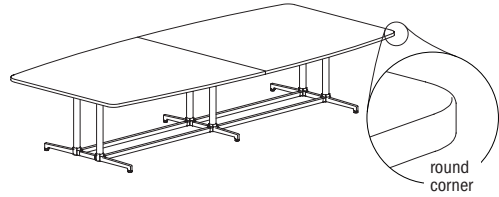

Laminate Tables "LKT" Models

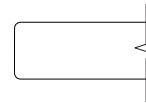

Eased Edge (R3)

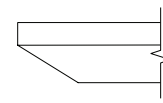

Reverse Bevel Edge (K9)

D	W	H	CTN WT	CU FT	Model	Eased Edge (R3)		Reverse Bevel Edge (K9)	
						Standard Tier 1	Graded In Tier 2	Standard Tier 1	Graded In Tier 2
60	192	29	511	226	LKT60192-29BTRT	\$8,547	\$8,708	\$9,307	\$9,465
60	168	29	449	198	LKT60168-29BTRT	\$7,977	\$8,115	\$8,699	\$8,838
60	144	29	395	169	LKT60144-29BTRT	\$7,360	\$7,478	\$8,048	\$8,165
60	120	29	342	143	LKT60120-29BTRT	\$6,526	\$6,623	\$7,176	\$7,275
54	192	29	459	204	LKT54192-29BTRT	\$8,133	\$8,277	\$8,861	\$9,004
54	168	29	377	178	LKT54168-29BTRT	\$7,367	\$7,493	\$8,065	\$8,187
54	144	29	365	154	LKT54144-29BTRT	\$6,787	\$6,895	\$7,452	\$7,558
54	120	29	316	130	LKT54120-29BTRT	\$6,081	\$6,169	\$6,708	\$6,798
48	192	29	419	183	LKT48192-29BTRT	\$7,097	\$7,224	\$7,793	\$7,918
48	168	29	377	161	LKT48168-29BTRT	\$6,598	\$6,708	\$7,264	\$7,375
48	144	29	334	139	LKT48144-29BTRT	\$6,053	\$6,147	\$6,691	\$6,787
48	120	29	290	116	LKT48120-29BTRT	\$5,439	\$5,518	\$6,051	\$6,130
48	108	29	268	105	LKT48108-29BTRT	\$4,609	\$4,678	\$5,202	\$5,274

LAMINATE

Features:

- price reflects complete table - top and base
- ships KD in multiple cartons
- two piece top
- model includes adjustable glide

Options:

- specify power/charging option, see below for options and upcharges

Electrical Options and Upcharges

	108 wide	120 - 192 wide
<b>CT2</b>		
Dual Power Center Top - Black	CT2BL - add \$1,837	n/a
Dual Power Center Top - White	CT2WH - add \$1,837	n/a
<b>CU1</b>		
Single Power Underside - Black	CU1-1C - add \$731	CU1-1C - add \$849
Single Power Underside with Wireless Charging - Black	CU1-1CW - add \$1,691	CU1-1CW - add \$1,776
<b>CT2U1</b>		
Dual Power Center Top - Black with Underside	CT2U1-BL - add \$2,235	n/a
Dual Power Center Top - White with Underside	CT2U1-WH - add \$2,235	n/a
Dual Power Center Top - Black with Wireless Charging	CT2U1-BLW2 - add \$3,194	n/a
Dual Power Center Top - White with Wireless Charging	CT2U1-WHW2 - add \$3,194	n/a

Note: Order power infeed that best fits application.

	108 wide	120 - 192 wide
<b>CT4U1</b>		
Four Power Center Top with Single Underside - Black	n/a	CT4U1-BL - add \$3,906
Four Power Center Top with Single Underside - White	n/a	CT4U1-WH - add \$3,906
Four Power Center Top - Black with Underside & Wireless Charging	n/a	CT4U1-BLW2 - add \$4,840
Four Power Center Top - White with Underside & Wireless Charging	n/a	CT4U1-WHW2 - add \$4,840
<b>CT4</b>		
Four Power Center Top - Black	n/a	CT4BL - add \$3,421
Four Power Center Top - White	n/a	CT4WH - add \$3,421



top shape

To Order Specify

1 Laminate Model #	2 Edge Detail	3 Laminate Selection	3a PVC Edge Color	4 Electrical	5 Metal Color
Laminate (LKT)	<a href="#">See Edge Detail Options</a>	<a href="#">See Laminate Selection</a>	<a href="#">See PVC Edge Color Options</a>	N None CT2 Dual Power Center Top CU2 Dual Power Underside CT2U1 Dual Power Center Top with Underside CT4U2 Four Power Center Top with Underside CT4 Four Power Center Top (See chart above)	<a href="#">See Metal Finish Color Options</a>

Model Number Breakdown

LKT60192-29BTRT						
LK	T	60192	29	BT	R	T
LOK	Laminate	60" x 192"	Height	Boat Top Shape	Rounded Corner	T base

LOK - CONFERENCE

Description

Rounded Boat 2pc Table with T Base at Working Height (continued)

Veneer Tables "LKV" Models      Solid Surface Tables "LKS" Models

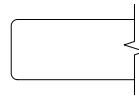

Eased Edge (R3)

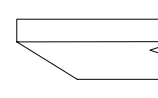

Reverse Bevel Edge (K9)

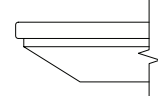

Reverse Bevel Edge (S7)

	D	W	H	CTN WT	CU FT	① Model	Veneer		Solid Surface		
							Essentials	Artisan	Essentials	Artisan	Standard
VENEER	60	192	29	511	226	LKV60192-29BTRT	\$13,301	\$14,366	\$14,497	\$15,439	--
	60	168	29	449	198	LKV60168-29BTRT	\$12,235	\$13,213	\$13,335	\$14,202	--
	60	144	29	395	169	LKV60144-29BTRT	\$11,137	\$12,028	\$12,138	\$12,928	--
	60	120	29	342	143	LKV60120-29BTRT	\$9,827	\$10,613	\$10,712	\$11,405	--
	54	192	29	459	204	LKV54192-29BTRT	\$12,166	\$13,143	\$13,263	\$14,122	--
	54	168	29	377	178	LKV54168-29BTRT	\$11,127	\$12,018	\$12,128	\$12,916	--
	54	144	29	365	154	LKV54144-29BTRT	\$10,106	\$10,914	\$11,017	\$11,730	--
	54	120	29	316	130	LKV54120-29BTRT	\$8,944	\$9,658	\$9,747	\$10,378	--
	48	192	29	419	183	LKV48192-29BTRT	\$13,301	\$11,822	\$11,511	\$12,356	--
	48	168	29	377	161	LKV48168-29BTRT	\$10,017	\$10,790	\$10,549	\$11,281	--
	48	144	29	334	139	LKV48144-29BTRT	\$9,072	\$9,725	\$9,556	\$10,170	--
	48	120	29	290	116	LKV48120-29BTRT	\$8,065	\$8,601	\$8,500	\$9,003	--
48	108	29	268	105	LKV48108-29BTRT	\$6,622	\$7,152	\$7,217	\$7,685	--	
SOLID SURFACE	60	192	29	511	226	LKS60192-29BTRT	--	--	--	--	\$32,183
	60	168	29	449	198	LKS60168-29BTRT	--	--	--	--	\$28,438
	60	144	29	395	169	LKS60144-29BTRT	--	--	--	--	\$24,738
	60	120	29	342	143	LKS60120-29BTRT	--	--	--	--	\$27,055
	54	192	29	459	204	LKS54192-29BTRT	--	--	--	--	\$29,137
	54	168	29	377	178	LKS54168-29BTRT	--	--	--	--	\$25,867
	54	144	29	365	154	LKS54144-29BTRT	--	--	--	--	\$22,540
	54	120	29	316	130	LKS54120-29BTRT	--	--	--	--	\$19,149
	48	192	29	419	183	LKS48192-29BTRT	--	--	--	--	\$26,347
	48	168	29	377	161	LKS48168-29BTRT	--	--	--	--	\$23,357
	48	144	29	334	139	LKS48144-29BTRT	--	--	--	--	\$20,391
	48	120	29	290	116	LKS48120-29BTRT	--	--	--	--	\$17,434
48	108	29	268	105	LKS48108-29BTRT	--	--	--	--	\$15,926	

LOK- CONFERENCE

To Order Specify

① Veneer Model #	② Edge Detail	③ Wood Collection	④ Wood Finish	⑤ Electrical	⑥ Metal Color
Veneer (LKV)	<a href="#">See Edge Detail Options</a>	Essentials	<a href="#">See Essentials Wood Finish Options</a>	N None CT2 Dual Power Center Top CU2 Dual Power Underside CT2U1 Dual Power Center Top with Underside CT4U2 Four Power Center Top with Underside CT4 Four Power Center Top (See chart on previous page)	<a href="#">See Metal Finish Color Options</a>
		Artisan	④ Wood Finish <a href="#">See Artisan Wood Finish Options</a>		

① Solid Surface Model #	② Top Surface Selection	③ Electrical	④ Metal Color
Solid Surface (LKS)	<a href="#">See Solid Surface Top Surface Selection Options</a>	N None CT2 Dual Power Center Top CU2 Dual Power Underside CT2U1 Dual Power Center Top with Underside CT4U2 Four Power Center Top with Underside CT4 Four Power Center Top (See chart on previous page)	<a href="#">See Metal Finish Color Options</a>

Description

Rounded Boat Table with T Base at Working Height

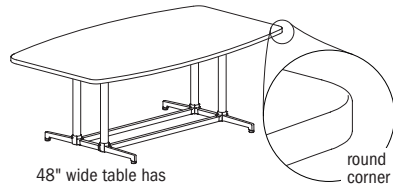

48" wide table has double column base

D	W	H	CTN WT	CU FT	1 Model
48	96	29	219	83	LKT4896-29BTRT
48	84	29	198	83	LKT4884-29BTRT
42	96	29	177	73	LKT4296-29BTRT
42	84	29	158	72	LKT4284-29BTRT
36	96	29	156	72	LKT3696-29BTRT
36	84	29	146	64	LKT3684-29BTRT

LAMINATE

Laminate Tables "LKT" Models

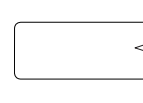

Eased Edge (R3)

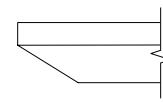

Reverse Bevel Edge (K9)

Eased Edge (R3)		Reverse Bevel Edge (K9)	
Standard Tier 1	Graded In Tier 2	Standard Tier 1	Graded In Tier 2
\$3,875	\$3,936	\$4,456	\$4,521
\$3,439	\$3,498	\$4,007	\$4,062
\$3,517	\$3,572	\$4,084	\$4,138
\$2,897	\$2,947	\$3,455	\$3,503
\$2,957	\$3,007	\$3,510	\$3,557
\$2,655	\$2,694	\$3,194	\$3,238

Features:

- price reflects complete table - top and base
- ships KD in multiple cartons
- one piece top
- model includes adjustable glide

Options:

- specify power/charging option, see below for options and upcharges

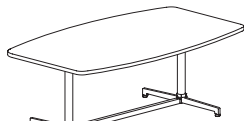

42" & 36" wide tables have single column base



top shape

LOK - CONFERENCE

To Order Specify

1 Laminate Model #	2 Edge Detail	3 Laminate Selection	3a PVC Edge Color	4 Electrical	5 Metal Color
Laminate (LKT)	<a href="#">See Edge Detail Options</a>	<a href="#">See Laminate Selection</a>	<a href="#">See PVC Edge Color Options</a>	N None CT2 Dual Power Center Top CU2 Dual Power Underside CT2U1 Dual Power Center Top with Underside (See chart on next page)	<a href="#">See Metal Finish Color Options</a>

Model Number Breakdown

LKT4896-29BTRT						
LK	T	4896	29	BT	R	T
LOK	Laminate	48" x 96"	Height	Boat Top Shape	Rounded Corner	T base

Description

Rounded Boat Table with T Base at Working Height (continued)

Veneer Tables "LKV" Models      Solid Surface Tables "LKS" Models

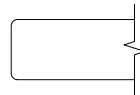

Eased Edge (R3)

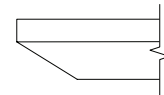

Reverse Bevel Edge (K9)

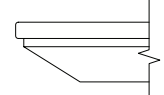

Reverse Bevel Edge (S7)

	D	W	H	CTN WT	CU FT	① Model	Veneer Tables		Solid Surface Tables		
							Essentials	Artisan	Essentials	Artisan	Standard
VENEER	48	96	29	219	83	LKV4896-29BTRT	\$5,395	\$5,810	\$5,776	\$6,168	--
	48	84	29	198	83	LKV4884-29BTRT	\$4,922	\$5,281	\$5,276	\$5,610	--
	42	96	29	177	73	LKV4296-29BTRT	\$5,256	\$5,678	\$5,729	\$6,100	--
	42	84	29	158	72	LKV4284-29BTRT	\$4,419	\$4,771	\$4,817	\$5,131	--
	36	96	29	156	72	LKV3696-29BTRT	\$4,001	\$4,320	\$4,359	\$4,644	--
	36	84	29	146	64	LKV3684-29BTRT	\$3,682	\$3,973	\$4,012	\$4,270	--
SOLID SURFACE	48	96	29	219	83	LKS4896-29BTRT	--	--	--	--	\$12,641
	48	84	29	198	83	LKS4884-29BTRT	--	--	--	--	\$11,205
	42	96	29	177	73	LKS4296-29BTRT	--	--	--	--	\$10,285
	42	84	29	158	72	LKS4284-29BTRT	--	--	--	--	\$9,066
	36	96	29	156	72	LKS3696-29BTRT	--	--	--	--	\$9,038
	36	84	29	146	64	LKS3684-29BTRT	--	--	--	--	\$8,146

Electrical Options and Upcharges

CT2	84 - 96 wide
Dual Power Center Top - Black	CT2BL - add \$1,837
Dual Power Center Top - White	CT2WH - add \$1,837
CU1	
Single Power Underside - Black	CU1-1C - add \$731
Single Power Underside with Wireless Charging - Black	CU1-1CW - add \$1,691
CT2U1	
Dual Power Center Top - Black with Single Underside	CT2U1-BL - add \$2,235
Dual Power Center Top - White with Single Underside	CT2U1-WH - add \$2,235
Dual Power Center Top - Black with Wireless Charging	CT2U1-BLW2 - add \$3,194
Dual Power Center Top - White with Wireless Charging	CT2U1-WHW2 - add \$3,194

LOK - CONFERENCE

Note: Order power infeed that best fits application

To Order Specify

① Veneer Model #	② Edge Detail	③ Wood Collection	④ Wood Finish	⑤ Electrical	⑥ Metal Color
Veneer (LKV)	<a href="#">See Edge Detail Options</a>	Essentials	<a href="#">See Essentials Wood Finish Options</a>	N None CT2 Dual Power Center Top CU2 Dual Power Underside CT2U1 Dual Power Center Top with Underside (See chart above)	<a href="#">See Metal Finish Color Options</a>
		Artisan	④ Wood Finish <a href="#">See Artisan Wood Finish Options</a>		

① Solid Surface Model #	② Top Surface Selection	③ Electrical	④ Metal Color
Solid Surface (LKS)	<a href="#">See Solid Surface Top Surface Selection Options</a>	N None CT2 Dual Power Center Top CU2 Dual Power Underside CT2U1 Dual Power Center Top with Underside (See chart above)	<a href="#">See Metal Finish Color Options</a>

Description

Boat 3pc Table with Y Base at Working Height

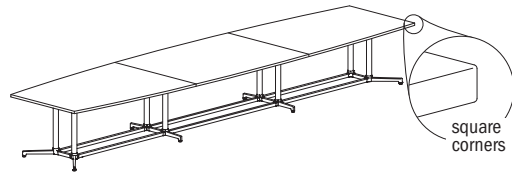

Laminate Tables "LKT" Models

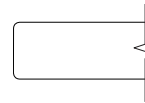

Eased Edge (R3)

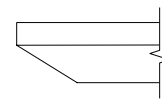

Reverse Bevel Edge (K9)

D	W	H	CTN WT	CU FT	Model	Eased Edge (R3)		Reverse Bevel Edge (K9)	
						Standard Tier 1	Graded In Tier 2	Standard Tier 1	Graded In Tier 2
60	240	29	636	281	LKT60240-29BTY	\$11,889	\$12,084	\$12,723	\$12,920
60	216	29	584	253	LKT60216-29BTY	\$10,053	\$10,232	\$10,852	\$11,030
54	240	29	575	254	LKT54240-29BTY	\$9,406	\$9,582	\$10,200	\$10,376
54	216	29	523	229	LKT54216-29BTY	\$8,408	\$8,568	\$9,169	\$9,329
48	240	29	537	228	LKT48240-29BTY	\$9,088	\$9,249	\$9,841	\$9,999
48	216	29	477	206	LKT48216-29BTY	\$8,423	\$8,566	\$9,152	\$9,291

Features:

- price reflects complete table - top and base
- ships KD in multiple cartons
- three piece top
- model includes adjustable glide

Options:

- specify power/charging option, see below for options and upcharges



top shape

LOK - CONFERENCE

To Order Specify

1 Laminate Model #	2 Edge Detail	3 Laminate Selection	4 PVC Edge Color	4 Electrical	5 Metal Color
Laminate (LKT)	<a href="#">See Edge Detail Options</a>	<a href="#">See Laminate Selection</a>	<a href="#">See PVC Edge Color Options</a>	N None CT6 Six Power Center Top CU2 Dual Power Underside CT6U2 Six Power Center Top with Underside (See chart on next page)	<a href="#">See Metal Finish Color Options</a>

Model Number Breakdown

LKT60240-29BTY					
LK	T	60240	29	BT	Y
LOK	Laminate	60" x 240"	Height	Boat Top Shape	Y base

Description

Boat 3pc Table with Y Base  
at Working Height  
(continued)

Veneer Tables  
"LKV" Models

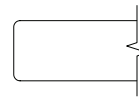

Eased Edge (R3)

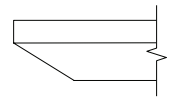

Reverse Bevel Edge (K9)

D	W	H	CTN WT	CU FT	① Model	Eased Edge (R3)		Reverse Bevel Edge (K9)		
						Essentials	Artisan	Essentials	Artisan	
60	240	29	636	281	LKV60240-29BTY	\$18,509	\$19,989	\$20,175	\$21,485	
60	216	29	584	253	LKV60216-29BTY	\$16,198	\$17,494	\$17,654	\$18,803	
VENEER	54	240	29	575	254	LKV54240-29BTY	\$15,440	\$16,755	\$16,203	\$17,449
	54	216	29	523	229	LKV54216-29BTY	\$13,697	\$14,858	\$14,398	\$15,501
	48	240	29	537	228	LKV48240-29BTY	\$14,674	\$15,830	\$15,364	\$16,459
	48	216	29	477	206	LKV48216-29BTY	\$13,444	\$14,466	\$14,080	\$15,048

Electrical Options and Upcharges

	216 - 240 wide
<b>CT6</b>	
Six Power Center Top - Black	CT6BL - add \$4,949
Six Power Center Top - White	CT6WH - add \$4,949
<b>CU2</b>	
Dual Power Underside - Black	CU2-1C - add \$1,298
Dual Power Underside with 4 Wireless Charging - Black	CU2-1CW - add \$3,278
<b>CT6U2</b>	
Six Power Center Top - Black with Dual Underside	CT6U2-BL - add \$5,748
Six Power Center Top - White with Dual Underside	CT6U2-WH - add \$5,748
Six Power Center Top - Black Dual Underside with 4 Wireless Charging	CT6U2-BLW2 - add \$7,668
Six Power Center Top - White Dual Underside with 4 Wireless Charging	CT6U2-WHW2 - add \$7,668

Note: Order power infeed that best fits application

To Order Specify

① Veneer Model #	② Edge Detail	③ Wood Collection	④ Wood Finish	⑤ Electrical	⑥ Metal Color
Veneer (LKV)	<a href="#">See Edge Detail Options</a>	Essentials	<a href="#">See Essentials Wood Finish Options</a>	N None CT6 Six Power Center Top CU2 Dual Power Underside CT6U2 Six Power Center Top with Underside (See chart above)	<a href="#">See Metal Finish Color Options</a>
		Artisan	<b>④ Wood Finish</b> <a href="#">See Artisan Wood Finish Options</a>		

LOK - CONFERENCE

Description

Boat 2pc Table with Y Base at Working Height

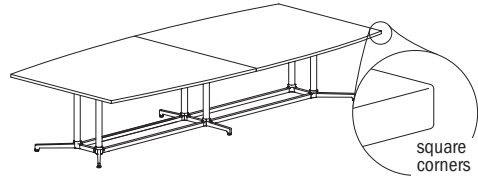

Laminate Tables "LKT" Models

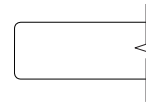

Eased Edge (R3)

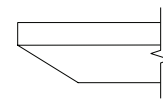

Reverse Bevel Edge (K9)

D	W	H	CTN WT	CU FT	Model	Eased Edge (R3)		Reverse Bevel Edge (K9)		
						Standard Tier 1	Graded In Tier 2	Standard Tier 1	Graded In Tier 2	
60	192	29	511	226	LKT60192-29BTY	\$8,315	\$8,471	\$9,074	\$9,230	
60	168	29	449	198	LKT60168-29BTY	\$7,724	\$7,862	\$8,448	\$8,588	
60	144	29	333	169	LKT60144-29BTY	\$7,037	\$7,155	\$7,723	\$7,841	
60	120	29	334	143	LKT60120-29BTY	\$6,338	\$6,436	\$6,990	\$7,089	
LAMINATE	54	192	29	449	204	LKT54192-29BTY	\$8,024	\$8,165	\$8,753	\$8,893
	54	168	29	359	178	LKT54168-29BTY	\$7,144	\$7,270	\$7,841	\$7,965
	54	144	29	356	154	LKT54144-29BTY	\$6,497	\$6,601	\$7,162	\$7,264
	54	120	29	308	130	LKT54120-29BTY	\$5,953	\$6,040	\$6,584	\$6,673
48	192	29	409	183	LKT48192-29BTY	\$7,802	\$7,931	\$8,498	\$8,623	
48	168	29	363	161	LKT48168-29BTY	\$6,328	\$6,436	\$6,994	\$7,102	
48	144	29	323	139	LKT48144-29BTY	\$5,860	\$5,955	\$6,501	\$6,596	
48	120	29	283	116	LKT48120-29BTY	\$5,296	\$5,376	\$5,908	\$5,986	
48	108	29	262	105	LKT48108-29BTY	\$4,718	\$4,790	\$5,316	\$5,386	

Features:

- price reflects complete table - top and base
- ships KD in multiple cartons
- two piece top
- model includes adjustable glide

Options:

- specify power/charging option, see below for options and upcharges



top shape

LOK - CONFERENCE

To Order Specify

1 Laminate Model #	2 Edge Detail	3 Laminate Selection	3a PVC Edge Color	4 Electrical	5 Metal Color
Laminate (LKT)	<a href="#">See Edge Detail Options</a>	<a href="#">See Laminate Selection</a>	<a href="#">See PVC Edge Color Options</a>	N None CT2 Dual Power Center Top CU2 Dual Power Underside CT2U1 Dual Power Center Top with Underside CT4U2 Four Power Center Top with Underside CT4 Four Power Center Top (See chart on next page)	<a href="#">See Metal Finish Color Options</a>

Model Number Breakdown

LKT60192-29BTY					
LK	T	60192	29	BT	Y
LOK	Laminate	60" x 192"	Height	Boat Top Shape	Y base

Description

Boat 2pc Table with Y Base  
at Working Height  
(continued)

Veneer Tables  
"LKV" Models

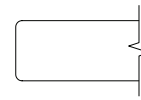

Eased Edge (R3)

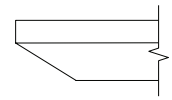

Reverse Bevel Edge (K9)

D	W	H	CTN WT	CU FT	Model	Eased Edge (R3)		Reverse Bevel Edge (K9)		
						Essentials	Artisan	Essentials	Artisan	
60	192	29	511	226	LKV60192-29BTY	\$12,962	\$13,999	\$14,129	\$15,047	
60	168	29	449	198	LKV60168-29BTY	\$11,877	\$12,825	\$12,946	\$13,787	
60	144	29	333	169	LKV60144-29BTY	\$10,684	\$11,536	\$11,644	\$12,399	
60	120	29	334	143	LKV60120-29BTY	\$9,571	\$10,333	\$10,428	\$11,107	
VENEER	54	192	29	449	204	LKV54192-29BTY	\$12,010	\$12,971	\$13,091	\$13,941
	54	168	29	359	178	LKV54168-29BTY	\$10,816	\$11,682	\$11,789	\$12,555
	54	144	29	356	154	LKV54144-29BTY	\$9,705	\$10,482	\$10,578	\$11,267
	54	120	29	308	130	LKV54120-29BTY	\$8,773	\$9,472	\$9,563	\$10,180
48	192	29	409	183	LKV48192-29BTY	\$11,913	\$12,809	\$12,499	\$13,346	
48	168	29	363	161	LKV48168-29BTY	\$9,643	\$10,415	\$10,177	\$10,902	
48	144	29	323	139	LKV48144-29BTY	\$8,813	\$9,465	\$9,295	\$9,911	
48	120	29	283	116	LKV48120-29BTY	\$7,875	\$8,412	\$8,310	\$8,814	
48	108	29	262	105	LKV48108-29BTY	\$6,767	\$7,308	\$7,375	\$7,855	

Electrical Options and Upcharges

CT2	108 wide	120 - 192 wide
Dual Power Center Top - Black	CT2BL - add \$1,837	n/a
Dual Power Center Top - White	CT2WH - add \$1,837	n/a
CU1		
Single Power Underside - Black	CU1-1C - add \$731	CU1-1C - add \$849
Single Power Underside with Wireless Charging - Black	CU1-1CW - add \$1,691	CU1-1CW - add \$1,776
CT2U1		
Dual Power Center Top - Black with Underside	CT2U1-BL - add \$2,235	n/a
Dual Power Center Top - White with Underside	CT2U1-WH - add \$2,235	n/a
Dual Power Center Top - Black with Wireless Charging	CT2U1-BLW2 - add \$3,194	n/a
Dual Power Center Top - White with Wireless Charging	CT2U1-WHW2 - add \$3,194	n/a

CT4U1	108 wide	120 - 192 wide
Four Power Center Top with Single Underside - Black	n/a	CT4U1-BL - add \$3,906
Four Power Center Top with Single Underside - White	n/a	CT4U1-WH - add \$3,906
Four Power Center Top - Black with Underside & Wireless Charging	n/a	CT4U1-BLW2 - add \$4,840
Four Power Center Top - White with Underside & Wireless Charging	n/a	CT4U1-WHW2 - add \$4,840
CT4		
Four Power Center Top - Black	n/a	CT4BL - add \$3,421
Four Power Center Top - White	n/a	CT4WH - add \$3,421

Note: Order power infeed that best fits application

To Order Specify

1 Veneer Model #	2 Edge Detail	3 Wood Collection	4 Wood Finish	5 Electrical	6 Metal Color
Veneer (LKV)	<a href="#">See Edge Detail Options</a>	Essentials	<a href="#">See Essentials Wood Finish Options</a>	N None CT2 Dual Power Center Top CU2 Dual Power Underside CT2U1 Dual Power Center Top with Underside CT4U2 Four Power Center Top with Underside CT4 Four Power Center Top	<a href="#">See Metal Finish Color Options</a>
		Artisan	4 Wood Finish <a href="#">See Artisan Wood Finish Options</a>		

LOK - CONFERENCE

Description

Boat Table with Y Base at Working Height

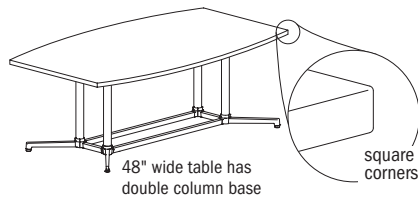

Laminate Tables "LKT" Models

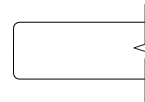

Eased Edge (R3)

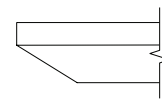

Reverse Bevel Edge (K9)

D	W	H	CTN WT	CU FT	Model	Eased Edge (R3)		Reverse Bevel Edge (K9)	
						Standard Tier 1	Graded In Tier 2	Standard Tier 1	Graded In Tier 2
48	96	29	219	105	LKT4896-29BTY	\$3,898	\$3,960	\$4,479	\$4,541
48	84	29	327	83	LKT4884-29BTY	\$3,421	\$3,476	\$3,988	\$4,046
42	96	29	168	83	LKT4296-29BTY	\$3,712	\$3,767	\$4,276	\$4,335
42	84	29	636	281	LKT4284-29BTY	\$3,109	\$3,157	\$3,664	\$3,715
36	96	29	636	281	LKT3696-29BTY	\$3,023	\$3,069	\$3,572	\$3,622
36	84	29	648	281	LKT3684-29BTY	\$2,717	\$2,760	\$3,258	\$3,300

LAMINATE

Features:

- price reflects complete table - top and base
- ships KD in multiple cartons
- one piece top
- model includes adjustable glide

Options:

- specify power/charging option, see below for options and upcharges

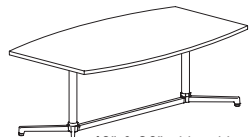

42" & 36" wide tables have single column base

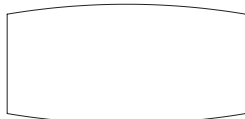

top shape

LOK - CONFERENCE

To Order Specify

1 Laminate Model #	2 Edge Detail	3 Laminate Selection	3a PVC Edge Color	4 Electrical	5 Metal Color
Laminate (LKT)	<a href="#">See Edge Detail Options</a>	<a href="#">See Laminate Selection</a>	<a href="#">See PVC Edge Color Options</a>	N None CT2 Dual Power Center Top CU2 Dual Power Underside CT2U1 Dual Power Center Top with Underside (See chart on next page)	<a href="#">See Metal Finish Color Options</a>

Model Number Breakdown

LKT4896-29BTY					
LK	T	4896	29	BT	Y
LOK	Laminate	48" x 96"	Height	Boat Top Shape	Y base

Description

Boat Table with  
Y Base at Working Height  
(continued)

Veneer Tables  
"LKV" Models

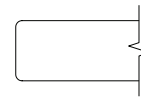

Eased Edge (R3)

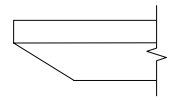

Reverse Bevel Edge (K9)

D	W	H	CTN WT	CU FT	① Model	Eased Edge (R3)		Reverse Bevel Edge (K9)	
						Essentials	Artisan	Essentials	Artisan
48	96	29	219	105	LKV4896-29BTY	\$5,426	\$5,842	\$5,806	\$6,196
48	84	29	327	83	LKV4884-29BTY	\$4,895	\$5,254	\$5,250	\$5,585
42	96	29	168	83	LKV4296-29BTY	\$5,500	\$5,939	\$5,994	\$6,385
	84	29	636	281	LKV4284-29BTY	\$4,678	\$5,051	\$5,098	\$5,430
36	96	29	636	281	LKV3696-29BTY	\$4,080	\$4,404	\$4,444	\$4,734
36	84	29	648	281	LKV3684-29BTY	\$3,758	\$4,058	\$4,094	\$4,359

VENEER

Electrical Options and Upcharges

CT2	84 - 96 wide
Dual Power Center Top - Black	CT2BL - add \$1,837
Dual Power Center Top - White	CT2WH - add \$1,837
<b>CU1</b>	
Single Power Underside - Black	CU1-1C - add \$731
Single Power Underside with Wireless Charging - Black	CU1-1CW - add \$1,691
<b>CT2U1</b>	
Dual Power Center Top - Black with Single Underside	CT2U1-BL - add \$2,235
Dual Power Center Top - White with Single Underside	CT2U1-WH - add \$2,235
Dual Power Center Top - Black with Wireless Charging	CT2U1-BLW2 - add \$3,194
Dual Power Center Top - White with Wireless Charging	CT2U1-WHW2 - add \$3,194

**Note: Order power infed that best fits application**

To Order Specify

① Veneer Model #	② Edge Detail	③ Wood Collection	④ Wood Finish	⑤ Electrical	⑥ Metal Color
Veneer (LKV)	<a href="#">See Edge Detail Options</a>	Essentials	<a href="#">See Essentials Wood Finish Options</a>	N None CT2 Dual Power Center Top CU2 Dual Power Underside CT2U1 Dual Power Center Top with Underside (See chart above)	<a href="#">See Metal Finish Color Options</a>
		Artisan	④ Wood Finish <a href="#">See Artisan Wood Finish Options</a>		

LOK - CONFERENCE

Description

Rounded Double Chevron Table with T Base at Working Height

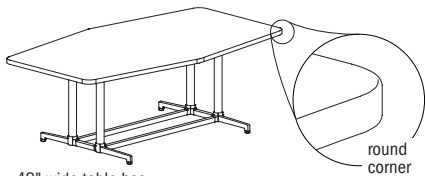

48" wide table has double column base

Laminate Tables "LKT" Models

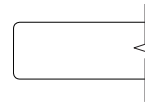

Eased Edge (R3)

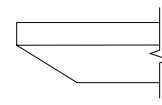

Reverse Bevel Edge (K9)

LAMINATE	D	W	H	CTN WT	CU FT	1 Model	Standard Tier 1	Graded In Tier 2	Standard Tier 1	Graded In Tier 2
	48	96	29	204	105	LKT4896-29DCRT	\$3,875	\$3,936	\$4,456	\$4,521
	48	84	29	182	83	LKT4884-29DCRT	\$3,439	\$3,498	\$4,007	\$4,062
42	96	29	161	73	LKT4296-29DCRT	\$3,517	\$3,572	\$4,084	\$4,138	
42	84	29	142	72	LKT4284-29DCRT	\$2,897	\$2,947	\$3,455	\$3,503	
36	96	29	146	72	LKT3696-29DCRT	\$2,957	\$3,007	\$3,510	\$3,557	
36	84	29	134	64	LKT3684-29DCRT	\$2,655	\$2,694	\$3,194	\$3,238	

Features:

- price reflects complete table - top and base
- ships KD in multiple cartons
- one piece top
- model includes adjustable glide

Options:

- specify power/charging option, see below for options and upcharges

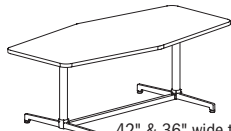

42" & 36" wide tables have single column base

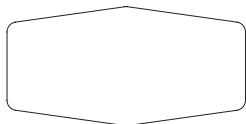

top shape

LOK - CONFERENCE

To Order Specify

1 Laminite Model #	2 Edge Detail	3 Laminite Selection	3a PVC Edge Color	4 Electrical	5 Metal Color
Laminite (LKT)	<a href="#">See Edge Detail Options</a>	<a href="#">See Laminite Selection</a>	<a href="#">See PVC Edge Color Options</a>	N None CT2 Dual Power Center Top CU2 Dual Power Underside CT2U1 Dual Power Center Top with Underside (See chart on next page)	<a href="#">See Metal Finish Color Options</a>

Model Number Breakdown

LKT4896-29DCRT						
LK	T	4896	29	DC	R	T
LOK	Laminite	48" x 96"	Height	Double Chevron Top Shape	Rounded Corner	T base

Description

Rounded Double Chevron Table with T Base at Working Height (continued)

Veneer Tables "LKV" Models

Solid Surface Tables "LKS" Models

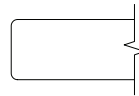

Eased Edge (R3)

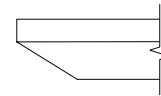

Reverse Bevel Edge (K9)

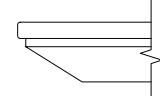

Reverse Bevel Edge (S7)

	D	W	H	CTN WT	CU FT	① Model	Veneer Tables		Solid Surface Tables		
							Essentials	Artisan	Essentials	Artisan	Standard
VENEER	48	96	29	204	105	LKV4896-29DCRT	\$5,395	\$5,810	\$5,776	\$6,168	--
	48	84	29	182	83	LKV4884-29DCRT	\$4,922	\$5,281	\$5,276	\$5,610	--
	42	96	29	161	73	LKV4296-29DCRT	\$5,256	\$5,678	\$5,729	\$6,100	--
	42	84	29	142	72	LKV4284-29DCRT	\$4,419	\$4,771	\$4,817	\$5,131	--
	36	96	29	146	72	LKV3696-29DCRT	\$4,001	\$4,320	\$4,359	\$4,644	--
	36	84	29	134	64	LKV3684-29DCRT	\$3,682	\$3,973	\$4,012	\$4,270	--
SOLID SURFACE	48	96	29	204	105	LKS4896-29DCRT	--	--	--	--	\$12,641
	48	84	29	182	83	LKS4884-29DCRT	--	--	--	--	\$11,205
	42	96	29	161	73	LKS4296-29DCRT	--	--	--	--	\$10,285
	42	84	29	142	72	LKS4284-29DCRT	--	--	--	--	\$9,066
	36	96	29	146	72	LKS3696-29DCRT	--	--	--	--	\$9,038
	36	84	29	134	64	LKS3684-29DCRT	--	--	--	--	\$8,146

Electrical Options and Upcharges

CT2	84 - 96 wide
Dual Power Center Top - Black	CT2BL - add \$1,837
Dual Power Center Top - White	CT2WH - add \$1,837
CU1	
Single Power Underside - Black	CU1-1C - add \$731
Single Power Underside with Wireless Charging - Black	CU1-1CW - add \$1,691
CT2U1	
Dual Power Center Top - Black with Single Underside	CT2U1-BL - add \$2,235
Dual Power Center Top - White with Single Underside	CT2U1-WH - add \$2,235
Dual Power Center Top - Black with Wireless Charging	CT2U1-BLW2 - add \$3,194
Dual Power Center Top - White with Wireless Charging	CT2U1-WHW2 - add \$3,194

Note: Order power infeed that best fits application

To Order Specify

① Veneer Model #	② Edge Detail	③ Wood Collection	④ Wood Finish	⑤ Electrical	⑥ Metal Color
Veneer (LKV)	<a href="#">See Edge Detail Options</a>	Essentials	<a href="#">See Essentials Wood Finish Options</a>	N None CT2 Dual Power Center Top CU2 Dual Power Underside CT2U1 Dual Power Center Top with Underside (See chart above)	<a href="#">See Metal Finish Color Options</a>
		Artisan	④ Wood Finish <a href="#">See Artisan Wood Finish Options</a>		

① Solid Surface Model #	② Top Surface Selection	③ Electrical	④ Metal Color
Solid Surface (LKS)	<a href="#">See Solid Surface Top Surface Selection Options</a>	N None CT2 Dual Power Center Top CU2 Dual Power Underside CT2U1 Dual Power Center Top with Underside (See chart above)	<a href="#">See Metal Finish Color Options</a>

LOK - CONFERENCE

## Description

Rounded Double Chevron Table with Y Base at Working Height

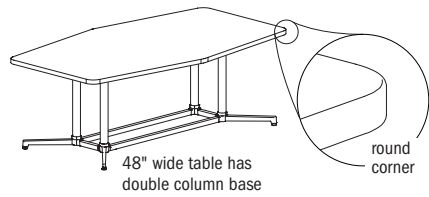

## Laminate Tables "LKT" Models

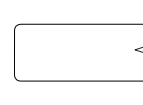

Eased Edge (R3)

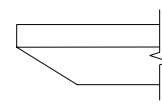

Reverse Bevel Edge (K9)

LAMINATE	D	W	H	CTN WT	CU FT	① Model	Standard Tier 1	Graded In Tier 2	Standard Tier 1	Graded In Tier 2
	48	96	29	199	105	LKT4896-29DCRY	\$3,898	\$3,960	\$4,479	\$4,541
	48	84	29	312	83	LKT4884-29DCRY	\$3,421	\$3,476	\$3,988	\$4,046
42	96	29	153	83	LKT4296-29DCRY	\$3,712	\$3,767	\$4,276	\$4,335	
42	84	29	153	72	LKT4284-29DCRY	\$3,109	\$3,157	\$3,664	\$3,715	
36	96	29	150	72	LKT3696-29DCRY	\$3,023	\$3,069	\$3,572	\$3,622	
36	84	29	144	64	LKT3684-29DCRY	\$2,717	\$2,760	\$3,258	\$3,300	

### Features:

- price reflects complete table - top and base
- ships KD in multiple cartons
- one piece top
- model includes adjustable glide

### Options:

- specify power/charging option, see below for options and upcharges

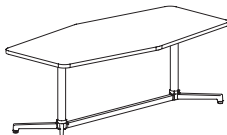

42" & 36" wide tables have single column base

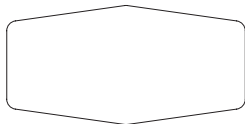

top shape

LOK - CONFERENCE

## To Order Specify

① Laminate Model #	② Edge Detail	③ Laminate Selection	④ PVC Edge Color	⑤ Electrical	⑥ Metal Color
Laminate (LKT)	<a href="#">See Edge Detail Options</a>	<a href="#">See Laminate Selection</a>	<a href="#">See PVC Edge Color Options</a>	N None CT2 Dual Power Center Top CU2 Dual Power Underside CT2U1 Dual Power Center Top with Underside (See chart on next page)	<a href="#">See Metal Finish Color Options</a>

## Model Number Breakdown

LKT4896-29DCRY						
LK	T	4896	29	DC	R	Y
LOK	Laminate	48" x 96"	Height	Double Chevron Top Shape	Rounded Corner	Y base

Description

Rounded Double Chevron Table with Y Base at Working Height (continued)

Veneer Tables "LKV" Models      Solid Surface Tables "LKS" Models

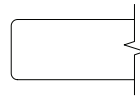

Eased Edge (R3)

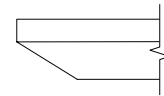

Reverse Bevel Edge (K9)

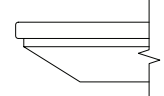

Reverse Bevel Edge (S7)

	D	W	H	CTN WT	CU FT	① Model	Veneer Tables		Solid Surface Tables		
							Essentials	Artisan	Essentials	Artisan	Standard
VENEER	48	96	29	199	105	LKV4896-29DCRY	\$5,426	\$5,842	\$5,806	\$6,196	--
	48	84	29	312	83	LKV4884-29DCRY	\$4,895	\$5,254	\$5,250	\$5,585	--
	42	96	29	153	83	LKV4296-29DCRY	\$5,500	\$5,939	\$5,994	\$6,385	--
	42	84	29	153	72	LKV4284-29DCRY	\$4,678	\$5,051	\$5,098	\$5,430	--
	36	96	29	150	72	LKV3696-29DCRY	\$4,080	\$4,404	\$4,444	\$4,734	--
	36	84	29	144	64	LKV3684-29DCRY	\$3,758	\$4,058	\$4,094	\$4,359	--
SOLID SURFACE	48	96	29	199	105	LKS4896-29DCRY	--	--	--	--	\$12,669
	48	84	29	312	83	LKS4884-29DCRY	--	--	--	--	\$11,183
	42	96	29	153	83	LKS4296-29DCRY	--	--	--	--	\$10,528
	42	84	29	153	72	LKS4284-29DCRY	--	--	--	--	\$9,321
	36	96	29	150	72	LKS3696-29DCRY	--	--	--	--	\$9,114
	36	84	29	144	64	LKS3684-29DCRY	--	--	--	--	\$8,223

Electrical Options and Upcharges

CT2	84 - 96 wide
Dual Power Center Top - Black	CT2BL - add \$1,837
Dual Power Center Top - White	CT2WH - add \$1,837
CU1	
Single Power Underside - Black	CU1-1C - add \$731
Single Power Underside with Wireless Charging - Black	CU1-1CW - add \$1,691
CT2U1	
Dual Power Center Top - Black with Single Underside	CT2U1-BL - add \$2,235
Dual Power Center Top - White with Single Underside	CT2U1-WH - add \$2,235
Dual Power Center Top - Black with Wireless Charging	CT2U1-BLW2 - add \$3,194
Dual Power Center Top - White with Wireless Charging	CT2U1-WHW2 - add \$3,194

LOK - CONFERENCE

Note: Order power infeed that best fits application

To Order Specify

① Veneer Model #	② Edge Detail	③ Wood Collection	④ Wood Finish	⑤ Electrical	⑥ Metal Color
Veneer (LKV)	<a href="#">See Edge Detail Options</a>	Essentials	<a href="#">See Essentials Wood Finish Options</a>	N None CT2 Dual Power Center Top CU2 Dual Power Underside CT2U1 Dual Power Center Top with Underside (See chart above)	<a href="#">See Metal Finish Color Options</a>
		Artisan	④ Wood Finish <a href="#">See Artisan Wood Finish Options</a>		

① Solid Surface Model #	② Top Surface Selection	③ Electrical	④ Metal Color
Solid Surface (LKS)	<a href="#">See Solid Surface Top Surface Selection Options</a>	N None CT2 Dual Power Center Top CU2 Dual Power Underside CT2U1 Dual Power Center Top with Underside (See chart above)	<a href="#">See Metal Finish Color Options</a>

## Description

Taper 2pc Table with T Base  
at Working Height

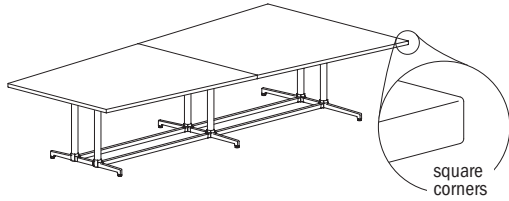

## Laminate Tables "LKT" Models

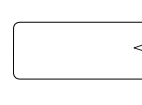

Eased Edge (R3)

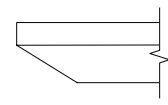

Reverse Bevel Edge (K9)

LAMI	D	W	H	CTN WT	CU FT	Model	Standard Tier 1	Graded In Tier 2	Standard Tier 1	Graded In Tier 2
		60	120	29	312	143	LKT60120-29TPT	\$6,478	\$6,581	\$7,130

### Features:

- price reflects complete table - top and base
- ships KD in multiple cartons
- two piece top
- model includes adjustable glide

### Options:

- specify power/charging option, see below for options and upcharges

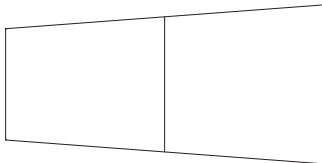

top shape

LOK - CONFERENCE

## To Order Specify

1 Laminate Model #	2 Edge Detail	3 Laminate Selection	3a PVC Edge Color	4 Electrical	5 Metal Color
Laminate (LKT)	<a href="#">See Edge Detail Options</a>	<a href="#">See Laminate Selection</a>	<a href="#">See PVC Edge Color Options</a>	N None CT4 Four Power on Top CU1 Single Power Underside CT4U1 Four Power Center Top with Underside (See chart on next page)	<a href="#">See Metal Finish Color Options</a>

## Model Number Breakdown

LKT60120-29TPT					
LK	T	60120	29	TP	T
LOK	Laminate	60" x 120"	Height	Taper Top Shape	T base

Description

Taper 2pc Table with T Base  
at Working Height  
(continued)

Veneer Tables  
"LKV" Models

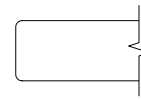

Eased Edge (R3)

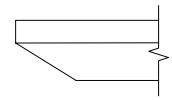

Reverse Bevel Edge (K9)

VEN.	D	W	H	CTN WT	CU FT	① Model	Eased Edge (R3)		Reverse Bevel Edge (K9)	
							Essentials	Artisan	Essentials	Artisan
	60	120	29	312	143	LKV60120-29TPT	\$9,761	\$10,541	\$10,639	\$11,330

Electrical Options and Upcharges

	120 - 192 wide
<b>CT4</b>	
Four Power Center Top - Black	CT4BL - add \$3,421
Four Power Center Top - White	CT4WH - add \$3,421
<b>CU1</b>	
Single Power Underside - Black	CU1-1C - add \$849
Single Power Underside with Wireless Charging - Black	CU1-1CW - add \$1,776
<b>CT4U1</b>	
Four Power Center Top with Underside - Black	CT4U1-BL - add \$3,906
Four Power Center Top with Underside - White	CT4U1-WH - add \$3,906
Four Power Center Top - Black with Underside & 2 Wireless Charging	CT4U1-BLW2 - add \$4,840
Four Power Center Top - White with Underside & 2 Wireless Charging	CT4U1-WHW2 - add \$4,840

Note: Order power infed that best fits application

To Order Specify

① Veneer Model #	② Edge Detail	③ Wood Collection	④ Wood Finish	⑤ Electrical	⑥ Metal Color
Veneer (LKV)	<a href="#">See Edge Detail Options</a>	Essentials	<a href="#">See Essentials Wood Finish Options</a>	N None CT4 Four Power on Top CU1 Single Power Underside CT4U1 Four Power Center Top with Underside (See chart above)	<a href="#">See Metal Finish Color Options</a>
		Artisan	④ Wood Finish <a href="#">See Artisan Wood Finish Options</a>		

LOK - CONFERENCE

Description

Taper Table with T Base at Working Height

Laminate Tables "LKT" Models

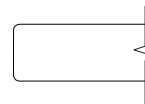
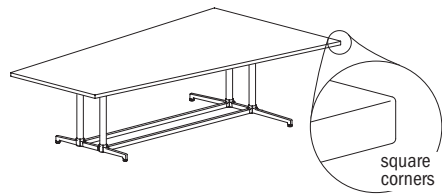

Eased Edge (R3)

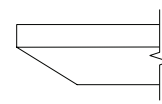

Reverse Bevel Edge (K9)

LAMI	D	W	H	CTN WT	CU FT	Model	Standard Tier 1	Graded In Tier 2	Standard Tier 1	Graded In Tier 2
		54	96	29	216	105	LKT5496-29TPT	\$4,404	\$4,475	\$5,001

Features:

- price reflects complete table - top and base
- ships KD in multiple cartons
- one piece top
- model includes adjustable glide

Options:

- specify power/charging option, see below for options and upcharges

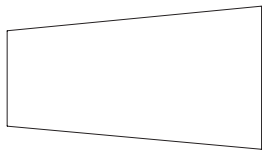

top shape

LOK - CONFERENCE

To Order Specify

1 Laminate Model #	2 Edge Detail	3 Laminate Selection	3a PVC Edge Color	4 Electrical	5 Metal Color
Laminate (LKT)	<a href="#">See Edge Detail Options</a>	<a href="#">See Laminate Selection</a>	<a href="#">See PVC Edge Color Options</a>	N None CT2 Dual Power Center Top CU2 Dual Power Underside CT2U1 Dual Power Center Top with Underside (See chart on next page)	<a href="#">See Metal Finish Color Options</a>

Model Number Breakdown

LKT5496-29TPT					
LK	T	5496	29	TP	T
LOK	Laminate	54" x 96"	Height	Taper Top Shape	T base

Description

Taper Table with T Base  
at Working Height  
(continued)

Veneer Tables  
"LKV" Models

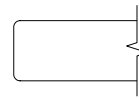

Eased Edge (R3)

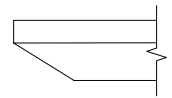

Reverse Bevel Edge (K9)

VEN.	D	W	H	CTN WT	CU FT	① Model	Essentials		Artisan	
							Essentials	Artisan	Essentials	Artisan
	54	96	29	216	105	LKV5496-29TPT	\$6,021	\$6,504	\$6,561	\$6,990

Electrical Options and Upcharges

CT2	84 - 96 wide
Dual Power Center Top - Black	CT2BL - add \$1,837
Dual Power Center Top - White	CT2WH - add \$1,837
CU1	
Single Power Underside - Black	CU1-1C - add \$731
Single Power Underside with Wireless Charging - Black	CU1-1CW - add \$1,691
CT2U1	
Dual Power Center Top - Black with Single Underside	CT2U1-BL - add \$2,235
Dual Power Center Top - White with Single Underside	CT2U1-WH - add \$2,235
Dual Power Center Top - Black with Wireless Charging	CT2U1-BLW2 - add \$3,194
Dual Power Center Top - White with Wireless Charging	CT2U1-WHW2 - add \$3,194

Note: Order power infeed that best fits application

To Order Specify

① Veneer Model #	② Edge Detail	③ Wood Collection	④ Wood Finish	⑤ Electrical	⑥ Metal Color
Veneer (LKV)	<a href="#">See Edge Detail Options</a>	Essentials	<a href="#">See Essentials Wood Finish Options</a>	N None CT2 Dual Power Center Top CU2 Dual Power Underside CT2U1 Dual Power Center Top with Underside (See chart above)	<a href="#">See Metal Finish Color Options</a>
		Artisan	④ Wood Finish <a href="#">See Artisan Wood Finish Options</a>		

Description

Rounded Taper 2pc Table with T Base at Working Height

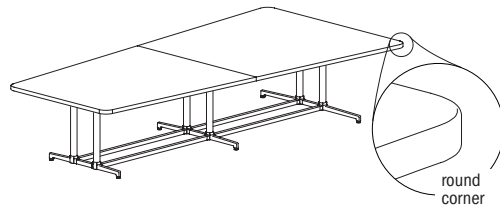

Laminate Tables  
"LKT" Models

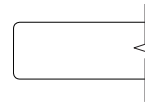

Eased Edge (R3)

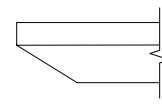

Reverse Bevel Edge (K9)

LAMI	D	W	H	CTN WT	CU FT	Model	Standard Tier 1	Graded In Tier 2	Standard Tier 1	Graded In Tier 2
		60	120	29	312	143	LKT60120-29TPRT	\$6,478	\$6,581	\$7,130

Features:

- price reflects complete table - top and base
- ships KD in multiple cartons
- two piece top
- model includes adjustable glide

Options:

- specify power/charging option, see below for options and upcharges

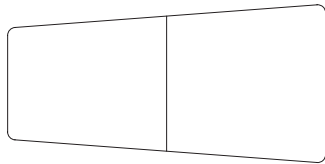

top shape

LOK - CONFERENCE

To Order Specify

1 Laminates Model #	2 Edge Detail	3 Laminates Selection	3a PVC Edge Color	4 Electrical	5 Metal Color
Laminates (LKT)	<a href="#">See Edge Detail Options</a>	<a href="#">See Laminates Selection</a>	<a href="#">See PVC Edge Color Options</a>	N None CT4 Four Power on Top CU1 Single Power Underside CT4U1 Four Power Center Top with Underside (See chart on next page)	<a href="#">See Metal Finish Color Options</a>

Model Number Breakdown

LKT60120-29TPRT						
LK	T	60120	29	TP	R	T
LOK	Laminates	60" x 120"	Height	Taper Top Shape	Rounded Corner	T base

Description

Rounded Taper 2pc Table with T Base at Working Height (continued)

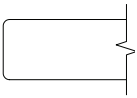
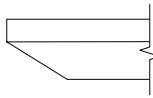
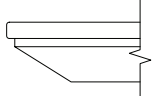
		Veneer Tables "LKV" Models				Solid Surface Tables "LKS" Models					
		 <p>Eased Edge (R3)</p>		 <p>Reverse Bevel Edge (K9)</p>		 <p>Reverse Bevel Edge (S7)</p>					
		Essentials	Artisan	Essentials	Artisan	Standard					
VEN.	D	W	H	CTN WT	CU FT	Model	Essentials	Artisan	Essentials	Artisan	Standard
	60	120	29	312	143	LKV60120-29TPRT	\$9,761	\$10,541	\$10,639	\$11,330	--
S.S.	60	120	29	312	143	LKS60120-29TPRT	--	--	--	--	\$26,991

Electrical Options and Upcharges

	120 - 192 wide
<b>CT4</b>	
Four Power Center Top - Black	CT4BL - add \$3,421
Four Power Center Top - White	CT4WH - add \$3,421
<b>CU1</b>	
Single Power Underside - Black	CU1-1C - add \$849
Single Power Underside with Wireless Charging - Black	CU1-1CW - add \$1,776
<b>CT4U1</b>	
Four Power Center Top with Underside - Black	CT4U1-BL - add \$3,906
Four Power Center Top with Underside - White	CT4U1-WH - add \$3,906
Four Power Center Top - Black with Underside & 2 Wireless Charging	CT4U1-BLW2 - add \$4,840
Four Power Center Top - White with Underside & 2 Wireless Charging	CT4U1-WHW2 - add \$4,840

LOK - CONFERENCE

Note: Order power infeed that best fits application

To Order Specify

1 Veneer Model #	2 Edge Detail	3 Wood Collection	4 Wood Finish	5 Electrical	6 Metal Color
Veneer (LKV)	<a href="#">See Edge Detail Options</a>	Essentials	<a href="#">See Essentials Wood Finish Options</a>	N None CT4 Four Power on Top CU1 Single Power Underside CT4U1 Four Power Center Top with Underside (See chart above)	<a href="#">See Metal Finish Color Options</a>
		Artisan	<b>4 Wood Finish</b> <a href="#">See Artisan Wood Finish Options</a>		
1 Solid Surface Model #	2 Top Surface Selection	3 Electrical	4 Metal Color		
Solid Surface (LKS)	<a href="#">See Solid Surface Top Surface Selection Options</a>	N None CT4 Four Power on Top CU1 Single Power Underside CT4U1 Four Power Center Top with Underside (See chart above)	<a href="#">See Metal Finish Color Options</a>		

Description

Rounded Taper Table with T Base at Working Height

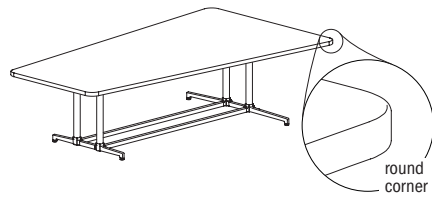

Laminate Tables "LKT" Models

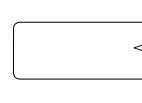

Eased Edge (R3)

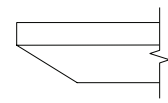

Reverse Bevel Edge (K9)

LAMI	D	W	H	CTN WT	CU FT	Model	Standard Tier 1	Graded In Tier 2	Standard Tier 1	Graded In Tier 2
		54	96	29	216	105	LKT5496-29TPRT	\$4,404	\$4,475	\$5,001

Features:

- price reflects complete table - top and base
- ships KD in multiple cartons
- one piece top
- model includes adjustable glide

Options:

- specify power/charging option, see below for options and upcharges

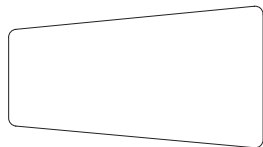

top shape

LOK - CONFERENCE

To Order Specify

1 Laminate Model #	2 Edge Detail	3 Laminate Selection	3a PVC Edge Color	4 Electrical	5 Metal Color
Laminate (LKT)	<a href="#">See Edge Detail Options</a>	<a href="#">See Laminate Selection</a>	<a href="#">See PVC Edge Color Options</a>	N None CT2 Dual Power Center Top CU2 Dual Power Underside CT2U1 Dual Power Center Top with Underside (See chart on next page)	<a href="#">See Metal Finish Color Options</a>

Model Number Breakdown

LKT5496-29TPRT						
LK	T	5496	29	TP	R	T
LOK	Laminate	54" x 96"	Height	Taper Top Shape	Rounded Corner	T base

Description

Rounded Taper Table with T Base at Working Height (continued)

Veneer Tables "LKV" Models	Solid Surface Tables "LKS" Models
----------------------------	-----------------------------------

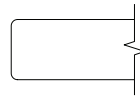

Eased Edge (R3)

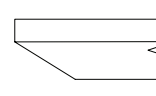

Reverse Bevel Edge (K9)

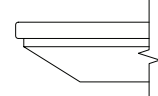

Reverse Bevel Edge (S7)

	D	W	H	CTN WT	CU FT	① Model	Veneer Tables "LKV" Models		Solid Surface Tables "LKS" Models		
							Essentials	Artisan	Essentials	Artisan	Standard
VEN.	54	96	29	216	105	LKV5496-29TPRT	\$6,021	\$6,504	\$6,561	\$6,990	--
S.S.	54	96	29	216	105	LKS5496-29TPRT	--	--	--	--	\$16,845

Electrical Options and Upcharges

<b>CT2</b>	84 - 96 wide
Dual Power Center Top - Black	CT2BL - add \$1,837
Dual Power Center Top - White	CT2WH - add \$1,837
<b>CU1</b>	
Single Power Underside - Black	CU1-1C - add \$731
Single Power Underside with Wireless Charging - Black	CU1-1CW - add \$1,691
<b>CT2U1</b>	
Dual Power Center Top - Black with Single Underside	CT2U1-BL - add \$2,235
Dual Power Center Top - White with Single Underside	CT2U1-WH - add \$2,235
Dual Power Center Top - Black with Wireless Charging	CT2U1-BLW2 - add \$3,194
Dual Power Center Top - White with Wireless Charging	CT2U1-WHW2 - add \$3,194

Note: Order power infeed that best fits application, see page 408.

To Order Specify

① Veneer Model #	② Edge Detail	③ Wood Collection	④ Wood Finish	⑤ Electrical	⑥ Metal Color
Veneer (LKV)	<a href="#">See Edge Detail Options</a>	Essentials	<a href="#">See Essentials Wood Finish Options</a>	N None CT2 Dual Power Center Top CU2 Dual Power Underside CT2U1 Dual Power Center Top with Underside (See chart above)	<a href="#">See Metal Finish Color Options</a>
		Artisan	④ Wood Finish <a href="#">See Artisan Wood Finish Options</a>		

① Solid Surface Model #	② Top Surface Selection	③ Electrical	④ Metal Color
Solid Surface (LKS)	<a href="#">See Solid Surface Top Surface Selection Options</a>	N None CT2 Dual Power Center Top CU2 Dual Power Underside (See chart above) CT2U1 Dual Power Center Top with Underside	<a href="#">See Metal Finish Color Options</a>

LOK - CONFERENCE

## Description

Taper 2pc Table with Y Base at Working Height

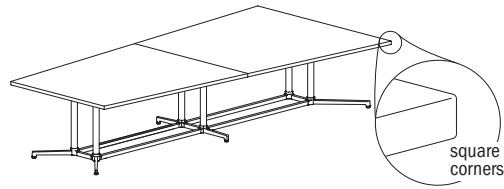

## Laminate Tables "LKT" Models

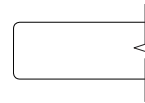

Eased Edge (R3)

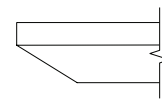

Reverse Bevel Edge (K9)

LAMI	D	W	H	CTN WT	CU FT	Model	Standard Tier 1	Graded In Tier 2	Standard Tier 1	Graded In Tier 2
		60	120	29	301	143	LKT60120-29TPY	\$6,292	\$6,388	\$6,940

### Features:

- price reflects complete table - top and base
- ships KD in multiple cartons
- two piece top
- model includes adjustable glide

### Options:

- specify power/charging option, see below for options and upcharges

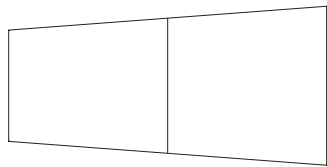

top shape

LOK - CONFERENCE

## To Order Specify

1 Laminate Model #	2 Edge Detail	3 Laminate Selection	3a PVC Edge Color	4 Electrical	5 Metal Color
Laminate (LKT)	<a href="#">See Edge Detail Options</a>	<a href="#">See Laminate Selection</a>	<a href="#">See PVC Edge Color Options</a>	N None CT4 Four Power on Top CU1 Single Power Underside CT4U1 Four Power Center Top with Underside (See chart on next page)	<a href="#">See Metal Finish Color Options</a>

## Model Number Breakdown

LKT60120-29TPY					
LK	T	60120	29	TP	Y
LOK	Laminate	60" x 120"	Height	Taper Top Shape	Y base

Description

Taper 2pc Table with Y Base  
at Working Height  
(continued)

Veneer Tables  
"LKV" Models

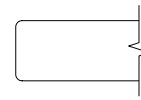

Eased Edge (R3)

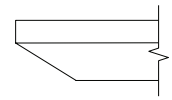

Reverse Bevel Edge (K9)

VEN.	D	W	H	CTN WT	CU FT	1 Model	Eased Edge (R3)		Reverse Bevel Edge (K9)	
							Essentials	Artisan	Essentials	Artisan
	60	120	29	301	143	LKV60120-29TPY	\$4,655	\$5,026	\$5,071	\$5,400

Electrical Options and Upcharges

	120 - 192 wide
<b>CT4</b>	
Four Power Center Top - Black	CT4BL - add \$3,421
Four Power Center Top - White	CT4WH - add \$3,421
<b>CU1</b>	
Single Power Underside - Black	CU1-1C - add \$849
Single Power Underside with Wireless Charging - Black	CU1-1CW - add \$1,776
<b>CT4U1</b>	
Four Power Center Top with Underside - Black	CT4U1-BL - add \$3,906
Four Power Center Top with Underside - White	CT4U1-WH - add \$3,906
Four Power Center Top - Black with Underside & 2 Wireless Charging	CT4U1-BLW2 - add \$4,840
Four Power Center Top - White with Underside & 2 Wireless Charging	CT4U1-WHW2 - add \$4,840

Note: Order power infed that best fits application

To Order Specify

1 Veneer Model #	2 Edge Detail	3 Wood Collection	4 Wood Finish	5 Electrical	6 Metal Color
Veneer (LKV)	<a href="#">See Edge Detail Options</a>	Essentials	<a href="#">See Essentials Wood Finish Options</a>	N None CT4 Four Power on Top CU1 Single Power Underside CT4U1 Four Power Center Top with Underside (See chart above)	<a href="#">See Metal Finish Color Options</a>
		Artisan	4 Wood Finish <a href="#">See Artisan Wood Finish Options</a>		

LOK - CONFERENCE

Description

Taper Table with Y Base at Working Height

Laminate Tables  
"LKT" Models

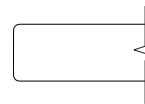
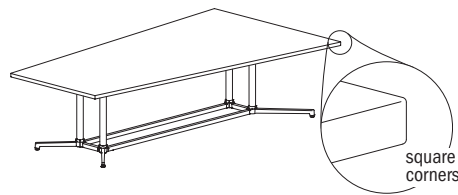

Eased Edge (R3)

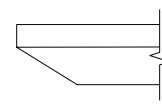

Reverse Bevel Edge (K9)

LAMI	D	W	H	CTN WT	CU FT	Model	Standard Tier 1	Graded In Tier 2	Standard Tier 1	Graded In Tier 2
		54	96	29	198	105	LKT5496-29TPY	\$2,043	\$2,111	\$2,640

Features:

- price reflects complete table - top and base
- ships KD in multiple cartons
- one piece top
- model includes adjustable glide

Options:

- specify power/charging option, see below for options and upcharges

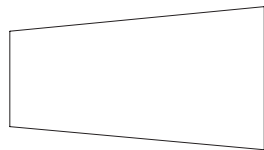

top shape

LOK - CONFERENCE

To Order Specify

1 Laminite Model #	2 Edge Detail	3 Laminite Selection	3a PVC Edge Color	4 Electrical	5 Metal Color
Laminite (LKT)	<a href="#">See Edge Detail Options</a>	<a href="#">See Laminite Selection</a>	<a href="#">See PVC Edge Color Options</a>	N None CT2 Dual Power Center Top CU2 Dual Power Underside CT2U1 Dual Power Center Top with Underside (See chart on next page)	<a href="#">See Metal Finish Color Options</a>

Model Number Breakdown

LKT5496-29TPY					
LK	T	5496	29	TP	Y
LOK	Laminite	54" x 96"	Height	Taper Top Shape	Y base

Description

Taper Table with Y Base  
at Working Height  
(continued)

Veneer Tables  
"LKV" Models

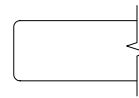

Eased Edge (R3)

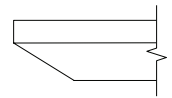

Reverse Bevel Edge (K9)

VEN.	D	W	H	CTN WT	CU FT	① Model	Eased Edge (R3)		Reverse Bevel Edge (K9)	
							Essentials	Artisan	Essentials	Artisan
54	96	29	198	105	LKV5496-29TPY	\$6,137	\$6,627	\$6,688	\$7,122	

Electrical Options and Upcharges

CT2	84 - 96 wide
Dual Power Center Top - Black	CT2BL - add \$1,837
Dual Power Center Top - White	CT2WH - add \$1,837
CU1	
Single Power Underside - Black	CU1-1C - add \$731
Single Power Underside with Wireless Charging - Black	CU1-1CW - add \$1,691
CT2U1	
Dual Power Center Top - Black with Single Underside	CT2U1-BL - add \$2,235
Dual Power Center Top - White with Single Underside	CT2U1-WH - add \$2,235
Dual Power Center Top - Black with Wireless Charging	CT2U1-BLW2 - add \$3,194
Dual Power Center Top - White with Wireless Charging	CT2U1-WHW2 - add \$3,194

Note: Order power infeed that best fits application

To Order Specify

① Veneer Model #	② Edge Detail	③ Wood Collection	④ Wood Finish	⑤ Electrical	⑥ Metal Color
Veneer (LKV)	<a href="#">See Edge Detail Options</a>	Essentials	<a href="#">See Essentials Wood Finish Options</a>	N None CT2 Dual Power Center Top CU2 Dual Power Underside CT2U1 Dual Power Center Top with Underside (See chart above)	<a href="#">See Metal Finish Color Options</a>
		Artisan	④ Wood Finish <a href="#">See Artisan Wood Finish Options</a>		

LOK - CONFERENCE

Description

Rounded Taper 2pc Table with Y Base at Working Height

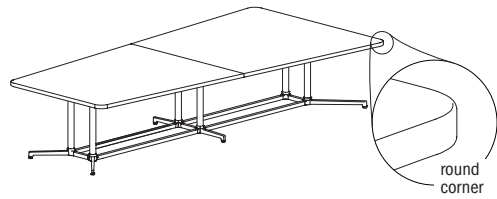

Laminate Tables  
"LKT" Models

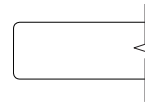

Eased Edge (R3)

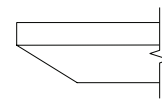

Reverse Bevel Edge (K9)

LAMI	D	W	H	CTN WT	CU FT	Model	Standard Tier 1	Graded In Tier 2	Standard Tier 1	Graded In Tier 2
		60	120	29	301	143	LKT60120-29TPRY	\$6,292	\$6,388	\$6,940

Features:

- price reflects complete table - top and base
- ships KD in multiple cartons
- two piece top
- model includes adjustable glide

Options:

- specify power/charging option, see below for options and upcharges

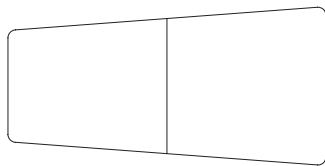

top shape

LOK - CONFERENCE

To Order Specify

1 Laminate Model #	2 Edge Detail	3 Laminate Selection	3a PVC Edge Color	4 Electrical	5 Metal Color
Laminate (LKT)	<a href="#">See Edge Detail Options</a>	<a href="#">See Laminate Selection</a>	<a href="#">See PVC Edge Color Options</a>	N None CT4 Four Power on Top CU1 Single Power Underside CT4U1 Four Power Center Top with Underside (See chart on next page)	<a href="#">See Metal Finish Color Options</a>

Model Number Breakdown

LKT60120-29TPRY						
LK	T	60120	29	TP	R	Y
LOK	Laminate	60" x 120"	Height	Taper Top Shape	Rounded Corner	Y base

Description

Rounded Taper 2pc Table with Y Base at Working Height (continued)

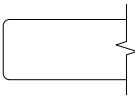
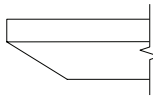
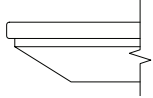
		Veneer Tables "LKV" Models				Solid Surface Tables "LKS" Models					
		 <p>Eased Edge (R3)</p>		 <p>Reverse Bevel Edge (K9)</p>		 <p>Reverse Bevel Edge (S7)</p>					
	D	W	H	CTN WT	CU FT	Model	Essentials	Artisan	Essentials	Artisan	Standard
VEN.	60	120	29	301	143	LKV60120-29TPRY	\$9,503	\$10,261	\$10,359	\$11,028	--
S.S.	60	120	29	301	143	LKS60120-29TPRY	--	--	--	--	\$26,731

Electrical Options and Upcharges

<b>CT4</b>		120 - 192 wide
Four Power Center Top - Black	CT4BL	- add \$3,421
Four Power Center Top - White	CT4WH	- add \$3,421
<b>CU1</b>		
Single Power Underside - Black	CU1-1C	- add \$849
Single Power Underside with Wireless Charging - Black	CU1-1CW	- add \$1,776
<b>CT4U1</b>		
Four Power Center Top with Underside - Black	CT4U1-BL	- add \$3,906
Four Power Center Top with Underside - White	CT4U1-WH	- add \$3,906
Four Power Center Top - Black with Underside & 2 Wireless Charging	CT4U1-BLW2	- add \$4,840
Four Power Center Top - White with Underside & 2 Wireless Charging	CT4U1-WHW2	- add \$4,840

LOK - CONFERENCE

Note: Order power infeed that best fits application

To Order Specify

1 Veneer Model #	2 Edge Detail	3 Wood Collection	4 Wood Finish	5 Electrical	6 Metal Color
Veneer (LKV)	<a href="#">See Edge Detail Options</a>	Essentials	<a href="#">See Essentials Wood Finish Options</a>	N None CT4 Four Power on Top CU1 Single Power Underside CT4U1 Four Power Center Top with Underside (See chart above)	<a href="#">See Metal Finish Color Options</a>
		Artisan	<b>4 Wood Finish</b> <a href="#">See Artisan Wood Finish Options</a>		
1 Solid Surface Model #	2 Top Surface Selection	3 Electrical	4 Metal Color		
Solid Surface (LKS)	<a href="#">See Solid Surface Top Surface Selection Options</a>	N None CT4 Four Power on Top CU1 Single Power Underside CT4U1 Four Power Center Top with Underside (See chart above)	<a href="#">See Metal Finish Color Options</a>		

Description

Rounded Taper Table with Y Base at Working Height

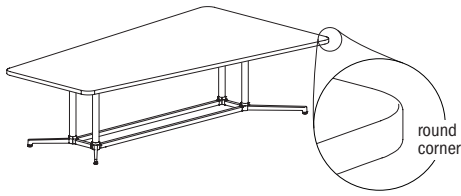

Laminate Tables "LKT" Models

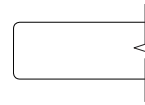

Eased Edge (R3)

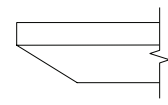

Reverse Bevel Edge (K9)

LAMI	D	W	H	CTN WT	CU FT	Model	Standard Tier 1	Graded In Tier 2	Standard Tier 1	Graded In Tier 2
		54	96	29	198	105	LKT5496-29TPRY	\$4,497	\$4,568	\$5,095

Features:

- price reflects complete table - top and base
- ships KD in multiple cartons
- one piece top
- model includes adjustable glide

Options:

- specify power/charging option, see below for options and upcharges

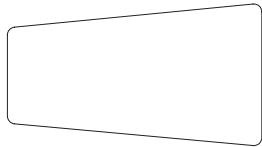

top shape

LOK - CONFERENCE

To Order Specify

1 Laminate Model #	2 Edge Detail	3 Laminate Selection	3a PVC Edge Color	4 Electrical	5 Metal Color
Laminate (LKT)	<a href="#">See Edge Detail Options</a>	<a href="#">See Laminate Selection</a>	<a href="#">See PVC Edge Color Options</a>	N None CT2 Dual Power Center Top CU2 Dual Power Underside CT2U1 Dual Power Center Top with Underside (See chart on next page)	<a href="#">See Metal Finish Color Options</a>

Model Number Breakdown

LKT5496-29TPRY						
LK	T	5496	29	TP	R	Y
LOK	Laminate	54" x 96"	Height	Taper Top Shape	Rounded Corner	Y base

Description

Rounded Taper Table with Y Base at Working Height (continued)

		Veneer Tables "LKV" Models				Solid Surface Tables "LKS" Models	
		Eased Edge (R3)		Reverse Bevel Edge (K9)		Reverse Bevel Edge (S7)	
		Essentials	Artisan	Essentials	Artisan	Standard	
VEN.	D W H CTN WT CU FT	Model	Essentials	Artisan	Essentials	Artisan	Standard
	54 96 29 198 105	LKV5496-29TPRY	\$6,137	\$6,627	\$6,688	\$7,122	--
S.S.	54 96 29 198 105	LKS5496-29TPRY	--	--	--	--	\$16,957

Electrical Options and Upcharges

CT2	84 - 96 wide
Dual Power Center Top - Black	CT2BL - add \$1,837
Dual Power Center Top - White	CT2WH - add \$1,837
CU1	
Single Power Underside - Black	CU1-1C - add \$731
Single Power Underside with Wireless Charging - Black	CU1-1CW - add \$1,691
CT2U1	
Dual Power Center Top - Black with Single Underside	CT2U1-BL - add \$2,235
Dual Power Center Top - White with Single Underside	CT2U1-WH - add \$2,235
Dual Power Center Top - Black with Wireless Charging	CT2U1-BLW2 - add \$3,194
Dual Power Center Top - White with Wireless Charging	CT2U1-WHW2 - add \$3,194

LOK - CONFERENCE

Note: Order power infeed that best fits application

To Order Specify

1 Veneer Model #	2 Edge Detail	3 Wood Collection	4 Wood Finish	5 Electrical	6 Metal Color
Veneer (LKV)	<a href="#">See Edge Detail Options</a>	Essentials	<a href="#">See Essentials Wood Finish Options</a>	N None CT2 Dual Power Center Top CU2 Dual Power Underside CT2U1 Dual Power Center Top with Underside (See chart above)	<a href="#">See Metal Finish Color Options</a>
		Artisan	<b>4 Wood Finish</b> <a href="#">See Artisan Wood Finish Options</a>		

1 Solid Surface Model #	2 Top Surface Selection	3 Electrical	4 Metal Color
Solid Surface (LKS)	<a href="#">See Solid Surface Top Surface Selection Options</a>	N None CT2 Dual Power Center Top CU2 Dual Power Underside (See chart above) CT2U1 Dual Power Center Top with Underside	<a href="#">See Metal Finish Color Options</a>

Description

Round Table with X Base  
at Working Height



Laminate Tables  
"LKT" Models

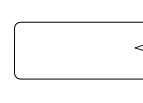

Eased Edge (R3)

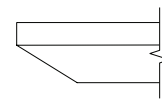

Reverse Bevel Edge (K9)

LAMINATE	D	W	H	CTN WT	CU FT	1 Model	Standard Tier 1	Graded In Tier 2	Standard Tier 1	Graded In Tier 2
		48	48	29	86	49	LKT48-29RDX	\$1,937	\$2,085	\$2,497
	42	42	29	72	38	LKT42-29RDX	\$1,769	\$1,914	\$2,330	\$2,474
	36	36	29	58	29	LKT36-29RDX	\$1,712	\$1,763	\$2,272	\$2,323
	30	30	29	58	21	LKT30-29RDX	\$1,650	\$1,692	\$2,194	\$2,253

Features:

- price reflects complete table - top and base
- ships KD in multiple cartons
- one piece top
- model includes adjustable glide
- when electrical option is selected, power accessible base is shipped; see page 178 for details
- power/charging units have 72" cord
- power cord is routed inside base column

Options:

- specify power access base with power unit option; None (N), add \$735 for EC23 (CTEC23), add \$616 for EC24 (CTEC24)

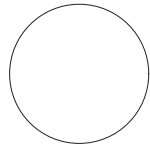

top shape

LOK - CONFERENCE

To Order Specify

1 Laminates Model #	2 Edge Detail	3 Laminates Selection	3a PVC Edge Color	4 Electrical	5 Metal Color
Laminates (LKT)	<a href="#">See Edge Detail Options</a>	<a href="#">See Laminates Selection</a>	<a href="#">See PVC Edge Color Options</a>	N None CTEC23 Power Center Top CTEC24 Power Center Top (See chart on next page)	<a href="#">See Metal Finish Color Options</a>

Model Number Breakdown

LKT48-29RDX					
LK	T	48	29	RD	X
LOK	Laminates	48" dia.	Height	Round Top Shape	X base

Description

Round Table with X Base  
at Working Height  
(continued)

Veneer Tables  
"LKV" Models

Solid Surface Tables  
"LKS" Models

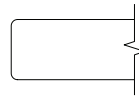

Eased Edge (R3)

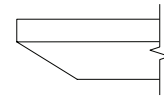

Reverse Bevel Edge (K9)

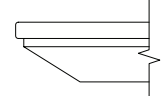

Reverse Bevel Edge (S7)

	D	W	H	CTN WT	CU FT	① Model	Veneer Tables		Solid Surface Tables		
							Essentials	Artisan	Essentials	Artisan	Standard
VENEER	48	48	29	86	49	LKV48-29RDX	\$2,595	\$2,774	\$2,698	\$2,889	--
	42	42	29	72	38	LKV42-29RDX	\$2,368	\$2,535	\$2,465	\$2,639	--
	36	36	29	58	29	LKV36-29RDX	\$2,294	\$2,455	\$2,388	\$2,555	--
	30	30	29	58	21	LKV30-29RDX	\$2,207	\$2,363	\$2,297	\$2,459	--
SOLID SURFACE	48	48	29	86	49	LKS48-29RDX	--	--	--	--	\$6,219
	42	42	29	72	38	LKS42-29RDX	--	--	--	--	\$5,281
	36	36	29	58	29	LKS36-29RDX	--	--	--	--	\$4,588
	30	30	29	47	21	LKS30-29RDX	--	--	--	--	\$3,976

Electrical Options and Upcharges

CTEC23	
EC23 Power Center Top - Black	CTEC23BL - add \$735
EC23 Power Center Top - White	CTEC23WH - add \$735
CTEC24	
EC24 Power Center Top - Black	CTEC43BL - add \$616
EC24 Power Center Top - White	CTEC43WH - add \$616

To Order Specify

① Veneer Model #	② Edge Detail	③ Wood Collection	④ Wood Finish	⑤ Electrical	⑥ Metal Color
Veneer (LKV)	<a href="#">See Edge Detail Options</a>	Essentials	<a href="#">See Essentials Wood Finish Options</a>	N None CTEC23 Power Center Top CTEC24 Power Center Top (See chart above)	<a href="#">See Metal Finish Color Options</a>
		Artisan	<a href="#">See Artisan Wood Finish Options</a>		

① Solid Surface Model #	② Top Surface Selection	③ Electrical Cut Out	④ Metal Color
Solid Surface (LKS)	<a href="#">See Solid Surface Top Surface Selection Options</a>	N None CTEC23 Power Center Top CTEC24 Power Center Top (See chart above)	<a href="#">See Metal Finish Color Options</a>

Description

Round Table with X4 Base at Working Height



Laminate Tables "LKT" Models

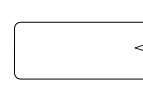

Eased Edge (R3)

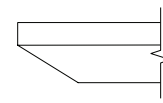

Reverse Bevel Edge (K9)

LAMINATE	D	W	H	CTN WT	CU FT	1 Model	Eased Edge (R3)		Reverse Bevel Edge (K9)	
							Standard	Graded In	Standard	Graded In
							Tier 1	Tier 2	Tier 1	Tier 2
	60	60	29	148	73	LKT60-29RDZ	\$3,156	\$3,270	\$3,717	\$3,833
	54	54	29	130	61	LKT54-29RDZ	\$3,092	\$3,180	\$3,653	\$3,743

Features:

- price reflects complete table - top and base
- ships KD in multiple cartons
- one piece top
- model includes adjustable glide
- power cord is routed outside base column
- order vertical wire manager separately; see page 408

Options:

- specify power unit option; None (N), add \$594 for EC23 (CTEC23), add \$474 for EC24 (CTEC24)

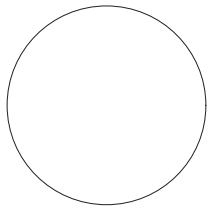

top shape

LOK - CONFERENCE

To Order Specify

1 Laminate Model #	2 Edge Detail	3 Laminate Selection	3a PVC Edge Color	4 Electrical	5 Metal Color
Laminate (LKT)	<a href="#">See Edge Detail Options</a>	<a href="#">See Laminate Selection</a>	<a href="#">See PVC Edge Color Options</a>	N None CTEC23 Power Center Top CTEC24 Power Center Top (See chart on next page)	<a href="#">See Metal Finish Color Options</a>

Model Number Breakdown

LKT60-29RDZ					
LK	T	60	29	RD	Z
LOK	Laminate	60" dia.	Height	Round Top Shape	X4 base

Description

Round Table with X4 Base  
at Working Height  
(continued)

Veneer Tables "LKV" Models      Solid Surface Tables "LKS" Models

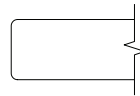

Eased Edge (R3)

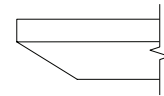

Reverse Bevel Edge (K9)

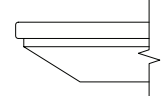

Reverse Bevel Edge (S7)

	D	W	H	CTN WT	CU FT	① Model	Veneer Tables "LKV" Models		Solid Surface Tables "LKS" Models		
							Essentials	Artisan	Essentials	Artisan	Standard
VENEER	60	60	29	148	73	LKV60-29RDZ	\$4,227	\$4,525	\$4,396	\$4,707	--
	54	54	29	130	61	LKV54-29RDZ	\$4,139	\$4,430	\$4,308	\$4,611	--
SOL. SURF.	60	60	29	148	73	LKS60-29RDZ	--	--	--	--	\$9,556
	54	54	29	130	61	LKS54-29RDZ	--	--	--	--	\$8,571

Electrical Options and Upcharges

CTEC23	
EC23 Power Center Top - Black	CTEC23BL - add \$594
EC23 Power Center Top - White	CTEC23WH - add \$594
CTEC24	
EC24 Power Center Top - Black	CTEC43BL - add \$474
EC24 Power Center Top - White	CTEC43WH - add \$474

To Order Specify

① Veneer Model #	② Edge Detail	③ Wood Collection	④ Wood Finish	⑤ Electrical	⑥ Metal Color
Veneer (LKV)	<a href="#">See Edge Detail Options</a>	Essentials	<a href="#">See Essentials Wood Finish Options</a>	N None CTEC23 Power Center Top CTEC24 Power Center Top (See chart above)	<a href="#">See Metal Finish Color Options</a>
		Artisan	<a href="#">See Artisan Wood Finish Options</a>		

① Solid Surface Model #	② Top Surface Selection	③ Electrical Cut Out	④ Metal Color
Solid Surface (LKS)	<a href="#">See Solid Surface Top Surface Selection Options</a>	N None CTEC23 Power Center Top CTEC24 Power Center Top (See chart above)	<a href="#">See Metal Finish Color Options</a>

LOK-CONFERENCE

Description

Square Table with X Base at Working Height

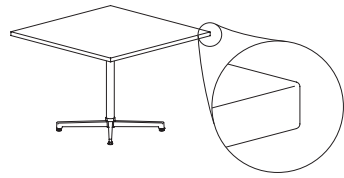

Laminate Tables "LKT" Models

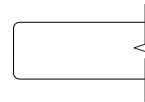

Eased Edge (R3)

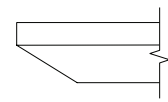

Reverse Bevel Edge (K9)

LAMINATE	D	W	H	CTN WT	CU FT	1 Model	Standard Tier 1	Graded In Tier 2	Standard Tier 1	Graded In Tier 2
		48	48	29	103	49	LKT4848-29SQX	\$1,981	\$2,049	\$2,542
	42	42	29	85	38	LKT4242-29SQX	\$1,816	\$1,881	\$2,378	\$2,442
	36	36	29	69	29	LKT3636-29SQX	\$1,599	\$1,652	\$2,315	\$2,337
	30	30	29	53	21	LKT3030-29SQX	\$1,426	\$1,470	\$1,987	\$2,028

Features:

- price reflects complete table - top and base
- ships KD in multiple cartons
- one piece top
- model includes adjustable glide
- when electrical option is selected, power accessible base is shipped; see page 178 for details
- power/charging units have 72" cord
- power cord is routed inside base column

Options:

- specify power access base with power unit option; None (N), add \$735 for EC23 (CTEC23), add \$616 for EC24 (CTEC24)



top shape

LOK - CONFERENCE

To Order Specify

1 Laminate Model #	2 Edge Detail	3 Laminate Selection	3a PVC Edge Color	4 Electrical	5 Metal Color
Laminate (LKT)	<a href="#">See Edge Detail Options</a>	<a href="#">See Laminate Selection</a>	<a href="#">See PVC Edge Color Options</a>	N None CTEC23 Power Center Top CTEC24 Power Center Top (See chart on next page)	<a href="#">See Metal Finish Color Options</a>

Model Number Breakdown

LKT4848-29SQX					
LK	T	4848	29	SQ	X
LOK	Laminate	48" x 48"	Height	Square Top Shape	X base

Description

Square Table with X Base  
at Working Height  
(continued)

Veneer Tables  
"LKV" Models

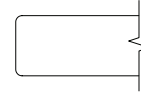

Eased Edge (R3)

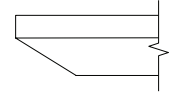

Reverse Bevel Edge (K9)

D	W	H	CTN WT	CU FT	① Model	Eased Edge (R3)		Reverse Bevel Edge (K9)	
						Essentials	Artisan	Essentials	Artisan
48	48	29	103	49	LKV4848-29SQX	\$2,613	\$2,797	\$2,718	\$2,910
42	42	29	85	38	LKV4242-29SQX	\$2,397	\$2,563	\$2,493	\$2,667
36	36	29	69	29	LKV3636-29SQX	\$2,110	\$2,261	\$2,197	\$2,350
30	30	29	53	21	LKV3030-29SQX	\$1,882	\$2,015	\$1,959	\$2,096

VENEER

LOK- CONFERENCE

Electrical Options and Upcharges

CTEC23	
EC23 Power Center Top - Black	CTEC23BL - add \$735
EC23 Power Center Top - White	CTEC23WH - add \$735
CTEC24	
EC24 Power Center Top - Black	CTEC43BL - add \$616
EC24 Power Center Top - White	CTEC43WH - add \$616

To Order Specify

① Veneer Model #	② Edge Detail	③ Wood Collection	④ Wood Finish	⑤ Electrical	⑥ Metal Color
Veneer (LKV)	<a href="#">See Edge Detail Options</a>	Essentials	<a href="#">See Essentials Wood Finish Options</a>	N None CTEC23 Power Center Top CTEC24 Power Center Top (See chart above)	<a href="#">See Metal Finish Color Options</a>
		Artisan	④ Wood Finish <a href="#">See Artisan Wood Finish Options</a>		

Description

Rounded Square Table with X Base at Working Height

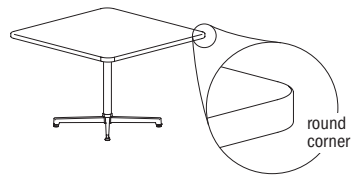

Laminate Tables  
"LKT" Models

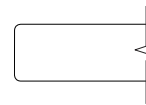

Eased Edge (R3)

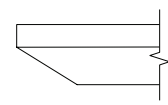

Reverse Bevel Edge (K9)

LAMINATE	D	W	H	CTN WT	CU FT	1 Model	Standard Tier 1	Graded In Tier 2	Standard Tier 1	Graded In Tier 2
		48	48	29	103	49	LKT4848-29SQRX	\$2,438	\$2,504	\$2,997
	42	42	29	85	38	LKT4242-29SQRX	\$2,254	\$2,319	\$2,815	\$2,884
	36	36	29	69	29	LKT3636-29SQRX	\$1,861	\$1,912	\$2,420	\$2,474
	30	30	29	53	21	LKT3030-29SQRX	\$1,653	\$1,698	\$2,213	\$2,259

Features:

- price reflects complete table - top and base
- ships KD in multiple cartons
- one piece top
- model includes adjustable glide
- when electrical option is selected, power accessible base is shipped; see page 178 for details
- power/charging units have 72" cord
- power cord is routed inside base column

Options:

- specify power access base with power unit option; None (N), add \$735 for EC23 (CTEC23), add \$616 for EC24 (CTEC24)

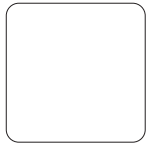

top shape

LOK - CONFERENCE

To Order Specify

1 Laminite Model #	2 Edge Detail	3 Laminite Selection	3a PVC Edge Color	4 Electrical	5 Metal Color
Laminite (LKT)	<a href="#">See Edge Detail Options</a>	<a href="#">See Laminite Selection</a>	<a href="#">See PVC Edge Color Options</a>	N None CTEC23 Power Center Top CTEC24 Power Center Top (See chart on next page)	<a href="#">See Metal Finish Color Options</a>

Model Number Breakdown

LKT4848-29SQRX						
LK	T	4848	29	SQ	R	X
LOK	Laminite	48" x 48"	Height	Square Top Shape	Round Corner	X base

Description

Rounded Square Table with X Base at Working Height (continued)

		Veneer Tables "LKV" Models				Solid Surface Tables "LKS" Models						
		Eased Edge (R3)		Reverse Bevel Edge (K9)		Reverse Bevel Edge (S7)						
		D	W	H	CTN WT	CU FT	Model	Essentials	Artisan	Essentials	Artisan	Standard
VENEER		48	48	29	103	49	LKV4848-29SQRX	\$3,214	\$3,439	\$3,344	\$3,578	--
		42	42	29	85	38	LKV4242-29SQRX	\$2,986	\$3,194	\$3,108	\$3,324	--
		36	36	29	69	29	LKV3636-29SQRX	\$2,455	\$2,627	\$2,553	\$2,733	--
		30	30	29	53	21	LKV3030-29SQRX	\$2,183	\$2,336	\$2,269	\$2,429	--
SOLID SURFACE		48	48	29	103	49	LKS4848-29SQRX	--	--	--	--	\$6,837
		42	42	29	85	38	LKS4242-29SQRX	--	--	--	--	\$5,898
		36	36	29	69	29	LKS3636-29SQRX	--	--	--	--	\$4,749
		30	30	29	53	21	LKS3030-29SQRX	--	--	--	--	\$3,954

Electrical Options and Upcharges

CTEC23	
EC23 Power Center Top - Black	CTEC23BL - add \$735
EC23 Power Center Top - White	CTEC23WH - add \$735
CTEC24	
EC24 Power Center Top - Black	CTEC43BL - add \$616
EC24 Power Center Top - White	CTEC43WH - add \$616

To Order Specify

1 Veneer Model #	2 Edge Detail	3 Wood Collection	4 Wood Finish	5 Electrical	6 Metal Color
Veneer (LKV)	<a href="#">See Edge Detail Options</a>	Essentials	<a href="#">See Essentials Wood Finish Options</a>	N None CTEC23 Power Center Top CTEC24 Power Center Top (See chart above)	<a href="#">See Metal Finish Color Options</a>
		Artisan	<a href="#">See Artisan Wood Finish Options</a>		

1 Solid Surface Model #	2 Top Surface Selection	3 Electrical Cut Out	4 Metal Color
Solid Surface (LKS)	<a href="#">See Solid Surface Top Surface Selection Options</a>	N None CTEC23 Power Center Top CTEC24 Power Center Top (See chart above)	<a href="#">See Metal Finish Color Options</a>

LOK - CONFERENCE

Description

Square Table with X4 Base at Working Height

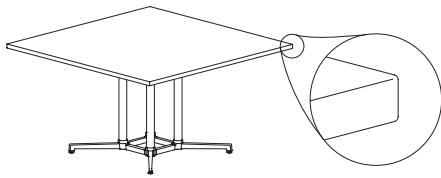

Laminate Tables "LKT" Models

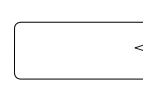

Eased Edge (R3)

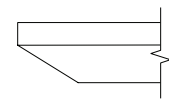

Reverse Bevel Edge (K9)

LAMINATE	D	W	H	CTN WT	CU FT	Model	Eased Edge (R3)		Reverse Bevel Edge (K9)	
							Standard	Graded In	Standard	Graded In
							Tier 1	Tier 2	Tier 1	Tier 2
	60	60	29	174	73	LKT6060-29SQZ	\$3,624	\$3,736	\$4,183	\$4,298
	54	54	29	151	61	LKT5454-29SQZ	\$3,436	\$3,538	\$3,999	\$4,099

Features:

- price reflects complete table - top and base
- ships KD in multiple cartons
- one piece top
- model includes adjustable glide
- power cord is routed outside base column
- order vertical wire manager separately; see page 408

Options:

- specify power unit option; None (N), add \$594 for EC23 (CTEC23), add \$474 for EC24 (CTEC24)

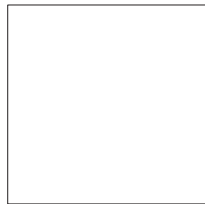

top shape

LOK - CONFERENCE

To Order Specify

1 Laminates Model #	2 Edge Detail	3 Laminates Selection	3a PVC Edge Color	4 Electrical	5 Metal Color
Laminates (LKT)	<a href="#">See Edge Detail Options</a>	<a href="#">See Laminates Selection</a>	<a href="#">See PVC Edge Color Options</a>	N None CTEC23 Power Center Top CTEC24 Power Center Top (See chart on next page)	<a href="#">See Metal Finish Color Options</a>

Model Number Breakdown

LKT6060-29SQZ					
LK	T	6060	29	SQ	Z
LOK	Laminates	60" x 60"	Height	Square Top Shape	X4 base

Description

Square Table with X4 Base  
at Working Height  
(continued)

Veneer Tables  
"LKV" Models

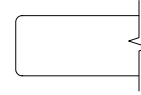

Eased Edge (R3)

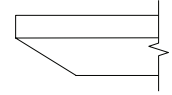

Reverse Bevel Edge (K9)

VENEER	D	W	H	CTN WT	CU FT	① Model	Eased Edge (R3)		Reverse Bevel Edge (K9)	
							Essentials	Artisan	Essentials	Artisan
	60	60	29	174	73	LKV6060-29SQZ	\$4,780	\$5,117	\$4,973	\$5,320
	54	54	29	151	61	LKV5454-29SQZ	\$4,536	\$4,855	\$4,717	\$5,049

LOK - CONFERENCE

Electrical Options and Upcharges

CTEC23	
EC23 Power Center Top - Black	CTEC23BL - add \$594
EC23 Power Center Top - White	CTEC23WH - add \$594
CTEC24	
EC24 Power Center Top - Black	CTEC43BL - add \$474
EC24 Power Center Top - White	CTEC43WH - add \$474

To Order Specify

① Veneer Model #	② Edge Detail	③ Wood Collection	④ Wood Finish	⑤ Electrical	⑥ Metal Color
Veneer (LKV)	<a href="#">See Edge Detail Options</a>	Essentials	<a href="#">See Essentials Wood Finish Options</a>	N None CTEC23 Power Center Top CTEC24 Power Center Top (See chart above)	<a href="#">See Metal Finish Color Options</a>
		Artisan	④ Wood Finish <a href="#">See Artisan Wood Finish Options</a>		

Description

Rounded Square Table with X4 Base at Working Height

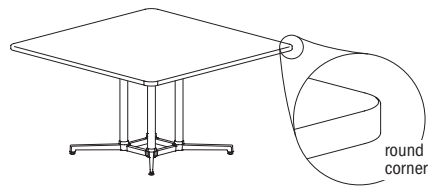

Laminate Tables "LKT" Models

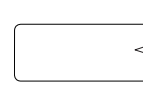

Eased Edge (R3)

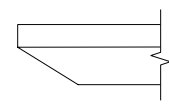

Reverse Bevel Edge (K9)

LAMINATE	D	W	H	CTN WT	CU FT	Model	Eased Edge (R3)		Reverse Bevel Edge (K9)	
							Standard	Graded In	Standard	Graded In
							Tier 1	Tier 2	Tier 1	Tier 2
	60	60	29	174	73	LKT6060-29SQRZ	\$3,913	\$4,013	\$4,473	\$4,573
	54	54	29	151	61	LKT5454-29SQRZ	\$3,193	\$3,296	\$3,755	\$3,854

Features:

- price reflects complete table - top and base
- ships KD in multiple cartons
- one piece top
- model includes adjustable glide
- power cord is routed outside base column
- order vertical wire manager separately; see page 408

Options:

- specify power unit option; None (N), add \$594 for EC23 (CTEC23), add \$474 for EC24 (CTEC24)

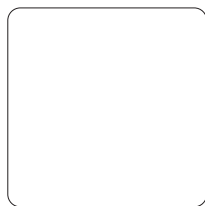

top shape

LOK - CONFERENCE

To Order Specify

1 Laminate Model #	2 Edge Detail	3 Laminate Selection	3a PVC Edge Color	4 Electrical	5 Metal Color
Laminate (LKT)	<a href="#">See Edge Detail Options</a>	<a href="#">See Laminate Selection</a>	<a href="#">See PVC Edge Color Options</a>	N None CTEC23 Power Center Top CTEC24 Power Center Top (See chart on next page)	<a href="#">See Metal Finish Color Options</a>

Model Number Breakdown

LKT6060-29SQRZ						
LK	T	6060	29	SQ	R	Z
LOK	Laminate	60" x 60"	Height	Square Top Shape	Round Corner	X4 base

Description

Rounded Square Table with X4 Base at Working Height (continued)

Veneer Tables "LKV" Models      Solid Surface Tables "LKS" Models

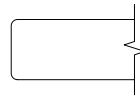

Eased Edge (R3)

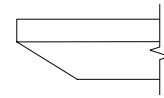

Reverse Bevel Edge (K9)

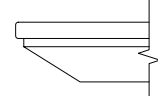

Reverse Bevel Edge (S7)

	D	W	H	CTN WT	CU FT	① Model	Veneer Tables "LKV" Models		Solid Surface Tables "LKS" Models		
							Essentials	Artisan	Essentials	Artisan	Standard
VENEER	60	60	29	174	73	LKV6060-29SQRZ	\$5,163	\$5,526	\$5,370	\$5,747	--
	54	54	29	151	61	LKV5454-29SQRZ	\$4,215	\$4,510	\$4,383	\$4,691	--
SOL. SURF.	60	60	29	174	73	LKS6060-29SQRZ	--	--	--	--	\$10,491
	54	54	29	151	61	LKS5454-29SQRZ	--	--	--	--	\$8,647

Electrical Options and Upcharges

CTEC23	
EC23 Power Center Top - Black	CTEC23BL - add \$594
EC23 Power Center Top - White	CTEC23WH - add \$594
CTEC24	
EC24 Power Center Top - Black	CTEC43BL - add \$474
EC24 Power Center Top - White	CTEC43WH - add \$474

To Order Specify

① Veneer Model #	② Edge Detail	③ Wood Collection	④ Wood Finish	⑤ Electrical	⑥ Metal Color
Veneer (LKV)	<a href="#">See Edge Detail Options</a>	Essentials	<a href="#">See Essentials Wood Finish Options</a>	N None CTEC23 Power Center Top CTEC24 Power Center Top (See chart above)	<a href="#">See Metal Finish Color Options</a>
		Artisan	<a href="#">See Artisan Wood Finish Options</a>		

① Solid Surface Model #	② Top Surface Selection	③ Electrical Cut Out	④ Metal Color
Solid Surface (LKS)	<a href="#">See Solid Surface Top Surface Selection Options</a>	N None CTEC23 Power Center Top CTEC24 Power Center Top (See chart above)	<a href="#">See Metal Finish Color Options</a>

LOK - CONFERENCE

Description

Squire Table with X Base at Working Height



Laminate Tables "LKT" Models

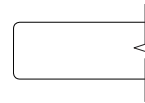

Eased Edge (R3)

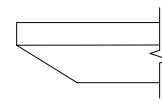

Reverse Bevel Edge (K9)

LAMINATE	D	W	H	CTN WT	CU FT	① Model	Eased Edge (R3)		Reverse Bevel Edge (K9)	
							Standard Tier 1	Graded In Tier 2	Standard Tier 1	Graded In Tier 2
	48	48	29	92	49	LKT48-29SCX	\$1,964	\$2,108	\$2,525	\$2,673
42	42	29	101	38	LKT42-29SCX	\$1,794	\$1,941	\$2,359	\$2,503	
36	36	29	62	29	LKT36-29SCX	\$1,737	\$1,789	\$2,298	\$2,352	
30	30	29	61	21	LKT30-29SCX	\$1,673	\$1,714	\$2,235	\$2,279	

Features:

- price reflects complete table - top and base
- ships KD in multiple cartons
- one piece top
- model includes adjustable glide
- when electrical option is selected, power accessible base is shipped; see page 178 for details
- power/charging units have 72" cord
- power cord is routed inside base column

Options:

- specify power access base with power unit option; None (N), add \$735 for EC23 (CTEC23), add \$616 for EC24 (CTEC24)

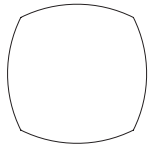

top shape

LOK - CONFERENCE

To Order Specify

① Laminate Model #	② Edge Detail	③ Laminate Selection	④ PVC Edge Color	⑤ Electrical	⑥ Metal Color
Laminate (LKT)	<a href="#">See Edge Detail Options</a>	<a href="#">See Laminate Selection</a>	<a href="#">See PVC Edge Color Options</a>	N None CTEC23 Power Center Top CTEC24 Power Center Top (See chart on next page)	<a href="#">See Metal Finish Color Options</a>

Model Number Breakdown

LKT48-29SQX					
LK	T	48	29	SQ	X
LOK	Laminate	48" dia.	Height	Squire Top Shape	X base

Description

Squirrel Table with X Base at Working Height (continued)

		Veneer Tables "LKV" Models				Solid Surface Tables "LKS" Models						
		Eased Edge (R3)		Reverse Bevel Edge (K9)		Reverse Bevel Edge (S7)						
		D	W	H	CTN WT	CU FT	Model	Essentials	Artisan	Essentials	Artisan	Standard
VENEER		48	48	29	92	49	LKV48-29SCX	\$2,620	\$2,801	\$2,727	\$2,916	--
		42	42	29	101	38	LKV42-29SCX	\$2,397	\$2,560	\$2,493	\$2,666	--
		36	36	29	62	29	LKV36-29SCX	\$2,318	\$2,479	\$2,412	\$2,582	--
		30	30	29	61	21	LKV30-29SCX	\$2,233	\$2,388	\$2,322	\$2,486	--
SOLID SURFACE		48	48	29	92	49	LKS48-29SCX	--	--	--	--	\$6,267
		42	42	29	101	38	LKS42-29SCX	--	--	--	--	\$5,331
		36	36	29	62	29	LKS36-29SCX	--	--	--	--	\$4,637
		30	30	29	61	21	LKS30-29SCX	--	--	--	--	\$4,028

Electrical Options and Upcharges

<b>CTEC23</b>	
EC23 Power Center Top - Black	CTEC23BL - add \$735
EC23 Power Center Top - White	CTEC23WH - add \$735
<b>CTEC24</b>	
EC24 Power Center Top - Black	CTEC43BL - add \$616
EC24 Power Center Top - White	CTEC43WH - add \$616

To Order Specify

1 Veneer Model #	2 Edge Detail	3 Wood Collection	4 Wood Finish	5 Electrical	6 Metal Color
Veneer (LKV)	<a href="#">See Edge Detail Options</a>	Essentials	<a href="#">See Essentials Wood Finish Options</a>	N None CTEC23 Power Center Top CTEC24 Power Center Top (See chart above)	<a href="#">See Metal Finish Color Options</a>
		Artisan	<b>4 Wood Finish</b> <a href="#">See Artisan Wood Finish Options</a>		

1 Solid Surface Model #	2 Top Surface Selection	3 Electrical Cut Out	4 Metal Color
Solid Surface (LKS)	<a href="#">See Solid Surface Top Surface Selection Options</a>	N None CTEC23 Power Center Top CTEC24 Power Center Top (See chart above)	<a href="#">See Metal Finish Color Options</a>

LOK- CONFERENCE

Description

Squircle Table with X4 Base at Working Height



Laminate Tables "LKT" Models

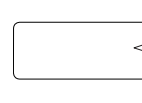

Eased Edge (R3)

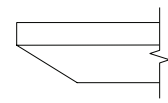

Reverse Bevel Edge (K9)

LAMINATE	D	W	H	CTN WT	CU FT	Model	Eased Edge (R3)		Reverse Bevel Edge (K9)	
							Standard	Graded In	Standard	Graded In
							Tier 1	Tier 2	Tier 1	Tier 2
	60	60	29	156	74	LKT60-29SCZ	\$3,180	\$3,298	\$3,744	\$3,861
	54	54	29	138	61	LKT54-29SCZ	\$3,116	\$3,209	\$3,680	\$3,770

Features:

- price reflects complete table - top and base
- ships KD in multiple cartons
- one piece top
- model includes adjustable glide
- power cord is routed outside base column
- order vertical wire manager separately; see page 408

Options:

- specify power unit option; None (N), add \$594 for EC23 (CTEC23), add \$474 for EC24 (CTEC24)

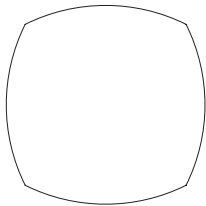

top shape

LOK - CONFERENCE

To Order Specify

1 Laminate Model #	2 Edge Detail	3 Laminate Selection	3a PVC Edge Color	4 Electrical	5 Metal Color
Laminate (LKT)	<a href="#">See Edge Detail Options</a>	<a href="#">See Laminate Selection</a>	<a href="#">See PVC Edge Color Options</a>	N None CTEC23 Power Center Top CTEC24 Power Center Top (See chart on next page)	<a href="#">See Metal Finish Color Options</a>

Model Number Breakdown

LKT60-29SCZ					
LK	T	60	29	SC	Z
LOK	Laminate	60" dia.	Height	Squircle Top Shape	X4 base

Description

Squirrel Table with X4 Base at Working Height (continued)

Veneer Tables "LKV" Models      Solid Surface Tables "LKS" Models

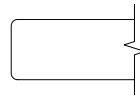

Eased Edge (R3)

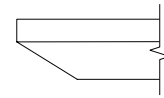

Reverse Bevel Edge (K9)

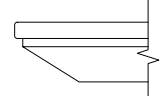

Reverse Bevel Edge (S7)

	D	W	H	CTN WT	CU FT	① Model	Veneer Tables "LKV" Models		Solid Surface Tables "LKS" Models		
							Essentials	Artisan	Essentials	Artisan	Standard
VENEER	60	60	29	156	74	LKV60-29SCZ	\$4,253	\$4,551	\$4,425	\$4,734	--
	54	54	29	138	61	LKV54-29SCZ	\$4,168	\$4,458	\$4,335	\$4,634	--
SOL. SURF.	60	60	29	156	74	LKS60-29SCZ	--	--	--	--	\$9,605
	54	54	29	138	61	LKS54-29SCZ	--	--	--	--	\$8,620

Electrical Options and Upcharges

CTEC23	
EC23 Power Center Top - Black	CTEC23BL - add \$594
EC23 Power Center Top - White	CTEC23WH - add \$594
CTEC24	
EC24 Power Center Top - Black	CTEC43BL - add \$474
EC24 Power Center Top - White	CTEC43WH - add \$474

To Order Specify

① Veneer Model #	② Edge Detail	③ Wood Collection	④ Wood Finish	⑤ Electrical	⑥ Metal Color
Veneer (LKV)	<a href="#">See Edge Detail Options</a>	Essentials	<a href="#">See Essentials Wood Finish Options</a>	N None CTEC23 Power Center Top CTEC24 Power Center Top (See chart above)	<a href="#">See Metal Finish Color Options</a>
		Artisan	④ Wood Finish <a href="#">See Artisan Wood Finish Options</a>		

① Solid Surface Model #	② Top Surface Selection	③ Electrical Cut Out	④ Metal Color
Solid Surface (LKS)	<a href="#">See Solid Surface Top Surface Selection Options</a>	N None CTEC23 Power Center Top CTEC24 Power Center Top (See chart above)	<a href="#">See Metal Finish Color Options</a>

LOK - CONFERENCE

Description

Hive Table with T Base at Working Height

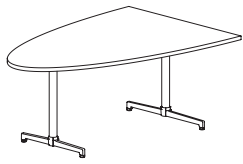

Laminate Tables  
"LKT" Models

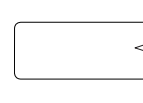

Eased Edge (R3)

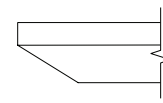

Reverse Bevel Edge (K9)

LAMI	D	W	H	CTN WT	CU FT	① Model	Standard Tier 1	Graded In Tier 2	Standard Tier 1	Graded In Tier 2
		48	72	29	135	71	LKT4872-29HVT	\$2,518	\$2,568	\$3,127

Features:

- price reflects complete table - top and base
- ships KD in multiple cartons

Options:

- specify power/charging option, see below for options and upcharges
- specify glide (G) or caster (C) -choice of black (BL) or white/grey casters (WG)

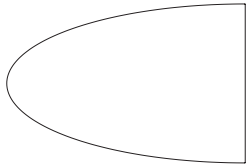

top shape

LOK - CONFERENCE

To Order Specify

① Laminate Model #	② Edge Detail	③ Laminate Selection	③a PVC Edge Color	④ Electrical
Laminate (LKT)	<a href="#">See Edge Detail Options</a>	<a href="#">See Laminate Selection</a>	<a href="#">See PVC Edge Color Options</a>	N None CT2 Dual Power Center Top (See chart on next page) CU1 Single Power Underside <b>⑤ Foot/Caster</b> G Glide C Caster - BL Black Caster - WG White Caster w/Grey Wheels <b>⑥ Metal Finish</b> <a href="#">See Metal Finish Color Options</a>

Model Number Breakdown

LKT4872-29HVT					
LK	T	4872	29	HV	T
LOK	Laminate	48" x 72"	Height	Hive Top Shape	T base

Description

Hive Table with T Base at Working Height (continued)

Veneer Tables "LKV" Models

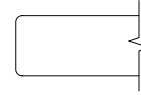

Eased Edge (R3)

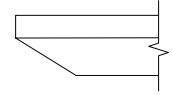

Reverse Bevel Edge (K9)

VEN.	D	W	H	CTN WT	CU FT	① Model	Essentials		Artisan	
							Price	Price	Price	Price
	48	72	29	135	71	LKV4872-29HVT	\$3,223	\$3,480	\$3,514	\$3,744

Electrical Options and Upcharges

CT2	
Dual Power Center Top - Black	CT2BL - add \$1,773
Dual Power Center Top - White	CT2WH - add \$1,773
CU1	
Single Power Underside - Black	CU11C - add \$711
Single Power Underside with Wireless Charging - Black	CU11CW - add \$1,651

Note: Order power infeed that best fits application, see page 408.

To Order, Specify:

① Veneer Model #	② Edge Detail	③ Wood Collection	④ Top Wood Finish	⑤ Electrical	⑥ Base - Foot/Caster	⑦ Metal Color
Veneer (LKV)	<a href="#">See Edge Detail Options</a>	Essentials	<a href="#">See Essentials Wood Finish Options</a>	N None CT2 Dual Power Center Top CU1 Single Power Underside (See chart above)	G Glide C Caster - BL Black Caster - WG White Caster with Grey Wheels	<a href="#">See Metal Finish Color Options</a>
		Artisan	④ Top Wood Finish <a href="#">See Artisan Wood Finish Options</a>			

Description

Rectangular Table with T Base at Counter Height

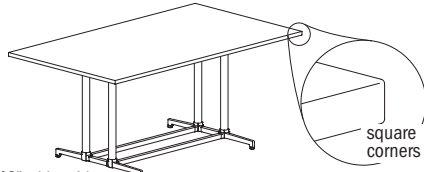

48" wide tables have double column base

D	W	H	CTN WT	CU FT	Model
48	96	36	233	115	LKT4896-36TTT
48	84	36	209	101	LKT4884-36TTT
42	96	36	186	83	LKT4296-36TTT
42	84	36	167	90	LKT4284-36TTT
36	96	36	166	89	LKT3696-36TTT
36	84	36	149	78	LKT3684-36TTT

LAMINATE

Laminate Tables "LKT" Models

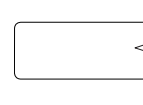

Eased Edge (R3)

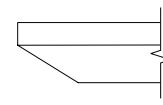

Reverse Bevel Edge (K9)

Eased Edge (R3)		Reverse Bevel Edge (K9)	
Standard Tier 1	Graded In Tier 2	Standard Tier 1	Graded In Tier 2
\$4,051	\$4,114	\$4,632	\$4,694
\$3,706	\$3,761	\$4,273	\$4,327
\$3,630	\$3,683	\$4,192	\$4,251
\$3,013	\$3,063	\$3,569	\$3,616
\$3,073	\$3,124	\$3,629	\$3,675
\$2,773	\$2,816	\$3,316	\$3,356

Features:

- price reflects complete table - top and base
- ships KD in multiple cartons
- one piece top
- model includes adjustable glide

Options:

- specify power/charging option, see below for options and upcharges

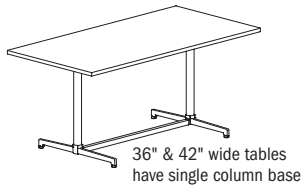

36" & 42" wide tables have single column base



top shape

LOK - CONFERENCE

To Order Specify

1 Laminate Model #	2 Edge Detail	3 Laminate Selection	3a PVC Edge Color	4 Electrical	5 Metal Color
Laminate (LKT)	<a href="#">See Edge Detail Options</a>	<a href="#">See Laminate Selection</a>	<a href="#">See PVC Edge Color Options</a>	N None CT2 Dual Power Center Top CU2 Dual Power Underside CT2U1 Dual Power Center Top with Underside (See chart on next page)	<a href="#">See Metal Finish Color Options</a>

Model Number Breakdown

LKT4896-36TTT					
LK	T	4896	36	TT	T
LOK	Laminate	48" x 96"	Height	Rectangular Top Shape	T base

Description

Rectangular Table with T Base  
at Counter Height  
(continued)

Veneer Tables  
"LKV" Models

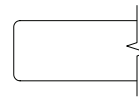

Eased Edge (R3)

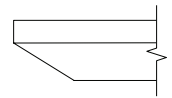

Reverse Bevel Edge (K9)

D	W	H	CTN WT	CU FT	① Model	Essentials		Artisan	
						Essentials	Artisan	Essentials	Artisan
48	96	36	233	115	LKV4896-36TTT	\$5,621	\$6,037	\$6,002	\$6,389
48	84	36	209	101	LKV4884-36TTT	\$5,250	\$5,611	\$5,607	\$5,939
42	96	36	186	83	LKV4296-36TTT	\$5,395	\$5,825	\$5,882	\$6,262
	84	36	167	90	LKV4284-36TTT	\$4,559	\$4,924	\$4,970	\$5,292
36	96	36	166	89	LKV3696-36TTT	\$4,142	\$4,474	\$4,515	\$4,809
36	84	36	149	78	LKV3684-36TTT	\$3,830	\$4,135	\$4,173	\$4,444

VENEER

Electrical Options and Upcharges

CT2	84 - 96 wide
Dual Power Center Top - Black	CT2BL - add \$1,837
Dual Power Center Top - White	CT2WH - add \$1,837
CU1	
Dual Power Underside - Black	CU1-1C - add \$731
Dual Power Underside with Wireless Charging - Black	CU1-1CW - add \$1,691
CT2U1	
Dual Power Center Top - Black with Underside	CT2U1-BL - add \$2,235
Dual Power Center Top - White with Underside	CT2U1-WH - add \$2,235
Dual Power Center Top - Black with Wireless Charging	CT2U1-BLW2 - add \$3,194
Dual Power Center Top - White with Wireless Charging	CT2U1-WHW2 - add \$3,194

Note: Order power infeed that best fits application

To Order Specify

① Veneer Model #	② Edge Detail	③ Wood Collection	④ Wood Finish	⑤ Electrical	⑥ Metal Color
Veneer (LKV)	<a href="#">See Edge Detail Options</a>	Essentials	<a href="#">See Essentials Wood Finish Options</a>	N None CT2 Dual Power Center Top CU2 Dual Power Underside CT2U1 Dual Power Center Top with Underside (See chart above)	<a href="#">See Metal Finish Color Options</a>
		Artisan	④ Wood Finish <a href="#">See Artisan Wood Finish Options</a>		

LOK - CONFERENCE

Description

Rounded Rectangular Table with T Base at Counter Height

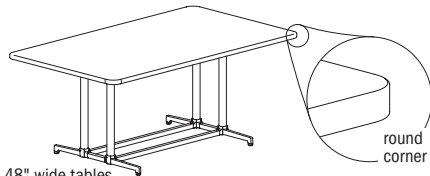

48" wide tables have double column base

D	W	H	CTN WT	CU FT	Model
48	96	36	233	115	LKT4896-36TTRT
48	84	36	209	101	LKT4884-36TTRT
42	96	36	186	83	LKT4296-36TTRT
42	84	36	167	90	LKT4284-36TTRT
36	96	36	166	89	LKT3696-36TTRT
36	84	36	149	78	LKT3684-36TTRT

LAMINATE

Laminate Tables "LKT" Models

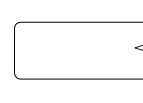

Eased Edge (R3)

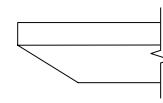

Reverse Bevel Edge (K9)

Eased Edge (R3)		Reverse Bevel Edge (K9)	
Standard Tier 1	Graded In Tier 2	Standard Tier 1	Graded In Tier 2
\$4,151	\$4,214	\$4,734	\$4,796
\$3,775	\$3,831	\$4,343	\$4,400
\$3,697	\$3,755	\$4,265	\$4,321
\$3,079	\$3,128	\$3,634	\$3,683
\$3,142	\$3,188	\$3,692	\$3,737
\$2,838	\$2,879	\$3,377	\$3,419

Features:

- price reflects complete table - top and base
- ships KD in multiple cartons
- one piece top
- model includes adjustable glide

Options:

- specify power/charging option, see below for options and upcharges

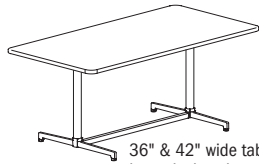

36" & 42" wide tables have single column base

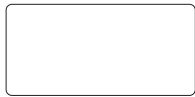

top shape

LOK - CONFERENCE

To Order Specify

1 Laminate Model #	2 Edge Detail	3 Laminate Selection	3a PVC Edge Color	4 Electrical	5 Metal Color
Laminate (LKT)	<a href="#">See Edge Detail Options</a>	<a href="#">See Laminate Selection</a>	<a href="#">See PVC Edge Color Options</a>	N None CT2 Dual Power Center Top CU2 Dual Power Underside CT2U1 Dual Power Center Top with Underside (See chart on next page)	<a href="#">See Metal Finish Color Options</a>

Model Number Breakdown

LKT4896-36TTRT						
LK	T	4896	36	TT	R	T
LOK	Laminate	48" x 96"	Height	Rectangular Top Shape	Rounded Corner	T Base

Description

Rounded Rectangular Table with T Base at Counter Height (continued)

Veneer Tables "LKV" Models      Solid Surface Tables "LKS" Models

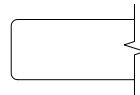

Eased Edge (R3)

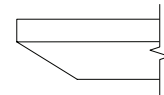

Reverse Bevel Edge (K9)

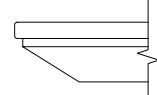

Reverse Bevel Edge (K7)

	D	W	H	CTN WT	CU FT	① Model	Veneer Tables "LKV" Models		Solid Surface Tables "LKS" Models		
							Essentials	Artisan	Essentials	Artisan	Standard
VENEER	48	96	36	233	115	LKV4896-36TTRT	\$5,748	\$6,168	\$6,130	\$6,514	--
	48	84	36	209	101	LKV4884-36TTRT	\$5,341	\$5,699	\$5,696	\$6,030	--
	42	96	36	186	83	LKV4296-36TTRT	\$5,485	\$5,925	\$5,977	\$6,368	--
	42	84	36	167	90	LKV4284-36TTRT	\$4,643	\$5,013	\$5,060	\$5,386	--
	36	96	36	166	89	LKV3696-36TTRT	\$4,222	\$4,563	\$4,604	\$4,901	--
	36	84	36	149	78	LKV3684-36TTRT	\$3,901	\$4,215	\$4,257	\$4,530	--
SOLID SURFACE	48	96	36	233	115	LKS4896-36TTRT	--	--	--	--	\$12,994
	48	84	36	209	101	LKS4884-36TTRT	--	--	--	--	\$11,627
	42	96	36	186	83	LKS4296-36TTRT	--	--	--	--	\$10,507
	42	84	36	167	90	LKS4284-36TTRT	--	--	--	--	\$9,287
	36	96	36	166	89	LKS3696-36TTRT	--	--	--	--	\$9,259
	36	84	36	149	78	LKS3684-36TTRT	--	--	--	--	\$8,366

Electrical Options and Upcharges

Option	Upcharge
<b>CT2</b>	84 - 96 wide
Dual Power Center Top - Black	CT2BL - add \$1,837
Dual Power Center Top - White	CT2WH - add \$1,837
<b>CU1</b>	
Dual Power Underside - Black	CU1-1C - add \$731
Dual Power Underside with Wireless Charging - Black	CU1-1CW - add \$1,691
<b>CT2U1</b>	
Dual Power Center Top - Black with Underside	CT2U1-BL - add \$2,235
Dual Power Center Top - White with Underside	CT2U1-WH - add \$2,235
Dual Power Center Top - Black with Wireless Charging	CT2U1-BLW2 - add \$3,194
Dual Power Center Top - White with Wireless Charging	CT2U1-WHW2 - add \$3,194

Note: Order power infeed that best fits application

To Order Specify

① Veneer Model #	② Edge Detail	③ Wood Collection	④ Wood Finish	⑤ Electrical	⑥ Metal Color
Veneer (LKV)	<a href="#">See Edge Detail Options</a>	Essentials	<a href="#">See Essentials Wood Finish Options</a>	N None CT2 Dual Power Center Top CU2 Dual Power Underside CT2U1 Dual Power Center Top with Underside (See chart above)	<a href="#">See Metal Finish Color Options</a>
		Artisan	④ Wood Finish <a href="#">See Artisan Wood Finish Options</a>		

① Solid Surface Model #	② Top Surface Selection	③ Electrical	④ Metal Color
Solid Surface (LKS)	<a href="#">See Solid Surface Top Surface Selection Options</a>	N None CT2 Dual Power Center Top CU2 Dual Power Underside CT2U1 Dual Power Center Top with Underside (See chart above)	<a href="#">See Metal Finish Color Options</a>

LOK - CONFERENCE

Description

Rectangular Table with Y Base at Counter Height

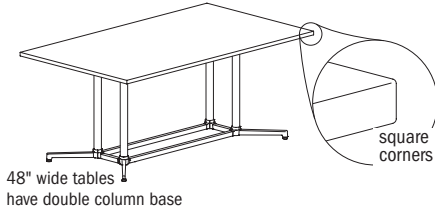

Laminate Tables "LKT" Models

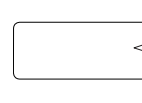

Eased Edge (R3)

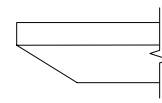

Reverse Bevel Edge (K9)

LAMINATE	D	W	H	CTN WT	CU FT	Model	Eased Edge (R3)		Reverse Bevel Edge (K9)	
							Standard Tier 1	Graded In Tier 2	Standard Tier 1	Graded In Tier 2
	48	96	36	232	115	LKT4896-36TTY	\$4,090	\$4,154	\$4,673	\$4,737
48	84	36	209	101	LKT4884-36TTY	\$3,622	\$3,676	\$4,186	\$4,244	
42	96	36	197	102	LKT4296-36TTY	\$4,634	\$4,691	\$5,202	\$5,256	
42	84	36	178	89	LKT4284-36TTY	\$3,155	\$3,203	\$3,710	\$3,758	
36	96	36	177	89	LKT3696-36TTY	\$3,170	\$3,218	\$3,722	\$3,770	
36	84	36	159	78	LKT3684-36TTY	\$2,818	\$2,859	\$3,360	\$3,401	

Features:

- price reflects complete table - top and base
- ships KD in multiple cartons
- one piece top
- model includes adjustable glide

Options:

- specify power/charging option, see below for options and upcharges

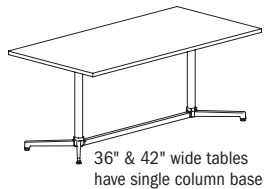

top shape

LOK - CONFERENCE

To Order Specify

1 Laminate Model #	2 Edge Detail	3 Laminate Selection	3a PVC Edge Color	4 Electrical	5 Metal Color
Laminate (LKT)	<a href="#">See Edge Detail Options</a>	<a href="#">See Laminate Selection</a>	<a href="#">See PVC Edge Color Options</a>	N None CT2 Dual Power Center Top CU2 Dual Power Underside CT2U1 Dual Power Center Top with Underside (See chart on next page)	<a href="#">See Metal Finish Color Options</a>

Model Number Breakdown

LKT4896-36TTY					
LK	T	4896	36	TT	Y
LOK	Laminate	48" x 96"	Height	Rectangular Top Shape	Y Base

Description

Rectangular Table with Y Base  
at Counter Height  
(continued)

Veneer Tables  
"LKV" Models

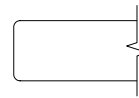

Eased Edge (R3)

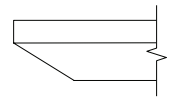

Reverse Bevel Edge (K9)

D	W	H	CTN WT	CU FT	① Model	Essentials		Artisan	
						Essentials	Artisan	Essentials	Artisan
48	96	36	232	115	LKV4896-36TTY	\$5,673	\$6,089	\$6,053	\$6,442
48	84	36	209	101	LKV4884-36TTY	\$5,146	\$5,506	\$5,501	\$5,836
42	96	36	197	102	LKV4296-36TTY	\$6,658	\$7,189	\$7,255	\$7,725
	84	36	178	89	LKV4284-36TTY	\$4,735	\$5,112	\$5,161	\$5,495
36	96	36	177	89	LKV3696-36TTY	\$4,261	\$4,602	\$4,644	\$4,944
36	84	36	159	78	LKV3684-36TTY	\$3,881	\$4,190	\$4,230	\$4,505

VENEER

Electrical Options and Upcharges

CT2	84 - 96 wide
Dual Power Center Top - Black	CT2BL - add \$1,837
Dual Power Center Top - White	CT2WH - add \$1,837
CU1	
Dual Power Underside - Black	CU1-1C - add \$731
Dual Power Underside with Wireless Charging - Black	CU1-1CW - add \$1,691
CT2U1	
Dual Power Center Top - Black with Underside	CT2U1-BL - add \$2,235
Dual Power Center Top - White with Underside	CT2U1-WH - add \$2,235
Dual Power Center Top - Black with Wireless Charging	CT2U1-BLW2 - add \$3,194
Dual Power Center Top - White with Wireless Charging	CT2U1-WhW2 - add \$3,194

Note: Order power infeed that best fits application

To Order Specify

① Veneer Model #	② Edge Detail	③ Wood Collection	④ Wood Finish	⑤ Electrical	⑥ Metal Color
Veneer (LKV)	<a href="#">See Edge Detail Options</a>	Essentials	<a href="#">See Essentials Wood Finish Options</a>	N None CT2 Dual Power Center Top CU2 Dual Power Underside CT2U1 Dual Power Center Top with Underside (See chart above)	<a href="#">See Metal Finish Color Options</a>
		Artisan	④ Wood Finish <a href="#">See Artisan Wood Finish Options</a>		

LOK - CONFERENCE

Description

Rounded Rectangular Table with Y Base at Counter Height

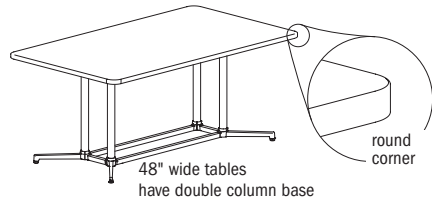

Laminate Tables  
"LKT" Models

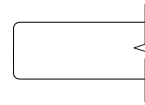

Eased Edge (R3)

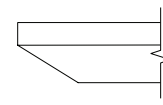

Reverse Bevel Edge (K9)

D	W	H	CTN WT	CU FT	Model	Eased Edge (R3)		Reverse Bevel Edge (K9)	
						Standard Tier 1	Graded In Tier 2	Standard Tier 1	Graded In Tier 2
48	96	36	232	115	LKT4896-36TTRY	\$4,169	\$4,230	\$4,749	\$4,813
48	84	36	209	101	LKT4884-36TTRY	\$3,691	\$3,747	\$4,260	\$4,315
42	96	36	197	102	LKT4296-36TTRY	\$4,709	\$4,763	\$5,273	\$5,330
42	84	36	178	89	LKT4284-36TTRY	\$3,219	\$3,268	\$3,775	\$3,823
36	96	36	177	89	LKT3696-36TTRY	\$3,237	\$3,283	\$3,787	\$3,835
36	84	36	159	78	LKT3684-36TTRY	\$2,880	\$2,921	\$3,422	\$3,464

LAMINATE

Features:

- price reflects complete table - top and base
- ships KD in multiple cartons
- one piece top
- model includes adjustable glide

Options:

- specify power/charging option, see below for options and upcharges

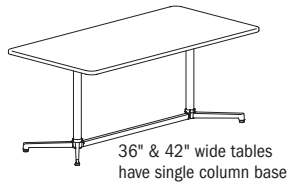

To Order Specify

1 Laminate Model #	2 Edge Detail	3 Laminate Selection	3a PVC Edge Color	4 Electrical	5 Metal Color
Laminate (LKT)	<a href="#">See Edge Detail Options</a>	<a href="#">See Laminate Selection</a>	<a href="#">See PVC Edge Color Options</a>	N None CT2 Dual Power Center Top CU2 Dual Power Underside CT2U1 Dual Power Center Top with Underside (See chart on next page)	<a href="#">See Metal Finish Color Options</a>

Model Number Breakdown

LKT4896-36TTRY						
LK	T	4896	36	TT	R	Y
LOK	Laminate	48" x 96"	Height	Rectangular Top Shape	Rounded Corner	Y Base

Description

Rounded Rectangular Table with Y Base at Counter Height (continued)

Veneer Tables "LKV" Models      Solid Surface Tables "LKS" Models

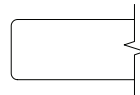

Eased Edge (R3)

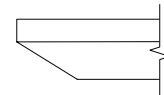

Reverse Bevel Edge (K9)

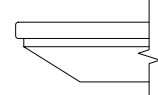

Reverse Bevel Edge (K7)

	D	W	H	CTN WT	CU FT	① Model	Veneer Tables		Solid Surface Tables		
							Essentials	Artisan	Essentials	Artisan	Standard
VENEER	48	96	36	232	115	LKV4896-36TTRY	\$5,770	\$6,187	\$6,151	\$6,542	--
	48	84	36	209	101	LKV4884-36TTRY	\$5,236	\$5,594	\$5,589	\$5,926	--
	42	96	36	197	102	LKV4296-36TTRY	\$6,745	\$7,285	\$7,352	\$7,829	--
	42	84	36	178	89	LKV4284-36TTRY	\$4,813	\$5,197	\$5,246	\$5,588	--
	36	96	36	177	89	LKV3696-36TTRY	\$4,339	\$4,687	\$4,728	\$5,036	--
	36	84	36	159	78	LKV3684-36TTRY	\$3,958	\$4,273	\$4,312	\$4,591	--
SOLID SURFACE	48	96	36	232	115	LKS4896-36TTRY	--	--	--	--	\$13,015
	48	84	36	209	101	LKS4884-36TTRY	--	--	--	--	\$11,522
	42	96	36	197	102	LKS4296-36TTRY	--	--	--	--	\$11,770
	42	84	36	178	89	LKS4284-36TTRY	--	--	--	--	\$9,459
	36	96	36	177	89	LKS3696-36TTRY	--	--	--	--	\$9,376
	36	84	36	159	78	LKS3684-36TTRY	--	--	--	--	\$8,418

Electrical Options and Upcharges

CT2	84 - 96 wide
Dual Power Center Top - Black	CT2BL - add \$1,837
Dual Power Center Top - White	CT2WH - add \$1,837
CU1	
Dual Power Underside - Black	CU1-1C - add \$731
Dual Power Underside with Wireless Charging - Black	CU1-1CW - add \$1,691
CT2U1	
Dual Power Center Top - Black with Underside	CT2U1-BL - add \$2,235
Dual Power Center Top - White with Underside	CT2U1-WH - add \$2,235
Dual Power Center Top - Black with Wireless Charging	CT2U1-BLW2 - add \$3,194
Dual Power Center Top - White with Wireless Charging	CT2U1-WHW2 - add \$3,194

Note: Order power infeed that best fits application

To Order Specify

① Veneer Model #	② Edge Detail	③ Wood Collection	④ Wood Finish	⑤ Electrical	⑥ Metal Color
Veneer (LKV)	<a href="#">See Edge Detail Options</a>	Essentials	<a href="#">See Essentials Wood Finish Options</a>	N None CT2 Dual Power Center Top CU2 Dual Power Underside CT2U1 Dual Power Center Top with Underside (See chart above)	<a href="#">See Metal Finish Color Options</a>
		Artisan	④ Wood Finish <a href="#">See Artisan Wood Finish Options</a>		

① Solid Surface Model #	② Top Surface Selection	③ Electrical	④ Metal Color
Solid Surface (LKS)	<a href="#">See Solid Surface Top Surface Selection Options</a>	N None CT2 Dual Power Center Top CU2 Dual Power Underside CT2U1 Dual Power Center Top with Underside (See chart above)	<a href="#">See Metal Finish Color Options</a>

LOK - CONFERENCE

Description

Arc Rectangular Table with T Base at Counter Height

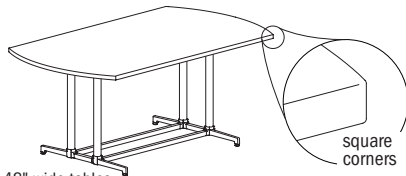

48" wide tables have double column base

LAMINATE

D	W	H	CTN WT	CU FT	Model
48	96	36	226	115	LKT4896-36ART
48	84	36	202	101	LKT4884-36ART
42	96	36	182	83	LKT4296-36ART
42	84	36	162	90	LKT4284-36ART
36	96	36	163	89	LKT3696-36ART
36	84	36	145	78	LKT3684-36ART

Laminate Tables "LKT" Models

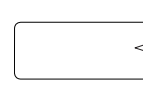

Eased Edge (R3)

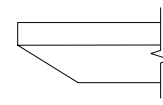

Reverse Bevel Edge (K9)

Eased Edge (R3)		Reverse Bevel Edge (K9)	
Standard Tier 1	Graded In Tier 2	Standard Tier 1	Graded In Tier 2
\$4,151	\$4,214	\$4,734	\$4,796
\$3,775	\$3,831	\$4,343	\$4,400
\$3,697	\$3,755	\$4,265	\$4,321
\$3,079	\$3,128	\$3,634	\$3,683
\$3,142	\$3,188	\$3,692	\$3,737
\$2,838	\$2,879	\$3,377	\$3,419

Features:

- price reflects complete table - top and base
- ships KD in multiple cartons
- one piece top
- model includes adjustable glide

Options:

- specify power/charging option, see below for options and upcharges

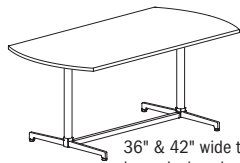

36" & 42" wide tables have single column base

LOK - CONFERENCE

To Order Specify

1 Laminite Model #	2 Edge Detail	3 Laminite Selection	3a PVC Edge Color	4 Electrical	5 Metal Color
Laminite (LKT)	<a href="#">See Edge Detail Options</a>	<a href="#">See Laminite Selection</a>	<a href="#">See PVC Edge Color Options</a>	N None CT2 Dual Power Center Top CU2 Dual Power Underside CT2U1 Dual Power Center Top with Underside (See chart on next page)	<a href="#">See Metal Finish Color Options</a>

Model Number Breakdown

LKT4896-36ART					
LK	T	4896	36	AR	T
LOK	Laminite	48" x 96"	Height	Arc Rectangular Top Shape	T Base

Description

Arc Rectangular Table with T Base at Counter Height (continued)

Veneer Tables "LKV" Models

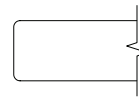

Eased Edge (R3)

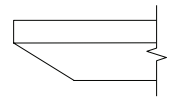

Reverse Bevel Edge (K9)

VENEER	D	W	H	CTN WT	CU FT	① Model	Essentials	Artisan	Essentials	Artisan
	48	96	36	226	115	LKV4896-36ART	\$5,748	\$6,168	\$6,130	\$6,514
	48	84	36	202	101	LKV4884-36ART	\$5,341	\$5,699	\$5,696	\$6,030
	42	96	36	182	83	LKV4296-36ART	\$5,485	\$5,925	\$5,977	\$6,368
	42	84	36	162	90	LKV4284-36ART	\$4,643	\$5,013	\$5,060	\$5,386
	36	96	36	163	89	LKV3696-36ART	\$4,222	\$4,563	\$4,604	\$4,901
	36	84	36	145	78	LKV3684-36ART	\$3,901	\$4,215	\$4,257	\$4,530

Electrical Options and Upcharges

CT2	84 - 96 wide
Dual Power Center Top - Black	CT2BL - add \$1,837
Dual Power Center Top - White	CT2WH - add \$1,837
CU1	
Dual Power Underside - Black	CU1-1C - add \$731
Dual Power Underside with Wireless Charging - Black	CU1-1CW - add \$1,691
CT2U1	
Dual Power Center Top - Black with Underside	CT2U1-BL - add \$2,235
Dual Power Center Top - White with Underside	CT2U1-WH - add \$2,235
Dual Power Center Top - Black with Wireless Charging	CT2U1-BLW2 - add \$3,194
Dual Power Center Top - White with Wireless Charging	CT2U1-WhW2 - add \$3,194

Note: Order power infeed that best fits application

To Order Specify

① Veneer Model #	② Edge Detail	③ Wood Collection	④ Wood Finish	⑤ Electrical	⑥ Metal Color
Veneer (LKV)	<a href="#">See Edge Detail Options</a>	Essentials	<a href="#">See Essentials Wood Finish Options</a>	N None CT2 Dual Power Center Top CU2 Dual Power Underside CT2U1 Dual Power Center Top with Underside (See chart above)	<a href="#">See Metal Finish Color Options</a>
		Artisan	④ Wood Finish <a href="#">See Artisan Wood Finish Options</a>		

LOK - CONFERENCE

Description

Rounded Arc Rectangular Table with T Base at Counter Height

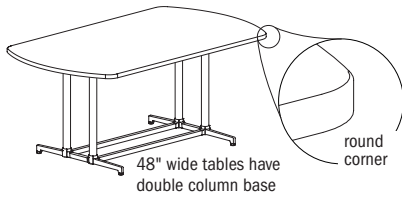

Laminate Tables  
"LKT" Models

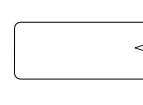

Eased Edge (R3)

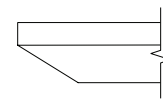

Reverse Bevel Edge (K9)

LAMINATE	D	W	H	CTN WT	CU FT	① Model	Eased Edge (R3)		Reverse Bevel Edge (K9)	
							Standard Tier 1	Graded In Tier 2	Standard Tier 1	Graded In Tier 2
	48	96	36	226	115	LKT4896-36ARRT	\$4,151	\$4,214	\$4,734	\$4,796
	48	84	36	202	101	LKT4884-36ARRT	\$3,775	\$3,831	\$4,343	\$4,400
	42	96	36	182	83	LKT4296-36ARRT	\$3,697	\$3,755	\$4,265	\$4,321
	42	84	36	162	90	LKT4284-36ARRT	\$3,079	\$3,128	\$3,634	\$3,683
	36	96	36	163	89	LKT3696-36ARRT	\$3,142	\$3,188	\$3,692	\$3,737
	36	84	36	145	78	LKT3684-36ARRT	\$2,838	\$2,879	\$3,377	\$3,419

Features:

- price reflects complete table - top and base
- ships KD in multiple cartons
- one piece top
- model includes adjustable glide

Options:

- specify power/charging option, see below for options and upcharges

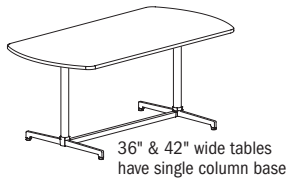

LOK - CONFERENCE

To Order Specify

① Laminate Model #	② Edge Detail	③ Laminate Selection	④ PVC Edge Color	⑤ Electrical	⑥ Metal Color
Laminate (LKT)	<a href="#">See Edge Detail Options</a>	<a href="#">See Laminate Selection</a>	<a href="#">See PVC Edge Color Options</a>	N None CT2 Dual Power Center Top CU2 Dual Power Underside CT2U1 Dual Power Center Top with Underside (See chart on next page)	<a href="#">See Metal Finish Color Options</a>

Model Number Breakdown

LKT4896-36ARRT						
LK	T	4896	36	AR	R	T
LOK	Laminate	48" x 96"	Height	Arc Rectangular Top Shape	Rounded Corner	T Base

Description

Rounded Arc Rectangular Table with T Base at Counter Height (continued)

Veneer Tables "LKV" Models      Solid Surface Tables "LKS" Models

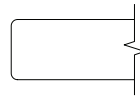

Eased Edge (R3)

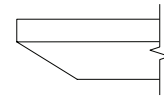

Reverse Bevel Edge (K9)

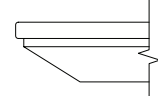

Reverse Bevel Edge (K7)

	D	W	H	CTN WT	CU FT	① Model	Veneer		Solid Surface		
							Essentials	Artisan	Essentials	Artisan	Standard
VENEER	48	96	36	226	115	LKV4896-36ARRT	\$5,748	\$6,168	\$6,130	\$6,514	--
	48	84	36	202	101	LKV4884-36ARRT	\$5,341	\$5,699	\$5,696	\$6,030	--
	42	96	36	182	83	LKV4296-36ARRT	\$5,485	\$5,925	\$5,977	\$6,368	--
	42	84	36	162	90	LKV4284-36ARRT	\$4,643	\$5,013	\$5,060	\$5,386	--
	36	96	36	163	89	LKV3696-36ARRT	\$4,222	\$4,563	\$4,604	\$4,901	--
	36	84	36	145	78	LKV3684-36ARRT	\$3,901	\$4,215	\$4,257	\$4,530	--
SOLID SURFACE	48	96	36	226	115	LKS4896-36ARRT	--	--	--	--	\$12,994
	48	84	36	202	101	LKS4884-36ARRT	--	--	--	--	\$11,627
	42	96	36	182	83	LKS4296-36ARRT	--	--	--	--	\$10,507
	42	84	36	162	90	LKS4284-36ARRT	--	--	--	--	\$9,287
	36	96	36	163	89	LKS3696-36ARRT	--	--	--	--	\$9,259
	36	84	36	145	78	LKS3684-36ARRT	--	--	--	--	\$8,366

Electrical Options and Upcharges

CT2	84 - 96 wide
Dual Power Center Top - Black	CT2BL - add \$1,837
Dual Power Center Top - White	CT2WH - add \$1,837
CU1	
Dual Power Underside - Black	CU1-1C - add \$731
Dual Power Underside with Wireless Charging - Black	CU1-1CW - add \$1,691
CT2U1	
Dual Power Center Top - Black with Underside	CT2U1-BL - add \$2,235
Dual Power Center Top - White with Underside	CT2U1-WH - add \$2,235
Dual Power Center Top - Black with Wireless Charging	CT2U1-BLW2 - add \$3,194
Dual Power Center Top - White with Wireless Charging	CT2U1-WHW2 - add \$3,194

Note: Order power infeed that best fits application

To Order Specify

① Veneer Model #	② Edge Detail	③ Wood Collection	④ Wood Finish	⑤ Electrical	⑥ Metal Color
Veneer (LKV)	<a href="#">See Edge Detail Options</a>	Essentials	<a href="#">See Essentials Wood Finish Options</a>	N None CT2 Dual Power Center Top CU2 Dual Power Underside CT2U1 Dual Power Center Top with Underside (See chart above)	<a href="#">See Metal Finish Color Options</a>
		Artisan	④ Wood Finish <a href="#">See Artisan Wood Finish Options</a>		

① Solid Surface Model #	② Top Surface Selection	③ Electrical	④ Metal Color
Solid Surface (LKS)	<a href="#">See Solid Surface Top Surface Selection Options</a>	N None CT2 Dual Power Center Top CU2 Dual Power Underside CT2U1 Dual Power Center Top with Underside (See chart above)	<a href="#">See Metal Finish Color Options</a>

LOK - CONFERENCE

Description

Arc Rectangular Table with Y Base at Counter Height

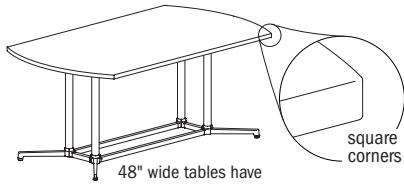

Laminate Tables "LKT" Models

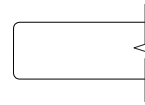

Eased Edge (R3)

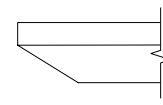

Reverse Bevel Edge (K9)

LAMINATE	D	W	H	CTN WT	CU FT	Model	Eased Edge (R3)		Reverse Bevel Edge (K9)	
							Standard Tier 1	Graded In Tier 2	Standard Tier 1	Graded In Tier 2
	48	96	36	226	115	LKT4896-36ARY	\$2,566	\$2,621	\$3,209	\$3,263
48	84	36	201	101	LKT4884-36ARY	\$2,443	\$2,490	\$3,069	\$3,116	
42	96	36	193	102	LKT4296-36ARY	\$2,230	\$2,315	\$2,792	\$2,875	
42	84	36	172	89	LKT4284-36ARY	\$2,056	\$2,131	\$2,614	\$2,689	
36	96	36	177	89	LKT3696-36ARY	\$2,566	\$2,621	\$3,209	\$3,263	
36	84	36	156	78	LKT3684-36ARY	\$2,150	\$2,230	\$2,711	\$2,792	

Features:

- price reflects complete table - top and base
- ships KD in multiple cartons
- one piece top
- model includes adjustable glide

Options:

- specify power/charging option, see below for options and upcharges

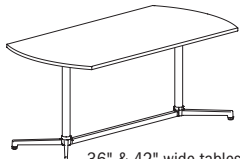

36" & 42" wide tables have single column base

LOK - CONFERENCE

To Order Specify

1 Laminate Model #	2 Edge Detail	3 Laminate Selection	3a PVC Edge Color	4 Electrical	5 Metal Color
Laminate (LKT)	<a href="#">See Edge Detail Options</a>	<a href="#">See Laminate Selection</a>	<a href="#">See PVC Edge Color Options</a>	N None CT2 Dual Power Center Top CU2 Dual Power Underside CT2U1 Dual Power Center Top with Underside (See chart on next page)	<a href="#">See Metal Finish Color Options</a>

Model Number Breakdown

LKT4896-36ARY					
LK	T	4896	36	AR	Y
LOK	Laminate	48" x 96"	Height	Arc Rectangular Top Shape	Y Base

Description

Arc Rectangular Table with Y Base at Counter Height (continued)

Veneer Tables "LKV" Models

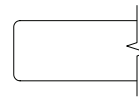

Eased Edge (R3)

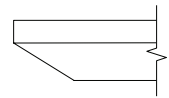

Reverse Bevel Edge (K9)

D	W	H	CTN WT	CU FT	Model	Essentials		Artisan	
						Essentials	Artisan	Essentials	Artisan
48	96	36	226	115	LKV4896-36ARY	\$5,770	\$6,187	\$6,151	\$6,542
48	84	36	201	101	LKV4884-36ARY	\$5,236	\$5,594	\$5,589	\$5,926
42	96	36	193	102	LKV4296-36ARY	\$6,745	\$7,285	\$7,352	\$7,829
	84	36	172	89	LKV4284-36ARY	\$4,813	\$5,197	\$5,246	\$5,588
36	96	36	177	89	LKV3696-36ARY	\$4,339	\$4,687	\$4,728	\$5,036
36	84	36	156	78	LKV3684-36ARY	\$3,958	\$4,273	\$4,312	\$4,591

Electrical Options and Upcharges

CT2	84 - 96 wide
Dual Power Center Top - Black	CT2BL - add \$1,837
Dual Power Center Top - White	CT2WH - add \$1,837
CU1	
Dual Power Underside - Black	CU1-1C - add \$731
Dual Power Underside with Wireless Charging - Black	CU1-1CW - add \$1,691
CT2U1	
Dual Power Center Top - Black with Underside	CT2U1-BL - add \$2,235
Dual Power Center Top - White with Underside	CT2U1-WH - add \$2,235
Dual Power Center Top - Black with Wireless Charging	CT2U1-BLW2 - add \$3,194
Dual Power Center Top - White with Wireless Charging	CT2U1-WHW2 - add \$3,194

Note: Order power infeed that best fits application

To Order Specify

1 Veneer Model #	2 Edge Detail	3 Wood Collection	4 Wood Finish	5 Electrical	6 Metal Color
Veneer (LKV)	<a href="#">See Edge Detail Options</a>	Essentials	<a href="#">See Essentials Wood Finish Options</a>	N None CT2 Dual Power Center Top CU2 Dual Power Underside CT2U1 Dual Power Center Top with Underside (See chart above)	<a href="#">See Metal Finish Color Options</a>
		Artisan	4 Wood Finish <a href="#">See Artisan Wood Finish Options</a>		

LOK - CONFERENCE

Description

Rounded Arc Rectangular Table with Y Base at Counter Height

Laminate Tables  
"LKT" Models

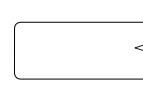
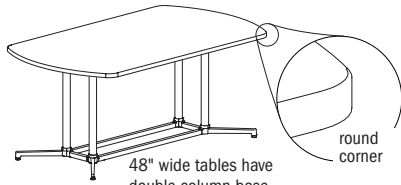

Eased Edge (R3)

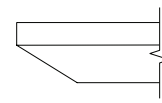

Reverse Bevel Edge (K9)

LAMINATE	D	W	H	CTN WT	CU FT	Model	Eased Edge (R3)		Reverse Bevel Edge (K9)	
							Standard Tier 1	Graded In Tier 2	Standard Tier 1	Graded In Tier 2
	48	96	36	226	115	LKT4896-36ARRY	\$4,169	\$4,230	\$4,749	\$4,813
48	84	36	201	101	LKT4884-36ARRY	\$3,691	\$3,747	\$4,260	\$4,315	
42	96	36	193	102	LKT4296-36ARRY	\$4,709	\$4,763	\$5,273	\$5,330	
42	84	36	172	89	LKT4284-36ARRY	\$3,219	\$3,268	\$3,775	\$3,823	
36	96	36	177	89	LKT3696-36ARRY	\$3,237	\$3,283	\$3,787	\$3,835	
36	84	36	156	78	LKT3684-36ARRY	\$2,880	\$2,921	\$3,422	\$3,464	

Features:

- price reflects complete table - top and base
- ships KD in multiple cartons
- one piece top
- model includes adjustable glide

Options:

- specify power/charging option, see below for options and upcharges

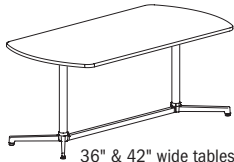

36" & 42" wide tables have single column base

LOK - CONFERENCE

To Order Specify

1 Laminite Model #	2 Edge Detail	3 Laminite Selection	3a PVC Edge Color	4 Electrical	5 Metal Color
Laminite (LKT)	<a href="#">See Edge Detail Options</a>	<a href="#">See Laminite Selection</a>	<a href="#">See PVC Edge Color Options</a>	N None CT2 Dual Power Center Top CU2 Dual Power Underside CT2U1 Dual Power Center Top with Underside (See chart on next page)	<a href="#">See Metal Finish Color Options</a>

Model Number Breakdown

LKT4896-36ARRY						
LK	T	4896	36	AR	R	Y
LOK	Laminite	48" x 96"	Height	Arc Rectangular Top Shape	Rounded Corner	Y Base

Description

Rounded Arc Rectangular Table with Y Base at Counter Height (continued)

Veneer Tables "LKV" Models      Solid Surface Tables "LKS" Models

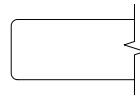

Eased Edge (R3)

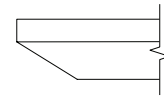

Reverse Bevel Edge (K9)

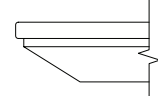

Reverse Bevel Edge (K7)

	D	W	H	CTN WT	CU FT	① Model	Veneer		Solid Surface		
							Essentials	Artisan	Essentials	Artisan	Standard
VENEER	48	96	36	226	115	LKV4896-36ARRY	\$5,770	\$6,187	\$6,151	\$6,542	--
	48	84	36	201	101	LKV4884-36ARRY	\$5,236	\$5,594	\$5,589	\$5,926	--
	42	96	36	193	102	LKV4296-36ARRY	\$6,745	\$7,285	\$7,352	\$7,829	--
	42	84	36	172	89	LKV4284-36ARRY	\$4,813	\$5,197	\$5,246	\$5,588	--
	36	96	36	177	89	LKV3696-36ARRY	\$4,339	\$4,687	\$4,728	\$5,036	--
	36	84	36	156	78	LKV3684-36ARRY	\$3,958	\$4,273	\$4,312	\$4,591	--
SOLID SURFACE	48	96	36	226	115	LKS4896-36ARRY	--	--	--	--	\$13,015
	48	84	36	201	101	LKS4884-36ARRY	--	--	--	--	\$11,522
	42	96	36	193	102	LKS4296-36ARRY	--	--	--	--	\$11,770
	42	84	36	172	89	LKS4284-36ARRY	--	--	--	--	\$9,459
	36	96	36	177	89	LKS3696-36ARRY	--	--	--	--	\$9,376
	36	84	36	156	78	LKS3684-36ARRY	--	--	--	--	\$8,418

Electrical Options and Upcharges

CT2	84 - 96 wide
Dual Power Center Top - Black	CT2BL - add \$1,837
Dual Power Center Top - White	CT2WH - add \$1,837
CU1	
Dual Power Underside - Black	CU1-1C - add \$731
Dual Power Underside with Wireless Charging - Black	CU1-1CW - add \$1,691
CT2U1	
Dual Power Center Top - Black with Underside	CT2U1-BL - add \$2,235
Dual Power Center Top - White with Underside	CT2U1-WH - add \$2,235
Dual Power Center Top - Black with Wireless Charging	CT2U1-BLW2 - add \$3,194
Dual Power Center Top - White with Wireless Charging	CT2U1-WHW2 - add \$3,194

Note: Order power infeed that best fits application

To Order Specify

① Veneer Model #	② Edge Detail	③ Wood Collection	④ Wood Finish	⑤ Electrical	⑥ Metal Color
Veneer (LKV)	<a href="#">See Edge Detail Options</a>	Essentials	<a href="#">See Essentials Wood Finish Options</a>	N None CT2 Dual Power Center Top CU2 Dual Power Underside CT2U1 Dual Power Center Top with Underside (See chart above)	<a href="#">See Metal Finish Color Options</a>
		Artisan	④ Wood Finish <a href="#">See Artisan Wood Finish Options</a>		

① Solid Surface Model #	② Top Surface Selection	③ Electrical	④ Metal Color
Solid Surface (LKS)	<a href="#">See Solid Surface Top Surface Selection Options</a>	N None CT2 Dual Power Center Top CU2 Dual Power Underside CT2U1 Dual Power Center Top with Underside (See chart above)	<a href="#">See Metal Finish Color Options</a>

LOK - CONFERENCE

Description

Racetrack Table with Y Base at Counter Height

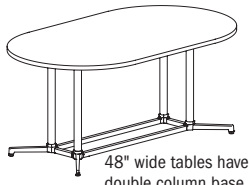

Laminate Tables "LKT" Models

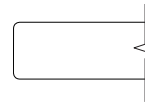

Eased Edge (R3)

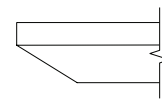

Reverse Bevel Edge (K9)

LAMINATE	D	W	H	CTN WT	CU FT	Model	Eased Edge (R3)		Reverse Bevel Edge (K9)	
							Standard Tier 1	Graded In Tier 2	Standard Tier 1	Graded In Tier 2
	48	96	36	213	115	LKT4896-36RKY	\$4,013	\$4,078	\$4,594	\$4,660
48	84	36	191	101	LKT4884-36RKY	\$3,691	\$3,747	\$4,260	\$4,315	
42	96	36	185	102	LKT4296-36RKY	\$4,709	\$4,763	\$5,273	\$5,330	
42	84	36	164	89	LKT4284-36RKY	\$3,219	\$3,268	\$3,775	\$3,823	
36	96	36	168	89	LKT3696-36RKY	\$3,237	\$3,283	\$3,787	\$3,835	
36	84	36	150	78	LKT3684-36RKY	\$2,880	\$2,921	\$3,422	\$3,464	

Features:

- price reflects complete table - top and base
- ships KD in multiple cartons
- one piece top
- model includes adjustable glide

Options:

- specify power/charging option, see below for options and upcharges

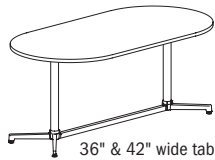

36" & 42" wide tables have single column base

LOK - CONFERENCE

To Order Specify

1 Laminite Model #	2 Edge Detail	3 Laminite Selection	3a PVC Edge Color	4 Electrical	5 Metal Color
Laminite (LKT)	<a href="#">See Edge Detail Options</a>	<a href="#">See Laminite Selection</a>	<a href="#">See PVC Edge Color Options</a>	N None CT2 Dual Power Center Top CU2 Dual Power Underside CT2U1 Dual Power Center Top with Underside (See chart on next page)	<a href="#">See Metal Finish Color Options</a>

Model Number Breakdown

LKT4896-36RKY					
LK	T	4896	36	RK	Y
LOK	Laminite	48" x 96"	Height	Racetrack Top Shape	Y Base

Description

Racetrack Table with Y Base at Counter Height (continued)

Veneer Tables "LKV" Models

Solid Surface Tables "LKS" Models

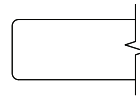

Eased Edge (R3)

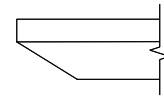

Reverse Bevel Edge (K9)

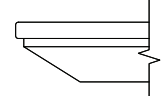

Reverse Bevel Edge (K7)

	D	W	H	CTN WT	CU FT	① Model	Veneer Tables "LKV" Models		Solid Surface Tables "LKS" Models		
							Essentials	Artisan	Essentials	Artisan	Standard
VENEER	48	96	36	213	115	LKV4896-36RKY	\$5,576	\$5,990	\$5,955	\$6,344	--
	48	84	36	191	101	LKV4884-36RKY	\$5,236	\$5,594	\$5,589	\$5,926	--
	42	96	36	185	102	LKV4296-36RKY	\$6,745	\$7,285	\$7,352	\$7,829	--
	42	84	36	164	89	LKV4284-36RKY	\$4,813	\$5,197	\$5,246	\$5,588	--
	36	96	36	168	89	LKV3696-36RKY	\$4,339	\$4,687	\$4,728	\$5,036	--
	36	84	36	150	78	LKV3684-36RKY	\$3,958	\$4,273	\$4,312	\$4,591	--
SOLID SURFACE	48	96	36	213	115	LKS4896-36RKY	--	--	--	--	\$12,817
	48	84	36	191	101	LKS4884-36RKY	--	--	--	--	\$11,522
	42	96	36	185	102	LKS4296-36RKY	--	--	--	--	\$11,770
	42	84	36	164	89	LKS4284-36RKY	--	--	--	--	\$9,459
	36	96	36	168	89	LKS3696-36RKY	--	--	--	--	\$9,376
	36	84	36	150	78	LKS3684-36RKY	--	--	--	--	\$8,418

Electrical Options and Upcharges

CT2	84 - 96 wide
Dual Power Center Top - Black	CT2BL - add \$1,837
Dual Power Center Top - White	CT2WH - add \$1,837
CU1	
Dual Power Underside - Black	CU1-1C - add \$731
Dual Power Underside with Wireless Charging - Black	CU1-1CW - add \$1,691
CT2U1	
Dual Power Center Top - Black with Underside	CT2U1-BL - add \$2,235
Dual Power Center Top - White with Underside	CT2U1-WH - add \$2,235
Dual Power Center Top - Black with Wireless Charging	CT2U1-BLW2 - add \$3,194
Dual Power Center Top - White with Wireless Charging	CT2U1-WHW2 - add \$3,194

Note: Order power infed that best fits application

To Order Specify

① Veneer Model #	② Edge Detail	③ Wood Collection	④ Wood Finish	⑤ Electrical	⑥ Metal Color
Veneer (LKV)	<a href="#">See Edge Detail Options</a>	Essentials	<a href="#">See Essentials Wood Finish Options</a>	N None CT2 Dual Power Center Top CU2 Dual Power Underside CT2U1 Dual Power Center Top with Underside (See chart above)	<a href="#">See Metal Finish Color Options</a>
		Artisan	④ Wood Finish <a href="#">See Artisan Wood Finish Options</a>		
① Solid Surface Model #	② Top Surface Selection	③ Electrical		④ Metal Color	
Solid Surface (LKS)	<a href="#">See Solid Surface Top Surface Selection Options</a>	N None CT2 Dual Power Center Top CU2 Dual Power Underside (See chart above) CT2U1 Dual Power Center Top with Underside		<a href="#">See Metal Finish Color Options</a>	

LOK - CONFERENCE

Description

Oval Table with Y Base at Counter Height

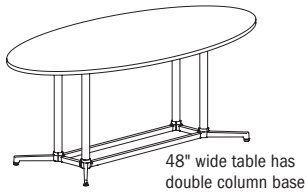

Laminate Tables  
"LKT" Models

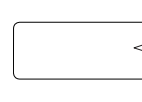

Eased Edge (R3)

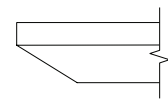

Reverse Bevel Edge (K9)

LAMINATE	D	W	H	CTN WT	CU FT	Model	Standard Tier 1	Graded In Tier 2	Standard Tier 1	Graded In Tier 2
		48	96	36	194	115	LKT4896-360VY	\$3,874	\$3,935	\$4,456
	42	84	36	150	89	LKT4284-360VY	\$3,219	\$3,268	\$3,775	\$3,823

Features:

- price reflects complete table - top and base
- ships KD in multiple cartons
- one piece top
- model includes adjustable glide

Options:

- specify power/charging option, see below for options and upcharges

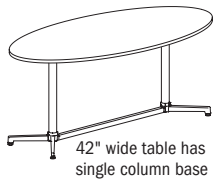

LOK - CONFERENCE

To Order Specify

1 Laminite Model #	2 Edge Detail	3 Laminite Selection	3a PVC Edge Color	4 Electrical	5 Metal Color
Laminite (LKT)	<a href="#">See Edge Detail Options</a>	<a href="#">See Laminite Selection</a>	<a href="#">See PVC Edge Color Options</a>	N None CT2 Dual Power Center Top CU2 Dual Power Underside CT2U1 Dual Power Center Top with Underside (See chart on next page)	<a href="#">See Metal Finish Color Options</a>

Model Number Breakdown

LKT4896-36RKY					
LK	T	4896	36	RK	Y
LOK	Laminite	48" x 96"	Height	Racetrack Top Shape	Y Base

Description

Oval Table with Y Base at Counter Height (continued)

Veneer Tables "LKV" Models      Solid Surface Tables "LKS" Models

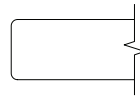

Eased Edge (R3)

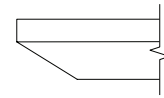

Reverse Bevel Edge (K9)

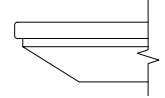

Reverse Bevel Edge (K7)

	D	W	H	CTN WT	CU FT	① Model	Veneer Tables "LKV" Models		Solid Surface Tables "LKS" Models		
							Essentials	Artisan	Essentials	Artisan	Standard
VENEER	48	96	36	194	115	LKV4896-360VY	\$5,395	\$5,809	\$5,775	\$6,163	--
	42	84	36	150	89	LKV4284-360VY	\$4,813	\$5,197	\$5,246	\$5,588	--
SOL SURF	48	96	36	194	115	LKS4896-360VY	--	--	--	--	\$12,639
	42	84	36	150	89	LKS4284-360VY	--	--	--	--	\$9,459

Electrical Options and Upcharges

CT2	84 - 96 wide
Dual Power Center Top - Black	CT2BL - add \$1,837
Dual Power Center Top - White	CT2WH - add \$1,837
CU1	
Dual Power Underside - Black	CU1-1C - add \$731
Dual Power Underside with Wireless Charging - Black	CU1-1CW - add \$1,691
CT2U1	
Dual Power Center Top - Black with Underside	CT2U1-BL - add \$2,235
Dual Power Center Top - White with Underside	CT2U1-WH - add \$2,235
Dual Power Center Top - Black with Wireless Charging	CT2U1-BLW2 - add \$3,194
Dual Power Center Top - White with Wireless Charging	CT2U1-WHW2 - add \$3,194

LOK - CONFERENCE

Note: Order power infed that best fits application

To Order Specify

① Veneer Model #	② Edge Detail	③ Wood Collection	④ Wood Finish	⑤ Electrical	⑥ Metal Color
Veneer (LKV)	<a href="#">See Edge Detail Options</a>	Essentials	<a href="#">See Essentials Wood Finish Options</a>	N None CT2 Dual Power Center Top CU2 Dual Power Underside CT2U1 Dual Power Center Top with Underside (See chart above)	<a href="#">See Metal Finish Color Options</a>
		Artisan	④ Wood Finish <a href="#">See Artisan Wood Finish Options</a>		
① Solid Surface Model #	② Top Surface Selection	③ Electrical		④ Metal Color	
Solid Surface (LKS)	<a href="#">See Solid Surface Top Surface Selection Options</a>	N None CT2 Dual Power Center Top CU2 Dual Power Underside (See chart above) CT2U1 Dual Power Center Top with Underside		<a href="#">See Metal Finish Color Options</a>	

Description

Boat Table with T Base at Counter Height

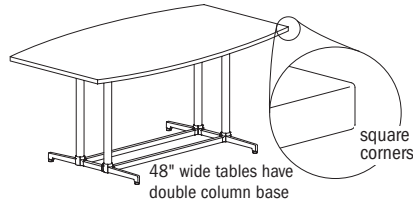

Laminate Tables  
"LKT" Models

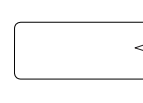

Eased Edge (R3)

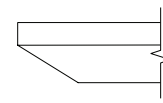

Reverse Bevel Edge (K9)

LAMINATE	D	W	H	CTN WT	CU FT	Model	Eased Edge (R3)		Reverse Bevel Edge (K9)	
							Standard Tier 1	Graded In Tier 2	Standard Tier 1	Graded In Tier 2
	48	96	36	226	101	LKT4896-36BTT	\$4,151	\$4,214	\$4,734	\$4,796
48	84	36	204	101	LKT4884-36BTT	\$3,775	\$3,831	\$4,343	\$4,400	
42	96	36	180	83	LKT4296-36BTT	\$3,697	\$3,755	\$4,265	\$4,321	
42	84	36	162	90	LKT4284-36BTT	\$3,079	\$3,128	\$3,634	\$3,683	
36	96	36	159	89	LKT3696-36BTT	\$3,142	\$3,188	\$3,692	\$3,737	
36	84	36	143	78	LKT3684-36BTT	\$2,838	\$2,879	\$3,377	\$3,419	

Features:

- price reflects complete table - top and base
- ships KD in multiple cartons
- one piece top
- model includes adjustable glide

Options:

- specify power/charging option, see below for options and upcharges

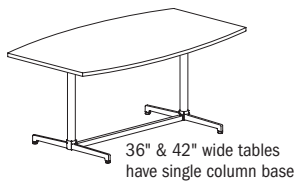

LOK - CONFERENCE

To Order Specify

1 Laminate Model #	2 Edge Detail	3 Laminate Selection	3a PVC Edge Color	4 Electrical	5 Metal Color
Laminate (LKT)	<a href="#">See Edge Detail Options</a>	<a href="#">See Laminate Selection</a>	<a href="#">See PVC Edge Color Options</a>	N None CT2 Dual Power Center Top CU2 Dual Power Underside CT2U1 Dual Power Center Top with Underside (See chart on next page)	<a href="#">See Metal Finish Color Options</a>

Model Number Breakdown

LKT4896-36BTT					
LK	T	4896	36	BT	T
LOK	Laminate	48" x 96"	Height	Boat Top Shape	T Base

Description

Boat Table with T Base at Counter Height  
(continued)

Veneer Tables  
"LKV" Models

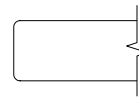

Eased Edge (R3)

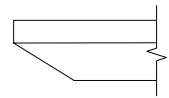

Reverse Bevel Edge (K9)

D	W	H	CTN WT	CU FT	① Model	Essentials		Artisan	
						Essentials	Artisan	Essentials	Artisan
48	96	36	226	101	LKV4896-36BTT	\$5,748	\$6,168	\$6,130	\$6,514
48	84	36	204	101	LKV4884-36BTT	\$5,341	\$5,699	\$5,696	\$6,030
42	96	36	180	83	LKV4296-36BTT	\$5,485	\$5,925	\$5,977	\$6,368
	84	36	162	90	LKV4284-36BTT	\$4,643	\$5,013	\$5,060	\$5,386
36	96	36	159	89	LKV3696-36BTT	\$4,222	\$4,563	\$4,604	\$4,901
36	84	36	143	78	LKV3684-36BTT	\$3,901	\$4,215	\$4,257	\$4,530

VENEER

Electrical Options and Upcharges

CT2	84 - 96 wide
Dual Power Center Top - Black	CT2BL - add \$1,837
Dual Power Center Top - White	CT2WH - add \$1,837
CU1	
Dual Power Underside - Black	CU1-1C - add \$731
Dual Power Underside with Wireless Charging - Black	CU1-1CW - add \$1,691
CT2U1	
Dual Power Center Top - Black with Underside	CT2U1-BL - add \$2,235
Dual Power Center Top - White with Underside	CT2U1-WH - add \$2,235
Dual Power Center Top - Black with Wireless Charging	CT2U1-BLW2 - add \$3,194
Dual Power Center Top - White with Wireless Charging	CT2U1-WhW2 - add \$3,194

Note: Order power infeed that best fits application

To Order Specify

① Veneer Model #	② Edge Detail	③ Wood Collection	④ Wood Finish	⑤ Electrical	⑥ Metal Color
Veneer (LKV)	<a href="#">See Edge Detail Options</a>	Essentials	<a href="#">See Essentials Wood Finish Options</a>	N None CT2 Dual Power Center Top CU2 Dual Power Underside CT2U1 Dual Power Center Top with Underside (See chart above)	<a href="#">See Metal Finish Color Options</a>
		Artisan	④ Wood Finish <a href="#">See Artisan Wood Finish Options</a>		

LOK - CONFERENCE

Description

Boat Table with Y Base at Counter Height

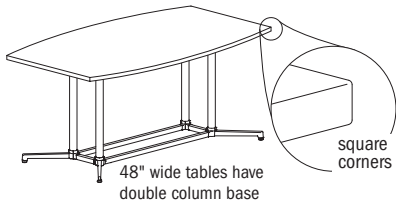

Laminate Tables  
"LKT" Models

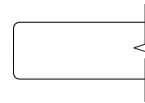

Eased Edge (R3)

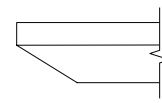

Reverse Bevel Edge (K9)

LAMINATE	D	W	H	CTN WT	CU FT	Model	Eased Edge (R3)		Reverse Bevel Edge (K9)	
							Standard Tier 1	Graded In Tier 2	Standard Tier 1	Graded In Tier 2
	48	96	36	225	115	LKT4896-36BTY	\$4,169	\$4,230	\$4,749	\$4,813
	48	84	36	204	101	LKT4884-36BTY	\$3,691	\$3,747	\$4,260	\$4,315
	42	96	36	194	102	LKT4296-36BTY	\$4,709	\$4,763	\$5,273	\$5,330
	42	84	36	172	89	LKT4284-36BTY	\$3,219	\$3,268	\$3,775	\$3,823
	36	96	36	175	89	LKT3696-36BTY	\$3,237	\$3,283	\$3,787	\$3,835
	36	84	36	153	78	LKT3684-36BTY	\$2,880	\$2,921	\$3,422	\$3,464

Features:

- price reflects complete table - top and base
- ships KD in multiple cartons
- one piece top
- model includes adjustable glide

Options:

- specify power/charging option, see below for options and upcharges

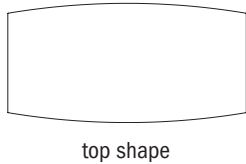
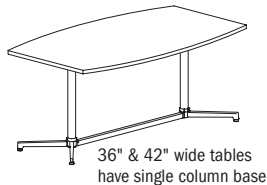

top shape

LOK - CONFERENCE

To Order Specify

1 Laminate Model #	2 Edge Detail	3 Laminate Selection	3a PVC Edge Color	4 Electrical	5 Metal Color
Laminate (LKT)	<a href="#">See Edge Detail Options</a>	<a href="#">See Laminate Selection</a>	<a href="#">See PVC Edge Color Options</a>	N None CT2 Dual Power Center Top CU2 Dual Power Underside CT2U1 Dual Power Center Top with Underside (See chart on next page)	<a href="#">See Metal Finish Color Options</a>

Model Number Breakdown

LKT4896-36BTY					
LK	T	4896	36	BT	Y
LOK	Laminate	48" x 96"	Height	Boat Top Shape	Y Base

Description

Boat Table with Y Base at Counter Height  
(continued)

Veneer Tables  
"LKV" Models

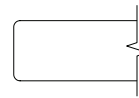

Eased Edge (R3)

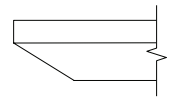

Reverse Bevel Edge (K9)

D	W	H	CTN WT	CU FT	① Model	Essentials		Artisan	
						Essentials	Artisan	Essentials	Artisan
48	96	36	225	115	LKV4896-36BTY	\$5,770	\$6,187	\$6,151	\$6,542
48	84	36	204	101	LKV4884-36BTY	\$5,236	\$5,594	\$5,589	\$5,926
42	96	36	194	102	LKV4296-36BTY	\$6,745	\$7,285	\$7,352	\$7,829
	84	36	172	89	LKV4284-36BTY	\$4,813	\$5,197	\$5,246	\$5,588
36	96	36	175	89	LKV3696-36BTY	\$4,339	\$4,687	\$4,728	\$5,036
36	84	36	153	78	LKV3684-36BTY	\$3,958	\$4,273	\$4,312	\$4,591

VENEER

Electrical Options and Upcharges

CT2	84 - 96 wide
Dual Power Center Top - Black	CT2BL - add \$1,837
Dual Power Center Top - White	CT2WH - add \$1,837
CU1	
Dual Power Underside - Black	CU1-1C - add \$731
Dual Power Underside with Wireless Charging - Black	CU1-1CW - add \$1,691
CT2U1	
Dual Power Center Top - Black with Underside	CT2U1-BL - add \$2,235
Dual Power Center Top - White with Underside	CT2U1-WH - add \$2,235
Dual Power Center Top - Black with Wireless Charging	CT2U1-BLW2 - add \$3,194
Dual Power Center Top - White with Wireless Charging	CT2U1-WHW2 - add \$3,194

Note: Order power infeed that best fits application

To Order Specify

① Veneer Model #	② Edge Detail	③ Wood Collection	④ Wood Finish	⑤ Electrical	⑥ Metal Color
Veneer (LKV)	<a href="#">See Edge Detail Options</a>	Essentials	<a href="#">See Essentials Wood Finish Options</a>	N None CT2 Dual Power Center Top CU2 Dual Power Underside CT2U1 Dual Power Center Top with Underside (See chart above)	<a href="#">See Metal Finish Color Options</a>
		Artisan	④ Wood Finish <a href="#">See Artisan Wood Finish Options</a>		

LOK - CONFERENCE

Description

Rounded Double Chevron Table with T Base at Counter Height

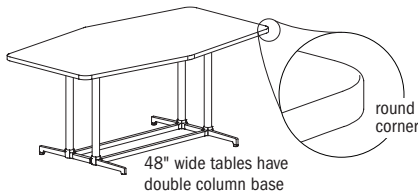

Laminate Tables "LKT" Models

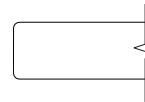

Eased Edge (R3)

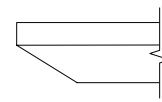

Reverse Bevel Edge (K9)

LAMINATE	D	W	H	CTN WT	CU FT	Model	Eased Edge (R3)		Reverse Bevel Edge (K9)	
							Standard Tier 1	Graded In Tier 2	Standard Tier 1	Graded In Tier 2
	48	96	36	211	115	LKT4896-36DCRT	\$4,151	\$4,214	\$4,734	\$4,796
48	84	36	189	101	LKT4884-36DCRT	\$3,775	\$3,831	\$4,343	\$4,400	
42	96	36	165	83	LKT4296-36DCRT	\$3,697	\$3,755	\$4,265	\$4,321	
42	84	36	146	90	LKT4284-36DCRT	\$3,079	\$3,128	\$3,634	\$3,683	
36	96	36	149	89	LKT3696-36DCRT	\$3,142	\$3,188	\$3,692	\$3,737	
36	84	36	142	78	LKT3684-36DCRT	\$2,838	\$2,879	\$3,377	\$3,419	

Features:

- price reflects complete table - top and base
- ships KD in multiple cartons
- one piece top
- model includes adjustable glide

Options:

- specify power/charging option, see below for options and upcharges

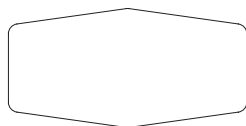
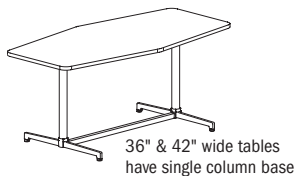

top shape

LOK - CONFERENCE

To Order Specify

1 Laminite Model #	2 Edge Detail	3 Laminite Selection	3a PVC Edge Color	4 Electrical	5 Metal Color
Laminite (LKT)	<a href="#">See Edge Detail Options</a>	<a href="#">See Laminite Selection</a>	<a href="#">See PVC Edge Color Options</a>	N None CT2 Dual Power Center Top CU2 Dual Power Underside CT2U1 Dual Power Center Top with Underside (See chart on next page)	<a href="#">See Metal Finish Color Options</a>

Model Number Breakdown

LKT4896-36DCRT						
LK	T	4896	36	DC	R	T
LOK	Laminite	48" x 96"	Height	Double Chevron Top Shape	Rounded Corner	T Base

Description

Rounded Double Chevron Table with T Base at Counter Height (continued)

Veneer Tables "LKV" Models      Solid Surface Tables "LKS" Models

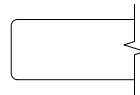

Eased Edge (R3)

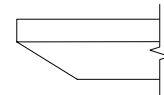

Reverse Bevel Edge (K9)

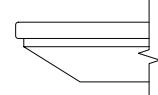

Reverse Bevel Edge (K7)

	D	W	H	CTN WT	CU FT	① Model	Veneer Tables		Solid Surface Tables		
							Essentials	Artisan	Essentials	Artisan	Standard
VENEER	48	96	36	211	115	LKV4896-36DCRT	\$5,748	\$6,168	\$6,130	\$6,514	--
	48	84	36	189	101	LKV4884-36DCRT	\$5,341	\$5,699	\$5,696	\$6,030	--
	42	96	36	165	83	LKV4296-36DCRT	\$5,485	\$5,925	\$5,977	\$6,368	--
	42	84	36	146	90	LKV4284-36DCRT	\$4,643	\$5,013	\$5,060	\$5,386	--
	36	96	36	149	89	LKV3696-36DCRT	\$4,222	\$4,563	\$4,604	\$4,901	--
	36	84	36	142	78	LKV3684-36DCRT	\$3,901	\$4,215	\$4,257	\$4,530	--
SOLID SURFACE	48	96	36	211	115	LKS4896-36DCRT	--	--	--	--	\$12,994
	48	84	36	189	101	LKS4884-36DCRT	--	--	--	--	\$11,627
	42	96	36	165	83	LKS4296-36DCRT	--	--	--	--	\$10,507
	42	84	36	146	90	LKS4284-36DCRT	--	--	--	--	\$9,287
	36	96	36	149	89	LKS3696-36DCRT	--	--	--	--	\$9,259
	36	84	36	142	78	LKS3684-36DCRT	--	--	--	--	\$8,366

Electrical Options and Upcharges

CT2	84 - 96 wide
Dual Power Center Top - Black	CT2BL - add \$1,837
Dual Power Center Top - White	CT2WH - add \$1,837
CU1	
Dual Power Underside - Black	CU1-1C - add \$731
Dual Power Underside with Wireless Charging - Black	CU1-1CW - add \$1,691
CT2U1	
Dual Power Center Top - Black with Underside	CT2U1-BL - add \$2,235
Dual Power Center Top - White with Underside	CT2U1-WH - add \$2,235
Dual Power Center Top - Black with Wireless Charging	CT2U1-BLW2 - add \$3,194
Dual Power Center Top - White with Wireless Charging	CT2U1-WHW2 - add \$3,194

Note: Order power infeed that best fits application

To Order Specify

① Veneer Model #	② Edge Detail	③ Wood Collection	④ Wood Finish	⑤ Electrical	⑥ Metal Color
Veneer (LKV)	<a href="#">See Edge Detail Options</a>	Essentials	<a href="#">See Essentials Wood Finish Options</a>	N None CT2 Dual Power Center Top CU2 Dual Power Underside CT2U1 Dual Power Center Top with Underside (See chart above)	<a href="#">See Metal Finish Color Options</a>
		Artisan	④ Wood Finish <a href="#">See Artisan Wood Finish Options</a>		

① Solid Surface Model #	② Top Surface Selection	③ Electrical	④ Metal Color
Solid Surface (LKS)	<a href="#">See Solid Surface Top Surface Selection Options</a>	N None CT2 Dual Power Center Top CU2 Dual Power Underside CT2U1 Dual Power Center Top with Underside (See chart above)	<a href="#">See Metal Finish Color Options</a>

LOK - CONFERENCE

## Description

Rounded Double Chevron Table with Y Base at Counter Height

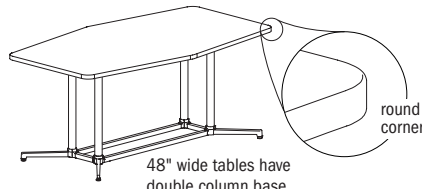

48" wide tables have double column base

## Laminate Tables "LKT" Models

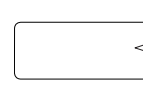

Eased Edge (R3)

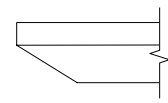

Reverse Bevel Edge (K9)

LAMINATE	D	W	H	CTN WT	CU FT	1 Model	Eased Edge (R3)		Reverse Bevel Edge (K9)	
							Standard Tier 1	Graded In Tier 2	Standard Tier 1	Graded In Tier 2
	48	96	36	206	115	LKT4896-36DCRY	\$4,169	\$4,230	\$4,749	\$4,813
48	84	36	188	101	LKT4884-36DCRY	\$3,691	\$3,747	\$4,260	\$4,315	
42	96	36	172	102	LKT4296-36DCRY	\$4,709	\$4,763	\$5,273	\$5,330	
42	84	36	156	89	LKT4284-36DCRY	\$3,219	\$3,268	\$3,775	\$3,823	
36	96	36	175	89	LKT3696-36DCRY	\$3,237	\$3,283	\$3,787	\$3,835	
36	84	36	144	78	LKT3684-36DCRY	\$2,880	\$2,921	\$3,422	\$3,464	

### Features:

- price reflects complete table - top and base
- ships KD in multiple cartons
- one piece top
- model includes adjustable glide

### Options:

- specify power/charging option, see below for options and upcharges

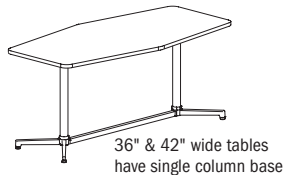

36" & 42" wide tables have single column base

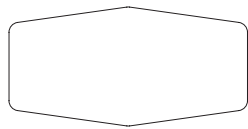

top shape

## To Order Specify

1 Laminate Model #	2 Edge Detail	3 Laminate Selection	3a PVC Edge Color	4 Electrical	5 Metal Color
Laminate (LKT)	<a href="#">See Edge Detail Options</a>	<a href="#">See Laminate Selection</a>	<a href="#">See PVC Edge Color Options</a>	N None CT2 Dual Power Center Top CU2 Dual Power Underside CT2U1 Dual Power Center Top with Underside (See chart on next page)	<a href="#">See Metal Finish Color Options</a>

## Model Number Breakdown

LKT4896-36DCRY						
LK	T	4896	36	DC	R	Y
LOK	Laminate	48" x 96"	Height	Double Chevron Top Shape	Rounded Corner	Y Base

Description

Rounded Double Chevron Table with Y Base at Counter Height (continued)

Veneer Tables "LKV" Models      Solid Surface Tables "LKS" Models

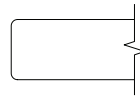

Eased Edge (R3)

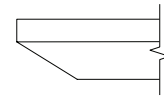

Reverse Bevel Edge (K9)

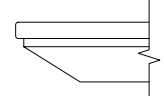

Reverse Bevel Edge (K7)

	D	W	H	CTN WT	CU FT	① Model	Veneer		Solid Surface		
							Essentials	Artisan	Essentials	Artisan	Standard
VENEER	48	96	36	206	115	LKV4896-36DCRY	\$5,770	\$6,187	\$6,151	\$6,542	--
	48	84	36	188	101	LKV4884-36DCRY	\$5,236	\$5,594	\$5,589	\$5,926	--
	42	96	36	172	102	LKV4296-36DCRY	\$6,745	\$7,285	\$7,352	\$7,829	--
	42	84	36	156	89	LKV4284-36DCRY	\$4,813	\$5,197	\$5,246	\$5,588	--
	36	96	36	175	89	LKV3696-36DCRY	\$4,339	\$4,687	\$4,728	\$5,036	--
	36	84	36	144	78	LKV3684-36DCRY	\$3,958	\$4,273	\$4,312	\$4,591	--
SOLID SURFACE	48	96	36	206	115	LKS4896-36DCRY	--	--	--	--	\$13,015
	48	84	36	188	101	LKS4884-36DCRY	--	--	--	--	\$11,522
	42	96	36	172	102	LKS4296-36DCRY	--	--	--	--	\$11,770
	42	84	36	156	89	LKS4284-36DCRY	--	--	--	--	\$9,459
	36	96	36	175	89	LKS3696-36DCRY	--	--	--	--	\$9,376
	36	84	36	144	78	LKS3684-36DCRY	--	--	--	--	\$8,418

Electrical Options and Upcharges

CT2	84 - 96 wide
Dual Power Center Top - Black	CT2BL - add \$1,837
Dual Power Center Top - White	CT2WH - add \$1,837
CU1	
Dual Power Underside - Black	CU1-1C - add \$731
Dual Power Underside with Wireless Charging - Black	CU1-1CW - add \$1,691
CT2U1	
Dual Power Center Top - Black with Underside	CT2U1-BL - add \$2,235
Dual Power Center Top - White with Underside	CT2U1-WH - add \$2,235
Dual Power Center Top - Black with Wireless Charging	CT2U1-BLW2 - add \$3,194
Dual Power Center Top - White with Wireless Charging	CT2U1-WHW2 - add \$3,194

Note: Order power infeed that best fits application

To Order Specify

① Veneer Model #	② Edge Detail	③ Wood Collection	④ Wood Finish	⑤ Electrical	⑥ Metal Color
Veneer (LKV)	<a href="#">See Edge Detail Options</a>	Essentials	<a href="#">See Essentials Wood Finish Options</a>	N None CT2 Dual Power Center Top CU2 Dual Power Underside CT2U1 Dual Power Center Top with Underside (See chart above)	<a href="#">See Metal Finish Color Options</a>
		Artisan	④ Wood Finish <a href="#">See Artisan Wood Finish Options</a>		

① Solid Surface Model #	② Top Surface Selection	③ Electrical	④ Metal Color
Solid Surface (LKS)	<a href="#">See Solid Surface Top Surface Selection Options</a>	N None CT2 Dual Power Center Top CU2 Dual Power Underside CT2U1 Dual Power Center Top with Underside (See chart above)	<a href="#">See Metal Finish Color Options</a>

LOK - CONFERENCE

Description

Taper Table with T Base at Counter Height

Laminate Tables  
"LKT" Models

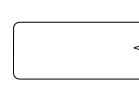
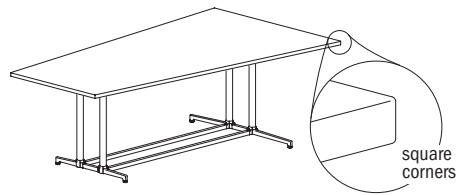

Eased Edge (R3)

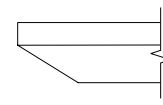

Reverse Bevel Edge (K9)

LAMI	D	W	H	CTN WT	CU FT	Model	Standard Tier 1	Graded In Tier 2	Standard Tier 1	Graded In Tier 2
		54	96	36	222	127	LKT5496-36TPT	\$4,434	\$4,506	\$5,033

Features:

- price reflects complete table - top and base
- ships KD in multiple cartons
- one piece top
- model includes adjustable glide

Options:

- specify power/charging option, see below for options and upcharges

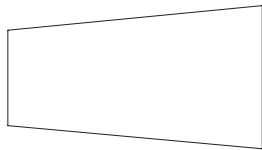

top shape

LOK - CONFERENCE

To Order Specify

1 Laminate Model #	2 Edge Detail	3 Laminate Selection	3a PVC Edge Color	4 Electrical	5 Metal Color
Laminate (LKT)	<a href="#">See Edge Detail Options</a>	<a href="#">See Laminate Selection</a>	<a href="#">See PVC Edge Color Options</a>	N None CT2 Dual Power Center Top CU2 Dual Power Underside CT2U1 Dual Power Center Top with Underside (See chart on next page)	<a href="#">See Metal Finish Color Options</a>

Model Number Breakdown

LKT5496-36TPT					
LK	T	5496	36	TP	T
LOK	Laminate	54" x 96"	Height	Taper Top Shape	T Base

Description

Taper Table with T Base at Counter Height (continued)

Veneer Tables "LKV" Models

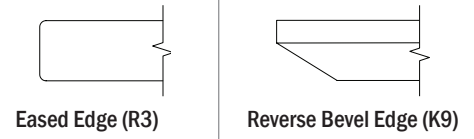

VEN.	D	W	H	CTN WT	CU FT	Model	Essentials	Artisan	Essentials	Artisan
	54	96	36	222	127	LKV5496-36TPT	\$6,060	\$6,544	\$6,604	\$7,035

Electrical Options and Upcharges

CT2	84 - 96 wide
Dual Power Center Top - Black	CT2BL - add \$1,837
Dual Power Center Top - White	CT2WH - add \$1,837
CU1	
Dual Power Underside - Black	CU1-1C - add \$731
Dual Power Underside with Wireless Charging - Black	CU1-1CW - add \$1,691
CT2U1	
Dual Power Center Top - Black with Underside	CT2U1-BL - add \$2,235
Dual Power Center Top - White with Underside	CT2U1-WH - add \$2,235
Dual Power Center Top - Black with Wireless Charging	CT2U1-BLW2 - add \$3,194
Dual Power Center Top - White with Wireless Charging	CT2U1-WHW2 - add \$3,194

Note: Order power infeed that best fits application

To Order Specify

1 Veneer Model #	2 Edge Detail	3 Wood Collection	4 Wood Finish	5 Electrical	6 Metal Color
Veneer (LKV)	<a href="#">See Edge Detail Options</a>	Essentials	<a href="#">See Essentials Wood Finish Options</a>	N None CT2 Dual Power Center Top CU2 Dual Power Underside CT2U1 Dual Power Center Top with Underside (See chart above)	<a href="#">See Metal Finish Color Options</a>
		Artisan	4 Wood Finish <a href="#">See Artisan Wood Finish Options</a>		

LOK- CONFERENCE

Description

Rounded Taper Table with T Base at Counter Height

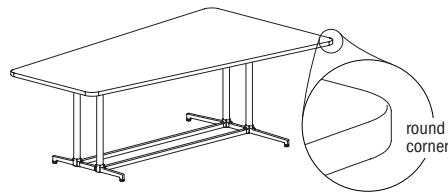

Laminate Tables "LKT" Models

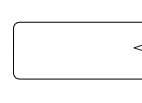

Eased Edge (R3)

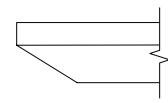

Reverse Bevel Edge (K9)

LAMI	D	W	H	CTN WT	CU FT	Model	Standard Tier 1	Graded In Tier 2	Standard Tier 1	Graded In Tier 2
		54	96	36	222	127	LKT5496-36TPRT	\$4,434	\$4,506	\$5,033

Features:

- price reflects complete table - top and base
- ships KD in multiple cartons
- one piece top
- model includes adjustable glide

Options:

- specify power/charging option, see below for options and upcharges

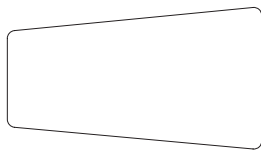

top shape

LOK - CONFERENCE

To Order Specify

1 Laminates Model #	2 Edge Detail	3 Laminates Selection	3a PVC Edge Color	4 Electrical	5 Metal Color
Laminates (LKT)	<a href="#">See Edge Detail Options</a>	<a href="#">See Laminates Selection</a>	<a href="#">See PVC Edge Color Options</a>	N None CT2 Dual Power Center Top CU2 Dual Power Underside CT2U1 Dual Power Center Top with Underside (See chart on next page)	<a href="#">See Metal Finish Color Options</a>

Model Number Breakdown

LKT5496-36TPRT						
LK	T	4896	36	TP	R	T
LOK	Laminates	48" x 96"	Height	Taper Top Shape	Rounded Corner	T Base

Description

Rounded Taper Table with T Base at Counter Height (continued)

Veneer Tables "LKV" Models      Solid Surface Tables "LKS" Models

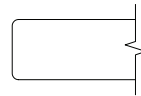

Eased Edge (R3)

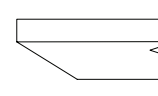

Reverse Bevel Edge (K9)

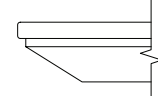

Reverse Bevel Edge (K7)

	D	W	H	CTN WT	CU FT	Model	Essentials	Artisan	Essentials	Artisan	Standard
VEN.	54	96	36	222	127	LKV5496-36TPRT	\$6,060	\$6,544	\$6,604	\$7,035	--
S.S.	54	96	36	222	127	LKS5496-36TPRT	--	--	--	--	\$16,884

Electrical Options and Upcharges

CT2	84 - 96 wide
Dual Power Center Top - Black	CT2BL - add \$1,837
Dual Power Center Top - White	CT2WH - add \$1,837
CU1	
Dual Power Underside - Black	CU1-1C - add \$731
Dual Power Underside with Wireless Charging - Black	CU1-1CW - add \$1,691
CT2U1	
Dual Power Center Top - Black with Underside	CT2U1-BL - add \$2,235
Dual Power Center Top - White with Underside	CT2U1-WH - add \$2,235
Dual Power Center Top - Black with Wireless Charging	CT2U1-BLW2 - add \$3,194
Dual Power Center Top - White with Wireless Charging	CT2U1-WHW2 - add \$3,194

Note: Order power infeed that best fits application

To Order Specify

1 Veneer Model #	2 Edge Detail	3 Wood Collection	4 Wood Finish	5 Electrical	6 Metal Color
Veneer (LKV)	<a href="#">See Edge Detail Options</a>	Essentials	<a href="#">See Essentials Wood Finish Options</a>	N None CT2 Dual Power Center Top CU2 Dual Power Underside CT2U1 Dual Power Center Top with Underside (See chart above)	<a href="#">See Metal Finish Color Options</a>
		Artisan	<b>4 Wood Finish</b> <a href="#">See Artisan Wood Finish Options</a>		

1 Solid Surface Model #	2 Top Surface Selection	3 Electrical	4 Metal Color
Solid Surface (LKS)	<a href="#">See Solid Surface Top Surface Selection Options</a>	N None CT2 Dual Power Center Top CU2 Dual Power Underside CT2U1 Dual Power Center Top with Underside (See chart above)	<a href="#">See Metal Finish Color Options</a>

LOK - CONFERENCE

Description

Taper Table with Y Base at Counter Height

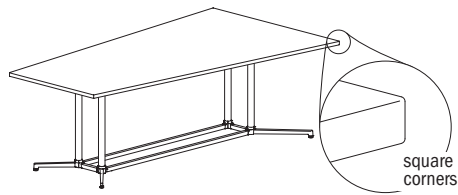

Laminate Tables "LKT" Models

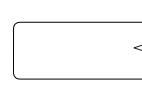

Eased Edge (R3)

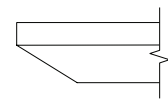

Reverse Bevel Edge (K9)

LAMI	D	W	H	CTN WT	CU FT	Model	Standard Tier 1	Graded In Tier 2	Standard Tier 1	Graded In Tier 2
		54	96	36	198	127	LKT5496-36TPY	\$4,197	\$4,267	\$4,794

Features:

- price reflects complete table - top and base
- ships KD in multiple cartons
- one piece top
- model includes adjustable glide

Options:

- specify power/charging option, see below for options and upcharges

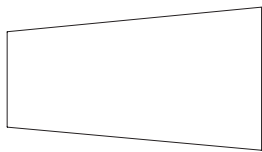

top shape

LOK - CONFERENCE

To Order Specify

1 Laminate Model #	2 Edge Detail	3 Laminate Selection	3a PVC Edge Color	4 Electrical	5 Metal Color
Laminate (LKT)	<a href="#">See Edge Detail Options</a>	<a href="#">See Laminate Selection</a>	<a href="#">See PVC Edge Color Options</a>	N None CT2 Dual Power Center Top CU2 Dual Power Underside CT2U1 Dual Power Center Top with Underside (See chart on next page)	<a href="#">See Metal Finish Color Options</a>

Model Number Breakdown

LKT4896-36TPY					
LK	T	4896	36	TP	Y
LOK	Laminate	48" x 96"	Height	Taper Top Shape	Y Base

Description

Taper Table with Y Base at Counter Height (continued)

Veneer Tables "LKV" Models

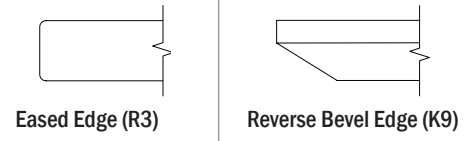

	D	W	H	CTN WT	CU FT	1 Model	Essentials	Artisan	Essentials	Artisan
VEN.	54	96	36	198	127	LKV5496-36TPY	\$5,769	\$6,229	\$6,290	\$6,697

Electrical Options and Upcharges

	84 - 96 wide
<b>CT2</b>	
Dual Power Center Top - Black	CT2BL - add \$1,837
Dual Power Center Top - White	CT2WH - add \$1,837
<b>CU1</b>	
Dual Power Underside - Black	CU1-1C - add \$731
Dual Power Underside with Wireless Charging - Black	CU1-1CW - add \$1,691
<b>CT2U1</b>	
Dual Power Center Top - Black with Underside	CT2U1-BL - add \$2,235
Dual Power Center Top - White with Underside	CT2U1-WH - add \$2,235
Dual Power Center Top - Black with Wireless Charging	CT2U1-BLW2 - add \$3,194
Dual Power Center Top - White with Wireless Charging	CT2U1-WHW2 - add \$3,194

Note: Order power infeed that best fits application

To Order Specify

1 Veneer Model #	2 Edge Detail	3 Wood Collection	4 Wood Finish	5 Electrical	6 Metal Color
Veneer (LKV)	<a href="#">See Edge Detail Options</a>	Essentials	<a href="#">See Essentials Wood Finish Options</a>	N None CT2 Dual Power Center Top CU2 Dual Power Underside CT2U1 Dual Power Center Top with Underside (See chart above)	<a href="#">See Metal Finish Color Options</a>
		Artisan	<b>4 Wood Finish</b> <a href="#">See Artisan Wood Finish Options</a>		

LOK - CONFERENCE

Description

Rounded Taper Table with Y Base at Counter Height

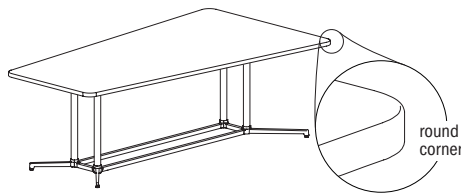

Laminate Tables "LKT" Models

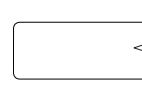

Eased Edge (R3)

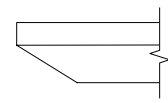

Reverse Bevel Edge (K9)

LAMI	D	W	H	CTN WT	CU FT	Model	Standard Tier 1	Graded In Tier 2	Standard Tier 1	Graded In Tier 2
		54	96	36	198	127	LKT5496-36TPRY	\$4,197	\$4,267	\$4,794

Features:

- price reflects complete table - top and base
- ships KD in multiple cartons
- one piece top
- model includes adjustable glide

Options:

- specify power/charging option, see below for options and upcharges

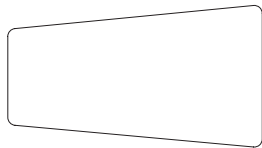

top shape

LOK - CONFERENCE

To Order Specify

1 Laminates Model #	2 Edge Detail	3 Laminates Selection	3a PVC Edge Color	4 Electrical	5 Metal Color
Laminates (LKT)	<a href="#">See Edge Detail Options</a>	<a href="#">See Laminates Selection</a>	<a href="#">See PVC Edge Color Options</a>	N None CT2 Dual Power Center Top CU2 Dual Power Underside CT2U1 Dual Power Center Top with Underside (See chart on next page)	<a href="#">See Metal Finish Color Options</a>

Model Number Breakdown

LKT5496-36TPRY						
LK	T	4896	36	TP	R	Y
LOK	Laminates	48" x 96"	Height	Taper Top Shape	Rounded Corner	Y Base

Description

Rounded Taper Table with Y Base at Counter Height (continued)

Veneer Tables "LKV" Models	Solid Surface Tables "LKS" Models
----------------------------	-----------------------------------

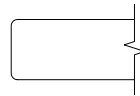

Eased Edge (R3)

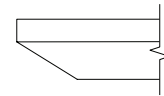

Reverse Bevel Edge (K9)

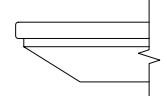

Reverse Bevel Edge (K7)

	D	W	H	CTN WT	CU FT	Model	Essentials	Artisan	Essentials	Artisan	Standard
VEN.	54	96	36	198	127	LKV5496-36TPRY	\$5,769	\$6,229	\$6,290	\$6,697	--
S.S.	54	96	36	198	127	LKS5496-36TPRY	--	--	--	--	\$16,592

Electrical Options and Upcharges

<b>CT2</b>	84 - 96 wide
Dual Power Center Top - Black	CT2BL - add \$1,837
Dual Power Center Top - White	CT2WH - add \$1,837
<b>CU1</b>	
Dual Power Underside - Black	CU1-1C - add \$731
Dual Power Underside with Wireless Charging - Black	CU1-1CW - add \$1,691
<b>CT2U1</b>	
Dual Power Center Top - Black with Underside	CT2U1-BL - add \$2,235
Dual Power Center Top - White with Underside	CT2U1-WH - add \$2,235
Dual Power Center Top - Black with Wireless Charging	CT2U1-BLW2 - add \$3,194
Dual Power Center Top - White with Wireless Charging	CT2U1-WHW2 - add \$3,194

Note: Order power infeed that best fits application

To Order Specify

1 Veneer Model #	2 Edge Detail	3 Wood Collection	4 Wood Finish	5 Electrical	6 Metal Color
Veneer (LKV)	<a href="#">See Edge Detail Options</a>	Essentials	<a href="#">See Essentials Wood Finish Options</a>	N None CT2 Dual Power Center Top CU2 Dual Power Underside CT2U1 Dual Power Center Top with Underside (See chart above)	<a href="#">See Metal Finish Color Options</a>
		Artisan	<b>4 Wood Finish</b> <a href="#">See Artisan Wood Finish Options</a>		

1 Solid Surface Model #	2 Top Surface Selection	3 Electrical	4 Metal Color
Solid Surface (LKS)	<a href="#">See Solid Surface Top Surface Selection Options</a>	N None CT2 Dual Power Center Top CU2 Dual Power Underside CT2U1 Dual Power Center Top with Underside (See chart above)	<a href="#">See Metal Finish Color Options</a>

LOK - CONFERENCE

Description

Round Table with X Base  
at Counter Height



Laminate Tables  
"LKT" Models

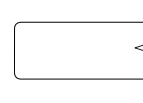

Eased Edge (R3)

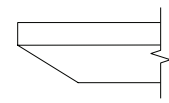

Reverse Bevel Edge (K9)

LAMINATE	D	W	H	CTN WT	CU FT	1 Model	Eased Edge (R3)		Reverse Bevel Edge (K9)	
							Standard	Graded In	Standard	Graded In
							Tier 1	Tier 2	Tier 1	Tier 2
	48	48	36	88	37	LKT48-36RDX	\$2,075	\$2,223	\$2,637	\$2,781
	42	42	36	74	35	LKT42-36RDX	\$1,908	\$2,053	\$2,470	\$2,613
	36	36	36	60	33	LKT36-36RDX	\$1,847	\$1,904	\$2,411	\$2,465
	30	30	36	48	30	LKT30-36RDX	\$1,786	\$1,830	\$2,349	\$2,391

Features:

- price reflects complete table - top and base
- ships KD in multiple cartons
- one piece top
- model includes adjustable glide
- when electrical option is selected, power accessible base is shipped; see page 178 for details
- power/charging units have 72" cord
- power cord is routed inside base column

Options:

- specify power access base with power unit option; None (N), add \$735 for EC23 (CTEC23), add \$616 for EC24 (CTEC24)

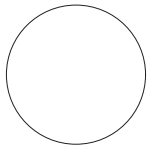

top shape

LOK - CONFERENCE

To Order Specify

1 Laminate Model #	2 Edge Detail	3 Laminate Selection	3a PVC Edge Color	4 Electrical	5 Metal Color
Laminate (LKT)	<a href="#">See Edge Detail Options</a>	<a href="#">See Laminate Selection</a>	<a href="#">See PVC Edge Color Options</a>	N None CTEC23 Power Center Top CTEC24 Power Center Top (See chart on next page)	<a href="#">See Metal Finish Color Options</a>

Model Number Breakdown

LKT48-36RDX					
LK	T	48	36	RD	X
LOK	Laminate	48" dia.	Height	Round Top Shape	X Base

Description

Round Table with X Base  
at Counter Height  
(continued)

Veneer Tables  
"LKV" Models

Solid Surface Tables  
"LKS" Models

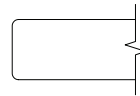

Eased Edge (R3)

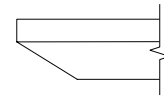

Reverse Bevel Edge (K9)

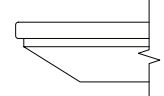

Reverse Bevel Edge (K7)

	D	W	H	CTN WT	CU FT	① Model	Veneer Tables		Solid Surface Tables		
							Essentials	Artisan	Essentials	Artisan	Standard
VENEER	48	48	36	88	37	LKV48-36RDX	\$2,733	\$2,913	\$2,839	\$3,025	--
	42	42	36	74	35	LKV42-36RDX	\$2,507	\$2,674	\$2,604	\$2,774	--
	36	36	36	60	33	LKV36-36RDX	\$2,432	\$2,594	\$2,525	\$2,691	--
	30	30	36	48	30	LKV30-36RDX	\$2,348	\$2,502	\$2,438	\$2,597	--
SOLID SURFACE	48	48	36	118	37	LKS48-36RDX	--	--	--	--	\$6,354
	42	42	36	95	35	LKS42-36RDX	--	--	--	--	\$5,420
	36	36	36	76	33	LKS36-36RDX	--	--	--	--	\$4,725
	30	30	36	59	30	LKS30-36RDX	--	--	--	--	\$4,117

Electrical Options and Upcharges

CTEC23	
EC23 Power Center Top - Black	CTEC23BL - add \$735
EC23 Power Center Top - White	CTEC23WH - add \$735
CTEC24	
EC24 Power Center Top - Black	CTEC43BL - add \$616
EC24 Power Center Top - White	CTEC43WH - add \$616

To Order Specify

① Veneer Model #	② Edge Detail	③ Wood Collection	④ Wood Finish	⑤ Electrical	⑥ Metal Color
Veneer (LKV)	<a href="#">See Edge Detail Options</a>	Essentials	<a href="#">See Essentials Wood Finish Options</a>	N None CTEC23 Power Center Top CTEC24 Power Center Top (See chart above)	<a href="#">See Metal Finish Color Options</a>
		Artisan	<a href="#">See Artisan Wood Finish Options</a>		

① Solid Surface Model #	② Top Surface Selection	③ Electrical Cut Out	④ Metal Color
Solid Surface (LKS)	<a href="#">See Solid Surface Top Surface Selection Options</a>	N None CTEC23 Power Center Top CTEC24 Power Center Top (See chart above)	<a href="#">See Metal Finish Color Options</a>

LOK - CONFERENCE

Description

Round Table with X4 Base at Counter Height



Laminate Tables "LKT" Models

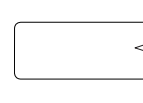

Eased Edge (R3)

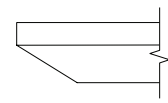

Reverse Bevel Edge (K9)

LAMINATE	D	W	H	CTN WT	CU FT	1 Model	Eased Edge (R3)		Reverse Bevel Edge (K9)	
							Standard	Graded In	Standard	Graded In
							Tier 1	Tier 2	Tier 1	Tier 2
	60	60	36	157	66	LKT60-36RDZ	\$3,457	\$3,572	\$4,019	\$4,135
	54	54	36	215	63	LKT54-36RDZ	\$3,230	\$3,318	\$3,790	\$3,879

Features:

- price reflects complete table - top and base
- ships KD in multiple cartons
- one piece top
- model includes adjustable glide
- power cord is routed outside base column
- order vertical wire manager separately; see page 407

Options:

- specify power unit option; None (N), add \$594 for EC23 (CTEC23), add \$474 for EC24 (CTEC24)

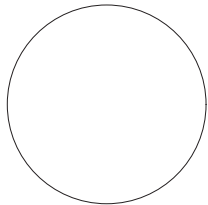

top shape

LOK - CONFERENCE

To Order Specify

1 Laminate Model #	2 Edge Detail	3 Laminate Selection	3a PVC Edge Color	4 Electrical	5 Metal Color
Laminate (LKT)	<a href="#">See Edge Detail Options</a>	<a href="#">See Laminate Selection</a>	<a href="#">See PVC Edge Color Options</a>	N None CTEC23 Power Center Top CTEC24 Power Center Top (See chart on next page)	<a href="#">See Metal Finish Color Options</a>

Model Number Breakdown

LKT60-36RDZ					
LK	T	60	36	RD	Z
LOK	Laminate	60" dia.	Height	Round Top Shape	X4 Base

Description

Round Table with X4 Base  
at Counter Height  
(continued)

Veneer Tables "LKV" Models	Solid Surface Tables "LKS" Models
-------------------------------	--------------------------------------

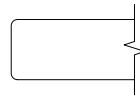

Eased Edge (R3)

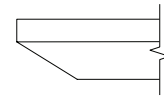

Reverse Bevel Edge (K9)

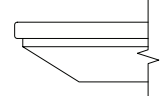

Reverse Bevel Edge (K7)

	D	W	H	CTN WT	CU FT	① Model	Veneer Tables "LKV" Models		Solid Surface Tables "LKS" Models		
							Essentials	Artisan	Essentials	Artisan	Standard
VENEER	60	60	36	215	66	LKV60-36RDZ	\$4,530	\$4,827	\$4,697	\$5,008	--
	54	54	36	186	63	LKV54-36RDZ	\$4,278	\$4,568	\$4,444	\$4,747	--
SOL SURF	60	60	36	157	66	LKS60-36RDZ	--	--	--	--	\$9,861
	54	54	36	186	63	LKS54-36RDZ	--	--	--	--	\$8,711

Electrical Options and Upcharges

CTEC23	
EC23 Power Center Top - Black	CTEC23BL - add \$594
EC23 Power Center Top - White	CTEC23WH - add \$594
CTEC24	
EC24 Power Center Top - Black	CTEC43BL - add \$474
EC24 Power Center Top - White	CTEC43WH - add \$474

To Order Specify

① Veneer Model #	② Edge Detail	③ Wood Collection	④ Wood Finish	⑤ Electrical	⑥ Metal Color
Veneer (LKV)	<a href="#">See Edge Detail Options</a>	Essentials	<a href="#">See Essentials Wood Finish Options</a>	N None CTEC23 Power Center Top CTEC24 Power Center Top (See chart above)	<a href="#">See Metal Finish Color Options</a>
		Artisan	④ Wood Finish <a href="#">See Artisan Wood Finish Options</a>		

① Solid Surface Model #	② Top Surface Selection	③ Electrical Cut Out	④ Metal Color
Solid Surface (LKS)	<a href="#">See Solid Surface Top Surface Selection Options</a>	N None CTEC23 Power Center Top CTEC24 Power Center Top (See chart above)	<a href="#">See Metal Finish Color Options</a>

LOK-CONFERENCE

Description

Square Table with X Base at Counter Height

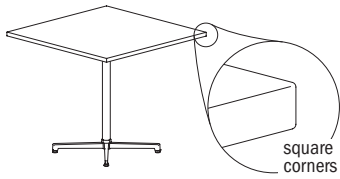

Laminate Tables "LKT" Models

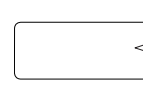

Eased Edge (R3)

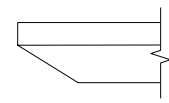

Reverse Bevel Edge (K9)

LAMINATE	D	W	H	CTN WT	CU FT	① Model	Standard Tier 1	Graded In Tier 2	Standard Tier 1	Graded In Tier 2
		42	42	36	93	35	LKT4242-36SQX	\$1,953	\$2,018	\$2,517
	36	36	36	81	33	LKT3636-36SQX	\$1,738	\$1,789	\$2,298	\$2,351
	30	30	36	62	30	LKT3030-36SQX	\$1,566	\$1,606	\$2,121	\$2,166

Features:

- price reflects complete table - top and base
- ships KD in multiple cartons
- one piece top
- model includes adjustable glide
- when electrical option is selected, power accessible base is shipped; see page 178 for details
- power/charging units have 72" cord
- power cord is routed inside base column

Options:

- specify power access base with power unit option; None (N), add \$735 for EC23 (CTEC23), add \$616 for EC24 (CTEC24)

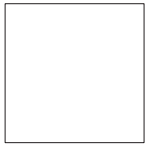

top shape

LOK - CONFERENCE

To Order Specify

① Laminate Model #	② Edge Detail	③ Laminate Selection	④ PVC Edge Color	⑤ Electrical	⑥ Metal Color
Laminate (LKT)	<a href="#">See Edge Detail Options</a>	<a href="#">See Laminate Selection</a>	<a href="#">See PVC Edge Color Options</a>	N None CTEC23 Power Center Top CTEC24 Power Center Top (See chart on next page)	<a href="#">See Metal Finish Color Options</a>

Model Number Breakdown

LKT4242-36SQX					
LK	T	4242	36	SQ	X
LOK	Laminate	42" x 42"	Height	Square Top Shape	X Base

Description

Square Table with X Base  
at Counter Height  
(continued)

Veneer Tables  
"LKV" Models

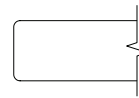

Eased Edge (R3)

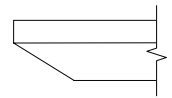

Reverse Bevel Edge (K9)

VENEER	D	W	H	CTN WT	CU FT	① Model	Essentials	Artisan	Essentials	Artisan
	42	42	36	93	35	LKV4242-36SQX	\$2,534	\$2,702	\$2,632	\$2,806
	36	36	36	81	33	LKV3636-36SQX	\$2,250	\$2,398	\$2,335	\$2,489
	30	30	36	62	30	LKV3030-36SQX	\$2,020	\$2,152	\$2,096	\$2,234

LOK- CONFERENCE

Electrical Options and Upcharges

CTEC23	
EC23 Power Center Top - Black	CTEC23BL - add \$735
EC23 Power Center Top - White	CTEC23WH - add \$735
CTEC24	
EC24 Power Center Top - Black	CTEC43BL - add \$616
EC24 Power Center Top - White	CTEC43WH - add \$616

To Order Specify

① Veneer Model #	② Edge Detail	③ Wood Collection	④ Wood Finish	⑤ Electrical	⑥ Metal Color
Veneer (LKV)	<a href="#">See Edge Detail Options</a>	Essentials	<a href="#">See Essentials Wood Finish Options</a>	N None CTEC23 Power Center Top CTEC24 Power Center Top (See chart above)	<a href="#">See Metal Finish Color Options</a>
		Artisan	④ Wood Finish <a href="#">See Artisan Wood Finish Options</a>		

Description

Rounded Square Table with X Base at Counter Height

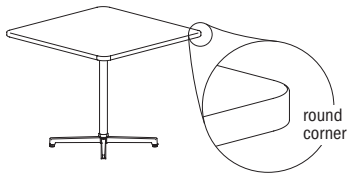

Laminate Tables  
"LKT" Models

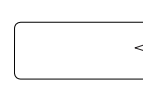

Eased Edge (R3)

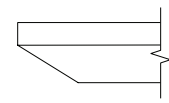

Reverse Bevel Edge (K9)

LAMINATE	D	W	H	CTN WT	CU FT	Model	Standard Tier 1	Graded In Tier 2	Standard Tier 1	Graded In Tier 2
	42	42	36	93	35	LKT4242-36SQRX	\$2,395	\$2,459	\$2,951	\$3,019
	36	36	36	81	33	LKT3636-36SQRX	\$1,861	\$1,912	\$2,420	\$2,474
	30	30	36	62	30	LKT3030-36SQRX	\$1,730	\$1,763	\$2,290	\$2,336

Features:

- price reflects complete table - top and base
- ships KD in multiple cartons
- one piece top
- model includes adjustable glide
- when electrical option is selected, power accessible base is shipped; see page 178 for details
- power/charging units have 72" cord
- power cord is routed inside base column

Options:

- specify power access base with power unit option; None (N), add \$735 for EC23 (CTEC23), add \$616 for EC24 (CTEC24)

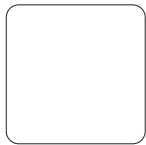

top shape

LOK - CONFERENCE

To Order Specify

1 Laminite Model #	2 Edge Detail	3 Laminite Selection	3a PVC Edge Color	4 Electrical	5 Metal Color
Laminite (LKT)	<a href="#">See Edge Detail Options</a>	<a href="#">See Laminite Selection</a>	<a href="#">See PVC Edge Color Options</a>	N None CTEC23 Power Center Top CTEC24 Power Center Top (See chart on next page)	<a href="#">See Metal Finish Color Options</a>

Model Number Breakdown

LKT4242-36SQRX						
LK	T	4242	36	SQ	R	X
LOK	Laminite	42" x 42"	Height	Square Top Shape	Rounded Corner	X Base

Description

Rounded Square Table with X Base at Counter Height (continued)

Veneer Tables "LKV" Models      Solid Surface Tables "LKS" Models

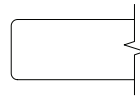

Eased Edge (R3)

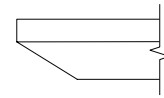

Reverse Bevel Edge (K9)

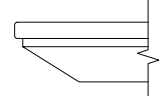

Reverse Bevel Edge (K7)

	D	W	H	CTN WT	CU FT	① Model	Veneer Tables "LKV" Models		Solid Surface Tables "LKS" Models		
							Essentials	Artisan	Essentials	Artisan	Standard
VENEER	42	42	36	93	35	LKV4242-36SQRX	\$3,126	\$3,334	\$3,243	\$3,464	--
	36	36	36	81	33	LKV3636-36SQRX	\$2,594	\$2,765	\$2,690	\$2,869	--
	30	30	36	62	30	LKV3030-36SQRX	\$2,319	\$2,473	\$2,409	\$2,567	--
SOLID SURFACE	42	42	36	93	35	LKS4242-36SQRX	--	--	--	--	\$6,174
	36	36	36	81	33	LKS3636-36SQRX	--	--	--	--	\$4,889
	30	30	36	62	30	LKS3030-36SQRX	--	--	--	--	\$4,090

Electrical Options and Upcharges

CTEC23	
EC23 Power Center Top - Black	CTEC23BL - add \$735
EC23 Power Center Top - White	CTEC23WH - add \$735
CTEC24	
EC24 Power Center Top - Black	CTEC43BL - add \$616
EC24 Power Center Top - White	CTEC43WH - add \$616

To Order Specify

① Veneer Model #	② Edge Detail	③ Wood Collection	④ Wood Finish	⑤ Electrical	⑥ Metal Color
Veneer (LKV)	<a href="#">See Edge Detail Options</a>	Essentials	<a href="#">See Essentials Wood Finish Options</a>	N None CTEC23 Power Center Top CTEC24 Power Center Top (See chart above)	<a href="#">See Metal Finish Color Options</a>
		Artisan	④ Wood Finish <a href="#">See Artisan Wood Finish Options</a>		

① Solid Surface Model #	② Top Surface Selection	③ Electrical Cut Out	④ Metal Color
Solid Surface (LKS)	<a href="#">See Solid Surface Top Surface Selection Options</a>	N None CTEC23 Power Center Top CTEC24 Power Center Top (See chart above)	<a href="#">See Metal Finish Color Options</a>

LOK- CONFERENCE

Description

Square Table with X4 Base at Counter Height

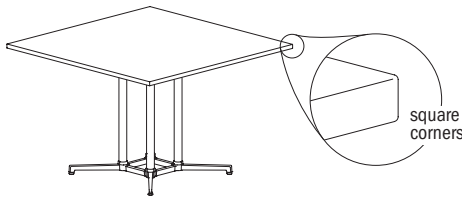

Laminate Tables "LKT" Models

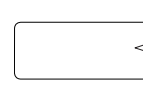

Eased Edge (R3)

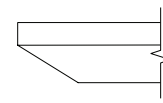

Reverse Bevel Edge (K9)

LAMINATE	D	W	H	CTN WT	CU FT	1 Model	Eased Edge (R3)		Reverse Bevel Edge (K9)	
							Standard Tier 1	Graded In Tier 2	Standard Tier 1	Graded In Tier 2
	60	60	36	181	66	LKT6060-36SQZ	\$3,925	\$4,039	\$4,485	\$4,602
54	54	36	157	63	LKT5454-36SQZ	\$3,737	\$3,838	\$4,299	\$4,400	
48	48	36	108	60	LKT4848-36SQZ	\$3,110	\$3,179	\$3,671	\$3,740	

Features:

- price reflects complete table - top and base
- ships KD in multiple cartons
- one piece top
- model includes adjustable glide
- power cord is routed outside base column
- order vertical wire manager separately; see page 407

Options:

- specify power unit option; None (N), add \$594 for EC23 (CTEC23), add \$474 for EC24 (CTEC24)

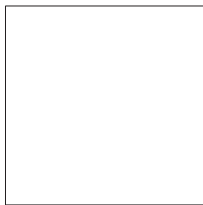

top shape

LOK - CONFERENCE

To Order Specify

1 Laminates Model #	2 Edge Detail	3 Laminates Selection	3a PVC Edge Color	4 Electrical	5 Metal Color
Laminates (LKT)	<a href="#">See Edge Detail Options</a>	<a href="#">See Laminates Selection</a>	<a href="#">See PVC Edge Color Options</a>	N None CTEC23 Power Center Top CTEC24 Power Center Top (See chart on next page)	<a href="#">See Metal Finish Color Options</a>

Model Number Breakdown

LKT6060-36SQZ					
LK	T	6060	36	SQ	Z
LOK	Laminates	60" x 60"	Height	Square Top Shape	X4 Base

Description

Square Table with X4 Base  
at Counter Height  
(continued)

Veneer Tables  
"LKV" Models

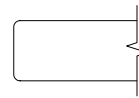

Eased Edge (R3)

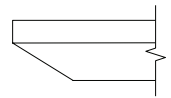

Reverse Bevel Edge (K9)

D	W	H	CTN WT	CU FT	① Model	Essentials		Artisan	
						Essentials	Artisan	Essentials	Artisan
60	60	36	181	66	LKV6060-36SQZ	\$5,083	\$5,419	\$5,274	\$5,624
54	54	36	157	63	LKV5454-36SQZ	\$4,839	\$5,158	\$5,018	\$5,350
48	48	36	108	60	LKV4848-36SQZ	\$3,744	\$3,927	\$3,850	\$4,042

VENEER

LOK - CONFERENCE

Electrical Options and Upcharges

CTEC23	
EC23 Power Center Top - Black	CTEC23BL - add \$594
EC23 Power Center Top - White	CTEC23WH - add \$594
CTEC24	
EC24 Power Center Top - Black	CTEC43BL - add \$474
EC24 Power Center Top - White	CTEC43WH - add \$474

To Order Specify

① Veneer Model #	② Edge Detail	③ Wood Collection	④ Wood Finish	⑤ Electrical	⑥ Metal Color
Veneer (LKV)	<a href="#">See Edge Detail Options</a>	Essentials	<a href="#">See Essentials Wood Finish Options</a>	N None CTEC23 Power Center Top CTEC24 Power Center Top (See chart above)	<a href="#">See Metal Finish Color Options</a>
		Artisan	<b>④ Wood Finish</b> <a href="#">See Artisan Wood Finish Options</a>		

Description

Rounded Square Table with X4 Base at Counter Height

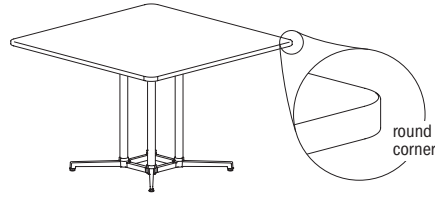

Laminate Tables  
"LKT" Models

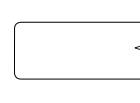

Eased Edge (R3)

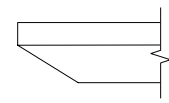

Reverse Bevel Edge (K9)

LAMINATE	D	W	H	CTN WT	CU FT	Model	Eased Edge (R3)		Reverse Bevel Edge (K9)	
							Standard Tier 1	Graded In Tier 2	Standard Tier 1	Graded In Tier 2
	60	60	36	181	66	LKT6060-36SQRZ	\$4,168	\$4,230	\$4,898	\$4,964
54	54	36	157	63	LKT5454-36SQRZ	\$3,498	\$3,599	\$4,057	\$4,159	
48	48	36	181	60	LKT4848-36SQRZ	\$3,564	\$3,636	\$4,127	\$4,197	

Features:

- price reflects complete table - top and base
- ships KD in multiple cartons
- one piece top
- model includes adjustable glide
- power cord is routed outside base column
- order vertical wire manager separately; see page 407

Options:

- specify power unit option; None (N), add \$594 for EC23 (CTEC23), add \$474 for EC24 (CTEC24)

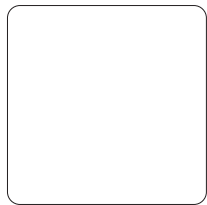

top shape

LOK - CONFERENCE

To Order Specify

1 Laminate Model #	2 Edge Detail	3 Laminate Selection	3a PVC Edge Color	4 Electrical	5 Metal Color
Laminate (LKT)	<a href="#">See Edge Detail Options</a>	<a href="#">See Laminate Selection</a>	<a href="#">See PVC Edge Color Options</a>	N None CTEC23 Power Center Top CTEC24 Power Center Top (See chart on next page)	<a href="#">See Metal Finish Color Options</a>

Model Number Breakdown

LKT6060-36SQRX						
LK	T	6060	36	SQ	R	Z
LOK	Laminate	60" x 60"	Height	Square Top Shape	Rounded Corner	X Base

Description

Rounded Square Table with X4 Base at Counter Height (continued)

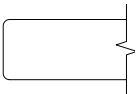
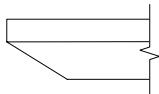
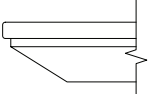
		Veneer Tables "LKV" Models				Solid Surface Tables "LKS" Models					
		 <p>Eased Edge (R3)</p>		 <p>Reverse Bevel Edge (K9)</p>		 <p>Reverse Bevel Edge (K7)</p>					
	D	W	H	CTN WT	CU FT	① Model	Essentials	Artisan	Essentials	Artisan	Standard
VENEER	60	60	36	181	66	LKV6060-36SQRZ	\$5,465	\$5,826	\$5,672	\$6,048	--
	54	54	36	157	63	LKV5454-36SQRZ	\$4,518	\$4,812	\$4,687	\$4,996	--
	48	48	36	142	60	LKV4848-36SQRZ	\$4,344	\$4,569	\$4,474	\$4,710	--
SOLID SURFACE	60	60	36	215	66	LKS6060-36SQRZ	--	--	--	--	\$10,792
	54	54	36	186	63	LKS5454-36SQRZ	--	--	--	--	\$8,947
	48	48	36	181	60	LKS4848-36SQRZ	--	--	--	--	\$7,116

Electrical Options and Upcharges

CTEC23	
EC23 Power Center Top - Black	CTEC23BL - add \$594
EC23 Power Center Top - White	CTEC23WH - add \$594
CTEC24	
EC24 Power Center Top - Black	CTEC43BL - add \$474
EC24 Power Center Top - White	CTEC43WH - add \$474

To Order Specify

① Veneer Model #	② Edge Detail	③ Wood Collection	④ Wood Finish	⑤ Electrical	⑥ Metal Color
Veneer (LKV)	<a href="#">See Edge Detail Options</a>	Essentials	<a href="#">See Essentials Wood Finish Options</a>	N None CTEC23 Power Center Top CTEC24 Power Center Top (See chart above)	<a href="#">See Metal Finish Color Options</a>
		Artisan	④ Wood Finish <a href="#">See Artisan Wood Finish Options</a>		
① Solid Surface Model #	② Top Surface Selection	③ Electrical Cut Out		④ Metal Color	
Solid Surface (LKS)	<a href="#">See Solid Surface Top Surface Selection Options</a>	N None CTEC23 Power Center Top CTEC24 Power Center Top (See chart above)		<a href="#">See Metal Finish Color Options</a>	

LOK-CONFERENCE

Description

Squircle Table with X Base at Counter Height



Laminate Tables "LKT" Models

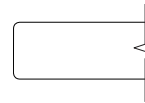

Eased Edge (R3)

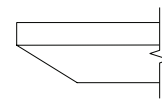

Reverse Bevel Edge (K9)

LAMINATE	D	W	H	CTN WT	CU FT	Model	Eased Edge (R3)		Reverse Bevel Edge (K9)	
							Standard Tier 1	Graded In Tier 2	Standard Tier 1	Graded In Tier 2
	42	42	36	93	35	LKT42-36SCX	\$1,935	\$2,077	\$2,495	\$2,641
36	36	36	81	33	LKT36-36SCX	\$1,873	\$1,927	\$2,438	\$2,491	
30	30	36	62	30	LKT30-36SCX	\$1,811	\$1,854	\$2,371	\$2,277	

Features:

- price reflects complete table - top and base
- ships KD in multiple cartons
- one piece top
- model includes adjustable glide
- when electrical option is selected, power accessible base is shipped; see page 178 for details
- power/charging units have 72" cord
- power cord is routed inside base column

Options:

- specify power access base with power unit option; None (N), add \$735 for EC23 (CTEC23), add \$616 for EC24 (CTEC24)

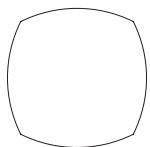

top shape

LOK - CONFERENCE

To Order Specify

1 Laminates Model #	2 Edge Detail	3 Laminates Selection	3a PVC Edge Color	4 Electrical	5 Metal Color
Laminates (LKT)	<a href="#">See Edge Detail Options</a>	<a href="#">See Laminates Selection</a>	<a href="#">See PVC Edge Color Options</a>	N None CTEC23 Power Center Top CTEC24 Power Center Top (See chart on next page)	<a href="#">See Metal Finish Color Options</a>

Model Number Breakdown

LKT42-36SCX					
LK	T	42	36	SC	X
LOK	Laminates	42" dia.	Height	Squircle Top Shape	X Base

Description

Squirrel Table with X Base at Counter Height (continued)

Veneer Tables "LKV" Models      Solid Surface Tables "LKS" Models

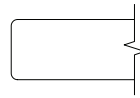

Eased Edge (R3)

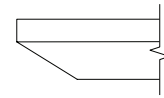

Reverse Bevel Edge (K9)

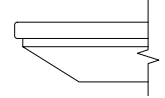

Reverse Bevel Edge (K7)

	D	W	H	CTN WT	CU FT	① Model	Veneer Tables		Solid Surface Tables		
							Essentials	Artisan	Essentials	Artisan	Standard
VENEER	42	42	36	93	35	LKV42-36SCX	\$2,534	\$2,701	\$2,632	\$2,805	--
	36	36	36	81	33	LKV36-36SCX	\$2,457	\$2,616	\$2,552	\$2,718	--
	30	30	36	62	30	LKV30-36SCX	\$2,368	\$2,525	\$2,461	\$2,621	--
SOLID SURFACE	42	42	36	93	35	LKS42-36SCX	--	--	--	--	\$5,468
	36	36	36	81	33	LKS36-36SCX	--	--	--	--	\$4,414
	30	30	36	62	30	LKS30-36SCX	--	--	--	--	\$4,605

Electrical Options and Upcharges

CTEC23	
EC23 Power Center Top - Black	CTEC23BL - add \$735
EC23 Power Center Top - White	CTEC23WH - add \$735
CTEC24	
EC24 Power Center Top - Black	CTEC43BL - add \$616
EC24 Power Center Top - White	CTEC43WH - add \$616

To Order Specify

① Veneer Model #	② Edge Detail	③ Wood Collection	④ Wood Finish	⑤ Electrical	⑥ Metal Color
Veneer (LKV)	<a href="#">See Edge Detail Options</a>	Essentials	<a href="#">See Essentials Wood Finish Options</a>	N None CTEC23 Power Center Top CTEC24 Power Center Top (See chart above)	<a href="#">See Metal Finish Color Options</a>
		Artisan	④ Wood Finish <a href="#">See Artisan Wood Finish Options</a>		

① Solid Surface Model #	② Top Surface Selection	③ Electrical Cut Out	④ Metal Color
Solid Surface (LKS)	<a href="#">See Solid Surface Top Surface Selection Options</a>	N None CTEC23 Power Center Top CTEC24 Power Center Top (See chart above)	<a href="#">See Metal Finish Color Options</a>

LOK- CONFERENCE

Description

Squircle Table with X4 Base at Counter Height



Laminate Tables "LKT" Models

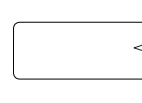

Eased Edge (R3)

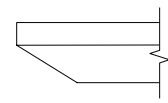

Reverse Bevel Edge (K9)

LAMINATE	D	W	H	CTN WT	CU FT	Model	Eased Edge (R3)		Reverse Bevel Edge (K9)	
							Standard Tier 1	Graded In Tier 2	Standard Tier 1	Graded In Tier 2
	60	60	36	163	66	LKT60-36SCZ	\$3,482	\$3,600	\$4,047	\$4,165
54	54	36	143	63	LKT54-36SCZ	\$3,256	\$3,345	\$3,817	\$3,908	
48	48	36	136	60	LKT48-36SCZ	\$3,095	\$3,240	\$3,655	\$3,804	

Features:

- price reflects complete table - top and base
- ships KD in multiple cartons
- one piece top
- model includes adjustable glide
- power cord is routed outside base column
- order vertical wire manager separately; see page 407

Options:

- specify power unit option; None (N), add \$594 for EC23 (CTEC23), add \$474 for EC24 (CTEC24)

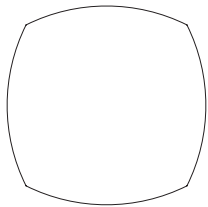

top shape

LOK - CONFERENCE

To Order Specify

1 Laminates Model #	2 Edge Detail	3 Laminates Selection	3a PVC Edge Color	4 Electrical	5 Metal Color
Laminates (LKT)	<a href="#">See Edge Detail Options</a>	<a href="#">See Laminates Selection</a>	<a href="#">See PVC Edge Color Options</a>	N None CTEC23 Power Center Top CTEC24 Power Center Top (See chart on next page)	<a href="#">See Metal Finish Color Options</a>

Model Number Breakdown

LKT60-36SCZ					
LK	T	60	36	SC	Z
LOK	Laminates	60" dia.	Height	Squircle Top Shape	X4 Base

Description

Squirrel Table with X4 Base at Counter Height (continued)

Veneer Tables "LKV" Models

Solid Surface Tables "LKS" Models

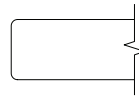

Eased Edge (R3)

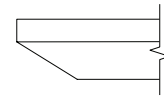

Reverse Bevel Edge (K9)

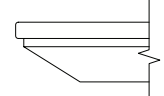

Reverse Bevel Edge (K7)

	D	W	H	CTN WT	CU FT	① Model	Veneer Tables		Solid Surface Tables		
							Essentials	Artisan	Essentials	Artisan	Standard
VENEER	60	60	36	163	66	LKV60-36SCZ	\$4,556	\$4,853	\$4,725	\$5,035	--
	54	54	36	143	63	LKV54-36SCZ	\$4,305	\$4,594	\$4,473	\$4,775	--
	48	48	36	136	60	LKV48-36SCZ	\$3,752	\$3,930	\$3,854	\$4,047	--
SOLID SURFACE	60	60	36	163	66	LKS60-36SCZ	--	--	--	--	\$9,909
	54	54	36	143	63	LKS54-36SCZ	--	--	--	--	\$9,304
	48	48	36	136	60	LKS48-36SCZ	--	--	--	--	\$7,398

Electrical Options and Upcharges

CTEC23	
EC23 Power Center Top - Black	CTEC23BL - add \$594
EC23 Power Center Top - White	CTEC23WH - add \$594
CTEC24	
EC24 Power Center Top - Black	CTEC43BL - add \$474
EC24 Power Center Top - White	CTEC43WH - add \$474

To Order Specify

① Veneer Model #	② Edge Detail	③ Wood Collection	④ Wood Finish	⑤ Electrical	⑥ Metal Color
Veneer (LKV)	<a href="#">See Edge Detail Options</a>	Essentials	<a href="#">See Essentials Wood Finish Options</a>	N None CTEC23 Power Center Top CTEC24 Power Center Top (See chart above)	<a href="#">See Metal Finish Color Options</a>
		Artisan	④ Wood Finish <a href="#">See Artisan Wood Finish Options</a>		

① Solid Surface Model #	② Top Surface Selection	③ Electrical Cut Out	④ Metal Color
Solid Surface (LKS)	<a href="#">See Solid Surface Top Surface Selection Options</a>	N None CTEC23 Power Center Top CTEC24 Power Center Top (See chart above)	<a href="#">See Metal Finish Color Options</a>

Description

Hive Table with T Base at Counter Height

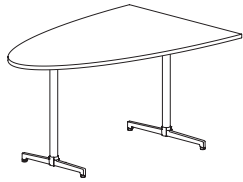

Laminate Tables  
"LKT" Models

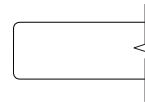

Eased Edge (R3)

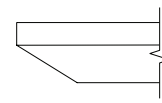

Reverse Bevel Edge (K9)

LAMI	D	W	H	CTN WT	CU FT	Model	Standard Tier 1	Graded In Tier 2	Standard Tier 1	Graded In Tier 2
		48	72	36	135	87	LKT4872-36HVT	\$2,724	\$2,777	\$3,334

Features:

- price reflects complete table - top and base
- ships KD in multiple cartons
- model includes adjustable glide

Options:

- specify power/charging option, see below for options and upcharges

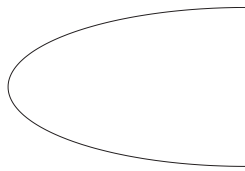

top shape

LOK - CONFERENCE

To Order Specify

1 Laminate Model #	2 Edge Detail	3 Laminate Selection	3a PVC Edge Color	4 Electrical
Laminate (LKT)	<a href="#">See Edge Detail Options</a>	<a href="#">See Laminate Selection</a>	<a href="#">See PVC Edge Color Options</a>	N None CT2 Dual Power Center Top (See chart on next page) CU1 Single Power Underside <b>5 Metal Finish</b> <a href="#">See Metal Finish Color Options</a>

Model Number Breakdown

LKT4872-36HVT					
LK	T	4872	36	HV	T
LOK	Laminate	48" x 72"	Height	Hive Top Shape	T base

Description

Hive Table with T Base at Counter Height  
(continued)

Veneer Tables  
"LKV" Models

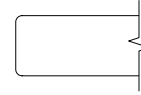

Eased Edge (R3)

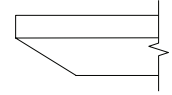

Reverse Bevel Edge (K9)

VEN.	D	W	H	CTN WT	CU FT	① Model	Essentials		Artisan	
	48	72	36	135	87	LKV4872-36HVT	\$3,431		\$3,706	
								\$3,737		\$3,982

Electrical Options and Upcharges

CT2	
Dual Power Center Top - Black	CT2BL - add \$1,773
Dual Power Center Top - White	CT2WH - add \$1,773
CU1	
Single Power Underside - Black	CU11C - add \$690
Single Power Underside with Wireless Charging - Black	CU11CW - add \$1,651

**Note: Order power infeed that best fits application.**

To Order, Specify:

① Veneer Model #	② Edge Detail	③ Wood Collection	④ Top Wood Finish	⑤ Electrical	⑥ Metal Color
Veneer (LKV)	<a href="#">See Edge Detail Options</a>	Essentials	<a href="#">See Essentials Wood Finish Options</a>	N None CT2 Dual Power Center Top CU1 Single Power Underside (See chart above)	<a href="#">See Metal Finish Color Options</a>
		Artisan	④ Top Wood Finish <a href="#">See Artisan Wood Finish Options</a>		

LOK- CONFERENCE

Description

Rectangular Table with T Base at Bar Height

Laminate Tables "LKT" Models

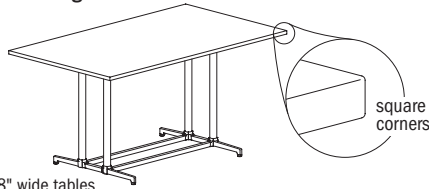

48" wide tables have double column base

D	W	H	CTN WT	CU FT	Model
48	84	42	216	117	LKT4884-42TTT
42	96	42	190	118	LKT4296-42TTT
42	84	42	215	105	LKT4284-42TTT
36	96	42	169	102	LKT3696-42TTT
36	84	42	151	90	LKT3684-42TTT

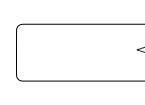

Eased Edge (R3)

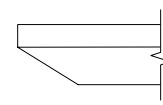

Reverse Bevel Edge (K9)

Standard Tier 1	Graded In Tier 2	Standard Tier 1	Graded In Tier 2
\$3,793	\$3,850	\$4,362	\$4,418
\$3,648	\$3,705	\$4,214	\$4,268
\$3,746	\$3,793	\$4,299	\$4,349
\$3,097	\$3,143	\$3,646	\$3,693
\$2,796	\$2,839	\$3,339	\$3,377

LAMINATE

Features:

- price reflects complete table - top and base
- ships KD in multiple cartons
- one piece top
- model includes adjustable glide

Options:

- specify power/charging option, see below for options and upcharges

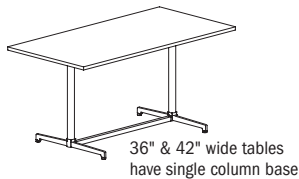

36" & 42" wide tables have single column base



top shape

LOK - CONFERENCE

To Order Specify

1 Laminate Model #	2 Edge Detail	3 Laminate Selection	3a PVC Edge Color	4 Electrical	5 Metal Color
Laminate (LKT)	<a href="#">See Edge Detail Options</a>	<a href="#">See Laminate Selection</a>	<a href="#">See PVC Edge Color Options</a>	N None CT2 Dual Power Center Top CU2 Dual Power Underside CT2U1 Dual Power Center Top with Underside (See chart on next page)	<a href="#">See Metal Finish Color Options</a>

Model Number Breakdown

LKT4896-42TTT					
LK	T	4896	42	TT	T
LOK	Laminate	48" x 96"	Height	Rectangular Top Shape	T base

Description

Rectangular Table with T Base  
at Bar Height  
(continued)

Veneer Tables  
"LKV" Models

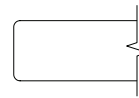

Eased Edge (R3)

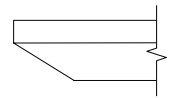

Reverse Bevel Edge (K9)

D	W	H	CTN WT	CU FT	① Model	Essentials		Artisan	
						Essentials	Artisan	Essentials	Artisan
48	96	42	239	132	LKV4896-42TTT	\$5,701	\$6,117	\$6,083	\$6,469
48	84	42	216	117	LKV4884-42TTT	\$5,364	\$5,724	\$5,719	\$6,051
42	96	42	190	118	LKV4296-42TTT	\$5,422	\$5,853	\$5,908	\$6,293
	84	42	215	105	LKV4284-42TTT	\$4,640	\$5,012	\$5,059	\$5,385
36	96	42	169	102	LKV3696-42TTT	\$4,169	\$4,503	\$4,541	\$4,839
36	84	42	151	90	LKV3684-42TTT	\$3,852	\$4,162	\$4,198	\$4,472

VENEER

Electrical Options and Upcharges

CT2	84 - 96 wide
Dual Power Center Top - Black	CT2BL - add \$1,837
Dual Power Center Top - White	CT2WH - add \$1,837
CU1	
Dual Power Underside - Black	CU1-1C - add \$731
Dual Power Underside with Wireless Charging - Black	CU1-1CW - add \$1,691
CT2U1	
Dual Power Center Top - Black with Underside	CT2U1-BL - add \$2,235
Dual Power Center Top - White with Underside	CT2U1-WH - add \$2,235
Dual Power Center Top - Black with Wireless Charging	CT2U1-BLW2 - add \$3,194
Dual Power Center Top - White with Wireless Charging	CT2U1-WHW2 - add \$3,194

Note: Order power infeed that best fits application

To Order Specify

① Veneer Model #	② Edge Detail	③ Wood Collection	④ Wood Finish	⑤ Electrical	⑥ Metal Color
Veneer (LKV)	<a href="#">See Edge Detail Options</a>	Essentials	<a href="#">See Essentials Wood Finish Options</a>	N None CT2 Dual Power Center Top CU2 Dual Power Underside CT2U1 Dual Power Center Top with Underside (See chart above)	<a href="#">See Metal Finish Color Options</a>
		Artisan	④ Wood Finish <a href="#">See Artisan Wood Finish Options</a>		

LOK - CONFERENCE

Description

Rounded Rectangular Table with T Base at Bar Height

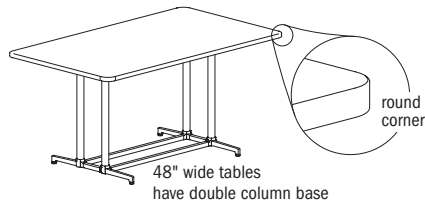

Laminate Tables "LKT" Models

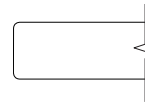

Eased Edge (R3)

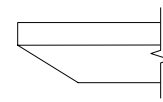

Reverse Bevel Edge (K9)

LAMINATE

D	W	H	CTN WT	CU FT	Model	Eased Edge (R3)		Reverse Bevel Edge (K9)	
						Standard Tier 1	Graded In Tier 2	Standard Tier 1	Graded In Tier 2
48	96	42	239	132	LKT4896-42TTRT	\$4,189	\$4,253	\$4,771	\$4,836
48	84	42	216	117	LKT4884-42TTRT	\$3,815	\$3,871	\$4,383	\$4,436
42	96	42	190	118	LKT4296-42TTRT	\$3,718	\$3,774	\$4,287	\$4,342
42	84	42	215	105	LKT4284-42TTRT	\$3,812	\$3,860	\$4,365	\$4,415
36	96	42	169	102	LKT3696-42TTRT	\$3,160	\$3,209	\$3,713	\$3,760
36	84	42	151	90	LKT3684-42TTRT	\$2,856	\$2,897	\$3,396	\$3,438

Features:

- price reflects complete table - top and base
- ships KD in multiple cartons
- one piece top
- model includes adjustable glide

Options:

- specify power/charging option, see below for options and upcharges

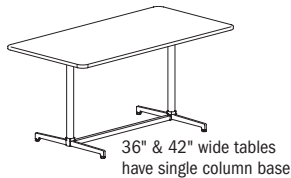

top shape

LOK - CONFERENCE

To Order Specify

1 Laminate Model #	2 Edge Detail	3 Laminate Selection	3a PVC Edge Color	4 Electrical	5 Metal Color
Laminate (LKT)	<a href="#">See Edge Detail Options</a>	<a href="#">See Laminate Selection</a>	<a href="#">See PVC Edge Color Options</a>	N None CT2 Dual Power Center Top CU2 Dual Power Underside CT2U1 Dual Power Center Top with Underside (See chart on next page)	<a href="#">See Metal Finish Color Options</a>

Model Number Breakdown

LKT4896-42TTRT						
LK	T	4896	42	TT	R	T
LOK	Laminate	48" x 96"	Height	Rectangular Top Shape	Rounded Corner	T Base

Description

Rounded Rectangular Table with T Base at Bar Height (continued)

Veneer Tables "LKV" Models      Solid Surface Tables "LKS" Models

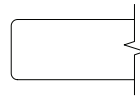

Eased Edge (R3)

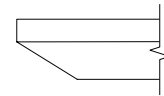

Reverse Bevel Edge (K9)

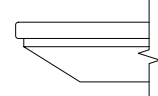

Reverse Bevel Edge (K7)

	D	W	H	CTN WT	CU FT	① Model	Veneer		Solid Surface		
							Essentials	Artisan	Essentials	Artisan	Standard
VENEER	48	96	42	239	132	LKV4896-42TTRT	\$5,800	\$6,216	\$6,178	\$6,566	--
	48	84	42	216	117	LKV4884-42TTRT	\$5,392	\$5,749	\$5,746	\$6,082	--
	42	96	42	190	118	LKV4296-42TTRT	\$5,511	\$5,948	\$6,005	\$6,393	--
	42	84	42	215	105	LKV4284-42TTRT	\$5,537	\$5,978	\$6,035	\$6,427	--
	36	96	42	169	102	LKV3696-42TTRT	\$4,249	\$4,586	\$4,628	\$4,928	--
	36	84	42	151	90	LKV3684-42TTRT	\$3,927	\$4,239	\$4,278	\$4,558	--
SOLID SURFACE	48	96	42	239	132	LKS4896-42TTRT	--	--	--	--	\$13,043
	48	84	42	216	117	LKS4884-42TTRT	--	--	--	--	\$11,678
	42	96	42	190	118	LKS4296-42TTRT	--	--	--	--	\$10,534
	42	84	42	215	105	LKS4284-42TTRT	--	--	--	--	\$10,183
	36	96	42	169	102	LKS3696-42TTRT	--	--	--	--	\$9,284
	36	84	42	151	90	LKS3684-42TTRT	--	--	--	--	\$8,390

Electrical Options and Upcharges

CT2	84 - 96 wide
Dual Power Center Top - Black	CT2BL - add \$1,837
Dual Power Center Top - White	CT2WH - add \$1,837
CU1	
Dual Power Underside - Black	CU1-1C - add \$731
Dual Power Underside with Wireless Charging - Black	CU1-1CW - add \$1,691
CT2U1	
Dual Power Center Top - Black with Underside	CT2U1-BL - add \$2,235
Dual Power Center Top - White with Underside	CT2U1-WH - add \$2,235
Dual Power Center Top - Black with Wireless Charging	CT2U1-BLW2 - add \$3,194
Dual Power Center Top - White with Wireless Charging	CT2U1-WHW2 - add \$3,194

Note: Order power infeed that best fits application

To Order Specify

① Veneer Model #	② Edge Detail	③ Wood Collection	④ Wood Finish	⑤ Electrical	⑥ Metal Color
Veneer (LKV)	<a href="#">See Edge Detail Options</a>	Essentials	<a href="#">See Essentials Wood Finish Options</a>	N None CT2 Dual Power Center Top CU2 Dual Power Underside CT2U1 Dual Power Center Top with Underside (See chart above)	<a href="#">See Metal Finish Color Options</a>
		Artisan	④ Wood Finish <a href="#">See Artisan Wood Finish Options</a>		

① Solid Surface Model #	② Top Surface Selection	③ Electrical	④ Metal Color
Solid Surface (LKS)	<a href="#">See Solid Surface Top Surface Selection Options</a>	N None CT2 Dual Power Center Top CU2 Dual Power Underside CT2U1 Dual Power Center Top with Underside (See chart above)	<a href="#">See Metal Finish Color Options</a>

LOK - CONFERENCE

Description

Rectangular Table with Y Base at Bar Height

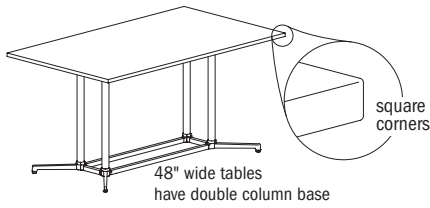

Laminate Tables "LKT" Models

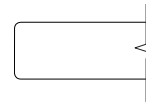

Eased Edge (R3)

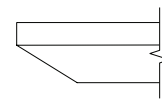

Reverse Bevel Edge (K9)

LAMINATE	D	W	H	CTN WT	CU FT	Model	Eased Edge (R3)		Reverse Bevel Edge (K9)	
							Standard Tier 1	Graded In Tier 2	Standard Tier 1	Graded In Tier 2
	48	96	42	229	132	LKT4896-42TTY	\$4,012	\$4,076	\$4,592	\$4,659
48	84	42	215	117	LKT4884-42TTY	\$3,544	\$3,597	\$4,107	\$4,166	
42	96	42	200	118	LKT4296-42TTY	\$4,557	\$4,612	\$5,123	\$5,180	
42	84	42	160	103	LKT4284-42TTY	\$3,166	\$3,217	\$3,723	\$3,771	
36	96	42	180	102	LKT3696-42TTY	\$3,181	\$3,232	\$3,732	\$3,783	
36	84	42	162	90	LKT3684-42TTY	\$2,834	\$2,874	\$3,375	\$3,418	

Features:

- price reflects complete table - top and base
- ships KD in multiple cartons
- one piece top
- model includes adjustable glide

Options:

- specify power/charging option, see below for options and upcharges

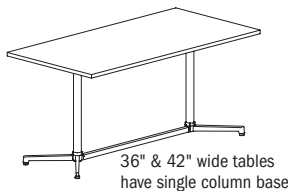

top shape

LOK - CONFERENCE

To Order Specify

1 Laminite Model #	2 Edge Detail	3 Laminite Selection	3a PVC Edge Color	4 Electrical	5 Metal Color
Laminite (LKT)	<a href="#">See Edge Detail Options</a>	<a href="#">See Laminite Selection</a>	<a href="#">See PVC Edge Color Options</a>	N None CT2 Dual Power Center Top CU2 Dual Power Underside CT2U1 Dual Power Center Top with Underside (See chart on next page)	<a href="#">See Metal Finish Color Options</a>

Model Number Breakdown

LKT4896-42TTY					
LK	T	4896	42	TT	Y
LOK	Laminite	48" x 96"	Height	Rectangular Top Shape	Y Base

Description

Rectangular Table with Y Base at Bar Height (continued)

Veneer Tables "LKV" Models

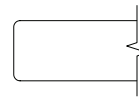

Eased Edge (R3)

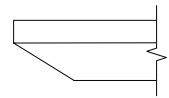

Reverse Bevel Edge (K9)

D	W	H	CTN WT	CU FT	① Model	Essentials		Artisan		
						Essentials	Artisan	Essentials	Artisan	
48	96	42	229	132	LKV4896-42TTY	\$5,573	\$5,986	\$5,954	\$6,342	
48	84	42	215	117	LKV4884-42TTY	\$5,047	\$5,405	\$5,400	\$5,734	
VENEER	42	96	42	200	118	LKV4296-42TTY	\$6,557	\$7,082	\$7,145	\$7,612
	42	84	42	160	103	LKV4284-42TTY	\$4,748	\$5,129	\$5,175	\$5,512
	36	96	42	180	102	LKV3696-42TTY	\$4,274	\$4,618	\$4,660	\$4,962
	36	84	42	162	90	LKV3684-42TTY	\$3,899	\$4,212	\$4,251	\$4,527

Electrical Options and Upcharges

CT2	84 - 96 wide
Dual Power Center Top - Black	CT2BL - add \$1,837
Dual Power Center Top - White	CT2WH - add \$1,837
CU1	
Dual Power Underside - Black	CU1-1C - add \$731
Dual Power Underside with Wireless Charging - Black	CU1-1CW - add \$1,691
CT2U1	
Dual Power Center Top - Black with Underside	CT2U1-BL - add \$2,235
Dual Power Center Top - White with Underside	CT2U1-WH - add \$2,235
Dual Power Center Top - Black with Wireless Charging	CT2U1-BLW2 - add \$3,194
Dual Power Center Top - White with Wireless Charging	CT2U1-WhW2 - add \$3,194

Note: Order power infeed that best fits application

To Order Specify

① Veneer Model #	② Edge Detail	③ Wood Collection	④ Wood Finish	⑤ Electrical	⑥ Metal Color
Veneer (LKV)	<a href="#">See Edge Detail Options</a>	Essentials	<a href="#">See Essentials Wood Finish Options</a>	N None CT2 Dual Power Center Top CU2 Dual Power Underside CT2U1 Dual Power Center Top with Underside (See chart above)	<a href="#">See Metal Finish Color Options</a>
		Artisan	④ Wood Finish <a href="#">See Artisan Wood Finish Options</a>		

LOK - CONFERENCE

Description

Rounded Rectangular Table with Y Base at Bar Height

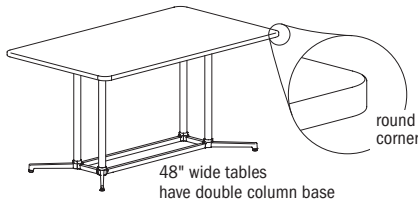

Laminate Tables  
"LKT" Models

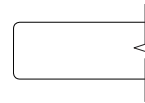

Eased Edge (R3)

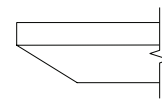

Reverse Bevel Edge (K9)

D	W	H	CTN WT	CU FT	① Model	Eased Edge (R3)		Reverse Bevel Edge (K9)	
						Standard Tier 1	Graded In Tier 2	Standard Tier 1	Graded In Tier 2
48	96	42	229	132	LKT4896-42TTRY	\$4,089	\$4,152	\$4,671	\$4,735
48	84	42	215	117	LKT4884-42TTRY	\$3,609	\$3,667	\$4,180	\$4,235
42	96	42	200	118	LKT4296-42TTRY	\$4,627	\$4,681	\$5,193	\$5,249
42	84	42	160	103	LKT4284-42TTRY	\$3,234	\$3,281	\$3,789	\$3,837
36	96	42	180	102	LKT3696-42TTRY	\$3,249	\$3,298	\$3,800	\$3,848
36	84	42	162	90	LKT3684-42TTRY	\$2,893	\$2,936	\$3,433	\$3,477

LAMINATE

Features:

- price reflects complete table - top and base
- ships KD in multiple cartons
- one piece top
- model includes adjustable glide

Options:

- specify power/charging option, see below for options and upcharges

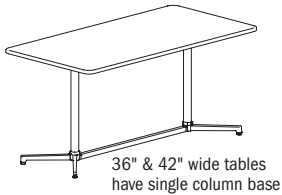

top shape

LOK - CONFERENCE

To Order Specify

① Laminate Model #	② Edge Detail	③ Laminate Selection	④ PVC Edge Color	⑤ Electrical	⑥ Metal Color
Laminate (LKT)	<a href="#">See Edge Detail Options</a>	<a href="#">See Laminate Selection</a>	<a href="#">See PVC Edge Color Options</a>	N None CT2 Dual Power Center Top CU2 Dual Power Underside CT2U1 Dual Power Center Top with Underside (See chart on next page)	<a href="#">See Metal Finish Color Options</a>

Model Number Breakdown

LKT4896-42TTRY						
LK	T	4896	42	TT	R	Y
LOK	Laminate	48" x 96"	Height	Rectangular Top Shape	Rounded Corner	Y Base

Description

Rounded Rectangular Table with Y Base at Bar Height (continued)

Veneer Tables "LKV" Models      Solid Surface Tables "LKS" Models

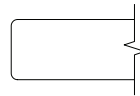

Eased Edge (R3)

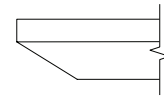

Reverse Bevel Edge (K9)

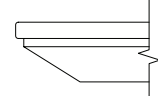

Reverse Bevel Edge (K7)

	D	W	H	CTN WT	CU FT	① Model	Veneer		Solid Surface		
							Essentials	Artisan	Essentials	Artisan	Standard
VENEER	48	96	42	229	132	LKV4896-42TTRY	\$5,671	\$6,085	\$6,051	\$6,437	--
	48	84	42	215	117	LKV4884-42TTRY	\$5,136	\$5,495	\$5,489	\$5,824	--
	42	96	42	200	118	LKV4296-42TTRY	\$6,645	\$7,176	\$7,244	\$7,714	--
	42	84	42	160	103	LKV4284-42TTRY	\$4,830	\$5,216	\$5,266	\$5,606	--
	36	96	42	180	102	LKV3696-42TTRY	\$4,356	\$4,705	\$4,747	\$5,057	--
	36	84	42	162	90	LKV3684-42TTRY	\$3,973	\$4,292	\$4,329	\$4,613	--
SOLID SURFACE	48	96	42	229	132	LKS4896-42TTRY	--	--	--	--	\$12,914
	48	84	42	215	117	LKS4884-42TTRY	--	--	--	--	\$11,421
	42	96	36	197	102	LKS4296-42TTRY	--	--	--	--	\$11,670
	42	84	42	160	103	LKS4284-42TTRY	--	--	--	--	\$9,473
	36	96	42	180	102	LKS3696-42TTRY	--	--	--	--	\$9,389
	36	84	42	162	90	LKS3684-42TTRY	--	--	--	--	\$8,440

Electrical Options and Upcharges

CT2	84 - 96 wide
Dual Power Center Top - Black	CT2BL - add \$1,837
Dual Power Center Top - White	CT2WH - add \$1,837
CU1	
Dual Power Underside - Black	CU1-1C - add \$731
Dual Power Underside with Wireless Charging - Black	CU1-1CW - add \$1,691
CT2U1	
Dual Power Center Top - Black with Underside	CT2U1-BL - add \$2,235
Dual Power Center Top - White with Underside	CT2U1-WH - add \$2,235
Dual Power Center Top - Black with Wireless Charging	CT2U1-BLW2 - add \$3,194
Dual Power Center Top - White with Wireless Charging	CT2U1-WHW2 - add \$3,194

Note: Order power infeed that best fits application

To Order Specify

① Veneer Model #	② Edge Detail	③ Wood Collection	④ Wood Finish	⑤ Electrical	⑥ Metal Color
Veneer (LKV)	<a href="#">See Edge Detail Options</a>	Essentials	<a href="#">See Essentials Wood Finish Options</a>	N None CT2 Dual Power Center Top CU2 Dual Power Underside CT2U1 Dual Power Center Top with Underside (See chart above)	<a href="#">See Metal Finish Color Options</a>
		Artisan	④ Wood Finish <a href="#">See Artisan Wood Finish Options</a>		

① Solid Surface Model #	② Top Surface Selection	③ Electrical	④ Metal Color
Solid Surface (LKS)	<a href="#">See Solid Surface Top Surface Selection Options</a>	N None CT2 Dual Power Center Top CU2 Dual Power Underside CT2U1 Dual Power Center Top with Underside (See chart above)	<a href="#">See Metal Finish Color Options</a>

LOK - CONFERENCE

Description

Arc Rectangular Table with T Base at Bar Height

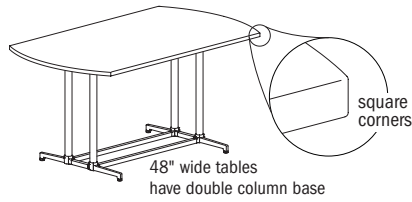

Laminate Tables "LKT" Models

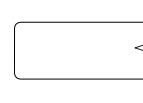

Eased Edge (R3)

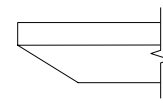

Reverse Bevel Edge (K9)

LAMINATE	D	W	H	CTN WT	CU FT	Model	Eased Edge (R3)		Reverse Bevel Edge (K9)	
							Standard Tier 1	Graded In Tier 2	Standard Tier 1	Graded In Tier 2
	48	96	42	232	132	LKT4896-42ART	\$4,189	\$4,253	\$4,771	\$4,836
48	84	42	208	117	LKT4884-42ART	\$3,815	\$3,871	\$4,383	\$4,436	
42	96	42	186	118	LKT4296-42ART	\$3,718	\$3,774	\$4,287	\$4,342	
42	84	42	207	90	LKT4284-42ART	\$3,812	\$3,860	\$4,365	\$4,415	
36	96	42	166	102	LKT3696-42ART	\$3,160	\$3,209	\$3,713	\$3,760	
36	84	42	147	90	LKT3684-42ART	\$2,856	\$2,897	\$3,396	\$3,438	

Features:

- price reflects complete table - top and base
- ships KD in multiple cartons
- one piece top
- model includes adjustable glide

Options:

- specify power/charging option, see below for options and upcharges

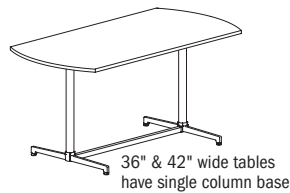

top shape

To Order Specify

1 Laminate Model #	2 Edge Detail	3 Laminate Selection	3a PVC Edge Color	4 Electrical	5 Metal Color
Laminate (LKT)	<a href="#">See Edge Detail Options</a>	<a href="#">See Laminate Selection</a>	<a href="#">See PVC Edge Color Options</a>	N None CT2 Dual Power Center Top CU2 Dual Power Underside CT2U1 Dual Power Center Top with Underside (See chart on next page)	<a href="#">See Metal Finish Color Options</a>

Model Number Breakdown

LKT4896-42ART					
LK	T	4896	42	AR	T
LOK	Laminate	48" x 96"	Height	Arc Rectangular Top Shape	T Base

Description

Arc Rectangular Table with T Base at Bar Height (continued)

Veneer Tables "LKV" Models

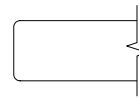

Eased Edge (R3)

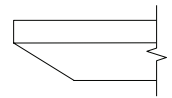

Reverse Bevel Edge (K9)

D	W	H	CTN WT	CU FT	Model	Essentials		Artisan	
						Essentials	Artisan	Essentials	Artisan
48	96	42	232	132	LKV4896-42ART	\$5,800	\$6,216	\$6,178	\$6,566
48	84	42	208	117	LKV4884-42ART	\$5,392	\$5,749	\$5,746	\$6,082
42	96	42	186	118	LKV4296-42ART	\$5,511	\$5,948	\$6,005	\$6,393
42	84	42	207	90	LKV4284-42ART	\$5,537	\$5,978	\$6,035	\$6,427
36	96	42	166	102	LKV3696-42ART	\$4,249	\$4,586	\$4,628	\$4,928
36	84	42	147	90	LKV3684-42ART	\$3,927	\$4,239	\$4,278	\$4,558

VENEER

Electrical Options and Upcharges

CT2	84 - 96 wide
Dual Power Center Top - Black	CT2BL - add \$1,837
Dual Power Center Top - White	CT2WH - add \$1,837
CU1	
Dual Power Underside - Black	CU1-1C - add \$731
Dual Power Underside with Wireless Charging - Black	CU1-1CW - add \$1,691
CT2U1	
Dual Power Center Top - Black with Underside	CT2U1-BL - add \$2,235
Dual Power Center Top - White with Underside	CT2U1-WH - add \$2,235
Dual Power Center Top - Black with Wireless Charging	CT2U1-BLW2 - add \$3,194
Dual Power Center Top - White with Wireless Charging	CT2U1-WhW2 - add \$3,194

Note: Order power infeed that best fits application

To Order Specify

1 Veneer Model #	2 Edge Detail	3 Wood Collection	4 Wood Finish	5 Electrical	6 Metal Color
Veneer (LKV)	<a href="#">See Edge Detail Options</a>	Essentials	<a href="#">See Essentials Wood Finish Options</a>	N None CT2 Dual Power Center Top CU2 Dual Power Underside CT2U1 Dual Power Center Top with Underside (See chart above)	<a href="#">See Metal Finish Color Options</a>
		Artisan	4 Wood Finish <a href="#">See Artisan Wood Finish Options</a>		

LOK - CONFERENCE

Description

Rounded Arc Rectangular Table with T Base at Bar Height

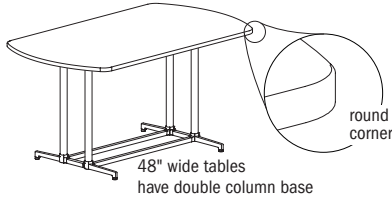

Laminate Tables  
"LKT" Models

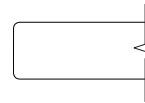

Eased Edge (R3)

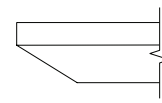

Reverse Bevel Edge (K9)

D	W	H	CTN WT	CU FT	Model	Eased Edge (R3)		Reverse Bevel Edge (K9)	
						Standard Tier 1	Graded In Tier 2	Standard Tier 1	Graded In Tier 2
48	96	42	232	132	LKT4896-42ARRT	\$4,189	\$4,253	\$4,771	\$4,836
48	84	42	208	117	LKT4884-42ARRT	\$3,815	\$3,871	\$4,383	\$4,436
42	96	42	186	118	LKT4296-42ARRT	\$3,718	\$3,774	\$4,287	\$4,342
42	84	42	207	90	LKT4284-42ARRT	\$3,812	\$3,860	\$4,365	\$4,415
36	96	42	166	102	LKT3696-42ARRT	\$3,160	\$3,209	\$3,713	\$3,760
36	84	42	147	90	LKT3684-42ARRT	\$2,856	\$2,897	\$3,396	\$3,438

LAMINATE

Features:

- price reflects complete table - top and base
- ships KD in multiple cartons
- one piece top
- model includes adjustable glide

Options:

- specify power/charging option, see below for options and upcharges

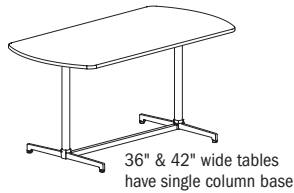

top shape

LOK - CONFERENCE

To Order Specify

1 Laminate Model #	2 Edge Detail	3 Laminate Selection	3a PVC Edge Color	4 Electrical	5 Metal Color
Laminate (LKT)	<a href="#">See Edge Detail Options</a>	<a href="#">See Laminate Selection</a>	<a href="#">See PVC Edge Color Options</a>	N None CT2 Dual Power Center Top CU2 Dual Power Underside CT2U1 Dual Power Center Top with Underside (See chart on next page)	<a href="#">See Metal Finish Color Options</a>

Model Number Breakdown

LKT4896-42ARRT						
LK	T	4896	42	AR	R	T
LOK	Laminate	48" x 96"	Height	Arc Rectangular Top Shape	Rounded Corner	T Base

Description

Rounded Arc Rectangular Table with T Base at Bar Height (continued)

Veneer Tables "LKV" Models      Solid Surface Tables "LKS" Models

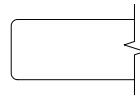

Eased Edge (R3)

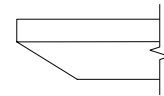

Reverse Bevel Edge (K9)

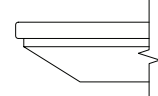

Reverse Bevel Edge (K7)

	D	W	H	CTN WT	CU FT	① Model	Veneer		Solid Surface		
							Essentials	Artisan	Essentials	Artisan	Standard
VENEER	48	96	42	232	132	LKV4896-42ARRT	\$5,800	\$6,216	\$6,178	\$6,566	--
	48	84	42	208	117	LKV4884-42ARRT	\$5,392	\$5,749	\$5,746	\$6,082	--
	42	96	42	186	118	LKV4296-42ARRT	\$5,511	\$5,948	\$6,005	\$6,393	--
	42	84	42	207	90	LKV4284-42ARRT	\$5,537	\$5,978	\$6,035	\$6,427	--
	36	96	42	166	102	LKV3696-42ARRT	\$4,249	\$4,586	\$4,628	\$4,928	--
	36	84	42	147	90	LKV3684-42ARRT	\$3,927	\$4,239	\$4,278	\$4,558	--
SOLID SURFACE	48	96	42	232	132	LKS4896-42ARRT	--	--	--	--	\$13,043
	48	84	42	208	117	LKS4884-42ARRT	--	--	--	--	\$11,678
	42	96	42	186	118	LKS4296-42ARRT	--	--	--	--	\$10,534
	42	84	42	207	90	LKS4284-42ARRT	--	--	--	--	\$10,183
	36	96	42	166	102	LKS3696-42ARRT	--	--	--	--	\$9,284
	36	84	42	147	90	LKS3684-42ARRT	--	--	--	--	\$8,390

Electrical Options and Upcharges

CT2	84 - 96 wide
Dual Power Center Top - Black	CT2BL - add \$1,837
Dual Power Center Top - White	CT2WH - add \$1,837
CU1	
Dual Power Underside - Black	CU1-1C - add \$731
Dual Power Underside with Wireless Charging - Black	CU1-1CW - add \$1,691
CT2U1	
Dual Power Center Top - Black with Underside	CT2U1-BL - add \$2,235
Dual Power Center Top - White with Underside	CT2U1-WH - add \$2,235
Dual Power Center Top - Black with Wireless Charging	CT2U1-BLW2 - add \$3,194
Dual Power Center Top - White with Wireless Charging	CT2U1-WHW2 - add \$3,194

Note: Order power infeed that best fits application

To Order Specify

① Veneer Model #	② Edge Detail	③ Wood Collection	④ Wood Finish	⑤ Electrical	⑥ Metal Color
Veneer (LKV)	<a href="#">See Edge Detail Options</a>	Essentials	<a href="#">See Essentials Wood Finish Options</a>	N None CT2 Dual Power Center Top CU2 Dual Power Underside CT2U1 Dual Power Center Top with Underside (See chart above)	<a href="#">See Metal Finish Color Options</a>
		Artisan	④ Wood Finish <a href="#">See Artisan Wood Finish Options</a>		

① Solid Surface Model #	② Top Surface Selection	③ Electrical	④ Metal Color
Solid Surface (LKS)	<a href="#">See Solid Surface Top Surface Selection Options</a>	N None CT2 Dual Power Center Top CU2 Dual Power Underside CT2U1 Dual Power Center Top with Underside (See chart above)	<a href="#">See Metal Finish Color Options</a>

LOK - CONFERENCE

Description

Arc Rectangular Table with Y Base at Bar Height

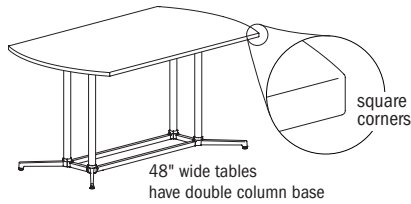

Laminate Tables "LKT" Models

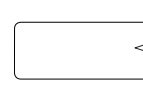

Eased Edge (R3)

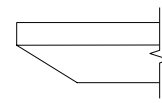

Reverse Bevel Edge (K9)

LAMINATE	D	W	H	CTN WT	CU FT	Model	Eased Edge (R3)		Reverse Bevel Edge (K9)	
							Standard Tier 1	Graded In Tier 2	Standard Tier 1	Graded In Tier 2
	48	96	42	231	132	LKT4896-42ARY	\$4,089	\$4,152	\$4,671	\$4,735
48	84	42	207	117	LKT4884-42ARY	\$3,609	\$3,667	\$4,180	\$4,235	
42	96	42	196	118	LKT4296-42ARY	\$4,627	\$4,681	\$5,193	\$5,249	
42	84	42	160	103	LKT4284-42ARY	\$3,234	\$3,281	\$3,789	\$3,837	
36	96	42	167	102	LKT3696-42ARY	\$3,249	\$3,298	\$3,800	\$3,848	
36	84	42	153	90	LKT3684-42ARY	\$2,893	\$2,936	\$3,433	\$3,477	

Features:

- price reflects complete table - top and base
- ships KD in multiple cartons
- one piece top
- model includes adjustable glide

Options:

- specify power/charging option, see below for options and upcharges

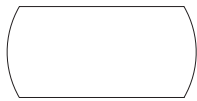
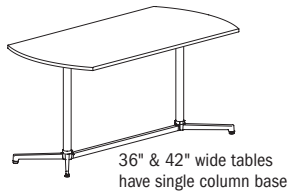

top shape

LOK - CONFERENCE

To Order Specify

1 Laminate Model #	2 Edge Detail	3 Laminate Selection	3a PVC Edge Color	4 Electrical	5 Metal Color
Laminate (LKT)	<a href="#">See Edge Detail Options</a>	<a href="#">See Laminate Selection</a>	<a href="#">See PVC Edge Color Options</a>	N None CT2 Dual Power Center Top CU2 Dual Power Underside CT2U1 Dual Power Center Top with Underside (See chart on next page)	<a href="#">See Metal Finish Color Options</a>

Model Number Breakdown

LKT4896-42ARY					
LK	T	4896	42	AR	Y
LOK	Laminate	48" x 96"	Height	Acr Rectangular Top Shape	Y Base

Description

Arc Rectangular Table with Y Base at Bar Height (continued)

Veneer Tables "LKV" Models

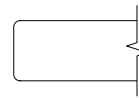

Eased Edge (R3)

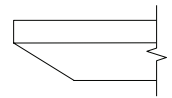

Reverse Bevel Edge (K9)

D	W	H	CTN WT	CU FT	Model	Essentials		Artisan	
						Essentials	Artisan	Essentials	Artisan
48	96	42	231	132	LKV4896-42ARY	\$5,671	\$6,085	\$6,051	\$6,437
48	84	42	207	117	LKV4884-42ARY	\$5,136	\$5,495	\$5,489	\$5,824
42	96	42	196	118	LKV4296-42ARY	\$6,645	\$7,176	\$7,244	\$7,714
	84	42	160	103	LKV4284-42ARY	\$4,830	\$5,216	\$5,266	\$5,606
36	96	42	167	102	LKV3696-42ARY	\$4,356	\$4,705	\$4,747	\$5,057
36	84	42	153	90	LKV3684-42ARY	\$3,973	\$4,292	\$4,329	\$4,613

VENEER

Electrical Options and Upcharges

CT2	84 - 96 wide
Dual Power Center Top - Black	CT2BL - add \$1,837
Dual Power Center Top - White	CT2WH - add \$1,837
CU1	
Dual Power Underside - Black	CU1-1C - add \$731
Dual Power Underside with Wireless Charging - Black	CU1-1CW - add \$1,691
CT2U1	
Dual Power Center Top - Black with Underside	CT2U1-BL - add \$2,235
Dual Power Center Top - White with Underside	CT2U1-WH - add \$2,235
Dual Power Center Top - Black with Wireless Charging	CT2U1-BLW2 - add \$3,194
Dual Power Center Top - White with Wireless Charging	CT2U1-WhW2 - add \$3,194

Note: Order power infeed that best fits application

To Order Specify

1 Veneer Model #	2 Edge Detail	3 Wood Collection	4 Wood Finish	5 Electrical	6 Metal Color
Veneer (LKV)	<a href="#">See Edge Detail Options</a>	Essentials	<a href="#">See Essentials Wood Finish Options</a>	N None CT2 Dual Power Center Top CU2 Dual Power Underside CT2U1 Dual Power Center Top with Underside (See chart above)	<a href="#">See Metal Finish Color Options</a>
		Artisan	<b>4 Wood Finish</b> <a href="#">See Artisan Wood Finish Options</a>		

LOK - CONFERENCE

Description

Rounded Arc Rectangular Table with Y Base at Bar Height

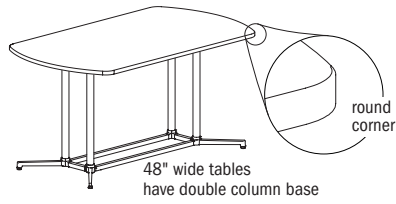

Laminate Tables  
"LKT" Models

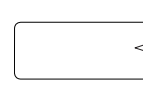

Eased Edge (R3)

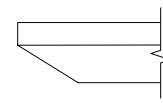

Reverse Bevel Edge (K9)

LAMINATE	D	W	H	CTN WT	CU FT	Model	Standard Tier 1	Graded In Tier 2	Standard Tier 1	Graded In Tier 2
		48	96	42	231	132	LKT4896-42ARRY	\$4,089	\$4,152	\$4,671
	48	84	42	175	117	LKT4884-42ARRY	\$3,609	\$3,667	\$4,180	\$4,235
	42	96	42	196	118	LKT4296-42ARRY	\$4,627	\$4,681	\$5,193	\$5,249
	42	84	42	180	103	LKT4284-42ARRY	\$3,234	\$3,281	\$3,789	\$3,837
	36	96	42	167	102	LKT3696-42ARRY	\$3,249	\$3,298	\$3,800	\$3,848
	36	84	42	159	90	LKT3684-42ARRY	\$2,893	\$2,936	\$3,433	\$3,477

Features:

- price reflects complete table - top and base
- ships KD in multiple cartons
- one piece top
- model includes adjustable glide

Options:

- specify power/charging option, see below for options and upcharges

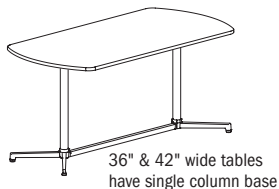

top shape

LOK - CONFERENCE

To Order Specify

1 Laminite Model #	2 Edge Detail	3 Laminite Selection	3a PVC Edge Color	4 Electrical	5 Metal Color
Laminite (LKT)	<a href="#">See Edge Detail Options</a>	<a href="#">See Laminite Selection</a>	<a href="#">See PVC Edge Color Options</a>	N None CT2 Dual Power Center Top CU2 Dual Power Underside CT2U1 Dual Power Center Top with Underside (See chart on next page)	<a href="#">See Metal Finish Color Options</a>

Model Number Breakdown

LKT4896-42ARRY						
LK	T	4896	42	AR	R	Y
LOK	Laminite	48" x 96"	Height	Arc Rectangular Top Shape	Rounded Corner	Y Base

Description

Rounded Arc Rectangular Table with Y Base at Bar Height (continued)

Veneer Tables "LKV" Models      Solid Surface Tables "LKS" Models

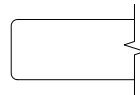

Eased Edge (R3)

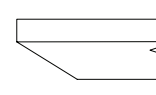

Reverse Bevel Edge (K9)

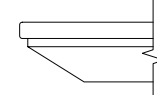

Reverse Bevel Edge (K7)

	D	W	H	CTN WT	CU FT	① Model	Veneer		Solid Surface		
							Essentials	Artisan	Essentials	Artisan	Standard
VENEER	48	96	42	231	132	LKV4896-42ARRY	\$5,671	\$6,085	\$6,051	\$6,437	--
	48	84	42	175	117	LKV4884-42ARRY	\$5,136	\$5,495	\$5,489	\$5,824	--
	42	96	42	196	118	LKV4296-42ARRY	\$6,645	\$7,176	\$7,244	\$7,714	--
	42	84	42	180	103	LKV4284-42ARRY	\$4,830	\$5,216	\$5,266	\$5,606	--
	36	96	42	167	102	LKV3696-42ARRY	\$4,356	\$4,705	\$4,747	\$5,057	--
	36	84	42	159	90	LKV3684-42ARRY	\$3,973	\$4,292	\$4,329	\$4,613	--
SOLID SURFACE	48	96	42	231	132	LKS4896-42ARRY	--	--	--	--	\$12,914
	48	84	42	175	117	LKS4884-42ARRY	--	--	--	--	\$11,421
	42	96	42	196	118	LKS4296-42ARRY	--	--	--	--	\$11,670
	42	84	42	180	103	LKS4284-42ARRY	--	--	--	--	\$9,473
	36	96	42	167	102	LKS3696-42ARRY	--	--	--	--	\$9,389
	36	84	42	159	90	LKS3684-42ARRY	--	--	--	--	\$8,440

Electrical Options and Upcharges

CT2	84 - 96 wide
Dual Power Center Top - Black	CT2BL - add \$1,837
Dual Power Center Top - White	CT2WH - add \$1,837
CU1	
Dual Power Underside - Black	CU1-1C - add \$731
Dual Power Underside with Wireless Charging - Black	CU1-1CW - add \$1,691
CT2U1	
Dual Power Center Top - Black with Underside	CT2U1-BL - add \$2,235
Dual Power Center Top - White with Underside	CT2U1-WH - add \$2,235
Dual Power Center Top - Black with Wireless Charging	CT2U1-BLW2 - add \$3,194
Dual Power Center Top - White with Wireless Charging	CT2U1-WHW2 - add \$3,194

Note: Order power infeed that best fits application

To Order Specify

① Veneer Model #	② Edge Detail	③ Wood Collection	④ Wood Finish	⑤ Electrical	⑥ Metal Color
Veneer (LKV)	<a href="#">See Edge Detail Options</a>	Essentials	<a href="#">See Essentials Wood Finish Options</a>	N None CT2 Dual Power Center Top CU2 Dual Power Underside CT2U1 Dual Power Center Top with Underside (See chart above)	<a href="#">See Metal Finish Color Options</a>
		Artisan	④ Wood Finish <a href="#">See Artisan Wood Finish Options</a>		

① Solid Surface Model #	② Top Surface Selection	③ Electrical	④ Metal Color
Solid Surface (LKS)	<a href="#">See Solid Surface Top Surface Selection Options</a>	N None CT2 Dual Power Center Top CU2 Dual Power Underside CT2U1 Dual Power Center Top with Underside (See chart above)	<a href="#">See Metal Finish Color Options</a>

LOK - CONFERENCE

Description

Racetrack Table with Y Base at Bar Height

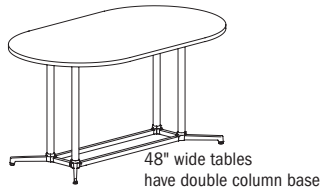

Laminate Tables "LKT" Models

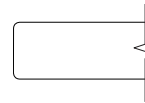

Eased Edge (R3)

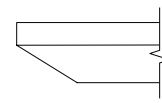

Reverse Bevel Edge (K9)

LAMINATE	D	W	H	CTN WT	CU FT	1 Model	Eased Edge (R3)		Reverse Bevel Edge (K9)	
							Standard Tier 1	Graded In Tier 2	Standard Tier 1	Graded In Tier 2
	48	96	42	219	132	LKT4896-42RKY	\$4,089	\$4,152	\$4,671	\$4,735
48	84	42	197	117	LKT4884-42RKY	\$3,609	\$3,667	\$4,180	\$4,235	
42	96	42	188	118	LKT4296-42RKY	\$4,627	\$4,681	\$5,193	\$5,249	
42	84	42	167	103	LKT4284-42RKY	\$3,234	\$3,281	\$3,789	\$3,837	
36	96	42	177	102	LKT3696-42RKY	\$3,249	\$3,298	\$3,800	\$3,848	
36	84	42	152	90	LKT3684-42RKY	\$2,893	\$2,936	\$3,433	\$3,477	

Features:

- price reflects complete table - top and base
- ships KD in multiple cartons
- one piece top
- model includes adjustable glide

Options:

- specify power/charging option, see below for options and upcharges



top shape

LOK - CONFERENCE

To Order Specify

1 Laminate Model #	2 Edge Detail	3 Laminate Selection	3a PVC Edge Color	4 Electrical	5 Metal Color
Laminate (LKT)	<a href="#">See Edge Detail Options</a>	<a href="#">See Laminate Selection</a>	<a href="#">See PVC Edge Color Options</a>	N None CT2 Dual Power Center Top CU2 Dual Power Underside CT2U1 Dual Power Center Top with Underside (See chart on next page)	<a href="#">See Metal Finish Color Options</a>

Model Number Breakdown

LKT4896-42RKY					
LK	T	4896	42	RK	Y
LOK	Laminate	48" x 96"	Height	Racetrack Top Shape	Y Base

Description

Racetrack Table with Y Base at Bar Height (continued)

Veneer Tables "LKV" Models

Solid Surface Tables "LKS" Models

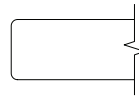

Eased Edge (R3)

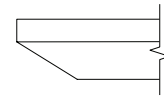

Reverse Bevel Edge (K9)

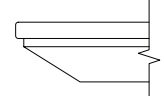

Reverse Bevel Edge (K7)

	D	W	H	CTN WT	CU FT	① Model	Veneer Tables		Solid Surface Tables		
							Essentials	Artisan	Essentials	Artisan	Standard
VENEER	48	96	42	219	132	LKV4896-42RKY	\$5,671	\$6,085	\$6,051	\$6,437	--
	48	84	42	197	117	LKV4884-42RKY	\$5,136	\$5,495	\$5,489	\$5,824	--
	42	96	42	188	118	LKV4296-42RKY	\$6,645	\$7,176	\$7,244	\$7,714	--
	42	84	42	167	103	LKV4284-42RKY	\$4,830	\$5,216	\$5,266	\$5,606	--
	36	96	42	177	102	LKV3696-42RKY	\$4,356	\$4,705	\$4,747	\$5,057	--
	36	84	42	152	90	LKV3684-42RKY	\$3,973	\$4,292	\$4,329	\$4,613	--
SOLID SURFACE	48	96	42	219	132	LKS4896-42RKY	--	--	--	--	\$12,914
	48	84	42	197	117	LKS4884-42RKY	--	--	--	--	\$11,421
	42	96	42	188	118	LKS4296-42RKY	--	--	--	--	\$11,670
	42	84	42	167	103	LKS4284-42RKY	--	--	--	--	\$9,473
	36	96	42	177	102	LKS3696-42RKY	--	--	--	--	\$9,389
	36	84	42	152	90	LKS3684-42RKY	--	--	--	--	\$8,440

Electrical Options and Upcharges

CT2	84 - 96 wide
Dual Power Center Top - Black	CT2BL - add \$1,837
Dual Power Center Top - White	CT2WH - add \$1,837
CU1	
Dual Power Underside - Black	CU1-1C - add \$731
Dual Power Underside with Wireless Charging - Black	CU1-1CW - add \$1,691
CT2U1	
Dual Power Center Top - Black with Underside	CT2U1-BL - add \$2,235
Dual Power Center Top - White with Underside	CT2U1-WH - add \$2,235
Dual Power Center Top - Black with Wireless Charging	CT2U1-BLW2 - add \$3,194
Dual Power Center Top - White with Wireless Charging	CT2U1-WHW2 - add \$3,194

Note: Order power infeed that best fits application

To Order Specify

① Veneer Model #	② Edge Detail	③ Wood Collection	④ Wood Finish	⑤ Electrical	⑥ Metal Color
Veneer (LKV)	<a href="#">See Edge Detail Options</a>	Essentials	<a href="#">See Essentials Wood Finish Options</a>	N None CT2 Dual Power Center Top CU2 Dual Power Underside CT2U1 Dual Power Center Top with Underside (See chart above)	<a href="#">See Metal Finish Color Options</a>
		Artisan	④ Wood Finish <a href="#">See Artisan Wood Finish Options</a>		

① Solid Surface Model #	② Top Surface Selection	③ Electrical	④ Metal Color
Solid Surface (LKS)	<a href="#">See Solid Surface Top Surface Selection Options</a>	N None CT2 Dual Power Center Top CU2 Dual Power Underside CT2U1 Dual Power Center Top with Underside (See chart above)	<a href="#">See Metal Finish Color Options</a>

LOK - CONFERENCE

Description

Oval Table with Y Base at Bar Height

Laminate Tables  
"LKT" Models

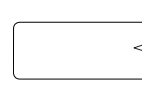
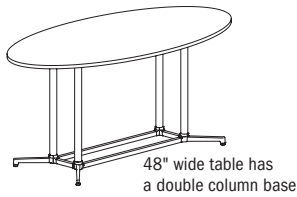

Eased Edge (R3)

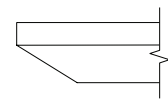

Reverse Bevel Edge (K9)

LAMINATE	D	W	H	CTN WT	CU FT	Model	Eased Edge (R3)		Reverse Bevel Edge (K9)	
							Standard Tier 1	Graded In Tier 2	Standard Tier 1	Graded In Tier 2
	48	96	42	198	132	LKT4896-420VY	\$3,793	\$3,854	\$4,374	\$4,436
42	84	42	153	103	LKT4284-420VY	\$3,234	\$3,281	\$3,789	\$3,837	

Features:

- price reflects complete table - top and base
- ships KD in multiple cartons
- one piece top
- model includes adjustable glide

Options:

- specify power/charging option, see below for options and upcharges

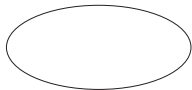
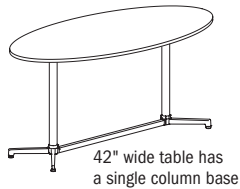

top shape

LOK - CONFERENCE

To Order Specify

1 Laminite Model #	2 Edge Detail	3 Laminite Selection	3a PVC Edge Color	4 Electrical	5 Metal Color
Laminite (LKT)	<a href="#">See Edge Detail Options</a>	<a href="#">See Laminite Selection</a>	<a href="#">See PVC Edge Color Options</a>	N None CT2 Dual Power Center Top CU2 Dual Power Underside CT2U1 Dual Power Center Top with Underside (See chart on next page)	<a href="#">See Metal Finish Color Options</a>

Model Number Breakdown

LKT4896-420VY					
LK	T	4896	42	OV	Y
LOK	Laminite	48" x 96"	Height	Oval Top Shape	Y Base

Description

Oval Table with Y Base at Bar Height  
(continued)

Veneer Tables  
"LKV" Models

Solid Surface Tables  
"LKS" Models

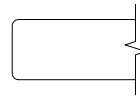

Eased Edge (R3)

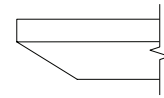

Reverse Bevel Edge (K9)

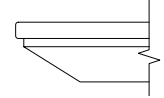

Reverse Bevel Edge (K7)

	D	W	H	CTN WT	CU FT	① Model	Veneer Tables "LKV" Models		Solid Surface Tables "LKS" Models		
							Essentials	Artisan	Essentials	Artisan	Standard
VENEER	48	96	42	198	132	LKV4896-420VY	\$5,290	\$5,708	\$5,673	\$6,061	--
	42	84	42	153	103	LKV4284-420VY	\$4,830	\$5,216	\$5,266	\$5,606	--
SOL. SURF.	48	96	42	198	132	LKS4896-420VY	--	--	--	--	\$12,537
	42	84	42	153	103	LKS4284-420VY	--	--	--	--	\$9,473

Electrical Options and Upcharges

CT2	84 - 96 wide
Dual Power Center Top - Black	CT2BL - add \$1,837
Dual Power Center Top - White	CT2WH - add \$1,837
CU1	
Dual Power Underside - Black	CU1-1C - add \$731
Dual Power Underside with Wireless Charging - Black	CU1-1CW - add \$1,691
CT2U1	
Dual Power Center Top - Black with Underside	CT2U1-BL - add \$2,235
Dual Power Center Top - White with Underside	CT2U1-WH - add \$2,235
Dual Power Center Top - Black with Wireless Charging	CT2U1-BLW2 - add \$3,194
Dual Power Center Top - White with Wireless Charging	CT2U1-WHW2 - add \$3,194

Note: Order power infeed that best fits application

To Order Specify

① Veneer Model #	② Edge Detail	③ Wood Collection	④ Wood Finish	⑤ Electrical	⑥ Metal Color
Veneer (LKV)	<a href="#">See Edge Detail Options</a>	Essentials	<a href="#">See Essentials Wood Finish Options</a>	N None CT2 Dual Power Center Top CU2 Dual Power Underside CT2U1 Dual Power Center Top with Underside (See chart above)	<a href="#">See Metal Finish Color Options</a>
		Artisan	④ Wood Finish <a href="#">See Artisan Wood Finish Options</a>		

① Solid Surface Model #	② Top Surface Selection	③ Electrical	④ Metal Color
Solid Surface (LKS)	<a href="#">See Solid Surface Top Surface Selection Options</a>	N None CT2 Dual Power Center Top CU2 Dual Power Underside CT2U1 Dual Power Center Top with Underside (See chart above)	<a href="#">See Metal Finish Color Options</a>

LOK - CONFERENCE

Description

Boat Table with T Base at Bar Height

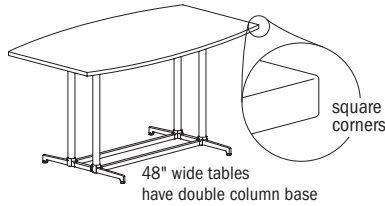

Laminate Tables  
"LKT" Models

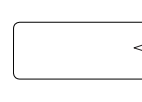

Eased Edge (R3)

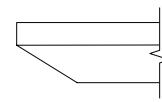

Reverse Bevel Edge (K9)

LAMINATE	D	W	H	CTN WT	CU FT	Model	Standard Tier 1	Graded In Tier 2	Standard Tier 1	Graded In Tier 2
		48	96	42	216	132	LKT4896-42BTT	\$4,189	\$4,253	\$4,771
	48	84	42	210	117	LKT4884-42BTT	\$3,815	\$3,871	\$4,383	\$4,436
	42	96	42	183	118	LKT4296-42BTT	\$3,718	\$3,774	\$4,287	\$4,342
	42	84	42	209	105	LKT4284-42BTT	\$3,812	\$3,860	\$4,365	\$4,415
	36	96	42	162	102	LKT3696-42BTT	\$3,160	\$3,209	\$3,713	\$3,760
	36	84	42	146	90	LKT3684-42BTT	\$2,856	\$2,897	\$3,396	\$3,438

Features:

- price reflects complete table - top and base
- ships KD in multiple cartons
- one piece top
- model includes adjustable glide

Options:

- specify power/charging option, see below for options and upcharges

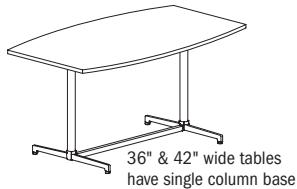

top shape

LOK - CONFERENCE

To Order Specify

1 Laminate Model #	2 Edge Detail	3 Laminate Selection	3a PVC Edge Color	4 Electrical	5 Metal Color
Laminate (LKT)	<a href="#">See Edge Detail Options</a>	<a href="#">See Laminate Selection</a>	<a href="#">See PVC Edge Color Options</a>	N None CT2 Dual Power Center Top CU2 Dual Power Underside CT2U1 Dual Power Center Top with Underside (See chart on next page)	<a href="#">See Metal Finish Color Options</a>

Model Number Breakdown

LKT4896-42BTT					
LK	T	4896	42	BT	T
LOK	Laminate	48" x 96"	Height	Boat Top Shape	T Base

Description

Boat Table with T Base at Bar Height  
(continued)

Veneer Tables  
"LKV" Models

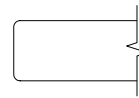

Eased Edge (R3)

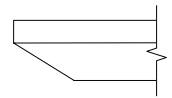

Reverse Bevel Edge (K9)

D	W	H	CTN WT	CU FT	① Model	Essentials		Artisan	
						Essentials	Artisan	Essentials	Artisan
48	96	42	216	132	LKV4896-42BTT	\$5,800	\$6,216	\$6,178	\$6,566
48	84	42	210	117	LKV4884-42BTT	\$5,392	\$5,749	\$5,746	\$6,082
42	96	42	183	118	LKV4296-42BTT	\$5,511	\$5,948	\$6,005	\$6,393
	84	42	209	105	LKV4284-42BTT	\$5,537	\$5,978	\$6,035	\$6,427
36	96	42	162	102	LKV3696-42BTT	\$4,249	\$4,586	\$4,628	\$4,928
36	84	42	146	90	LKV3684-42BTT	\$3,927	\$4,239	\$4,278	\$4,558

VENEER

Electrical Options and Upcharges

CT2	84 - 96 wide
Dual Power Center Top - Black	CT2BL - add \$1,837
Dual Power Center Top - White	CT2WH - add \$1,837
CU1	
Dual Power Underside - Black	CU1-1C - add \$731
Dual Power Underside with Wireless Charging - Black	CU1-1CW - add \$1,691
CT2U1	
Dual Power Center Top - Black with Underside	CT2U1-BL - add \$2,235
Dual Power Center Top - White with Underside	CT2U1-WH - add \$2,235
Dual Power Center Top - Black with Wireless Charging	CT2U1-BLW2 - add \$3,194
Dual Power Center Top - White with Wireless Charging	CT2U1-WhW2 - add \$3,194

Note: Order power infeed that best fits application

To Order Specify

① Veneer Model #	② Edge Detail	③ Wood Collection	④ Wood Finish	⑤ Electrical	⑥ Metal Color
Veneer (LKV)	<a href="#">See Edge Detail Options</a>	Essentials	<a href="#">See Essentials Wood Finish Options</a>	N None CT2 Dual Power Center Top CU2 Dual Power Underside CT2U1 Dual Power Center Top with Underside (See chart above)	<a href="#">See Metal Finish Color Options</a>
		Artisan	④ Wood Finish <a href="#">See Artisan Wood Finish Options</a>		

LOK- CONFERENCE

Description

Boat Table with Y Base at Bar Height

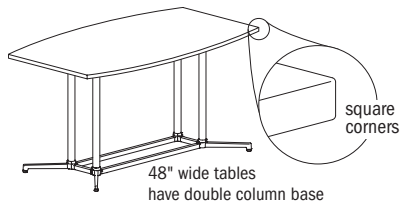

Laminate Tables  
"LKT" Models

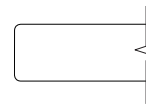

Eased Edge (R3)

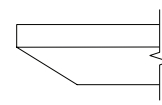

Reverse Bevel Edge (K9)

LAMINATE	D	W	H	CTN WT	CU FT	Model	Standard Tier 1	Graded In Tier 2	Standard Tier 1	Graded In Tier 2
		48	96	42	231	132	LKT4896-42BTY	\$4,089	\$4,152	\$4,671
	48	84	42	209	117	LKT4884-42BTY	\$3,609	\$3,667	\$4,180	\$4,235
	42	96	42	198	118	LKT4296-42BTY	\$4,627	\$4,681	\$5,193	\$5,249
	42	84	42	175	103	LKT4284-42BTY	\$3,234	\$3,281	\$3,789	\$3,837
	36	96	42	175	102	LKT3696-42BTY	\$3,249	\$3,298	\$3,800	\$3,848
	36	84	42	156	90	LKT3684-42BTY	\$2,893	\$2,936	\$3,433	\$3,477

Features:

- price reflects complete table - top and base
- ships KD in multiple cartons
- one piece top
- model includes adjustable glide

Options:

- specify power/charging option, see below for options and upcharges

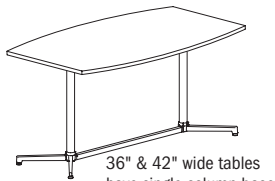

top shape

LOK - CONFERENCE

To Order Specify

1 Laminate Model #	2 Edge Detail	3 Laminate Selection	3a PVC Edge Color	4 Electrical	5 Metal Color
Laminate (LKT)	<a href="#">See Edge Detail Options</a>	<a href="#">See Laminate Selection</a>	<a href="#">See PVC Edge Color Options</a>	N None CT2 Dual Power Center Top CU2 Dual Power Underside CT2U1 Dual Power Center Top with Underside (See chart on next page)	<a href="#">See Metal Finish Color Options</a>

Model Number Breakdown

LKT4896-42BTY					
LK	T	4896	42	BT	Y
LOK	Laminate	48" x 96"	Height	Boat Top Shape	Y Base

Description

Boat Table with Y Base at Bar Height  
(continued)

Veneer Tables  
"LKV" Models

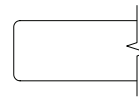

Eased Edge (R3)

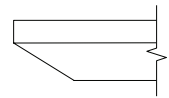

Reverse Bevel Edge (K9)

D	W	H	CTN WT	CU FT	① Model	Essentials		Artisan	
						Essentials	Artisan	Essentials	Artisan
48	96	42	231	132	LKV4896-42BTY	\$5,671	\$6,085	\$6,051	\$6,437
48	84	42	209	117	LKV4884-42BTY	\$5,136	\$5,495	\$5,489	\$5,824
42	96	42	198	118	LKV4296-42BTY	\$6,645	\$7,176	\$7,244	\$7,714
	84	42	175	103	LKV4284-42BTY	\$4,830	\$5,216	\$5,266	\$5,606
36	96	42	175	102	LKV3696-42BTY	\$4,356	\$4,705	\$4,747	\$5,057
36	84	42	156	90	LKV3684-42BTY	\$3,973	\$4,292	\$4,329	\$4,613

VENEER

Electrical Options and Upcharges

CT2	84 - 96 wide
Dual Power Center Top - Black	CT2BL - add \$1,837
Dual Power Center Top - White	CT2WH - add \$1,837
CU1	
Dual Power Underside - Black	CU1-1C - add \$731
Dual Power Underside with Wireless Charging - Black	CU1-1CW - add \$1,691
CT2U1	
Dual Power Center Top - Black with Underside	CT2U1-BL - add \$2,235
Dual Power Center Top - White with Underside	CT2U1-WH - add \$2,235
Dual Power Center Top - Black with Wireless Charging	CT2U1-BLW2 - add \$3,194
Dual Power Center Top - White with Wireless Charging	CT2U1-WhW2 - add \$3,194

Note: Order power infeed that best fits application

To Order Specify

① Veneer Model #	② Edge Detail	③ Wood Collection	④ Wood Finish	⑤ Electrical	⑥ Metal Color
Veneer (LKV)	<a href="#">See Edge Detail Options</a>	Essentials	<a href="#">See Essentials Wood Finish Options</a>	N None CT2 Dual Power Center Top CU2 Dual Power Underside CT2U1 Dual Power Center Top with Underside (See chart above)	<a href="#">See Metal Finish Color Options</a>
		Artisan	④ Wood Finish <a href="#">See Artisan Wood Finish Options</a>		

LOK - CONFERENCE

Description

Rounded Double Chevron Table with T Base at Bar Height

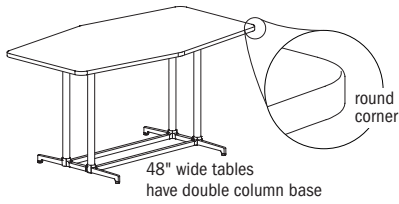

Laminate Tables "LKT" Models

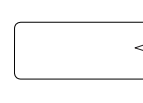

Eased Edge (R3)

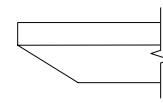

Reverse Bevel Edge (K9)

LAMINATE	D	W	H	CTN WT	CU FT	Model	Eased Edge (R3)		Reverse Bevel Edge (K9)	
							Standard Tier 1	Graded In Tier 2	Standard Tier 1	Graded In Tier 2
	48	96	42	216	132	LKT4896-42DCRT	\$4,189	\$4,253	\$4,771	\$4,836
	48	84	42	195	117	LKT4884-42DCRT	\$3,815	\$3,871	\$4,383	\$4,436
	42	96	42	189	118	LKT4296-42DCRT	\$3,718	\$3,774	\$4,287	\$4,342
	42	84	42	195	105	LKT4284-42DCRT	\$3,812	\$3,860	\$4,365	\$4,415
	36	96	42	152	102	LKT3696-42DCRT	\$3,160	\$3,209	\$3,713	\$3,760
	36	84	42	135	90	LKT3684-42DCRT	\$2,856	\$2,897	\$3,396	\$3,438

Features:

- price reflects complete table - top and base
- ships KD in multiple cartons
- one piece top
- model includes adjustable glide

Options:

- specify power/charging option, see below for options and upcharges

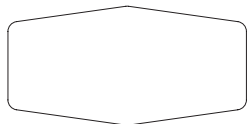
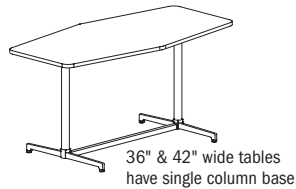

top shape

LOK - CONFERENCE

To Order Specify

1 Laminate Model #	2 Edge Detail	3 Laminate Selection	3a PVC Edge Color	4 Electrical	5 Metal Color
Laminate (LKT)	<a href="#">See Edge Detail Options</a>	<a href="#">See Laminate Selection</a>	<a href="#">See PVC Edge Color Options</a>	N None CT2 Dual Power Center Top CU2 Dual Power Underside CT2U1 Dual Power Center Top with Underside (See chart on next page)	<a href="#">See Metal Finish Color Options</a>

Model Number Breakdown

LKT4896-42DCRT						
LK	T	4896	42	DC	R	T
LOK	Laminate	48" x 96"	Height	Double Chevron Top Shape	Rounded Corner	T Base

Description

Rounded Double Chevron Table with T Base at Bar Height (continued)

Veneer Tables "LKV" Models      Solid Surface Tables "LKS" Models

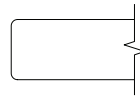

Eased Edge (R3)

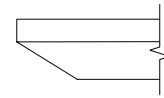

Reverse Bevel Edge (K9)

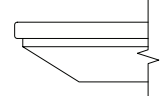

Reverse Bevel Edge (K7)

	D	W	H	CTN WT	CU FT	① Model	Veneer Tables		Solid Surface Tables		
							Essentials	Artisan	Essentials	Artisan	Standard
VENEER	48	96	42	216	132	LKV4896-42DCRT	\$5,800	\$6,216	\$6,178	\$6,566	--
	48	84	42	195	117	LKV4884-42DCRT	\$5,392	\$5,749	\$5,746	\$6,082	--
	42	96	42	189	118	LKV4296-42DCRT	\$5,511	\$5,948	\$6,005	\$6,393	--
	42	84	42	195	105	LKV4284-42DCRT	\$5,537	\$5,978	\$6,035	\$6,427	--
	36	96	42	152	102	LKV3696-42DCRT	\$4,249	\$4,586	\$4,628	\$4,928	--
	36	84	42	135	90	LKV3684-42DCRT	\$3,927	\$4,239	\$4,278	\$4,558	--
SOLID SURFACE	48	96	42	216	132	LKS4896-42DCRT	--	--	--	--	\$13,043
	48	84	42	195	117	LKS4884-42DCRT	--	--	--	--	\$11,678
	42	96	42	189	118	LKS4296-42DCRT	--	--	--	--	\$10,534
	42	84	42	195	105	LKS4284-42DCRT	--	--	--	--	\$10,183
	36	96	42	152	102	LKS3696-42DCRT	--	--	--	--	\$9,284
	36	84	42	135	90	LKS3684-42DCRT	--	--	--	--	\$8,390

Electrical Options and Upcharges

CT2	84 - 96 wide
Dual Power Center Top - Black	CT2BL - add \$1,837
Dual Power Center Top - White	CT2WH - add \$1,837
CU1	
Dual Power Underside - Black	CU1-1C - add \$731
Dual Power Underside with Wireless Charging - Black	CU1-1CW - add \$1,691
CT2U1	
Dual Power Center Top - Black with Underside	CT2U1-BL - add \$2,235
Dual Power Center Top - White with Underside	CT2U1-WH - add \$2,235
Dual Power Center Top - Black with Wireless Charging	CT2U1-BLW2 - add \$3,194
Dual Power Center Top - White with Wireless Charging	CT2U1-WHW2 - add \$3,194

Note: Order power infeed that best fits application

To Order Specify

① Veneer Model #	② Edge Detail	③ Wood Collection	④ Wood Finish	⑤ Electrical	⑥ Metal Color
Veneer (LKV)	<a href="#">See Edge Detail Options</a>	Essentials	<a href="#">See Essentials Wood Finish Options</a>	N None CT2 Dual Power Center Top CU2 Dual Power Underside CT2U1 Dual Power Center Top with Underside (See chart above)	<a href="#">See Metal Finish Color Options</a>
		Artisan	④ Wood Finish <a href="#">See Artisan Wood Finish Options</a>		

① Solid Surface Model #	② Top Surface Selection	③ Electrical	④ Metal Color
Solid Surface (LKS)	<a href="#">See Solid Surface Top Surface Selection Options</a>	N None CT2 Dual Power Center Top CU2 Dual Power Underside CT2U1 Dual Power Center Top with Underside (See chart above)	<a href="#">See Metal Finish Color Options</a>

LOK - CONFERENCE

Description

Rounded Double Chevron Table with Y Base at Bar Height

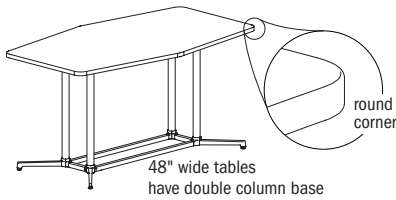

Laminate Tables  
"LKT" Models

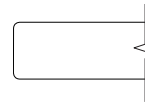

Eased Edge (R3)

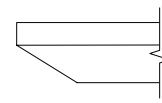

Reverse Bevel Edge (K9)

D	W	H	CTN WT	CU FT	① Model	Eased Edge (R3)		Reverse Bevel Edge (K9)	
						Standard Tier 1	Graded In Tier 2	Standard Tier 1	Graded In Tier 2
48	96	42	211	132	LKT4896-42DCRY	\$4,089	\$4,152	\$4,671	\$4,735
48	84	42	194	117	LKT4884-42DCRY	\$3,609	\$3,667	\$4,180	\$4,235
42	96	42	175	118	LKT4296-42DCRY	\$4,627	\$4,681	\$5,193	\$5,249
42	84	42	159	103	LKT4284-42DCRY	\$3,234	\$3,281	\$3,789	\$3,837
36	96	42	175	102	LKT3696-42DCRY	\$3,249	\$3,298	\$3,800	\$3,848
36	84	42	154	90	LKT3684-42DCRY	\$2,893	\$2,936	\$3,433	\$3,477

LAMINATE

Features:

- price reflects complete table - top and base
- ships KD in multiple cartons
- one piece top
- model includes adjustable glide

Options:

- specify power/charging option, see below for options and upcharges

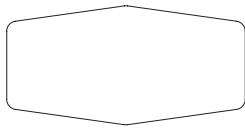
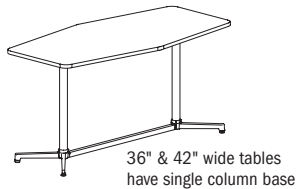

top shape

LOK - CONFERENCE

To Order Specify

① Laminate Model #	② Edge Detail	③ Laminate Selection	④ PVC Edge Color	⑤ Electrical	⑥ Metal Color
Laminate (LKT)	<a href="#">See Edge Detail Options</a>	<a href="#">See Laminate Selection</a>	<a href="#">See PVC Edge Color Options</a>	N None CT2 Dual Power Center Top CU2 Dual Power Underside CT2U1 Dual Power Center Top with Underside (See chart on next page)	<a href="#">See Metal Finish Color Options</a>

Model Number Breakdown

LKT4896-42DCRY						
LK	T	4896	42	DC	R	Y
LOK	Laminate	48" x 96"	Height	Double Chevron Top Shape	Rounded Corner	Y Base

Description

Rounded Double Chevron Table with Y Base at Bar Height (continued)

Veneer Tables "LKV" Models      Solid Surface Tables "LKS" Models

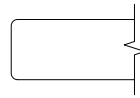

Eased Edge (R3)

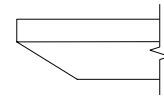

Reverse Bevel Edge (K9)

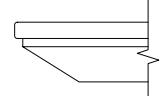

Reverse Bevel Edge (K7)

	D	W	H	CTN WT	CU FT	① Model	Veneer		Solid Surface		
							Essentials	Artisan	Essentials	Artisan	Standard
VENEER	48	96	42	211	132	LKV4896-42DCRY	\$5,671	\$6,085	\$6,051	\$6,437	--
	48	84	42	194	117	LKV4884-42DCRY	\$5,136	\$5,495	\$5,489	\$5,824	--
	42	96	42	175	118	LKV4296-42DCRY	\$6,645	\$7,176	\$7,244	\$7,714	--
	42	84	42	159	103	LKV4284-42DCRY	\$4,830	\$5,216	\$5,266	\$5,606	--
	36	96	42	175	102	LKV3696-42DCRY	\$4,356	\$4,705	\$4,747	\$5,057	--
	36	84	42	154	90	LKV3684-42DCRY	\$3,973	\$4,292	\$4,329	\$4,613	--
SOLID SURFACE	48	96	42	211	132	LKS4896-42DCRY	--	--	--	--	\$12,914
	48	84	42	194	117	LKS4884-42DCRY	--	--	--	--	\$11,421
	42	96	42	175	118	LKS4296-42DCRY	--	--	--	--	\$11,670
	42	84	42	159	103	LKS4284-42DCRY	--	--	--	--	\$9,473
	36	96	42	175	102	LKS3696-42DCRY	--	--	--	--	\$9,389
	36	84	42	154	90	LKS3684-42DCRY	--	--	--	--	\$8,440

Electrical Options and Upcharges

CT2	84 - 96 wide
Dual Power Center Top - Black	CT2BL - add \$1,837
Dual Power Center Top - White	CT2WH - add \$1,837
CU1	
Dual Power Underside - Black	CU1-1C - add \$731
Dual Power Underside with Wireless Charging - Black	CU1-1CW - add \$1,691
CT2U1	
Dual Power Center Top - Black with Underside	CT2U1-BL - add \$2,235
Dual Power Center Top - White with Underside	CT2U1-WH - add \$2,235
Dual Power Center Top - Black with Wireless Charging	CT2U1-BLW2 - add \$3,194
Dual Power Center Top - White with Wireless Charging	CT2U1-WHW2 - add \$3,194

Note: Order power infeed that best fits application

To Order Specify

① Veneer Model #	② Edge Detail	③ Wood Collection	④ Wood Finish	⑤ Electrical	⑥ Metal Color
Veneer (LKV)	<a href="#">See Edge Detail Options</a>	Essentials	<a href="#">See Essentials Wood Finish Options</a>	N None CT2 Dual Power Center Top CU2 Dual Power Underside CT2U1 Dual Power Center Top with Underside (See chart above)	<a href="#">See Metal Finish Color Options</a>
		Artisan	④ Wood Finish <a href="#">See Artisan Wood Finish Options</a>		

① Solid Surface Model #	② Top Surface Selection	③ Electrical	④ Metal Color
Solid Surface (LKS)	<a href="#">See Solid Surface Top Surface Selection Options</a>	N None CT2 Dual Power Center Top CU2 Dual Power Underside CT2U1 Dual Power Center Top with Underside (See chart above)	<a href="#">See Metal Finish Color Options</a>

LOK - CONFERENCE

Description

Taper Table with T Base at Bar Height

Laminate Tables  
"LKT" Models

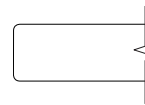
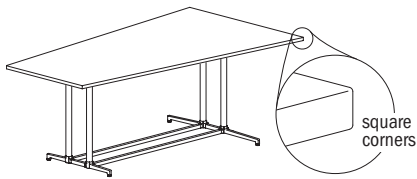

Eased Edge (R3)

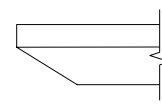

Reverse Bevel Edge (K9)

LAMI	D	W	H	CTN WT	CU FT	Model	Standard Tier 1	Graded In Tier 2	Standard Tier 1	Graded In Tier 2
		54	96	42	228	147	LKT5496-42TPT	\$4,480	\$4,552	\$5,077

Features:

- price reflects complete table - top and base
- ships KD in multiple cartons
- one piece top
- model includes adjustable glide

Options:

- specify power/charging option, see below for options and upcharges

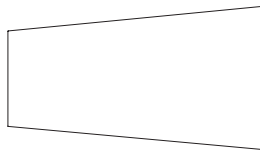

top shape

LOK - CONFERENCE

To Order Specify

1 Laminates Model #	2 Edge Detail	3 Laminates Selection	3a PVC Edge Color	4 Electrical	5 Metal Color
Laminates (LKT)	<a href="#">See Edge Detail Options</a>	<a href="#">See Laminates Selection</a>	<a href="#">See PVC Edge Color Options</a>	N None CT2 Dual Power Center Top CU2 Dual Power Underside CT2U1 Dual Power Center Top with Underside (See chart on next page)	<a href="#">See Metal Finish Color Options</a>

Model Number Breakdown

LKT5496-42TPT					
LK	T	5496	42	TP	T
LOK	Laminates	54" x 96"	Height	Taper Top Shape	T Base

Description

Taper Table with T Base at Bar Height  
(continued)

Veneer Tables  
"LKV" Models

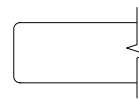

Eased Edge (R3)

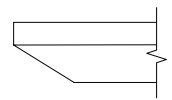

Reverse Bevel Edge (K9)

	D	W	H	CTN WT	CU FT	① Model	Essentials	Artisan	Essentials	Artisan
VEN.	54	96	42	228	147	LKV5496-42TPT	\$6,115	\$6,601	\$6,664	\$7,096

Electrical Options and Upcharges

	84 - 96 wide
<b>CT2</b>	
Dual Power Center Top - Black	CT2BL - add \$1,837
Dual Power Center Top - White	CT2WH - add \$1,837
<b>CU1</b>	
Dual Power Underside - Black	CU1-1C - add \$731
Dual Power Underside with Wireless Charging - Black	CU1-1CW - add \$1,691
<b>CT2U1</b>	
Dual Power Center Top - Black with Underside	CT2U1-BL - add \$2,235
Dual Power Center Top - White with Underside	CT2U1-WH - add \$2,235
Dual Power Center Top - Black with Wireless Charging	CT2U1-BLW2 - add \$3,194
Dual Power Center Top - White with Wireless Charging	CT2U1-WHW2 - add \$3,194

Note: Order power infeed that best fits application

To Order Specify

① Veneer Model #	② Edge Detail	③ Wood Collection	④ Wood Finish	⑤ Electrical	⑥ Metal Color
Veneer (LKV)	<a href="#">See Edge Detail Options</a>	Essentials	<a href="#">See Essentials Wood Finish Options</a>	N None CT2 Dual Power Center Top CU2 Dual Power Underside CT2U1 Dual Power Center Top with Underside (See chart above)	<a href="#">See Metal Finish Color Options</a>
		Artisan	④ Wood Finish <a href="#">See Artisan Wood Finish Options</a>		

LOK - CONFERENCE

Description

Rounded Taper Table with T Base at Bar Height

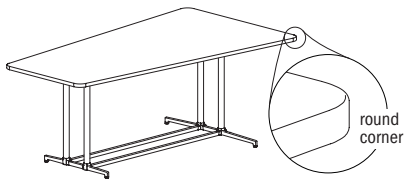

Laminate Tables "LKT" Models

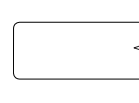

Eased Edge (R3)

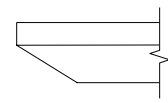

Reverse Bevel Edge (K9)

LAMI	D	W	H	CTN WT	CU FT	Model	Standard Tier 1	Graded In Tier 2	Standard Tier 1	Graded In Tier 2
		54	96	42	228	147	LKT5496-42TPRT	\$4,480	\$4,552	\$5,077

Features:

- price reflects complete table - top and base
- ships KD in multiple cartons
- one piece top
- model includes adjustable glide

Options:

- specify power/charging option, see below for options and upcharges

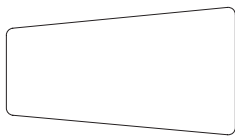

top shape

LOK - CONFERENCE

To Order Specify

1 Laminate Model #	2 Edge Detail	3 Laminate Selection	3a PVC Edge Color	4 Electrical	5 Metal Color
Laminate (LKT)	<a href="#">See Edge Detail Options</a>	<a href="#">See Laminate Selection</a>	<a href="#">See PVC Edge Color Options</a>	N None CT2 Dual Power Center Top CU2 Dual Power Underside CT2U1 Dual Power Center Top with Underside (See chart on next page)	<a href="#">See Metal Finish Color Options</a>

Model Number Breakdown

LKT5496-42TPRT						
LK	T	5496	42	TP	R	T
LOK	Laminate	54" x 96"	Height	Taper Top Shape	Rounded Corner	T Base

Description

Rounded Taper Table with T Base at Bar Height (continued)

Veneer Tables "LKV" Models      Solid Surface Tables "LKS" Models

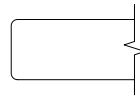

Eased Edge (R3)

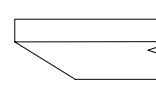

Reverse Bevel Edge (K9)

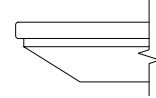

Reverse Bevel Edge (K7)

	D	W	H	CTN WT	CU FT	Model	Essentials	Artisan	Essentials	Artisan	Standard
VEN.	54	96	42	228	147	LKV5496-42TPRT	\$6,115	\$6,601	\$6,664	\$7,096	--
S.S.	54	96	42	228	147	LKS5496-42TPRT	--	--	--	--	\$16,937

Electrical Options and Upcharges

CT2	84 - 96 wide
Dual Power Center Top - Black	CT2BL - add \$1,837
Dual Power Center Top - White	CT2WH - add \$1,837
CU1	
Dual Power Underside - Black	CU1-1C - add \$731
Dual Power Underside with Wireless Charging - Black	CU1-1CW - add \$1,691
CT2U1	
Dual Power Center Top - Black with Underside	CT2U1-BL - add \$2,235
Dual Power Center Top - White with Underside	CT2U1-WH - add \$2,235
Dual Power Center Top - Black with Wireless Charging	CT2U1-BLW2 - add \$3,194
Dual Power Center Top - White with Wireless Charging	CT2U1-WHW2 - add \$3,194

Note: Order power infeed that best fits application

To Order Specify

1 Veneer Model #	2 Edge Detail	3 Wood Collection	4 Wood Finish	5 Electrical	6 Metal Color
Veneer (LKV)	<a href="#">See Edge Detail Options</a>	Essentials	<a href="#">See Essentials Wood Finish Options</a>	N None CT2 Dual Power Center Top CU2 Dual Power Underside CT2U1 Dual Power Center Top with Underside (See chart above)	<a href="#">See Metal Finish Color Options</a>
		Artisan	<b>4 Wood Finish</b> <a href="#">See Artisan Wood Finish Options</a>		

1 Solid Surface Model #	2 Top Surface Selection	3 Electrical	4 Metal Color
Solid Surface (LKS)	<a href="#">See Solid Surface Top Surface Selection Options</a>	N None CT2 Dual Power Center Top CU2 Dual Power Underside (See chart above) CT2U1 Dual Power Center Top with Underside	<a href="#">See Metal Finish Color Options</a>

LOK - CONFERENCE

Description

Taper Table with Y Base at Bar Height

Laminate Tables  
"LKT" Models

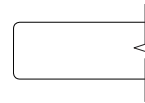
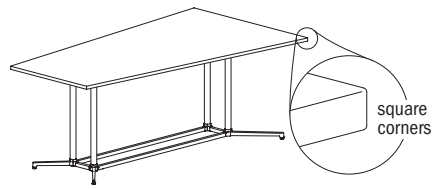

Eased Edge (R3)

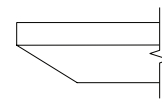

Reverse Bevel Edge (K9)

LAMI	D	W	H	CTN WT	CU FT	Model	Standard Tier 1	Graded In Tier 2	Standard Tier 1	Graded In Tier 2
		54	96	42	198	147	LKT5496-42TPY	\$4,336	\$4,406	\$4,933

Features:

- price reflects complete table - top and base
- ships KD in multiple cartons
- one piece top
- model includes adjustable glide

Options:

- specify power/charging option, see below for options and upcharges

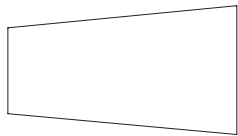

top shape

LOK - CONFERENCE

To Order Specify

1 Laminate Model #	2 Edge Detail	3 Laminate Selection	3a PVC Edge Color	4 Electrical	5 Metal Color
Laminate (LKT)	<a href="#">See Edge Detail Options</a>	<a href="#">See Laminate Selection</a>	<a href="#">See PVC Edge Color Options</a>	N None CT2 Dual Power Center Top CU2 Dual Power Underside CT2U1 Dual Power Center Top with Underside (See chart on next page)	<a href="#">See Metal Finish Color Options</a>

Model Number Breakdown

LKT5496-42TPY					
LK	T	5496	42	TP	Y
LOK	Laminate	54" x 96"	Height	Taper Top Shape	Y Base

Description

Taper Table with Y Base at Bar Height  
(continued)

Veneer Tables  
"LKV" Models

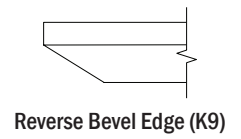
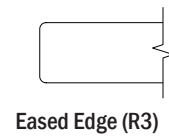

VEN.	D	W	H	CTN WT	CU FT	1 Model	Essentials	Artisan	Essentials	Artisan
		54	96	42	198	147	LKV5496-42TPY	\$5,938	\$6,414	\$6,474

Electrical Options and Upcharges

CT2	84 - 96 wide
Dual Power Center Top - Black	CT2BL - add \$1,837
Dual Power Center Top - White	CT2WH - add \$1,837
CU1	
Dual Power Underside - Black	CU1-1C - add \$731
Dual Power Underside with Wireless Charging - Black	CU1-1CW - add \$1,691
CT2U1	
Dual Power Center Top - Black with Underside	CT2U1-BL - add \$2,235
Dual Power Center Top - White with Underside	CT2U1-WH - add \$2,235
Dual Power Center Top - Black with Wireless Charging	CT2U1-BLW2 - add \$3,194
Dual Power Center Top - White with Wireless Charging	CT2U1-WHW2 - add \$3,194

Note: Order power infeed that best fits application

To Order Specify

1 Veneer Model #	2 Edge Detail	3 Wood Collection	4 Wood Finish	5 Electrical	6 Metal Color
Veneer (LKV)	<a href="#">See Edge Detail Options</a>	Essentials	<a href="#">See Essentials Wood Finish Options</a>	N None CT2 Dual Power Center Top CU2 Dual Power Underside CT2U1 Dual Power Center Top with Underside (See chart above)	<a href="#">See Metal Finish Color Options</a>
		Artisan	4 Wood Finish <a href="#">See Artisan Wood Finish Options</a>		

LOK- CONFERENCE

Description

Rounded Taper Table with Y Base at Bar Height

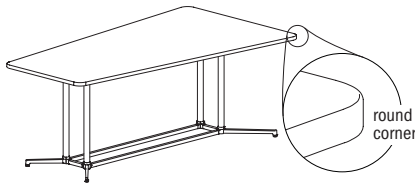

Laminate Tables  
"LKT" Models

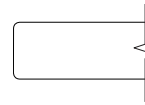

Eased Edge (R3)

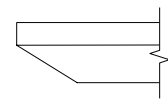

Reverse Bevel Edge (K9)

LAMI	D	W	H	CTN WT	CU FT	Model	Standard Tier 1	Graded In Tier 2	Standard Tier 1	Graded In Tier 2
		54	96	42	198	147	LKT5496-42TPRY	\$4,336	\$4,406	\$4,933

Features:

- price reflects complete table - top and base
- ships KD in multiple cartons
- one piece top
- model includes adjustable glide

Options:

- specify power/charging option, see below for options and upcharges

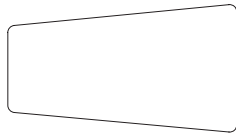

top shape

LOK - CONFERENCE

To Order Specify

1 Laminate Model #	2 Edge Detail	3 Laminate Selection	3a PVC Edge Color	4 Electrical	5 Metal Color
Laminate (LKT)	<a href="#">See Edge Detail Options</a>	<a href="#">See Laminate Selection</a>	<a href="#">See PVC Edge Color Options</a>	N None CT2 Dual Power Center Top CU2 Dual Power Underside CT2U1 Dual Power Center Top with Underside (See chart on next page)	<a href="#">See Metal Finish Color Options</a>

Model Number Breakdown

LKT5496-42TPRY						
LK	T	5496	42	TP	R	Y
LOK	Laminate	54" x 96"	Height	Taper Top Shape	Rounded Corner	Y Base

Description

Rounded Taper Table with Y Base at Bar Height (continued)

Veneer Tables "LKV" Models      Solid Surface Tables "LKS" Models

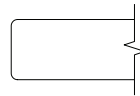

Eased Edge (R3)

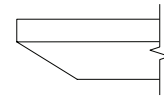

Reverse Bevel Edge (K9)

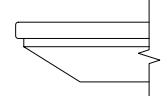

Reverse Bevel Edge (K7)

	D	W	H	CTN WT	CU FT	Model	Essentials	Artisan	Essentials	Artisan	Standard
VEN.	54	96	42	198	147	LKV5496-42TPRY	\$5,938	\$6,414	\$6,474	\$6,891	--
S.S.	54	96	42	198	147	LKS5496-42TPRY	--	--	--	--	\$16,761

Electrical Options and Upcharges

CT2	84 - 96 wide
Dual Power Center Top - Black	CT2BL - add \$1,837
Dual Power Center Top - White	CT2WH - add \$1,837
CU1	
Dual Power Underside - Black	CU1-1C - add \$731
Dual Power Underside with Wireless Charging - Black	CU1-1CW - add \$1,691
CT2U1	
Dual Power Center Top - Black with Underside	CT2U1-BL - add \$2,235
Dual Power Center Top - White with Underside	CT2U1-WH - add \$2,235
Dual Power Center Top - Black with Wireless Charging	CT2U1-BLW2 - add \$3,194
Dual Power Center Top - White with Wireless Charging	CT2U1-WHW2 - add \$3,194

Note: Order power infeed that best fits application

To Order Specify

1 Veneer Model #	2 Edge Detail	3 Wood Collection	4 Wood Finish	5 Electrical	6 Metal Color
Veneer (LKV)	<a href="#">See Edge Detail Options</a>	Essentials	<a href="#">See Essentials Wood Finish Options</a>	N None CT2 Dual Power Center Top CU2 Dual Power Underside CT2U1 Dual Power Center Top with Underside (See chart above)	<a href="#">See Metal Finish Color Options</a>
		Artisan	<b>4 Wood Finish</b> <a href="#">See Artisan Wood Finish Options</a>		

1 Solid Surface Model #	2 Top Surface Selection	3 Electrical	4 Metal Color
Solid Surface (LKS)	<a href="#">See Solid Surface Top Surface Selection Options</a>	N None CT2 Dual Power Center Top CU2 Dual Power Underside CT2U1 Dual Power Center Top with Underside (See chart above)	<a href="#">See Metal Finish Color Options</a>

LOK - CONFERENCE

Description

Round Table with X Base at Bar Height



Laminate Tables  
"LKT" Models

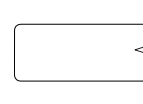

Eased Edge (R3)

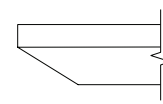

Reverse Bevel Edge (K9)

LAMINATE	D	W	H	CTN WT	CU FT	1 Model	Eased Edge (R3)		Reverse Bevel Edge (K9)	
							Standard	Graded In	Standard	Graded In
							Tier 1	Tier 2	Tier 1	Tier 2
	48	48	42	90	69	LKT48-42RDX	\$2,092	\$2,238	\$2,652	\$2,800
	42	42	42	75	54	LKT42-42RDX	\$1,926	\$2,070	\$2,488	\$2,632
	36	36	42	60	41	LKT36-42RDX	\$1,867	\$1,921	\$2,429	\$2,482
	30	30	42	50	30	LKT30-42RDX	\$1,804	\$1,845	\$2,365	\$2,407

Features:

- price reflects complete table - top and base
- ships KD in multiple cartons
- one piece top
- model includes adjustable glide
- when electrical option is selected, power accessible base is shipped; see page 178 for details
- power/charging units have 72" cord
- power cord is routed inside base column

Options:

- specify power access base with power unit option; None (N), add \$735 for EC23 (CTEC23), add \$616 for EC24 (CTEC24)

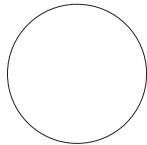

top shape

LOK - CONFERENCE

To Order Specify

1 Laminite Model #	2 Edge Detail	3 Laminite Selection	3a PVC Edge Color	4 Electrical	5 Metal Color
Laminite (LKT)	<a href="#">See Edge Detail Options</a>	<a href="#">See Laminite Selection</a>	<a href="#">See PVC Edge Color Options</a>	N None CTEC23 Power Center Top CTEC24 Power Center Top (See chart on next page)	<a href="#">See Metal Finish Color Options</a>

Model Number Breakdown

LKT48-42RDX					
LK	T	48	42	RD	X
LOK	Laminite	48" dia.	Height	Round Top Shape	X Base

Description

Round Table with X Base at Bar Height  
(continued)

Veneer Tables  
"LKV" Models

Solid Surface Tables  
"LKS" Models

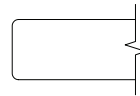

Eased Edge (R3)

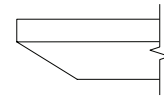

Reverse Bevel Edge (K9)

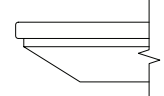

Reverse Bevel Edge (K7)

	D	W	H	CTN WT	CU FT	① Model	Veneer Tables		Solid Surface Tables		
							Essentials	Artisan	Essentials	Artisan	Standard
VENEER	48	48	42	90	69	LKV48-42RDX	\$2,750	\$2,931	\$2,854	\$3,045	--
	42	42	42	75	54	LKV42-42RDX	\$2,525	\$2,690	\$2,620	\$2,795	--
	36	36	42	60	41	LKV36-42RDX	\$2,448	\$2,609	\$2,544	\$2,711	--
	30	30	42	50	30	LKV30-42RDX	\$2,363	\$2,519	\$2,452	\$2,613	--
SOLID SURFACE	48	48	42	90	69	LKS48-42RDX	--	--	--	--	\$6,376
	42	42	42	75	54	LKS42-42RDX	--	--	--	--	\$5,437
	36	36	42	60	41	LKS36-42RDX	--	--	--	--	\$4,745
	30	30	42	50	30	LKS30-42RDX	--	--	--	--	\$4,134

Electrical Options and Upcharges

CTEC23	
EC23 Power Center Top - Black	CTEC23BL - add \$735
EC23 Power Center Top - White	CTEC23WH - add \$735
CTEC24	
EC24 Power Center Top - Black	CTEC43BL - add \$616
EC24 Power Center Top - White	CTEC43WH - add \$616

To Order Specify

① Veneer Model #	② Edge Detail	③ Wood Collection	④ Wood Finish	⑤ Electrical	⑥ Metal Color
Veneer (LKV)	<a href="#">See Edge Detail Options</a>	Essentials	<a href="#">See Essentials Wood Finish Options</a>	N None CTEC23 Power Center Top CTEC24 Power Center Top (See chart above)	<a href="#">See Metal Finish Color Options</a>
		Artisan	④ Wood Finish <a href="#">See Artisan Wood Finish Options</a>		

① Solid Surface Model #	② Top Surface Selection	③ Electrical Cut Out	④ Metal Color
Solid Surface (LKS)	<a href="#">See Solid Surface Top Surface Selection Options</a>	N None CTEC23 Power Center Top CTEC24 Power Center Top (See chart above)	<a href="#">See Metal Finish Color Options</a>

LOK - CONFERENCE

Description

Round Table with X4 Base at Bar Height



Laminate Tables  
"LKT" Models

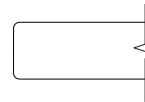

Eased Edge (R3)

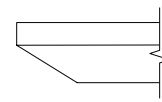

Reverse Bevel Edge (K9)

LAMINATE	D	W	H	CTN WT	CU FT	① Model	Eased Edge (R3)		Reverse Bevel Edge (K9)	
							Standard	Graded In	Standard	Graded In
							Tier 1	Tier 2	Tier 1	Tier 2
	60	60	42	207	94	LKT60-42RDZ	\$3,468	\$3,584	\$4,029	\$4,142
	54	54	42	180	86	LKT54-42RDZ	\$3,248	\$3,339	\$3,808	\$3,898

Features:

- price reflects complete table - top and base
- ships KD in multiple cartons
- one piece top
- model includes adjustable glide
- power cord is routed outside base column
- order vertical wire manager separately; see page 407

Options:

- specify power unit option; None (N), add \$594 for EC23 (CTEC23), add \$474 for EC24 (CTEC24)

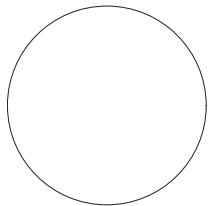

top shape

LOK - CONFERENCE

To Order Specify

① Laminate Model #	② Edge Detail	③ Laminate Selection	④ PVC Edge Color	⑤ Electrical	⑥ Metal Color
Laminate (LKT)	<a href="#">See Edge Detail Options</a>	<a href="#">See Laminate Selection</a>	<a href="#">See PVC Edge Color Options</a>	N None CTEC23 Power Center Top CTEC24 Power Center Top (See chart on next page)	<a href="#">See Metal Finish Color Options</a>

Model Number Breakdown

LKT60-42RDZ					
LK	T	60	42	RD	Z
LOK	Laminate	60" dia.	Height	Round Top Shape	X4 Base

Description

Round Table with X4 Base at Bar Height  
(continued)

Veneer Tables  
"LKV" Models

Solid Surface Tables  
"LKS" Models

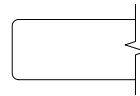

Eased Edge (R3)

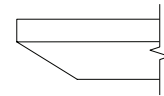

Reverse Bevel Edge (K9)

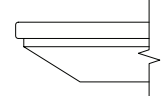

Reverse Bevel Edge (K7)

	D	W	H	CTN WT	CU FT	① Model	Veneer Tables "LKV" Models		Solid Surface Tables "LKS" Models		
							Essentials	Artisan	Essentials	Artisan	Standard
VENEER	60	60	42	207	94	LKV60-42RDZ	\$4,538	\$4,837	\$4,710	\$5,017	--
	54	54	42	180	86	LKV54-42RDZ	\$4,297	\$4,586	\$4,461	\$4,764	--
SOL. SURF.	60	60	42	207	94	LKS60-42RDZ	--	--	--	--	\$9,870
	54	54	42	180	86	LKS54-42RDZ	--	--	--	--	\$8,726

Electrical Options and Upcharges

CTEC23	
EC23 Power Center Top - Black	CTEC23BL - add \$594
EC23 Power Center Top - White	CTEC23WH - add \$594
CTEC24	
EC24 Power Center Top - Black	CTEC43BL - add \$474
EC24 Power Center Top - White	CTEC43WH - add \$474

To Order Specify

① Veneer Model #	② Edge Detail	③ Wood Collection	④ Wood Finish	⑤ Electrical	⑥ Metal Color
Veneer (LKV)	<a href="#">See Edge Detail Options</a>	Essentials	<a href="#">See Essentials Wood Finish Options</a>	N None CTEC23 Power Center Top CTEC24 Power Center Top (See chart above)	<a href="#">See Metal Finish Color Options</a>
		Artisan	<a href="#">See Artisan Wood Finish Options</a>		

① Solid Surface Model #	② Top Surface Selection	③ Electrical Cut Out	④ Metal Color
Solid Surface (LKS)	<a href="#">See Solid Surface Top Surface Selection Options</a>	N None CTEC23 Power Center Top CTEC24 Power Center Top (See chart above)	<a href="#">See Metal Finish Color Options</a>

LOK - CONFERENCE

Description

Square Table with X Base  
at Bar Height

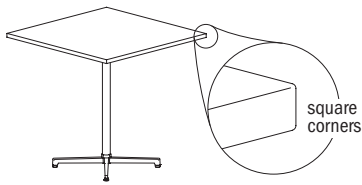

Laminate Tables  
"LKT" Models

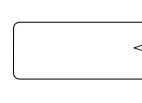

Eased Edge (R3)

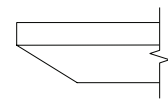

Reverse Bevel Edge (K9)

LAMINATE	D	W	H	CTN WT	CU FT	Model	Standard Tier 1	Graded In Tier 2	Standard Tier 1	Graded In Tier 2
		42	42	42	87	54	LKT4242-42SQX	\$1,970	\$2,036	\$2,533
	36	36	42	70	41	LKT3636-42SQX	\$1,755	\$1,806	\$2,317	\$2,367
	30	30	42	55	30	LKT3030-42SQX	\$1,581	\$1,623	\$2,143	\$2,185

Features:

- price reflects complete table - top and base
- ships KD in multiple cartons
- one piece top
- model includes adjustable glide
- when electrical option is selected, power accessible base is shipped; see page 178 for details
- power/charging units have 72" cord
- power cord is routed inside base column

Options:

- specify power access base with power unit option; None (N), add \$735 for EC23 (CTEC23), add \$616 for EC24 (CTEC24)



top shape

LOK - CONFERENCE

To Order Specify

1 Laminite Model #	2 Edge Detail	3 Laminite Selection	3a PVC Edge Color	4 Electrical	5 Metal Color
Laminite (LKT)	<a href="#">See Edge Detail Options</a>	<a href="#">See Laminite Selection</a>	<a href="#">See PVC Edge Color Options</a>	N None CTEC23 Power Center Top CTEC24 Power Center Top (See chart on next page)	<a href="#">See Metal Finish Color Options</a>

Model Number Breakdown

LKT4242-42SQX					
LK	T	4242	42	SQ	X
LOK	Laminite	42" x 42"	Height	Square Top Shape	X Base

Description

Square Table with X Base at Bar Height  
(continued)

Veneer Tables  
"LKV" Models

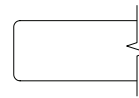

Eased Edge (R3)

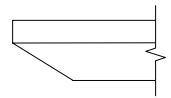

Reverse Bevel Edge (K9)

D	W	H	CTN WT	CU FT	① Model	Essentials		Artisan	
						Essentials	Artisan	Essentials	Artisan
42	42	42	87	54	LKV4242-42SQX	\$2,552	\$2,718	\$2,648	\$2,821
36	36	42	70	41	LKV3636-42SQX	\$2,267	\$2,414	\$2,351	\$2,504
30	30	42	55	30	LKV3030-42SQX	\$2,039	\$2,171	\$2,111	\$2,252

VENEER

LOK- CONFERENCE

Electrical Options and Upcharges

CTEC23	
EC23 Power Center Top - Black	CTEC23BL - add \$735
EC23 Power Center Top - White	CTEC23WH - add \$735
CTEC24	
EC24 Power Center Top - Black	CTEC43BL - add \$616
EC24 Power Center Top - White	CTEC43WH - add \$616

To Order Specify

① Veneer Model #	② Edge Detail	③ Wood Collection	④ Wood Finish	⑤ Electrical	⑥ Metal Color
Veneer (LKV)	<a href="#">See Edge Detail Options</a>	Essentials	<a href="#">See Essentials Wood Finish Options</a>	N None CTEC23 Power Center Top CTEC24 Power Center Top (See chart above)	<a href="#">See Metal Finish Color Options</a>
		Artisan	④ Wood Finish <a href="#">See Artisan Wood Finish Options</a>		

Description

Rounded Square Table with X Base at Bar Height

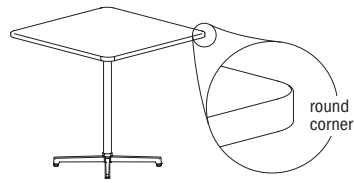

Laminate Tables  
"LKT" Models

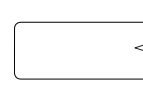

Eased Edge (R3)

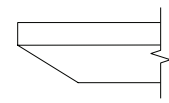

Reverse Bevel Edge (K9)

LAMINATE	D	W	H	CTN WT	CU FT	❶ Model	Standard Tier 1	Graded In Tier 2	Standard Tier 1	Graded In Tier 2
	42	42	42	87	54	LKT4242-42SQRX	\$2,410	\$2,474	\$2,972	\$3,035
	36	36	42	70	41	LKT3636-42SQRX	\$2,016	\$2,069	\$2,576	\$2,631
	30	30	42	55	30	LKT3030-42SQRX	\$1,806	\$1,854	\$2,368	\$2,414

Features:

- price reflects complete table - top and base
- ships KD in multiple cartons
- one piece top
- model includes adjustable glide
- when electrical option is selected, power accessible base is shipped; see page 178 for details
- power/charging units have 72" cord
- power cord is routed inside base column

Options:

- specify power access base with power unit option; None (N), add \$735 for EC23 (CTEC23), add \$616 for EC24 (CTEC24)

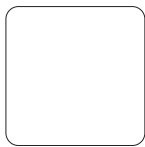

top shape

LOK - CONFERENCE

To Order Specify

❶ Laminante Model #	❷ Edge Detail	❸ Laminante Selection	❹ PVC Edge Color	❺ Electrical	❻ Metal Color
Laminante (LKT)	<a href="#">See Edge Detail Options</a>	<a href="#">See Laminante Selection</a>	<a href="#">See PVC Edge Color Options</a>	N None CTEC23 Power Center Top CTEC24 Power Center Top (See chart on next page)	<a href="#">See Metal Finish Color Options</a>

Model Number Breakdown

LKT4242-42SQRX						
LK	T	4242	42	SQ	R	X
LOK	Laminante	42" x 42"	Height	Square Top Shape	Rounded Corner	X Base

Description

Rounded Square Table with X Base at Bar Height (continued)

Veneer Tables "LKV" Models      Solid Surface Tables "LKS" Models

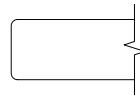

Eased Edge (R3)

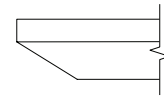

Reverse Bevel Edge (K9)

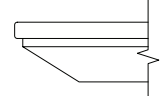

Reverse Bevel Edge (K7)

	D	W	H	CTN WT	CU FT	① Model	Veneer Tables "LKV" Models		Solid Surface Tables "LKS" Models		
							Essentials	Artisan	Essentials	Artisan	Standard
VENEER	42	42	42	87	54	LKV4242-42SQRX	\$3,143	\$3,349	\$3,263	\$3,479	--
	36	36	42	70	41	LKV3636-42SQRX	\$2,609	\$2,781	\$2,710	\$2,889	--
	30	30	42	55	30	LKV3030-42SQRX	\$2,337	\$2,491	\$2,426	\$2,585	--
SOLID SURFACE	42	42	42	87	54	LKS4242-42SQRX	--	--	--	--	\$6,052
	36	36	42	70	41	LKS3636-42SQRX	--	--	--	--	\$4,904
	30	30	42	55	30	LKS3030-42SQRX	--	--	--	--	\$4,107

Electrical Options and Upcharges

CTEC23	
EC23 Power Center Top - Black	CTEC23BL - add \$735
EC23 Power Center Top - White	CTEC23WH - add \$735
CTEC24	
EC24 Power Center Top - Black	CTEC43BL - add \$616
EC24 Power Center Top - White	CTEC43WH - add \$616

To Order Specify

① Veneer Model #	② Edge Detail	③ Wood Collection	④ Wood Finish	⑤ Electrical	⑥ Metal Color
Veneer (LKV)	<a href="#">See Edge Detail Options</a>	Essentials	<a href="#">See Essentials Wood Finish Options</a>	N None CTEC23 Power Center Top CTEC24 Power Center Top (See chart above)	<a href="#">See Metal Finish Color Options</a>
		Artisan	④ Wood Finish <a href="#">See Artisan Wood Finish Options</a>		

① Solid Surface Model #	② Top Surface Selection	③ Electrical Cut Out	④ Metal Color
Solid Surface (LKS)	<a href="#">See Solid Surface Top Surface Selection Options</a>	N None CTEC23 Power Center Top CTEC24 Power Center Top (See chart above)	<a href="#">See Metal Finish Color Options</a>

LOK- CONFERENCE

Description

Square Table with X4 Base at Bar Height

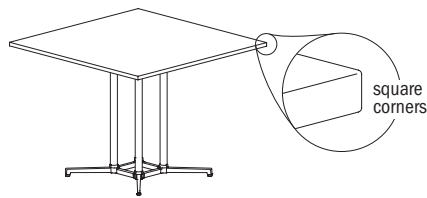

Laminate Tables  
"LKT" Models

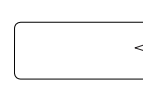

Eased Edge (R3)

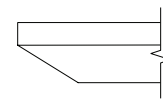

Reverse Bevel Edge (K9)

LAMINATE	D	W	H	CTN WT	CU FT	① Model	Eased Edge (R3)		Reverse Bevel Edge (K9)	
							Standard Tier 1	Graded In Tier 2	Standard Tier 1	Graded In Tier 2
	60	60	42	207	94	LKT6060-42SQZ	\$3,935	\$4,051	\$4,497	\$4,612
	54	54	42	180	86	LKT5454-42SQZ	\$3,749	\$3,850	\$4,311	\$4,411
	48	48	42	124	69	LKT4848-42SQZ	\$3,128	\$3,195	\$3,689	\$3,758

Features:

- price reflects complete table - top and base
- ships KD in multiple cartons
- one piece top
- model includes adjustable glide
- power cord is routed outside base column
- order vertical wire manager separately; see page 407

Options:

- specify power unit option; None (N), add \$594 for EC23 (CTEC23), add \$474 for EC24 (CTEC24)



top shape

LOK - CONFERENCE

To Order Specify

① Laminate Model #	② Edge Detail	③ Laminate Selection	④ PVC Edge Color	⑤ Electrical	⑥ Metal Color
Laminate (LKT)	<a href="#">See Edge Detail Options</a>	<a href="#">See Laminate Selection</a>	<a href="#">See PVC Edge Color Options</a>	N None CTEC23 Power Center Top CTEC24 Power Center Top (See chart on next page)	<a href="#">See Metal Finish Color Options</a>

Model Number Breakdown

LKT6060-42SQZ					
LK	T	6060	42	SQ	Z
LOK	Laminate	60" x 60"	Height	Square Top Shape	X4 Base

Description

Square Table with X4 Base  
at Bar Height  
(continued)

Veneer Tables  
"LKV" Models

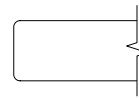

Eased Edge (R3)

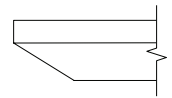

Reverse Bevel Edge (K9)

D	W	H	GTN WT	CU FT	① Model	Essentials		Artisan	
						Essentials	Artisan	Essentials	Artisan
60	60	42	207	94	LKV6060-42SQZ	\$5,093	\$5,428	\$5,286	\$5,635
54	54	42	180	86	LKV5454-42SQZ	\$4,849	\$5,165	\$5,029	\$5,362
48	48	42	124	69	LKV4848-42SQZ	\$3,762	\$3,945	\$3,867	\$4,058

VENEER

LOK - CONFERENCE

Electrical Options and Upcharges

CTEC23	
EC23 Power Center Top - Black	CTEC23BL - add \$594
EC23 Power Center Top - White	CTEC23WH - add \$594
CTEC24	
EC24 Power Center Top - Black	CTEC43BL - add \$474
EC24 Power Center Top - White	CTEC43WH - add \$474

To Order Specify

① Veneer Model #	② Edge Detail	③ Wood Collection	④ Wood Finish	⑤ Electrical	⑥ Metal Color
Veneer (LKV)	<a href="#">See Edge Detail Options</a>	Essentials	<a href="#">See Essentials Wood Finish Options</a>	N None CTEC23 Power Center Top CTEC24 Power Center Top (See chart above)	<a href="#">See Metal Finish Color Options</a>
		Artisan	④ Wood Finish <a href="#">See Artisan Wood Finish Options</a>		

Description

Rounded Square Table with X4 Base at Bar Height

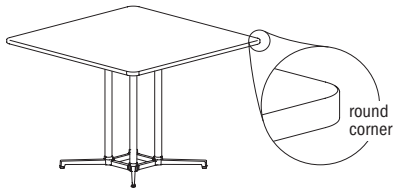

Laminate Tables "LKT" Models

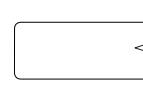

Eased Edge (R3)

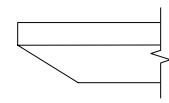

Reverse Bevel Edge (K9)

LAMINATE	D	W	H	CTN WT	CU FT	1 Model	Eased Edge (R3)		Reverse Bevel Edge (K9)	
							Standard Tier 1	Graded In Tier 2	Standard Tier 1	Graded In Tier 2
	60	60	42	207	94	LKT6060-42SQRZ	\$4,222	\$4,326	\$4,787	\$4,886
54	54	42	180	86	LKT5454-42SQRZ	\$3,508	\$3,607	\$4,066	\$4,169	
48	48	42	124	69	LKT4848-42SQRZ	\$3,584	\$3,653	\$4,142	\$4,214	

Features:

- price reflects complete table - top and base
- ships KD in multiple cartons
- one piece top
- model includes adjustable glide
- power cord is routed outside base column
- order vertical wire manager separately; see page 407

Options:

- specify power unit option; None (N), add \$594 for EC23 (CTEC23), add \$474 for EC24 (CTEC24)

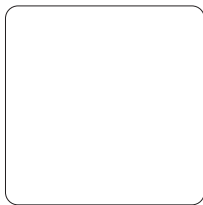

top shape

LOK - CONFERENCE

To Order Specify

1 Laminate Model #	2 Edge Detail	3 Laminate Selection	3a PVC Edge Color	4 Electrical	5 Metal Color
Laminate (LKT)	<a href="#">See Edge Detail Options</a>	<a href="#">See Laminate Selection</a>	<a href="#">See PVC Edge Color Options</a>	N None CTEC23 Power Center Top CTEC24 Power Center Top (See chart on next page)	<a href="#">See Metal Finish Color Options</a>

Model Number Breakdown

LKT6060-42SQRZ						
LK	T	6060	42	SQ	R	Z
LOK	Laminate	60" x 60"	Height	Square Top Shape	Rounded Corner	X4 Base

Description

Rounded Square Table with X4 Base at Bar Height (continued)

Veneer Tables "LKV" Models      Solid Surface Tables "LKS" Models

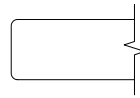

Eased Edge (R3)

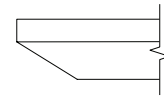

Reverse Bevel Edge (K9)

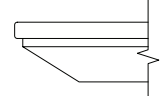

Reverse Bevel Edge (K7)

	D	W	H	CTN WT	CU FT	① Model	Veneer Tables "LKV" Models		Solid Surface Tables "LKS" Models		
							Essentials	Artisan	Essentials	Artisan	Standard
VENEER	60	60	42	207	94	LKV6060-42SQRZ	\$5,476	\$5,838	\$5,684	\$6,058	--
	54	54	42	180	86	LKV5454-42SQRZ	\$4,527	\$4,824	\$4,695	\$5,005	--
	48	48	42	124	69	LKV4848-42SQRZ	\$4,362	\$4,587	\$4,490	\$4,725	--
SOLID SURFACE	60	60	42	207	94	LKS6060-42SQRZ	--	--	--	--	\$10,805
	54	54	42	180	86	LKS5454-42SQRZ	--	--	--	--	\$8,958
	48	48	42	124	69	LKS4848-42SQRZ	--	--	--	--	\$6,994

Electrical Options and Upcharges

CTEC23	
EC23 Power Center Top - Black	CTEC23BL - add \$594
EC23 Power Center Top - White	CTEC23WH - add \$594
CTEC24	
EC24 Power Center Top - Black	CTEC43BL - add \$474
EC24 Power Center Top - White	CTEC43WH - add \$474

To Order Specify

① Veneer Model #	② Edge Detail	③ Wood Collection	④ Wood Finish	⑤ Electrical	⑥ Metal Color
Veneer (LKV)	<a href="#">See Edge Detail Options</a>	Essentials	<a href="#">See Essentials Wood Finish Options</a>	N None CTEC23 Power Center Top CTEC24 Power Center Top (See chart above)	<a href="#">See Metal Finish Color Options</a>
		Artisan	④ Wood Finish <a href="#">See Artisan Wood Finish Options</a>		

① Solid Surface Model #	② Top Surface Selection	③ Electrical Cut Out	④ Metal Color
Solid Surface (LKS)	<a href="#">See Solid Surface Top Surface Selection Options</a>	N None CTEC23 Power Center Top CTEC24 Power Center Top (See chart above)	<a href="#">See Metal Finish Color Options</a>

LOK - CONFERENCE

Description

Squircle Table with X Base at Bar Height



Laminate Tables  
"LKT" Models

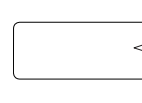

Eased Edge (R3)

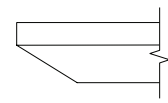

Reverse Bevel Edge (K9)

LAMINATE	D	W	H	CTN WT	CU FT	1 Model	Standard Tier 1	Graded In Tier 2	Standard Tier 1	Graded In Tier 2
	42	42	42	104	54	LKT42-42SCX	\$1,951	\$2,096	\$2,514	\$2,657
	36	36	42	82	41	LKT36-42SCX	\$1,892	\$1,943	\$2,451	\$2,504
30	30	42	64	30	LKT30-42SCX	\$1,829	\$1,870	\$2,391	\$2,436	

Features:

- price reflects complete table - top and base
- ships KD in multiple cartons
- one piece top
- model includes adjustable glide
- when electrical option is selected, power accessible base is shipped; see page 178 for details
- power/charging units have 72" cord
- power cord is routed inside base column

Options:

- specify power access base with power unit option; None (N), add \$735 for EC23 (CTEC23), add \$616 for EC24 (CTEC24)

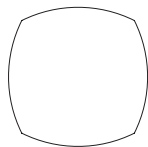

top shape

LOK - CONFERENCE

To Order Specify

1 Laminates Model #	2 Edge Detail	3 Laminates Selection	3a PVC Edge Color	4 Electrical	5 Metal Color
Laminates (LKT)	<a href="#">See Edge Detail Options</a>	<a href="#">See Laminates Selection</a>	<a href="#">See PVC Edge Color Options</a>	N None CTEC23 Power Center Top CTEC24 Power Center Top (See chart on next page)	<a href="#">See Metal Finish Color Options</a>

Model Number Breakdown

LKT42-42SCX					
LK	T	42	42	SC	X
LOK	Laminates	42" dia.	Height	Squircle Top Shape	X Base

Description

Squirrel Table with X Base at Bar Height (continued)

Veneer Tables "LKV" Models      Solid Surface Tables "LKS" Models

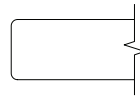

Eased Edge (R3)

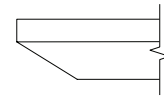

Reverse Bevel Edge (K9)

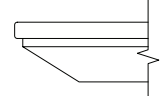

Reverse Bevel Edge (K7)

	D	W	H	CTN WT	CU FT	① Model	Veneer Tables		Solid Surface Tables		
							Essentials	Artisan	Essentials	Artisan	Standard
VENEER	42	42	42	104	54	LKV42-42SCX	\$2,552	\$2,717	\$2,648	\$2,820	--
	36	36	42	82	41	LKV36-42SCX	\$2,473	\$2,636	\$2,568	\$2,735	--
	30	30	42	64	30	LKV30-42SCX	\$2,388	\$2,544	\$2,479	\$2,640	--
SOLID SURFACE	42	42	42	104	54	LKS42-42SCX	--	--	--	--	\$5,485
	36	36	42	82	41	LKS36-42SCX	--	--	--	--	\$4,794
	30	30	42	64	30	LKS30-42SCX	--	--	--	--	\$4,622

Electrical Options and Upcharges

CTEC23	
EC23 Power Center Top - Black	CTEC23BL - add \$735
EC23 Power Center Top - White	CTEC23WH - add \$735
CTEC24	
EC24 Power Center Top - Black	CTEC43BL - add \$616
EC24 Power Center Top - White	CTEC43WH - add \$616

To Order Specify

① Veneer Model #	② Edge Detail	③ Wood Collection	④ Wood Finish	⑤ Electrical	⑥ Metal Color
Veneer (LKV)	<a href="#">See Edge Detail Options</a>	Essentials	<a href="#">See Essentials Wood Finish Options</a>	N None CTEC23 Power Center Top CTEC24 Power Center Top (See chart above)	<a href="#">See Metal Finish Color Options</a>
		Artisan	④ Wood Finish <a href="#">See Artisan Wood Finish Options</a>		

① Solid Surface Model #	② Top Surface Selection	③ Electrical Cut Out	④ Metal Color
Solid Surface (LKS)	<a href="#">See Solid Surface Top Surface Selection Options</a>	N None CTEC23 Power Center Top CTEC24 Power Center Top (See chart above)	<a href="#">See Metal Finish Color Options</a>

Description

Squire Table with X4 Base at Bar Height



Laminate Tables "LKT" Models

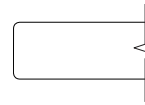

Eased Edge (R3)

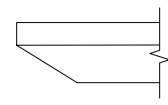

Reverse Bevel Edge (K9)

LAMINATE	D	W	H	CTN WT	CU FT	Model	Eased Edge (R3)		Reverse Bevel Edge (K9)	
							Standard Tier 1	Graded In Tier 2	Standard Tier 1	Graded In Tier 2
	60	60	42	207	94	LKT60-42SCZ	\$3,495	\$3,608	\$4,057	\$4,172
	54	54	42	180	86	LKT54-42SCZ	\$3,272	\$3,363	\$3,836	\$3,925
	48	48	42	129	69	LKT48-42SCZ	\$3,110	\$3,257	\$3,675	\$3,818

Features:

- price reflects complete table - top and base
- ships KD in multiple cartons
- one piece top
- model includes adjustable glide
- power cord is routed outside base column
- order vertical wire manager separately; see page 407

Options:

- specify power unit option; None (N), add \$594 for EC23 (CTEC23), add \$474 for EC24 (CTEC24)

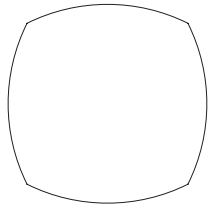

top shape

LOK - CONFERENCE

To Order Specify

1 Laminates Model #	2 Edge Detail	3 Laminates Selection	3a PVC Edge Color	4 Electrical	5 Metal Color
Laminates (LKT)	<a href="#">See Edge Detail Options</a>	<a href="#">See Laminates Selection</a>	<a href="#">See PVC Edge Color Options</a>	N None CTEC23 Power Center Top CTEC24 Power Center Top (See chart on next page)	<a href="#">See Metal Finish Color Options</a>

Model Number Breakdown

LKT60-42SCZ					
LK	T	60	42	SC	Z
LOK	Laminates	60" dia.	Height	Squire Top Shape	X4 Base

Description

Squirrel Table with X4  
Base at Bar Height  
(continued)

Veneer Tables "LKV" Models      Solid Surface Tables "LKS" Models

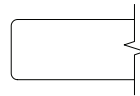

Eased Edge (R3)

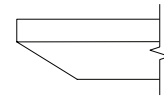

Reverse Bevel Edge (K9)

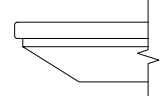

Reverse Bevel Edge (K7)

	D	W	H	CTN WT	CU FT	① Model	Veneer Tables "LKV" Models		Solid Surface Tables "LKS" Models		
							Essentials	Artisan	Essentials	Artisan	Standard
VENEER	60	60	42	207	94	LKV60-42SCZ	\$4,566	\$4,860	\$4,737	\$5,046	--
	54	54	42	180	86	LKV54-42SCZ	\$4,322	\$4,613	\$4,489	\$4,793	--
	48	48	42	129	69	LKV48-42SCZ	\$3,768	\$3,951	\$3,875	\$4,061	--
SOLID SURFACE	60	60	42	207	94	LKS60-42SCZ	--	--	--	--	\$9,917
	54	54	42	180	86	LKS54-42SCZ	--	--	--	--	\$8,775
	48	48	42	129	69	LKS48-42SCZ	--	--	--	--	\$7,413

Electrical Options and Upcharges

CTEC23	
EC23 Power Center Top - Black	CTEC23BL - add \$594
EC23 Power Center Top - White	CTEC23WH - add \$594
CTEC24	
EC24 Power Center Top - Black	CTEC43BL - add \$474
EC24 Power Center Top - White	CTEC43WH - add \$474

To Order Specify

① Veneer Model #	② Edge Detail	③ Wood Collection	④ Wood Finish	⑤ Electrical	⑥ Metal Color
Veneer (LKV)	<a href="#">See Edge Detail Options</a>	Essentials	<a href="#">See Essentials Wood Finish Options</a>	N None CTEC23 Power Center Top CTEC24 Power Center Top (See chart above)	<a href="#">See Metal Finish Color Options</a>
		Artisan	④ Wood Finish <a href="#">See Artisan Wood Finish Options</a>		

① Solid Surface Model #	② Top Surface Selection	③ Electrical Cut Out	④ Metal Color
Solid Surface (LKS)	<a href="#">See Solid Surface Top Surface Selection Options</a>	N None CTEC23 Power Center Top CTEC24 Power Center Top (See chart above)	<a href="#">See Metal Finish Color Options</a>

LOK - CONFERENCE

Description

Hive Table with T Base at Bar Height

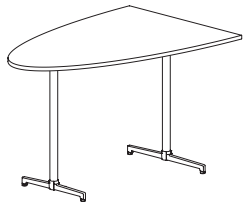

Laminate Tables "LKT" Models

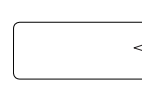

Eased Edge (R3)

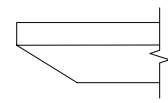

Reverse Bevel Edge (K9)

LAMI	D	W	H	CTN WT	CU FT	Model	Standard Tier 1	Graded In Tier 2	Standard Tier 1	Graded In Tier 2
		48	72	42	138	101	LKT4872-42HVT	\$2,746	\$2,800	\$3,355

Features:

- price reflects complete table - top and base
- ships KD in multiple cartons
- model includes adjustable glide

Options:

- specify power/charging option, see below for options and upcharges

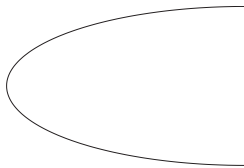

top shape

LOK - CONFERENCE

To Order Specify

1 Laminate Model #	2 Edge Detail	3 Laminate Selection	3a PVC Edge Color	4 Electrical
Laminate (LKT)	<a href="#">See Edge Detail Options</a>	<a href="#">See Laminate Selection</a>	<a href="#">See PVC Edge Color Options</a>	N None CT2 Dual Power Center Top (See chart on next page) CU1 Single Power Underside <b>5 Metal Finish</b> <a href="#">See Metal Finish Color Options</a>

Model Number Breakdown

LKT4872-42HVT					
LK	T	4872	42	HV	T
LOK	Laminate	48" x 72"	Height	Hive Top Shape	T base

Description

Hive Table with T Base  
at Bar Height  
(continued)

Veneer Tables  
"LKV" Models

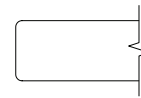

Eased Edge (R3)

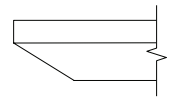

Reverse Bevel Edge (K9)

VEN.	D	W	H	CTN WT	CU FT	① Model	Essentials		Artisan	
	48	72	42	138	101	LKV4872-42HVT	\$3,455		\$3,729	
									\$3,763	\$4,007

Electrical Options and Upcharges

CT2	
Dual Power Center Top - Black	CT2BL - add \$1,773
Dual Power Center Top - White	CT2WH - add \$1,773
CU1	
Single Power Underside - Black	CU11C - add \$690
Single Power Underside with Wireless Charging - Black	CU11CW - add \$1,651

**Note: Order power infeed that best fits application.**

To Order, Specify:

① Veneer Model #	② Edge Detail	③ Wood Collection	④ Top Wood Finish	⑤ Electrical	⑥ Metal Color
Veneer (LKV)	<a href="#">See Edge Detail Options</a>	Essentials	<a href="#">See Essentials Wood Finish Options</a>	N None CT2 Dual Power Center Top CU1 Single Power Underside (See chart above)	<a href="#">See Metal Finish Color Options</a>
		Artisan	④ Top Wood Finish <a href="#">See Artisan Wood Finish Options</a>		

Description	D	W	H	CTN WT	CU FT	① Model	Laminate	Essentials Veneer	Artisan Veneer
Closed Storage Credenza	20	72	29	343	32	LKT2072-29L777	\$4,035		
	20	72	29	343	32	LKV2072-29L777		\$5,158	\$5,672
	20	60	29	237	28	LKT2060-29L777	\$3,824		
	20	60	29	237	28	LKV2060-29L777		\$4,870	\$5,353



**Features:**

- model comes with finished top, profiled top available to order separately, see page 444-445
- each compartment has one adjustable shelf
- back access grommet standard at top of each compartment
- door pulls match metal finish selected for column

**Options:**

- locking doors available, specify and add \$474

Closed/Open Storage Credenza	20	72	29	339	32	LKT2072-29L707	\$3,867		
	20	72	29	339	32	LKV2072-29L707		\$4,945	\$5,439
	20	60	29	230	28	LKT2060-29L707	\$3,666		
	20	60	29	230	28	LKV2060-29L707		\$4,664	\$5,131

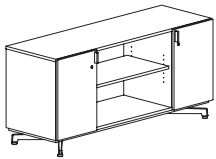

**Features:**

- model comes with finished top, profiled top available to order separately, see page 444-445
- each compartment has one adjustable shelf
- back access grommet standard at top of each compartment
- door pulls match metal finish selected for column

**Options:**

- locking doors available, specify and add \$316

LOK - CONFERENCE

**To Order Specify**

Laminate Model #	② Laminate Selection	③ PVC Edge Color
Laminate (LKT)	<a href="#">See Laminate Selection</a>	<a href="#">See PVC Edge Color Options</a>

**Model Number Breakdown**

LKT2060-29L777				
LK	T	2060	29	L777
LOK	Laminate	20"x60"	Height	Door Configuration

Description	D	W	H	CTN WT	CU FT	① Model	Laminate	Essentials Veneer	Artisan Veneer
Closed Storage Credenza at Counter Height	20	72	36	362	38	LKT2072-36L777	\$4,402		
	20	72	36	362	38	LKV2072-36L777		\$5,621	\$6,183
	20	60	36	303	34	LKT2060-36L777	\$4,170		
	20	60	36	303	34	LKV2060-36L777		\$5,305	\$5,837



**Features:**

- model comes with finished top, profiled top available to order separately, see page 444-445
- each compartment has one adjustable shelf
- back access grommet standard at top of each compartment
- door pulls match metal finish selected for column

**Options:**

- locking doors available, specify and add \$474

Closed/Open Storage Credenza at Counter Height	20	72	36	355	38	LKT2072-36L707	\$4,221		
	20	72	36	355	38	LKV2072-36L707		\$5,392	\$5,931
	20	60	36	296	34	LKT2060-36L707	\$3,998		
	20	60	36	296	34	LKV2060-36L707		\$5,086	\$5,592

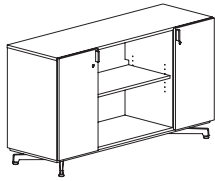

**Features:**

- model comes with finished top, profiled top available to order separately, see page 444-445
- each compartment has one adjustable shelf
- back access grommet standard at top of each compartment
- door pulls match metal finish selected for column

**Options:**

- locking doors available, specify and add \$316

**To Order Specify**

① Veneer Model #	② Wood Collection	③ Wood Finish
Veneer (LKV)	Essentials	<a href="#">See Essentials Wood Finish Options</a>
	Artisan	③ Wood Finish <a href="#">See Artisan Wood Finish Options</a>

Description

Credenza Cabinet Top



Laminate Tables  
"LKT" Models

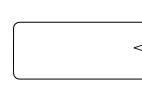

Eased Edge (R3)

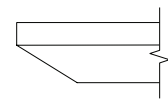

Reverse Bevel Edge (K9)

LAMINATE	D	W	H	CTN WT	CU FT	Model	Standard Tier 1	Graded In Tier 2	Standard Tier 1	Graded In Tier 2
	20	72	1 3/16	55	8	LKT2072TT	\$657	\$684	\$1,241	\$1,264
	20	60	1 3/16	47	7	LKT2060TT	\$581	\$602	\$1,157	\$1,177

Features:

- edge profile on approach side
- placed on top of storage credenza

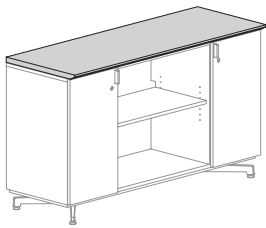

LOK - CONFERENCE

To Order Specify

1 Laminite Model #	2 Edge Detail	3 Laminite Selection	4 PVC Edge Color
Laminite (LKT)	<a href="#">See Edge Detail Options</a>	<a href="#">See Laminite Selection</a>	<a href="#">See PVC Edge Color Options</a>
			N None CT2 Dual Power Center Top CU2 Dual Power Underside CT2U1 Dual Power Center Top with Underside (See chart on next page)

[See Metal Finish Color Options](#)

Model Number Breakdown

LKT2072TT			
LK	T	2072	TT
LOK	Laminite	20" x 72"	Rectangular Top Shape

Description

Credenza Cabinet Top  
(continued)

Veneer Tables  
"LKV" Models

Solid Surface Tables  
"LKS" Models

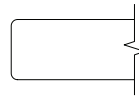

Eased Edge (R3)

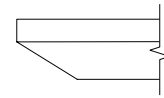

Reverse Bevel Edge (K9)

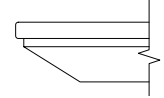

Reverse Bevel Edge (K7)

	D	W	H	CTN WT	CU FT	① Model	Veneer Tables "LKV" Models		Solid Surface Tables "LKS" Models		
							Essentials	Artisan	Essentials	Artisan	Standard
VENEER	20	72	1 3/16	55	8	LKV2072TT	\$1,014	\$1,145	\$1,262	\$1,379	--
	20	60	1 3/16	47	7	LKV2060TT	\$931	\$1,040	\$1,175	\$1,268	--
SOL SURF	20	72	1 3/16	55	8	LKS2072TT	--	--	--	--	\$2,785
	20	60	1 3/16	47	7	LKS2060TT	--	--	--	--	\$2,529

To Order Specify

① Veneer Model #	② Edge Detail	③ Wood Collection	④ Wood Finish
Veneer (LKV)	<a href="#">See Edge Detail Options</a>	Essentials	<a href="#">See Essentials Wood Finish Options</a>
		Artisan	④ Wood Finish <a href="#">See Artisan Wood Finish Options</a>

① Solid Surface Model #	② Top Surface Selection
Solid Surface (LKS)	<a href="#">See Solid Surface Top Surface Selection Options</a>

LOK- CONFERENCE

Description	D	W	H	CTN WT	CU FT	① Model	List Price
-------------	---	---	---	-----------	----------	---------	------------

<b>3 Prong Plug - 110 Power Infeed</b>				1	1	AP72	\$357
--	--	--	--	---	---	------	-------

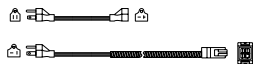

- Features:**
- 72" plug power infeed
  - 20 amps/110 volts max
  - 3 prong plug - 15 amp adapter plug included
  - single circuit use only

<b>Hardwire Power Infeed</b>				1	1	HP72	\$290
------------------------------	--	--	--	---	---	------	-------



- Features:**
- 72" hardwire power infeed
  - 20 amps/120 volts max
  - single or double circuit
  - electrical contractor responsible for connection to building power source

<b>Quick Disconnect Power Infeed</b>				1	1	MP72	\$267
--------------------------------------	--	--	--	---	---	------	-------



- Features:**
- must be used with QD1
  - 72" modular power infeed
  - 20 amps/120 volts max
  - single or double circuit

<b>Quick Disconnect Wall Outlet</b>				1	1	QD1	\$137
-------------------------------------	--	--	--	---	---	-----	-------

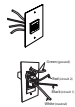

- Features:**
- must be used with MP72
  - works for both single or double circuit
  - 20 amps/120 volts max
  - electrical contractor responsible for connection to building power source

<b>Vertical Wire Manager</b>	1/2	2 1/4	33	1	1	AVL33	\$154
	1/2	2 1/4	25	1	1	AVL25	\$117
	1/2	2 1/4	22	1	1	AVL20	\$95
	1/2	2 1/4	17	1	1	AVL17	\$90



- Features:**
- field installed
  - use AVL33 for 42"h tables with disk base
  - use AVL25 for 42"h tables
  - use AVL20 for 36"h tables
  - use AVL17 for 29"h tables

- Options:**
- specify plastic color, Black (B) or Silver (S)

<b>Flexible Vertical Wire Manager</b>	1 1/2	1 1/2	45	4	1	45VWM	\$146
---------------------------------------	-------	-------	----	---	---	-------	-------



- Features:**
- black plastic
  - field installed to bottom of table top, with screws provided
  - wire manager is 1 1/2" diameter
  - weighted base is 4" diameter
  - length can be adjusted by removing individual discs as required

LOK - CONFERENCE

Description	D	W	H	CTN WT	CU FT	Model	List Price
Power Strip	1 1/2	1 7/8	8	3	1	GP9ACP1-0212	\$103

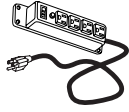

- Features:**
- power surge with 10' cord
  - four electrical outlets
  - includes switch
  - field installed

Wire Management Velcro Straps	1 3/4	3 1/2	1/4	1	1	04WVS	\$63
-------------------------------	-------	-------	-----	---	---	-------	------

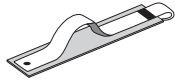

- Features:**
- black, set of 4
  - field installed to bottom of table top, with adhesive tape provided

Cable Management Clips	2 5/8	3 3/4	1 5/8	1	1	0304CMC	\$61
------------------------	-------	-------	-------	---	---	---------	------

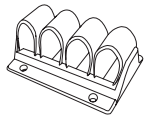

- Features:**
- black plastic
  - installed to bottom of table top
  - four retention loops

Floor Mount Glide	3	2 1/4	1/2	1	1	LKB516-18ANCHOR	\$47
-------------------	---	-------	-----	---	---	-----------------	------

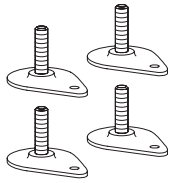

- Features:**
- field installed glides for mounting table base to floor
  - 1/4" diameter hole in the glide for mounting
  - set of 4
  - table can be leveled before attached to floor
  - floor attachment hardware provided by installer
  - glide threads 3/8"-16

Wire Management Tray	7 1/2	45	3	8	2	GP9WMT1-0845	\$300
	7 1/2	35	3	6	1	GP9WMT1-0835	\$253
	7 1/2	25	3	4	1	GP9WMT1-0825	\$205

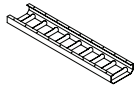

- Features:**
- silver powder-coated finish
  - four hanging brackets (CI2C00)

Wire Manager Trough	2 1/2	36	2 1/2	4	1	36WCT	\$169
	2 1/2	24	2 1/2	3	1	24WCT	\$154
	2 1/2	12	2 1/2	2	1	12WCT	\$132

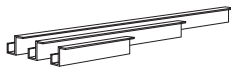

- Features:**
- black plastic
  - field installed to bottom of table top, with screws provided

**Accessories/ Keyboard/ Tasklights**

For an additional list of electrical units, grommets, keyboards, wire management, monitor arms & telecom jacks, please see our [accessories price list](#)

Contact your customer service representative for specific questions regarding which units can be used with Lok Conferencing.

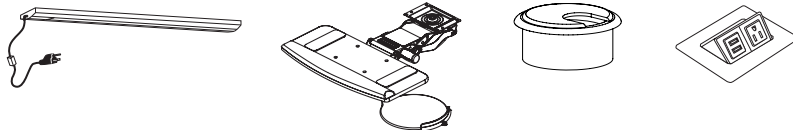

Page left intentionally blank

**Lounge - Table of Contents**



Training



Teamwork



Conference



Lounge

**Lok - Lounge**

**Product Information**

Lounge Overview . . . . . 410  
 Tables Shapes & Sizes . . . . . 415-416  
 Laminate Specifications . . . . . 413  
 Veneer Specifications . . . . . 414  
 Solid Surface Specifications . . . . . 414  
 Base Styles - Features . . . . . 417  
 Electrical Planning - Options . . . . . 417

**Pricing Pages**

Lounge Tables at 16" Height . . . . . 418-435  
 Lounge Tables at 26" Height . . . . . 436-453  
 Electrical . . . . . 454

## Lounge - Overview



rectangular  
16 "H - Page 448  
26""H - Page 464



rounded rectangular  
16 "H - Page 450



arc rectangular  
16 "H - Page 452



rounded arc  
rectangular  
16 "H - Page 454



oval  
16 "H - Page 456  
26""H - Page 466

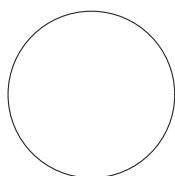

round  
16 "H - Page 458  
26""H - Page 468



square  
26""H - Page 470



rounded square  
16 "H - Page 460  
26""H - Page 472

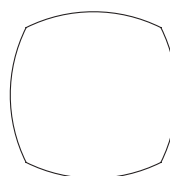

squircle  
16 "H - Page 462  
26""H - Page 474

## Lounge - Materials

### Laminate Tops

Lok training table worksurfaces are offered in HPL (High Pressure Laminate) The tops are 1 3/16" thick, 3 ply balanced construction. Particle board core and a phenolic backer sheet complete the balanced construction.

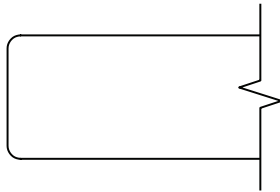

**Eased Edge (R3)**  
PVC

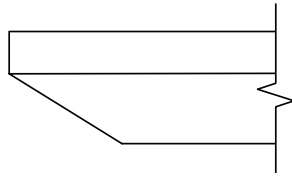

**Reverse Bevel (K9)**  
PVC on painted top of painted MDF

### Standard PVC Edge Colors

JSI supports 26 standard PVC edge colors listed below. These coordinate with our Standard (Tier1) Laminates.

When selecting a Standard (Tier 1) Laminate, the coordinating PVC edge color is automatically applied. When selecting a Graded-In Tier 2 Laminate, you will be prompted to choose one these 26 PVC edge colors to be applied to the edge.

<b>ALB</b> Alabaster	<b>MES</b> Mesa
<b>BEL</b> Belair	<b>MIN</b> Mineral
<b>BLK</b> Black	<b>MCH</b> Mocha
<b>BRK</b> Brickdust	<b>OBK</b> Outback
<b>BBL</b> Bridal Blanco	<b>PIL</b> Pilsner
<b>CSK</b> Cask	<b>PIN</b> Pinnacle Walnut
<b>CLY</b> Clay	<b>SHD</b> Shadow
<b>DWH</b> Designer White	<b>SLG</b> Slate Grey
<b>EGR</b> Egret	<b>UMB</b> Umber
<b>FAW</b> Fawn	<b>VAL</b> Valley
<b>FLN</b> Flint	<b>WAL</b> Walnut Heights
<b>FLO</b> Florence Walnut	<b>WEA</b> Weathered Ash
<b>LOF</b> Loft	<b>ZEN</b> Zen Grey

### Standard Laminates

JSI Standard Laminate program consists of 26 solid and wood grain patterns, and establish our Tier 1 laminate pricing. Each has a coordinating PVC edge color that is automatically used with the Standard Laminates.

#### Wood Grain Laminate

<b>BEL</b> Belair	<b>MIN</b> Mineral
<b>BRK</b> Brickdust	<b>MCH</b> Mocha
<b>CSK</b> Cask	<b>OBK</b> Outback
<b>CLY</b> Clay	<b>PIL</b> Pilsner
<b>EGR</b> Egret	<b>PIN</b> Pinnacle Walnut
<b>FAW</b> Fawn	<b>UMB</b> Umber
<b>FLN</b> Flint	<b>VAL</b> Valley
<b>FLO</b> Florence Walnut	<b>WLH</b> Walnut Heights
<b>LOF</b> Loft	<b>WEA</b> Weathered Ash
<b>MES</b> Mesa	

#### Solid Laminate

<b>ALB</b> Alabaster
<b>BLK</b> Black
<b>BBL</b> Bridal Blanco
<b>DWH</b> Designer White
<b>SHD</b> Shadow
<b>SLG</b> Slate Grey
<b>ZEN</b> Zen Grey

## Lounge - Materials

### Veneer Tops

Tops are 1 3/8" thick, 5 ply balanced construction with particle board core. Standard Tier 1 veneer is essentials, book matched for cherry, maple, walnut and black oak veneer. Standard Tier 2 veneer is artisan.

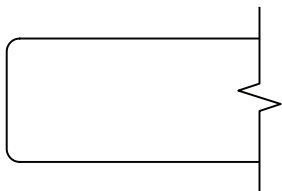

**Eased Edge (R3)**  
Internal Lumber Band

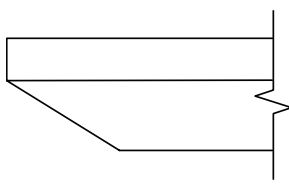

**Reverse Bevel (K9)**  
Veneer Band on Stained MDF

### Finish - Stain/Colors

#### ESS Essentials Veneer Collection

BRK Brickdust	MIN Mineral
CSK Cask	MCH Mocha
CLY Clay	OBK Outback
FAW Fawn	PIL Pilsner
FLX Flax	SIE Sienna
FLN Flint	TRF Truffle
LOF Loft	UMB Umber
MES Mesa	VAL Valley

#### ART Artisan Veneer Collection

BAR Barrel	RAV Raven
BUF Buff	RYE Rye
CND Cinder	SAB Sable
EGR Egret	SAD Saddle

#### Protective Top Coat

DuraTex™ offers exceptional hardness along with abrasion and impact resistance, it has been formulated to eliminate hazardous and harmful gases that are normally associated with wood finish.

#### DuraTex™ Features

- Safety - Significantly reduces hazardous formaldehyde emissions which help improve the quality of the of the indoor air we breathe.
- Quality - Developed to be tough and durable with special attention to appearance. The DuraTex™ finish preserves the natural beauty of wood.
- Durability - Designed to meet a wide range of demanding performance and environmental standards to withstand even the highest wear and tear.

#### Finish Sheen

All veneer finishes are standard in 35-sheen, with the exception of Raven. Raven is only offered in 15-sheen. All other finishes can have their sheen modified with a 15% upcharge added to the list price of each item.

#### Custom/Special Finishes

JSI, upon request, will accommodate special finishes. A written request is required to proceed with custom finish orders. A sample reference is required for first-time matches and must be included with the written request.

There is a one-time charge of **\$412 list per order** for any non-standard wood finish.

Orders will be entered noting the special finish. A sample match will be provided to the customer. Written approval is needed before the finish process can be started. Delays in approval may have an impact on lead times.

Every effort will be made to create the requested match; however, an acceptable match may not be possible because of natural variations of wood. These natural variations can also cause minor differences in the final finish product.

Use standard pricing and option pricing for each line item with a special finish, unless additional modifications have been specified. For items available in both Essential and Artisan veneers, apply the Essentials pricing.

### Solid Surface Tops

Tops are 1 3/8" thick constructed of 1/2" thick Solid Surface on top of a 1/4" MDF sub top. Sub top has an under cut bevel profile and is painted in a coordinated color to match the Solid Surface.

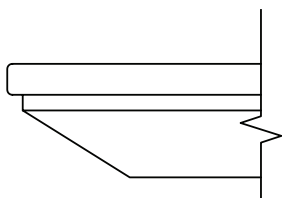





#### Standard Solid Surface

<b>ONX</b>	Black Onyx Mirage
<b>DWH</b>	Designer White
<b>HST</b>	Hot Stone
<b>SOG</b>	Soothing Grey

**Reverse Bevel Edge (K7)**  
Solid Surface over painted MDF

## Lounge -Top Shapes

Lok offers 9 lounge table top shapes. Tables are available in 16" or 26" high and in laminate, veneer or solid surface. Compatible bases are: X Base or Y Base.

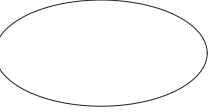
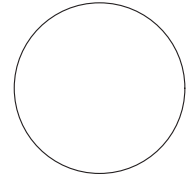
					
rectangular	rounded rectangular	arc rectangular	rounded arc rectangular	oval	round
16"h	16"h	16"h	16"h	16"h	16"h
24" x 48"	24" x 48"	24" x 48"	24" x 48"	30" x 48"	24"
30" x 48"	30" x 48"	30" x 48"	30" x 48"		30"
					36"
					42"
26"h	26"h	26"h	26"h	26"h	26"h
24" x 48"	24" x 48"	24" x 48"	24" x 48"	30" x 48"	24"
30" x 48"	30" x 48"	30" x 48"	30" x 48"		30"
					36"
					42"

## Lounge - Top Shapes

Lok offers 9 lounge table top shapes. Tables are available in 16" or 26" high and in laminate, veneer or solid surface. Compatible bases are: X Base or Y Base.

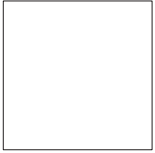

square

16"h

24" x 24"  
30" x 30"  
36" x 36"

26"h

24" x 24"  
30" x 30"  
36" x 36"

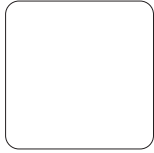

rounded square

26"h

24" x 24"  
30" x 30"  
36" x 36"

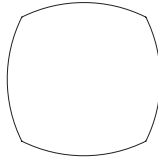

squircle

16"h

24" x 24"  
30" x 30"  
36" x 36"

26"h

24" x 24"  
30" x 30"  
36" x 36"

## Lounge- Base Styles

Lok provides a choice selection of bases in both function and aesthetics to serve a variety of needs. The conferencing offering includes: X-base and Y-Base.

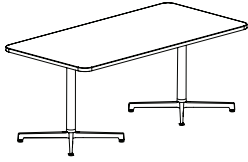

### X-Base

- available 16"h or 26"h only in glides.
- compatible with the following top shapes: round, square, square, squircle
- base finish - select single metal finish or two-tone metal finish. See options listed below
- power access version, with integrated wire management available with an upcharge

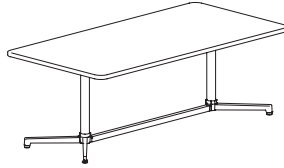

### Y Base

- available in 16"h or 26"h only in glides
- compatible with the following top shapes: arc rectangular, oval
- base finish - select single metal finish or two-tone metal finish. See options listed below

## Single Metal Finish

- ABZ** Aged Bronze Feet & Post
- ASL** Arctic Silver Feet & Post
- GLD** Gold Feet & Post
- PEW** Pewter Feet & Post
- MBK** Matte Black Feet & Post
- SBZ** Soft Bronze Feet & Post
- SNK** Soft Nickel Feet & Post

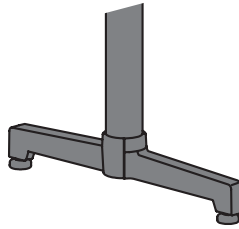

## Two - Tone Metal Finish

Two-Tone Aesthetics can be achieved by specifying Polished Aluminum on the foot and a contrasting finish on the post

### Polished Aluminum Feet

- ABZ** Aged Bronze Post
- ASL** Arctic Silver Post
- GLD** Gold Post
- PEW** Pewter Post
- MBK** Matte Black Post
- SBZ** Soft Bronze Post
- SNK** Soft Nickel Post

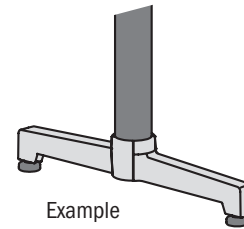

## Power/Charging Options

Lok offers the ability to place power and charging options in the center of select tables. Select your choice of EC23 or EC24, available in black and white.



### Moire - EC23

- Three 110 outlets
- Dual USB port with 72" power cord
- Black (B) or White (W)

select CTEC23 for cutout in worksurfaces



### Node - EC24

- One 110 outlet
- Dual USB port with 72" power cord
- Black (B) or White (W)

select CTEC24 for cutout in worksurfaces

Cut outs are located in the center of each table. See below for representation or location.

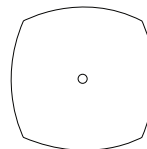
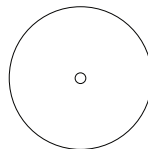
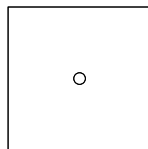
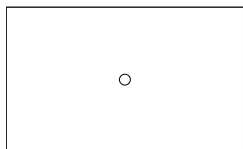

Description

Rectangular Table with Y Base at 16" Lounge Height

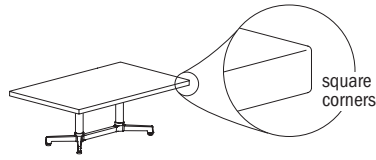

Laminate Tables  
"LKT" Models

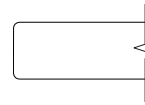

Eased Edge (R3)

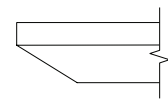

Reverse Bevel Edge (K9)

LAMINATE	D	W	H	CTN WT	CU FT	Model	Eased Edge (R3)		Reverse Bevel Edge (K9)	
							Standard	Graded In	Standard	Graded In
							Tier 1	Tier 2	Tier 1	Tier 2
	30	48	16	79	18	LKT3048-16TTY	\$2,007	\$2,029	\$2,562	\$2,586
	24	48	16	74	16	LKT2448-16TTY	\$1,926	\$1,942	\$2,473	\$2,493

Features:

- price reflects complete table - top and base
- ships KD in multiple cartons
- model includes adjustable glide
- power cord is routed outside base column
- order vertical wire manager separately; see page 454

Options:

- specify power unit option; None (N), add \$594 for EC23 (CTEC23), add \$474 for EC24 (CTEC24)



top shape

To Order Specify

1 Laminates Model #	2 Edge Detail	3 Laminates Selection	3a PVC Edge Color	4 Electrical	5 Metal Color
Laminates (LKT)	<a href="#">See Edge Detail Options</a>	<a href="#">See Laminates Selection</a>	<a href="#">See PVC Edge Color Options</a>	N None CTEC23 Power Center Top CTEC24 Power Center Top (See chart on next page)	<a href="#">See Metal Finish Color Options</a>

Model Number Breakdown

LKT3048-16TTY					
LK	T	3048	16	TT	Y
LOK	Laminates	30" x 48"	Height	Rectangular Top Shape	Y base

Description

Rectangular Table with Y  
Base at 16" Lounge Height  
(continued)

Veneer Tables  
"LKV" Models

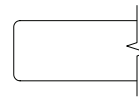

Eased Edge (R3)

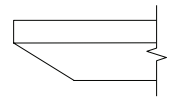

Reverse Bevel Edge (K9)

VENEER	D	W	H	CTN WT	CU FT	1 Model	Essentials	Artisan	Essentials	Artisan
	30	48	16	79	18	LKV3048-16TTY	\$2,342	\$2,467	\$2,583	\$2,689
24	48	16	74	16	LKV2448-16TTY	\$2,258	\$2,359	\$2,489	\$2,575	

Electrical Options and Upcharges

CTEC23	
EC23 Power Center Top - Black	CTEC23BL - add \$594
EC23 Power Center Top - White	CTEC23WH - add \$594
CTEC24	
EC24 Power Center Top - Black	CTEC43BL - add \$474
EC24 Power Center Top - White	CTEC43WH - add \$474

To Order Specify

1 Veneer Model #	2 Edge Detail	3 Wood Collection	4 Wood Finish	5 Electrical	6 Metal Color
Veneer (LKV)	R3 Eased K9 Reverse Bevel	Essentials	<a href="#">See Essentials Wood Finish Options</a>	N None CTEC23 Power Center Top CTEC24 Power Center Top (See chart above)	<a href="#">See Metal Finish Color Options</a>
	Artisan	4 Wood Finish <a href="#">See Artisan Wood Finish Options</a>			

Description

Rounded Rectangular Table with Y Base at 16" Lounge Height

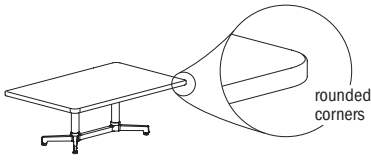

Laminate Tables  
"LKT" Models

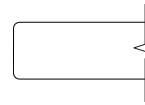

Eased Edge (R3)

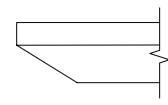

Reverse Bevel Edge (K9)

LAMINATE	D	W	H	CTN WT	CU FT	① Model	Standard Tier 1	Graded In Tier 2	Standard Tier 1	Graded In Tier 2
	30	48	16	79	18	LKT3048-16TTRY	\$2,084	\$2,106	\$2,643	\$2,668
	24	48	16	69	16	LKT2448-16TTRY	\$1,969	\$1,989	\$2,520	\$2,536

Features:

- price reflects complete table - top and base
- ships KD in multiple cartons
- model includes adjustable glide
- power cord is routed outside base column
- order vertical wire manager separately; see page 454

Options:

- specify power unit option; None (N), add \$594 for EC23 (CTEC23), add \$474 for EC24 (CTEC24)

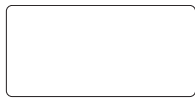

top shape

To Order Specify

① Laminate Model #	② Edge Detail	③ Laminate Selection	④ PVC Edge Color	⑤ Electrical	⑥ Metal Color
Laminate (LKT)	<a href="#">See Edge Detail Options</a>	<a href="#">See Laminate Selection</a>	<a href="#">See PVC Edge Color Options</a>	N None CTEC23 Power Center Top CTEC24 Power Center Top (See chart on next page)	<a href="#">See Metal Finish Color Options</a>

Model Number Breakdown

LKT3048-16TTRY						
LK	T	3048	16	TT	R	Y
LOK	Laminate	30" x 48"	Height	Rectangular Top Shape	Rounded Corner	Y Base

Description

Rounded Rectangular Table with Y Base at 16" Lounge Height (continued)

Veneer Tables "LKV" Models      Solid Surface Tables "LKS" Models

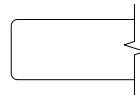

Eased Edge (R3)

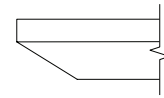

Reverse Bevel Edge (K9)

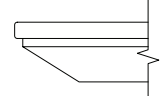

Reverse Bevel Edge (S7)

	D	W	H	CTN WT	CU FT	① Model	Veneer Tables "LKV" Models		Solid Surface Tables "LKS" Models		
							Essentials	Artisan	Essentials	Artisan	Standard
VENEER	30	48	16	79	18	LKV3048-16TTRY	\$2,411	\$2,549	\$2,655	\$2,774	--
	24	48	16	69	16	LKV2448-16TTRY	\$2,306	\$2,403	\$2,533	\$2,621	--
SOL. SURF.	30	48	16	79	18	LKS3048-16TTRY	--	--	--	--	\$4,886
	24	48	16	69	16	LKS2448-16TTRY	--	--	--	--	\$3,632

Electrical Options and Upcharges

CTEC23	
EC23 Power Center Top - Black	CTEC23BL - add \$594
EC23 Power Center Top - White	CTEC23WH - add \$594
CTEC24	
EC24 Power Center Top - Black	CTEC43BL - add \$474
EC24 Power Center Top - White	CTEC43WH - add \$474

To Order Specify

① Veneer Model #	② Edge Detail	③ Wood Collection	④ Wood Finish	⑤ Electrical	⑥ Metal Color
Veneer (LKV)	<a href="#">See Edge Detail Options</a>	Essentials	<a href="#">See Essentials Wood Finish Options</a>	N None CTEC23 Power Center Top CTEC24 Power Center Top (See chart above)	<a href="#">See Metal Finish Color Options</a>
		Artisan	<a href="#">See Artisan Wood Finish Options</a>		

① Solid Surface Model #	② Top Surface Selection	③ Electrical Cut Out	④ Metal Color
Solid Surface (LKS)	<a href="#">See Solid Surface Top Surface Selection Options</a>	N None CTEC23 Power Center Top CTEC24 Power Center Top (See chart above)	<a href="#">See Metal Finish Color Options</a>

LOK - LOUNGE

Description

Arc Rectangular Table with Y  
Base at 16" Lounge Height

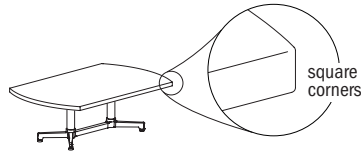

Laminate Tables  
"LKT" Models

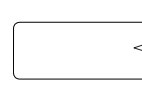

Eased Edge (R3)

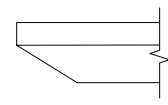

Reverse Bevel Edge (K9)

LAMINATE	D	W	H	CTN WT	CU FT	① Model	Standard Tier 1	Graded In Tier 2	Standard Tier 1	Graded In Tier 2
		30	48	16	75	18	LKT3048-16ARY	\$2,084	\$2,106	\$2,643
	24	48	16	67	16	LKT2448-16ARY	\$1,969	\$1,989	\$2,520	\$2,536

Features:

- price reflects complete table - top and base
- ships KD in multiple cartons
- model includes adjustable glide
- power cord is routed outside base column
- order vertical wire manager separately; see page 454

Options:

- specify power unit option; None (N), add \$594 for EC23 (CTEC23), add \$474 for EC24 (CTEC24)



top shape

To Order Specify

① Laminate Model #	② Edge Detail	③ Laminate Selection	④ PVC Edge Color	⑤ Electrical	⑥ Metal Color
Laminate (LKT)	<a href="#">See Edge Detail Options</a>	<a href="#">See Laminate Selection</a>	<a href="#">See PVC Edge Color Options</a>	N None CTEC23 Power Center Top CTEC24 Power Center Top (See chart on next page)	<a href="#">See Metal Finish Color Options</a>

Model Number Breakdown

LKT3048-16ARY					
LK	T	3048	16	AR	Y
LOK	Laminate	30" x 48"	Height	Arc Rectangular Top Shape	Y base

Description

Arc Rectangular Table with Y Base  
at 16" Lounge Height  
(continued)

Veneer Tables  
"LKV" Models

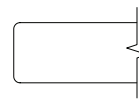

Eased Edge (R3)

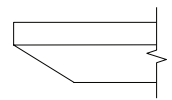

Reverse Bevel Edge (K9)

VENEER	D	W	H	CTN WT	CU FT	① Model	Essentials	Artisan	Essentials	Artisan
	30	48	16	75	18	LKV3048-16ARY	\$2,411	\$2,549	\$2,655	\$2,774
24	48	16	67	16	LKV2448-16ARY	\$2,306	\$2,403	\$2,533	\$2,621	

Electrical Options and Upcharges

CTEC23	
EC23 Power Center Top - Black	CTEC23BL - add \$594
EC23 Power Center Top - White	CTEC23WH - add \$594
CTEC24	
EC24 Power Center Top - Black	CTEC43BL - add \$474
EC24 Power Center Top - White	CTEC43WH - add \$474

To Order Specify

① Veneer Model #	② Edge Detail	③ Wood Collection	④ Wood Finish	⑤ Electrical	⑥ Metal Color
Veneer (LKV)	R3 Eased K9 Reverse Bevel	Essentials	<a href="#">See Essentials Wood Finish Options</a>	N None CTEC23 Power Center Top CTEC24 Power Center Top (See chart above)	<a href="#">See Metal Finish Color Options</a>
	Artisan	④ Wood Finish <a href="#">See Artisan Wood Finish Options</a>			

LOK - LOUNGE

Description

Rounded Arc Rectangular Table with Y Base at 16" Lounge Height

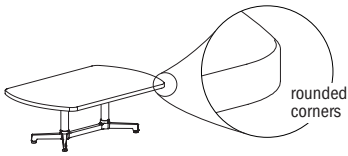

Laminate Tables  
"LKT" Models

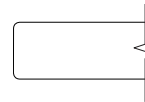

Eased Edge (R3)

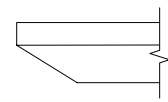

Reverse Bevel Edge (K9)

LAMINATE	D	W	H	CTN WT	CU FT	① Model	Standard Tier 1	Graded In Tier 2	Standard Tier 1	Graded In Tier 2
	30	48	16	75	18	LKT3048-16ARRY	\$2,084	\$2,106	\$2,643	\$2,668
	24	48	16	67	16	LKT2448-16ARRY	\$1,969	\$1,989	\$2,520	\$2,536

Features:

- price reflects complete table - top and base
- ships KD in multiple cartons
- model includes adjustable glide
- power cord is routed outside base column
- order vertical wire manager separately; see page 454

Options:

- specify power unit option; None (N), add \$594 for EC23 (CTEC23), add \$474 for EC24 (CTEC24)



top shape

To Order Specify

① Laminate Model #	② Edge Detail	③ Laminate Selection	④ PVC Edge Color	⑤ Electrical	⑥ Metal Color
Laminate (LKT)	<a href="#">See Edge Detail Options</a>	<a href="#">See Laminate Selection</a>	<a href="#">See PVC Edge Color Options</a>	N None CTEC23 Power Center Top CTEC24 Power Center Top (See chart on next page)	<a href="#">See Metal Finish Color Options</a>

Model Number Breakdown

LKT3048-16ARRY						
LK	T	3048	16	AR	R	Y
LOK	Laminate	30" x 48"	Height	Arc Rectangular Top Shape	Rounded Corner	Y Base

Description

Rounded Arc Rectangular Table with Y Base at 16" Lounge Height (continued)

Veneer Tables "LKV" Models      Solid Surface Tables "LKS" Models

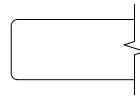

Eased Edge (R3)

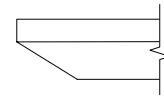

Reverse Bevel Edge (K9)

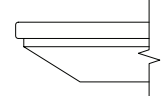

Reverse Bevel Edge (S7)

	D	W	H	CTN WT	CU FT	① Model	Veneer Tables "LKV" Models		Solid Surface Tables "LKS" Models		
							Essentials	Artisan	Essentials	Artisan	Standard
VENEER	30	48	16	75	18	LKV3048-16ARRY	\$2,411	\$2,549	\$2,655	\$2,774	--
	24	48	16	67	16	LKV2448-16ARRY	\$2,306	\$2,403	\$2,533	\$2,621	--
SOL.SURF.	30	48	16	75	18	LKS3048-16ARRY	--	--	--	--	\$4,886
	24	48	16	67	16	LKS2448-16ARRY	--	--	--	--	\$3,632

Electrical Options and Upcharges

CTEC23	
EC23 Power Center Top - Black	CTEC23BL - add \$594
EC23 Power Center Top - White	CTEC23WH - add \$594
CTEC24	
EC24 Power Center Top - Black	CTEC43BL - add \$474
EC24 Power Center Top - White	CTEC43WH - add \$474

To Order Specify

① Veneer Model #	② Edge Detail	③ Wood Collection	④ Wood Finish	⑤ Electrical	⑥ Metal Color
Veneer (LKV)	<a href="#">See Edge Detail Options</a>	Essentials	<a href="#">See Essentials Wood Finish Options</a>	N None CTEC23 Power Center Top CTEC24 Power Center Top (See chart above)	<a href="#">See Metal Finish Color Options</a>
		Artisan	<a href="#">See Artisan Wood Finish Options</a>		

① Solid Surface Model #	② Top Surface Selection	③ Electrical Cut Out	④ Metal Color
Solid Surface (LKS)	<a href="#">See Solid Surface Top Surface Selection Options</a>	N None CTEC23 Power Center Top CTEC24 Power Center Top (See chart above)	<a href="#">See Metal Finish Color Options</a>

LOK - LOUNGE

Description

Oval Table with Y Base at 16"  
Lounge Height



Laminate Tables  
"LKT" Models

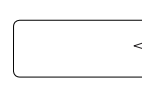

Eased Edge (R3)

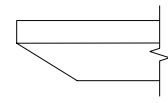

Reverse Bevel Edge (K9)

LAMI	D	W	H	CTN WT	CU FT	Model	Standard Tier 1	Graded In Tier 2	Standard Tier 1	Graded In Tier 2
		30	48	16	68	18	LKT3048-160VY	\$2,061	\$2,090	\$2,624

Features:

- price reflects complete table - top and base
- ships KD in multiple cartons
- model includes adjustable glide
- power cord is routed outside base column
- order vertical wire manager separately; see page 454

Options:

- specify power unit option; None (N), add \$594 for EC23 (CTEC23), add \$474 for EC24 (CTEC24)

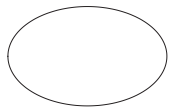

top shape

To Order Specify

1 Laminate Model #	2 Edge Detail	3 Laminate Selection	3a PVC Edge Color	4 Electrical	5 Metal Color
Laminate (LKT)	<a href="#">See Edge Detail Options</a>	<a href="#">See Laminate Selection</a>	<a href="#">See PVC Edge Color Options</a>	N None CTEC23 Power Center Top CTEC24 Power Center Top (See chart on next page)	<a href="#">See Metal Finish Color Options</a>

Model Number Breakdown

LKT3048-160VY					
LK	T	3048	16	OV	Y
LOK	Laminate	30" x 48"	Height	Oval Top Shape	Y base

Description

Oval Table with Y Base at 16"  
Lounge Height  
(continued)

Veneer Tables  
"LKV" Models

Solid Surface Tables  
"LKS" Models

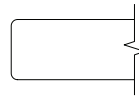

Eased Edge (R3)

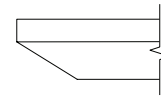

Reverse Bevel Edge (K9)

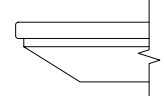

Reverse Bevel Edge (S7)

	D	W	H	CTN WT	CU FT	① Model	Veneer Tables "LKV" Models		Solid Surface Tables "LKS" Models		
							Essentials	Artisan	Essentials	Artisan	Standard
VEN.	30	48	16	68	18	LKV3048-160VY	\$2,395	\$2,529	\$2,637	\$2,759	--
S.S.	30	48	16	68	18	LKS3048-160VY	--	--	--	--	\$4,870

Electrical Options and Upcharges

CTEC23	
EC23 Power Center Top - Black	CTEC23BL - add \$594
EC23 Power Center Top - White	CTEC23WH - add \$594
CTEC24	
EC24 Power Center Top - Black	CTEC43BL - add \$474
EC24 Power Center Top - White	CTEC43WH - add \$474

To Order Specify

① Veneer Model #	② Edge Detail	③ Wood Collection	④ Wood Finish	⑤ Electrical	⑥ Metal Color
Veneer (LKV)	<a href="#">See Edge Detail Options</a>	Essentials	<a href="#">See Essentials Wood Finish Options</a>	N None CTEC23 Power Center Top CTEC24 Power Center Top (See chart above)	<a href="#">See Metal Finish Color Options</a>
		Artisan	<a href="#">See Artisan Wood Finish Options</a>		

① Solid Surface Model #	② Top Surface Selection	③ Electrical Cut Out	④ Metal Color
Solid Surface (LKS)	<a href="#">See Solid Surface Top Surface Selection Options</a>	N None CTEC23 Power Center Top CTEC24 Power Center Top (See chart above)	<a href="#">See Metal Finish Color Options</a>

LOK - LOUNGE

Description

Round Table with X Base at 16" Lounge Height



Laminate Tables "LKT" Models

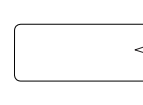

Eased Edge (R3)

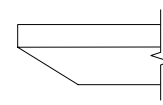

Reverse Bevel Edge (K9)

LAMINATE	D	W	H	CTN WT	CU FT	Model	Eased Edge (R3)		Reverse Bevel Edge (K9)	
							Standard Tier 1	Graded In Tier 2	Standard Tier 1	Graded In Tier 2
	42	42	16	68	18	LKT42-16RDX	\$1,622	\$1,753	\$2,135	\$2,267
36	36	16	55	17	LKT36-16RDX	\$1,495	\$1,515	\$2,052	\$2,072	
30	30	16	43	13	LKT30-16RDX	\$1,495	\$1,539	\$2,004	\$2,047	
24	24	16	35	12	LKT24-16RDX	\$1,206	\$1,219	\$1,750	\$1,759	

Features:

- price reflects complete table - top and base
- ships KD in multiple cartons
- model includes adjustable glide
- when electrical option is selected, power accessible base is shipped; see page 417 for details
- power/charging units have 72" cord
- power cord is routed inside base column

Options:

- specify power access base with power unit option; None (N), add \$735 for EC23 (CTEC23), add \$616 for EC24 (CTEC24)

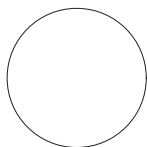

top shape

To Order Specify

1 Laminate Model #	2 Edge Detail	3 Laminate Selection	3a PVC Edge Color	4 Electrical	5 Metal Color
Laminate (LKT)	<a href="#">See Edge Detail Options</a>	<a href="#">See Laminate Selection</a>	<a href="#">See PVC Edge Color Options</a>	N None CTEC23 Power Center Top CTEC24 Power Center Top (See chart on next page)	<a href="#">See Metal Finish Color Options</a>

Model Number Breakdown

LKT42-16RDX					
LK	T	42	16	RD	X
LOK	Laminate	42" dia.	Height	Round Top Shape	X base

Description

Round Table with X Base at  
16" Lounge Height  
(continued)

Veneer Tables  
"LKV" Models

Solid Surface Tables  
"LKS" Models

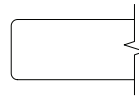

Eased Edge (R3)

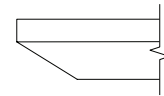

Reverse Bevel Edge (K9)

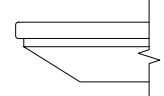

Reverse Bevel Edge (S7)

	D	W	H	CTN WT	CU FT	① Model	Veneer Tables "LKV" Models		Solid Surface Tables "LKS" Models		
							Essentials	Artisan	Essentials	Artisan	Standard
VENEER	42	42	16	68	18	LKV42-16RDX	\$2,061	\$2,217	\$2,321	\$2,460	--
	36	36	16	55	17	LKV36-16RDX	\$1,863	\$1,980	\$2,107	\$2,210	--
	30	30	16	43	13	LKV30-16RDX	\$1,837	\$1,927	\$2,092	\$2,169	--
	24	24	16	35	12	LKV24-16RDX	\$1,522	\$1,590	\$1,742	\$1,800	--
SOLID SURFACE	42	42	16	91	18	LKS42-16RDX	--	--	--	--	\$4,886
	36	36	16	71	17	LKS36-16RDX	--	--	--	--	\$4,076
	30	30	16	54	13	LKS30-16RDX	--	--	--	--	\$3,540
	24	24	16	41	12	LKS24-16RDX	--	--	--	--	\$2,901

Electrical Options and Upcharges

CTEC23	
EC23 Power Center Top - Black	CTEC23BL - add \$735
EC23 Power Center Top - White	CTEC23WH - add \$735
CTEC24	
EC24 Power Center Top - Black	CTEC43BL - add \$616
EC24 Power Center Top - White	CTEC43WH - add \$616

To Order Specify

① Veneer Model #	② Edge Detail	③ Wood Collection	④ Wood Finish	⑤ Electrical	⑥ Metal Color
Veneer (LKV)	R3 Eased K9 Reverse Bevel	Essentials	<a href="#">See Essentials Wood Finish Options</a>	N None CTEC23 Power Center Top CTEC24 Power Center Top (See chart above)	<a href="#">See Metal Finish Color Options</a>
		Artisan	<a href="#">See Artisan Wood Finish Options</a>		

① Solid Surface Model #	② Top Surface Selection	Electrical Cut Out	Metal Color
Solid Surface (LKS)	<a href="#">See Solid Surface Top Surface Selection Options</a>		

LOK - LOUNGE

Description

Square Table with X Base at 16" Lounge Height

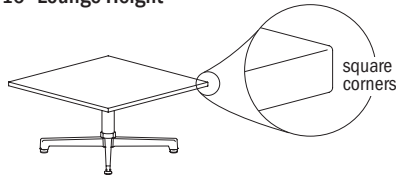

Laminate Tables  
"LKT" Models

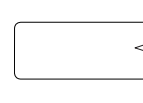

Eased Edge (R3)

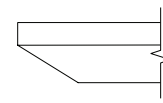

Reverse Bevel Edge (K9)

LAMINATE	D	W	H	CTN WT	CU FT	① Model	Eased Edge (R3)		Reverse Bevel Edge (K9)	
							Standard Tier 1	Graded In Tier 2	Standard Tier 1	Graded In Tier 2
	36	36	16	65	17	LKT3636-16SQX	\$1,448	\$1,470	\$2,004	\$2,026
	30	30	16	50	13	LKT3030-16SQX	\$1,454	\$1,474	\$2,076	\$2,092
	24	24	16	38	9	LKT2424-16SQX	\$1,126	\$1,132	\$1,652	\$1,659

Features:

- price reflects complete table - top and base
- ships KD in multiple cartons
- model includes adjustable glide
- when electrical option is selected, power accessible base is shipped; see page 417 for details
- power/charging units have 72" cord
- power cord is routed inside base column

Options:

- specify power access base with power unit option; None (N), add \$735 for EC23 (CTEC23), add \$616 for EC24 (CTEC24)



top shape

To Order Specify

① Laminate Model #	② Edge Detail	③ Laminate Selection	④ PVC Edge Color	⑤ Electrical	⑥ Metal Color
Laminate (LKT)	<a href="#">See Edge Detail Options</a>	<a href="#">See Laminate Selection</a>	<a href="#">See PVC Edge Color Options</a>	N None CTEC23 Power Center Top CTEC24 Power Center Top (See chart on next page)	<a href="#">See Metal Finish Color Options</a>

Model Number Breakdown

LKT3636-16SQX					
LK	T	3636	16	SQ	X
LOK	Laminate	36" x 36"	Height	Square Top Shape	X Base

Description

Square Table with X Base at 16"  
Lounge Height  
(continued)

Veneer Tables  
"LKV" Models

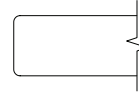

Eased Edge (R3)

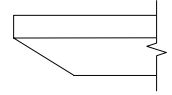

Reverse Bevel Edge (K9)

D	W	H	CTN WT	CU FT	① Model	Essentials		Artisan	
						Essentials	Artisan	Essentials	Artisan
36	36	16	65	17	LKV3636-16SQX	\$1,859	\$1,974	\$2,105	\$2,204
30	30	16	50	13	LKV3030-16SQX	\$1,832	\$1,923	\$2,087	\$2,162
24	24	16	38	9	LKV2424-16SQX	\$1,472	\$1,528	\$1,689	\$1,734

VENEER

Electrical Options and Upcharges

CTEC23	
EC23 Power Center Top - Black	CTEC23BL - add \$735
EC23 Power Center Top - White	CTEC23WH - add \$735
CTEC24	
EC24 Power Center Top - Black	CTEC43BL - add \$616
EC24 Power Center Top - White	CTEC43WH - add \$616

To Order Specify

① Veneer Model #	② Edge Detail	③ Wood Collection	④ Wood Finish	⑤ Electrical	⑥ Metal Color
Veneer (LKV)	R3 Eased K9 Reverse Bevel	Essentials	<a href="#">See Essentials Wood Finish Options</a>	N None CTEC23 Power Center Top CTEC24 Power Center Top (See chart above)	<a href="#">See Metal Finish Color Options</a>
	Artisan	④ Wood Finish <a href="#">See Artisan Wood Finish Options</a>			

LOK - LOUNGE

Description

Rounded Square Table with X Base at 16" Lounge Height

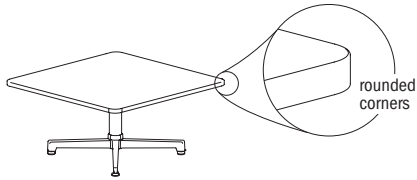

Laminate Tables "LKT" Models

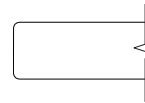

Eased Edge (R3)

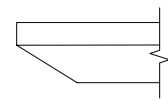

Reverse Bevel Edge (K9)

LAMINATE	D	W	H	CTN WT	CU FT	Model	Standard Tier 1	Graded In Tier 2	Standard Tier 1	Graded In Tier 2
		36	36	16	65	17	LKT3636-16SQRX	\$1,495	\$1,515	\$2,052
	30	30	16	50	13	LKT3030-16SQRX	\$1,482	\$1,539	\$2,004	\$2,047
	24	24	16	38	9	LKT2424-16SQRX	\$1,183	\$1,193	\$1,714	\$1,724

Features:

- price reflects complete table - top and base
- ships KD in multiple cartons
- model includes adjustable glide
- when electrical option is selected, power accessible base is shipped; see page 417 for details
- power/charging units have 72" cord
- power cord is routed inside base column

Options:

- specify power access base with power unit option; None (N), add \$735 for EC23 (CTEC23), add \$616 for EC24 (CTEC24)

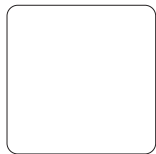

top shape

To Order Specify

1 Laminite Model #	2 Edge Detail	3 Laminite Selection	3a PVC Edge Color	4 Electrical	5 Metal Color
Laminite (LKT)	<a href="#">See Edge Detail Options</a>	<a href="#">See Laminite Selection</a>	<a href="#">See PVC Edge Color Options</a>	N None CTEC23 Power Center Top CTEC24 Power Center Top (See chart on next page)	<a href="#">See Metal Finish Color Options</a>

Model Number Breakdown

LKT3636-16SQRX						
LK	T	3636	16	SQ	R	X
LOK	Laminite	36" x 36"	Height	Square Top Shape	Rounded Corner	X Base

Description

Rounded Square Table with X Base at 16" Lounge Height (continued)

Veneer Tables "LKV" Models      Solid Surface Tables "LKS" Models

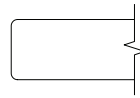

Eased Edge (R3)

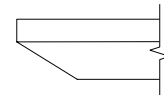

Reverse Bevel Edge (K9)

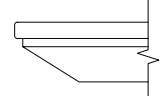

Reverse Bevel Edge (S7)

	D	W	H	CTN WT	CU FT	① Model	Veneer		Solid Surface		
							Essentials	Artisan	Essentials	Artisan	Standard
VENEER	36	36	16	65	17	LKV3636-16SQRX	\$1,908	\$2,024	\$2,153	\$2,256	--
	30	30	16	50	13	LKV3030-16SQRX	\$1,880	\$1,968	\$2,135	\$2,213	--
	24	24	16	38	9	LKV2424-16SQRX	\$1,522	\$1,590	\$1,742	\$1,800	--
SOLID SURFACE	36	36	16	86	17	LKS3636-16SQRX	--	--	--	--	\$4,121
	30	30	16	72	13	LKS3030-16SQRX	--	--	--	--	\$3,540
	24	24	16	47	9	LKS2424-16SQRX	--	--	--	--	\$2,901

Electrical Options and Upcharges

CTEC23	
EC23 Power Center Top - Black	CTEC23BL - add \$735
EC23 Power Center Top - White	CTEC23WH - add \$735
CTEC24	
EC24 Power Center Top - Black	CTEC43BL - add \$616
EC24 Power Center Top - White	CTEC43WH - add \$616

To Order Specify

① Veneer Model #	② Edge Detail	③ Wood Collection	④ Wood Finish	⑤ Electrical	⑥ Metal Color
Veneer (LKV)	R3 Eased K9 Reverse Bevel	Essentials	<a href="#">See Essentials Wood Finish Options</a>	N None CTEC23 Power Center Top CTEC24 Power Center Top (See chart above)	<a href="#">See Metal Finish Color Options</a>
	Artisan	④ Wood Finish	<a href="#">See Artisan Wood Finish Options</a>		

① Solid Surface Model #	② Top Surface Selection	Electrical Cut Out	Metal Color
Solid Surface (LKS)	<a href="#">See Solid Surface Top Surface Selection Options</a>		

LOK - LOUNGE

Description

Squirrel Table with X Base at 16" Lounge Height

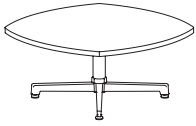

Laminate Tables "LKT" Models

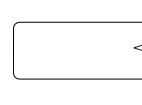

Eased Edge (R3)

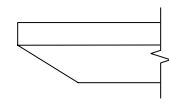

Reverse Bevel Edge (K9)

LAMINATE	D	W	H	CTN WT	CU FT	Model	Eased Edge (R3)		Reverse Bevel Edge (K9)	
							Standard	Graded In	Standard	Graded In
							Tier 1	Tier 2	Tier 1	Tier 2
	36	36	16	65	17	LKT36-16SCX	\$1,495	\$1,515	\$2,052	\$2,072
	30	30	16	50	13	LKT30-16SCX	\$1,495	\$1,539	\$2,004	\$2,047
	24	24	16	38	9	LKT24-16SCX	\$1,193	\$1,206	\$1,732	\$1,743

Features:

- price reflects complete table - top and base
- ships KD in multiple cartons
- model includes adjustable glide
- when electrical option is selected, power accessible base is shipped; see page 417 for details
- power/charging units have 72" cord
- power cord is routed inside base column

Options:

- specify power access base with power unit option; None (N), add \$735 for EC23 (CTEC23), add \$616 for EC24 (CTEC24)

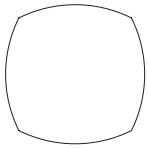

top shape

LOK - LOUNGE

To Order Specify

1 Laminates Model #	2 Edge Detail	3 Laminates Selection	3a PVC Edge Color	4 Electrical	5 Metal Color
Laminates (LKT)	<a href="#">See Edge Detail Options</a>	<a href="#">See Laminates Selection</a>	<a href="#">See PVC Edge Color Options</a>	N None CTEC23 Power Center Top CTEC24 Power Center Top (See chart on next page)	<a href="#">See Metal Finish Color Options</a>

Model Number Breakdown

LKT36-16SCX					
LK	T	36	16	SC	X
LOK	Laminates	36" dia.	Height	Squirrel Top Shape	X Base

Description

Squirrel Table with X Base at 16" Lounge Height (continued)

Veneer Tables "LKV" Models

Solid Surface Tables "LKS" Models

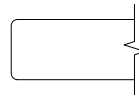

Eased Edge (R3)

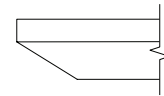

Reverse Bevel Edge (K9)

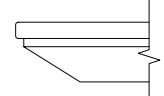

Reverse Bevel Edge (S7)

	D	W	H	CTN WT	CU FT	① Model	Veneer Tables		Solid Surface Tables		
							Essentials	Artisan	Essentials	Artisan	Standard
VENEER	36	36	16	65	17	LKV36-16SCX	\$1,908	\$2,024	\$2,153	\$2,256	--
	30	30	16	50	13	LKV30-16SCX	\$1,880	\$1,968	\$2,135	\$2,213	--
	24	24	16	38	9	LKV24-16SCX	\$1,522	\$1,590	\$1,742	\$1,800	--
SOLID SURFACE	36	36	16	86	17	LKS36-16SCX	--	--	--	--	\$4,121
	30	30	16	72	13	LKS30-16SCX	--	--	--	--	\$3,503
	24	24	16	47	9	LKS24-16SCX	--	--	--	--	\$2,901

Electrical Options and Upcharges

CTEC23	
EC23 Power Center Top - Black	CTEC23BL - add \$735
EC23 Power Center Top - White	CTEC23WH - add \$735
CTEC24	
EC24 Power Center Top - Black	CTEC43BL - add \$616
EC24 Power Center Top - White	CTEC43WH - add \$616

To Order Specify

① Veneer Model #	② Edge Detail	③ Wood Collection	④ Wood Finish	⑤ Electrical	⑥ Metal Color
Veneer (LKV)	R3 Eased K9 Reverse Bevel	Essentials	<a href="#">See Essentials Wood Finish Options</a>	N None CTEC23 Power Center Top CTEC24 Power Center Top (See chart above)	<a href="#">See Metal Finish Color Options</a>
	Artisan	④ Wood Finish <a href="#">See Artisan Wood Finish Options</a>			

① Solid Surface Model #	② Top Surface Selection	Electrical Cut Out	Metal Color
Solid Surface (LKS)	<a href="#">See Solid Surface Top Surface Selection Options</a>		

LOK - LOUNGE

Description

Rectangular Table with Y Base  
at 26" Chat Height

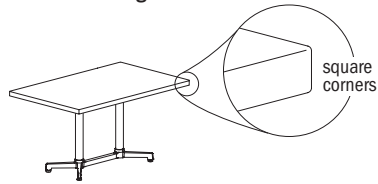

Laminate Tables  
"LKT" Models

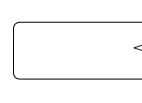

Eased Edge (R3)

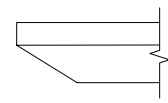

Reverse Bevel Edge (K9)

LAMINATE	D	W	H	CTN WT	CU FT	Model	Standard Tier 1	Graded In Tier 2	Standard Tier 1	Graded In Tier 2
	30	48	26	83	29	LKT3048-26TTY	\$2,007	\$2,029	\$2,563	\$2,586
	24	48	26	74	24	LKT2448-26TTY	\$1,926	\$1,942	\$2,474	\$2,494

Features:

- price reflects complete table - top and base
- ships KD in multiple cartons
- model includes adjustable glide
- power cord is routed outside base column
- order vertical wire manager separately; see page 454

Options:

- specify power unit option; None (N), add \$594 for EC23 (CTEC23), add \$474 for EC24 (CTEC24)



top shape

To Order Specify

1 Laminate Model #	2 Edge Detail	3 Laminate Selection	3a PVC Edge Color	4 Electrical	5 Metal Color
Laminate (LKT)	<a href="#">See Edge Detail Options</a>	<a href="#">See Laminate Selection</a>	<a href="#">See PVC Edge Color Options</a>	N None CTEC23 Power Center Top CTEC24 Power Center Top (See chart on next page)	<a href="#">See Metal Finish Color Options</a>

Model Number Breakdown

LKT3048-26TTY					
LK	T	3048	26	TT	Y
LOK	Laminate	30" x 48"	Height	Rectangular Top Shape	Y Base

Description

Rectangular Table with Y Base  
at 26" Chat Height  
(continued)

Veneer Tables  
"LKV" Models

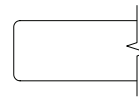

Eased Edge (R3)

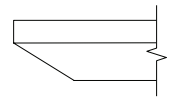

Reverse Bevel Edge (K9)

VENEER	D	W	H	CTN WT	CU FT	① Model	Essentials	Artisan	Essentials	Artisan
	30	48	26	83	29	LKV3048-26TTY	\$2,346	\$2,467	\$2,585	\$2,689
24	48	26	74	24	LKV2448-26TTY	\$2,259	\$2,359	\$2,490	\$2,576	

Electrical Options and Upcharges

CTEC23	
EC23 Power Center Top - Black	CTEC23BL - add \$594
EC23 Power Center Top - White	CTEC23WH - add \$594
CTEC24	
EC24 Power Center Top - Black	CTEC43BL - add \$474
EC24 Power Center Top - White	CTEC43WH - add \$474

To Order Specify

① Veneer Model #	② Edge Detail	③ Wood Collection	④ Wood Finish	⑤ Electrical	⑥ Metal Color
Veneer (LKV)	R3 Eased K9 Reverse Bevel	Essentials	<a href="#">See Essentials Wood Finish Options</a>	N None CTEC23 Power Center Top CTEC24 Power Center Top (See chart above)	<a href="#">See Metal Finish Color Options</a>
	Artisan	④ Wood Finish <a href="#">See Artisan Wood Finish Options</a>			

Description

Rounded Rectangular Table with Y Base at 26" Chat Height

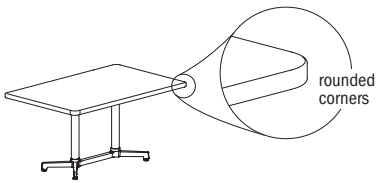

Laminate Tables  
"LKT" Models

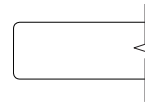

Eased Edge (R3)

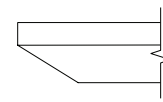

Reverse Bevel Edge (K9)

LAMINATE	D	W	H	CTN WT	CU FT	Model	Standard Tier 1	Graded In Tier 2	Standard Tier 1	Graded In Tier 2
	30	48	26	83	29	LKT3048-26TTRY	\$2,084	\$2,107	\$2,645	\$2,668
	24	48	26	79	24	LKT2448-26TTRY	\$1,969	\$1,989	\$2,520	\$2,536

Features:

- price reflects complete table - top and base
- ships KD in multiple cartons
- model includes adjustable glide
- power cord is routed outside base column
- order vertical wire manager separately; see page 454

Options:

- specify power unit option; None (N), add \$594 for EC23 (CTEC23), add \$474 for EC24 (CTEC24)

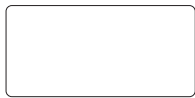

top shape

To Order Specify

1 Laminate Model #	2 Edge Detail	3 Laminate Selection	3a PVC Edge Color	4 Electrical	5 Metal Color
Laminate (LKT)	<a href="#">See Edge Detail Options</a>	<a href="#">See Laminate Selection</a>	<a href="#">See PVC Edge Color Options</a>	N None CTEC23 Power Center Top CTEC24 Power Center Top (See chart on next page)	<a href="#">See Metal Finish Color Options</a>

Model Number Breakdown

LKT3048-26TTRY						
LK	T	3048	26	TT	R	Y
LOK	Laminate	30" x 48"	Height	Rectangular Top Shape	Rounded Corner	Y Base

Description

Rounded Rectangular Table with Y Base at 26" Chat Height (continued)

		Veneer Tables "LKV" Models				Solid Surface Tables "LKS" Models					
		Eased Edge (R3)		Reverse Bevel Edge (K9)		Reverse Bevel Edge (S7)					
		Model	Essentials	Artisan	Essentials	Artisan	Standard				
D	W	H	CTN WT	CU FT							
VENEER	30	48	26	83	29	LKV3048-26TTRY	\$2,411	\$2,549	\$2,656	\$2,777	--
	24	48	26	79	24	LKV2448-26TTRY	\$2,306	\$2,403	\$2,534	\$2,621	--
SOL. SURF.	30	48	26	83	29	LKS3048-26TTRY	--	--	--	--	\$4,889
	24	48	26	79	24	LKS2448-26TTRY	--	--	--	--	\$3,814

Electrical Options and Upcharges

CTEC23	
EC23 Power Center Top - Black	CTEC23BL - add \$594
EC23 Power Center Top - White	CTEC23WH - add \$594
CTEC24	
EC24 Power Center Top - Black	CTEC43BL - add \$474
EC24 Power Center Top - White	CTEC43WH - add \$474

To Order Specify

1 Veneer Model #	2 Edge Detail	3 Wood Collection	4 Wood Finish	5 Electrical	6 Metal Color
Veneer (LKV)	<a href="#">See Edge Detail Options</a>	Essentials	<a href="#">See Essentials Wood Finish Options</a>	N None CTEC23 Power Center Top CTEC24 Power Center Top (See chart above)	<a href="#">See Metal Finish Color Options</a>
		Artisan	<a href="#">See Artisan Wood Finish Options</a>		

1 Solid Surface Model #	2 Top Surface Selection	3 Electrical Cut Out	4 Metal Color
Solid Surface (LKS)	<a href="#">See Solid Surface Top Surface Selection Options</a>	N None CTEC23 Power Center Top CTEC24 Power Center Top (See chart above)	<a href="#">See Metal Finish Color Options</a>

LOK - LOUNGE

Description

Arc Rectangular Table with Y Base at 26" Chat Height

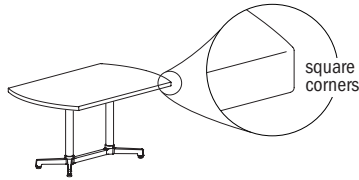

Laminate Tables "LKT" Models

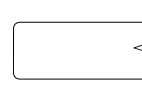

Eased Edge (R3)

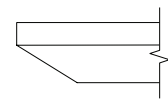

Reverse Bevel Edge (K9)

LAMINATE	D	W	H	CTN WT	CU FT	Model	Standard Tier 1	Graded In Tier 2	Standard Tier 1	Graded In Tier 2
	30	48	26	80	29	LKT3048-26ARY	\$2,084	\$2,107	\$2,645	\$2,668
	24	48	26	72	24	LKT2448-26ARY	\$1,969	\$1,989	\$2,520	\$2,536

Features:

- price reflects complete table - top and base
- ships KD in multiple cartons
- model includes adjustable glide
- power cord is routed outside base column
- order vertical wire manager separately; see page 454

Options:

- specify power unit option; None (N), add \$594 for EC23 (CTEC23), add \$474 for EC24 (CTEC24)



top shape

To Order Specify

1 Laminite Model #	2 Edge Detail	3 Laminite Selection	3a PVC Edge Color	4 Electrical	5 Metal Color
Laminite (LKT)	<a href="#">See Edge Detail Options</a>	<a href="#">See Laminite Selection</a>	<a href="#">See PVC Edge Color Options</a>	N None CTEC23 Power Center Top CTEC24 Power Center Top (See chart on next page)	<a href="#">See Metal Finish Color Options</a>

Model Number Breakdown

LKT3048-26ARY					
LK	T	3048	26	AR	Y
LOK	Laminite	30" x 48"	Height	Arc Rectangular Top Shape	Y Base

Description

Arc Rectangular Table with Y Base at 26" Chat Height (continued)

Veneer Tables "LKV" Models

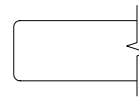

Eased Edge (R3)

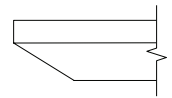

Reverse Bevel Edge (K9)

VENEER	D	W	H	CTN WT	CU FT	① Model	Essentials	Artisan	Essentials	Artisan
	30	48	26	80	29	LKV3048-26ARY	\$2,411	\$2,549	\$2,656	\$2,777
24	48	26	72	24	LKV2448-26ARY	\$2,306	\$2,403	\$2,534	\$2,621	

Electrical Options and Upcharges

CTEC23	
EC23 Power Center Top - Black	CTEC23BL - add \$594
EC23 Power Center Top - White	CTEC23WH - add \$594
CTEC24	
EC24 Power Center Top - Black	CTEC43BL - add \$474
EC24 Power Center Top - White	CTEC43WH - add \$474

To Order Specify

① Veneer Model #	② Edge Detail	③ Wood Collection	④ Wood Finish	⑤ Electrical	⑥ Metal Color
Veneer (LKV)	R3 Eased K9 Reverse Bevel	Essentials	<a href="#">See Essentials Wood Finish Options</a>	N None CTEC23 Power Center Top CTEC24 Power Center Top (See chart above)	<a href="#">See Metal Finish Color Options</a>
		Artisan	④ Wood Finish <a href="#">See Artisan Wood Finish Options</a>		

Description

Rounded Arc Rectangular Table with Y Base at 26" Chat Height

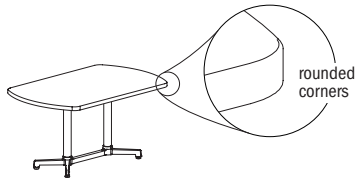

Laminate Tables  
"LKT" Models

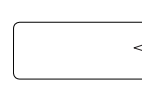

Eased Edge (R3)

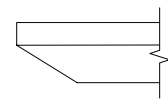

Reverse Bevel Edge (K9)

LAMINATE	D	W	H	CTN WT	CU FT	Model	Standard Tier 1	Graded In Tier 2	Standard Tier 1	Graded In Tier 2
	30	48	26	80	29	LKT3048-26ARRY	\$2,084	\$2,107	\$2,645	\$2,668
	24	48	26	77	24	LKT2448-26ARRY	\$1,969	\$1,989	\$2,520	\$2,536

Features:

- price reflects complete table - top and base
- ships KD in multiple cartons
- model includes adjustable glide
- power cord is routed outside base column
- order vertical wire manager separately; see page 454

Options:

- specify power unit option; None (N), add \$594 for EC23 (CTEC23), add \$474 for EC24 (CTEC24)

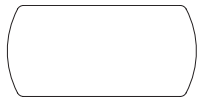

top shape

To Order Specify

1 Laminate Model #	2 Edge Detail	3 Laminate Selection	3a PVC Edge Color	4 Electrical	5 Metal Color
Laminate (LKT)	<a href="#">See Edge Detail Options</a>	<a href="#">See Laminate Selection</a>	<a href="#">See PVC Edge Color Options</a>	N None CTEC23 Power Center Top CTEC24 Power Center Top (See chart on next page)	<a href="#">See Metal Finish Color Options</a>

Model Number Breakdown

LKT3048-26ARRY						
LK	T	3048	26	AR	R	Y
LOK	Laminate	30" x 48"	Height	Arc Rectangular Top Shape	Rounded Corner	Y Base

Description

Rounded Arc Rectangular Table with Y Base at 26" Chat Height (continued)

Veneer Tables "LKV" Models      Solid Surface Tables "LKS" Models

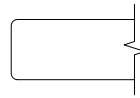

Eased Edge (R3)

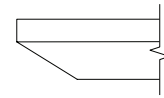

Reverse Bevel Edge (K9)

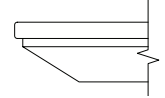

Reverse Bevel Edge (S7)

	D	W	H	CTN WT	CU FT	① Model	Veneer Tables "LKV" Models		Solid Surface Tables "LKS" Models		
							Essentials	Artisan	Essentials	Artisan	Standard
VENEER	30	48	26	80	29	LKV3048-26ARRY	\$2,411	\$2,549	\$2,656	\$2,777	--
	24	48	26	77	24	LKV2448-26ARRY	\$2,306	\$2,403	\$2,534	\$2,621	--
SOL. SURF.	30	48	26	80	29	LKS3048-26ARRY	--	--	--	--	\$4,889
	24	48	26	77	24	LKS2448-26ARRY	--	--	--	--	\$3,814

Electrical Options and Upcharges

CTEC23	
EC23 Power Center Top - Black	CTEC23BL - add \$594
EC23 Power Center Top - White	CTEC23WH - add \$594
CTEC24	
EC24 Power Center Top - Black	CTEC43BL - add \$474
EC24 Power Center Top - White	CTEC43WH - add \$474

To Order Specify

① Veneer Model #	② Edge Detail	③ Wood Collection	④ Wood Finish	⑤ Electrical	⑥ Metal Color
Veneer (LKV)	<a href="#">See Edge Detail Options</a>	Essentials	<a href="#">See Essentials Wood Finish Options</a>	N None CTEC23 Power Center Top CTEC24 Power Center Top (See chart above)	<a href="#">See Metal Finish Color Options</a>
		Artisan	<a href="#">See Artisan Wood Finish Options</a>		

① Solid Surface Model #	② Top Surface Selection	③ Electrical Cut Out	④ Metal Color
Solid Surface (LKS)	<a href="#">See Solid Surface Top Surface Selection Options</a>	N None CTEC23 Power Center Top CTEC24 Power Center Top (See chart above)	<a href="#">See Metal Finish Color Options</a>

LOK - LOUNGE

Description

Oval Table with Y Base at 26" Chat Height



Laminate Tables  
"LKT" Models

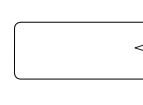

Eased Edge (R3)

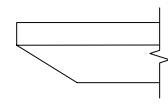

Reverse Bevel Edge (K9)

LAMI	D	W	H	CTN WT	CU FT	Model	Standard Tier 1	Graded In Tier 2	Standard Tier 1	Graded In Tier 2
		30	48	26	74	29	LKT3048-260VY	\$2,064	\$2,090	\$2,625

Features:

- price reflects complete table - top and base
- ships KD in multiple cartons
- model includes adjustable glide
- power cord is routed outside base column
- order vertical wire manager separately; see page 454

Options:

- specify power unit option; None (N), add \$594 for EC23 (CTEC23), add \$474 for EC24 (CTEC24)

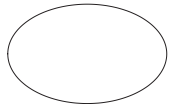

top shape

To Order Specify

1 Laminate Model #	2 Edge Detail	3 Laminate Selection	3a PVC Edge Color	4 Electrical	5 Metal Color
Laminate (LKT)	<a href="#">See Edge Detail Options</a>	<a href="#">See Laminate Selection</a>	<a href="#">See PVC Edge Color Options</a>	N None CTEC23 Power Center Top CTEC24 Power Center Top (See chart on next page)	<a href="#">See Metal Finish Color Options</a>

Model Number Breakdown

LKT3048-260VY					
LK	T	3048	26	OV	Y
LOK	Laminate	30" x 48"	Height	Oval Top Shape	Y Base

Description

Oval Table with Y Base at 26"  
 Chat Height  
 (continued)

Veneer Tables  
 "LKV" Models

Solid Surface Tables  
 "LKS" Models

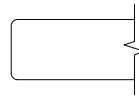

Eased Edge (R3)

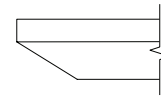

Reverse Bevel Edge (K9)

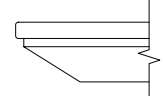

Reverse Bevel Edge (S7)

VEN.	D	W	H	CTN WT	CU FT	① Model	Veneer Tables "LKV" Models		Solid Surface Tables "LKS" Models		
							Essentials	Artisan	Essentials	Artisan	Standard
	30	48	26	74	29	LKV3048-260VY	\$2,396	\$2,529	\$2,639	\$2,759	--
S.S.	30	48	26	74	29	LKS3048-260VY	--	--	--	--	\$4,871

Electrical Options and Upcharges

CTEC23	
EC23 Power Center Top - Black	CTEC23BL - add \$594
EC23 Power Center Top - White	CTEC23WH - add \$594
CTEC24	
EC24 Power Center Top - Black	CTEC43BL - add \$474
EC24 Power Center Top - White	CTEC43WH - add \$474

To Order Specify

① Veneer Model #	② Edge Detail	③ Wood Collection	④ Wood Finish	⑤ Electrical	⑥ Metal Color
Veneer (LKV)	<a href="#">See Edge Detail Options</a>	Essentials	<a href="#">See Essentials Wood Finish Options</a>	N None CTEC23 Power Center Top CTEC24 Power Center Top (See chart above)	<a href="#">See Metal Finish Color Options</a>
		Artisan	④ Wood Finish <a href="#">See Artisan Wood Finish Options</a>		

① Solid Surface Model #	② Top Surface Selection	③ Electrical Cut Out	④ Metal Color
Solid Surface (LKS)	<a href="#">See Solid Surface Top Surface Selection Options</a>	N None CTEC23 Power Center Top CTEC24 Power Center Top (See chart above)	<a href="#">See Metal Finish Color Options</a>

LOK - LOUNGE

Description

Round Table with X Base at 26" Chat Height



Laminate Tables "LKT" Models

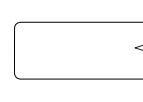

Eased Edge (R3)

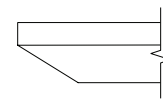

Reverse Bevel Edge (K9)

LAMINATE	D	W	H	CTN WT	CU FT	1 Model	Eased Edge (R3)		Reverse Bevel Edge (K9)	
							Standard Tier 1	Graded In Tier 2	Standard Tier 1	Graded In Tier 2
	42	42	26	77	35	LKT42-26RDX	\$1,654	\$1,788	\$2,180	\$2,313
36	36	26	63	26	LKT36-26RDX	\$1,558	\$1,577	\$2,136	\$2,156	
30	30	26	51	19	LKT30-26RDX	\$1,544	\$1,585	\$2,067	\$2,108	
24	24	26	41	13	LKT24-26RDX	\$1,230	\$1,241	\$1,784	\$1,797	

Features:

- price reflects complete table - top and base
- ships KD in multiple cartons
- model includes adjustable glide
- when electrical option is selected, power accessible base is shipped; see page 417 for details
- power/charging units have 72" cord
- power cord is routed inside base column

Options:

- specify power access base with power unit option; None (N), add \$735 for EC23 (CTEC23), add \$616 for EC24 (CTEC24)

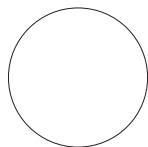

top shape

To Order Specify

1 Laminate Model #	2 Edge Detail	3 Laminate Selection	3a PVC Edge Color	4 Electrical	5 Metal Color
Laminate (LKT)	<a href="#">See Edge Detail Options</a>	<a href="#">See Laminate Selection</a>	<a href="#">See PVC Edge Color Options</a>	N None CTEC23 Power Center Top CTEC24 Power Center Top (See chart on next page)	<a href="#">See Metal Finish Color Options</a>

Model Number Breakdown

LKT42-26RDX					
LK	T	42	26	RD	X
LOK	Laminate	42" dia.	Height	Round Top Shape	X Base

Description

Round Table with X Base at  
26" Chat Height  
(continued)

Veneer Tables  
"LKV" Models

Solid Surface Tables  
"LKS" Models

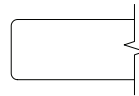

Eased Edge (R3)

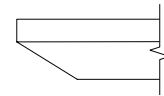

Reverse Bevel Edge (K9)

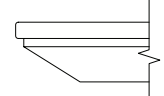

Reverse Bevel Edge (S7)

	D	W	H	CTN WT	CU FT	① Model	Veneer Tables		Solid Surface Tables		
							Essentials	Artisan	Essentials	Artisan	Standard
VENEER	42	42	26	77	35	LKV42-26RDX	\$2,208	\$2,361	\$2,467	\$2,605	--
	36	36	26	63	26	LKV36-26RDX	\$1,908	\$2,024	\$2,153	\$2,256	--
	30	30	26	51	19	LKV30-26RDX	\$1,880	\$1,968	\$2,135	\$2,213	--
	24	24	26	41	13	LKV24-26RDX	\$1,522	\$1,590	\$1,742	\$1,800	--
SOLID SURFACE	42	42	26	99	35	LKS42-26RDX	--	--	--	--	\$5,032
	36	36	26	79	26	LKS36-26RDX	--	--	--	--	\$4,121
	30	30	26	62	19	LKS30-26RDX	--	--	--	--	\$3,722
	24	24	26	48	13	LKS24-26RDX	--	--	--	--	\$3,356

Electrical Options and Upcharges

CTEC23	
EC23 Power Center Top - Black	CTEC23BL - add \$735
EC23 Power Center Top - White	CTEC23WH - add \$735
CTEC24	
EC24 Power Center Top - Black	CTEC43BL - add \$616
EC24 Power Center Top - White	CTEC43WH - add \$616

To Order Specify

① Veneer Model #	② Edge Detail	③ Wood Collection	④ Wood Finish	⑤ Electrical	⑥ Metal Color
Veneer (LKV)	R3 Eased K9 Reverse Bevel	Essentials	<a href="#">See Essentials Wood Finish Options</a>	N None CTEC23 Power Center Top CTEC24 Power Center Top (See chart above)	<a href="#">See Metal Finish Color Options</a>
		Artisan	<a href="#">See Artisan Wood Finish Options</a>		

① Solid Surface Model #	② Top Surface Selection	Electrical Cut Out	Metal Color
Solid Surface (LKS)	<a href="#">See Solid Surface Top Surface Selection Options</a>		

LOK - LOUNGE

Description

Square Table with X Base  
at 26" Chat Height

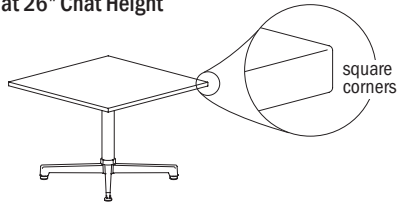

Laminate Tables  
"LKT" Models

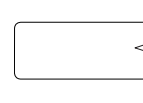

Eased Edge (R3)

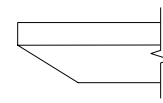

Reverse Bevel Edge (K9)

LAMINATE	D	W	H	CTN WT	CU FT	① Model	Standard Tier 1	Graded In Tier 2	Standard Tier 1	Graded In Tier 2
		36	36	26	73	26	LKT3636-26SQX	\$1,509	\$1,530	\$2,088
	30	30	26	57	19	LKT3030-26SQX	\$1,454	\$1,474	\$2,076	\$2,092
	24	24	26	45	13	LKT2424-26SQX	\$1,172	\$1,182	\$1,717	\$1,729

Features:

- price reflects complete table - top and base
- ships KD in multiple cartons
- model includes adjustable glide
- when electrical option is selected, power accessible base is shipped; see page 417 for details
- power/charging units have 72" cord
- power cord is routed inside base column

Options:

- specify power access base with power unit option; None (N), add \$735 for EC23 (CTEC23), add \$616 for EC24 (CTEC24)

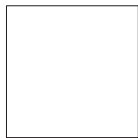

top shape

To Order Specify

① Laminate Model #	② Edge Detail	③ Laminate Selection	④ PVC Edge Color	⑤ Electrical	⑥ Metal Color
Laminate (LKT)	<a href="#">See Edge Detail Options</a>	<a href="#">See Laminate Selection</a>	<a href="#">See PVC Edge Color Options</a>	N None CTEC23 Power Center Top CTEC24 Power Center Top (See chart on next page)	<a href="#">See Metal Finish Color Options</a>

Model Number Breakdown

LKT3636-26SQX					
LK	T	3636	26	SQ	X
LOK	Laminate	36" x 36"	Height	Square Top Shape	X Base

Description

Square Table with X Base  
at 26" Chat Height  
(continued)

Veneer Tables  
"LKV" Models

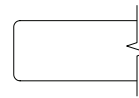

Eased Edge (R3)

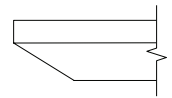

Reverse Bevel Edge (K9)

VENEER	D	W	H	CTN WT	CU FT	① Model	Essentials	Artisan	Essentials	Artisan
	36	36	26	73	26	LKV3636-26SQX	\$1,859	\$1,974	\$2,105	\$2,204
	30	30	26	57	19	LKV3030-26SQX	\$1,832	\$1,923	\$2,087	\$2,162
	24	24	26	45	13	LKV2424-26SQX	\$1,472	\$1,528	\$1,689	\$1,734

Electrical Options and Upcharges

CTEC23	
EC23 Power Center Top - Black	CTEC23BL - add \$735
EC23 Power Center Top - White	CTEC23WH - add \$735
CTEC24	
EC24 Power Center Top - Black	CTEC43BL - add \$616
EC24 Power Center Top - White	CTEC43WH - add \$616

To Order Specify

① Veneer Model #	② Edge Detail	③ Wood Collection	④ Wood Finish	⑤ Electrical	⑥ Metal Color
Veneer (LKV)	R3 Eased K9 Reverse Bevel	Essentials	<a href="#">See Essentials Wood Finish Options</a>	N None CTEC23 Power Center Top CTEC24 Power Center Top (See chart above)	<a href="#">See Metal Finish Color Options</a>
	Artisan	④ Wood Finish <a href="#">See Artisan Wood Finish Options</a>			

Description

Rounded Square Table with X Base at 26" Chat Height

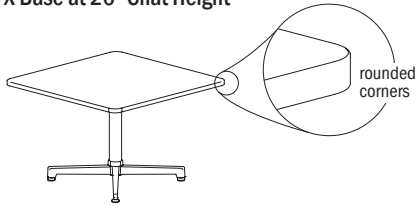

Laminate Tables  
"LKT" Models

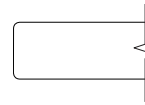

Eased Edge (R3)

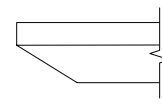

Reverse Bevel Edge (K9)

LAMINATE	D	W	H	CTN WT	CU FT	1 Model	Standard Tier 1	Graded In Tier 2	Standard Tier 1	Graded In Tier 2
	36	36	26	73	26	LKT3636-26SQRX	\$1,558	\$1,577	\$2,136	\$2,156
	30	30	26	57	19	LKT3030-26SQRX	\$1,544	\$1,585	\$2,067	\$2,108
24	24	26	45	13	LKT2424-26SQRX	\$1,230	\$1,241	\$1,784	\$1,797	

Features:

- price reflects complete table - top and base
- ships KD in multiple cartons
- model includes adjustable glide
- when electrical option is selected, power accessible base is shipped; see page 417 for details
- power/charging units have 72" cord
- power cord is routed inside base column

Options:

- specify power access base with power unit option; None (N), add \$735 for EC23 (CTEC23), add \$616 for EC24 (CTEC24)

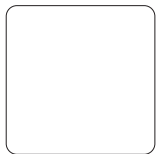

top shape

To Order Specify

1 Laminite Model #	2 Edge Detail	3 Laminite Selection	3a PVC Edge Color	4 Electrical	5 Metal Color
Laminite (LKT)	<a href="#">See Edge Detail Options</a>	<a href="#">See Laminite Selection</a>	<a href="#">See PVC Edge Color Options</a>	N None CTEC23 Power Center Top CTEC24 Power Center Top (See chart on next page)	<a href="#">See Metal Finish Color Options</a>

Model Number Breakdown

LKT3636-26SQRX						
LK	T	3636	26	SQ	R	X
LOK	Laminite	36" x 36"	Height	Square Top Shape	Rounded Corner	X Base

Description

Rounded Square Table with X Base at 26" Chat Height (continued)

Veneer Tables "LKV" Models

Solid Surface Tables "LKS" Models

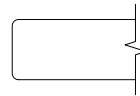

Eased Edge (R3)

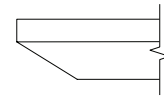

Reverse Bevel Edge (K9)

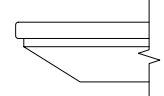

Reverse Bevel Edge (S7)

	D	W	H	CTN WT	CU FT	① Model	Veneer Tables "LKV" Models		Solid Surface Tables "LKS" Models		
							Essentials	Artisan	Essentials	Artisan	Standard
VENEER	36	36	26	73	26	LKV3636-26SQRX	\$1,908	\$2,024	\$2,153	\$2,256	--
	30	30	26	57	19	LKV3030-26SQRX	\$1,880	\$1,968	\$2,135	\$2,213	--
	24	24	26	45	13	LKV2424-26SQRX	\$1,522	\$1,590	\$1,742	\$1,800	--
SOLID SURFACE	36	36	26	94	26	LKS3636-26SQRX	--	--	--	--	\$4,121
	30	30	26	72	19	LKS3030-26SQRX	--	--	--	--	\$3,722
	24	24	26	54	13	LKS2424-26SQRX	--	--	--	--	\$3,356

Electrical Options and Upcharges

CTEC23	
EC23 Power Center Top - Black	CTEC23BL - add \$735
EC23 Power Center Top - White	CTEC23WH - add \$735
CTEC24	
EC24 Power Center Top - Black	CTEC43BL - add \$616
EC24 Power Center Top - White	CTEC43WH - add \$616

To Order Specify

① Veneer Model #	② Edge Detail	③ Wood Collection	④ Wood Finish	⑤ Electrical	⑥ Metal Color
Veneer (LKV)	R3 Eased K9 Reverse Bevel	Essentials	<a href="#">See Essentials Wood Finish Options</a>	N None CTEC23 Power Center Top CTEC24 Power Center Top (See chart above)	<a href="#">See Metal Finish Color Options</a>
	Artisan	④ Wood Finish <a href="#">See Artisan Wood Finish Options</a>			

① Solid Surface Model #	② Top Surface Selection	Electrical Cut Out	Metal Color
Solid Surface (LKS)	<a href="#">See Solid Surface Top Surface Selection Options</a>		

LOK - LOUNGE

Description

Squircle Table with X Base  
at 26" Chat Height



Laminate Tables  
"LKT" Models

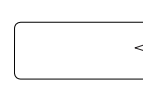

Eased Edge (R3)

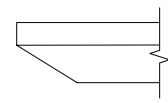

Reverse Bevel Edge (K9)

LAMINATE	D	W	H	CTN WT	CU FT	Model	Eased Edge (R3)		Reverse Bevel Edge (K9)	
							Standard	Graded In	Standard	Graded In
							Tier 1	Tier 2	Tier 1	Tier 2
	36	36	26	73	26	LKT36-26SCX	\$1,558	\$1,577	\$2,136	\$2,156
	30	30	26	57	19	LKT30-26SCX	\$1,544	\$1,585	\$2,067	\$2,108
	24	24	26	45	13	LKT24-26SCX	\$1,230	\$1,241	\$1,784	\$1,797

Features:

- price reflects complete table - top and base
- ships KD in multiple cartons
- model includes adjustable glide
- when electrical option is selected, power accessible base is shipped; see page 417 for details
- power/charging units have 72" cord
- power cord is routed inside base column

Options:

- specify power access base with power unit option; None (N), add \$735 for EC23 (CTEC23), add \$616 for EC24 (CTEC24)

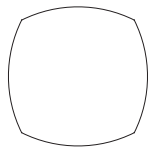

top shape

To Order Specify

1 Laminite Model #	2 Edge Detail	3 Laminite Selection	3a PVC Edge Color	4 Electrical	5 Metal Color
Laminite (LKT)	<a href="#">See Edge Detail Options</a>	<a href="#">See Laminite Selection</a>	<a href="#">See PVC Edge Color Options</a>	N None CTEC23 Power Center Top CTEC24 Power Center Top (See chart on next page)	<a href="#">See Metal Finish Color Options</a>

Model Number Breakdown

LKT36-26SCX					
LK	T	36	26	SC	X
LOK	Laminite	36"	Height	Squircle Top Shape	X Base

Description

Squirrel Table with X Base  
at 26" Chat Height  
(continued)

Veneer Tables  
"LKV" Models

Solid Surface Tables  
"LKS" Models

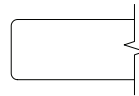

Eased Edge (R3)

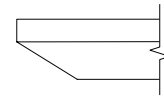

Reverse Bevel Edge (K9)

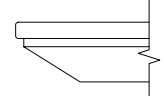

Reverse Bevel Edge (S7)

	D	W	H	CTN WT	CU FT	① Model	Veneer Tables		Solid Surface Tables		
							Essentials	Artisan	Essentials	Artisan	Standard
VENEER	36	36	26	73	26	LKV36-26SCX	\$1,908	\$2,024	\$2,153	\$2,256	--
	30	30	26	57	19	LKV30-26SCX	\$1,880	\$1,968	\$2,135	\$2,213	--
	24	24	26	45	13	LKV24-26SCX	\$1,522	\$1,590	\$1,742	\$1,800	--
SOLID SURFACE	36	36	26	94	26	LKS36-26SCX	--	--	--	--	\$4,121
	30	30	26	72	19	LKS30-26SCX	--	--	--	--	\$3,722
	24	24	26	54	13	LKS24-26SCX	--	--	--	--	\$3,356

Electrical Options and Upcharges

CTEC23	
EC23 Power Center Top - Black	CTEC23BL - add \$735
EC23 Power Center Top - White	CTEC23WH - add \$735
CTEC24	
EC24 Power Center Top - Black	CTEC43BL - add \$616
EC24 Power Center Top - White	CTEC43WH - add \$616

To Order Specify

① Veneer Model #	② Edge Detail	③ Wood Collection	④ Wood Finish	⑤ Electrical	⑥ Metal Color
Veneer (LKV)	R3 Eased K9 Reverse Bevel	Essentials	<a href="#">See Essentials Wood Finish Options</a>	N None CTEC23 Power Center Top CTEC24 Power Center Top (See chart above)	<a href="#">See Metal Finish Color Options</a>
	Artisan	④ Wood Finish	<a href="#">See Artisan Wood Finish Options</a>		

① Solid Surface Model #	② Top Surface Selection	Electrical Cut Out	Metal Color
Solid Surface (LKS)	<a href="#">See Solid Surface Top Surface Selection Options</a>		

LOK - LOUNGE

Description	D	W	H	CTN WT	CU FT	① Model	List Price
Power Strip	1 1/2	1 7/8	8	3	1	GP9ACP1-0212	\$103

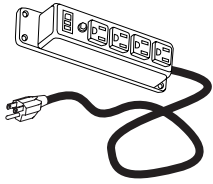

**Features:**

- power surge with 10' cord
- four electrical outlets
- includes switch
- field installed

Wire Management Velcro Straps	1 3/4	3 1/2	1/4	1	1	04WVS	\$63
-------------------------------	-------	-------	-----	---	---	-------	------

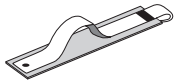

**Features:**

- black, set of 4
- field installed to bottom of table top, with adhesive tape provided

Cable Management Clips	2 5/8	3 3/4	1 5/8	1	1	0304CMC	\$61
------------------------	-------	-------	-------	---	---	---------	------

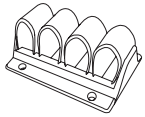

**Features:**

- black plastic
- installed to bottom of table top
- four retention loops

**To Order, Specify:**

① Model Number	
----------------	--

**Accessories/ Keyboard/ Tasklights**

For an additional list of electrical units, grommets, keyboards, wire management, monitor arms & telecom jacks, please see our [accessories price list](#)

Contact your customer service representative for specific questions regarding which units can be used with Lok Lounge.

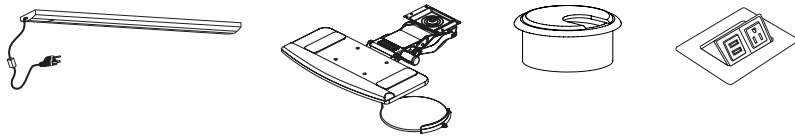



# Formica Laminate

Nosh offers an extensive program for laminates beyond our Standard Program. Always reference below the most current listing and tier pricing when using a Graded-In Laminate; on page NS3 select the color of the PVC edge color.

Laminate	Pattern-Sheen	Tier	Laminate	Pattern-Sheen	Tier	Laminate	Pattern-Sheen	Tier	Laminate	Pattern-Sheen	Tier
Acajou Mahogany	7008-58	2	Dark Chocolate	2200-58	2	Mission White	933-58	2	Smoke Onyx	3710-58	2
Aged Ash	8844-58	2	Denim	8822-58	2	Mocha Travertine	3456-58	2	Smoke Quarstone	6220-58	2
Algae	8796-58	2	Desert Beige	899-58	2	Mojave	8751-58	2	Smokey Brown Pear	5488-58	2
Almond	920-58	2	Dover White	7197-58	2	Moonstone	7872-58	2	Solar Orange	8235-58	2
Aluminum	9318-58	2	Earth	5342-58	2	Mouse	928-58	2	Sorrel Cherry	5886-58	2
Amber Kashmir	6227-58	2	Earth Wash	7213-58	2	Muslin Fabric	6127-58	2	Spectrum Blue	851-58	2
Amber Maple	7012-58	2	Earthen Twill	8828-58	2	Natural Ash	8843-58	2	Spectrum Green	7897-58	2
Antique White	932-58	2	Earthen Warp	5880-58	2	Natural Birch	7481-58	2	Spectrum Red	845-58	2
Argento Romano	6697-58	2	Earthenware	8241-58	2	Natural Canvas	7022-58	2	Stainless	9319-58	2
Artichoke	800-58	2	Earthenware	6999-58	2	Natural Gray Felt	4971-58	2	Star Dune	9309-58	2
Ashwood Beige	5785-58	2	Brushstroke		2	Natural Maple	756-58	2	Starched Paperfold	8678-58	2
Ashwood Bone	5784-58	2	Ebony	9012-58	2	Natural Oak	346-58	2	Stone Grafix	503-58	2
Ashwood Oak	5786-58	2	Ebony Oxide	299-58	2	Natural Recycled Kraft	9684-58	2	Stop Red	839-58	2
Basalt Slate	3690-58	2	Elemental Concrete	8830-58	2	Natural Riftwood	9282-58	2	Storm	912-58	2
Beige Elm	5794-58	2	Elemental Stone	8831-58	2	Natural Teak	8849-58	2	Storm Solidz	3505-58	2
Belmonte Granite	3496-58	2	Espresso Pear	5489-58	2	Navy Blue	969-58	2	Storm Teakwood	8908-58	2
Birchbark	8684-58	2	Finnish Oak	118-58	2	Navy Grafix	7018-58	2	Sugar Glass	3705-58	2
Black	909-58	2	Flax Gauze	7708-58	2	Neo Cloud	6314-58	2	Surf	923-58	2
Black Bardiglio	5019-58	2	Flint Crystal	3518-58	2	Neutral Twill	8826-58	2	Swede Rift Oak	8676-58	2
Black Birchply	8552-58	2	Fog	961-58	2	Neutral Weft	5875-58	2	Taupe Walnut	5787-58	2
Black Recycled Kraft	9685-58	2	Folkstone	927-58	2	Neutral White	918-58	2	Terril	2297-58	2
Black Riftwood	6414-58	2	Folkstone Celesta	692-58	2	New Burgundy	7966-58	2	Thermo Walnut	6402-58	2
Black Shalestone	9527-58	2	Folkstone Grafix	507-58	2	Night Forest	8244-58	2	Travertine	3526-58	2
Black Walnut	3485-58	2	Formal Walnut	5782-58	2	Night Shade	8243-58	2	Tula Oak	8589-58	2
Blackened Fiberwood	8916-58	2	Fossil	5349-58	2	Noble Mahogany	9236-58	2	Venetian Gold Granite	6223-58	2
Blackened Legno	8848-58	2	Fox Teakwood	8907-58	2	Nocturne	5323-58	2	Vibrant Green	6901-58	2
Blackened Steel	8918-58	2	Geriba Gray	9308-58	2	Noir Cedar	1547-58	2	Walnut Butcherblock	3712-58	2
Blackstone	271-58	2	Ginger Root Maple	7288-58	2	Noir Envision	7500-58	2	Walnut Fiberwood	8915-58	2
Bleached Legno	8845-58	2	Glamour Cherry	6208-58	2	Nut Brown Cherry	5790-58	2	Walnut Riftwood	9283-58	2
Blond Cedar	8576-58	2	Glass Cloth	8683-58	2	Oiled Legno	8846-58	2	Walnut Softwood	4925-58	2
Blossom Cherrywood	758-58	2	Gold Braze	1193-58	2	Oiled Walnut	5487-58	2	Washi Paperfold	8680-58	2
Blue Felt	9320-58	2	Graphite	837-58	2	Orange Felt	4973-58	2	Waxed Maple	8905-58	2
Blush	8238-58	2	Graphite Elm	5796-58	2	Origami Paperfold	8679-58	2	Weathered Ash	8842-58	2
Brazilian Brown Granite	6222-58	2	Graphite Grafix	515-58	2	Otter	3202-58	2	Weathered Fiberwood	8914-58	2
Brite White	459-58	2	Graphite Twill	8829-58	2	Oxidized Beamwood	9484-58	2	Wenge Strand	6306-58	2
Bronzed Steel	8919-58	2	Gray Fabric	6129-58	2	Oyster Grey	929-58	2	Wheat Strand	6212-58	2
Bubble Art	8958-58	2	Gray Grafix	9300-58	2	Pale Brushstroke	6997-58	2	White	949-58	2
Buff Elm	5793-58	2	Gray Onyx	7409-58	2	Paloma Polar	6698-58	2	White Ash	8841-58	2
Burnished Coin	3708-58	2	Grayed Oak	5791-58	2	Patine Bronze	3707-58	2	White Bardiglio	9306-58	2
Burnished Iron	3709-58	2	Graystone	464-58	2	Patine Concrete	3706-58	2	White Drops	8824-58	2
Burnt Strand	6307-58	2	Green Felt	4974-58	2	Pearl	934-58	2	White Ice Granite	9476-58	2
Butterum Granite	7732-58	2	Green Slate	8793-58	2	Pecan Walnut	6996-58	2	White Marble	9310-58	2
Camel Elm	5795-58	2	Greige Softwood	4924-58	2	Pecan Woodline	5883-58	2	Herringbone		2
Cardboard Solidz	7813-58	2	Gull Grey	9242-58	2	Pencil Wood	7747-58	2	White Onyx	827-58	2
Carrara Bianco	6696-58	2	Hard Rock Maple	86992-58	2	Perlato Granite	3522-58	2	White Painted Wood	8902-58	2
Carrara Envision	7494-58	2	Hazel Walnut	5788-58	2	Planked Coffee Oak	7413-58	2	White Pearl Cascade	3720-58	2
Cascara Teakwood	8909-58	2	Ice Onyx	7408-58	2	Planked Deluxe Pear	6206-58	2	White Shalestone	9525-58	2
Cassis	6903-58	2	Inked Oak	5792-58	2	Planked Raw Oak	7412-58	2	White Thewill	9285-58	2
Ceruse Gray Walnut	6994-58	2	Ivory Kashmir	6226-58	2	Planked Urban Oak	9312-58	2	White Washed	6372-58	2
Chambray Fabric	6130-58	2	Jadeite	1198-58	2	Platinum	902-58	2	Birchply		2
Charcoal Boomerang	6942-58	2	Jamocho Granite	7734-58	2	Portico Marble	7735-58	2	Wild Cherry	5904-58	2
Chelsea Maple	9238-58	2	Just Rose	8858-58	2	Prestige Walnut	6209-58	2	Winter Sky	8792-58	2
Cherry Heartwood	9240-58	2	Labrador Granite	3692-58	2	Pumice	858-58	2	Wood Brushstroke	6998-58	2
Cherry Walnut	6995-58	2	Layered Black Sand	9510-58	2	Purple Dye	1196-58	2	Woolen Cloth	8682-58	2
Chestnut Woodline	5884-58	2	Layered Sand	9511-58	2	Raw Birchply	8910-58	2	Yellow Felt	4972-58	2
Chrome Yellow	1485-58	2	Layered White Sand	9512-58	2	Raw Cedar	1545-58	2			
Cinnamon Cherry	8955-58	2	Lime Stone	7264-58	2	Sail White	463-58	2			
Citadel	1097-58	2	Liquid Glass	8240-58	2	Sand Crystal	3517-58	2			
Citadel Warp	5882-58	2	Luxe Mango	8685-58	2	Sand Maple	9237-58	2			
Classic White	9244-58	2	Macchiato Walnut	6932-58	2	Sarum Grey	2770-58	2			
Clementine	2962-58	2	Maple Woodline	6925-58	2	Sarum Twill	8827-58	2			
Clove Spice Cherry	5789-58	2	Marine Blue	914-58	2	Scandi Rift Oak	8677-58	2			
Cocoa Maple	7739-58	2	Marmara Beige	7406-58	2	Sea Salt	9529-58	2			
Cocoa Oak	9374-58	2	Marmara Gray	7407-58	2	Seasoned Planked Elm	6477-58	2			
Cognac Maple	7738-58	2	Matrix Blue	8795-58	2	Select Cherry	7759-58	2			
Concrete Formwood	6362-58	2	Mdf Solidz	7812-58	2	Sheer Fabric	6126-58	2			
Concrete Stone	7267-58	2	Midnight Stone	6280-58	2	Silver Quartzite	9497-58	2			
Cotton Cloth	8681-58	2	Milk	9634-58	2	Silver Riftwood	6413-58	2			
Cream Softwood	4923-58	2	Millennium Oak	5887-58	2	Silver Shalestone	9307-58	2			
Danish Maple	8906-58	2	Mineral Jet	3450-58	2	Slate Noir	3711-58	2			
			Mineral Spa	6920-58	2	Smoke	3245-58	2			

## Wilsonart Laminate

Nosh offers an extensive program for laminates beyond our Standard Program. Always reference below the most current listing and tier pricing when using a Graded-In Laminate; see below on the PVC edge color selection.

Laminate	Pattern-Sheen	Tier	Laminate	Pattern-Sheen	Tier	Laminate	Pattern-Sheen	Tier	Laminate	Pattern-Sheen	Tier
Almond Leather	2932-60	2	Florence Walnut	7993-38	2	Lowell Ash	7994-38	2	Port	D14-60	2
Anitique White	1572-60	2	Fonthill Pear	10745-60	2	Mangalore Mango	7984-38	2	Pressed Linen	4991-38	2
Anzio Marble	5037-38	2	Forged Steel	4995-60	2	Manitoba Maple	7911-60	2	Raw Cotton	4947-38	2
Atlantis	D25-60	2	Fossil Shale	D504-60	2	Midnight	D505-60	2	River Cherry	7937-38	2
Bannister Oak	7806-60	2	French Linen	5016-38	2	Mission Maple	7990-38	2	Rustic Slate	4888-38	2
Beige	1530-60	2	French Pear	8220-38	2	Misted Zephyr	4843-60	2	Sable Soapstone	4883-38	2
Beigewood	7850-60	2	Frosty White	1573-60	2	Monticello Maple	7925-38	2	Sap Walnut	8221-38	2
Boardwalk Oak	7983-38	2	Fusion Maple	7909-60	2	Morelia Maple	7985-38	2	Shadow Zephyr	4857-60	2
Brazilwood	7946-38	2	Graphite	10657-60	2	Morro Zephyr	4846-60	2	Sheer Mesh	4876-38	2
Brittany Blue	D321-60	2	Graphite Nebula	4623-60	2	Natural Almond	D30-60	2	Sierra Cascade	5005-38	2
Bronze Legacy	4656-60	2	Green Tigris	4667-60	2	Natural Cotton	4946-38	2	Silicon Ev	4811-60	2
Buka Bark	7982-38	2	Grey	1500-60	2	Natural Recon	7996-38	2	Solar Oak	7816-60	2
Burnished Chestnut	4796-60	2	Grey Glace	4142-60	2	Natural Rift	7954-38	2	Steel Mesh	4879-38	2
Candy Apple	13096-60	2	Grey Mesh	4877-38	2	Natural Tigris	4669-60	2	Sterling Ash	7995-38	2
Canyon Zephyr	4842-60	2	Grey Nebula	4622-60	2	Navy Legacy	4651-60	2	Sunny Side Up	13089-60	2
Carbon Ev	4820-60	2	Grey Pampas	4168-60	2	Neo Walnut	7991-38	2	Tailored Linen	4992-38	2
Carbon Mesh	4880-60	2	Gumball	13102-60	2	Neutral Glace	4143-60	2	Titanium EV	4810-60	2
Castle Oak	7928-38	2	Handspun Chestnut	5036-38	2	New Age Oak	7938-38	2	Tungsten EV	4814-60	2
Casual Linen	4944-38	2	Handspun Dove	5034-38	2	Nordic Linen	5015-38	2	Tuscan Walnut	7921-38	2
Catalina	13092-60	2	Handspun Pearl	5033-38	2	Nori	13091-60	2	Twilight Zephyr	4845-60	2
Cement	D503-60	2	Hanspun Slate	5035-38	2	North Sea	D90-60	2	Wallaby	D439-60	2
Centizo Cherry	8239-38	2	Harvest Maple	7953-38	2	Norwegian Ash	8241-38	2	Washi Crystal	5017-38	2
Classic Linen	4843-38	2	high Rise	4996-38	2	Oiled Soapstone	4882-38	2	Washi Pewter	5018-38	2
Cloud Nebula	4830-60	2	Hollyberry	D307-60	2	Orange Grove	D501-60	2	White	1570-60	2
Cloud Zephyr	4856-60	2	Huntington Mplae	7929-38	2	Organic Cotton	4945-38	2	White Carrara	4924-38	2
Coffee Bean	D495-60	2	Indigo	D379-60	2	Palisades Oak	7987-38	2	White Cascade	5003-38	2
Crisp Linen	4942-38	2	Invory Birch	8219-38	2	Pampas	4170-60	2	White Nebula	4621-60	2
Crystal	D388-60	2	Jubilee Oak	8242-38	2	Pasadena Oak	7966-38	2	White Sand	D403-60	2
Desert Zephyr	4841-60	2	Kensington Maple	10776-60	2	Pearl Soapstone	4886-38	2	White Tigris	4783-60	2
Dove Grey	D92-60	2	Khaki Brown	D50-60	2	Pepperdust	D327-60	2	Wild Cherry	7054-60	2
Dragon Fly	13088-60	2	Kingswood Walnut	8218-38	2	Pewter	D73-60	2	Windswept Pewter	4795-60	2
Ebony Recon	7997-38	2	Lapis Blue	D417-60	2	Pewter Brush	4779-60	2	Woolamai Brush	4746-60	2
Evening Tigris	4674-60	2	Limber Maple	10734-60	2	Pewter Mesh	4878-38	2			
Fashion Grey	D381-60	2	Linen	D427-60	2	Pinnacle Walnut	7992-38	2			
Flax Linen	4930-38	2	Loden Zephyr	4844-60	2	Platinum	D315-60	2			

### PVC Edge Selection

Tier 2 Laminates require the additional specification of a PVC edge band. Choose from one of the following JSI standard options.

ALB	Alabaster	MES	Mesa
BEL	Belair	MIN	Mineral
BLK	Black	MCH	Mocha
BRK	Brickdust	OBK	Outback
BBL	Bridal Blanco	PIL	Pilsner
CSK	Cask	PIN	Pinnacle Walnut
CLY	Clay	SHD	Shadow
DWH	Designer White	SLG	Slate Grey
EGR	Egret	UMB	Umber
FAW	Fawn	VAL	Valley
FLN	Flint	WLH	Walnut Heights
FLO	Florence Walnut	WEA	Weathered Ash
LOF	Loft	ZEN	Zen Grey