



Training



Teamwork



Conference



Lounge

LOK - TEAMWORK

Lok - Teamwork

Product Information

Teamwork Overview 86
 Tables Shapes & Sizes 88-91
 Laminate Specifications 92
 Veneer Specifications 93
 Base Styles - Features 94
 Electrical Planning - Options 95

Pricing Pages

Teamwork Tables at Working Height . . . 96-129
 Teamwork Tables at Counter Height . . . 130-133
 Teamwork Tables at Bar Height 134-167
 Electrical 168-169

Teamwork - Overview



rectangular
29"H - Pages 68, 72
36"H - Pages 116, 120
42"H - Pages 164, 168



rounded rectangular
29"H - Pages 70, 74
36"H - Pages 118, 122
42"H - Pages 166, 170



arc rectangular
29"H - Pages 76
36"H - Pages 124
42"H - Pages 172



rounded arc rectangular
29"H - Pages 78
36"H - Pages 126
42"H - Pages 174



racetrack
29"H - Pages 80
36"H - Pages 128
42"H - Pages 176

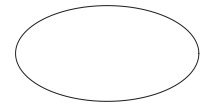

oval
29"H - Pages 82
36"H - Pages 130
42"H - Pages 178

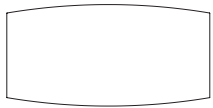

boat
29"H - Pages 84
36"H - Pages 132
42"H - Pages 180

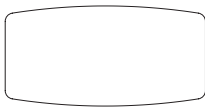

rounded boat
29"H - Pages 86
36"H - Pages 134
42"H - Pages 182

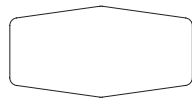

rounded double chevron
29"H - Pages 88
36"H - Pages 136
42"H - Pages 184

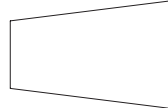

taper
29"H - Pages 90
36"H - Pages 138
42"H - Pages 186

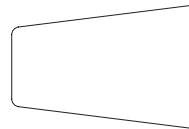

rounded taper
29"H - Pages 92
36"H - Pages 138
42"H - Pages 184

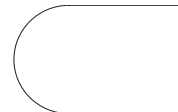

bullet
29"H - Pages 94
36"H - Pages 142
42"H - Pages 190

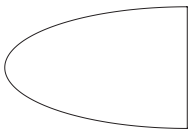

hive
29"H - Pages 96
36"H - Pages 144
42"H - Pages 192

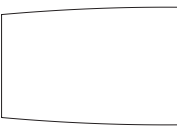

wedge
29"H - Pages 112
36"H - Pages 160
42"H - Pages 208

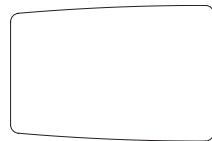

rounded wedge
29"H - Pages 114
36"H - Pages 162
42"H - Pages 210

Teamwork - Top Shapes

Lok offers 24 teamwork table top shapes. Tables are available in 29", 36" or 42" high and in laminate or veneer. Compatible bases are: T Base or X Base



rectangular

29"h

- 36" x 60" Seats 4
- 36" x 66" Seats 6
- 36" x 72" Seats 6
- 42" x 72" Seats 6
- 48" x 72" Seats 6

36"h

- 36" x 60" Seats 4
- 36" x 66" Seats 6
- 36" x 72" Seats 6
- 42" x 72" Seats 6
- 48" x 72" Seats 6

42"h

- 36" x 60" Seats 4
- 36" x 66" Seats 6
- 36" x 72" Seats 6
- 42" x 72" Seats 6
- 48" x 72" Seats 6



rounded rectangular

29"h

- 36" x 60" Seats 4
- 36" x 66" Seats 6
- 36" x 72" Seats 6
- 42" x 72" Seats 6
- 48" x 72" Seats 6

36"h

- 36" x 60" Seats 4
- 36" x 66" Seats 6
- 36" x 72" Seats 6
- 42" x 72" Seats 6
- 48" x 72" Seats 6

42"h

- 36" x 60" Seats 4
- 36" x 66" Seats 6
- 36" x 72" Seats 6
- 42" x 72" Seats 6
- 48" x 72" Seats 6



arc rectangular

29"h

- 36" x 60" Seats 4
- 36" x 66" Seats 6
- 36" x 72" Seats 6
- 42" x 72" Seats 6
- 48" x 72" Seats 6

36"h

- 36" x 60" Seats 4
- 36" x 66" Seats 6
- 36" x 72" Seats 6
- 42" x 72" Seats 6
- 48" x 72" Seats 6

42"h

- 36" x 60" Seats 4
- 36" x 66" Seats 6
- 36" x 72" Seats 6
- 42" x 72" Seats 6
- 48" x 72" Seats 6



rounded arc rectangular

29"h

- 36" x 60" Seats 4
- 36" x 66" Seats 6
- 36" x 72" Seats 6
- 42" x 72" Seats 6
- 48" x 72" Seats 6

36"h

- 36" x 60" Seats 4
- 36" x 66" Seats 6
- 36" x 72" Seats 6
- 42" x 72" Seats 6
- 48" x 72" Seats 6

42"h

- 36" x 60" Seats 4
- 36" x 66" Seats 6
- 36" x 72" Seats 6
- 42" x 72" Seats 6
- 48" x 72" Seats 6



racetrack

29"h

- 36" x 60" Seats 4
- 36" x 66" Seats 6
- 36" x 72" Seats 6
- 42" x 72" Seats 6
- 48" x 72" Seats 6

36"h

- 36" x 60" Seats 4
- 36" x 66" Seats 6
- 36" x 72" Seats 6
- 42" x 72" Seats 6
- 48" x 72" Seats 6

42"h

- 36" x 60" Seats 4
- 36" x 66" Seats 6
- 36" x 72" Seats 6
- 42" x 72" Seats 6
- 48" x 72" Seats 6

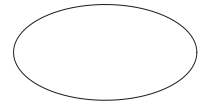

oval

29"h

- 36" x 72" Seats 6

36"h

- 36" x 72" Seats 6

42"h

- 36" x 72" Seats 6

LOK - TEAMWORK

Teamwork - Top Shapes

Lok offers 24 teamwork table top shapes. Tables are available in 29", 36" or 42" high and in laminate or veneer. Compatible bases are: T Base or X Base

LOK - TEAMWORK

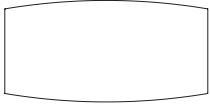

boat
29"h
36" x 60" Seats 4
36" x 66" Seats 6
36" x 72" Seats 6
42" x 72" Seats 6
48" x 72" Seats 6

36"h
36" x 60" Seats 4
36" x 66" Seats 6
36" x 72" Seats 6
42" x 72" Seats 6
48" x 72" Seats 6

42"h
36" x 60" Seats 4
36" x 66" Seats 6
36" x 72" Seats 6
42" x 72" Seats 6
48" x 72" Seats 6

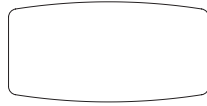

rounded boat
29"h
36" x 60" Seats 4
36" x 66" Seats 6
36" x 72" Seats 6
42" x 72" Seats 6
48" x 72" Seats 6

36"h
36" x 60" Seats 4
36" x 66" Seats 6
36" x 72" Seats 6
42" x 72" Seats 6
48" x 72" Seats 6

42"h
36" x 60" Seats 4
36" x 66" Seats 6
36" x 72" Seats 6
42" x 72" Seats 6
48" x 72" Seats 6

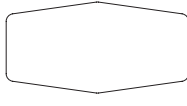

rounded double chevron
29"h
36" x 60" Seats 4
36" x 72" Seats 6
42" x 72" Seats 6
48" x 72" Seats 6

36"h
36" x 60" Seats 4
36" x 72" Seats 6
42" x 72" Seats 6
48" x 72" Seats 6

42"h
36" x 60" Seats 4
36" x 72" Seats 6
42" x 72" Seats 6
48" x 72" Seats 6

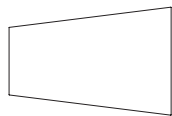

taper
29"h
48" x 72" Seats 6

36"h
48" x 72" Seats 6

42"h
48" x 72" Seats 6

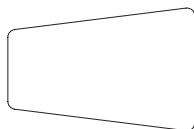

rounded taper
29"h
48" x 72" Seats 6

36"h
48" x 72" Seats 6

42"h
48" x 72" Seats 6

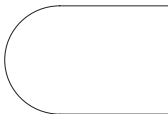

bullet
29"h
48" x 72" Seats 6

36"h
48" x 72" Seats 6

42"h
48" x 72" Seats 6

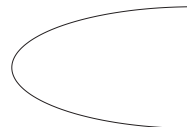

hive
29"h
48" x 72" Seats 6

36"h
48" x 72" Seats 6

42"h
48" x 72" Seats 6

Teamwork - Top Shapes cont.

Lok offers 24 teamwork table top shapes. Tables are available in 29", 36" or 42" high and in laminate or veneer. Compatible bases are: T Base or X Base

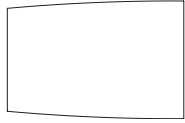

wedge

29"h

48" x 72" Seats 6

36"h

48" x 72" Seats 6

42"h

48" x 72" Seats 6

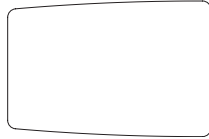

rounded wedge

29"h

48" x 72" Seats 6

36"h

48" x 72" Seats 6

42"h

48" x 72" Seats 6

Teamwork - Materials

Laminate Tops

HPL tops are 1 3/16" thick, 3 ply balanced construction. The laminate face is horizontal grade high pressure laminate. Particle board core and a phenolic backer sheet complete the balanced construction.

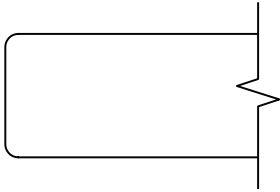

Eased Edge (R3)
PVC

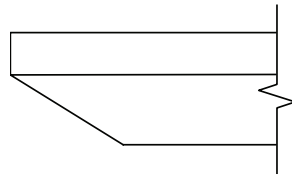

Reverse Bevel (K9)
PVC on painted top of painted MDF

Standard PVC Edge Colors

JSI supports 26 standard PVC edge colors listed below. These coordinate with our Standard (Tier1) Laminates.

When selecting a Standard (Tier 1) Laminate, the coordinating PVC edge color is automatically applied. When selecting a Graded-In Laminate (Tier 2), you will be prompted to choose one these 26 PVC edge colors to be applied to the edge.

ALB Alabaster	MES Mesa
BEL Belair	MIN Mineral
BLK Black	MCH Mocha
BRK Brickdust	OBK Outback
BBL Bridal Blanco	PIL Pilsner
CSK Cask	PIN Pinnacle Walnut
CLY Clay	SHD Shadow
DWH Designer White	SLG Slate Grey
EGR Egret	UMB Umber
FAW Fawn	VAL Valley
FLN Flint	WAL Walnut Heights
FLO Florence Walnut	WEA Weathered Ash
LOF Loft	ZEN Zen Grey

Standard Laminates

JSI Standard Laminate program consists of 26 solid and wood grain patterns, and establish our Tier 1 laminate pricing. Each has a coordinating PVC edge color that is automatically used with the Standard Laminates.

Wood Grain Laminate

BEL Belair	MIN Mineral
BRK Brickdust	MCH Mocha
CSK Cask	OBK Outback
CLY Clay	PIL Pilsner
EGR Egret	PIN Pinnacle Walnut
FAW Fawn	UMB Umber
FLN Flint	VAL Valley
FLO Florence Walnut	WLH Walnut Heights
LOF Loft	WEA Weathered Ash
MES Mesa	

Solid Laminate

ALB Alabaster
BLK Black
BBL Bridal Blanco
DWH Designer White
SHD Shadow
SLG Slate Grey
ZEN Zen Grey

Teamwork - Materials cont.

Veneer Tops

Tops are 1 3/16" thick, 5-ply balanced construction with particle board core. Standard Tier 1 Essentials veneer is book matched for cherry, maple, walnut and black oak veneer. Standard Tier 2 veneer is Artisan.

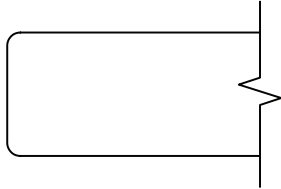

Eased Edge (R3)
Internal Lumber Band

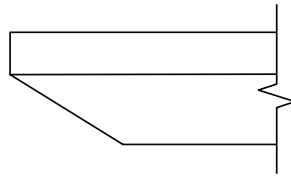

Reverse Bevel (K9)
Veneer Band on Stained MDF

Finish - Stain/Colors

ESS Essentials Veneer Collection

BRK	Brickdust	MIN	Mineral
CSK	Cask	MCH	Mocha
CLY	Clay	OBK	Outback
FAW	Fawn	PIL	Pilsner
FLX	Flax	SIE	Sienna
FLN	Flint	TRF	Truffle
LOF	Loft	UMB	Umber
MES	Mesa	VAL	Valley

ART Artisan Veneer Collection

BAR	Barrel	RAV	Raven
BUF	Buff	RYE	Rye
CND	Cinder	SAB	Sable
EGR	Egret	SAD	Saddle

Protective Top Coat

DuraTex™ offers exceptional hardness along with abrasion and impact resistance, it has been formulated to eliminate hazardous and harmful gases that are normally associated with wood finish.

DuraTex™ Features

Safety - Significantly reduces hazardous formaldehyde emissions which help improve the quality of the of the indoor air we breathe.

Quality - Developed to be tough and durable with special attention to appearance. The DuraTex™ finish preserves the natural beauty of wood.

Durability - Designed to meet a wide range of demanding performance and environmental standards to withstand even the highest wear and tear.

Finish Sheen

All veneer finishes are standard in 35-sheen, with the exception of Raven. Raven is only offered in 15-sheen. All other finishes can have their sheen modified with a 15% upcharge added to the list price of each item.

Custom/Special Finishes

JSI, upon request, will accommodate special finishes. A written request is required to proceed with custom finish orders. A sample reference is required for first-time matches and must be included with the written request.

There is a one-time charge of **\$412 list per order** for any non-standard wood finish.

Orders will be entered noting the special finish. A sample match will be provided to the customer. Written approval is needed before the finish process can be started. Delays in approval may have an impact on lead times.

Every effort will be made to create the requested match; however, an acceptable match may not be possible because of natural variations of wood. These natural variations can also cause minor differences in the final finish product.

Use standard pricing and option pricing for each line item with a special finish, unless additional modifications have been specified. For items available in both Essential and Artisan veneers, apply the Essentials pricing.

Teamwork - Base Styles

Lok provides a choice selection of bases in both function and aesthetics to serve a variety of needs. The teamwork offering includes: T-base and X-base

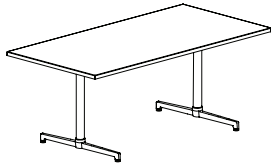

T-Base

- available in 29" with options of glide or caster
- available in 36"h and 42"h only in glides
- compatible with the following top shapes: arc rectangular, boat, boomerang, bullet, double chevron, hive, home base, huddle, intersect, one-twenty, racetrack, rectangular, taper, wedge
- base finish - select single metal finish or two-tone metal finish. See options listed below.

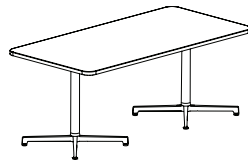

X-Base

- available in 16", 29"h, 36"h or 42"h only in glides.
- compatible with the following top shapes: rectangular, round, square, squircle
- base finish - select single metal finish or two-tone metal finish. See options listed below.

Single Metal Finish

- ABZ** Aged Bronze Feet & Post
- ASL** Arctic Silver Feet & Post
- GLD** Gold Feet & Post
- PEW** Pewter Feet & Post
- MBK** Matte Black Feet & Post
- SBZ** Soft Bronze Feet & Post
- SNK** Soft Nickel Feet & Post

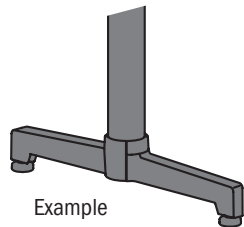

Example

Two - Tone Metal Finish

Two-Tone Aesthetics can be achieved by specifying Polished Aluminum on the foot and a contrasting finish on the post

Polished Aluminum Feet

- ABZ** Aged Bronze Post
- ASL** Arctic Silver Post
- GLD** Gold Post
- PEW** Pewter Post
- MBK** Matte Black Post
- SBZ** Soft Bronze Post
- SNK** Soft Nickel Post

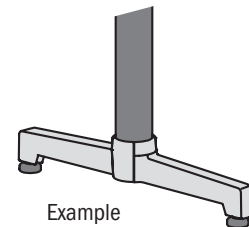

Example

Power/Charging Options

Lok offers the ability to place power and charging options in the center of select tables. Select your choice of EC23 or EC24, available in black and white.

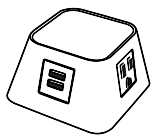

Moire - EC23

- Three 110 outlets
- Dual USB port with 72" power cord
- Black (B) or White (W)

select CTEC23 for cutout in worksurfaces



Node - EC24

- One 110 outlet
- Dual USB port with 72" power cord
- Black (B) or White (W)

select CTEC24 for cutout in worksurfaces

Cut outs are located in the center of each table. See below for representation or location.

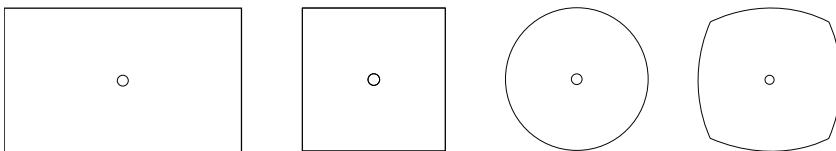

Teamwork - Electrical

Electrical Overview

Lok provides several packages to choose from for your electrical needs. Choose solutions for top surface power, underneath outlets, wireless charging, or a combination.

Specifying an electrical package eliminates your need to calculate additional components, as all units and necessary jumpers will ship with your table. You will only need to determine which power in-feed best suits your needs and order separately.

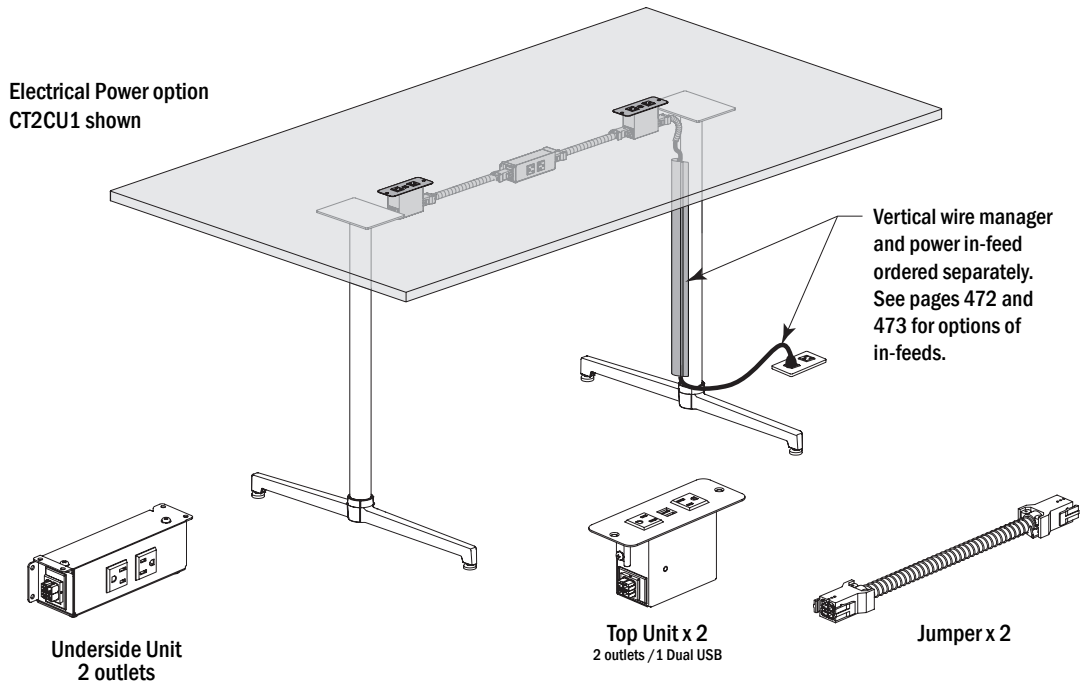

Electrical

Power and Charging Packages are measured and located out from the center of the table. Shown on rectangular tops, these dimensions are the same from center regardless of table shape (ie huddle, boomerang, etc.). Power in-feed is specified separately to support building electrical connection.

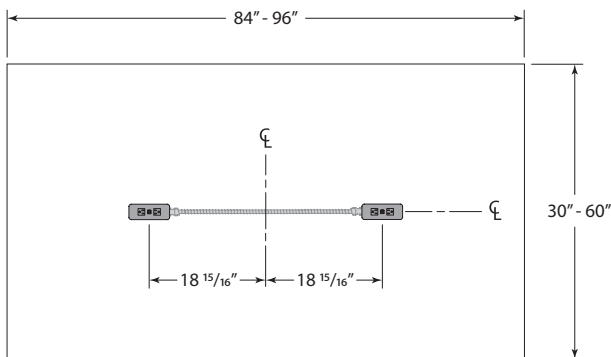

CT2 - Dual Power Top of Surface

Description

Rectangular Table with T Base at Working Height

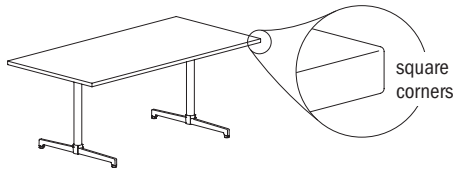

Laminate Tables "LKT" Models

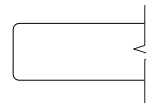

Eased Edge (R3)

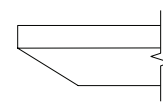

Reverse Bevel Edge (K9)

LAMINATE	D	W	H	CTN WT	CU FT	Model	Standard Tier 1	Graded In Tier 2	Standard Tier 1	Graded In Tier 2
	48	72	29	148	71	LKT4872-29TTT	\$2,566	\$2,621	\$3,209	\$3,263
	42	72	29	143	63	LKT4272-29TTT	\$2,443	\$2,490	\$3,069	\$3,116
	36	72	29	132	56	LKT3672-29TTT	\$2,230	\$2,315	\$2,792	\$2,875
	36	66	29	123	51	LKT3666-29TTT	\$2,150	\$2,230	\$2,711	\$2,792
	36	60	29	115	46	LKT3660-29TTT	\$2,056	\$2,131	\$2,614	\$2,689

Features:

- price reflects complete table - top and base
- ships KD in multiple cartons

Options:

- specify power/charging option, see below for options and upcharges
- specify glide (G) or caster (C) -choice of black (BL) or white/grey casters (WG)

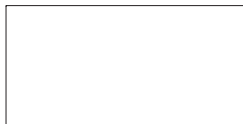

top shape

LOK - TEAMWORK

To Order Specify

1 Laminate Model #	2 Edge Detail	3 Laminate Selection	3a PVC Edge Color	4 Electrical
Laminate (LKT)	See Edge Detail Options	See Laminate Selection	See PVC Edge Color Options	N None CT2 Dual Power Center Top (See chart on next page) CU1 Single Power Underside 5 Foot/Caster G Glide C Caster - BL Black Caster - WG White Caster w/Grey Wheels 6 Metal Finish See Metal Finish Color Options

Model Number Breakdown

LKT4872-29TTT					
LK	T	4872	29	TT	T
LOK	Laminate	48" x 72"	Height	Rectangular Top Shape	T base

Description

Rectangular Table with T Base
at Working Height
(continued)

Veneer Tables
"LKV" Models

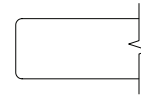

Eased Edge (R3)

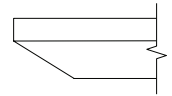

Reverse Bevel Edge (K9)

VENEER	D	W	H	CTN WT	CU FT	① Model	Essentials	Artisan	Essentials	Artisan
		48	72	29	148	71	LKV4872-29TTT	\$2,957	\$3,243	\$3,269
	42	72	29	143	63	LKV4272-29TTT	\$2,824	\$3,079	\$3,125	\$3,355
	36	72	29	132	56	LKV3672-29TTT	\$2,605	\$2,852	\$2,820	\$3,063
	36	66	29	123	51	LKV3666-29TTT	\$2,551	\$2,779	\$2,760	\$2,984
	36	60	29	115	46	LKV3660-29TTT	\$2,474	\$2,688	\$2,677	\$2,887

LOK - TEAMWORK

Electrical Options and Upcharges

CT2	
Dual Power Center Top - Black	CT2BL - add \$1,773
Dual Power Center Top - White	CT2WH - add \$1,773
CU1	
Single Power Underside - Black	CU11C - add \$690
Single Power Underside with Wireless Charging - Black	CU11CW - add \$1,651

Note: Order power infeed that best fits application

To Order, Specify:

① Veneer Model #	② Edge Detail	③ Wood Collection	④ Top Wood Finish	⑤ Electrical	⑥ Base - Foot/Caster	⑦ Metal Color
Veneer (LKV)	See Edge Detail Options	Essentials	See Essentials Top Wood Finish Options	N None CT2 Dual Power Center Top CU1 Single Power Underside (See chart above)	G Glide C Caster - BL Black Caster - WG White Caster with Grey Wheels	See Metal Finish Color Options
		Artisan	④ Top Wood Finish See Artisan Top Wood Finish Options			

Description

Rounded Rectangular Table with T Base at Working Height

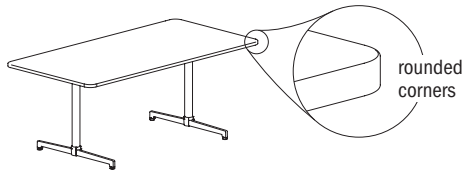

Laminate Tables
"LKT" Models

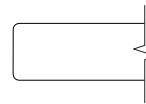

Eased Edge (R3)

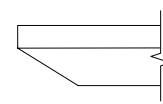

Reverse Bevel Edge (K9)

D	W	H	CTN WT	CU FT	Model	Eased Edge (R3)		Reverse Bevel Edge (K9)	
						Standard Tier 1	Graded In Tier 2	Standard Tier 1	Graded In Tier 2
48	72	29	148	71	LKT4872-29TTRT	\$2,642	\$2,696	\$3,281	\$3,339
42	72	29	143	63	LKT4272-29TTRT	\$2,514	\$2,559	\$3,139	\$3,188
36	72	29	132	56	LKT3672-29TTRT	\$2,352	\$2,440	\$2,913	\$2,999
36	66	29	123	51	LKT3666-29TTRT	\$2,280	\$2,360	\$2,841	\$2,923
36	60	29	115	46	LKT3660-29TTRT	\$2,194	\$2,269	\$2,756	\$2,833

LAMINATE

Features:

- price reflects complete table - top and base
- ships KD in multiple cartons

Options:

- specify power/charging option, see below for options and upcharges
- specify glide (G) or caster (C) -choice of black (BL) or white/grey casters (WG)



top shape

LOK - TEAMWORK

To Order Specify

1 Laminate Model #	2 Edge Detail	3 Laminate Selection	3a PVC Edge Color	4 Electrical
Laminate (LKT)	See Edge Detail Options	See Laminate Selection	See PVC Edge Color Options	N None CT2 Dual Power Center Top (See chart on next page) CU1 Single Power Underside 5 Foot/Caster G Glide C Caster - BL Black Caster - WG White Caster w/Grey Wheels 6 Metal Finish See Metal Finish Color Options

Model Number Breakdown

LKT4872-29TTRT						
LK	T	4872	29	TT	R	T
LOK	Laminate	48" x 72"	Height	Rectangular Top Shape	Rounded Corner	T base

Description

Rounded Rectangular Table with T Base at Working Height (continued)

Veneer Tables "LKV" Models

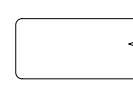

Eased Edge (R3)

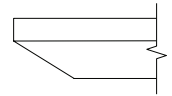

Reverse Bevel Edge (K9)

VENEER	D	W	H	CTN WT	CU FT	① Model	Eased Edge (R3)		Reverse Bevel Edge (K9)	
							Essentials	Artisan	Essentials	Artisan
	48	72	29	148	71	LKV4872-29TTRT	\$3,034	\$3,319	\$3,345	\$3,608
	42	72	29	143	63	LKV4272-29TTRT	\$2,896	\$3,150	\$3,193	\$3,425
	36	72	29	132	56	LKV3672-29TTRT	\$2,800	\$3,059	\$2,905	\$3,151
	36	66	29	123	51	LKV3666-29TTRT	\$2,741	\$2,984	\$2,846	\$3,070
	36	60	29	115	46	LKV3660-29TTRT	\$2,659	\$2,887	\$2,759	\$2,969

LOK - TEAMWORK

Electrical Options and Upcharges

CT2	
Dual Power Center Top - Black	CT2BL - add \$1,773
Dual Power Center Top - White	CT2WH - add \$1,773
CU1	
Single Power Underside - Black	CU11C - add \$690
Single Power Underside with Wireless Charging - Black	CU11CW - add \$1,651

Note: Order power infeed that best fits application

To Order, Specify:

① Veneer Model #	② Edge Detail	③ Wood Collection	④ Top Wood Finish	⑤ Electrical	⑥ Base - Foot/Caster	⑦ Metal Color
Veneer (LKV)	See Edge Detail Options	Essentials	See Essentials Top Wood Finish Options	N None CT2 Dual Power Center Top CU1 Single Power Underside (See chart above)	G Glide C Caster - BL Black Caster - WG White Caster with Grey Wheels	See Metal Finish Color Options
		Artisan	④ Top Wood Finish See Artisan Top Wood Finish Options			

Description

Rectangular Table with X Base at Working Height

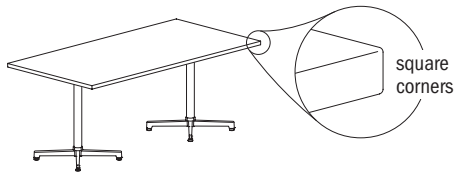

Laminate Tables "LKT" Models

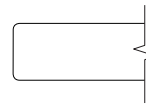

Eased Edge (R3)

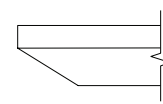

Reverse Bevel Edge (K9)

LAMINATE	D	W	H	CTN WT	CU FT	Model	Standard Tier 1	Graded In Tier 2	Standard Tier 1	Graded In Tier 2
		48	72	29	163	71	LKT4872-29TTX	\$3,311	\$3,365	\$3,954
	42	72	29	147	63	LKT4272-29TTX	\$3,188	\$3,237	\$3,815	\$3,864
	36	72	29	130	55	LKT3672-29TTX	\$2,918	\$3,004	\$3,478	\$3,563

Features:

- price reflects complete table - top and base
- ships KD in multiple cartons

Options:

- specify power/charging option, see below for options and upcharges



top shape

LOK - TEAMWORK

To Order Specify

1 Laminate Model #	2 Edge Detail	3 Laminate Selection	3a PVC Edge Color	4 Electrical
Laminate (LKT)	See Edge Detail Options	See Laminate Selection	See PVC Edge Color Options	N None CT2 Dual Power Center Top (See chart on next page) CU1 Single Power Underside 5 Metal Finish See Metal Finish Color Options

Model Number Breakdown

LKT4872-29TTX					
LK	T	4872	29	TT	X
LOK	Laminate	48" x 72"	Height	Rectangular Top Shape	X base

Description

Rectangular Table with X Base
at Working Height
(continued)

Veneer Tables
"LKV" Models

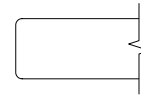

Eased Edge (R3)

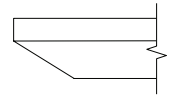

Reverse Bevel Edge (K9)

VENEER	D	W	H	CTN WT	CU FT	① Model	Essentials	Artisan	Essentials	Artisan
	48	72	29	163	71	LKV4872-29TTX	\$3,706	\$3,991	\$4,015	\$4,280
42	72	29	147	63	LKV4272-29TTX	\$3,571	\$3,823	\$3,870	\$4,103	
36	72	29	130	55	LKV3672-29TTX	\$3,295	\$3,544	\$3,510	\$3,752	

LOK - TEAMWORK

Electrical Options and Upcharges

CT2	
Dual Power Center Top - Black	CT2BL - add \$1,773
Dual Power Center Top - White	CT2WH - add \$1,773
CU1	
Single Power Underside - Black	CU11C - add \$690
Single Power Underside with Wireless Charging - Black	CU11CW - add \$1,651

Note: Order power infeed that best fits application

To Order, Specify:

① Veneer Model #	② Edge Detail	③ Wood Collection	④ Top Wood Finish	⑤ Electrical	⑥ Metal Color
Veneer (LKV)	See Edge Detail Options	Essentials	See Essentials Top Wood Finish Options	N None CT2 Dual Power Center Top CU1 Single Power Underside (See chart above)	See Metal Finish Color Options
		Artisan	④ Top Wood Finish See Artisan Top Wood Finish Options		

Description

Rounded Rectangular Table with X Base at Working Height

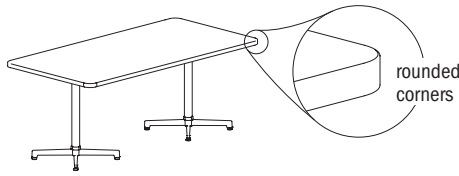

Laminate Tables
"LKT" Models

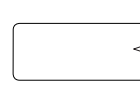

Eased Edge (R3)

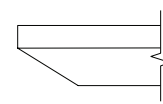

Reverse Bevel Edge (K9)

LAMINATE	D	W	H	CTN WT	CU FT	Model	Standard Tier 1	Graded In Tier 2	Standard Tier 1	Graded In Tier 2
		48	72	29	163	71	LKT4872-29TTRX	\$3,388	\$3,442	\$4,028
	42	72	29	147	63	LKT4272-29TTRX	\$3,257	\$3,306	\$3,884	\$3,931
	36	72	29	125	55	LKT3672-29TTRX	\$3,042	\$3,127	\$3,602	\$3,686

Features:

- price reflects complete table - top and base
- ships KD in multiple cartons

Options:

- specify power/charging option, see below for options and upcharges



top shape

LOK - TEAMWORK

To Order Specify

1 Laminite Model #	2 Edge Detail	3 Laminite Selection	3a PVC Edge Color	4 Electrical
Laminite (LKT)	See Edge Detail Options	See Laminite Selection	See PVC Edge Color Options	N None CT2 Dual Power Center Top (See chart on next page) CU1 Single Power Underside 5 Metal Finish See Metal Finish Color Options

Model Number Breakdown

LKT4872-29TTRX						
LK	T	4872	29	TT	R	X
LOK	Laminite	48" x 72"	Height	Rectangular Top Shape	Rounded Corner	X base

Description

Rounded Rectangular Table with X Base at Working Height (continued)

Veneer Tables "LKV" Models

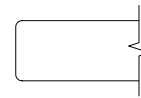

Eased Edge (R3)

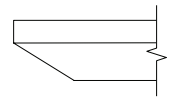

Reverse Bevel Edge (K9)

VENEER	D	W	H	CTN WT	CU FT	① Model	Eased Edge (R3)		Reverse Bevel Edge (K9)	
							Essentials	Artisan	Essentials	Artisan
	48	72	29	163	71	LKV4872-29TTRX	\$3,777	\$4,063	\$4,090	\$4,356
	42	72	29	147	63	LKV4272-29TTRX	\$3,641	\$3,896	\$3,939	\$4,172
	36	72	29	130	55	LKV3672-29TTRX	\$3,529	\$3,790	\$3,638	\$3,882

LOK - TEAMWORK

Electrical Options and Upcharges

CT2	
Dual Power Center Top - Black	CT2BL - add \$1,773
Dual Power Center Top - White	CT2WH - add \$1,773
CU1	
Single Power Underside - Black	CU11C - add \$690
Single Power Underside with Wireless Charging - Black	CU11CW - add \$1,651

Note: Order power infeed that best fits application

To Order, Specify:

① Veneer Model #	② Edge Detail	③ Wood Collection	④ Top Wood Finish	⑤ Electrical	⑥ Metal Color
Veneer (LKV)	See Edge Detail Options	Essentials	See Essentials Top Wood Finish Options	N None CT2 Dual Power Center Top CU1 Single Power Underside (See chart above)	See Metal Finish Color Options
		Artisan	④ Top Wood Finish See Artisan Top Wood Finish Options		

Description

Arc Rectangular Table with T Base at Working Height

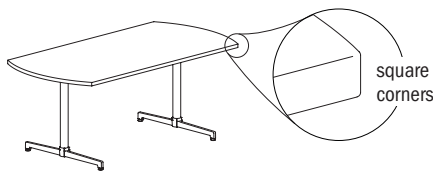

Laminate Tables
"LKT" Models

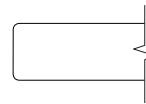

Eased Edge (R3)

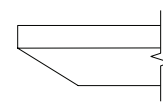

Reverse Bevel Edge (K9)

D	W	H	CTN WT	CU FT	Model	Eased Edge (R3)		Reverse Bevel Edge (K9)	
						Standard Tier 1	Graded In Tier 2	Standard Tier 1	Graded In Tier 2
48	72	29	148	71	LKT4872-29ART	\$2,518	\$2,568	\$3,127	\$3,179
42	72	29	140	63	LKT4272-29ART	\$2,396	\$2,440	\$2,990	\$3,035
36	72	29	128	56	LKT3672-29ART	\$2,241	\$2,321	\$2,774	\$2,857
36	66	29	119	51	LKT3666-29ART	\$2,172	\$2,246	\$2,706	\$2,783
36	60	29	110	46	LKT3660-29ART	\$2,091	\$2,161	\$2,624	\$2,696

LAMINATE

Features:

- price reflects complete table - top and base
- ships KD in multiple cartons

Options:

- specify power/charging option, see below for options and upcharges
- specify glide (G) or caster (C) -choice of black (BL) or white/grey casters (WG)



top shape

LOK - TEAMWORK

To Order Specify

1 Laminate Model #	2 Edge Detail	3 Laminate Selection	3a PVC Edge Color	4 Electrical
Laminate (LKT)	See Edge Detail Options	See Laminate Selection	See PVC Edge Color Options	N None CT2 Dual Power Center Top (See chart on next page) CU1 Single Power Underside 5 Foot/Caster G Glide C Caster - BL Black Caster - WG White Caster w/Grey Wheels 6 Metal Finish See Metal Finish Color Options

Model Number Breakdown

LKT4872-29ART					
LK	T	4872	29	AR	T
LOK	Laminate	48" x 72"	Height	Arc Rectangular Top Shape	T base

Description

Arc Rectangular Table with T Base at Working Height (continued)

Veneer Tables "LKV" Models

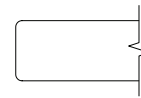

Eased Edge (R3)

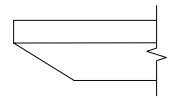

Reverse Bevel Edge (K9)

VENEER	D	W	H	CTN WT	CU FT	① Model	Eased Edge (R3)		Reverse Bevel Edge (K9)	
							Essentials	Artisan	Essentials	Artisan
	48	72	29	148	71	LKV4872-29ART	\$3,223	\$3,480	\$3,514	\$3,744
	42	72	29	140	63	LKV4272-29ART	\$3,092	\$3,341	\$3,372	\$3,591
	36	72	29	128	56	LKV3672-29ART	\$2,963	\$3,195	\$3,225	\$3,436
	36	66	29	119	51	LKV3666-29ART	\$2,856	\$3,084	\$3,112	\$3,312
	36	60	29	110	46	LKV3660-29ART	\$2,792	\$3,013	\$3,042	\$3,239

LOK - TEAMWORK

Electrical Options and Upcharges

CT2	
Dual Power Center Top - Black	CT2BL - add \$1,773
Dual Power Center Top - White	CT2WH - add \$1,773
CU1	
Single Power Underside - Black	CU11C - add \$690
Single Power Underside with Wireless Charging - Black	CU11CW - add \$1,651

Note: Order power infeed that best fits application

To Order, Specify:

① Veneer Model #	② Edge Detail	③ Wood Collection	④ Top Wood Finish	⑤ Electrical	⑥ Base - Foot/Caster	⑦ Metal Color
Veneer (LKV)	See Edge Detail Options	Essentials	See Essentials Top Wood Finish Options	N None CT2 Dual Power Center Top CU1 Single Power Underside (See chart above)	G Glide C Caster - BL Black Caster - WG White Caster with Grey Wheels	See Metal Finish Color Options
		Artisan	④ Top Wood Finish See Artisan Top Wood Finish Options			

Description

Rounded Arc Rectangular Table with T Base at Working Height

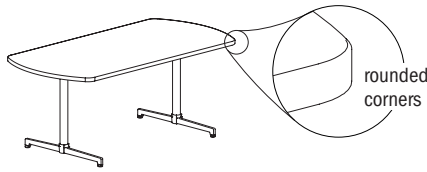

Laminate Tables
"LKT" Models

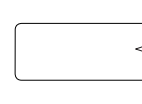

Eased Edge (R3)

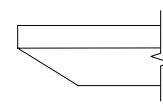

Reverse Bevel Edge (K9)

D	W	H	CTN WT	CU FT	Model	Eased Edge (R3)		Reverse Bevel Edge (K9)	
						Standard Tier 1	Graded In Tier 2	Standard Tier 1	Graded In Tier 2
48	72	29	148	71	LKT4872-29ARRT	\$2,518	\$2,568	\$3,127	\$3,179
42	72	29	140	63	LKT4272-29ARRT	\$2,396	\$2,440	\$2,990	\$3,035
36	72	29	128	56	LKT3672-29ARRT	\$2,241	\$2,321	\$2,774	\$2,857
36	66	29	119	51	LKT3666-29ARRT	\$2,172	\$2,246	\$2,706	\$2,783
36	60	29	110	46	LKT3660-29ARRT	\$2,091	\$2,161	\$2,624	\$2,696

LAMINATE

Features:

- price reflects complete table - top and base
- ships KD in multiple cartons

Options:

- specify power/charging option, see below for options and upcharges
- specify glide (G) or caster (C) -choice of black (BL) or white/grey casters (WG)

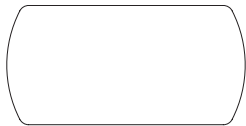

top shape

LOK - TEAMWORK

To Order Specify

1 Laminate Model #	2 Edge Detail	3 Laminate Selection	3a PVC Edge Color	4 Electrical
Laminate (LKT)	See Edge Detail Options	See Laminate Selection	See PVC Edge Color Options	N None CT2 Dual Power Center Top (See chart on next page) CU1 Single Power Underside 5 Foot/Caster G Glide C Caster - BL Black Caster - WG White Caster w/Grey Wheels 6 Metal Finish See Metal Finish Color Options

Model Number Breakdown

LKT4872-29ARRT						
LK	T	4872	29	AR	R	T
LOK	Laminate	48" x 72"	Height	Arc Rectangular Top Shape	Rounded Corner	T base

Description

Rounded Arc Rectangular Table with T Base at Working Height (continued)

Veneer Tables "LKV" Models

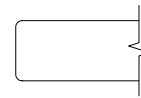

Eased Edge (R3)

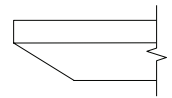

Reverse Bevel Edge (K9)

D	W	H	CTN WT	CU FT	Model	Eased Edge (R3)		Reverse Bevel Edge (K9)	
						Essentials	Artisan	Essentials	Artisan
48	72	29	148	71	LKV4872-29ARRT	\$3,223	\$3,480	\$3,514	\$3,744
42	72	29	140	63	LKV4272-29ARRT	\$3,092	\$3,341	\$3,372	\$3,591
36	72	29	128	56	LKV3672-29ARRT	\$2,963	\$3,195	\$3,225	\$3,436
36	66	29	119	51	LKV3666-29ARRT	\$2,856	\$3,084	\$3,112	\$3,312
36	60	29	110	46	LKV3660-29ARRT	\$2,792	\$3,013	\$3,042	\$3,239

VENEER

LOK - TEAMWORK

Electrical Options and Upcharges

CT2	
Dual Power Center Top - Black	CT2BL - add \$1,773
Dual Power Center Top - White	CT2WH - add \$1,773
CU1	
Single Power Underside - Black	CU11C - add \$690
Single Power Underside with Wireless Charging - Black	CU11CW - add \$1,651

Note: Order power infeed that best fits application

To Order, Specify:

1 Veneer Model #	2 Edge Detail	3 Wood Collection	4 Top Wood Finish	5 Electrical	6 Base - Foot/Caster	7 Metal Color
Veneer (LKV)	See Edge Detail Options	Essentials	See Essentials Top Wood Finish Options	N None CT2 Dual Power Center Top CU1 Single Power Underside (See chart above)	G Glide C Caster - BL Black Caster - WG White Caster with Grey Wheels	See Metal Finish Color Options
		Artisan	4 Top Wood Finish See Artisan Top Wood Finish Options			

Description

Racetrack Table with T Base at Working Height

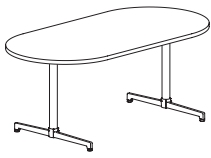

Laminate Tables
"LKT" Models

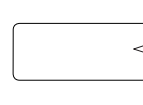

Eased Edge (R3)

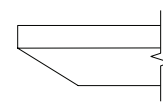

Reverse Bevel Edge (K9)

D	W	H	CTN WT	CU FT	Model	Eased Edge (R3)		Reverse Bevel Edge (K9)	
						Standard Tier 1	Graded In Tier 2	Standard Tier 1	Graded In Tier 2
48	72	29	135	71	LKT4872-29RKT	\$2,518	\$2,568	\$3,127	\$3,179
42	72	29	133	63	LKT4272-29RKT	\$2,396	\$2,440	\$2,990	\$3,035
36	72	29	122	56	LKT3672-29RKT	\$2,241	\$2,321	\$2,774	\$2,857
36	66	29	113	51	LKT3666-29RKT	\$2,172	\$2,246	\$2,706	\$2,783
36	60	29	104	46	LKT3660-29RKT	\$2,091	\$2,161	\$2,624	\$2,696

LAMINATE

Features:

- price reflects complete table - top and base
- ships KD in multiple cartons

Options:

- specify power/charging option, see below for options and upcharges
- specify glide (G) or caster (C) -choice of black (BL) or white/grey casters (WG)

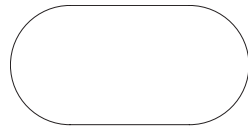

top shape

LOK - TEAMWORK

To Order Specify

1 Laminate Model #	2 Edge Detail	3 Laminate Selection	3a PVC Edge Color	4 Electrical
Laminate (LKT)	See Edge Detail Options	See Laminate Selection	See PVC Edge Color Options	N None CT2 Dual Power Center Top (See chart on next page) CU1 Single Power Underside 5 Foot/Caster G Glide C Caster - BL Black Caster - WG White Caster w/Grey Wheels 6 Metal Finish See Metal Finish Color Options

Model Number Breakdown

LKT4872-29RKT					
LK	T	4872	29	RK	T
LOK	Laminate	48" x 72"	Height	Racetrack Top Shape	T base

Description

Racetrack Table with T Base
at Working Height
(continued)

Veneer Tables
"LKV" Models

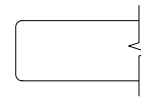

Eased Edge (R3)

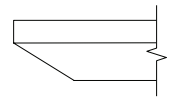

Reverse Bevel Edge (K9)

D	W	H	CTN WT	CU FT	① Model	Eased Edge (R3)		Reverse Bevel Edge (K9)	
						Essentials	Artisan	Essentials	Artisan
48	72	29	135	71	LKV4872-29RKT	\$3,223	\$3,480	\$3,514	\$3,744
42	72	29	133	63	LKV4272-29RKT	\$3,092	\$3,341	\$3,372	\$3,591
36	72	29	122	56	LKV3672-29RKT	\$2,963	\$3,195	\$3,225	\$3,436
36	66	29	113	51	LKV3666-29RKT	\$2,856	\$3,084	\$3,112	\$3,312
36	60	29	104	46	LKV3660-29RKT	\$2,701	\$2,915	\$2,943	\$3,132

VENEER

LOK - TEAMWORK

Electrical Options and Upcharges

CT2	
Dual Power Center Top - Black	CT2BL - add \$1,773
Dual Power Center Top - White	CT2WH - add \$1,773
CU1	
Single Power Underside - Black	CU11C - add \$690
Single Power Underside with Wireless Charging - Black	CU11CW - add \$1,651

Note: Order power infeed that best fits application

To Order, Specify:

① Veneer Model #	② Edge Detail	③ Wood Collection	④ Top Wood Finish	⑤ Electrical	⑥ Base - Foot/Caster	⑦ Metal Color
Veneer (LKV)	See Edge Detail Options	Essentials	See Essentials Top Wood Finish Options	N None CT2 Dual Power Center Top CU1 Single Power Underside (See chart above)	G Glide C Caster - BL Black Caster - WG White Caster with Grey Wheels	See Metal Finish Color Options
		Artisan	④ Top Wood Finish See Artisan Top Wood Finish Options			

Description

Oval Table with T Base at Working Height

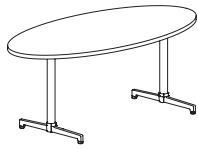

Laminate Tables
"LKT" Models

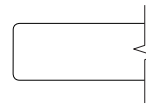

Eased Edge (R3)

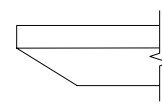

Reverse Bevel Edge (K9)

LAMI	D	W	H	CTN WT	CU FT	Model	Standard Tier 1	Graded In Tier 2	Standard Tier 1	Graded In Tier 2
		36	72	29	110	56	LKT3672-290VT	\$2,241	\$2,321	\$2,774

Features:

- price reflects complete table - top and base
- ships KD in multiple cartons

Options:

- specify power option and or charging option, see below for options and upcharges
- specify glide (always black) or caster; Black (BL) or White with Grey Wheels (WG)

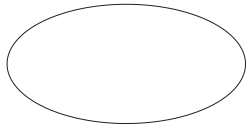

top shape

LOK - TEAMWORK

To Order Specify

1 Laminate Model #	2 Edge Detail	3 Laminate Selection	3a PVC Edge Color	4 Electrical
Laminate (LKT)	See Edge Detail Options	See Laminate Selection	See PVC Edge Color Options	N None CT2 Dual Power Center Top (See chart on next page) CU1 Single Power Underside 5 Foot/Caster G Glide C Caster - BL Black Caster - WG White Caster w/Grey Wheels 6 Metal Finish See Metal Finish Color Options

Model Number Breakdown

LKT3672-290VT					
LK	T	3672	29	OV	T
LOK	Laminate	36" x 72"	Height	Oval Top Shape	T base

Description

Oval Table with T Base at Working Height (continued)

Veneer Tables "LKV" Models

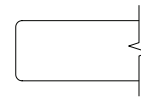

Eased Edge (R3)

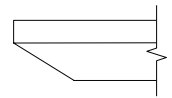

Reverse Bevel Edge (K9)

VEN.	D	W	H	CTN WT	CU FT	① Model	Essentials		Artisan	
							Essentials	Artisan	Essentials	Artisan
	36	72	29	110	56	LKV3672-29OVT	\$2,772	\$2,994	\$3,023	\$3,217

LOK - TEAMWORK

Electrical Options and Upcharges

CT2	
Dual Power Center Top - Black	CT2BL - add \$1,773
Dual Power Center Top - White	CT2WH - add \$1,773
CU1	
Single Power Underside - Black	CU11C - add \$690
Single Power Underside with Wireless Charging - Black	CU11CW - add \$1,651

Note: Order power infeed that best fits application

To Order, Specify:

① Veneer Model #	② Edge Detail	③ Wood Collection	④ Top Wood Finish	⑤ Electrical	⑥ Base - Foot/Caster	⑦ Metal Color
Veneer (LKV)	See Edge Detail Options	Essentials	See Essentials Top Wood Finish Options	N None CT2 Dual Power Center Top CU1 Single Power Underside (See chart above)	G Glide C Caster - BL Black Caster - WG White Caster with Grey Wheels	See Metal Finish Color Options
		Artisan	④ Top Wood Finish See Artisan Top Wood Finish Options			

Description

Boat Table with T Base at Working Height

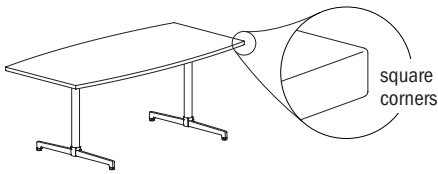

Laminate Tables "LKT" Models

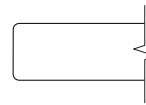

Eased Edge (R3)

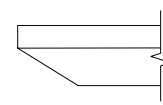

Reverse Bevel Edge (K9)

LAMINATE	D	W	H	CTN WT	CU FT	Model	Standard Tier 1	Graded In Tier 2	Standard Tier 1	Graded In Tier 2
		48	72	29	145	71	LKT4872-29BTT	\$2,518	\$2,568	\$3,127
	42	72	29	142	63	LKT4272-29BTT	\$2,396	\$2,440	\$2,990	\$3,035
	36	72	29	128	56	LKT3672-29BTT	\$2,241	\$2,321	\$2,774	\$2,857
	36	66	29	119	51	LKT3666-29BTT	\$2,172	\$2,246	\$2,706	\$2,783
	36	60	29	111	46	LKT3660-29BTT	\$2,091	\$2,161	\$2,624	\$2,696

Features:

- price reflects complete table - top and base
- ships KD in multiple cartons

Options:

- specify power/charging option, see below for options and upcharges
- specify glide (G) or caster (C) -choice of black (BL) or white/grey casters (WG)



top shape

LOK - TEAMWORK

To Order Specify

1 Laminate Model #	2 Edge Detail	3 Laminate Selection	3a PVC Edge Color	4 Electrical
Laminate (LKT)	See Edge Detail Options	See Laminate Selection	See PVC Edge Color Options	N None CT2 Dual Power Center Top (See chart on next page) CU1 Single Power Underside 5 Foot/Caster G Glide C Caster - BL Black Caster - WG White Caster w/Grey Wheels 6 Metal Finish See Metal Finish Color Options

Model Number Breakdown

LKT4872-29BTT					
LK	T	4872	29	BT	T
LOK	Laminate	48" x 72"	Height	Boat Top Shape	T base

Description

Boat Table with T Base at Working Height (continued)

Veneer Tables "LKV" Models

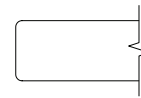

Eased Edge (R3)

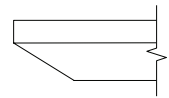

Reverse Bevel Edge (K9)

D	W	H	CTN WT	CU FT	① Model	Eased Edge (R3)		Reverse Bevel Edge (K9)	
						Essentials	Artisan	Essentials	Artisan
48	72	29	145	71	LKV4872-29BTT	\$3,223	\$3,480	\$3,514	\$3,744
42	72	29	145	71	LKV4272-29BTT	\$3,092	\$3,341	\$3,372	\$3,591
36	72	29	142	63	LKV3672-29BTT	\$2,963	\$3,195	\$3,225	\$3,436
36	66	29	128	56	LKV3666-29BTT	\$2,856	\$3,084	\$3,112	\$3,312
36	60	29	119	46	LKV3660-29BTT	\$2,792	\$3,013	\$3,042	\$3,239

VENEER

LOK - TEAMWORK

Electrical Options and Upcharges

CT2	
Dual Power Center Top - Black	CT2BL - add \$1,773
Dual Power Center Top - White	CT2WH - add \$1,773
CU1	
Single Power Underside - Black	CU11C - add \$690
Single Power Underside with Wireless Charging - Black	CU11CW - add \$1,651

Note: Order power infeed that best fits application

To Order, Specify:

① Veneer Model #	② Edge Detail	③ Wood Collection	④ Top Wood Finish	⑤ Electrical	⑥ Base - Foot/Caster	⑦ Metal Color
Veneer (LKV)	See Edge Detail Options	Essentials	See Essentials Top Wood Finish Options	N None CT2 Dual Power Center Top CU1 Single Power Underside (See chart above)	G Glide C Caster - BL Black Caster - WG White Caster with Grey Wheels	See Metal Finish Color Options
		Artisan	④ Top Wood Finish See Artisan Top Wood Finish Options			

Description

Rounded Boat Table with T Base at Working Height

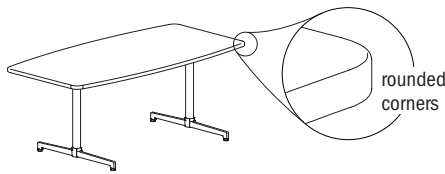

Laminate Tables "LKT" Models

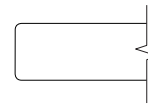

Eased Edge (R3)

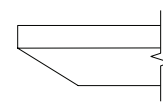

Reverse Bevel Edge (K9)

LAMINATE	D	W	H	CTN WT	CU FT	Model	Standard Tier 1	Graded In Tier 2	Standard Tier 1	Graded In Tier 2
		48	72	29	145	71	LKT4872-29BTRT	\$2,518	\$2,568	\$3,127
	42	72	29	142	63	LKT4272-29BTRT	\$2,396	\$2,440	\$2,990	\$3,035
	36	72	29	128	56	LKT3672-29BTRT	\$2,241	\$2,321	\$2,774	\$2,857
	36	66	29	119	51	LKT3666-29BTRT	\$2,172	\$2,246	\$2,706	\$2,783
	36	60	29	111	46	LKT3660-29BTRT	\$2,091	\$2,161	\$2,624	\$2,696

Features:

- price reflects complete table - top and base
- ships KD in multiple cartons

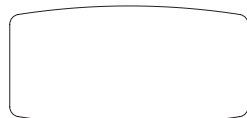

top shape

Options:

- specify power/charging option, see below for options and upcharges
- specify glide (G) or caster (C) - choice of black (BL) or white/grey casters (WG)

LOK - TEAMWORK

To Order Specify

1 Laminate Model #	2 Edge Detail	3 Laminate Selection	3a PVC Edge Color	4 Electrical
Laminate (LKT)	See Edge Detail Options	See Laminate Selection	See PVC Edge Color Options	N None CT2 Dual Power Center Top (See chart on next page) CU1 Single Power Underside 5 Foot/Caster G Glide C Caster - BL Black Caster - WG White Caster w/Grey Wheels 6 Metal Finish See Metal Finish Color Options

Model Number Breakdown

LKT4872-29BTRT						
LK	T	4872	29	BT	R	T
LOK	Laminate	48" x 72"	Height	Boat Top Shape	Rounded Corner	T base

Description

Rounded Boat Table with T Base at Working Height (continued)

Veneer Tables "LKV" Models

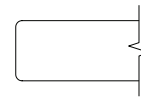

Eased Edge (R3)

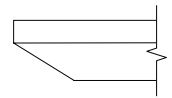

Reverse Bevel Edge (K9)

VENEER	D	W	H	CTN WT	CU FT	Model	Eased Edge (R3)		Reverse Bevel Edge (K9)	
							Essentials	Artisan	Essentials	Artisan
	48	72	29	145	71	LKV4872-29BTRT	\$3,223	\$3,480	\$3,514	\$3,744
	42	72	29	142	63	LKV4272-29BTRT	\$3,092	\$3,341	\$3,372	\$3,591
	36	72	29	128	56	LKV3672-29BTRT	\$2,963	\$3,195	\$3,225	\$3,436
	36	66	29	119	51	LKV3666-29BTRT	\$2,856	\$3,084	\$3,112	\$3,312
	36	60	29	111	46	LKV3660-29BTRT	\$2,792	\$3,013	\$3,042	\$3,239

LOK - TEAMWORK

Electrical Options and Upcharges

CT2	
Dual Power Center Top - Black	CT2BL - add \$1,773
Dual Power Center Top - White	CT2WH - add \$1,773
CU1	
Single Power Underside - Black	CU11C - add \$690
Single Power Underside with Wireless Charging - Black	CU11CW - add \$1,651

Note: Order power infeed that best fits application

To Order, Specify:

1 Veneer Model #	2 Edge Detail	3 Wood Collection	4 Top Wood Finish	5 Electrical	6 Base - Foot/Caster	7 Metal Color
Veneer (LKV)	See Edge Detail Options	Essentials	See Essentials Top Wood Finish Options	N None CT2 Dual Power Center Top CU1 Single Power Underside (See chart above)	G Glide C Caster - BL Black Caster - WG White Caster with Grey Wheels	See Metal Finish Color Options
		Artisan	4 Top Wood Finish See Artisan Top Wood Finish Options			

Description

Rounded Double Chevron Table with T Base at Working Height

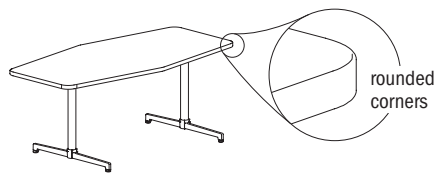

Laminate Tables "LKT" Models

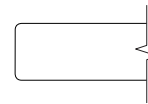

Eased Edge (R3)

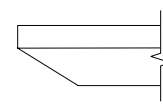

Reverse Bevel Edge (K9)

LAMINATE

D	W	H	CTN WT	CU FT	Model	Eased Edge (R3)		Reverse Bevel Edge (K9)	
						Standard Tier 1	Graded In Tier 2	Standard Tier 1	Graded In Tier 2
48	72	29	148	71	LKT4872-29DCRT	\$2,518	\$2,568	\$3,127	\$3,179
48	60	29	138	60	LKT4860-29DCRT	\$2,225	\$2,268	\$2,818	\$2,863
42	72	29	133	63	LKT4272-29DCRT	\$2,396	\$2,440	\$2,990	\$3,035
42	60	29	123	52	LKT4260-29DCRT	\$2,119	\$2,157	\$2,706	\$2,743
36	72	29	107	56	LKT3672-29DCRT	\$2,241	\$2,321	\$2,774	\$2,857
36	60	29	101	46	LKT3660-29DCRT	\$2,061	\$2,096	\$2,639	\$2,672

Features:

- price reflects complete table - top and base
- ships KD in multiple cartons

Options:

- specify power/charging option, see below for options and upcharges
- specify glide (G) or caster (C) - choice of black (BL) or white/grey casters (WG)

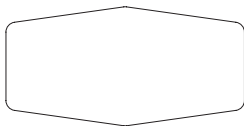

top shape

LOK - TEAMWORK

To Order Specify

1 Laminate Model #	2 Edge Detail	3 Laminate Selection	3a PVC Edge Color	4 Electrical
Laminate (LKT)	See Edge Detail Options	See Laminate Selection	See PVC Edge Color Options	N None CT2 Dual Power Center Top (See chart on next page) CU1 Single Power Underside 5 Foot/Caster G Glide C Caster - BL Black Caster - WG White Caster w/Grey Wheels 6 Metal Finish See Metal Finish Color Options

Model Number Breakdown

LKT4872-29DCRT						
LK	T	4872	29	DC	R	T
LOK	Laminate	48" x 72"	Height	Double Chevron Top Shape	Rounded Corner	T base

Description

Rounded Double Chevron Table with T Base
at Working Height
(continued)

Veneer Tables
"LKV" Models



Eased Edge (R3)

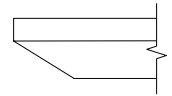

Reverse Bevel Edge (K9)

D	W	H	CTN WT	CU FT	① Model	Eased Edge (R3)		Reverse Bevel Edge (K9)	
						Essentials	Artisan	Essentials	Artisan
48	72	29	148	71	LKV4872-29DCRT	\$3,223	\$3,480	\$3,514	\$3,744
48	60	29	138	60	LKV4860-29DCRT	\$2,923	\$3,156	\$3,186	\$3,392
42	72	29	133	63	LKV4272-29DCRT	\$3,092	\$3,341	\$3,372	\$3,591
42	60	29	123	52	LKV4260-29DCRT	\$2,810	\$3,035	\$3,064	\$3,263
36	72	29	107	56	LKV3672-29DCRT	\$2,772	\$2,994	\$3,023	\$3,217
36	60	29	101	46	LKV3660-29DCRT	\$2,601	\$2,809	\$2,838	\$3,019

VENEER

LOK - TEAMWORK

Electrical Options and Upcharges

CT2	
Dual Power Center Top - Black	CT2BL - add \$1,773
Dual Power Center Top - White	CT2WH - add \$1,773
CU1	
Single Power Underside - Black	CU11C - add \$690
Single Power Underside with Wireless Charging - Black	CU11CW - add \$1,651

Note: Order power infeed that best fits application

To Order, Specify:

① Veneer Model #	② Edge Detail	③ Wood Collection	④ Top Wood Finish	⑤ Electrical	⑥ Base - Foot/Caster	⑦ Metal Color
Veneer (LKV)	See Edge Detail Options	Essentials	See Essentials Top Wood Finish Options	N None CT2 Dual Power Center Top CU1 Single Power Underside (See chart above)	G Glide C Caster - BL Black Caster - WG White Caster with Grey Wheels	See Metal Finish Color Options
		Artisan	④ Top Wood Finish See Artisan Top Wood Finish Options			

Description

Taper Table with T Base at Working Height

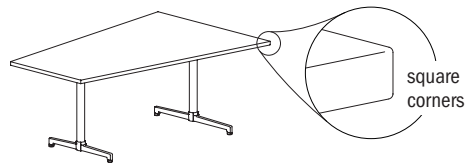

Laminate Tables "LKT" Models

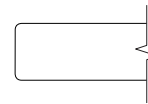

Eased Edge (R3)

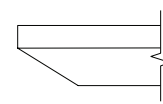

Reverse Bevel Edge (K9)

LAMI	D	W	H	CTN WT	CU FT	Model	Standard Tier 1	Graded In Tier 2	Standard Tier 1	Graded In Tier 2
		48	72	29	140	71	LKT4872-29TPT	\$3,127	\$3,180	\$3,737

Features:

- price reflects complete table - top and base
- ships KD in multiple cartons

Options:

- specify power/charging option, see below for options and upcharges
- specify glide (G) or caster (C) - choice of black (BL) or white/grey casters (WG)

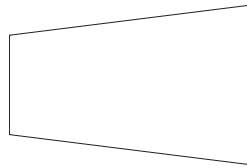

top shape

LOK - TEAMWORK

To Order Specify

1 Laminate Model #	2 Edge Detail	3 Laminate Selection	3a PVC Edge Color	4 Electrical
Laminate (LKT)	See Edge Detail Options	See Laminate Selection	See PVC Edge Color Options	N None CT2 Dual Power Center Top (See chart on next page) CU1 Single Power Underside 5 Foot/Caster G Glide C Caster - BL Black Caster - WG White Caster w/Grey Wheels 6 Metal Finish See Metal Finish Color Options

Model Number Breakdown

LKT4872-29TPT					
LK	T	4872	29	TP	T
LOK	Laminate	48" x 72"	Height	Taper Top Shape	T base

Description

Taper Table with T Base at Working Height (continued)

Veneer Tables "LKV" Models

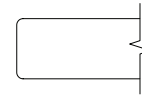

Eased Edge (R3)

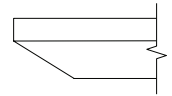

Reverse Bevel Edge (K9)

VEN.	D	W	H	CTN WT	CU FT	① Model	Essentials		Artisan	
							Essentials	Artisan	Essentials	Artisan
	48	72	29	140	71	LKV4872-29TPT	\$3,837	\$4,140	\$4,181	\$4,452

LOK - TEAMWORK

Electrical Options and Upcharges

CT2	
Dual Power Center Top - Black	CT2BL - add \$1,773
Dual Power Center Top - White	CT2WH - add \$1,773
CU1	
Single Power Underside - Black	CU11C - add \$690
Single Power Underside with Wireless Charging - Black	CU11CW - add \$1,651

Note: Order power infeed that best fits application

To Order, Specify:

① Veneer Model #	② Edge Detail	③ Wood Collection	④ Top Wood Finish	⑤ Electrical	⑥ Base - Foot/Caster	⑦ Metal Color
Veneer (LKV)	See Edge Detail Options	Essentials	See Essentials Top Wood Finish Options	N None CT2 Dual Power Center Top CU1 Single Power Underside (See chart above)	G Glide C Caster - BL Black Caster - WG White Caster with Grey Wheels	See Metal Finish Color Options
		Artisan	④ Top Wood Finish See Artisan Top Wood Finish Options			

Description

Rounded Taper Table with T Base at Working Height

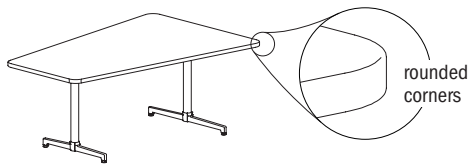

Laminate Tables "LKT" Models

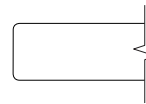

Eased Edge (R3)

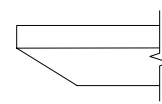

Reverse Bevel Edge (K9)

LAMI	D	W	H	CTN WT	CU FT	Model	Standard Tier 1	Graded In Tier 2	Standard Tier 1	Graded In Tier 2
		48	72	29	140	71	LKT4872-29TPRT	\$3,127	\$3,180	\$3,737

Features:

- price reflects complete table - top and base
- ships KD in multiple cartons

Options:

- specify power/charging option, see below for options and upcharges
- specify glide (G) or caster (C) -choice of black (BL) or white/grey casters (WG)

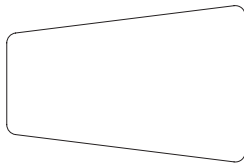

top shape

LOK - TEAMWORK

To Order Specify

1 Laminate Model #	2 Edge Detail	3 Laminate Selection	3a PVC Edge Color	4 Electrical
Laminate (LKT)	See Edge Detail Options	See Laminate Selection	See PVC Edge Color Options	N None CT2 Dual Power Center Top (See chart on next page) CU1 Single Power Underside 5 Foot/Caster G Glide C Caster - BL Black Caster - WG White Caster w/Grey Wheels 6 Metal Finish See Metal Finish Color Options

Model Number Breakdown

LKT4872-29TPRT						
LK	T	4872	29	TP	R	T
LOK	Laminate	48" x 72"	Height	Taper Top Shape	Rounded Corner	T base

Description

Rounded Taper Table with T Base at Working Height (continued)

Veneer Tables "LKV" Models

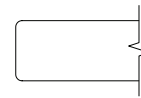

Eased Edge (R3)

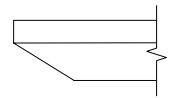

Reverse Bevel Edge (K9)

VEN.	D	W	H	CTN WT	CU FT	① Model	Essentials		Artisan	
							Essentials	Artisan	Essentials	Artisan
	48	72	29	140	71	LKV4872-29TPRT	\$3,837	\$4,140	\$4,181	\$4,452

LOK - TEAMWORK

Electrical Options and Upcharges

CT2	
Dual Power Center Top - Black	CT2BL - add \$1,773
Dual Power Center Top - White	CT2WH - add \$1,773
CU1	
Single Power Underside - Black	CU11C - add \$690
Single Power Underside with Wireless Charging - Black	CU11CW - add \$1,651

Note: Order power infeed that best fits application

To Order, Specify:

① Veneer Model #	② Edge Detail	③ Wood Collection	④ Top Wood Finish	⑤ Electrical	⑥ Base - Foot/Caster	⑦ Metal Color
Veneer (LKV)	See Edge Detail Options	Essentials	See Essentials Top Wood Finish Options	N None CT2 Dual Power Center Top CU1 Single Power Underside (See chart above)	G Glide C Caster - BL Black Caster - WG White Caster with Grey Wheels	See Metal Finish Color Options
		Artisan	④ Top Wood Finish See Artisan Top Wood Finish Options			

Description

Wedge Table with T Base
at Working Height

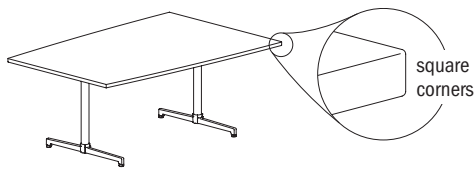

Laminate Tables
"LKT" Models

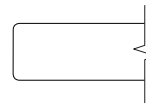

Eased Edge (R3)

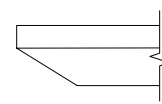

Reverse Bevel Edge (K9)

LAMI	D	W	H	CTN WT	CU FT	Model	Standard Tier 1	Graded In Tier 2	Standard Tier 1	Graded In Tier 2
		48	72	29	127	71	LKT4872-29WDT	\$3,503	\$3,555	\$4,113

Features:

- price reflects complete table - top and base
- ships KD in multiple cartons

Options:

- specify power/charging option, see below for options and upcharges
- specify glide (G) or caster (C) - choice of black (BL) or white/grey casters (WG)

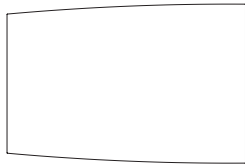

top shape

LOK - TEAMWORK

To Order Specify

1 Laminate Model #	2 Edge Detail	3 Laminate Selection	3a PVC Edge Color	4 Electrical
Laminate (LKT)	See Edge Detail Options	See Laminate Selection	See PVC Edge Color Options	N None CT2 Dual Power Center Top (See chart on next page) CU1 Single Power Underside 5 Foot/Caster G Glide C Caster - BL Black Caster - WG White Caster w/Grey Wheels 6 Metal Finish See Metal Finish Color Options

Model Number Breakdown

LKT4872-29WDT					
LK	T	4872	29	WD	T
LOK	Laminate	48" x 72"	Height	Wedge Top Shape	T base

Description

Wedge Table with T Base
at Working Height
(continued)

Veneer Tables
"LKV" Models

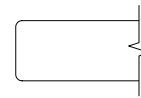

Eased Edge (R3)

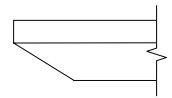

Reverse Bevel Edge (K9)

VEN.	D	W	H	CTN WT	CU FT	① Model	Eased Edge (R3)		Reverse Bevel Edge (K9)	
							Essentials	Artisan	Essentials	Artisan
	48	72	29	124	71	LKV4872-29WDT	\$4,212	\$4,545	\$4,587	\$4,886

LOK - TEAMWORK

Electrical Options and Upcharges

CT2	
Dual Power Center Top - Black	CT2BL - add \$1,773
Dual Power Center Top - White	CT2WH - add \$1,773
CU1	
Single Power Underside - Black	CU11C - add \$690
Single Power Underside with Wireless Charging - Black	CU11CW - add \$1,651

Note: Order power infeed that best fits application

To Order, Specify:

① Veneer Model #	② Edge Detail	③ Wood Collection	④ Top Wood Finish	⑤ Electrical	⑥ Base - Foot/Caster	⑦ Metal Color
Veneer (LKV)	See Edge Detail Options	Essentials	See Essentials Top Wood Finish Options	N None CT2 Dual Power Center Top CU1 Single Power Underside (See chart above)	G Glide C Caster - BL Black Caster - WG White Caster with Grey Wheels	See Metal Finish Color Options
		Artisan	④ Top Wood Finish See Artisan Top Wood Finish Options			

Description

Wedge Table with T Base
at Working Height

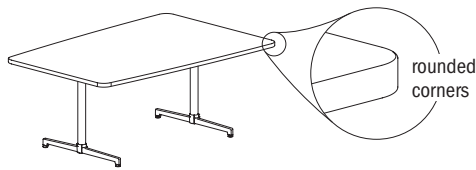

Laminate Tables
"LKT" Models

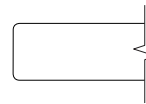

Eased Edge (R3)

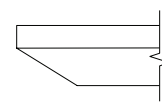

Reverse Bevel Edge (K9)

LAMI	D	W	H	CTN WT	CU FT	Model	Standard Tier 1	Graded In Tier 2	Standard Tier 1	Graded In Tier 2
		48	72	29	156	71	LKT4872-29WDRT	\$2,518	\$2,568	\$3,127

Features:

- price reflects complete table - top and base
- ships KD in multiple cartons

Options:

- specify power/charging option, see below for options and upcharges
- specify glide (G) or caster (C) - choice of black (BL) or white/grey casters (WG)

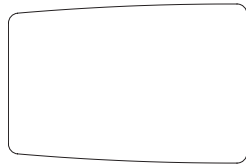

top shape

LOK - TEAMWORK

To Order Specify

1 Laminate Model #	2 Edge Detail	3 Laminate Selection	3a PVC Edge Color	4 Electrical
Laminate (LKT)	See Edge Detail Options	See Laminate Selection	See PVC Edge Color Options	N None CT2 Dual Power Center Top (See chart on next page) CU1 Single Power Underside 5 Foot/Caster G Glide C Caster - BL Black Caster - WG White Caster w/Grey Wheels 6 Metal Finish See Metal Finish Color Options

Model Number Breakdown

LKT4872-29WDRT						
LK	T	4872	29	WD	R	T
LOK	Laminate	48" x 72"	Height	Wedge Top Shape	Rounded Corner	T base

Description

Wedge Table with T Base
at Working Height
(continued)

Veneer Tables
"LKV" Models

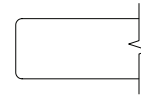

Eased Edge (R3)

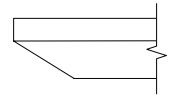

Reverse Bevel Edge (K9)

VEN.	D	W	H	CTN WT	CU FT	① Model	Eased Edge (R3)		Reverse Bevel Edge (K9)	
							Essentials	Artisan	Essentials	Artisan
	48	72	29	156	71	LKV4872-29WDRT	\$3,223	\$3,480	\$3,514	\$3,744

LOK - TEAMWORK

Electrical Options and Upcharges

CT2	
Dual Power Center Top - Black	CT2BL - add \$1,773
Dual Power Center Top - White	CT2WH - add \$1,773
CU1	
Single Power Underside - Black	CU11C - add \$690
Single Power Underside with Wireless Charging - Black	CU11CW - add \$1,651

Note: Order power infeed that best fits application

To Order, Specify:

① Veneer Model #	② Edge Detail	③ Wood Collection	④ Top Wood Finish	⑤ Electrical	⑥ Base - Foot/Caster	⑦ Metal Color
Veneer (LKV)	See Edge Detail Options	Essentials	See Essentials Top Wood Finish Options	N None CT2 Dual Power Center Top CU1 Single Power Underside (See chart above)	G Glide C Caster - BL Black Caster - WG White Caster with Grey Wheels	See Metal Finish Color Options
		Artisan	④ Top Wood Finish See Artisan Top Wood Finish Options			

Description

Bullet Table with T Base at Working Height

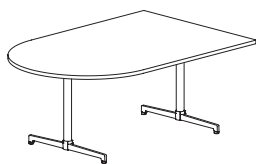

Laminate Tables "LKT" Models

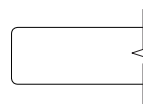

Eased Edge (R3)

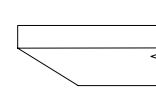

Reverse Bevel Edge (K9)

LAMI	D	W	H	CTN WT	CU FT	Model	Standard Tier 1	Graded In Tier 2	Standard Tier 1	Graded In Tier 2
		48	72	29	153	71	LKT4872-29BUT	\$2,518	\$2,568	\$3,127

Features:

- price reflects complete table - top and base
- ships KD in multiple cartons

Options:

- specify power/charging option, see below for options and upcharges
- specify glide (G) or caster (C) - choice of black (BL) or white/grey casters (WG)

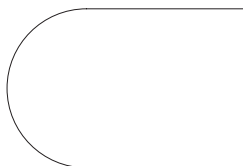

top shape

LOK - TEAMWORK

To Order Specify

1 Laminate Model #	2 Edge Detail	3 Laminate Selection	3a PVC Edge Color	4 Electrical
Laminate (LKT)	See Edge Detail Options	See Laminate Selection	See PVC Edge Color Options	N None CT2 Dual Power Center Top (See chart on next page) CU1 Single Power Underside 5 Foot/Caster G Glide C Caster - BL Black Caster - WG White Caster w/Grey Wheels 6 Metal Finish See Metal Finish Color Options

Model Number Breakdown

LKT4872-29BUT					
LK	T	4872	29	BU	T
LOK	Laminate	48" x 72"	Height	Bullet Top Shape	T base

Description

Bullet Table with T Base
at Working Height
(continued)

Veneer Tables
"LKV" Models

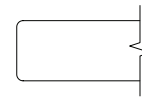

Eased Edge (R3)

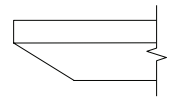

Reverse Bevel Edge (K9)

VEN.	D	W	H	CTN WT	CU FT	① Model	Essentials		Artisan	
							Essentials	Artisan	Essentials	Artisan
	48	72	29	153	71	LKV4872-29BUT	\$3,223	\$3,480	\$3,514	\$3,744

LOK - TEAMWORK

Electrical Options and Upcharges

CT2	
Dual Power Center Top - Black	CT2BL - add \$1,773
Dual Power Center Top - White	CT2WH - add \$1,773
CU1	
Single Power Underside - Black	CU11C - add \$690
Single Power Underside with Wireless Charging - Black	CU11CW - add \$1,651

Note: Order power infeed that best fits application

To Order, Specify:

① Veneer Model #	② Edge Detail	③ Wood Collection	④ Top Wood Finish	⑤ Electrical	⑥ Base - Foot/Caster	⑦ Metal Color
Veneer (LKV)	See Edge Detail Options	Essentials	See Essentials Top Wood Finish Options	N None CT2 Dual Power Center Top CU1 Single Power Underside (See chart above)	G Glide C Caster - BL Black Caster - WG White Caster with Grey Wheels	See Metal Finish Color Options
		Artisan	④ Top Wood Finish See Artisan Top Wood Finish Options			

Description

Hive Table with T Base at Working Height

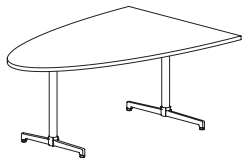

Laminate Tables
"LKT" Models

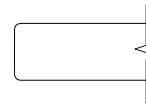

Eased Edge (R3)

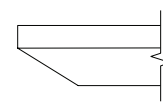

Reverse Bevel Edge (K9)

LAMI	D	W	H	CTN WT	CU FT	① Model	Standard Tier 1	Graded In Tier 2	Standard Tier 1	Graded In Tier 2
		48	72	29	135	71	LKT4872-29HVT	\$2,518	\$2,568	\$3,127

Features:

- price reflects complete table - top and base
- ships KD in multiple cartons

Options:

- specify power/charging option, see below for options and upcharges
- specify glide (G) or caster (C) - choice of black (BL) or white/grey casters (WG)

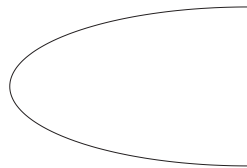

top shape

LOK - TEAMWORK

To Order Specify

① Laminate Model #	② Edge Detail	③ Laminate Selection	③a PVC Edge Color	④ Electrical
Laminate (LKT)	See Edge Detail Options	See Laminate Selection	See PVC Edge Color Options	N None CT2 Dual Power Center Top (See chart on next page) CU1 Single Power Underside ⑤ Foot/Caster G Glide C Caster - BL Black Caster - WG White Caster w/Grey Wheels ⑥ Metal Finish See Metal Finish Color Options

Model Number Breakdown

LKT4872-29HVT					
LK	T	4872	29	HV	T
LOK	Laminate	48" x 72"	Height	Hive Top Shape	T base

Description

Hive Table with T Base at Working Height (continued)

Veneer Tables "LKV" Models

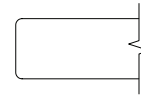

Eased Edge (R3)

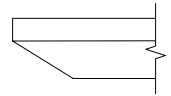

Reverse Bevel Edge (K9)

VEN.	D	W	H	CTN WT	CU FT	① Model	Essentials		Artisan	
	48	72	29	135	71	LKV4872-29HVT	\$3,223		\$3,480	
									\$3,514	\$3,744

LOK - TEAMWORK

Electrical Options and Upcharges

CT2	
Dual Power Center Top - Black	CT2BL - add \$1,773
Dual Power Center Top - White	CT2WH - add \$1,773
CU1	
Single Power Underside - Black	CU11C - add \$690
Single Power Underside with Wireless Charging - Black	CU11CW - add \$1,651

Note: Order power infeed that best fits application

To Order, Specify:

① Veneer Model #	② Edge Detail	③ Wood Collection	④ Top Wood Finish	⑤ Electrical	⑥ Base - Foot/Caster	⑦ Metal Color
Veneer (LKV)	See Edge Detail Options	Essentials	See Essentials Top Wood Finish Options	N None CT2 Dual Power Center Top CU1 Single Power Underside (See chart above)	G Glide C Caster - BL Black Caster - WG White Caster with Grey Wheels	See Metal Finish Color Options
		Artisan	④ Top Wood Finish See Artisan Top Wood Finish Options			

Description

Rectangular Table with T Base at Counter Height

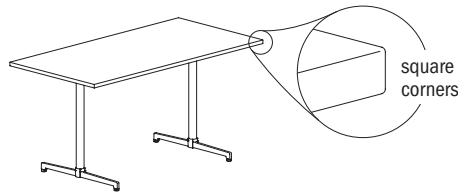

Laminate Tables
"LKT" Models

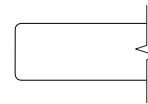

Eased Edge (R3)

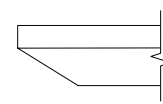

Reverse Bevel Edge (K9)

D	W	H	CTN WT	CU FT	① Model	Eased Edge (R3)		Reverse Bevel Edge (K9)	
						Standard Tier 1	Graded In Tier 2	Standard Tier 1	Graded In Tier 2
48	72	36	144	87	LKT4872-36TTT	\$2,783	\$2,840	\$3,424	\$3,478
42	72	36	146	77	LKT4272-36TTT	\$2,658	\$2,708	\$3,288	\$3,335
36	72	36	135	66	LKT3672-36TTT	\$2,407	\$2,491	\$2,969	\$3,055
36	66	36	126	62	LKT3666-36TTT	\$2,333	\$2,407	\$2,889	\$2,969
36	60	36	135	57	LKT3660-36TTT	\$2,233	\$2,309	\$2,796	\$2,866

LAMINATE

Features:

- price reflects complete table - top and base
- ships KD in multiple cartons
- model includes adjustable glide

Options:

- specify power option and or charging option, see below for options and upcharges

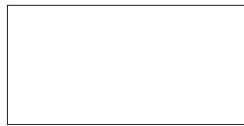

top shape

LOK - TEAMWORK

To Order Specify

① Laminate Model #	② Edge Detail	③ Laminate Selection	④ PVC Edge Color	⑤ Electrical
Laminate (LKT)	See Edge Detail Options	See Laminate Selection	See PVC Edge Color Options	N None CT2 Dual Power Center Top (See chart on next page) CU1 Single Power Underside ⑤ Metal Finish See Metal Finish Color Options

Model Number Breakdown

LKT4872-36TTT					
LK	T	4872	36	TT	T
LOK	Laminate	48" x 72"	Height	Rectangular Top Shape	T base

Description

Rectangular Table with T Base at Counter Height
(continued)

Veneer Tables
"LKV" Models

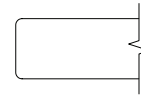

Eased Edge (R3)

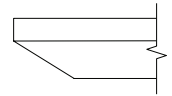

Reverse Bevel Edge (K9)

D	W	H	CTN WT	CU FT	① Model	Eased Edge (R3)		Reverse Bevel Edge (K9)	
						Essentials	Artisan	Essentials	Artisan
48	72	36	140	87	LKV4872-36TTT	\$3,177	\$3,464	\$3,485	\$3,754
42	72	36	146	77	LKV4272-36TTT	\$3,045	\$3,298	\$3,342	\$3,572
36	72	36	135	66	LKV3672-36TTT	\$2,781	\$3,028	\$2,999	\$3,240
36	66	36	126	62	LKV3666-36TTT	\$2,728	\$2,957	\$2,938	\$3,162
36	60	36	135	57	LKV3660-36TTT	\$2,652	\$2,866	\$2,854	\$3,063

VENEER

LOK - TEAMWORK

Electrical Options and Upcharges

CT2	
Dual Power Center Top - Black	CT2BL - add \$1,773
Dual Power Center Top - White	CT2WH - add \$1,773
CU1	
Single Power Underside - Black	CU11C - add \$690
Single Power Underside with Wireless Charging - Black	CU11CW - add \$1,651

Note: Order power infeed that best fits application

To Order, Specify:

① Veneer Model #	② Edge Detail	③ Wood Collection	④ Top Wood Finish	⑤ Electrical	⑥ Metal Color
Veneer (LKV)	See Edge Detail Options	Essentials	See Essentials Top Wood Finish Options	N None CT2 Dual Power Center Top CU1 Single Power Underside (See chart above)	See Metal Finish Color Options
		Artisan	④ Top Wood Finish See Artisan Top Wood Finish Options		

Description

Rounded Rectangular Table with T Base at Counter Height

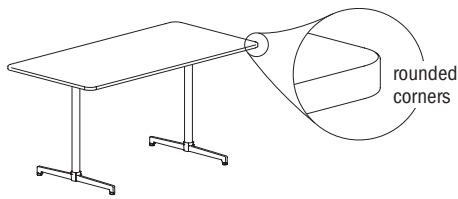

Laminate Tables "LKT" Models

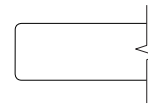

Eased Edge (R3)

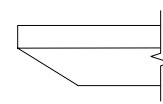

Reverse Bevel Edge (K9)

D	W	H	CTN WT	CU FT	Model	Eased Edge (R3)		Reverse Bevel Edge (K9)	
						Standard Tier 1	Graded In Tier 2	Standard Tier 1	Graded In Tier 2
48	72	36	144	87	LKT4872-36TTRT	\$2,858	\$2,915	\$3,501	\$3,555
42	72	36	136	77	LKT4272-36TTRT	\$2,729	\$2,777	\$3,356	\$3,404
36	72	36	135	66	LKT3672-36TTRT	\$2,530	\$2,614	\$3,091	\$3,178
36	66	36	126	62	LKT3666-36TTRT	\$2,457	\$2,536	\$3,019	\$3,101
36	60	36	135	57	LKT3660-36TTRT	\$2,369	\$2,447	\$2,931	\$3,009

LAMINATE

Features:

- price reflects complete table - top and base
- ships KD in multiple cartons
- model includes adjustable glide

Options:

- specify power option and or charging option, see below for options and upcharges



top shape

LOK - TEAMWORK

To Order Specify

1 Laminate Model #	2 Edge Detail	3 Laminate Selection	3a PVC Edge Color	4 Electrical
Laminate (LKT)	See Edge Detail Options	See Laminate Selection	See PVC Edge Color Options	N None CT2 Dual Power Center Top (See chart on next page) CU1 Single Power Underside 5 Metal Finish See Metal Finish Color Options

Model Number Breakdown

LKT4872-36TTRT						
LK	T	4872	36	TT	R	T
LOK	Laminate	48" x 72"	Height	Rectangular Top Shape	Rounded Corner	T base

Description

Rounded Rectangular Table with T Base at Counter Height (continued)

Veneer Tables "LKV" Models

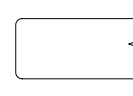

Eased Edge (R3)

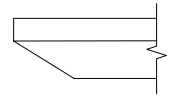

Reverse Bevel Edge (K9)

VENEER	D	W	H	CTN WT	CU FT	① Model	Essentials	Artisan	Essentials	Artisan
		48	72	36	144	87	LKV4872-36TTRT	\$3,253	\$3,540	\$3,562
	42	72	36	146	77	LKV4272-36TTRT	\$3,114	\$3,365	\$3,415	\$3,644
	36	72	36	135	66	LKV3672-36TTRT	\$2,977	\$3,238	\$3,086	\$3,332
	36	66	36	126	62	LKV3666-36TTRT	\$2,864	\$3,068	\$3,145	\$3,326
	36	60	36	135	57	LKV3660-36TTRT	\$2,840	\$3,063	\$2,936	\$3,147

LOK - TEAMWORK

Electrical Options and Upcharges

CT2	
Dual Power Center Top - Black	CT2BL - add \$1,773
Dual Power Center Top - White	CT2WH - add \$1,773
CU1	
Single Power Underside - Black	CU11C - add \$690
Single Power Underside with Wireless Charging - Black	CU11CW - add \$1,651

Note: Order power infeed that best fits application

To Order, Specify:

① Veneer Model #	② Edge Detail	③ Wood Collection	④ Top Wood Finish	⑤ Electrical	⑥ Metal Color
Veneer (LKV)	See Edge Detail Options	Essentials	See Essentials Top Wood Finish Options	N None CT2 Dual Power Center Top CU1 Single Power Underside (See chart above)	See Metal Finish Color Options
		Artisan	④ Top Wood Finish See Artisan Top Wood Finish Options		

Description

Rectangular Table with X Base at Counter Height

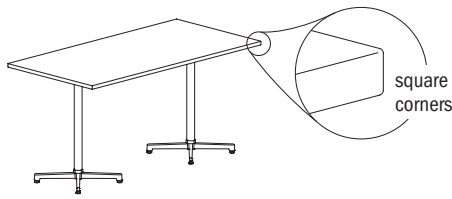

Laminate Tables
"LKT" Models

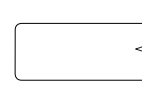

Eased Edge (R3)

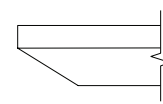

Reverse Bevel Edge (K9)

LAMINATE	D	W	H	CTN WT	CU FT	1 Model	Standard Tier 1	Graded In Tier 2	Standard Tier 1	Graded In Tier 2
		48	72	36	165	87	LKT4872-36TTX	\$3,415	\$3,468	\$4,053
	42	72	36	150	77	LKT4272-36TTX	\$3,288	\$3,335	\$3,915	\$3,962
	36	72	36	133	67	LKT3672-36TTX	\$3,097	\$3,180	\$3,657	\$3,743

Features:

- price reflects complete table - top and base
- ships KD in multiple cartons
- model includes adjustable glide

Options:

- specify power option and or charging option, see below for options and upcharges

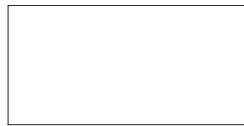

top shape

LOK - TEAMWORK

To Order Specify

1 Laminates Model #	2 Edge Detail	3 Laminates Selection	3a PVC Edge Color	4 Electrical
Laminates (LKT)	See Edge Detail Options	See Laminates Selection	See PVC Edge Color Options	N None CT2 Dual Power Center Top (See chart on next page) CU1 Single Power Underside 5 Metal Finish See Metal Finish Color Options

Model Number Breakdown

LKT4872-36TTX					
LK	T	4872	36	TT	X
LOK	Laminates	48" x 72"	Height	Rectangular Top Shape	X base

Description

Rectangular Table with X Base at Counter Height
(continued)

Veneer Tables
"LKV" Models

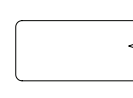

Eased Edge (R3)

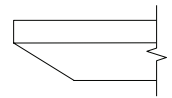

Reverse Bevel Edge (K9)

VENEER	D	W	H	CTN WT	CU FT	① Model	Essentials	Artisan	Essentials	Artisan
		48	72	36	165	87	LKV4872-36TTX	\$3,805	\$4,090	\$4,115
	42	72	36	150	77	LKV4272-36TTX	\$3,671	\$3,925	\$3,969	\$4,204
	36	72	36	133	67	LKV3672-36TTX	\$3,471	\$3,718	\$3,686	\$3,928

LOK - TEAMWORK

Electrical Options and Upcharges

CT2	
Dual Power Center Top - Black	CT2BL - add \$1,773
Dual Power Center Top - White	CT2WH - add \$1,773
CU1	
Single Power Underside - Black	CU11C - add \$690
Single Power Underside with Wireless Charging - Black	CU11CW - add \$1,651

Note: Order power infeed that best fits application

To Order, Specify:

① Veneer Model #	② Edge Detail	③ Wood Collection	④ Top Wood Finish	⑤ Electrical	⑥ Metal Color
Veneer (LKV)	See Edge Detail Options	Essentials	See Essentials Top Wood Finish Options	N None CT2 Dual Power Center Top CU1 Single Power Underside (See chart above)	See Metal Finish Color Options
		Artisan	④ Top Wood Finish See Artisan Top Wood Finish Options		

Description

Rounded Rectangular Table with X Base at Counter Height

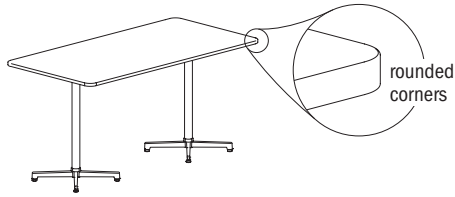

Laminate Tables
"LKT" Models

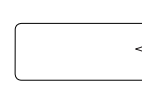

Eased Edge (R3)

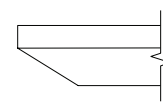

Reverse Bevel Edge (K9)

LAMINATE	D	W	H	CTN WT	CU FT	1 Model	Standard Tier 1	Graded In Tier 2	Standard Tier 1	Graded In Tier 2
		48	72	36	165	87	LKT4872-36TTRX	\$3,485	\$3,545	\$4,129
	42	72	36	150	77	LKT4272-36TTRX	\$3,189	\$3,238	\$3,816	\$3,866
	36	72	36	133	67	LKT3672-36TTRX	\$3,218	\$3,304	\$3,777	\$3,867

Features:

- price reflects complete table - top and base
- ships KD in multiple cartons
- model includes adjustable glide

Options:

- specify power option and or charging option, see below for options and upcharges



top shape

LOK - TEAMWORK

To Order Specify

1 Laminate Model #	2 Edge Detail	3 Laminate Selection	3a PVC Edge Color	4 Electrical
Laminate (LKT)	See Edge Detail Options	See Laminate Selection	See PVC Edge Color Options	N None CT2 Dual Power Center Top (See chart on next page) CU1 Single Power Underside 5 Metal Finish See Metal Finish Color Options

Model Number Breakdown

LKT4872-36TTRX						
LK	T	4872	36	TT	R	X
LOK	Laminate	48" x 72"	Height	Rectangular Top Shape	Rounded Corner	X base

Description

Rounded Rectangular Table with X Base at Counter Height (continued)

Veneer Tables
"LKV" Models

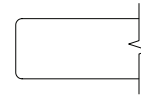

Eased Edge (R3)

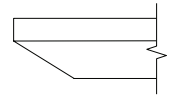

Reverse Bevel Edge (K9)

VENEER	D	W	H	CTN WT	CU FT	① Model	Essentials	Artisan	Essentials	Artisan
		48	72	36	165	87	LKV4872-36TTRX	\$3,879	\$4,168	\$4,189
	42	72	36	150	77	LKV4272-36TTRX	\$3,572	\$3,828	\$3,871	\$4,104
	36	72	36	133	67	LKV3672-36TTRX	\$3,710	\$3,968	\$3,816	\$4,060

LOK - TEAMWORK

Electrical Options and Upcharges

CT2	
Dual Power Center Top - Black	CT2BL - add \$1,773
Dual Power Center Top - White	CT2WH - add \$1,773
CU1	
Single Power Underside - Black	CU11C - add \$690
Single Power Underside with Wireless Charging - Black	CU11CW - add \$1,651

Note: Order power infeed that best fits application

To Order, Specify:

① Veneer Model #	② Edge Detail	③ Wood Collection	④ Top Wood Finish	⑤ Electrical	⑥ Metal Color
Veneer (LKV)	See Edge Detail Options	Essentials	See Essentials Top Wood Finish Options	N None CT2 Dual Power Center Top CU1 Single Power Underside (See chart above)	See Metal Finish Color Options
		Artisan	④ Top Wood Finish See Artisan Top Wood Finish Options		

Description

Arc Rectangular Table with T Base at Counter Height

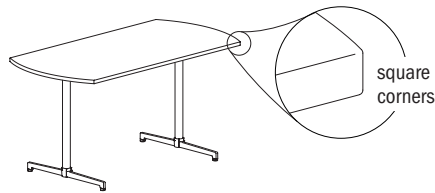

Laminate Tables
"LKT" Models

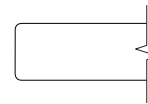

Eased Edge (R3)

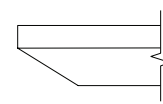

Reverse Bevel Edge (K9)

D	W	H	CTN WT	CU FT	Model	Eased Edge (R3)		Reverse Bevel Edge (K9)	
						Standard Tier 1	Graded In Tier 2	Standard Tier 1	Graded In Tier 2
48	72	36	153	87	LKT4872-36ART	\$2,724	\$2,777	\$3,334	\$3,388
42	72	36	140	78	LKT4272-36ART	\$2,599	\$2,647	\$3,196	\$3,243
36	72	36	131	66	LKT3672-36ART	\$2,410	\$2,493	\$2,944	\$3,026
36	66	36	122	62	LKT3666-36ART	\$2,341	\$2,417	\$2,875	\$2,951
36	60	36	131	57	LKT3660-36ART	\$2,259	\$2,333	\$2,795	\$2,865

Features:

- price reflects complete table - top and base
- ships KD in multiple cartons
- model includes adjustable glide

Options:

- specify power option and or charging option, see below for options and upcharges

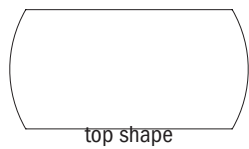

top shape

LOK - TEAMWORK

To Order Specify

1 Laminate Model #	2 Edge Detail	3 Laminate Selection	3a PVC Edge Color	4 Electrical
Laminate (LKT)	See Edge Detail Options	See Laminate Selection	See PVC Edge Color Options	N None CT2 Dual Power Center Top (See chart on next page) CU1 Single Power Underside 5 Metal Finish See Metal Finish Color Options

Model Number Breakdown

LKT4872-36ART					
LK	T	4872	36	AR	T
LOK	Laminate	48" x 72"	Height	Arc Rectangular Top Shape	T base

Description

Arc Rectangular Table with T Base at Counter Height
(continued)

Veneer Tables
"LKV" Models

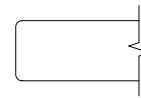

Eased Edge (R3)

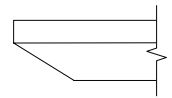

Reverse Bevel Edge (K9)

D	W	H	CTN WT	CU FT	① Model	Eased Edge (R3)		Reverse Bevel Edge (K9)	
						Essentials	Artisan	Essentials	Artisan
48	72	36	153	87	LKV4872-36ART	\$3,431	\$3,706	\$3,737	\$3,982
42	72	36	140	78	LKV4272-36ART	\$3,301	\$3,563	\$3,599	\$3,831
36	72	36	131	66	LKV3672-36ART	\$3,168	\$3,422	\$3,455	\$3,678
36	66	36	122	62	LKV3666-36ART	\$3,063	\$3,308	\$3,340	\$3,555
36	60	36	131	57	LKV3660-36ART	\$2,995	\$3,237	\$3,265	\$3,477

VENEER

LOK - TEAMWORK

Electrical Options and Upcharges

CT2	
Dual Power Center Top - Black	CT2BL - add \$1,773
Dual Power Center Top - White	CT2WH - add \$1,773
CU1	
Single Power Underside - Black	CU11C - add \$690
Single Power Underside with Wireless Charging - Black	CU11CW - add \$1,651

Note: Order power infeed that best fits application

To Order, Specify:

① Veneer Model #	② Edge Detail	③ Wood Collection	④ Top Wood Finish	⑤ Electrical	⑥ Metal Color
Veneer (LKV)	See Edge Detail Options	Essentials	See Essentials Top Wood Finish Options	N None CT2 Dual Power Center Top CU1 Single Power Underside (See chart above)	See Metal Finish Color Options
		Artisan	④ Top Wood Finish See Artisan Top Wood Finish Options		

Description

Rounded Arc Rectangular Table with T Base at Counter Height

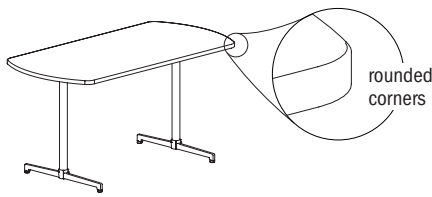

Laminate Tables "LKT" Models

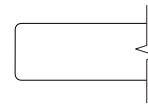

Eased Edge (R3)

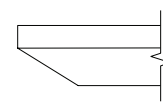

Reverse Bevel Edge (K9)

D	W	H	CTN WT	CU FT	Model	Eased Edge (R3)		Reverse Bevel Edge (K9)	
						Standard Tier 1	Graded In Tier 2	Standard Tier 1	Graded In Tier 2
48	72	36	153	87	LKT4872-36ARRT	\$2,724	\$2,777	\$3,334	\$3,388
42	72	36	140	78	LKT4272-36ARRT	\$2,599	\$2,647	\$3,196	\$3,243
36	72	36	131	66	LKT3672-36ARRT	\$2,410	\$2,493	\$2,944	\$3,026
36	66	36	122	62	LKT3666-36ARRT	\$2,341	\$2,417	\$2,875	\$2,951
36	60	36	131	57	LKT3660-36ARRT	\$2,259	\$2,333	\$2,795	\$2,865

LAMINATE

Features:

- price reflects complete table - top and base
- ships KD in multiple cartons
- model includes adjustable glide

Options:

- specify power option and or charging option, see below for options and upcharges

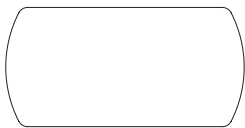

top shape

LOK - TEAMWORK

To Order Specify

1 Laminate Model #	2 Edge Detail	3 Laminate Selection	3a PVC Edge Color	4 Electrical
Laminate (LKT)	See Edge Detail Options	See Laminate Selection	See PVC Edge Color Options	N None CT2 Dual Power Center Top (See chart on next page) CU1 Single Power Underside 5 Metal Finish See Metal Finish Color Options

Model Number Breakdown

LKT4872-36ARRT						
LK	T	4872	36	AR	R	T
LOK	Laminate	48" x 72"	Height	Arc Rectangular Top Shape	Rounded Corner	T base

Description

Rounded Arc Rectangular Table with T Base at Counter Height (continued)

Veneer Tables "LKV" Models

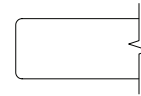

Eased Edge (R3)

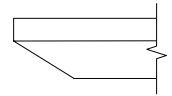

Reverse Bevel Edge (K9)

VENEER	D	W	H	CTN WT	CU FT	① Model	Essentials	Artisan	Essentials	Artisan
	48	72	36	153	87	LKV4872-36ARRT	\$3,431	\$3,706	\$3,737	\$3,982
42	72	36	140	78	LKV4272-36ARRT	\$3,301	\$3,563	\$3,599	\$3,831	
36	72	36	131	66	LKV3672-36ARRT	\$3,168	\$3,422	\$3,455	\$3,678	
36	66	36	122	62	LKV3666-36ARRT	\$3,063	\$3,308	\$3,340	\$3,555	
36	60	36	131	57	LKV3660-36ARRT	\$2,995	\$3,237	\$3,265	\$3,477	

LOK - TEAMWORK

Electrical Options and Upcharges

CT2	
Dual Power Center Top - Black	CT2BL - add \$1,773
Dual Power Center Top - White	CT2WH - add \$1,773
CU1	
Single Power Underside - Black	CU11C - add \$690
Single Power Underside with Wireless Charging - Black	CU11CW - add \$1,651

Note: Order power infeed that best fits application

To Order, Specify:

① Veneer Model #	② Edge Detail	③ Wood Collection	④ Top Wood Finish	⑤ Electrical	⑥ Metal Color
Veneer (LKV)	See Edge Detail Options	Essentials	See Essentials Top Wood Finish Options	N None CT2 Dual Power Center Top CU1 Single Power Underside (See chart above)	See Metal Finish Color Options
		Artisan	④ Top Wood Finish See Artisan Top Wood Finish Options		

Description

Racetrack Table with T Base at Counter Height



Laminate Tables
"LKT" Models

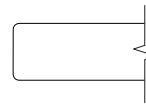

Eased Edge (R3)

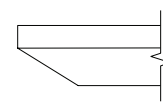

Reverse Bevel Edge (K9)

LAMINATE	D	W	H	CTN WT	CU FT	1 Model	Standard Tier 1	Graded In Tier 2	Standard Tier 1	Graded In Tier 2
		42	72	36	136	77	LKT4272-36RKT	\$2,599	\$2,647	\$3,196
	36	72	36	125	66	LKT3672-36RKT	\$2,410	\$2,493	\$2,944	\$3,026
	36	66	36	117	62	LKT3666-36RKT	\$2,341	\$2,417	\$2,875	\$2,951
	36	60	36	125	57	LKT3660-36RKT	\$2,259	\$2,333	\$2,795	\$2,865

Features:

- price reflects complete table - top and base
- ships KD in multiple cartons
- model includes adjustable glide

Options:

- specify power option and or charging option, see below for options and upcharges

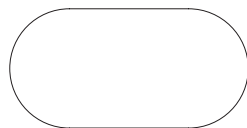

top shape

LOK - TEAMWORK

To Order Specify

1 Laminate Model #	2 Edge Detail	3 Laminate Selection	3a PVC Edge Color	4 Electrical
Laminate (LKT)	See Edge Detail Options	See Laminate Selection	See PVC Edge Color Options	N None CT2 Dual Power Center Top (See chart on next page) CU1 Single Power Underside 5 Metal Finish See Metal Finish Color Options

Model Number Breakdown

LKT4272-36RKT					
LK	T	4272	36	RK	T
LOK	Laminate	42" x 72"	Height	Racetrack Top Shape	T base

133.9 Lok

Description

Racetrack Table with T Base at Counter Height
(continued)

Veneer Tables
"LKV" Models

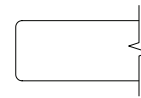

Eased Edge (R3)

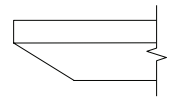

Reverse Bevel Edge (K9)

VENEER	D	W	H	CTN WT	CU FT	① Model	Essentials	Artisan	Essentials	Artisan
		48	72	36	144	87	LKV4872-36RKT	\$3,431	\$3,706	\$3,737
	36	72	36	125	66	LKV3672-36RKT	\$3,168	\$3,422	\$3,455	\$3,678
	36	66	36	117	62	LKV3666-36RKT	\$3,063	\$3,308	\$3,340	\$3,555
	36	60	36	125	57	LKV3660-36RKT	\$2,995	\$3,237	\$3,265	\$3,477

LOK - TEAMWORK

Electrical Options and Upcharges

CT2	
Dual Power Center Top - Black	CT2BL - add \$1,773
Dual Power Center Top - White	CT2WH - add \$1,773
CU1	
Single Power Underside - Black	CU11C - add \$690
Single Power Underside with Wireless Charging - Black	CU11CW - add \$1,651

Note: Order power infeed that best fits application

To Order, Specify:

① Veneer Model #	② Edge Detail	③ Wood Collection	④ Top Wood Finish	⑤ Electrical	⑥ Metal Color
Veneer (LKV)	See Edge Detail Options	Essentials	See Essentials Top Wood Finish Options	N None CT2 Dual Power Center Top CU1 Single Power Underside (See chart above)	See Metal Finish Color Options
		Artisan	④ Top Wood Finish See Artisan Top Wood Finish Options		

Description

Oval Table with T Base at Counter Height

Laminate Tables
"LKT" Models

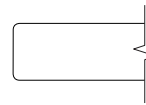

Eased Edge (R3)

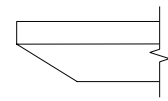

Reverse Bevel Edge (K9)

LAMI	D	W	H	CTN WT	CU FT	1 Model	Standard Tier 1	Graded In Tier 2	Standard Tier 1	Graded In Tier 2
		36	72	36	113	67	LKT3672-360VT	\$2,410	\$2,493	\$2,944

Features:

- price reflects complete table - top and base
- ships KD in multiple cartons
- model includes adjustable glide

Options:

- specify power option and or charging option, see below for options and upcharges

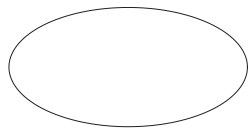

top shape

LOK - TEAMWORK

To Order Specify

1 Laminate Model #	2 Edge Detail	3 Laminate Selection	3a PVC Edge Color	4 Electrical
Laminate (LKT)	See Edge Detail Options	See Laminate Selection	See PVC Edge Color Options	N None CT2 Dual Power Center Top (See chart on next page) CU1 Single Power Underside 5 Metal Finish See Metal Finish Color Options

Model Number Breakdown

LKT3672-360VT					
LK	T	3672	36	OV	T
LOK	Laminate	36" x 72"	Height	Oval Top Shape	T base

Description

Oval Table with T Base at Counter Height
(continued)

Veneer Tables
"LKV" Models

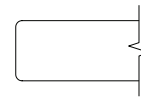

Eased Edge (R3)

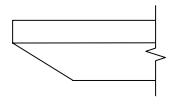

Reverse Bevel Edge (K9)

VEN.	D	W	H	CTN WT	CU FT	① Model	Eased Edge (R3)		Reverse Bevel Edge (K9)	
							Essentials	Artisan	Essentials	Artisan
	36	72	36	113	67	LKV3672-360VT	\$2,977	\$3,216	\$3,243	\$3,456

LOK - TEAMWORK

Electrical Options and Upcharges

CT2	
Dual Power Center Top - Black	CT2BL - add \$1,773
Dual Power Center Top - White	CT2WH - add \$1,773
CU1	
Single Power Underside - Black	CU11C - add \$690
Single Power Underside with Wireless Charging - Black	CU11CW - add \$1,651

Note: Order power infeed that best fits application

To Order, Specify:

① Veneer Model #	② Edge Detail	③ Wood Collection	④ Top Wood Finish	⑤ Electrical	⑥ Metal Color
Veneer (LKV)	See Edge Detail Options	Essentials	See Essentials Top Wood Finish Options	N None CT2 Dual Power Center Top CU1 Single Power Underside (See chart above)	See Metal Finish Color Options
		Artisan	④ Top Wood Finish See Artisan Top Wood Finish Options		

Description

Boat Table with T Base at Counter Height

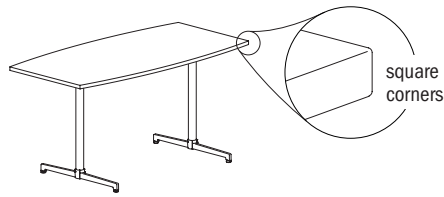

Laminate Tables
"LKT" Models

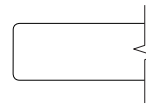

Eased Edge (R3)

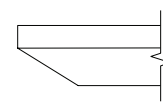

Reverse Bevel Edge (K9)

LAMINATE	D	W	H	CTN WT	CU FT	1 Model	Standard Tier 1	Graded In Tier 2	Standard Tier 1	Graded In Tier 2
	48	72	36	156	87	LKT4872-36BTT	\$2,724	\$2,777	\$3,334	\$3,388
	42	72	36	107	87	LKT4272-36BTT	\$2,599	\$2,647	\$3,196	\$3,243
	36	72	36	130	66	LKT3672-36BTT	\$2,410	\$2,493	\$2,944	\$3,026
	36	66	36	122	62	LKT3666-36BTT	\$2,341	\$2,417	\$2,875	\$2,951
	36	60	36	130	57	LKT3660-36BTT	\$2,259	\$2,333	\$2,795	\$2,865

Features:

- price reflects complete table - top and base
- ships KD in multiple cartons
- model includes adjustable glide

Options:

- specify power option and or charging option, see below for options and upcharges



top shape

LOK - TEAMWORK

To Order Specify

1 Laminate Model #	2 Edge Detail	3 Laminate Selection	3a PVC Edge Color	4 Electrical
Laminate (LKT)	See Edge Detail Options	See Laminate Selection	See PVC Edge Color Options	N None CT2 Dual Power Center Top (See chart on next page) CU1 Single Power Underside 5 Metal Finish See Metal Finish Color Options

Model Number Breakdown

LKT4872-36BTT					
LK	T	4872	36	BT	T
LOK	Laminate	48" x 72"	Height	Boat Top Shape	T base

Description

Boat Table with T Base at Counter Height
(continued)

Veneer Tables
"LKV" Models

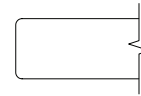

Eased Edge (R3)

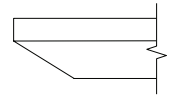

Reverse Bevel Edge (K9)

D	W	H	CTN WT	CU FT	① Model	Eased Edge (R3)		Reverse Bevel Edge (K9)	
						Essentials	Artisan	Essentials	Artisan
48	72	36	156	87	LKV4872-36BTT	\$3,431	\$3,706	\$3,737	\$3,982
42	72	36	143	78	LKV4272-36BTT	\$3,301	\$3,563	\$3,599	\$3,831
36	72	36	130	66	LKV3672-36BTT	\$3,168	\$3,422	\$3,455	\$3,678
36	66	36	122	62	LKV3666-36BTT	\$3,063	\$3,308	\$3,340	\$3,555
36	60	36	130	57	LKV3660-36BTT	\$2,995	\$3,237	\$3,265	\$3,477

VENEER

LOK - TEAMWORK

Electrical Options and Upcharges

CT2	
Dual Power Center Top - Black	CT2BL - add \$1,773
Dual Power Center Top - White	CT2WH - add \$1,773
CU1	
Single Power Underside - Black	CU11C - add \$690
Single Power Underside with Wireless Charging - Black	CU11CW - add \$1,651

Note: Order power infeed that best fits application

To Order, Specify:

① Veneer Model #	② Edge Detail	③ Wood Collection	④ Top Wood Finish	⑤ Electrical	⑥ Metal Color
Veneer (LKV)	See Edge Detail Options	Essentials	See Essentials Top Wood Finish Options	N None CT2 Dual Power Center Top CU1 Single Power Underside (See chart above)	See Metal Finish Color Options
		Artisan	④ Top Wood Finish See Artisan Top Wood Finish Options		

Description

Rounded Boat Table with T Base at Counter Height

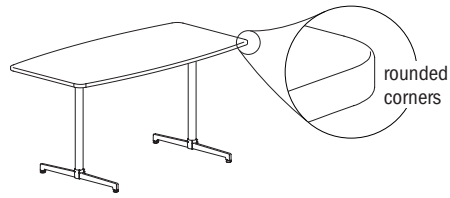

Laminate Tables
"LKT" Models

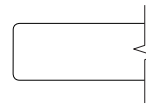

Eased Edge (R3)

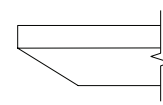

Reverse Bevel Edge (K9)

LAMINATE	D	W	H	CTN WT	CU FT	Model	Standard Tier 1	Graded In Tier 2	Standard Tier 1	Graded In Tier 2
		48	72	36	156	87	LKT4872-36BTRT	\$2,724	\$2,777	\$3,334
	42	72	36	143	78	LKT4272-36BTRT	\$2,599	\$2,647	\$3,196	\$3,243
	36	72	36	130	66	LKT3672-36BTRT	\$2,410	\$2,493	\$2,944	\$3,026
	36	66	36	122	62	LKT3666-36BTRT	\$2,341	\$2,417	\$2,875	\$2,951
	36	60	36	130	57	LKT3660-36BTRT	\$2,259	\$2,333	\$2,795	\$2,865

Features:

- price reflects complete table - top and base
- ships KD in multiple cartons
- model includes adjustable glide

Options:

- specify power option and or charging option, see below for options and upcharges



top shape

LOK - TEAMWORK

To Order Specify

1 Laminate Model #	2 Edge Detail	3 Laminate Selection	3a PVC Edge Color	4 Electrical
Laminate (LKT)	See Edge Detail Options	See Laminate Selection	See PVC Edge Color Options	N None CT2 Dual Power Center Top (See chart on next page) CU1 Single Power Underside 5 Metal Finish See Metal Finish Color Options

Model Number Breakdown

LKT3048-29TTT						
LK	T	4872	36	BT	R	T
LOK	Laminate	48" x 72"	Height	Boat Top Shape	Rounded Corner	T base

Description

Rounded Boat Table with T Base at Counter Height
(continued)

Veneer Tables
"LKV" Models

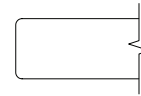

Eased Edge (R3)

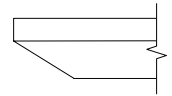

Reverse Bevel Edge (K9)

VENEER	D	W	H	CTN WT	CU FT	① Model	Essentials	Artisan	Essentials	Artisan
		48	72	36	156	87	LKV4872-36BTRT	\$3,431	\$3,706	\$3,737
	42	72	36	143	78	LKV4272-36BTRT	\$3,301	\$3,563	\$3,599	\$3,831
	36	72	36	130	66	LKV3672-36BTRT	\$3,168	\$3,422	\$3,455	\$3,678
	36	66	36	122	62	LKV3666-36BTRT	\$3,063	\$3,308	\$3,340	\$3,555
	36	60	36	130	57	LKV3660-36BTRT	\$2,995	\$3,237	\$3,265	\$3,477

LOK - TEAMWORK

Electrical Options and Upcharges

CT2	
Dual Power Center Top - Black	CT2BL - add \$1,773
Dual Power Center Top - White	CT2WH - add \$1,773
CU1	
Single Power Underside - Black	CU11C - add \$690
Single Power Underside with Wireless Charging - Black	CU11CW - add \$1,651

Note: Order power infeed that best fits application

To Order, Specify:

① Veneer Model #	② Edge Detail	③ Wood Collection	④ Top Wood Finish	⑤ Electrical	⑥ Metal Color
Veneer (LKV)	See Edge Detail Options	Essentials	See Essentials Top Wood Finish Options	N None CT2 Dual Power Center Top CU1 Single Power Underside (See chart above)	See Metal Finish Color Options
		Artisan	④ Top Wood Finish See Artisan Top Wood Finish Options		

Description

Rounded Double Chevron Table with T Base at Counter Height

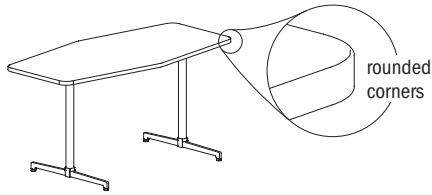

Laminate Tables "LKT" Models

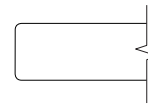

Eased Edge (R3)

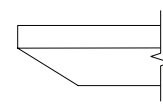

Reverse Bevel Edge (K9)

LAMINATE

D	W	H	CTN WT	CU FT	Model	Eased Edge (R3)		Reverse Bevel Edge (K9)	
						Standard Tier 1	Graded In Tier 2	Standard Tier 1	Graded In Tier 2
48	72	36	150	87	LKT4872-36DCRT	\$2,724	\$2,777	\$3,334	\$3,388
48	60	36	131	74	LKT4860-36DCRT	\$2,520	\$2,563	\$3,115	\$3,158
42	72	36	136	77	LKT4272-36DCRT	\$2,599	\$2,647	\$3,196	\$3,243
42	60	36	119	65	LKT4260-36DCRT	\$2,415	\$2,455	\$3,002	\$3,041
36	72	36	122	66	LKT3672-36DCRT	\$2,410	\$2,493	\$2,944	\$3,026
36	60	36	122	57	LKT3660-36DCRT	\$2,259	\$2,333	\$2,795	\$2,865

Features:

- price reflects complete table - top and base
- ships KD in multiple cartons
- model includes adjustable glide

Options:

- specify power option and or charging option, see below for options and upcharges

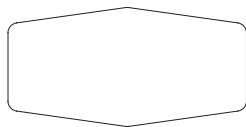

top shape

LOK - TEAMWORK

To Order Specify

1 Laminate Model #	2 Edge Detail	3 Laminate Selection	3a PVC Edge Color	4 Electrical
Laminate (LKT)	See Edge Detail Options	See Laminate Selection	See PVC Edge Color Options	N None CT2 Dual Power Center Top (See chart on next page) CU1 Single Power Underside 5 Metal Finish See Metal Finish Color Options

Model Number Breakdown

LKT4872-36DCRT						
LK	T	4872	36	DC	R	T
LOK	Laminate	48" x 72"	Height	Double Chevron Top Shape	Rounded Corner	T base

Description

Rounded Double Chevron Table with T Base at Counter Height (continued)

Veneer Tables
"LKV" Models

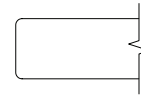

Eased Edge (R3)

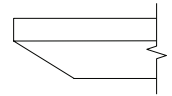

Reverse Bevel Edge (K9)

D	W	H	CTN WT	CU FT	① Model	Eased Edge (R3)		Reverse Bevel Edge (K9)	
						Essentials	Artisan	Essentials	Artisan
48	72	36	150	87	LKV4872-36DCRT	\$3,431	\$3,706	\$3,737	\$3,982
48	60	36	131	74	LKV4860-36DCRT	\$3,217	\$3,473	\$3,508	\$3,732
42	72	36	136	77	LKV4272-36DCRT	\$3,301	\$3,563	\$3,599	\$3,831
42	60	36	119	65	LKV4260-36DCRT	\$3,108	\$3,355	\$3,388	\$3,606
36	72	36	122	66	LKV3672-36DCRT	\$3,125	\$3,375	\$3,404	\$3,626
36	60	36	122	57	LKV3660-36DCRT	\$2,950	\$3,188	\$3,217	\$3,425

VENEER

LOK - TEAMWORK

Electrical Options and Upcharges

CT2	
Dual Power Center Top - Black	CT2BL - add \$1,773
Dual Power Center Top - White	CT2WH - add \$1,773
CU1	
Single Power Underside - Black	CU11C - add \$690
Single Power Underside with Wireless Charging - Black	CU11CW - add \$1,651

Note: Order power infeed that best fits application

To Order, Specify:

① Veneer Model #	② Edge Detail	③ Wood Collection	④ Top Wood Finish	⑤ Electrical	⑥ Metal Color
Veneer (LKV)	See Edge Detail Options	Essentials	See Essentials Top Wood Finish Options	N None CT2 Dual Power Center Top CU1 Single Power Underside (See chart above)	See Metal Finish Color Options
		Artisan	④ Top Wood Finish See Artisan Top Wood Finish Options		

Description

Taper Table with T Base at Counter Height

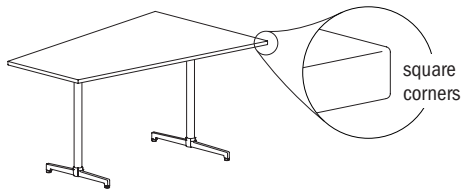

Laminate Tables
"LKT" Models

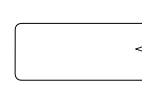

Eased Edge (R3)

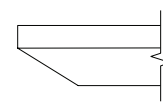

Reverse Bevel Edge (K9)

LAMI	D	W	H	CTN WT	CU FT	1 Model	Standard Tier 1	Graded In Tier 2	Standard Tier 1	Graded In Tier 2
		48	72	36	140	87	LKT4872-36TPT	\$2,736	\$2,792	\$3,346

Features:

- price reflects complete table - top and base
- ships KD in multiple cartons
- model includes adjustable glide

Options:

- specify power option and or charging option, see below for options and upcharges

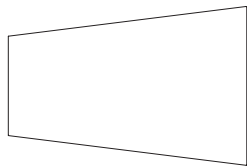

top shape

LOK - TEAMWORK

To Order Specify

1 Laminate Model #	2 Edge Detail	3 Laminate Selection	3a PVC Edge Color	4 Electrical
Laminate (LKT)	See Edge Detail Options	See Laminate Selection	See PVC Edge Color Options	N None CT2 Dual Power Center Top (See chart on next page) CU1 Single Power Underside 5 Metal Finish See Metal Finish Color Options

Model Number Breakdown

LKT4872-36TPT					
LK	T	4872	36	TP	T
LOK	Laminate	48" x 72"	Height	Taper Top Shape	T base

Description

Taper Table with T Base at Counter Height
(continued)

Veneer Tables
"LKV" Models

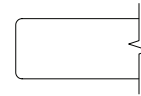

Eased Edge (R3)

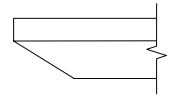

Reverse Bevel Edge (K9)

VEN.	D	W	H	CTN WT	CU FT	① Model	Eased Edge (R3)		Reverse Bevel Edge (K9)	
							Essentials	Artisan	Essentials	Artisan
	48	72	36	140	87	LKV4872-36TPT	\$3,444	\$3,721	\$3,755	\$3,999

LOK - TEAMWORK

Electrical Options and Upcharges

CT2	
Dual Power Center Top - Black	CT2BL - add \$1,773
Dual Power Center Top - White	CT2WH - add \$1,773
CU1	
Single Power Underside - Black	CU11C - add \$690
Single Power Underside with Wireless Charging - Black	CU11CW - add \$1,651

Note: Order power infeed that best fits application

To Order, Specify:

① Veneer Model #	② Edge Detail	③ Wood Collection	④ Top Wood Finish	⑤ Electrical	⑥ Metal Color
Veneer (LKV)	See Edge Detail Options	Essentials	See Essentials Top Wood Finish Options	N None CT2 Dual Power Center Top CU1 Single Power Underside (See chart above)	See Metal Finish Color Options
		Artisan	④ Top Wood Finish See Artisan Top Wood Finish Options		

Description

Rounded Taper Table with T Base at Counter Height

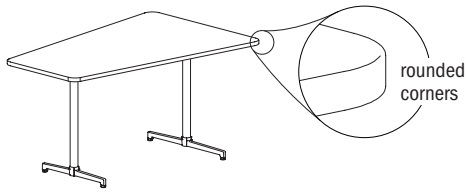

Laminate Tables
"LKT" Models

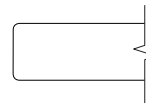

Eased Edge (R3)

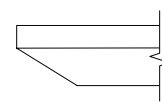

Reverse Bevel Edge (K9)

LAMI	D	W	H	CTN WT	CU FT	1 Model	Standard Tier 1	Graded In Tier 2	Standard Tier 1	Graded In Tier 2
		48	72	36	140	87	LKT4872-36TPRT	\$2,736	\$2,792	\$3,346

Features:

- price reflects complete table - top and base
- ships KD in multiple cartons
- model includes adjustable glide

Options:

- specify power option and or charging option, see below for options and upcharges

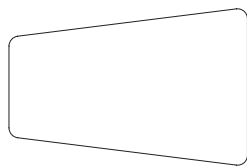

top shape

LOK - TEAMWORK

To Order Specify

1 Laminate Model #	2 Edge Detail	3 Laminate Selection	3a PVC Edge Color	4 Electrical
Laminate (LKT)	See Edge Detail Options	See Laminate Selection	See PVC Edge Color Options	N None CT2 Dual Power Center Top (See chart on next page) CU1 Single Power Underside 5 Metal Finish See Metal Finish Color Options

Model Number Breakdown

LKT4872-36TPRT						
LK	T	4872	36	TP	R	T
LOK	Laminate	48" x 72"	Height	Taper Top Shape	Rounded Corner	T base

Description

Rounded Taper Table with T Base at Counter Height
(continued)

Veneer Tables
"LKV" Models

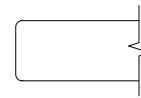

Eased Edge (R3)

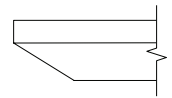

Reverse Bevel Edge (K9)

VEN.	D	W	H	CTN WT	CU FT	① Model	Eased Edge (R3)		Reverse Bevel Edge (K9)	
							Essentials	Artisan	Essentials	Artisan
	48	72	36	140	87	LKV4872-36TPRT	\$3,444	\$3,721	\$3,755	\$3,999

LOK - TEAMWORK

Electrical Options and Upcharges

CT2	
Dual Power Center Top - Black	CT2BL - add \$1,773
Dual Power Center Top - White	CT2WH - add \$1,773
CU1	
Single Power Underside - Black	CU11C - add \$690
Single Power Underside with Wireless Charging - Black	CU11CW - add \$1,651

Note: Order power infeed that best fits application

To Order, Specify:

① Veneer Model #	② Edge Detail	③ Wood Collection	④ Top Wood Finish	⑤ Electrical	⑥ Metal Color
Veneer (LKV)	See Edge Detail Options	Essentials	See Essentials Top Wood Finish Options	N None CT2 Dual Power Center Top CU1 Single Power Underside (See chart above)	See Metal Finish Color Options
		Artisan	④ Top Wood Finish See Artisan Top Wood Finish Options		

Description

Bullet Table with T Base at Counter Height

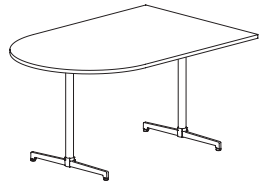

Laminate Tables
"LKT" Models

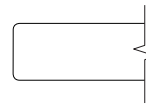

Eased Edge (R3)

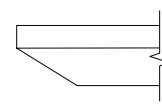

Reverse Bevel Edge (K9)

LAMI	D	W	H	CTN WT	CU FT	Model	Standard Tier 1	Graded In Tier 2	Standard Tier 1	Graded In Tier 2
		48	72	36	154	87	LKT4872-36BUT	\$2,724	\$2,777	\$3,334

Features:

- price reflects complete table - top and base
- ships KD in multiple cartons
- model includes adjustable glide

Options:

- specify power option and or charging option, see below for options and upcharges

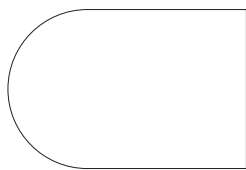

top shape

LOK - TEAMWORK

To Order Specify

1 Laminate Model #	2 Edge Detail	3 Laminate Selection	3a PVC Edge Color	4 Electrical
Laminate (LKT)	See Edge Detail Options	See Laminate Selection	See PVC Edge Color Options	N None CT2 Dual Power Center Top (See chart on next page) CU1 Single Power Underside 5 Metal Finish See Metal Finish Color Options

Model Number Breakdown

LKT4872-36BUT					
LK	T	4872	36	BU	T
LOK	Laminate	48" x 72"	Height	Bullet Top Shape	T base

Description

Bullet Table with T Base at Counter Height
(continued)

Veneer Tables
"LKV" Models

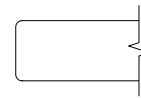

Eased Edge (R3)

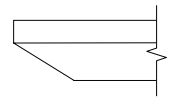

Reverse Bevel Edge (K9)

VEN.	D	W	H	CTN WT	CU FT	① Model	Essentials		Artisan	
	48	72	36	154	87	LKV4872-36BUT	\$3,431		\$3,706	
									\$3,737	\$3,982

LOK - TEAMWORK

Electrical Options and Upcharges

CT2	
Dual Power Center Top - Black	CT2BL - add \$1,773
Dual Power Center Top - White	CT2WH - add \$1,773
CU1	
Single Power Underside - Black	CU11C - add \$690
Single Power Underside with Wireless Charging - Black	CU11CW - add \$1,651

Note: Order power infeed that best fits application

To Order, Specify:

① Veneer Model #	② Edge Detail	③ Wood Collection	④ Top Wood Finish	⑤ Electrical	⑥ Metal Color
Veneer (LKV)	See Edge Detail Options	Essentials	See Essentials Top Wood Finish Options	N None CT2 Dual Power Center Top CU1 Single Power Underside (See chart above)	See Metal Finish Color Options
		Artisan	④ Top Wood Finish See Artisan Top Wood Finish Options		

Description

Hive Table with T Base at Counter Height

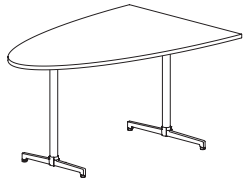

Laminate Tables
"LKT" Models

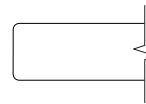

Eased Edge (R3)

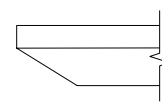

Reverse Bevel Edge (K9)

LAMI	D	W	H	CTN WT	CU FT	1 Model	Standard Tier 1	Graded In Tier 2	Standard Tier 1	Graded In Tier 2
		48	72	36	135	87	LKT4872-36HVT	\$2,724	\$2,777	\$3,334

Features:

- price reflects complete table - top and base
- ships KD in multiple cartons
- model includes adjustable glide

Options:

- specify power option and or charging option, see below for options and upcharges

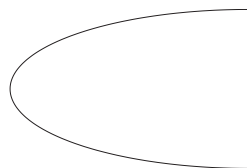

top shape

LOK - TEAMWORK

To Order Specify

1 Laminate Model #	2 Edge Detail	3 Laminate Selection	3a PVC Edge Color	4 Electrical
Laminate (LKT)	See Edge Detail Options	See Laminate Selection	See PVC Edge Color Options	N None CT2 Dual Power Center Top (See chart on next page) CU1 Single Power Underside 5 Metal Finish See Metal Finish Color Options

Model Number Breakdown

LKT4872-36HVT					
LK	T	4872	36	HV	T
LOK	Laminate	48" x 72"	Height	Hive Top Shape	T base

Description

Hive Table with T Base at Counter Height
(continued)

Veneer Tables
"LKV" Models

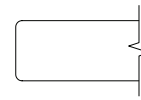

Eased Edge (R3)

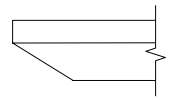

Reverse Bevel Edge (K9)

VEN.	D	W	H	CTN WT	CU FT	① Model	Eased Edge (R3)		Reverse Bevel Edge (K9)	
							Essentials	Artisan	Essentials	Artisan
	48	72	36	135	87	LKV4872-36HVT	\$3,431	\$3,706	\$3,737	\$3,982

LOK - TEAMWORK

Electrical Options and Upcharges

CT2	
Dual Power Center Top - Black	CT2BL - add \$1,773
Dual Power Center Top - White	CT2WH - add \$1,773
CU1	
Single Power Underside - Black	CU11C - add \$690
Single Power Underside with Wireless Charging - Black	CU11CW - add \$1,651

Note: Order power infeed that best fits application

To Order, Specify:

① Veneer Model #	② Edge Detail	③ Wood Collection	④ Top Wood Finish	⑤ Electrical	⑥ Metal Color
Veneer (LKV)	See Edge Detail Options	Essentials	See Essentials Top Wood Finish Options	N None CT2 Dual Power Center Top CU1 Single Power Underside (See chart above)	See Metal Finish Color Options
		Artisan	④ Top Wood Finish See Artisan Top Wood Finish Options		

Description

Intersect Table with T Base at Counter Height



Laminate Tables
"LKT" Models

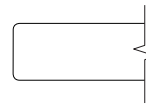

Eased Edge (R3)

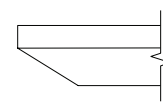

Reverse Bevel Edge (K9)

LAMINATE	D	W	H	CTN WT	CU FT	① Model	Standard Tier 1	Graded In Tier 2	Standard Tier 1	Graded In Tier 2
		30	60	36	118	48	LKT3060-36INT	\$2,464	\$2,493	\$3,034
	24	60	36	113	40	LKT2460-36INT	\$2,409	\$2,430	\$2,966	\$2,990

Features:

- price reflects complete table - top and base
- ships KD in multiple cartons
- model includes adjustable glide

Options:

- specify power option; None (N), add \$594 for EC23 (CTEC23), add \$474 for EC24 (CTEC24)

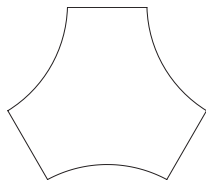

top shape

LOK - TEAMWORK

To Order Specify

Laminate Model #	② Edge Detail	③ Laminate Selection	④ PVC Edge Color	⑤ Electrical
Laminate (LKT)	See Edge Detail Options	See Laminate Selection	See PVC Edge Color Options	N None CTEC23 Power Center Top (See chart on next page) CTEC24 Power Center Top ⑤ Metal Finish See Metal Finish Color Options

Model Number Breakdown

LKT3060-36INT					
LK	T	3060	36	IN	T
LOK	Laminate	30" x 60"	Height	Intersect Top Shape	T base

Description

Intersect Table with T Base at Counter Height
(continued)

Veneer Tables
"LKV" Models

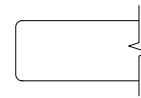

Eased Edge (R3)

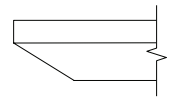

Reverse Bevel Edge (K9)

VENEER	D	W	H	CTN WT	CU FT	① Model	Essentials	Artisan	Essentials	Artisan
	30	60	36	118	48	LKV3060-36INT	\$3,147	\$3,398	\$3,429	\$3,653
24	60	36	113	40	LKV2460-36INT	\$3,092	\$3,340	\$3,372	\$3,590	

LOK - TEAMWORK

Electrical Options and Upcharges

CTEC23	
EC23 Power Center Top - Black	CTEC23BL - add \$594
EC23 Power Center Top - White	CTEC23WH - add \$594
CTEC24	
EC24 Power Center Top - Black	CTEC43BL - add \$474
EC24 Power Center Top - White	CTEC43WH - add \$474

Note: Order power infeed that best fits application

To Order, Specify:

① Veneer Model #	② Edge Detail	③ Wood Collection	④ Top Wood Finish	⑤ Electrical	⑥ Metal Color
Veneer (LKV)	See Edge Detail Options	Essentials	See Essentials Top Wood Finish Options	N None CTEC23 Power Center Top CTEC24 Power Center Top (See chart above)	See Metal Finish Color Options
		Artisan	④ Top Wood Finish See Artisan Top Wood Finish Options		

Description

One-Twenty Table with T Base at Counter Height

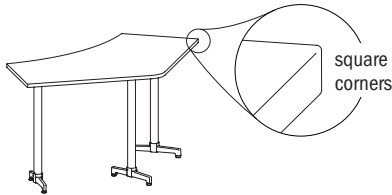

Laminate Tables
"LKT" Models

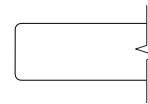

Eased Edge (R3)

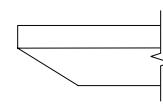

Reverse Bevel Edge (K9)

LAMINATE	D	W	H	CTN WT	CU FT	1 Model	Standard Tier 1	Graded In Tier 2	Standard Tier 1	Graded In Tier 2
		45	84	36	118	94	LKT4584-36YGT	\$3,591	\$3,651	\$4,213
	42	73	36	107	78	LKT4273-36YGT	\$3,110	\$3,156	\$3,710	\$3,755

Features:

- price reflects complete table - top and base
- ships KD in multiple cartons
- model includes adjustable glide

Options:

- specify power option and or charging option, see below for options and upcharges

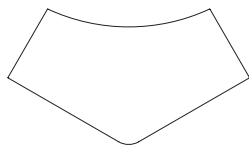

top shape

LOK - TEAMWORK

To Order Specify

1 Laminite Model #	2 Edge Detail	3 Laminite Selection	3a PVC Edge Color	4 Electrical
Laminite (LKT)	See Edge Detail Options	See Laminite Selection	See PVC Edge Color Options	<p>N None</p> <p>CT1 Single Power Center Top</p> <p>CU1 Single Power Underside</p> <p>CT1U1 Single Power Center Top</p> <p>LRT2 Dual Power Left/Right</p> <p>LRT2CU1 Dual Power Left/Right Top w/Underside</p> <p>(See chart on next page)</p>
				5 Metal Finish
				See Metal Finish Color Options

Model Number Breakdown

LKT4584-36YGT					
LK	T	4584	36	YG	T
LOK	Laminite	45" x 84"	Height	One-Twenty Top Shape	T base

Description

One-Twenty Table with T Base at Counter Height
(continued)

Veneer Tables
"LKV" Models

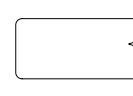

Eased Edge (R3)

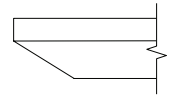

Reverse Bevel Edge (K9)

VENEER	D	W	H	CTN WT	CU FT	① Model	Essentials	Artisan	Essentials	Artisan
	45	84	36	118	94	LKV4584-36YGT	\$4,076	\$4,402	\$4,442	\$4,728
42	73	36	107	78	LKV4273-36YGT	\$3,813	\$4,117	\$4,154	\$4,425	

Electrical Options and Upcharges

	73 - 84 wide	
	Circuit 1	Circuit 2
CT1		
Single Power Center Top - Black	CT11CBL - add \$846	CT12CBL - add \$846
Single Power Center Top - White	CT11CWH - add \$846	CT12CWH - add \$846
CU1		
Single Power Underside - Black	CU11C - add \$853	CU12C - add \$853
Single Power Underside with Wireless Charging - Black	CU11CW - add \$1,843	CU12CW - add \$1,843
CT1U1		
Single Power Center Top - Black with Underside	CT1U1-1CBL - add \$1,599	CT1U1-2CBL - add \$1,599
Single Power Center Top - White with Underside	CT1U1-1CWH - add \$1,599	CT1U1-2CWH - add \$1,599
Single Power Center Top - Black with Wireless Charging	CT1U1-1CWBL - add \$2,558	CT1U1-2CWBL - add \$2,558
Single Power Center Top - White with Wireless Charging	CT1U1-1CWHW - add \$2,558	CT1U1-2CWHW - add \$2,558
LRT2CU1		
Dual Power Left/Right Top with Underside - Black	LRT2CU1-1CBL - add \$2,978	LRT2CU1-2CBL - add \$2,978
Dual Power Left/Right Top with Underside - White	LRT2CU1-1CWH - add \$2,978	LRT2CU1-2CWH - add \$2,978
Dual Power Left/Right Top - Black with Underside & Wireless Charging	LRT2CU1-1CWBL - add \$3,938	LRT2CU1-2CWBL - add \$3,938
Dual Power Left/Right Top - White with Underside & Wireless Charging	LRT2CU1-1CWHW - add \$3,938	LRT2CU1-2CWHW - add \$3,938
LRT2		
Dual Power Left/Right Top - Black	LRT2-1CBL - add \$1,447	LRT2-2CBL - add \$1,447
Dual Power Left/Right Top - White	LRT2-1CWH - add \$1,447	LRT2-2CWH - add \$1,447

LOK - TEAMWORK

Note: Order power infeed that best fits application

To Order, Specify:

① Veneer Model #	② Edge Detail	③ Wood Collection	④ Top Wood Finish	⑤ Electrical	⑥ Metal Color
Veneer (LKV)	See Edge Detail Options	Essentials	See Essentials Top Wood Finish Options	N None CT1 Single Power Center Top CU1 Single Power Underside CT1U1 Single Power Center Top LRT2 Dual Power Left/Right LRT2CU1 Dual Power Left/Right Top with Underside (See chart above)	See Metal Finish Color Options
		Artisan	④ Top Wood Finish See Artisan Top Wood Finish Options		

Description

Rounded One-Twenty Table with T Base at Counter Height

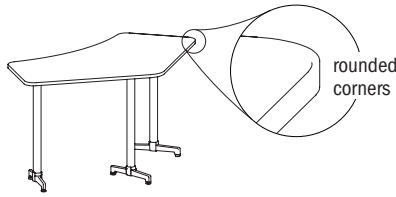

Laminate Tables "LKT" Models

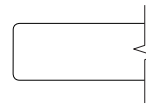

Eased Edge (R3)

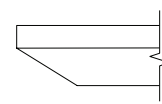

Reverse Bevel Edge (K9)

LAMINATE	D	W	H	CTN WT	CU FT	1 Model	Standard Tier 1	Graded In Tier 2	Standard Tier 1	Graded In Tier 2
		45	84	36	118	94	LKT4584-36YGRT	\$3,591	\$3,651	\$4,213
	42	73	36	107	78	LKT4273-36YGRT	\$3,110	\$3,156	\$3,710	\$3,755

Features:

- price reflects complete table - top and base
- ships KD in multiple cartons
- model includes adjustable glide

Options:

- specify power option and or charging option, see below for options and upcharges

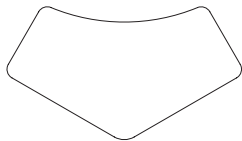

top shape

LOK - TEAMWORK

To Order Specify

1 Laminite Model #	2 Edge Detail	3 Laminite Selection	3a PVC Edge Color	4 Electrical
Laminite (LKT)	See Edge Detail Options	See Laminite Selection	See PVC Edge Color Options	N None CT2 Dual Power Center Top (See chart on next page) CU1 Single Power Underside 5 Metal Finish See Metal Finish Color Options

Model Number Breakdown

LKT4584-36YGRT						
LK	T	4584	36	YG	R	T
LOK	Laminite	45" x 84"	Height	One-Twenty Top Shape	Rounded Corner	T base

Description

Rounded One-twenty Table with T Base at Counter Height (continued)

Veneer Tables "LKV" Models

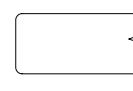

Eased Edge (R3)

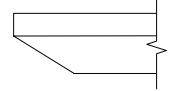

Reverse Bevel Edge (K9)

VENEER	D	W	H	CTN WT	CU FT	Model	Essentials	Artisan	Essentials	Artisan
	45	84	36	118	94	LKV4584-36YGRT	\$4,076	\$4,402	\$4,442	\$4,728
42	73	36	107	78	LKV4273-36YGRT	\$3,813	\$4,117	\$4,154	\$4,425	

Electrical Options and Upcharges

	73 - 84 wide	
	Circuit 1	Circuit 2
CT1		
Single Power Center Top - Black	CT11CBL - add \$846	CT12CBL - add \$846
Single Power Center Top - White	CT11CWH - add \$846	CT12CWH - add \$846
CU1		
Single Power Underside - Black	CU11C - add \$853	CU12C - add \$853
Single Power Underside with Wireless Charging - Black	CU11CW - add \$1,843	CU12CW - add \$1,843
CT1U1		
Single Power Center Top - Black with Underside	CT1U1-1CBL - add \$1,599	CT1U1-2CBL - add \$1,599
Single Power Center Top - White with Underside	CT1U1-1CWH - add \$1,599	CT1U1-2CWH - add \$1,599
Single Power Center Top - Black with Wireless Charging	CT1U1-1CWBL - add \$2,558	CT1U1-2CWBL - add \$2,558
Single Power Center Top - White with Wireless Charging	CT1U1-1CWHW - add \$2,558	CT1U1-2CWHW - add \$2,558
LRT2CU1		
Dual Power Left/Right Top with Underside - Black	LRT2CU1-1CBL - add \$2,978	LRT2CU1-2CBL - add \$2,978
Dual Power Left/Right Top with Underside - White	LRT2CU1-1CWH - add \$2,978	LRT2CU1-2CWH - add \$2,978
Dual Power Left/Right Top - Black with Underside & Wireless Charging	LRT2CU1-1CWBL - add \$3,938	LRT2CU1-2CWBL - add \$3,938
Dual Power Left/Right Top - White with Underside & Wireless Charging	LRT2CU1-1CWHW - add \$3,938	LRT2CU1-2CWHW - add \$3,938
LRT2		
Dual Power Left/Right Top - Black	LRT2-1CBL - add \$1,447	LRT2-2CBL - add \$1,447
Dual Power Left/Right Top - White	LRT2-1CWH - add \$1,447	LRT2-2CWH - add \$1,447

LOK - TEAMWORK

Note: Order power infeed that best fits application

To Order, Specify:

1 Veneer Model #	2 Edge Detail	3 Wood Collection	4 Top Wood Finish	5 Electrical	6 Metal Color
Veneer (LKV)	See Edge Detail Options	Essentials	See Essentials Top Wood Finish Options	N None CT1 Single Power Center Top CU1 Single Power Underside CT1U1 Single Power Center Top LRT2 Dual Power Left/Right LRT2CU1 Dual Power Left/Right with Underside (See chart above)	See Metal Finish Color Options
		Artisan	4 Top Wood Finish See Artisan Top Wood Finish Options		

Description

Home Base Table with X Base at Counter Height



Laminate Tables
"LKT" Models

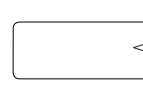

Eased Edge (R3)

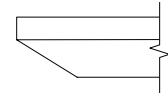

Reverse Bevel Edge (K9)

LAMINATE	D	W	H	CTN WT	CU FT	① Model	Standard Tier 1	Graded In Tier 2	Standard Tier 1	Graded In Tier 2
		30	36	36	75	30	LKT3036-36HBX	\$1,721	\$1,762	\$2,268
	24	30	36	59	21	LKT2430-36HBX	\$1,463	\$1,477	\$2,007	\$2,022

Features:

- price reflects complete table - top and base
- ships KD in multiple cartons
- model includes adjustable glide

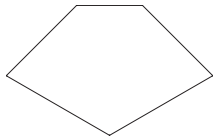

top shape

LOK - TEAMWORK

To Order Specify

① Laminate Model #	② Edge Detail	③ Laminate Selection	④ PVC Edge Color	⑤ Metal Finish
Laminate (LKT)	See Edge Detail Options	See Laminate Selection	See PVC Edge Color Options	See Metal Finish Color Options

Model Number Breakdown

LKT3036-36HBX					
LK	T	3036	36	HB	X
LOK	Laminate	30" x 36"	Height	Home Base Top Shape	X base

133.33 Lok

Description

Home Base Table with X Base at Counter Height
(continued)

Veneer Tables
"LKV" Models

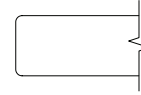

Eased Edge (R3)

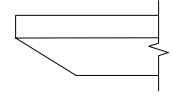

Reverse Bevel Edge (K9)

VENEER	D	W	H	CTN WT	CU FT	① Model	Eased Edge (R3)		Reverse Bevel Edge (K9)	
							Essentials	Artisan	Essentials	Artisan
	30	36	36	75	30	LKV3036-36HBX	\$2,253	\$2,436	\$2,455	\$2,613
	24	30	36	59	21	LKV2430-36HBX	\$2,116	\$2,286	\$2,309	\$2,457

LOK-TEAMWORK

To Order, Specify:

① Veneer Model #	② Edge Detail	③ Wood Collection	④ Top Wood Finish	⑤ Metal Color
Veneer (LKV)	See Edge Detail Options	Essentials	See Essentials Top Wood Finish Options	See Metal Finish Color Options
		Artisan	④ Top Wood Finish See Artisan Top Wood Finish Options	

Description

Boomerang Table - Left with T Base at Counter Height

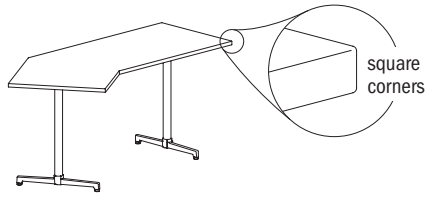

Laminate Tables "LKT" Models

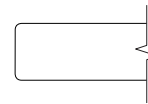

Eased Edge (R3)

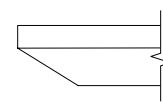

Reverse Bevel Edge (K9)

LAMINATE	D	W	H	CTN WT	CU FT	Model	Standard Tier 1	Graded In Tier 2	Standard Tier 1	Graded In Tier 2
		36	84	36	139	78	LKT3684-36BMLT	\$3,103	\$3,154	\$3,767
	36	84	36	139	78	LKT3684-36BMRT	\$3,103	\$3,154	\$3,767	\$3,817
	30	84	36	121	66	LKT3084-36BMLT	\$2,655	\$2,691	\$3,237	\$3,273
	30	84	36	121	66	LKT3084-36BMRT	\$2,655	\$2,691	\$3,237	\$3,273

Features:

- price reflects complete table - top and base
- ships KD in multiple cartons
- model includes adjustable glide

Options:

- specify power option and or charging option, see below for options and upcharges

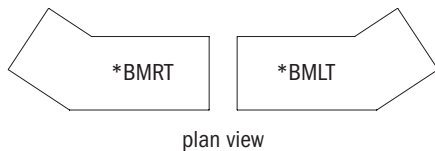

plan view

LOK - TEAMWORK

To Order Specify

1 Laminate Model #	2 Edge Detail	3 Laminate Selection	3a PVC Edge Color	4 Electrical
Laminate (LKT)	See Edge Detail Options	See Laminate Selection	See PVC Edge Color Options	<p>4 Electrical</p> <p>N None CT1U1 Single Power Center Top CT1 Single Power Center Top LRT2 Dual Power Left/Right CU1 Single Power Underside LRT2CU1 Dual Power Left/Right Top w/Underside (See chart on next page)</p> <p>5 Metal Finish</p> <p>See Metal Finish Color Options.</p>

Model Number Breakdown

LKT3684-36BMLT					
LK	T	3684	36	BML	T
LOK	Laminate	36" x 84"	Height	Boomerang Left Top Shape	T base

Description

Boomerang Table - Left with T Base
at Counter Height (continued)

Veneer Tables
"LKV" Models

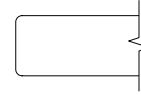

Eased Edge (R3)

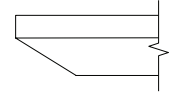

Reverse Bevel Edge (K9)

VENEER	D	W	H	CTN WT	CU FT	① Model	Essentials	Artisan	Essentials	Artisan
		36	84	36	139	78	LKV3684-36BMLT	\$3,955	\$4,268	\$4,310
	36	84	36	139	78	LKV3684-36BMRT	\$3,955	\$4,268	\$4,310	\$4,587
	30	84	36	121	66	LKV3084-36BMLT	\$3,463	\$3,736	\$3,771	\$4,015
	30	84	36	121	66	LKV3084-36BMRT	\$3,463	\$3,736	\$3,771	\$4,015

Electrical Options and Upcharges

	73 - 84 wide	
	Circuit 1	Circuit 2
CT1		
Single Power Center Top - Black	CT11CBL - add \$846	CT12CBL - add \$846
Single Power Center Top - White	CT11CWH - add \$846	CT12CWH - add \$846
CU1		
Single Power Underside - Black	CU11C - add \$853	CU12C - add \$853
Single Power Underside with Wireless Charging - Black	CU11CW - add \$1,843	CU12CW - add \$1,843
CT1U1		
Single Power Center Top - Black with Underside	CT1U1-1CBL - add \$1,599	CT1U1-2CBL - add \$1,599
Single Power Center Top - White with Underside	CT1U1-1CWH - add \$1,599	CT1U1-2CWH - add \$1,599
Single Power Center Top - Black with Wireless Charging	CT1U1-1CWBL - add \$2,558	CT1U1-2CWBL - add \$2,558
Single Power Center Top - White with Wireless Charging	CT1U1-1CWHW - add \$2,558	CT1U1-2CWHW - add \$2,558
LRT2CU1		
Dual Power Left/Right Top with Underside - Black	LRT2CU1-1CBL - add \$2,978	LRT2CU1-2CBL - add \$2,978
Dual Power Left/Right Top with Underside - White	LRT2CU1-1CWH - add \$2,978	LRT2CU1-2CWH - add \$2,978
Dual Power Left/Right Top - Black with Underside & Wireless Charging	LRT2CU1-1CWBL - add \$3,938	LRT2CU1-2CWBL - add \$3,938
Dual Power Left/Right Top - White with Underside & Wireless Charging	LRT2CU1-1CWHW - add \$3,938	LRT2CU1-2CWHW - add \$3,938
LRT2		
Dual Power Left/Right Top - Black	LRT2-1CBL - add \$1,447	LRT2-2CBL - add \$1,447
Dual Power Left/Right Top - White	LRT2-1CWH - add \$1,447	LRT2-2CWH - add \$1,447

LOK - TEAMWORK

Note: Order power infeed that best fits application

To Order, Specify:

① Veneer Model #	② Edge Detail	③ Wood Collection	④ Top Wood Finish	⑤ Electrical	⑥ Metal Color
Veneer (LKV)	See Edge Detail Options	Essentials	See Essentials Top Wood Finish Options	N None CT1 Single Power Center Top CU1 Single Power Underside CT1U1 Single Power Center Top LRT2 Dual Power Left/Right LRT2CU1 Dual Power Left/Right with Underside (See chart above)	See Metal Finish Color Options
			Artisan		

Description

Rounded Boomerang Table - Left with T Base at Counter Height

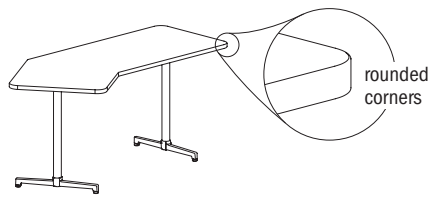

Laminate Tables "LKT" Models

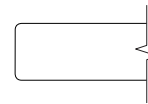

Eased Edge (R3)

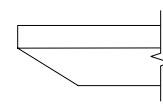

Reverse Bevel Edge (K9)

LAMINATE	D	W	H	CTN WT	CU FT	1 Model	Standard Tier 1	Graded In Tier 2	Standard Tier 1	Graded In Tier 2
		36	84	36	101	78	LKT3684-36BMLRT	\$3,103	\$3,154	\$3,767
	36	84	36	139	78	LKT3684-36BMRRT	\$3,103	\$3,154	\$3,767	\$3,817
	30	84	36	121	66	LKT3084-36BMLRT	\$2,655	\$2,691	\$3,237	\$3,273
	30	84	36	121	66	LKT3084-36BMRRT	\$2,655	\$2,691	\$3,237	\$3,273

Features:

- price reflects complete table - top and base
- ships KD in multiple cartons
- model includes adjustable glide

Options:

- specify power option and or charging option, see below for options and upcharges



top shape

LOK - TEAMWORK

To Order Specify

1 Laminate Model #	2 Edge Detail	3 Laminate Selection	3a PVC Edge Color	4 Electrical
Laminate (LKT)	See Edge Detail Options	See Laminate Selection	See PVC Edge Color Options	<p>4 Electrical</p> <p>N None CT1U1 Single Power Center Top CT1 Single Power Center Top LRT2 Dual Power Left/Right CU1 Single Power Underside LRT2CU1 Dual Power Left/Right Top w/Underside (See chart on next page)</p> <p>5 Metal Finish</p> <p>See Metal Finish Color Options</p>

Model Number Breakdown

LKT3684-36BMLRT						
LK	T	3684	36	BML	R	T
LOK	Laminate	36" x 84"	Height	Boomerang Left Top Shape	Rounded Corner	T base

Description

Rounded Boomerang Table - Left with T Base at Counter Height (continued)

Veneer Tables
"LKV" Models



Eased Edge (R3)

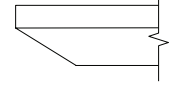

Reverse Bevel Edge (K9)

VENEER	D	W	H	CTN WT	CU FT	① Model	Essentials	Artisan	Essentials	Artisan
		36	84	36	143	78	LKV3684-36BMLRT	\$3,955	\$4,268	\$4,310
	36	84	36	139	78	LKV3684-36BMRRT	\$3,955	\$4,268	\$4,310	\$4,587
	30	84	36	101	66	LKV3084-36BMLRT	\$3,463	\$3,736	\$3,771	\$4,015
	30	84	36	121	66	LKV3084-36BMRRT	\$3,463	\$3,736	\$3,771	\$4,015

Electrical Options and Upcharges

	73 - 84 wide	
	Circuit 1	Circuit 2
CT1		
Single Power Center Top - Black	CT11CBL - add \$846	CT12CBL - add \$846
Single Power Center Top - White	CT11CWH - add \$846	CT12CWH - add \$846
CU1		
Single Power Underside - Black	CU11C - add \$853	CU12C - add \$853
Single Power Underside with Wireless Charging - Black	CU11CW - add \$1,843	CU12CW - add \$1,843
CT1U1		
Single Power Center Top - Black with Underside	CT1U1-1CBL - add \$1,599	CT1U1-2CBL - add \$1,599
Single Power Center Top - White with Underside	CT1U1-1CWH - add \$1,599	CT1U1-2CWH - add \$1,599
Single Power Center Top - Black with Wireless Charging	CT1U1-1CWBL - add \$2,558	CT1U1-2CWBL - add \$2,558
Single Power Center Top - White with Wireless Charging	CT1U1-1CWHW - add \$2,558	CT1U1-2CWHW - add \$2,558
LRT2CU1		
Dual Power Left/Right Top with Underside - Black	LRT2CU1-1CBL - add \$2,978	LRT2CU1-2CBL - add \$2,978
Dual Power Left/Right Top with Underside - White	LRT2CU1-1CWH - add \$2,978	LRT2CU1-2CWH - add \$2,978
Dual Power Left/Right Top - Black with Underside & Wireless Charging	LRT2CU1-1CWBL - add \$3,938	LRT2CU1-2CWBL - add \$3,938
Dual Power Left/Right Top - White with Underside & Wireless Charging	LRT2CU1-1CWHW - add \$3,938	LRT2CU1-2CWHW - add \$3,938
LRT2		
Dual Power Left/Right Top - Black	LRT2-1CBL - add \$1,447	LRT2-2CBL - add \$1,447
Dual Power Left/Right Top - White	LRT2-1CWH - add \$1,447	LRT2-2CWH - add \$1,447

LOK - TEAMWORK

Note: Order power infeed that best fits application

To Order, Specify:

① Veneer Model #	② Edge Detail	③ Wood Collection	④ Top Wood Finish	⑤ Electrical	⑥ Metal Color
Veneer (LKV)	See Edge Detail Options	Essentials	See Essentials Top Wood Finish Options	N None CT1 Single Power Center Top CU1 Single Power Underside CT1U1 Single Power Center Top LRT2 Dual Power Left/Right LRT2CU1 Dual Power Left/Right with Underside (See chart above)	See Metal Finish Color Options
		Artisan	④ Top Wood Finish See Artisan Top Wood Finish Options		

Description

Wedge Table with T Base at Counter Height

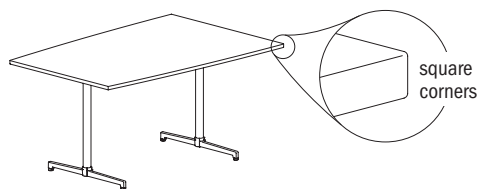

Laminate Tables
"LKT" Models

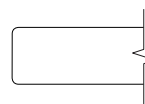

Eased Edge (R3)

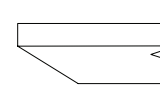

Reverse Bevel Edge (K9)

LAMI	D	W	H	CTN WT	CU FT	1 Model	Standard Tier 1	Graded In Tier 2	Standard Tier 1	Graded In Tier 2
		48	72	36	156	87	LKT4872-36WDT	\$2,724	\$2,777	\$3,334

Features:

- price reflects complete table - top and base
- ships KD in multiple cartons
- model includes adjustable glide

Options:

- specify power option and or charging option, see below for options and upcharges



top shape

LOK - TEAMWORK

To Order Specify

1 Laminate Model #	2 Edge Detail	3 Laminate Selection	3a PVC Edge Color	4 Electrical
Laminate (LKT)	See Edge Detail Options	See Laminate Selection	See PVC Edge Color Options	N None CT2 Dual Power Center Top (See chart on next page) CU1 Single Power Underside 5 Metal Finish See Metal Finish Color Options

Model Number Breakdown

LKT4872-36WDT					
LK	T	4872	36	WD	T
LOK	Laminate	48" x 72"	Height	Wedge Top Shape	T base

Description

Wedge Table with T Base at Counter Height
(continued)

Veneer Tables
"LKV" Models

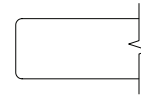

Eased Edge (R3)

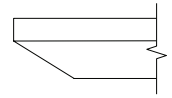

Reverse Bevel Edge (K9)

VEN.	D	W	H	CTN WT	CU FT	① Model	Eased Edge (R3)		Reverse Bevel Edge (K9)	
							Essentials	Artisan	Essentials	Artisan
	48	72	36	156	87	LKV4872-36WDT	\$3,431	\$3,706	\$3,737	\$3,982

LOK - TEAMWORK

Electrical Options and Upcharges

CT2	
Dual Power Center Top - Black	CT2BL - add \$1,773
Dual Power Center Top - White	CT2WH - add \$1,773
CU1	
Single Power Underside - Black	CU11C - add \$690
Single Power Underside with Wireless Charging - Black	CU11CW - add \$1,651

Note: Order power infeed that best fits application

To Order, Specify:

① Veneer Model #	② Edge Detail	③ Wood Collection	④ Top Wood Finish	⑤ Electrical	⑥ Metal Color
Veneer (LKV)	See Edge Detail Options	Essentials	See Essentials Top Wood Finish Options	N None CT2 Dual Power Center Top CU1 Single Power Underside (See chart above)	See Metal Finish Color Options
		Artisan	④ Top Wood Finish See Artisan Top Wood Finish Options		

Description

Rounded Wedge Table with T Base at Counter Height

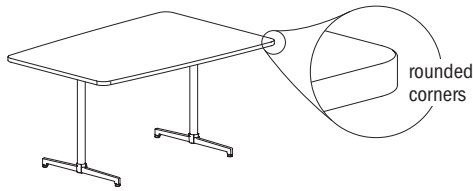

Laminate Tables
"LKT" Models

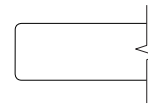

Eased Edge (R3)

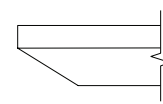

Reverse Bevel Edge (K9)

LAMI	D	W	H	CTN WT	CU FT	1 Model	Standard Tier 1	Graded In Tier 2	Standard Tier 1	Graded In Tier 2
		48	72	36	156	87	LKT4872-36WDRT	\$2,724	\$2,777	\$3,334

Features:

- price reflects complete table - top and base
- ships KD in multiple cartons
- model includes adjustable glide

Options:

- specify power option and or charging option, see below for options and upcharges

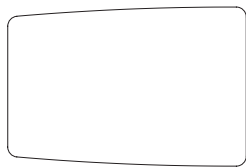

top shape

LOK - TEAMWORK

To Order Specify

1 Laminate Model #	2 Edge Detail	3 Laminate Selection	3a PVC Edge Color	4 Electrical
Laminate (LKT)	See Edge Detail Options	See Laminate Selection	See PVC Edge Color Options	N None CT2 Dual Power Center Top (See chart on next page) CU1 Single Power Underside 5 Metal Finish See Metal Finish Color Options

Model Number Breakdown

LKT4872-36WDRT						
LK	T	4872	36	WD	R	T
LOK	Laminate	48" x 72"	Height	Wedge Top Shape	Rounded Corner	T base

Description

Rounded Wedge Table with T Base at Counter Height
(continued)

Veneer Tables
"LKV" Models

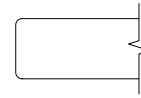

Eased Edge (R3)

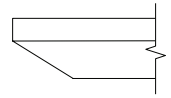

Reverse Bevel Edge (K9)

VEN.	D	W	H	CTN WT	CU FT	① Model	Essentials		Artisan	
	48	72	36	156	87	LKV4872-36WDRT	\$3,431		\$3,706	
									\$3,737	\$3,982

LOK - TEAMWORK

Electrical Options and Upcharges

CT2	
Dual Power Center Top - Black	CT2BL - add \$1,773
Dual Power Center Top - White	CT2WH - add \$1,773
CU1	
Single Power Underside - Black	CU11C - add \$690
Single Power Underside with Wireless Charging - Black	CU11CW - add \$1,651

Note: Order power infeed that best fits application

To Order, Specify:

① Veneer Model #	② Edge Detail	③ Wood Collection	④ Top Wood Finish	⑤ Electrical	⑥ Metal Color
Veneer (LKV)	See Edge Detail Options	Essentials	See Essentials Top Wood Finish Options	N None CT2 Dual Power Center Top CU1 Single Power Underside (See chart above)	See Metal Finish Color Options
		Artisan	④ Top Wood Finish See Artisan Top Wood Finish Options		

Description

Rectangular Table with T Base at Bar Height

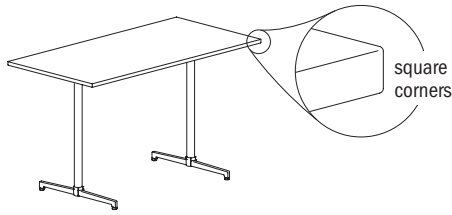

Laminate Tables
"LKT" Models

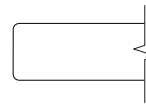

Eased Edge (R3)

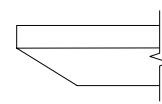

Reverse Bevel Edge (K9)

D	W	H	CTN WT	CU FT	Model	Eased Edge (R3)		Reverse Bevel Edge (K9)	
						Standard Tier 1	Graded In Tier 2	Standard Tier 1	Graded In Tier 2
48	72	42	164	101	LKT4872-42TTT	\$2,808	\$2,861	\$3,447	\$3,503
42	72	42	149	89	LKT4272-42TTT	\$2,683	\$2,732	\$3,310	\$3,358
36	72	42	139	77	LKT3672-42TTT	\$2,427	\$2,510	\$2,988	\$3,071
36	66	42	129	72	LKT3666-42TTT	\$2,349	\$2,427	\$2,907	\$2,988
36	60	42	121	66	LKT3660-42TTT	\$2,253	\$2,323	\$2,813	\$2,888

LAMINATE

Features:

- price reflects complete table - top and base
- ships KD in multiple cartons
- model includes adjustable glide

Options:

- specify power/charging option, see below for options and upcharges

LOK - TEAMWORK

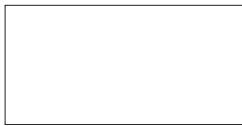

top shape

To Order Specify

1 Laminate Model #	2 Edge Detail	3 Laminate Selection	3a PVC Edge Color	4 Electrical
Laminate (LKT)	See Edge Detail Options	See Laminate Selection	See PVC Edge Color Options	N None CT2 Dual Power Center Top (See chart on next page) CU1 Single Power Underside 5 Metal Finish See Metal Finish Color Options

Model Number Breakdown

LKT4872-42TTT					
LK	T	4872	42	TT	T
LOK	Laminate	48" x 72"	Height	Rectangular Top Shape	T base

Description

Rectangular Table with T Base at Bar Height
(continued)

Veneer Tables
"LKV" Models

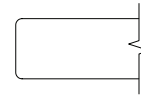

Eased Edge (R3)

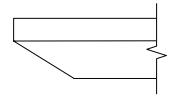

Reverse Bevel Edge (K9)

D	W	H	CTN WT	CU FT	① Model	Eased Edge (R3)		Reverse Bevel Edge (K9)	
						Essentials	Artisan	Essentials	Artisan
48	72	42	140	101	LKV4872-42TTT	\$3,200	\$3,484	\$3,511	\$3,774
42	72	42	149	89	LKV4272-42TTT	\$3,068	\$3,318	\$3,363	\$3,599
36	72	42	139	77	LKV3672-42TTT	\$2,801	\$3,049	\$3,018	\$3,258
36	66	42	129	72	LKV3666-42TTT	\$2,746	\$2,977	\$2,955	\$3,180
36	60	42	121	66	LKV3660-42TTT	\$2,673	\$2,888	\$2,871	\$3,080

VENEER

LOK - TEAMWORK

Electrical Options and Upcharges

CT2	
Dual Power Center Top - Black	CT2BL - add \$1,588
Dual Power Center Top - White	CT2WH - add \$1,588
CU1	
Single Power Underside - Black	CU11C - add \$618
Single Power Underside with Wireless Charging - Black	CU11CW - add \$1,479

Note: Order power infeed that best fits application

To Order, Specify:

① Veneer Model #	② Edge Detail	③ Wood Collection	④ Top Wood Finish	⑤ Electrical	⑥ Metal Color
Veneer (LKV)	See Edge Detail Options	Essentials	See Essentials Top Wood Finish Options	N None CT2 Dual Power Center Top CU1 Single Power Underside (See chart above)	See Metal Finish Color Options
		Artisan	④ Top Wood Finish See Artisan Top Wood Finish Options		

Description

Rounded Rectangular Table with T Base at Bar Height

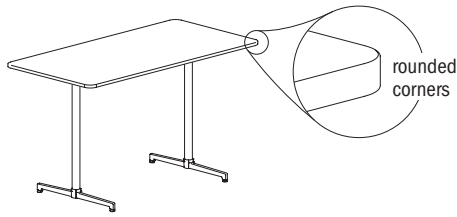

Laminate Tables
"LKT" Models

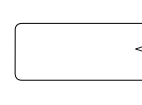

Eased Edge (R3)

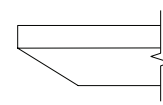

Reverse Bevel Edge (K9)

D	W	H	CTN WT	CU FT	Model	Eased Edge (R3)		Reverse Bevel Edge (K9)	
						Standard Tier 1	Graded In Tier 2	Standard Tier 1	Graded In Tier 2
48	72	42	164	101	LKT4872-42TTRT	\$2,885	\$2,939	\$3,522	\$3,578
42	72	42	149	89	LKT4272-42TTRT	\$2,755	\$2,801	\$3,379	\$3,429
36	72	42	139	77	LKT3672-42TTRT	\$2,624	\$2,665	\$3,239	\$3,279
36	66	42	129	72	LKT3666-42TTRT	\$2,519	\$2,556	\$3,130	\$3,166
36	60	42	121	66	LKT3660-42TTRT	\$2,450	\$2,486	\$3,056	\$3,089

LAMINATE

Features:

- price reflects complete table - top and base
- ships KD in multiple cartons
- model includes adjustable glide

Options:

- specify power/charging option, see below for options and upcharges



top shape

LOK - TEAMWORK

To Order Specify

1 Laminate Model #	2 Edge Detail	3 Laminate Selection	3a PVC Edge Color	4 Electrical
Laminate (LKT)	See Edge Detail Options	See Laminate Selection	See PVC Edge Color Options	N None CT2 Dual Power Center Top (See chart on next page) CU1 Single Power Underside 5 Metal Finish See Metal Finish Color Options

Model Number Breakdown

LKT4872-42TTRT						
LK	T	4872	42	TT	R	T
LOK	Laminate	48" x 72"	Height	Rectangular Top Shape	Rounded Corner	T base

Description

Rounded Rectangular Table with T Base at Bar Height
(continued)

Veneer Tables
"LKV" Models

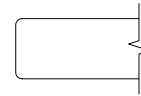

Eased Edge (R3)

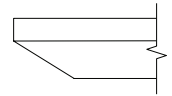

Reverse Bevel Edge (K9)

VENEER	D	W	H	CTN WT	CU FT	① Model	Essentials	Artisan	Essentials	Artisan
		48	72	42	164	101	LKV4872-42TTRT	\$3,273	\$3,561	\$3,586
	42	72	42	149	89	LKV4272-42TTRT	\$3,137	\$3,391	\$3,433	\$3,667
	36	72	42	139	77	LKV3672-42TTRT	\$2,997	\$3,256	\$3,103	\$3,348
	36	66	42	129	72	LKV3666-42TTRT	\$2,889	\$3,091	\$3,165	\$3,349
	36	60	42	121	66	LKV3660-42TTRT	\$2,857	\$3,080	\$2,951	\$3,164

LOK - TEAMWORK

Electrical Options and Upcharges

CT2	
Dual Power Center Top - Black	CT2BL - add \$1,588
Dual Power Center Top - White	CT2WH - add \$1,588
CU1	
Single Power Underside - Black	CU11C - add \$618
Single Power Underside with Wireless Charging - Black	CU11CW - add \$1,479

Note: Order power infeed that best fits application

To Order, Specify:

① Veneer Model #	② Edge Detail	③ Wood Collection	④ Top Wood Finish	⑤ Electrical	⑥ Metal Color
Veneer (LKV)	See Edge Detail Options	Essentials	See Essentials Top Wood Finish Options	N None CT2 Dual Power Center Top CU1 Single Power Underside (See chart above)	See Metal Finish Color Options
		Artisan	④ Top Wood Finish See Artisan Top Wood Finish Options		

Description

Rectangular Table with X Base at Bar Height

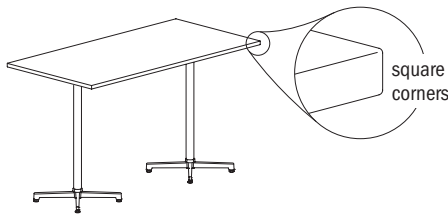

Laminate Tables
"LKT" Models

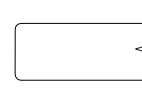

Eased Edge (R3)

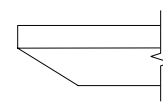

Reverse Bevel Edge (K9)

LAMINATE	D	W	H	CTN WT	CU FT	1 Model	Standard Tier 1	Graded In Tier 2	Standard Tier 1	Graded In Tier 2
		48	72	42	169	101	LKT4872-42TTX	\$3,423	\$3,478	\$4,061
	42	72	42	153	90	LKT4272-42TTX	\$3,299	\$3,346	\$3,925	\$3,973
	36	72	42	136	78	LKT3672-42TTX	\$3,115	\$3,200	\$3,677	\$3,761

Features:

- price reflects complete table - top and base
- ships KD in multiple cartons
- model includes adjustable glide

Options:

- specify power/charging option, see below for options and upcharges

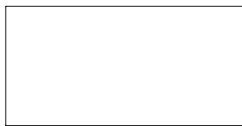

top shape

LOK - TEAMWORK

To Order Specify

1 Laminate Model #	2 Edge Detail	3 Laminate Selection	3a PVC Edge Color	4 Electrical
Laminate (LKT)	See Edge Detail Options	See Laminate Selection	See PVC Edge Color Options	N None CT2 Dual Power Center Top (See chart on next page) CU1 Single Power Underside 5 Metal Finish See Metal Finish Color Options

Model Number Breakdown

LKT4872-42TTX					
LK	T	4872	42	TT	X
LOK	Laminate	48" x 72"	Height	Rectangular Top Shape	X base

Description

Rectangular Table with X Base at Bar Height
(continued)

Veneer Tables
"LKV" Models

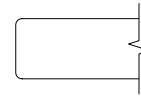

Eased Edge (R3)

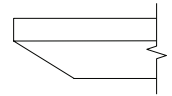

Reverse Bevel Edge (K9)

VENEER	D	W	H	CTN WT	CU FT	① Model	Essentials	Artisan	Essentials	Artisan
		48	72	42	169	101	LKV4872-42TTX	\$3,815	\$4,103	\$4,127
	42	72	42	153	90	LKV4272-42TTX	\$3,683	\$3,935	\$3,981	\$4,213
	36	72	42	136	78	LKV3672-42TTX	\$3,491	\$3,736	\$3,707	\$3,947

LOK - TEAMWORK

Electrical Options and Upcharges

CT2	
Dual Power Center Top - Black	CT2BL - add \$1,588
Dual Power Center Top - White	CT2WH - add \$1,588
CU1	
Single Power Underside - Black	CU11C - add \$618
Single Power Underside with Wireless Charging - Black	CU11CW - add \$1,479

Note: Order power infeed that best fits application

To Order, Specify:

① Veneer Model #	② Edge Detail	③ Wood Collection	④ Top Wood Finish	⑤ Electrical	⑥ Metal Color
Veneer (LKV)	See Edge Detail Options	Essentials	See Essentials Top Wood Finish Options	N None CT2 Dual Power Center Top CU1 Single Power Underside (See chart above)	See Metal Finish Color Options
		Artisan	④ Top Wood Finish See Artisan Top Wood Finish Options		

Description

Rectangular Table with X Base at Bar Height

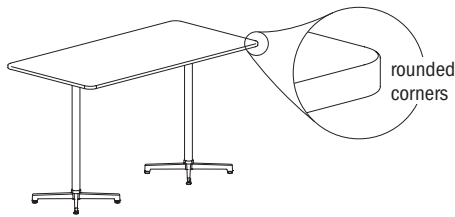

Laminate Tables
"LKT" Models

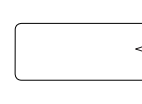

Eased Edge (R3)

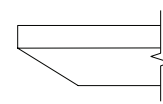

Reverse Bevel Edge (K9)

LAMINATE	D	W	H	CTN WT	CU FT	1 Model	Standard Tier 1	Graded In Tier 2	Standard Tier 1	Graded In Tier 2
		48	72	42	169	101	LKT4872-42TTRX	\$3,423	\$3,478	\$4,061
	42	72	42	153	90	LKT4272-42TTRX	\$3,299	\$3,346	\$3,925	\$3,973
	36	72	42	136	78	LKT3672-42TTRX	\$3,238	\$3,324	\$3,798	\$3,890

Features:

- price reflects complete table - top and base
- ships KD in multiple cartons
- model includes adjustable glide

Options:

- specify power/charging option, see below for options and upcharges

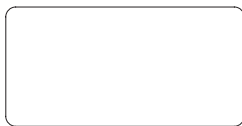

top shape

LOK - TEAMWORK

To Order Specify

1 Laminate Model #	2 Edge Detail	3 Laminate Selection	3a PVC Edge Color	4 Electrical
Laminate (LKT)	See Edge Detail Options	See Laminate Selection	See PVC Edge Color Options	N None CT2 Dual Power Center Top (See chart on next page) CU1 Single Power Underside 5 Metal Finish See Metal Finish Color Options

Model Number Breakdown

LKT4872-42TTRX						
LK	T	4872	42	TT	R	X
LOK	Laminate	48" x 72"	Height	Rectangular Top Shape	Rounded Corner	X base

Description

Rectangular Table with X Base at Bar Height
(continued)

Veneer Tables
"LKV" Models

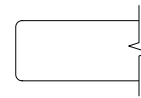

Eased Edge (R3)

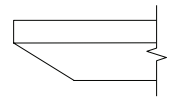

Reverse Bevel Edge (K9)

VENEER	D	W	H	CTN WT	CU FT	① Model	Essentials	Artisan	Essentials	Artisan
		48	72	42	169	101	LKV4872-42TTRX	\$3,815	\$4,103	\$4,127
	42	72	42	153	90	LKV4272-42TTRX	\$3,728	\$3,988	\$3,981	\$4,213
	36	72	42	136	78	LKV3672-42TTRX	\$3,683	\$3,935	\$3,836	\$4,081

LOK - TEAMWORK

Electrical Options and Upcharges

CT2	
Dual Power Center Top - Black	CT2BL - add \$1,588
Dual Power Center Top - White	CT2WH - add \$1,588
CU1	
Single Power Underside - Black	CU11C - add \$618
Single Power Underside with Wireless Charging - Black	CU11CW - add \$1,479

Note: Order power infeed that best fits application

To Order, Specify:

① Veneer Model #	② Edge Detail	③ Wood Collection	④ Top Wood Finish	⑤ Electrical	⑥ Metal Color
Veneer (LKV)	See Edge Detail Options	Essentials	See Essentials Top Wood Finish Options	N None CT2 Dual Power Center Top CU1 Single Power Underside (See chart above)	See Metal Finish Color Options
		Artisan	④ Top Wood Finish See Artisan Top Wood Finish Options		

Description

Arc Rectangular Table with T Base at Bar Height

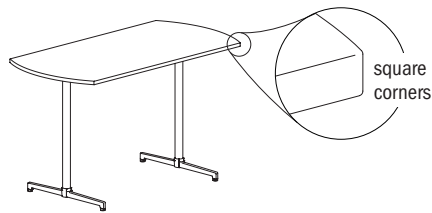

Laminate Tables
"LKT" Models

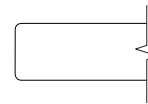

Eased Edge (R3)

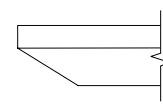

Reverse Bevel Edge (K9)

D	W	H	CTN WT	CU FT	① Model	Eased Edge (R3)		Reverse Bevel Edge (K9)	
						Standard Tier 1	Graded In Tier 2	Standard Tier 1	Graded In Tier 2
48	72	42	155	101	LKT4872-42ART	\$2,746	\$2,800	\$3,355	\$3,407
42	72	42	143	89	LKT4272-42ART	\$2,621	\$2,668	\$3,219	\$3,266
36	72	42	134	77	LKT3672-42ART	\$2,499	\$2,536	\$3,087	\$3,125
36	66	42	125	72	LKT3666-42ART	\$2,401	\$2,437	\$2,980	\$3,018
36	60	42	116	66	LKT3660-42ART	\$2,336	\$2,367	\$2,910	\$2,943

LAMINATE

Features:

- price reflects complete table - top and base
- ships KD in multiple cartons
- model includes adjustable glide

Options:

- specify power/charging option, see below for options and upcharges

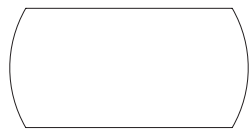

top shape

LOK - TEAMWORK

To Order Specify

① Laminate Model #	② Edge Detail	③ Laminate Selection	④ PVC Edge Color	⑤ Electrical
Laminate (LKT)	See Edge Detail Options	See Laminate Selection	See PVC Edge Color Options	N None CT2 Dual Power Center Top (See chart on next page) CU1 Single Power Underside ⑤ Metal Finish See Metal Finish Color Options

Model Number Breakdown

LKT4872-42ART					
LK	T	4872	42	AR	T
LOK	Laminate	48" x 72"	Height	Arc Rectangular Top Shape	T base

Description

Arc Rectangular Table with T Base at Bar Height
(continued)

Veneer Tables
"LKV" Models

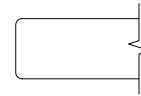

Eased Edge (R3)

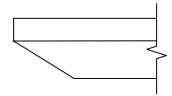

Reverse Bevel Edge (K9)

VENEER	D	W	H	CTN WT	CU FT	① Model	Essentials	Artisan	Essentials	Artisan
		48	72	42	155	101	LKV4872-42ART	\$3,455	\$3,729	\$3,763
	42	72	42	143	89	LKV4272-42ART	\$3,323	\$3,587	\$3,623	\$3,855
	36	72	42	134	77	LKV3672-42ART	\$3,191	\$3,446	\$3,477	\$3,705
	36	66	42	125	72	LKV3666-42ART	\$3,087	\$3,333	\$3,363	\$3,583
	36	60	42	116	66	LKV3660-42ART	\$2,685	\$2,861	\$2,943	\$3,103

LOK - TEAMWORK

Electrical Options and Upcharges

CT2	
Dual Power Center Top - Black	CT2BL - add \$1,588
Dual Power Center Top - White	CT2WH - add \$1,588
CU1	
Single Power Underside - Black	CU11C - add \$618
Single Power Underside with Wireless Charging - Black	CU11CW - add \$1,479

Note: Order power infeed that best fits application

To Order, Specify:

① Veneer Model #	② Edge Detail	③ Wood Collection	④ Top Wood Finish	⑤ Electrical	⑥ Metal Color
Veneer (LKV)	See Edge Detail Options	Essentials	See Essentials Top Wood Finish Options	N None CT2 Dual Power Center Top CU1 Single Power Underside (See chart above)	See Metal Finish Color Options
		Artisan	④ Top Wood Finish See Artisan Top Wood Finish Options		

Description

Rounded Arc Rectangular Table with T Base at Bar Height

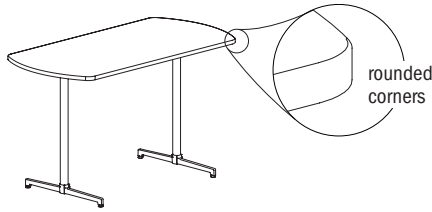

Laminate Tables
"LKT" Models

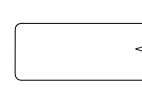

Eased Edge (R3)

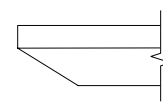

Reverse Bevel Edge (K9)

D	W	H	CTN WT	CU FT	Model	Eased Edge (R3)		Reverse Bevel Edge (K9)	
						Standard Tier 1	Graded In Tier 2	Standard Tier 1	Graded In Tier 2
48	72	42	155	101	LKT4872-42ARRT	\$2,746	\$2,800	\$3,355	\$3,407
42	72	42	143	89	LKT4272-42ARRT	\$2,621	\$2,668	\$3,219	\$3,266
36	72	42	134	77	LKT3672-42ARRT	\$2,499	\$2,536	\$3,087	\$3,125
36	66	42	125	72	LKT3666-42ARRT	\$2,401	\$2,437	\$2,980	\$3,018
36	60	42	116	66	LKT3660-42ARRT	\$2,336	\$2,367	\$2,910	\$2,943

LAMINATE

Features:

- price reflects complete table - top and base
- ships KD in multiple cartons
- model includes adjustable glide

Options:

- specify power/charging option, see below for options and upcharges



top shape

LOK - TEAMWORK

To Order Specify

1 Laminate Model #	2 Edge Detail	3 Laminate Selection	3a PVC Edge Color	4 Electrical
Laminate (LKT)	See Edge Detail Options	See Laminate Selection	See PVC Edge Color Options	N None CT2 Dual Power Center Top (See chart on next page) CU1 Single Power Underside 5 Metal Finish See Metal Finish Color Options

Model Number Breakdown

LKT4872-42ARRT						
LK	T	4872	42	AR	R	T
LOK	Laminate	48" x 72"	Height	Arc Rectangular Top Shape	Rounded Corner	T base

Description

Rounded Arc Rectangular Table with T Base at Bar Height (continued)

Veneer Tables "LKV" Models

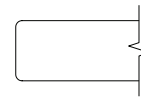

Eased Edge (R3)

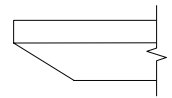

Reverse Bevel Edge (K9)

VENEER	D	W	H	CTN WT	CU FT	① Model	Eased Edge (R3)		Reverse Bevel Edge (K9)	
							Essentials	Artisan	Essentials	Artisan
	48	72	42	155	101	LKV4872-42ARRT	\$3,119	\$3,393	\$3,418	\$3,668
	42	72	42	143	89	LKV4272-42ARRT	\$2,989	\$3,230	\$3,272	\$3,495
	36	72	42	134	77	LKV3672-42ARRT	\$2,857	\$3,065	\$3,127	\$3,317
	36	66	42	125	72	LKV3666-42ARRT	\$2,751	\$2,944	\$3,017	\$3,192
	36	60	42	116	66	LKV3660-42ARRT	\$2,685	\$2,861	\$2,943	\$3,103

LOK - TEAMWORK

Electrical Options and Upcharges

CT2	
Dual Power Center Top - Black	CT2BL - add \$1,588
Dual Power Center Top - White	CT2WH - add \$1,588
CU1	
Single Power Underside - Black	CU11C - add \$618
Single Power Underside with Wireless Charging - Black	CU11CW - add \$1,479

Note: Order power infeed that best fits application

To Order, Specify:

① Veneer Model #	② Edge Detail	③ Wood Collection	④ Top Wood Finish	⑤ Electrical	⑥ Metal Color
Veneer (LKV)	See Edge Detail Options	Essentials	See Essentials Top Wood Finish Options	N None CT2 Dual Power Center Top CU1 Single Power Underside (See chart above)	See Metal Finish Color Options
		Artisan	④ Top Wood Finish See Artisan Top Wood Finish Options		

Description

Racetrack Table with T Base at Bar Height



Laminate Tables "LKT" Models

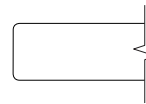

Eased Edge (R3)

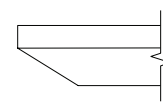

Reverse Bevel Edge (K9)

LAMINATE	D	W	H	CTN WT	CU FT	1 Model	Standard Tier 1	Graded In Tier 2	Standard Tier 1	Graded In Tier 2
		42	72	42	136	89	LKT4272-42RKT	\$2,621	\$2,668	\$3,219
	36	72	42	129	77	LKT3672-42RKT	\$2,499	\$2,536	\$3,087	\$3,125
	36	66	42	120	72	LKT3666-42RKT	\$2,401	\$2,437	\$2,980	\$3,018
	36	60	42	110	66	LKT3660-42RKT	\$2,336	\$2,367	\$2,910	\$2,943

Features:

- price reflects complete table - top and base
- ships KD in multiple cartons
- model includes adjustable glide

Options:

- specify power/charging option, see below for options and upcharges



top shape

LOK - TEAMWORK

To Order Specify

1 Laminate Model #	2 Edge Detail	3 Laminate Selection	3a PVC Edge Color	4 Electrical
Laminate (LKT)	See Edge Detail Options	See Laminate Selection	See PVC Edge Color Options	N None CT2 Dual Power Center Top (See chart on next page) CU1 Single Power Underside 5 Metal Finish See Metal Finish Color Options

Model Number Breakdown

LKT4872-42RKT					
LK	T	4872	42	RK	T
LOK	Laminate	48" x 72"	Height	Racetrack Top Shape	T base

Description

Racetrack Table with
T Base at Bar Height
(continued)

Veneer Tables
"LKV" Models

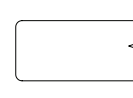

Eased Edge (R3)

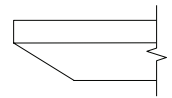

Reverse Bevel Edge (K9)

VENEER	D	W	H	CTN WT	CU FT	① Model	Eased Edge (R3)		Reverse Bevel Edge (K9)	
							Essentials	Artisan	Essentials	Artisan
	48	72	42	147	101	LKV4872-42RKT	\$3,455	\$3,729	\$3,763	\$4,007
	36	72	42	129	77	LKV3672-42RKT	\$3,191	\$3,446	\$3,477	\$3,705
	36	66	42	120	72	LKV3666-42RKT	\$3,087	\$3,333	\$3,363	\$3,583
	36	60	42	110	66	LKV3660-42RKT	\$3,019	\$3,262	\$3,293	\$3,505

LOK - TEAMWORK

Electrical Options and Upcharges

CT2	
Dual Power Center Top - Black	CT2BL - add \$1,588
Dual Power Center Top - White	CT2WH - add \$1,588
CU1	
Single Power Underside - Black	CU11C - add \$618
Single Power Underside with Wireless Charging - Black	CU11CW - add \$1,479

Note: Order power infeed that best fits application

To Order, Specify:

① Veneer Model #	② Edge Detail	③ Wood Collection	④ Top Wood Finish	⑤ Electrical	⑥ Metal Color
Veneer (LKV)	See Edge Detail Options	Essentials	See Essentials Top Wood Finish Options	N None CT2 Dual Power Center Top CU1 Single Power Underside (See chart above)	See Metal Finish Color Options
		Artisan	④ Top Wood Finish See Artisan Top Wood Finish Options		

Description

Oval Table with T Base at Bar Height



Laminate Tables "LKT" Models

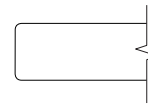

Eased Edge (R3)

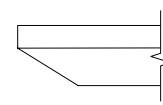

Reverse Bevel Edge (K9)

LAMI	D	W	H	CTN WT	CU FT	Model	Standard Tier 1	Graded In Tier 2	Standard Tier 1	Graded In Tier 2
		36	72	42	119	77	LKT3672-420VT	\$2,499	\$2,536	\$3,087

Features:

- price reflects complete table - top and base
- ships KD in multiple cartons
- model includes adjustable glide

Options:

- specify power/charging option, see below for options and upcharges

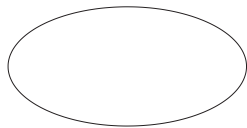

top shape

LOK - TEAMWORK

To Order Specify

1 Laminate Model #	2 Edge Detail	3 Laminate Selection	3a PVC Edge Color	4 Electrical
Laminate (LKT)	See Edge Detail Options	See Laminate Selection	See PVC Edge Color Options	N None CT2 Dual Power Center Top (See chart on next page) CU1 Single Power Underside 5 Metal Finish See Metal Finish Color Options

Model Number Breakdown

LKT4272-42RKT					
LK	T	4272	42	OV	T
LOK	Laminate	42" x 72"	Height	Oval Top Shape	T base

Description

Oval Table with T Base at Bar Height
(continued)

Veneer Tables
"LKV" Models

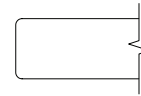

Eased Edge (R3)

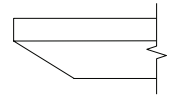

Reverse Bevel Edge (K9)

VEN.	D	W	H	CTN WT	CU FT	① Model	Essentials		Artisan	
							Essentials	Artisan	Essentials	Artisan
	36	72	42	119	77	LKV3672-42OVT	\$3,165	\$3,419	\$3,450	\$3,675

LOK - TEAMWORK

Electrical Options and Upcharges

CT2	
Dual Power Center Top - Black	CT2BL - add \$1,588
Dual Power Center Top - White	CT2WH - add \$1,588
CU1	
Single Power Underside - Black	CU11C - add \$618
Single Power Underside with Wireless Charging - Black	CU11CW - add \$1,479

Note: Order power infeed that best fits application

To Order, Specify:

① Veneer Model #	② Edge Detail	③ Wood Collection	④ Top Wood Finish	⑤ Electrical	⑥ Metal Color
Veneer (LKV)	See Edge Detail Options	Essentials	See Essentials Top Wood Finish Options	N None CT2 Dual Power Center Top CU1 Single Power Underside (See chart above)	See Metal Finish Color Options
		Artisan	④ Top Wood Finish See Artisan Top Wood Finish Options		

Description

Boat Table with T Base
at Bar Height

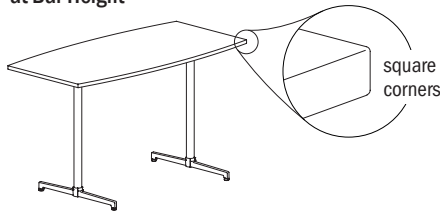

Laminate Tables
"LKT" Models

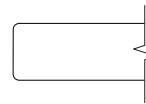

Eased Edge (R3)

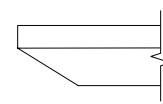

Reverse Bevel Edge (K9)

LAMINATE	D	W	H	CTN WT	CU FT	Model	Standard Tier 1	Graded In Tier 2	Standard Tier 1	Graded In Tier 2
		48	72	42	159	101	LKT4872-42BTT	\$2,746	\$2,800	\$3,355
	42	72	42	144	89	LKT4272-42BTT	\$2,621	\$2,668	\$3,219	\$3,266
	36	72	42	133	77	LKT3672-42BTT	\$2,499	\$2,536	\$3,087	\$3,125
	36	66	42	125	72	LKT3666-42BTT	\$2,401	\$2,437	\$2,980	\$3,018
	36	60	42	117	66	LKT3660-42BTT	\$2,336	\$2,367	\$2,910	\$2,943

Features:

- price reflects complete table - top and base
- ships KD in multiple cartons
- model includes adjustable glide

Options:

- specify power/charging option, see below for options and upcharges



top shape

LOK - TEAMWORK

To Order Specify

1 Laminate Model #	2 Edge Detail	3 Laminate Selection	3a PVC Edge Color	4 Electrical
Laminate (LKT)	See Edge Detail Options	See Laminate Selection	See PVC Edge Color Options	N None CT2 Dual Power Center Top (See chart on next page) CU1 Single Power Underside 5 Metal Finish See Metal Finish Color Options

Model Number Breakdown

LKT4872-42BTT					
LK	T	4872	42	BT	T
LOK	Laminate	48" x 72"	Height	Boat Top Shape	T base

Description

Boat Table with T Base
at Bar Height
(continued)

Veneer Tables
"LKV" Models

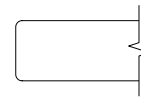

Eased Edge (R3)

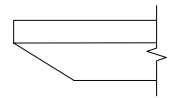

Reverse Bevel Edge (K9)

D	W	H	CTN WT	CU FT	① Model	Eased Edge (R3)		Reverse Bevel Edge (K9)	
						Essentials	Artisan	Essentials	Artisan
48	72	42	159	101	LKV4872-42BTT	\$3,455	\$3,729	\$3,763	\$4,007
42	72	42	144	89	LKV4272-42BTT	\$3,323	\$3,587	\$3,623	\$3,855
36	72	42	133	77	LKV3672-42BTT	\$3,191	\$3,446	\$3,477	\$3,705
36	66	42	125	72	LKV3666-42BTT	\$3,087	\$3,333	\$3,363	\$3,583
36	60	42	117	66	LKV3660-42BTT	\$3,019	\$3,262	\$3,293	\$3,505

VENEER

LOK - TEAMWORK

Electrical Options and Upcharges

CT2	
Dual Power Center Top - Black	CT2BL - add \$1,588
Dual Power Center Top - White	CT2WH - add \$1,588
CU1	
Single Power Underside - Black	CU11C - add \$618
Single Power Underside with Wireless Charging - Black	CU11CW - add \$1,479

Note: Order power infeed that best fits application

To Order, Specify:

① Veneer Model #	② Edge Detail	③ Wood Collection	④ Top Wood Finish	⑤ Electrical	⑥ Metal Color
Veneer (LKV)	See Edge Detail Options	Essentials	See Essentials Top Wood Finish Options	N None CT2 Dual Power Center Top CU1 Single Power Underside (See chart above)	See Metal Finish Color Options
		Artisan	④ Top Wood Finish See Artisan Top Wood Finish Options		

Description

Rounded Boat Table with T Base at Bar Height

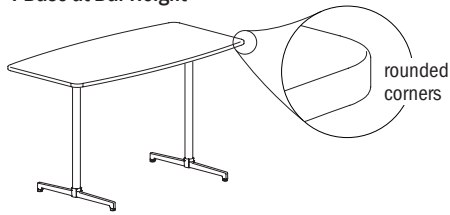

Laminate Tables
"LKT" Models

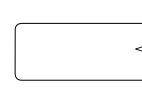

Eased Edge (R3)

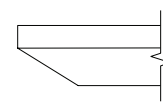

Reverse Bevel Edge (K9)

D	W	H	CTN WT	CU FT	① Model	Eased Edge (R3)		Reverse Bevel Edge (K9)	
						Standard Tier 1	Graded In Tier 2	Standard Tier 1	Graded In Tier 2
48	72	42	159	101	LKT4872-42BTRT	\$2,746	\$2,800	\$3,355	\$3,407
42	72	42	144	89	LKT4272-42BTRT	\$2,621	\$2,668	\$3,219	\$3,266
36	72	42	133	77	LKT3672-42BTRT	\$2,499	\$2,536	\$3,087	\$3,125
36	66	42	125	72	LKT3666-42BTRT	\$2,401	\$2,437	\$2,980	\$3,018
36	60	42	117	66	LKT3660-42BTRT	\$2,336	\$2,367	\$2,910	\$2,943

LAMINATE

Features:

- price reflects complete table - top and base
- ships KD in multiple cartons
- model includes adjustable glide

Options:

- specify power/charging option, see below for options and upcharges

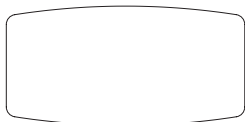

top shape

LOK - TEAMWORK

To Order Specify

① Laminate Model #	② Edge Detail	③ Laminate Selection	④ PVC Edge Color	⑤ Electrical
Laminate (LKT)	See Edge Detail Options	See Laminate Selection	See PVC Edge Color Options	N None CT2 Dual Power Center Top (See chart on next page) CU1 Single Power Underside ⑤ Metal Finish See Metal Finish Color Options

Model Number Breakdown

LKT4872-42BTRT						
LK	T	4872	42	BT	R	T
LOK	Laminate	48" x 72"	Height	Boat Top Shape	Rounded Corner	T base

Description

Rounded Boat Table with
T Base at Bar Height
(continued)

Veneer Tables
"LKV" Models



Eased Edge (R3)

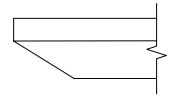

Reverse Bevel Edge (K9)

D	W	H	CTN WT	CU FT	① Model	Eased Edge (R3)		Reverse Bevel Edge (K9)	
						Essentials	Artisan	Essentials	Artisan
48	72	42	159	101	LKV4872-42BTRT	\$3,455	\$3,729	\$3,763	\$4,007
42	72	42	144	89	LKV4272-42BTRT	\$3,323	\$3,587	\$3,623	\$3,855
36	72	42	133	77	LKV3672-42BTRT	\$3,191	\$3,446	\$3,477	\$3,705
36	66	42	125	72	LKV3666-42BTRT	\$3,087	\$3,333	\$3,363	\$3,583
36	60	42	117	66	LKV3660-42BTRT	\$3,019	\$3,262	\$3,293	\$3,505

VENEER

LOK - TEAMWORK

Electrical Options and Upcharges

CT2	
Dual Power Center Top - Black	CT2BL - add \$1,588
Dual Power Center Top - White	CT2WH - add \$1,588
CU1	
Single Power Underside - Black	CU11C - add \$618
Single Power Underside with Wireless Charging - Black	CU11CW - add \$1,479

Note: Order power infeed that best fits application

To Order, Specify:

① Veneer Model #	② Edge Detail	③ Wood Collection	④ Top Wood Finish	⑤ Electrical	⑥ Metal Color
Veneer (LKV)	See Edge Detail Options	Essentials	See Essentials Top Wood Finish Options	N None CT2 Dual Power Center Top CU1 Single Power Underside (See chart above)	See Metal Finish Color Options
		Artisan	④ Top Wood Finish See Artisan Top Wood Finish Options		

Description

Rounded Double Chevron Table with T Base at Bar Height

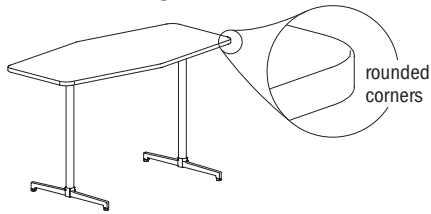

Laminate Tables
"LKT" Models

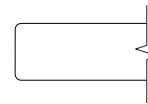

Eased Edge (R3)

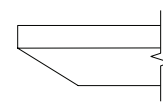

Reverse Bevel Edge (K9)

LAMINATE

D	W	H	CTN WT	CU FT	Model	Eased Edge (R3)		Reverse Bevel Edge (K9)	
						Standard Tier 1	Graded In Tier 2	Standard Tier 1	Graded In Tier 2
48	72	42	153	101	LKT4872-42DCRT	\$2,746	\$2,800	\$3,355	\$3,407
48	60	42	135	85	LKT4860-42DCRT	\$2,544	\$2,588	\$3,137	\$3,181
42	72	42	137	89	LKT4272-42DCRT	\$2,621	\$2,668	\$3,219	\$3,266
42	60	42	121	75	LKT4260-42DCRT	\$2,440	\$2,475	\$3,024	\$3,061
36	72	42	125	77	LKT3672-42DCRT	\$2,499	\$2,536	\$3,087	\$3,125
36	60	42	111	66	LKT3660-42DCRT	\$2,336	\$2,367	\$2,910	\$2,943

Features:

- price reflects complete table - top and base
- ships KD in multiple cartons
- model includes adjustable glide

Options:

- specify power/charging option, see below for options and upcharges

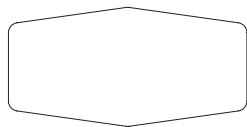

top shape

LOK - TEAMWORK

To Order Specify

1 Laminate Model #	2 Edge Detail	3 Laminate Selection	3a PVC Edge Color	4 Electrical
Laminate (LKT)	See Edge Detail Options	See Laminate Selection	See PVC Edge Color Options	N None CT2 Dual Power Center Top (See chart on next page) CU1 Single Power Underside 5 Metal Finish See Metal Finish Color Options

Model Number Breakdown

LKT4872-42DCRT						
LK	T	4872	42	DC	R	T
LOK	Laminate	48" x 72"	Height	Double Chevron Top Shape	Rounded Corner	T base

Description

Rounded Double Chevron Table with T Base at Bar Height (continued)

Veneer Tables "LKV" Models

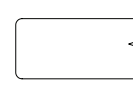

Eased Edge (R3)

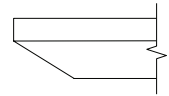

Reverse Bevel Edge (K9)

D	W	H	CTN WT	CU FT	① Model	Eased Edge (R3)		Reverse Bevel Edge (K9)	
						Essentials	Artisan	Essentials	Artisan
48	72	42	153	101	LKV4872-42DCRT	\$3,455	\$3,729	\$3,763	\$4,007
48	60	42	135	85	LKV4860-42DCRT	\$3,240	\$3,501	\$3,529	\$3,761
42	72	42	137	89	LKV4272-42DCRT	\$3,323	\$3,587	\$3,623	\$3,855
42	60	42	121	75	LKV4260-42DCRT	\$3,130	\$3,379	\$3,415	\$3,633
36	72	42	125	77	LKV3672-42DCRT	\$3,263	\$3,522	\$3,555	\$3,786
36	60	42	111	66	LKV3660-42DCRT	\$3,046	\$3,289	\$3,318	\$3,532

VENEER

LOK - TEAMWORK

Electrical Options and Upcharges

CT2	
Dual Power Center Top - Black	CT2BL - add \$1,588
Dual Power Center Top - White	CT2WH - add \$1,588
CU1	
Single Power Underside - Black	CU11C - add \$618
Single Power Underside with Wireless Charging - Black	CU11CW - add \$1,479

Note: Order power infeed that best fits application

To Order, Specify:

① Veneer Model #	② Edge Detail	③ Wood Collection	④ Top Wood Finish	⑤ Electrical	⑥ Metal Color
Veneer (LKV)	See Edge Detail Options	Essentials	See Essentials Top Wood Finish Options	N None CT2 Dual Power Center Top CU1 Single Power Underside (See chart above)	See Metal Finish Color Options
		Artisan	④ Top Wood Finish See Artisan Top Wood Finish Options		

Description

Taper Table with T Base at Bar Height

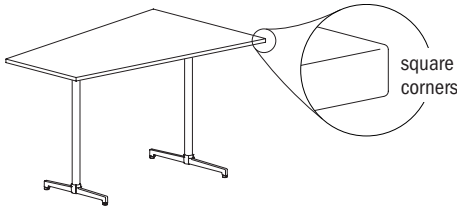

Laminate Tables "LKT" Models

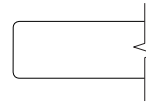

Eased Edge (R3)

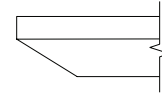

Reverse Bevel Edge (K9)

LAMI	D	W	H	CTN WT	CU FT	Model	Standard Tier 1	Graded In Tier 2	Standard Tier 1	Graded In Tier 2
		48	72	42	140	101	LKT4872-42TPT	\$2,760	\$2,810	\$3,370

Features:

- price reflects complete table - top and base
- ships KD in multiple cartons
- model includes adjustable glide

Options:

- specify power/charging option, see below for options and upcharges

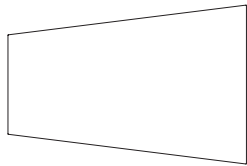

top shape

LOK - TEAMWORK

To Order Specify

1 Laminate Model #	2 Edge Detail	3 Laminate Selection	3a PVC Edge Color	4 Electrical
Laminate (LKT)	See Edge Detail Options	See Laminate Selection	See PVC Edge Color Options	N None CT2 Dual Power Center Top (See chart on next page) CU1 Single Power Underside 5 Metal Finish See Metal Finish Color Options

Model Number Breakdown

LKT4872-42TPT					
LK	T	4872	42	TP	T
LOK	Laminate	48" x 72"	Height	Taper Top Shape	T base

Description

Taper Table with T Base
at Bar Height
(continued)

Veneer Tables
"LKV" Models

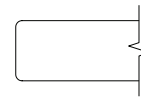

Eased Edge (R3)

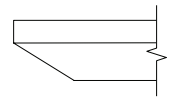

Reverse Bevel Edge (K9)

VEN.	D	W	H	CTN WT	CU FT	① Model	Essentials		Artisan	
							Essentials	Artisan	Essentials	Artisan
	48	72	42	140	101	LKV4872-42TPT	\$3,467	\$3,744	\$3,776	\$4,023

LOK - TEAMWORK

Electrical Options and Upcharges

CT2	
Dual Power Center Top - Black	CT2BL - add \$1,588
Dual Power Center Top - White	CT2WH - add \$1,588
CU1	
Single Power Underside - Black	CU11C - add \$618
Single Power Underside with Wireless Charging - Black	CU11CW - add \$1,479

Note: Order power infeed that best fits application

To Order, Specify:

① Veneer Model #	② Edge Detail	③ Wood Collection	④ Top Wood Finish	⑤ Electrical	⑥ Metal Color
Veneer (LKV)	See Edge Detail Options	Essentials	See Essentials Top Wood Finish Options	N None CT2 Dual Power Center Top CU1 Single Power Underside (See chart above)	See Metal Finish Color Options
		Artisan	④ Top Wood Finish See Artisan Top Wood Finish Options		

Description

Rounded Taper Table with T Base at Bar Height

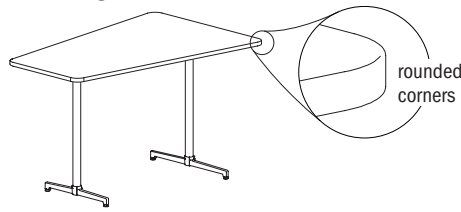

Laminate Tables "LKT" Models

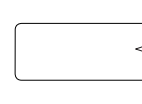

Eased Edge (R3)

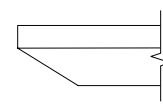

Reverse Bevel Edge (K9)

LAMI	D	W	H	CTN WT	CU FT	Model	Standard Tier 1	Graded In Tier 2	Standard Tier 1	Graded In Tier 2
		48	72	42	140	101	LKT4872-42TPRT	\$2,760	\$2,810	\$3,370

Features:

- price reflects complete table - top and base
- ships KD in multiple cartons
- model includes adjustable glide

Options:

- specify power/charging option, see below for options and upcharges

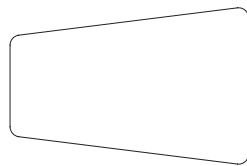

top shape

LOK - TEAMWORK

To Order Specify

1 Laminate Model #	2 Edge Detail	3 Laminate Selection	3a PVC Edge Color	4 Electrical
Laminate (LKT)	See Edge Detail Options	See Laminate Selection	See PVC Edge Color Options	N None CT2 Dual Power Center Top (See chart on next page) CU1 Single Power Underside 5 Metal Finish See Metal Finish Color Options

Model Number Breakdown

LKT4872-42TPRT						
LK	T	4872	42	TP	R	T
LOK	Laminate	48" x 72"	Height	Taper Top Shape	Rounded Corner	T base

Description

Rounded Taper Table with T Base
at Bar Height
(continued)

Veneer Tables
"LKV" Models

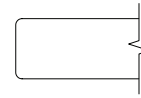

Eased Edge (R3)

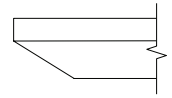

Reverse Bevel Edge (K9)

VEN.	D	W	H	CTN WT	CU FT	① Model	Eased Edge (R3)		Reverse Bevel Edge (K9)	
							Essentials	Artisan	Essentials	Artisan
	48	72	42	140	101	LKV4872-42TPRT	\$3,467	\$3,744	\$3,776	\$4,023

LOK - TEAMWORK

Electrical Options and Upcharges

CT2	
Dual Power Center Top - Black	CT2BL - add \$1,588
Dual Power Center Top - White	CT2WH - add \$1,588
CU1	
Single Power Underside - Black	CU11C - add \$618
Single Power Underside with Wireless Charging - Black	CU11CW - add \$1,479

Note: Order power infeed that best fits application

To Order, Specify:

① Veneer Model #	② Edge Detail	③ Wood Collection	④ Top Wood Finish	⑤ Electrical	⑥ Metal Color
Veneer (LKV)	See Edge Detail Options	Essentials	See Essentials Top Wood Finish Options	N None CT2 Dual Power Center Top CU1 Single Power Underside (See chart above)	See Metal Finish Color Options
		Artisan	④ Top Wood Finish See Artisan Top Wood Finish Options		

Description

Bullet Table with T Base at Bar Height

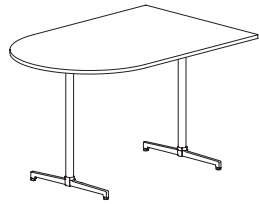

Laminate Tables "LKT" Models

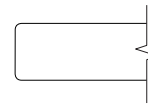

Eased Edge (R3)

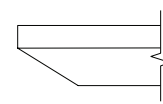

Reverse Bevel Edge (K9)

LAMI	D	W	H	CTN WT	CU FT	Model	Standard Tier 1	Graded In Tier 2	Standard Tier 1	Graded In Tier 2
		48	72	42	156	101	LKT4872-42BUT	\$2,746	\$2,800	\$3,355

Features:

- price reflects complete table - top and base
- ships KD in multiple cartons
- model includes adjustable glide

Options:

- specify power/charging option, see below for options and upcharges

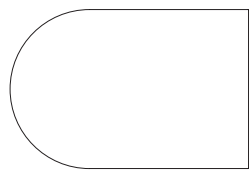

top shape

LOK - TEAMWORK

To Order Specify

1 Laminate Model #	2 Edge Detail	3 Laminate Selection	3a PVC Edge Color	4 Electrical
Laminate (LKT)	See Edge Detail Options	See Laminate Selection	See PVC Edge Color Options	N None CT2 Dual Power Center Top (See chart on next page) CU1 Single Power Underside 5 Metal Finish See Metal Finish Color Options

Model Number Breakdown

LKT4872-42BUT					
LK	T	4872	42	BU	T
LOK	Laminate	48" x 72"	Height	Bullet Top Shape	T base

Description

Bullet Table with T Base
at Bar Height
(continued)

Veneer Tables
"LKV" Models

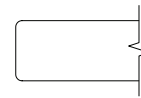

Eased Edge (R3)

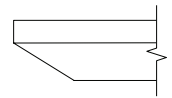

Reverse Bevel Edge (K9)

VEN.	D	W	H	CTN WT	CU FT	① Model	Essentials		Artisan	
	48	72	42	156	101	LKV4872-42BUT	\$3,455		\$3,729	
									\$3,763	\$4,007

LOK - TEAMWORK

Electrical Options and Upcharges

CT2	
Dual Power Center Top - Black	CT2BL - add \$1,773
Dual Power Center Top - White	CT2WH - add \$1,773
CU1	
Single Power Underside - Black	CU11C - add \$690
Single Power Underside with Wireless Charging - Black	CU11CW - add \$1,651

Note: Order power infeed that best fits application

To Order, Specify:

① Veneer Model #	② Edge Detail	③ Wood Collection	④ Top Wood Finish	⑤ Electrical	⑥ Metal Color
Veneer (LKV)	See Edge Detail Options	Essentials	See Essentials Top Wood Finish Options	N None CT2 Dual Power Center Top CU1 Single Power Underside (See chart above)	See Metal Finish Color Options
		Artisan	④ Top Wood Finish See Artisan Top Wood Finish Options		

Description

Hive Table with T Base at Bar Height

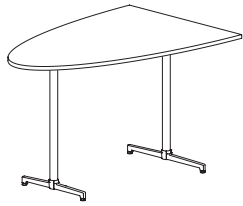

Laminate Tables "LKT" Models

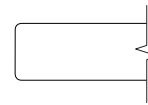

Eased Edge (R3)

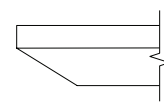

Reverse Bevel Edge (K9)

LAMI	D	W	H	CTN WT	CU FT	Model	Standard Tier 1	Graded In Tier 2	Standard Tier 1	Graded In Tier 2
		48	72	42	138	101	LKT4872-42HVT	\$2,746	\$2,800	\$3,355

Features:

- price reflects complete table - top and base
- ships KD in multiple cartons
- model includes adjustable glide

Options:

- specify power/charging option, see below for options and upcharges

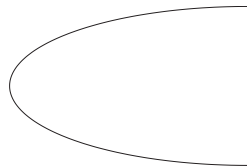

top shape

LOK - TEAMWORK

To Order Specify

1 Laminate Model #	2 Edge Detail	3 Laminate Selection	3a PVC Edge Color	4 Electrical
Laminate (LKT)	See Edge Detail Options	See Laminate Selection	See PVC Edge Color Options	N None CT2 Dual Power Center Top (See chart on next page) CU1 Single Power Underside 5 Metal Finish See Metal Finish Color Options

Model Number Breakdown

LKT4872-42HVT					
LK	T	4872	42	HV	T
LOK	Laminate	48" x 72"	Height	Hive Top Shape	T base

Description

Hive Table with T Base
at Bar Height
(continued)

Veneer Tables
"LKV" Models

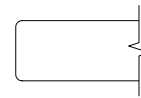

Eased Edge (R3)

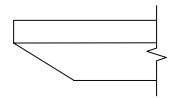

Reverse Bevel Edge (K9)

VEN.	D	W	H	CTN WT	CU FT	① Model	Essentials		Artisan	
							Essentials	Artisan	Essentials	Artisan
	48	72	42	138	101	LKV4872-42HVT	\$3,455	\$3,729	\$3,763	\$4,007

LOK - TEAMWORK

Electrical Options and Upcharges

CT2	
Dual Power Center Top - Black	CT2BL - add \$1,773
Dual Power Center Top - White	CT2WH - add \$1,773
CU1	
Single Power Underside - Black	CU11C - add \$690
Single Power Underside with Wireless Charging - Black	CU11CW - add \$1,651

Note: Order power infeed that best fits application

To Order, Specify:

① Veneer Model #	② Edge Detail	③ Wood Collection	④ Top Wood Finish	⑤ Electrical	⑥ Metal Color
Veneer (LKV)	See Edge Detail Options	Essentials	See Essentials Top Wood Finish Options	N None CT2 Dual Power Center Top CU1 Single Power Underside (See chart above)	See Metal Finish Color Options
		Artisan	④ Top Wood Finish See Artisan Top Wood Finish Options		

Description

Wedge Table with T Base
at Bar Height

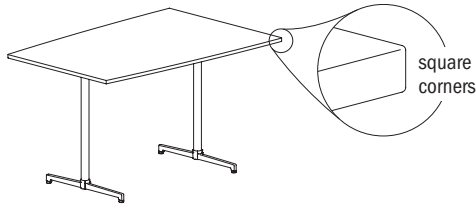

Laminate Tables
"LKT" Models

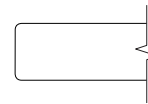

Eased Edge (R3)

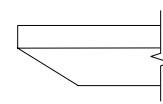

Reverse Bevel Edge (K9)

LAMI	D	W	H	CTN WT	CU FT	1 Model	Standard Tier 1	Graded In Tier 2	Standard Tier 1	Graded In Tier 2
		48	72	42	160	101	LKT4872-42WDT	\$2,746	\$2,800	\$3,355

Features:

- price reflects complete table - top and base
- ships KD in multiple cartons
- model includes adjustable glide

Options:

- specify power/charging option, see below for options and upcharges

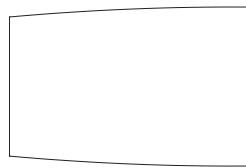

top shape

LOK - TEAMWORK

To Order Specify

1 Laminate Model #	2 Edge Detail	3 Laminate Selection	3a PVC Edge Color	4 Electrical
Laminate (LKT)	See Edge Detail Options	See Laminate Selection	See PVC Edge Color Options	N None CT2 Dual Power Center Top (See chart on next page) CU1 Single Power Underside 5 Metal Finish See Metal Finish Color Options

Model Number Breakdown

LKT4872-42WDT					
LK	T	4872	42	WD	T
LOK	Laminate	48" x 72"	Height	Wedge Top Shape	T base

Description

Wedge Table with T Base
at Bar Height
(continued)

Veneer Tables
"LKV" Models

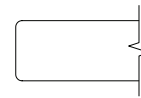

Eased Edge (R3)

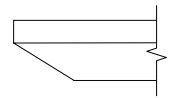

Reverse Bevel Edge (K9)

VEN.	D	W	H	CTN WT	CU FT	① Model	Eased Edge (R3)		Reverse Bevel Edge (K9)	
							Essentials	Artisan	Essentials	Artisan
	48	72	42	160	101	LKV4872-42WDT	\$3,455	\$3,729	\$3,763	\$4,007

LOK - TEAMWORK

Electrical Options and Upcharges

CT2	
Dual Power Center Top - Black	CT2BL - add \$1,588
Dual Power Center Top - White	CT2WH - add \$1,588
CU1	
Single Power Underside - Black	CU11C - add \$618
Single Power Underside with Wireless Charging - Black	CU11CW - add \$1,479

Note: Order power infeed that best fits application

To Order, Specify:

① Veneer Model #	② Edge Detail	③ Wood Collection	④ Top Wood Finish	⑤ Electrical	⑥ Metal Color
Veneer (LKV)	See Edge Detail Options	Essentials	See Essentials Top Wood Finish Options	N None CT2 Dual Power Center Top CU1 Single Power Underside (See chart above)	See Metal Finish Color Options
		Artisan	④ Top Wood Finish See Artisan Top Wood Finish Options		

Description

Rounded Wedge Table with T Base at Bar Height

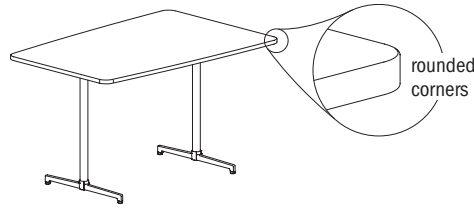

Laminate Tables "LKT" Models

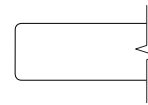

Eased Edge (R3)

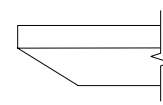

Reverse Bevel Edge (K9)

LAMI	D	W	H	CTN WT	CU FT	1 Model	Standard Tier 1	Graded In Tier 2	Standard Tier 1	Graded In Tier 2
		48	72	42	160	101	LKT4872-42WDRT	\$2,746	\$2,800	\$3,355

Features:

- price reflects complete table - top and base
- ships KD in multiple cartons
- model includes adjustable glide

Options:

- specify power/charging option, see below for options and upcharges

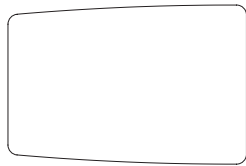

top shape

LOK - TEAMWORK

To Order Specify

1 Laminate Model #	2 Edge Detail	3 Laminate Selection	3a PVC Edge Color	4 Electrical
Laminate (LKT)	See Edge Detail Options	See Laminate Selection	See PVC Edge Color Options	N None CT2 Dual Power Center Top (See chart on next page) CU1 Single Power Underside 5 Metal Finish See Metal Finish Color Options

Model Number Breakdown

LKT4872-42WDRT						
LK	T	4872	42	WD	R	T
LOK	Laminate	48" x 72"	Height	Wedge Top Shape	Rounded Corner	T base

Description

Rounded Wedge Table with
T Base at Bar Height
(continued)

Veneer Tables
"LKV" Models

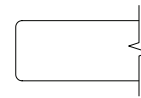

Eased Edge (R3)

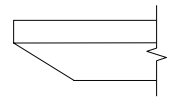

Reverse Bevel Edge (K9)

VEN.	D	W	H	CTN WT	CU FT	① Model	Eased Edge (R3)		Reverse Bevel Edge (K9)	
							Essentials	Artisan	Essentials	Artisan
	48	72	42	160	101	LKV4872-42WDRT	\$3,455	\$3,729	\$3,763	\$4,007

LOK - TEAMWORK

Electrical Options and Upcharges

CT2	
Dual Power Center Top - Black	CT2BL - add \$1,588
Dual Power Center Top - White	CT2WH - add \$1,588
CU1	
Single Power Underside - Black	CU11C - add \$618
Single Power Underside with Wireless Charging - Black	CU11CW - add \$1,479

Note: Order power infeed that best fits application

To Order, Specify:

① Veneer Model #	② Edge Detail	③ Wood Collection	④ Top Wood Finish	⑤ Electrical	⑥ Metal Color
Veneer (LKV)	See Edge Detail Options	Essentials	See Essentials Top Wood Finish Options	N None CT2 Dual Power Center Top CU1 Single Power Underside (See chart above)	See Metal Finish Color Options
		Artisan	④ Top Wood Finish See Artisan Top Wood Finish Options		

Description	D	W	H	CTN WT	CU FT	Model	List Price
3 Prong Plug - 110 Power Infeed				1	1	AP72	\$357

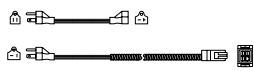

Features:

- 72" plug power infeed
- 20 amps/110 volts max
- 3 prong plug - 15 amp adapter plug included
- single circuit use only

Hardwire Power Infeed				1	1	HP72	\$290
-----------------------	--	--	--	---	---	------	-------



Features:

- 72" hardwire power infeed
- 20 amps/120 volts max
- single or double circuit
- electrical contractor responsible for connection to building power source

Quick Disconnect Power Infeed				1	1	MP72	\$267
-------------------------------	--	--	--	---	---	------	-------



Features:

- must be used with QD1
- 72" modular power infeed
- 20 amps/120 volts max
- single or double circuit

Quick Disconnect Wall Outlet				1	1	QD1	\$137
------------------------------	--	--	--	---	---	-----	-------

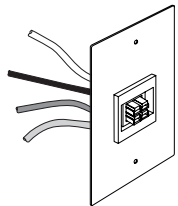

Features:

- must be used with MP72
- works for both single or double circuit
- 20 amps/120 volts max
- electrical contractor responsible for connection to building power source

Vertical Wire Manager	1/2	2 1/4	33	1	1	AVL33	\$154
	1/2	2 1/4	25	1	1	AVL25	\$117
	1/2	2 1/4	22	1	1	AVL20	\$95
	1/2	2 1/4	17	1	1	AVL17	\$90

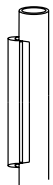

Features:

- field installed
- use AVL33 for 42"h tables with disk base
- use AVL25 for 42"h tables
- use AVL20 for 36"h tables
- use AVL17 for 29"h tables

Options:

- specify plastic color, Black (B) or Silver (S)

Flexible Vertical Wire Manager	1 1/2	1 1/2	45	4	1	45VWM	\$146
--------------------------------	-------	-------	----	---	---	-------	-------



Features:

- black plastic
- field installed to bottom of table top, with screws provided
- wire manager is 1 1/2" diameter
- weighted base is 4" diameter
- length can be adjusted by removing individual discs as required

Description	D	W	H	CTN WT	CU FT	① Model	List Price
Power Strip	1 ½	1 ⅞	8	3	1	GP9ACP1-0212	\$103

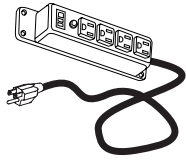

- Features:**
- power surge with 10" cord
 - four electrical outlets
 - includes switch
 - field installed

Wire Management Velcro Straps	1 ¾	3 ½	¼	1	1	04WVS	\$63
--------------------------------------	-----	-----	---	---	---	-------	------

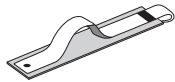

- Features:**
- black, set of 4
 - field installed to bottom of table top, with adhesive tape provided

Cable Management Clips	2 ⅝	3 ¾	1 ⅝	1	1	0304CMC	\$61
-------------------------------	-----	-----	-----	---	---	---------	------

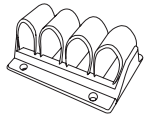

- Features:**
- black plastic
 - installed to bottom of table top
 - four retention loops

Floor Mount Glide	3	2 ¼	½	1	1	LKB516-18ANCHOR	\$47
--------------------------	---	-----	---	---	---	-----------------	------

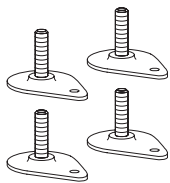

- Features:**
- field installed glides for mounting table base to floor
 - ¼" diameter hole in the glide for mounting
 - set of 4
 - table can be leveled before attached to floor
 - floor attachment hardware provided by installer
 - glide threads ⅜"-16

Single Monitor Arm	4	11	10	9	1	GP5901MA	\$761
---------------------------	---	----	----	---	---	----------	-------

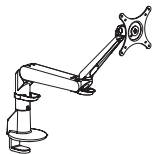

- Features:**
- one-touch reposition monitor adjustment
 - tension adjustment at each joint
 - flat panel mount rotates for portrait or landscape viewing
 - edge mount installation from above surface
 - cable management routes cables below monitor arm
 - specify Black (B) or Silver (S)
 - quick install VESA mount adapter

Wire Management Tray	7 ½	45	3	8	2	GP9WMT1-0845	\$300
	7 ½	35	3	6	1	GP9WMT1-0835	\$253
	7 ½	25	3	4	1	GP9WMT1-0825	\$205

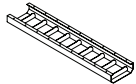

- Features:**
- silver powder-coated finish
 - four hanging brackets (CI2C00)

Wire Manager Trough	2 ½	36	2 ½	4	1	36WCT	\$169
	2 ½	24	2 ½	3	1	24WCT	\$154
	2 ½	12	2 ½	2	1	12WCT	\$132

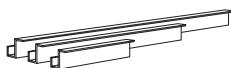

- Features:**
- black plastic
 - field installed to bottom of table top, with screws provided

Accessories/ Keyboard/ Tasklights

For an additional list of electrical units, grommets, keyboards, wire management, monitor arms & telecom jacks, please see our [accessories price list](#)

Contact your customer service representative for specific questions regarding which units can be used with Lok Teamwork.

