

# *Product Guide*

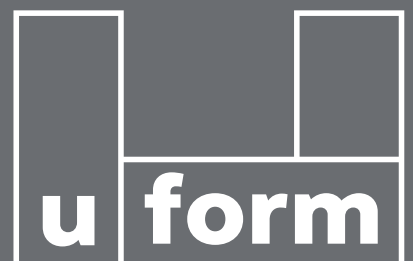

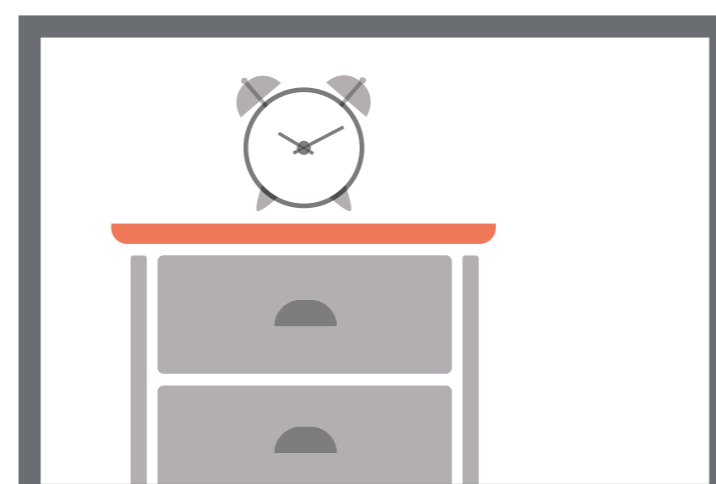

<b>COMPANY OVERVIEW</b>	02
<b>DOORS &amp; ACCESSORIES</b>	06
<b>UNIVERSAL ACCESSORIES</b>	110
<b>STORAGE &amp; BINS</b>	122
<b>HANDLES &amp; HANDLELESS RAILS</b>	148
<b>LIGHTING</b>	166
<b>TECHNICAL GUIDE</b>	182
<b>TERMS &amp; CONDITIONS</b>	336



We have made every effort to make the colours and finishes within this product guide as accurate as possible. However, due to the limitations of the printing process, we cannot guarantee an exact match in colours and finishes and the images and information in this product guide should not be relied on as such.

The information shown in this literature is accurate as at the date of print release and is therefore subject to change after such date. If you have any doubt about the suitability or availability of the product or the accuracy of the information shown, please contact Uform.



## *Doors & accessories.*









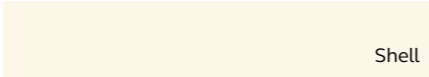
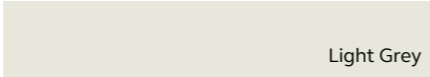
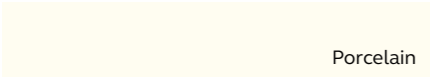
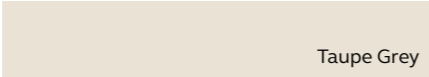

FINISHES	08
PRODUCT LEAD TIMES	10
DOOR DRILLING SERVICES	12
MADE TO ORDER PRODUCTS	13
COLOUR MATCH SERVICE	13
PAINT & STAIN RANGES	14
MFC OPTIONS	15

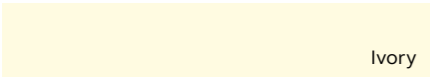
### **RANGES**

















ALDANA	18
ARRINGTON	24
BELGRAVIA	30
CLIFDEN	34
DAWSON	38
ELLESMERE	42
FERRO	46
FLORENCE	48
GEORGIA	50
HARBORNE	52
JACOBSEN	54
JEFFERSON	60
KENSINGTON	64
LAWRENSON	68
MADISON	72
PEMBRIDGE	76
REZANA	78
STRADA GLOSS	80
STRADA MATTE	82
TAVOLA	84
WAKEFIELD	86
WINSLOW	90
ZOLA GLOSS	96
ZOLA MATTE	100
ZOLA SOFT-MATTE	104



## STANDARD PAINT PALETTE PTO





WHITES/CREAMS	BEIGES	GREYS/BLACKS
 Brilliant White	 Shell	 Light Grey
 Porcelain	 Taupe Grey	 Dust Grey
 Ivory	 Mussel	 Monument Grey
	 Stone	 Gunmetal Grey
	 Stone Grey	 Graphite
	 Lava	 Cannon Black

BLUES	GREENS	PINKS/REDS
 Pantry Blue	 Sage Green	 Cashmere
 Light Teal	 Cardamom	 Vintage Pink
 Airforce	 Reed Green	 Antique Red
 Parisian Blue	 Willow	
 Marine	 Viridian	
 Slate Blue	 Heritage Green	
 Indigo	 Deep Forest	







We have made every effort to make the colours and finishes within this product guide as accurate as possible. However, due to the limitations of the printing process, we cannot guarantee an exact match in colours and finishes and the images and information in this product guide should not be relied on as such.

## STAIN PALETTE STO

 Light Oak	 Espresso	 Carbon
 Parched Oak	 Weathered Silver	 Hacienda Black

Can be applied to Rezana and Tavola.

## FERRO PALETTE

SMOOTH METAL FINISHES	WEATHERED METAL FINISHES
 Iron	 Rusted Iron
 Copper	 Oxidised Copper
 Brass	 Burnished Brass

Metal paints can be applied to Ferro only.

## COLOUR MATCH SERVICE CMS



Uform can colour match any RAL (European Standard) or BS (British Standard) paint swatch.

## GOLA HANDLESS RAIL SYSTEM PTO CMS



The Gola Handleless Rail System is now available in any of our standard paint to order colours or can be colour matched to any RAL (European Standard) or BS (British Standard) paint swatch.

# PRODUCT LEAD TIMES

Uform will always try to maintain its lead times, however, capacity will ultimately determine the time taken to despatch orders. In times of increased demand and seasonal fluctuations, lead times may be extended

and customers will be informed of the revised despatch date on their order acknowledgement form. For the latest lead times, visit [uform.co.uk](http://uform.co.uk)

RANGE NAME	FINISH	NO. OF WORKING DAYS		
		STANDARD PRODUCTS	MADE TO ORDER SPECIAL SIZES	
			DOORS/ACCESSORIES	PLAIN PANELS
ALDANA	SANDED Ash	EX-STOCK	15	10
	PAINTED Dust Grey / Graphite / Heritage Green / Light Grey / Marine / Porcelain / Reed Green / Stone / Taupe Grey	EX-STOCK	20	15
	PAINT TO ORDER Uform paint palette colours	10	20	15
BEDROOM SIZES	PAINT TO ORDER Uform paint palette colours	10	20	15
	COLOUR MATCH SERVICE	20	25	20
ARRINGTON	SANDED Ash	7	15	10
	PAINT TO ORDER Uform paint palette colours	15	20	15
	COLOUR MATCH SERVICE	25	25	20
BELGRAVIA	SANDED Ash	EX-STOCK	15	10
	PAINT TO ORDER Uform paint palette colours	10	20	15
	COLOUR MATCH SERVICE	20	25	20
CLIFDEN	PRIMED	EX-STOCK	-	-
	PAINTED Heritage Green / Light Grey / Marine / Porcelain	EX-STOCK	-	-
	PAINT TO ORDER Uform paint palette colours	10	-	-
	COLOUR MATCH SERVICE	20	-	-
DAWSON	FOIL Cashmere / Dust Grey / Graphite / Indigo / Light Grey / Porcelain	EX-STOCK	15	10
	BEDROOM SIZES FOIL Cashmere / Light Grey / Porcelain	EX-STOCK	15	10
ELLESMERE	PRIMED	EX-STOCK	-	-
	PAINT TO ORDER Uform paint palette colours	10	-	-
	COLOUR MATCH SERVICE	20	-	-
FERRO	PAINT TO ORDER Iron / Copper / Brass / Rusted Iron / Oxidised Copper / Burnished Brass	-	25	25
FLORENCE	PRIMED	EX-STOCK	-	-
	PAINT TO ORDER Uform paint palette colours	10	-	-
	COLOUR MATCH SERVICE	20	-	-
GEORGIA	PRIMED	EX-STOCK	-	-
	PAINT TO ORDER Uform paint palette colours	10	-	-
	COLOUR MATCH SERVICE	20	-	-
HARBORNE	SANDED Ash	EX-STOCK	15	10
	PAINTED Graphite / Heritage Green / Light Grey	EX-STOCK	20	15
	PAINT TO ORDER Uform paint palette colours	10	20	15
	COLOUR MATCH SERVICE	20	25	20
JACOBSEN	SANDED Ash	7	15	10
	PAINT TO ORDER Uform paint palette colours	15	20	15
	COLOUR MATCH SERVICE	25	25	20
JEFFERSON	SANDED Ash	EX-STOCK	15	10
	STAINED Light Oak	EX-STOCK	-	15
	PAINTED Ivory	EX-STOCK	20	15
	PAINT TO ORDER Uform paint palette colours	10	20	15
	COLOUR MATCH SERVICE	20	25	20

RANGE NAME	FINISH	NO. OF WORKING DAYS		
		STANDARD PRODUCTS	MADE TO ORDER SPECIAL SIZES	
			DOORS/ACCESSORIES	PLAIN PANELS
KENSINGTON	FOIL Cashmere / Dust Grey / Graphite / Heritage Green / Indigo / Ivory / Light Grey / Mussel / Porcelain / Reed Green / Taupe Grey	EX-STOCK	15	10
	BEDROOM SIZES FOIL Cashmere / Light Grey / Porcelain / Reed Green / Taupe Grey	EX-STOCK	15	10
LAWRENSON	SANDED Ash	EX-STOCK	15	10
	PAINT TO ORDER Uform paint palette colours	10	20	15
	COLOUR MATCH SERVICE	20	25	20
MADISON	SANDED Ash	EX-STOCK	15	10
	STAINED Light Oak	EX-STOCK	20	15
	PAINTED Dust Grey / Ivory / Light Grey / Marine / Porcelain / Sage Green / Stone	EX-STOCK	20	15
	PAINT TO ORDER Uform paint palette colours	10	20	15
PEMBRIDGE	FOIL Indigo / Light Grey / Porcelain / Reed Green / Taupe Grey	EX-STOCK	-	10
	REZANA	SANDED Knotty Oak Veneer	-	10
STRADA GLOSS	STAIN TO ORDER	-	20	20
	PAINTED Cashmere / Dust Grey / Graphite / Light Grey / Porcelain / White	EX-STOCK	-	-
STRADA MATTE	PRIMED	EX-STOCK	-	-
	PAINTED Cashmere / Dust Grey / Graphite / Light Grey / Marine / Porcelain / White	EX-STOCK	-	-
	PAINT TO ORDER Uform paint palette colours	10	-	-
	COLOUR MATCH SERVICE	20	-	-
TAVOLA	SANDED Oak	EX-STOCK	10	10
	STAIN TO ORDER	10	20	20
	PAINT TO ORDER Uform paint palette colours	10	20	20
	COLOUR MATCH SERVICE	20	25	25
WAKEFIELD	SANDED Ash	EX-STOCK	15	10
	STAINED Light Oak	EX-STOCK	20	15
	PAINTED Dust Grey / Ivory / Light Grey / Marine / Mussel / Porcelain / Reed Green / Sage Green / Stone / Taupe Grey	EX-STOCK	20	15
	PAINT TO ORDER Uform paint palette colours	10	20	15
	COLOUR MATCH SERVICE	20	25	20
WINSLOW	SANDED Ash	7	15	10
	PAINT TO ORDER Uform paint palette colours	10	20	15
	COLOUR MATCH SERVICE	20	25	20
ZOLA GLOSS	PAINTED Cashmere / Dust Grey / Graphite / Light Grey / Porcelain / White	EX-STOCK	-	-
ZOLA MATTE	PRIMED	EX-STOCK	-	-
	PAINT TO ORDER Uform paint palette colours	10	-	-
	COLOUR MATCH SERVICE	20	-	-
ZOLA SOFT-MATTE	PET FOIL Cashmere / Dust Grey / Graphite / Indigo / Light Grey / Porcelain / White	EX-STOCK	10	10
	BEDROOM SIZES PET FOIL Cashmere / Light Grey / White	EX-STOCK	10	10

\* Any Made to Order painted orders with more than 5 pieces will incur an additional lead time of 5 working days.





## EX-STOCK PAINT TO ORDER STANDARD COLOURS

	WHITES/CREAMS	BEIGES	BLUES	GREENS	GREYS/BLACKS	PINKS/REDS
Sanded Ash	Brilliant White	Shell	Pantry Blue	Sage Green	Monument Grey	Cashmere
Porcelain	Ivory	Mussel	Light Teal	Cardamom	Gunmetal Grey	Vintage Pink
Light Grey		Stone Grey	Airforce	Willow	Cannon Black	Antique Red
Taupe Grey		Lava	Parisian Blue	Viridian		
Stone			Slate Blue	Deep Forest		
Dust Grey			Indigo			
Reed Green						
Marine						
Heritage Green						
Graphite						



## DOOR SPECIFICATION

Description	Narrow shaker - 5 piece solid frame with flat veneer centre panel
Finish	Ash painted or sanded
Frame material	Ash
Centre panel material	Ash veneer
Door thickness	20mm
Frame width	68mm
Edge colour	As face
Reverse colour	As face

## LEAD TIMES EXCLUDING DELIVERY (WORKING DAYS)

FINISH	STANDARD PRODUCT
Sanded Ash	EX
Painted ex-stock colours	EX
Paint to order standard colours	10
Colour Match Service	20

## STANDARD DRAWERFRONTS & DOORS

- 115 x 597 slab
- 140 x 297 slab
- 140 x 397 slab
- 140 x 447 slab
- 140 x 497 slab
- 140 x 597 slab
- 140 x 797 slab
- 140 x 897 slab
- 140 x 997 slab
- 175 x 397 slab
- 175 x 497 slab
- 175 x 597 slab
- 283 x 497
- 283 x 597
- 283 x 797
- 283 x 897
- 283 x 997
- 355 x 497
- 355 x 497 plain frame
- 355 x 597
- 355 x 797
- 355 x 897
- 355 x 997
- 450 x 597
- 495 x 397
- 495 x 597
- 570 x 297
- 570 x 397
- 570 x 447
- 570 x 497
- 570 x 597
- 645 x 597
- 715 x 147 slab
- 715 x 257
- 715 x 273
- 715 x 273 pair
- 715 x 297
- 715 x 315
- 715 x 315 pair
- 715 x 320 quadrant door
- 715 x 347
- 715 x 397
- 715 x 397 plain frame
- 715 x 447
- 715 x 497
- 715 x 497 plain frame
- 715 x 547
- 715 x 597
- 825 x 597
- 895 x 297
- 895 x 347
- 895 x 397
- 895 x 397 plain frame
- 895 x 447
- 895 x 497
- 895 x 497 plain frame
- 895 x 597
- 980 x 597
- 1060 x 497 plain frame
- 1245 x 297
- 1245 x 397
- 1245 x 447
- 1245 x 497
- 1245 x 597
- 1425 x 597
- 1965 x 297 with 2 cross rails
- 1965 x 397 with 2 cross rails
- 1965 x 497 with 2 cross rails
- 1965 x 597 with 2 cross rails

## STANDARD DOORS



STANDARD DOOR PLAIN FRAME includes clear glass QUADRANT DOOR

## STANDARD ACCESSORIES

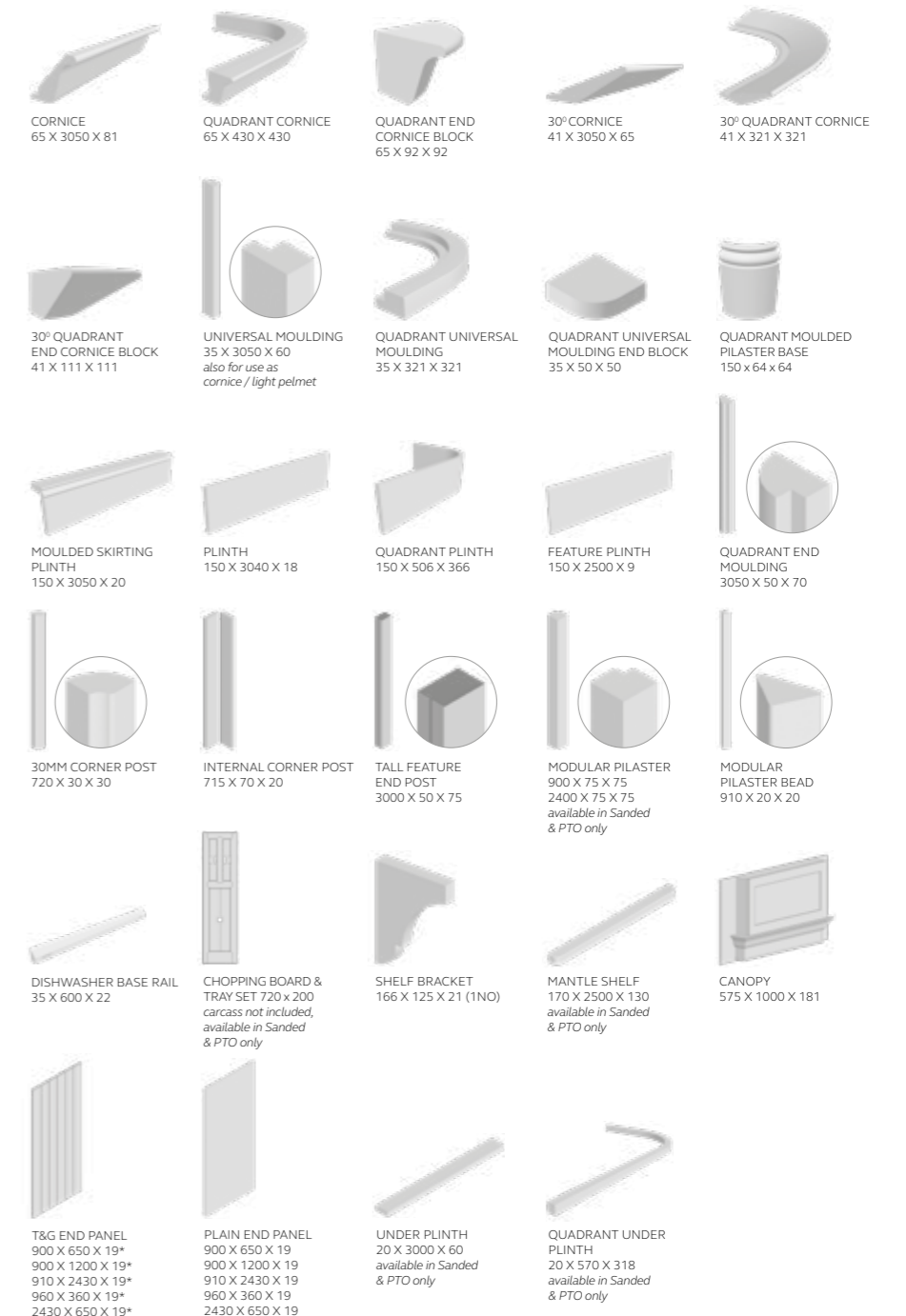

\* The T&G grooving and the timber grain run up and down the panel height.



## STANDARD DRAWERFRONTS & DOORS

- 140 x 297 slab
- 140 x 397 slab
- 140 x 447 slab
- 140 x 497 slab
- 140 x 797 slab
- 140 x 897 slab
- 140 x 997 slab
- 215 x 397
- 215 x 447
- 215 x 497
- 215 x 797
- 215 x 897
- 215 x 997
- 283 x 497
- 283 x 797
- 283 x 897
- 283 x 997
- 355 x 497
- 355 x 797
- 355 x 897
- 355 x 997
- 450 x 397
- 450 x 447
- 450 x 497
- 570 x 297
- 570 x 397
- 570 x 447
- 570 x 497
- 715 x 297
- 715 x 347
- 715 x 397
- 715 x 447
- 715 x 497
- 1495 x 397 with 2 cross rails
- 1495 x 447 with 2 cross rails
- 1495 x 497 with 2 cross rails
- 1595 x 397 with 2 cross rails
- 1595 x 447 with 2 cross rails
- 1595 x 497 with 2 cross rails
- 2155 x 397 with 3 cross rails
- 2155 x 447 with 3 cross rails
- 2155 x 497 with 3 cross rails
- 2250 x 397 with 3 cross rails
- 2250 x 447 with 3 cross rails
- 2250 x 497 with 3 cross rails
- 2155 x 497 mirrored door with 3 cross rails
- 2250 x 497 mirrored door with 3 cross rails

## WARDROBE DOORS



2155/2250  
4 PANEL

2155/2250  
4 PANEL MIRROR

1495/1595  
3 PANEL

STANDARD DOOR

## SANDED

## PAINT TO ORDER STANDARD COLOURS

	WHITES/CREAMS	BEIGES	BLUES	GREENS	GREYS/BLACKS	PINKS/REDS
Sanded Ash	Brilliant White	Shell	Pantry Blue	Sage Green	Light Grey	Cashmere
	Porcelain	Taupe Grey	Light Teal	Cardamom	Dust Grey	Vintage Pink
	Ivory	Mussel	Airforce	Reed Green	Monument Grey	Antique Red
		Stone	Parisian Blue	Willow	Gunmetal Grey	
		Stone Grey	Marine	Viridian	Graphite	
		Lava	Slate Blue	Heritage Green	Cannon Black	
		Indigo	Deep Forest			

CMS Colour Match Service

## DOOR SPECIFICATION

Description	Narrow shaker - 5 piece solid frame with flat veneer centre panel
Finish	Ash painted or sanded
Frame material	Ash
Centre panel material	Ash veneer
Door thickness	20mm
Frame width	68mm
Edge colour	As face
Reverse colour	As face

## LEAD TIMES EXCLUDING DELIVERY (WORKING DAYS)

FINISH	STANDARD PRODUCT
Sanded Ash	EX
Paint to order standard colours	10
Colour Match Service	20

## STANDARD ACCESSORIES

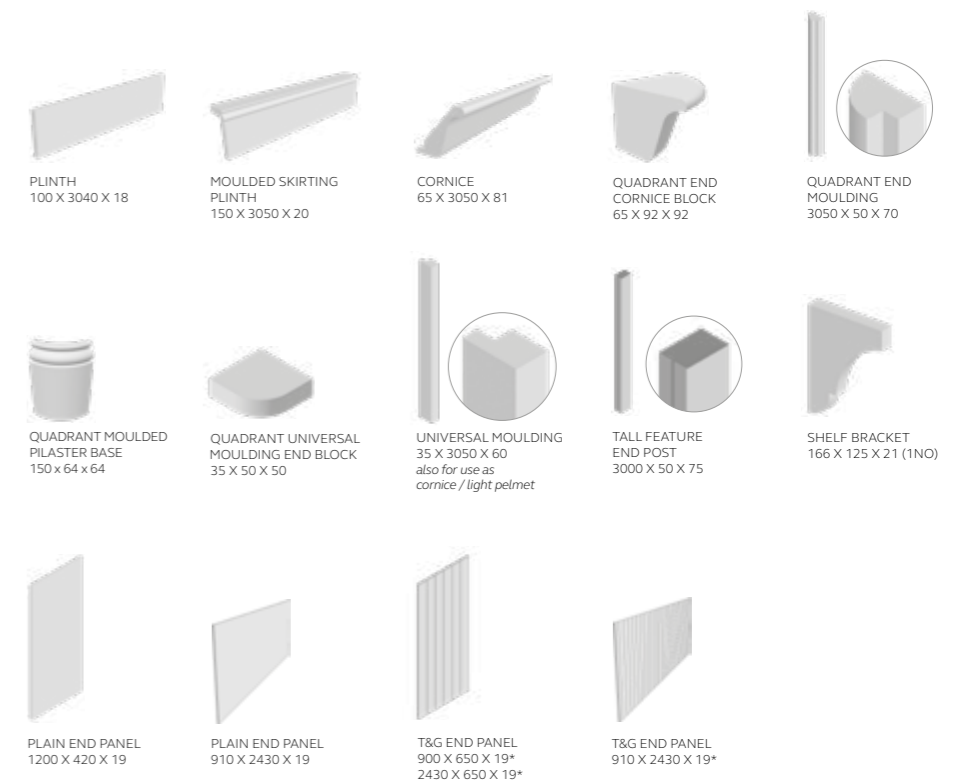

PLINTH  
100 X 3040 X 18

MOULDED SKIRTING  
PLINTH  
150 X 3050 X 20

CORNICE  
65 X 3050 X 81

QUADRANT END  
CORNICE BLOCK  
65 X 92 X 92

QUADRANT END  
MOULDING  
3050 X 50 X 70

QUADRANT MOULDED  
PLASTER BASE  
150 X 64 X 64

QUADRANT UNIVERSAL  
MOULDING END BLOCK  
35 X 50 X 50

UNIVERSAL MOULDING  
35 X 3050 X 60  
also for use as  
cornice / light pelmet

TALL FEATURE  
END POST  
3000 X 50 X 75

SHELF BRACKET  
166 X 125 X 21 (1NO)

PLAIN END PANEL  
1200 X 420 X 19

PLAIN END PANEL  
910 X 2430 X 19

T&G END PANEL  
900 X 650 X 19\*  
2430 X 650 X 19\*

T&G END PANEL  
910 X 2430 X 19\*

\* The T&G grooving and the timber grain run up and down the panel height.



## MADE TO ORDER DRAWERFRONTS & DOORS

SPECIAL SIZES ARE AVAILABLE MADE TO ORDER. PLEASE REFER TO THE CURRENT PRICE LIST FOR (h) & (w) LIMITATIONS.



Doors over 1464 require cross rails. Please specify 1, 2 or 3 rails when ordering.  
Frames exclude glass.

## MADE TO ORDER ACCESSORIES

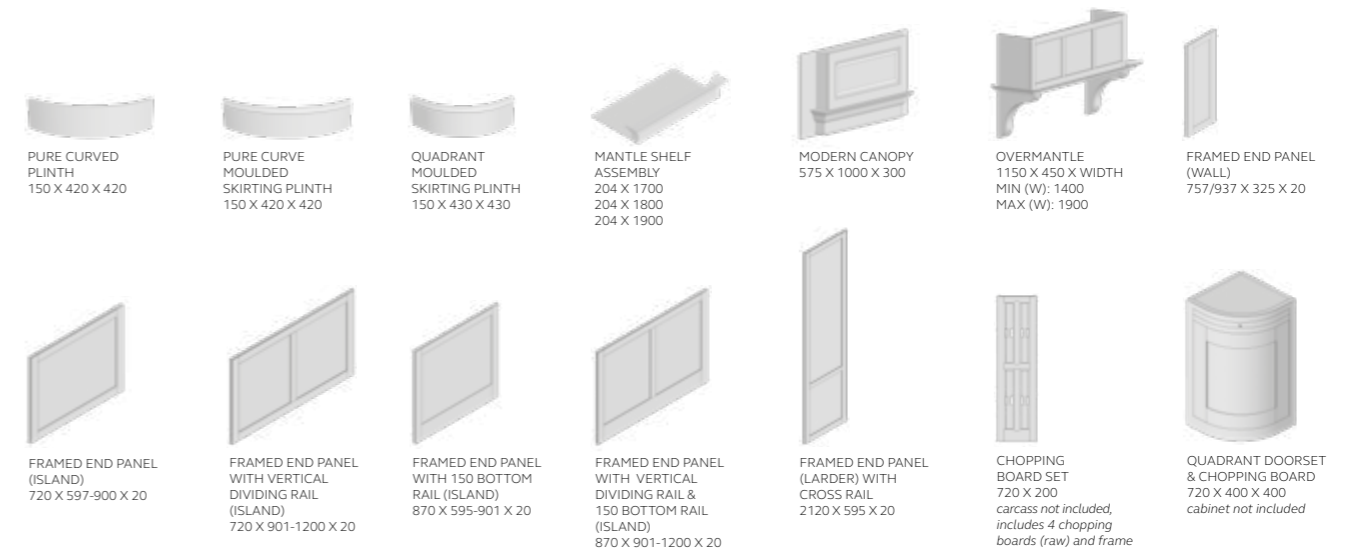

## SANDED

## PAINT TO ORDER STANDARD COLOURS

	WHITES/CREAMS	BEIGES	BLUES	GREENS	GREYS/BLACKS	PINKS/REDS
Sanded Ash	Brilliant White	Shell	Pantry Blue	Sage Green	Light Grey	Cashmere
	Porcelain	Taupe Grey	Light Teal	Cardamom	Dust Grey	Vintage Pink
	Ivory	Mussel	Airforce	Reed Green	Monument Grey	Antique Red
		Stone	Parisian Blue	Willow	Gunmetal Grey	
		Stone Grey	Marine	Viridian	Graphite	
		Lava	Slate Blue	Heritage Green	Cannon Black	
			Indigo	Deep Forest		

CMS Colour Match Service

## DOOR SPECIFICATION

Description	Narrow shaker - 5 piece solid frame with flat veneer centre panel
Finish	Ash painted or sanded
Frame material	Ash
Centre panel material	Ash veneer
Door thickness	20mm
Frame width	68mm
Edge colour	As face
Reverse colour	As face

## LEAD TIMES EXCLUDING DELIVERY (WORKING DAYS)

FINISH	MADE TO ORDER & SPECIAL SIZES	
	DOORS	PANELS
Sanded Ash	15	10
Painted Ex-stock colours	20	15
Paint to order standard colours	20	15
Colour Match Service	25	20

## MADE TO ORDER ACCESSORIES: FOR HANDLELESS



## MADE TO ORDER PLAIN PANELS

SIZE PARAMETERS:

Height (mm)		Width (mm)	
Min	Max	Min	Max
70	900	100	1200
901	1250	100	900
1251	2500	100	800



## STANDARD DRAWERFRONTS & DOORS

- 1 115 x 597 slab
- 1 140 x 297 slab
- 1 140 x 397 slab
- 1 140 x 447 slab
- 1 140 x 497 slab
- 1 140 x 597 slab
- 1 140 x 797 slab
- 1 140 x 897 slab
- 1 140 x 997 slab
- 1 175 x 397 slab
- 1 175 x 497 slab
- 1 175 x 597 slab
- 2 283 x 497
- 2 283 x 597
- 2 283 x 797
- 2 283 x 897
- 2 283 x 997
- 2 355 x 497
- 2 355 x 597
- 2 355 x 797
- 2 355 x 897
- 2 355 x 997
- 3 355 x 497 plain frame
- 4 450 x 497
- 4 450 x 597
- 4 495 x 397
- 4 495 x 597
- 4 570 x 297
- 4 570 x 397
- 4 570 x 447
- 4 570 x 497
- 4 570 x 597
- 4 645 x 597
- 5 715 x 147 slab
- 6 715 x 273
- 6 715 x 273 pair
- 6 715 x 297
- 6 715 x 315
- 6 715 x 315 pair
- 6 715 x 347
- 6 715 x 397
- 6 715 x 447
- 6 715 x 497
- 6 715 x 547
- 6 715 x 597
- 7 715 x 397 plain frame
- 7 715 x 497 plain frame
- 7 895 x 397 plain frame
- 7 895 x 497 plain frame
- 7 1060 x 497 plain frame
- 8 825 x 597
- 8 895 x 297
- 8 895 x 347
- 8 895 x 397
- 8 895 x 447
- 8 895 x 497
- 8 895 x 597
- 9 980 x 597
- 9 1245 x 297
- 9 1245 x 397
- 9 1245 x 447
- 9 1245 x 497
- 9 1245 x 597
- 9 1425 x 597
- 10 1965 x 297 with 2 cross rails
- 10 1965 x 397 with 2 cross rails
- 10 1965 x 497 with 2 cross rails
- 10 1965 x 597 with 2 cross rails

## STANDARD DRAWERFRONTS & DOORS



STANDARD DOOR



PLAIN FRAME  
includes clear glass

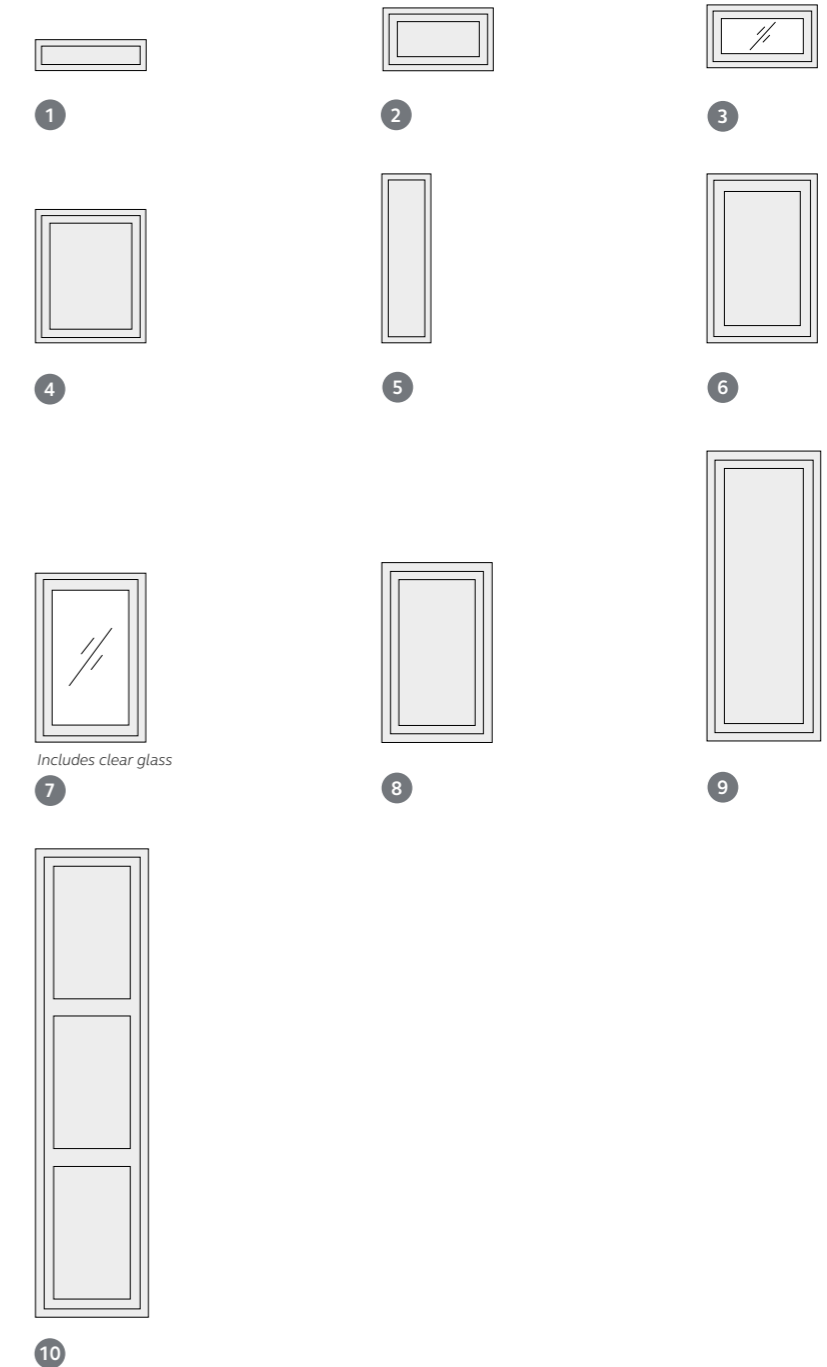

## SANDED

## PAINT TO ORDER STANDARD COLOURS

	WHITES/CREAMS	BEIGES	BLUES	GREENS	GREYS/BLACKS	PINKS/REDS
Sanded Ash	Brilliant White	Shell	Pantry Blue	Sage Green	Light Grey	Cashmere
	Porcelain	Taupe Grey	Light Teal	Cardamom	Dust Grey	Vintage Pink
	Ivory	Mussel	Airforce	Reed Green	Monument Grey	Antique Red
		Stone	Parisian Blue	Willow	Gunmetal Grey	
		Stone Grey	Marine	Viridian	Graphite	
		Lava	Slate Blue	Heritage Green	Cannon Black	
			Indigo	Deep Forest		



## DOOR SPECIFICATION

Description	Inframe effect narrow shaker - 5 piece solid frame with flat veneer centre panel
Finish	Ash painted or sanded
Frame material	Ash
Centre panel material	Ash veneer
Door thickness	20mm
Frame width	68mm; includes 28mm routered frame & 5mm routerline
Edge colour	As face
Reverse colour	As face

## LEAD TIMES EXCLUDING DELIVERY (WORKING DAYS)

FINISH	STANDARD PRODUCT
Sanded Ash	7
Paint to order standard colours	15
Colour Match Service	25

# ARRINGTON KITCHEN

## STANDARD ACCESSORIES



CORNICE  
65 X 3050 X 81



QUADRANT END  
CORNICE BLOCK  
65 X 92 X 92



30° CORNICE  
41 X 3050 X 65



30° QUADRANT  
END CORNICE BLOCK  
41 X 111 X 111

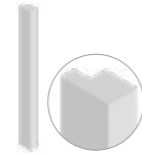

UNIVERSAL MOULDING  
35 X 3050 X 60



QUADRANT UNIVERSAL  
MOULDING END BLOCK  
35 X 50 X 50



QUADRANT MOULDED  
PILASTER BASE  
150 X 64 X 64



MOULDED SKIRTING  
PLINTH  
150 X 3050 X 20



PLINTH  
150 X 3040 X 18



FEATURE PLINTH  
150 X 2500 X 9



QUADRANT END  
MOULDING  
3050 X 50 X 70



30MM CORNER POST  
720 X 30 X 30



INTERNAL CORNER  
POST  
715 X 70 X 20 (2NO.)



TALL FEATURE  
END POST  
3000 X 50 X 75

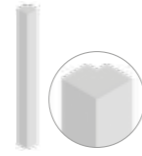

MODULAR PILASTER  
900 X 75 X 75  
2400 X 75 X 75

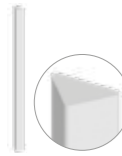

MODULAR PILASTER  
BEAD  
910 X 20 X 20



DISHWASHER BASE  
RAIL  
35 X 600 X 22



CHOPPING BOARD &  
TRAY SET  
720 X 200



SHELF BRACKET  
166 X 125 X 21 (1NO.)



MANTLE SHELF  
170 X 2500 X 130



CANOPY  
575 X 1000 X 181  
(no routed frame)



T&G END PANEL  
900 X 650 X 19\*  
900 X 1200 X 19\*  
910 X 2430 X 19\*  
960 X 360 X 19\*  
2430 X 650 X 19\*



PLAIN END PANEL  
900 X 650 X 19  
900 X 1200 X 19  
910 X 2430 X 19  
960 X 360 X 19  
2430 X 650 X 19  
2430 X 650 X 39



UNDER PLINTH  
20 X 3000 X 60





## MADE TO ORDER DRAWERFRONTS & DOORS

SPECIAL SIZES ARE AVAILABLE MADE TO ORDER. PLEASE REFER TO THE CURRENT PRICE LIST FOR (h) & (w) LIMITATIONS.



**STANDARD DOOR**  
**PLAIN FRAME**  
*glass not supplied*  
**GLAZED FRAME**  
*with horizontal bars*  
*glass not supplied*  
*(number of bars depends on door height)*  
**SINGLE GLAZED DOOR**  
*glass not supplied*  
**SLAB DRAWERFRONT**

Doors over 1464 require cross rails. Please specify 1, 2 or 3 rails when ordering. Frames exclude glass.

## MADE TO ORDER ACCESSORIES

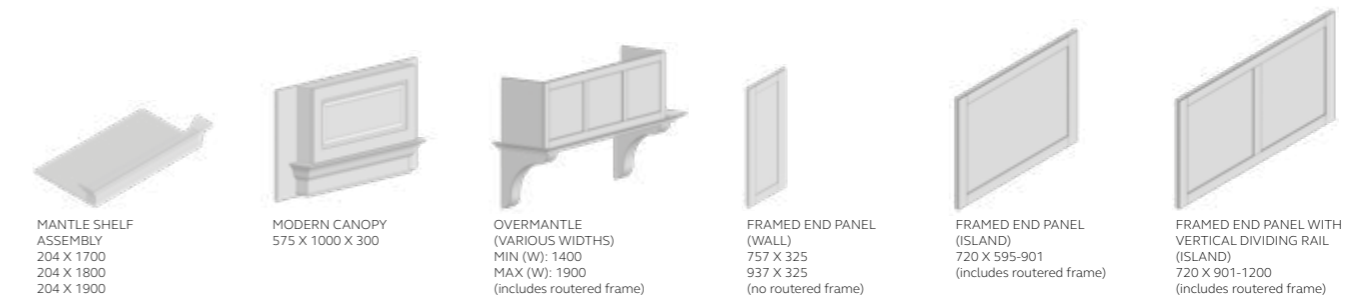

**MANTLE SHELF ASSEMBLY**  
 204 X 1700  
 204 X 1800  
 204 X 1900  
**MODERN CANOPY**  
 575 X 1000 X 300  
**OVERMANTLE (VARIOUS WIDTHS)**  
 MIN (W): 1400  
 MAX (W): 1900  
 (includes routed frame)  
**FRAMED END PANEL (WALL)**  
 757 X 325  
 937 X 325  
 (no routed frame)  
**FRAMED END PANEL (ISLAND)**  
 720 X 595-901  
 (includes routed frame)  
**FRAMED END PANEL WITH VERTICAL DIVIDING RAIL (ISLAND)**  
 720 X 901-1200  
 (includes routed frame)

### SANDED

### PAINT TO ORDER STANDARD COLOURS

	WHITES/CREAMS	BEIGES	BLUES	GREENS	GREYS/BLACKS	PINKS/REDS
Sanded Ash	Brilliant White	Shell	Pantry Blue	Sage Green	Light Grey	Cashmere
	Porcelain	Taupe Grey	Light Teal	Cardamom	Dust Grey	Vintage Pink
	Ivory	Mussel	Airforce	Reed Green	Monument Grey	Antique Red
		Stone	Parisian Blue	Willow	Gunmetal Grey	
		Stone Grey	Marine	Viridian	Graphite	
		Lava	Slate Blue	Heritage Green	Cannon Black	
			Indigo	Deep Forest		



### MADE TO ORDER ACCESSORIES: FOR HANDLELESS

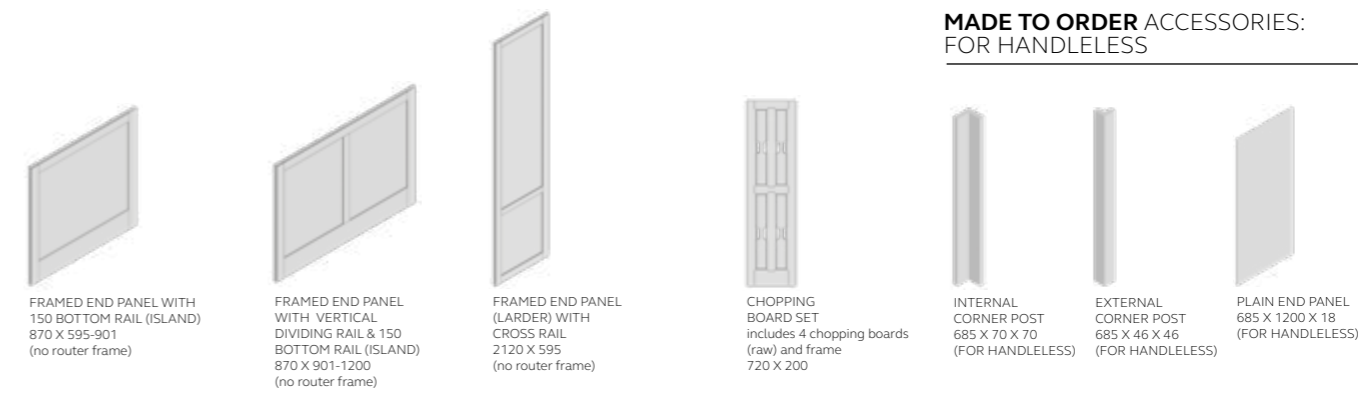

**FRAMED END PANEL WITH 150 BOTTOM RAIL (ISLAND)**  
 870 X 595-901  
 (no router frame)  
**FRAMED END PANEL WITH VERTICAL DIVIDING RAIL & 150 BOTTOM RAIL (ISLAND)**  
 870 X 901-1200  
 (no router frame)  
**FRAMED END PANEL (LARDER) WITH CROSS RAIL**  
 2120 X 595  
 (no router frame)  
**CHOPPING BOARD SET**  
 includes 4 chopping boards (raw) and frame  
 720 X 200  
**INTERNAL CORNER POST**  
 685 X 70 X 70  
 (FOR HANDLELESS)  
**EXTERNAL CORNER POST**  
 685 X 46 X 46  
 (FOR HANDLELESS)  
**PLAIN END PANEL**  
 685 X 1200 X 18  
 (FOR HANDLELESS)

### DOOR SPECIFICATION

<b>Description</b>	Inframe effect narrow shaker - 5 piece solid frame with flat veneer centre panel
<b>Finish</b>	Ash painted or sanded
<b>Frame material</b>	Ash
<b>Centre panel material</b>	Ash veneer
<b>Door thickness</b>	20mm
<b>Frame width</b>	68mm; includes 28mm routed frame & 5mm routerline
<b>Edge colour</b>	As face
<b>Reverse colour</b>	As face

### LEAD TIMES EXCLUDING DELIVERY (WORKING DAYS)

FINISH	MADE TO ORDER & SPECIAL SIZES	
	DOORS	PANELS
Sanded Ash	15	10
Paint to order standard colours	20	15
Colour Match Service	25	20

### MADE TO ORDER PLAIN PANELS



PLAIN END PANEL

### SIZE PARAMETERS:

Height (mm)		Width (mm)	
Min	Max	Min	Max
70	900	100	1200
901	1250	100	900
1251	2500	100	800



## EX-STOCK PAINT TO ORDER STANDARD COLOURS

	WHITES/CREAMS	BEIGES	BLUES	GREENS	GREYS/BLACKS	PINKS/REDS
Primed	Brilliant White	Shell	Pantry Blue	Sage Green	Dust Grey	Cashmere
Porcelain	Ivory	Taupe Grey	Light Teal	Cardamom	Monument Grey	Vintage Pink
Light Grey		Mussel	Airforce	Reed Green	Gunmetal Grey	Antique Red
Marine		Stone	Parisian Blue	Willow	Graphite	
Heritage Green		Stone Grey	Slate Blue	Viridian	Cannon Black	
		Lava	Indigo	Deep Forest		

**CMS** Colour Match Service

## DOOR SPECIFICATION

<b>Description</b>	Narrow shaker - routed
<b>Finish</b>	Smooth matte painted - 15% sheen
<b>Frame material</b>	MDF (high tension mdf plus)
<b>Door thickness</b>	18mm
<b>Frame width</b>	68mm
<b>Edge colour</b>	As face
<b>Reverse colour</b> <span>EX</span>	As face - melamine matte*
<b>Reverse colour</b> <span>PTO</span>	As face - painted

\*Please note: our primed product comes with a White reverse.

## LEAD TIMES EXCLUDING DELIVERY (WORKING DAYS)

FINISH	STANDARD PRODUCT
<b>Primed</b>	<span>EX</span>
<b>Painted</b> ex-stock colours	<span>EX</span>
<b>Paint to order</b> standard colours	<span>10</span>
<b>Colour Match Service</b>	<span>20</span>

## STANDARD DRAWERFRONTS & DOORS

- 115 x 597 slab
- 140 x 297 slab
- 140 x 397 slab
- 140 x 447 slab
- 140 x 497 slab
- 140 x 597 slab
- 140 x 797 slab
- 140 x 897 slab
- 140 x 997 slab
- 175 x 397 slab
- 175 x 497 slab
- 175 x 597 slab
- 283 x 497
- 283 x 597
- 283 x 797
- 283 x 897
- 283 x 997
- 315 x 457 american fridge freezer door
- 355 x 497
- 355 x 597
- 355 x 797
- 355 x 897
- 355 x 997
- 355 x 1197
- 400 x 597 appliance door
- 450 x 597
- 495 x 397
- 495 x 497
- 495 x 597
- 570 x 297
- 570 x 397
- 570 x 447
- 570 x 497
- 570 x 597
- 645 x 597
- 715 x 147 slab
- 715 x 277
- 715 x 297
- 715 x 315
- 715 x 347
- 715 x 397
- 715 x 397 plain frame includes clear glass
- 715 x 447
- 715 x 497
- 715 x 497 plain frame includes clear glass
- 715 x 547
- 715 x 597
- 825 x 597
- 895 x 297
- 895 x 397
- 895 x 447
- 895 x 497
- 895 x 597
- 825 x 597 with cross rail
- 895 x 297 with cross rail
- 895 x 397 with cross rail
- 895 x 447 with cross rail
- 895 x 497 with cross rail
- 895 x 597 with cross rail
- 895 x 597 plain frame includes clear glass
- 980 x 597
- 1215 x 497 plain frame includes clear glass
- 1245 x 297
- 1245 x 397
- 1245 x 497
- 1245 x 597
- 1425 x 297 with cross rail
- 1425 x 597 with cross rail
- 1965 x 297 with 2 cross rails
- 1965 x 397 with 2 cross rails
- 1965 x 497 with 2 cross rails
- 1965 x 597 with 2 cross rails

## STANDARD DOORS



STANDARD DOOR | PLAIN FRAME includes clear glass | CROSS RAIL DOOR

## STANDARD ACCESSORIES

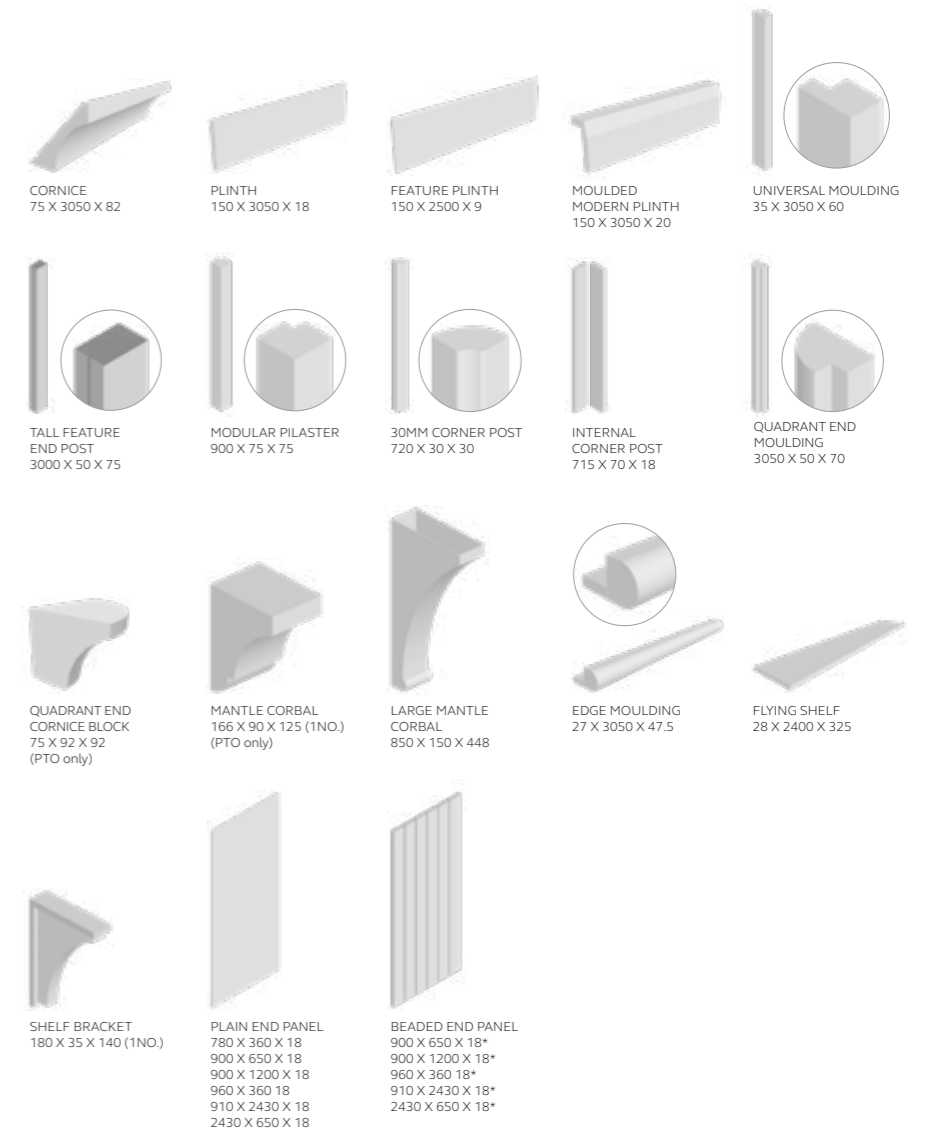

CORNICE 75 X 3050 X 82 | PLINTH 150 X 3050 X 18 | FEATURE PLINTH 150 X 2500 X 9 | MOULDED MODERN PLINTH 150 X 3050 X 20 | UNIVERSAL MOULDING 35 X 3050 X 60

TALL FEATURE END POST 3000 X 50 X 75 | MODULAR PILASTER 900 X 75 X 75 | 30MM CORNER POST 720 X 30 X 30 | INTERNAL CORNER POST 715 X 70 X 18 | QUADRANT END MOULDING 3050 X 50 X 70

QUADRANT END CORNICE BLOCK 75 X 92 X 92 (PTO only) | MANTLE CORBAL 166 X 90 X 125 (1NO.) (PTO only) | LARGE MANTLE CORBAL 850 X 150 X 448 | EDGE MOULDING 27 X 3050 X 47.5 | FLYING SHELF 28 X 2400 X 325

SHELF BRACKET 180 X 35 X 140 (1NO.) | PLAIN END PANEL 780 X 360 X 18 | BEADED END PANEL 900 X 650 X 18\* | 900 X 1200 X 18\* | 960 X 360 X 18\* | 910 X 2430 X 18\* | 2430 X 650 X 18\*

\* Beading runs up and down the panel height.



## HANDLELESS DOORS & ACCESSORIES

325 x 497
325 x 597
325 x 797
325 x 897
325 x 997
325 x 1197
685 x 397
685 x 447
685 x 497
685 x 597

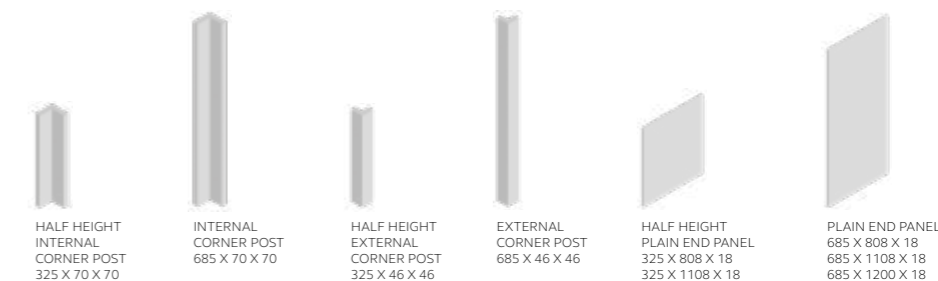

## HANDLELESS KITS

### HALF HEIGHT L-SHAPE PANEL & POST KIT FOR BASE UNIT



### FULL HEIGHT L-SHAPE PANEL & POST KIT FOR BASE UNIT

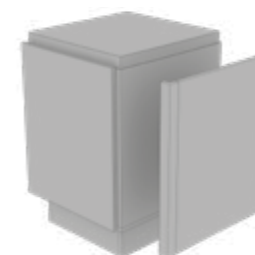

### HALF HEIGHT C-SHAPE PANEL & POST KIT FOR 900 & 1200 WIDE ISLANDS



### FULL HEIGHT C-SHAPE PANEL & POST KIT FOR 900 & 1200 WIDE ISLANDS



### HALF HEIGHT L SHAPE PANEL & POST KIT FOR BASE UNIT\*

CODE	KIT INCLUDES
prefix-325600LPANPKT	1 x half height external corner post 1 x plain end panel 325 x 808 2 x mdf fixing batons

### FULL HEIGHT L SHAPE PANEL & POST KIT FOR BASE UNIT

CODE	KIT INCLUDES
prefix-685600LPANPKT	1 x external corner post 1 x plain end panel 685 x 808 2 x mdf fixing batons

### HALF HEIGHT C SHAPE PANEL & POST KIT FOR 900 WIDE ISLAND\*

CODE	KIT INCLUDES
prefix-325960CPANPKT	2 x half height external corner posts 1 x plain end panel 325 x 808 2 x mdf fixing batons

### FULL HEIGHT C SHAPE PANEL & POST KIT FOR 900 WIDE ISLAND

CODE	KIT INCLUDES
prefix-685960CPANPKT	2 x external corner posts 1 x plain end panel 685 x 808 2 x mdf fixing batons

### HALF HEIGHT C SHAPE PANEL & POST KIT FOR 1200 WIDE ISLAND\*

CODE	KIT INCLUDES
prefix-3251200CPANPKT	2 x half height external corner posts 1 x plain end panel 325 x 1108 3 x mdf fixing batons

### FULL HEIGHT C SHAPE PANEL & POST KIT FOR 1200 WIDE ISLAND

CODE	KIT INCLUDES
prefix-6851200CPANPKT	2 x half height external corner posts 1 x plain end panel 685 x 1108 3 x mdf fixing batons

Please refer to pages 286-291 for fitting details.

\* Please note: 2 panel kits are required for each half-height base run / island end solution.

## EX-STOCK

## PAINT TO ORDER STANDARD COLOURS

	WHITES/CREAMS	BEIGES	BLUES	GREENS	GREYS/BLACKS	PINKS/REDS
Primed	Brilliant White	Shell	Pantry Blue	Sage Green	Dust Grey	Cashmere
Porcelain	Ivory	Taupe Grey	Light Teal	Cardamom	Monument Grey	Vintage Pink
Light Grey		Mussel	Airforce	Reed Green	Gunmetal Grey	Antique Red
Marine		Stone	Parisian Blue	Willow	Graphite	
Heritage Green		Stone Grey	Slate Blue	Viridian	Cannon Black	
		Lava	Indigo	Deep Forest		



## DOOR SPECIFICATION

Description	Shaker - routed
Finish	Smooth matte painted - 15% sheen
Frame material	MDF (high tension mdf plus)
Door thickness	18mm
Frame width	68mm
Edge colour	As face
Reverse colour <span>EX</span>	As face - melamine matte*
Reverse colour <span>PTO</span>	As face - painted

\*Please note: our primed product comes with a White reverse.

## LEAD TIMES EXCLUDING DELIVERY (WORKING DAYS)

FINISH	STANDARD PRODUCT
Primed	<span>EX</span>
Painted ex-stock colours	<span>EX</span>
Paint to order standard colours	<span>10</span>
Colour Match Service	<span>20</span>



**EX-STOCK**      **MADE TO ORDER**

	Porcelain		Porcelain
	Light Grey		Light Grey
	Cashmere		Cashmere
	Dust Grey		Dust Grey
	Indigo		Indigo
	Graphite		Graphite

**DOOR SPECIFICATION**

<b>Description</b>	Shaker - 5 piece frame with bevelled edge & v-groove
<b>Finish</b>	Smooth matte foil
<b>Base material</b>	MDF wrapped in Alkorcell
<b>Door thickness</b>	19mm
<b>Frame width</b>	68mm
<b>Edge colour</b>	As face
<b>Reverse colour</b>	As face

**LEAD TIMES EXCLUDING DELIVERY (WORKING DAYS)**

FINISH	STANDARD PRODUCTS	MADE TO ORDER	
		DOORS	PANELS
Foil Ex-stock colours	EX	15	10

**STANDARD DRAWERFRONTS & DOORS**

- 115 x 597 slab
- 140 x 297 slab
- 140 x 397 slab
- 140 x 447 slab
- 140 x 497 slab
- 140 x 597 slab
- 140 x 797 slab
- 140 x 897 slab
- 140 x 997 slab
- 175 x 397 slab
- 175 x 497 slab
- 175 x 597 slab
- 283 x 497
- 283 x 597
- 283 x 797
- 283 x 897
- 283 x 997
- 355 x 497
- 355 x 597
- 355 x 797
- 355 x 897
- 355 x 997
- 450 x 597
- 495 x 397
- 495 x 597
- 570 x 297
- 570 x 397
- 570 x 447
- 570 x 497
- 570 x 597
- 645 x 597
- 715 x 147 slab
- 715 x 297
- 715 x 276
- 715 x 276 pair
- 715 x 315
- 715 x 315 pair
- 715 x 347
- 715 x 397
- 715 x 397 plain frame
- 715 x 447
- 715 x 497
- 715 x 497 plain frame
- 715 x 497 single glazed door includes clear glass
- 715 x 547
- 715 x 597
- 825 x 597
- 895 x 297
- 895 x 347
- 895 x 397
- 895 x 447
- 895 x 497
- 895 x 497 plain frame
- 895 x 497 single glazed door includes clear glass
- 895 x 597
- 980 x 597
- 1245 x 297
- 1245 x 397
- 1245 x 447
- 1245 x 497
- 1245 x 597
- 1425 x 297
- 1425 x 597

**STANDARD DOORS**



**STANDARD ACCESSORIES**

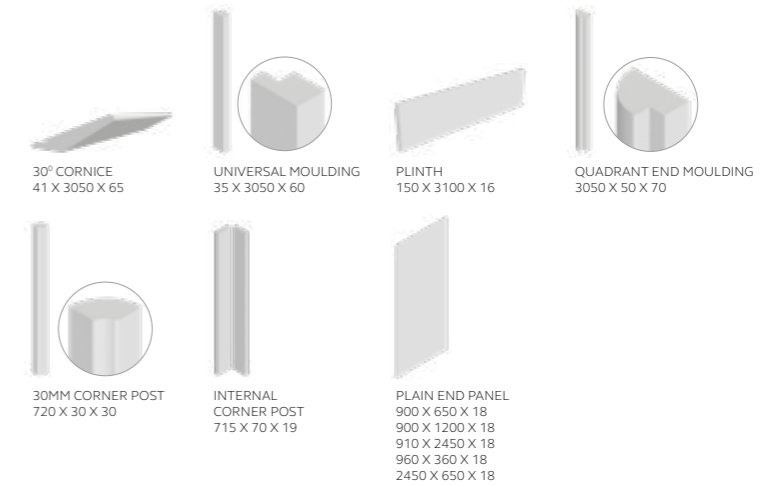

**MADE TO ORDER DRAWERFRONTS & DOORS**

PLEASE REFER TO THE CURRENT PRICE LIST FOR (h) & (w) LIMITATIONS.



Doors over 1425 require cross rails. Please specify 1, 2 or 3 rails when ordering.

**MADE TO ORDER PLAIN PANELS**



**SIZE PARAMETERS:**

Height (mm)		Width (mm)	
Min	Max	Min	Max
70	900	100	1200
901	1250	100	900
1251	2500	100	800



## EX-STOCK MADE TO ORDER

Porcelain	Porcelain
Light Grey	Light Grey
Cashmere	Cashmere
	Dust Grey
	Indigo
	Graphite

## DOOR SPECIFICATION

Description	Shaker - 5 piece frame with bevelled edge & v-groove
Finish	Smooth matte foil
Base material	MDF wrapped in Alkorcell
Door thickness	19mm
Frame width	68mm
Edge colour	As face
Reverse colour	As face

## LEAD TIMES EXCLUDING DELIVERY (WORKING DAYS)

FINISH	STANDARD PRODUCTS	MADE TO ORDER	
		DOORS	PANELS
Foil Ex-stock colours	EX	15	10

## STANDARD DRAWERFRONTS & DOORS

- 140 x 297 slab
- 140 x 397 slab
- 140 x 447 slab
- 140 x 497 slab
- 140 x 797 slab
- 140 x 897 slab
- 140 x 997 slab
- 215 x 397
- 215 x 447
- 215 x 497
- 215 x 797
- 215 x 897
- 215 x 997
- 283 x 497
- 283 x 797
- 283 x 897
- 283 x 997
- 355 x 497
- 355 x 797
- 355 x 897
- 355 x 997
- 450 x 397
- 450 x 447
- 450 x 497
- 570 x 297
- 570 x 397
- 570 x 447
- 570 x 497
- 715 x 297
- 715 x 347
- 715 x 397
- 715 x 447
- 715 x 497
- 1495 x 397 with 1 cross rail
- 1495 x 447 with 1 cross rail
- 1495 x 497 with 1 cross rail
- 1595 x 397 with 1 cross rail
- 1595 x 447 with 1 cross rail
- 1595 x 497 with 1 cross rail
- 2155 x 397 with 2 cross rails
- 2155 x 447 with 2 cross rails
- 2155 x 497 with 2 cross rails
- 2250 x 397 with 2 cross rails
- 2250 x 447 with 2 cross rails
- 2250 x 497 with 2 cross rails
- 2155 x 497 mirrored door with 2 cross rails
- 2250 x 497 mirrored door with 2 cross rails

## STANDARD DOORS

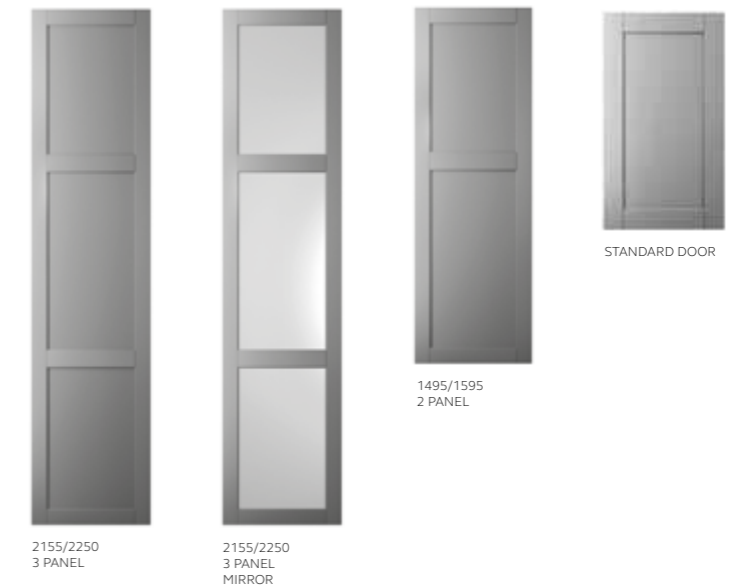

## STANDARD ACCESSORIES



## MADE TO ORDER DRAWERFRONTS & DOORS

PLEASE REFER TO THE CURRENT PRICE LIST FOR (h) & (w) LIMITATIONS.



Doors over 1425 require cross rails. Please specify 1, 2 or 3 rails when ordering.

## MADE TO ORDER PLAIN PANELS



## SIZE PARAMETERS:

Height (mm)		Width (mm)	
Min	Max	Min	Max
70	900	100	1200
901	1250	100	900
1251	2500	100	800



**EX-STOCK** | **PAINT TO ORDER STANDARD COLOURS**

	WHITES/CREAMS	BEIGES	BLUES	GREENS	GREYS/BLACKS	PINKS/REDS
Primed	Brilliant White	Shell	Pantry Blue	Sage Green	Light Grey	Cashmere
	Porcelain	Taupe Grey	Light Teal	Cardamom	Dust Grey	Vintage Pink
	Ivory	Mussel	Airforce	Reed Green	Monument Grey	Antique Red
		Stone	Parisian Blue	Willow	Gunmetal Grey	
		Stone Grey	Marine	Viridian	Graphite	
		Lava	Slate Blue	Heritage Green	Cannon Black	
		Indigo	Deep Forest			

**CMS** Colour Match Service

**DOOR SPECIFICATION**

<b>Description</b>	Inframe effect routed shaker
<b>Finish</b>	Smooth matte painted - 15% sheen
<b>Frame material</b>	MDF (high tension mdf plus)
<b>Door thickness</b>	18mm
<b>Door Frame width</b>	99mm; includes 32mm routed frame & 4.7mm routerline
<b>Edge colour</b>	As face
<b>Reverse colour</b> EX	As face - melamine matte*
<b>Reverse colour</b> PTO	As face - painted

\*Please note: our primed product comes with a White reverse.

**LEAD TIMES EXCLUDING DELIVERY (WORKING DAYS)**

FINISH	STANDARD PRODUCT
Primed	EX
Paint to order standard colours	10
Colour Match Service	20

**STANDARD DRAWERFRONTS & DOORS**

- 1 115 x 597 slab
- 1 140 x 297 slab
- 1 140 x 397 slab
- 1 140 x 447 slab
- 1 140 x 497 slab
- 1 140 x 597 slab
- 1 140 x 797 slab
- 1 140 x 897 slab
- 1 140 x 997 slab
- 1 175 x 397 slab
- 1 175 x 497 slab
- 1 175 x 597 slab
- 2 283 x 497
- 2 283 x 597
- 2 283 x 797
- 2 283 x 897
- 2 283 x 997
- 2 315 x 457 american fridge freezer door
- 2 355 x 497
- 2 355 x 597
- 2 355 x 797
- 2 355 x 897
- 2 355 x 997
- 2 355 x 1197
- 3 283 x 497 slab
- 3 283 x 597 slab
- 3 283 x 797 slab
- 3 283 x 897 slab
- 3 283 x 997 slab
- 3 355 x 497 slab
- 3 355 x 597 slab
- 3 355 x 797 slab
- 3 355 x 897 slab
- 3 355 x 997 slab
- 3 355 x 1197 slab
- 4 355 x 497 plain frame includes clear glass
- 5 400 x 597 appliance door
- 5 450 x 597
- 5 495 x 397
- 5 495 x 497
- 5 495 x 597
- 5 570 x 297
- 5 570 x 397
- 5 570 x 447
- 5 570 x 497
- 5 570 x 597
- 5 645 x 597
- 6 715 x 147 slab
- 7 715 x 277
- 7 715 x 297
- 7 715 x 315
- 7 715 x 347
- 7 715 x 397
- 7 715 x 447
- 7 715 x 497
- 7 715 x 547
- 7 715 x 597
- 8 750 x 277 with integrated pelmet
- 8 750 x 297 with integrated pelmet
- 8 750 x 315 with integrated pelmet
- 8 750 x 347 with integrated pelmet
- 8 750 x 397 with integrated pelmet
- 8 750 x 447 with integrated pelmet
- 8 750 x 497 with integrated pelmet
- 8 750 x 547 with integrated pelmet
- 8 750 x 597 with integrated pelmet

**STANDARD DRAWERFRONTS & DOORS**

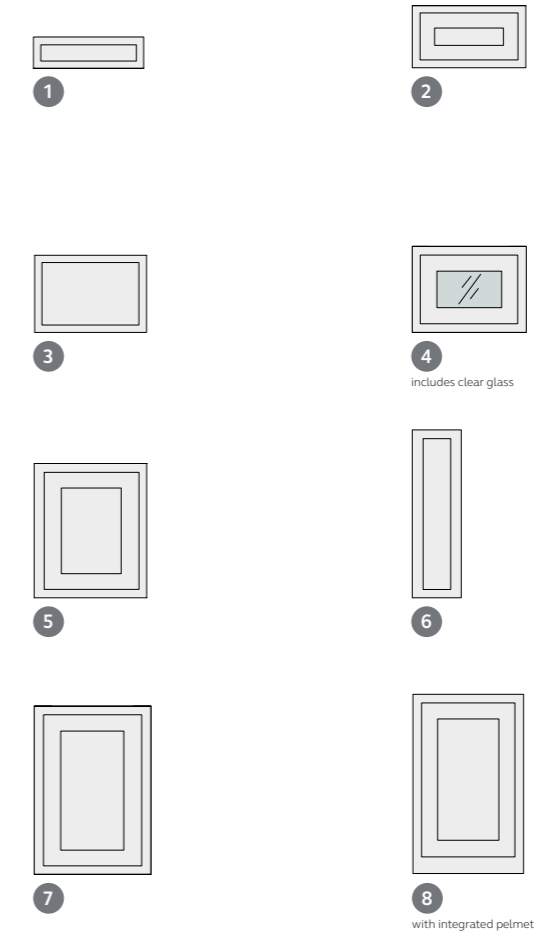

STANDARD  
DRAWERFRONTS & DOORS

- 9 825 x 597
- 9 895 x 297
- 9 895 x 397
- 9 895 x 447
- 9 895 x 497
- 9 895 x 597
- 10 930 x 297 with integrated pelmet
- 10 930 x 397 with integrated pelmet
- 10 930 x 447 with integrated pelmet
- 10 930 x 497 with integrated pelmet
- 10 930 x 597 with integrated pelmet
- 11 750 x 397 plain frame with integrated pelmet, includes clear glass
- 11 750 x 497 plain frame with integrated pelmet, includes clear glass
- 11 930 x 497 plain frame with integrated pelmet, includes clear glass
- 12 980 x 597
- 12 1245 x 297
- 12 1245 x 397
- 12 1245 x 497
- 12 1245 x 597
- 12 1425 x 297
- 12 1425 x 597
- 13 1215 x 497 plain frame includes clear glass
- 14 1965 x 297 with 2 cross rails
- 14 1965 x 397 with 2 cross rails
- 14 1965 x 497 with 2 cross rails
- 14 1965 x 597 with 2 cross rails

STANDARD DRAWERFRONTS & DOORS

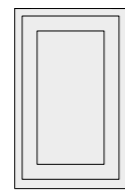

9

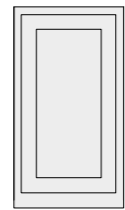

10

with integrated pelmet

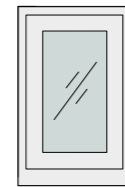

11

plain frame with integrated pelmet, includes clear glass

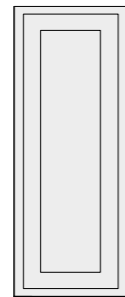

12

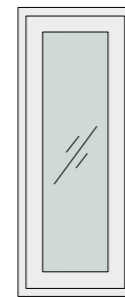

13

includes clear glass

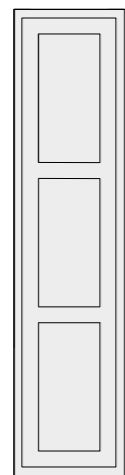

14

STANDARD ACCESSORIES



CORNICE  
75 X 3050 X 82



UNDER CORNICE  
50 X 3000 X 68



PLINTH  
150 X 3050 X 18



FEATURE PLINTH  
150 X 2500 X 9



MOULDED MODERN PLINTH  
150 X 3050 X 20



UNIVERSAL MOULDING  
35 X 3050 X 60

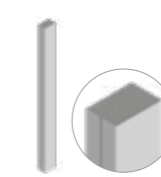

TALL FEATURE  
END POST  
3000 X 50 X 75

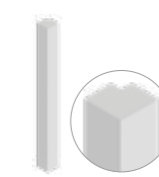

MODULAR PILASTER  
900 X 75 X 75

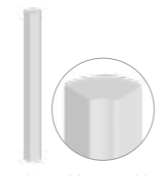

30MM CORNER POST  
720 X 30 X 30



INTERNAL CORNER POST  
720 X 70 X 18

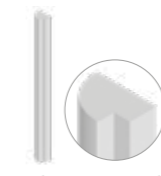

QUADRANT END MOULDING  
3050 X 50 X 70



QUADRANT END CORNICE BLOCK  
75 X 92 X 92  
(PTO only)



QUADRANT END  
UNDER CORNICE BLOCK  
50 X 48 X 48



MANTLE CORBAL  
166 X 90 X 125 (1NO.)  
(PTO only)



LARGE MANTLE CORBAL  
850 X 150 X 448

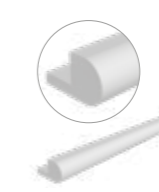

EDGE MOULDING  
27 X 3050 X 47.5



FLYING SHELF  
28 X 2400 X 325



SHELF BRACKET  
180 X 35 X 140 (1NO.)



PLAIN END PANEL  
2430 X 650 X 18  
910 X 2430 X 18  
900 X 1200 X 18  
900 X 650 X 18  
960 X 360 18

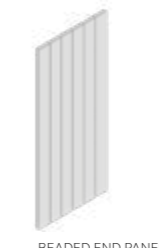

BEADED END PANEL  
2430 X 650 X 18\*  
910 X 2430 X 18\*  
900 X 1200 X 18\*  
900 X 650 X 18\*  
960 X 360 18\*

\* Beading runs up and down the panel height.



## STANDARD DRAWERFRONTS & DOORS

- 115 x 597 slab
- 140 x 297
- 140 x 397
- 140 x 447
- 140 x 497
- 140 x 597
- 140 x 797
- 140 x 897
- 140 x 997
- 175 x 397
- 175 x 497
- 175 x 597
- 283 x 497
- 283 x 597
- 283 x 797
- 283 x 897
- 283 x 997
- 355 x 497
- 355 x 597
- 355 x 797
- 355 x 897
- 355 x 997
- 450 x 597
- 495 x 397
- 495 x 597
- 570 x 297
- 570 x 397
- 570 x 447
- 570 x 497
- 570 x 597
- 645 x 597
- 715 x 147
- 715 x 297
- 715 x 272
- 715 x 272 pair
- 715 x 312
- 715 x 312 pair
- 715 x 347
- 715 x 397
- 715 x 397 plain frame
- 715 x 447
- 715 x 497
- 715 x 497 plain frame
- 715 x 547
- 715 x 597
- 825 x 597
- 895 x 297
- 895 x 347
- 895 x 397
- 895 x 447
- 895 x 497
- 895 x 497 plain frame
- 895 x 597
- 980 x 597
- 1245 x 297
- 1245 x 397
- 1245 x 447
- 1245 x 497
- 1245 x 597
- 1425 x 297
- 1425 x 597

## STANDARD DOORS



STANDARD DOOR



PLAIN FRAME  
includes clear glass



STANDARD DOOR



CROSS RAIL DOOR

## MADE TO ORDER DOORS

PLEASE REFER TO THE CURRENT PRICE LIST FOR (h) & (w) LIMITATIONS.

## STANDARD ACCESSORIES

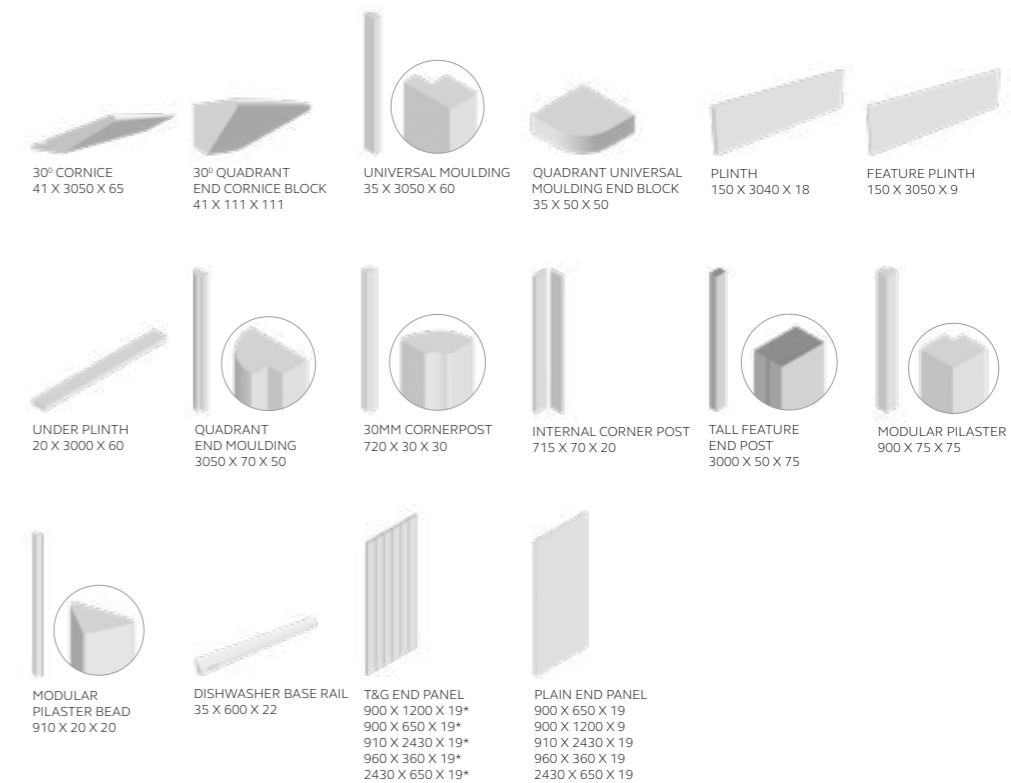

\* T&G runs up and down height of panel.

## MADE TO ORDER PLAIN PANELS



PLAIN END PANEL

## SIZE PARAMETERS:

Height (mm)		Width (mm)	
Min	Max	Min	Max
70	900	100	1200
901	1250	100	900
1251	2500	100	800

## EX-STOCK

## PAINT TO ORDER STANDARD COLOURS

	WHITES/CREAMS	BEIGES	BLUES	GREENS	GREYS/BLACKS	PINKS/REDS
Sanded Ash	Brilliant White	Shell	Pantry Blue	Sage Green	Dust Grey	Cashmere
Light Grey	Porcelain	Taupe Grey	Light Teal	Cardamom	Monument Grey	Vintage Pink
Heritage Green	Ivory	Mussel	Airforce	Reed Green	Gunmetal Grey	Antique Red
Graphite		Stone	Parisian Blue	Willow	Cannon Black	
		Stone Grey	Marine	Viridian		
		Lava	Slate Blue	Deep Forest		
		Indigo				

CMS Colour Match Service

## DOOR SPECIFICATION

Description	Shaker - 5 piece solid frame with integrated handle
	Ash Sanded
Finish	Ash painted or sanded
Frame material	Ash
Centre panel material	Ash veneer
Door thickness	21mm
Frame width	55mm
Edge colour	As face
Reverse colour	As face

## LEAD TIMES EXCLUDING DELIVERY (WORKING DAYS)

FINISH	STANDARD PRODUCTS	MADE TO ORDER	
		DOORS	PANELS
SADED Ash	EX	15	10
PAINTED Ex-stock colours	EX	20	15
PAINT TO ORDER Standard colours	10	20	15
COLOUR MATCH SERVICE	20	25	20



## EX-STOCK MADE TO ORDER

Porcelain	Porcelain
Ivory	Ivory
Mussel	Mussel
Light Grey	Light Grey
Taupe Grey *	Taupe Grey *
Cashmere	Cashmere
Dust Grey	Dust Grey
Reed Green *	Reed Green *
Indigo	Indigo
Heritage Green	Heritage Green
Graphite	Graphite

## DOOR SPECIFICATION

Description	Shaker - 5 piece frame with v-groove
Finish	<b>Standard:</b> Ash effect foil
	<b>Premier:</b> Oak effect foil *
Base material	MDF wrapped in Alkorcell
Door thickness	22mm
Frame width	94mm
Edge colour	As face
Reverse colour	As face

## LEAD TIMES EXCLUDING DELIVERY (WORKING DAYS)

FINISH	STANDARD PRODUCTS	MADE TO ORDER	
		DOORS	PANELS
Foil Ex-stock colours	EX	15	10

\*Premier Foil has an authentic painted Oak woodgrain effect with 3-4% sheen level - this differs from the standard Ash effect foil, therefore it is recommended that they are not mixed.

## STANDARD DRAWERFRONTS & DOORS

- 115 x 597 slab
- 140 x 297 slab
- 140 x 397 slab
- 140 x 447 slab
- 140 x 497 slab
- 140 x 597 slab
- 140 x 797 slab
- 140 x 897 slab
- 140 x 997 slab
- 175 x 397 slab
- 175 x 497 slab
- 175 x 597 slab
- 283 x 497
- 283 x 597
- 283 x 797
- 283 x 897
- 283 x 997
- 355 x 497
- 355 x 597
- 355 x 797
- 355 x 897
- 355 x 997
- 450 x 597
- 495 x 397
- 495 x 597
- 570 x 297
- 570 x 397
- 570 x 447
- 570 x 497
- 570 x 597
- 645 x 597
- 715 x 147 slab
- 715 x 297
- 715 x 271
- 715 x 271 pair
- 715 x 315
- 715 x 315 pair
- 715 x 347
- 715 x 397
- 715 x 397 plain frame
- 715 x 447
- 715 x 497
- 715 x 497 plain frame
- 715 x 547
- 715 x 597
- 825 x 597
- 895 x 297
- 895 x 347
- 895 x 397
- 895 x 447
- 895 x 497
- 895 x 597
- 980 x 597
- 1245 x 297
- 1245 x 397
- 1245 x 447
- 1245 x 497
- 1245 x 597
- 1425 x 597

## STANDARD DOORS

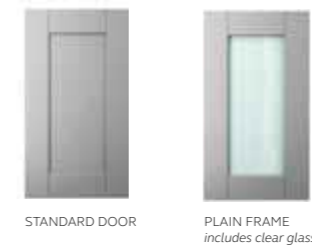

STANDARD DOOR PLAIN FRAME includes clear glass

## STANDARD ACCESSORIES

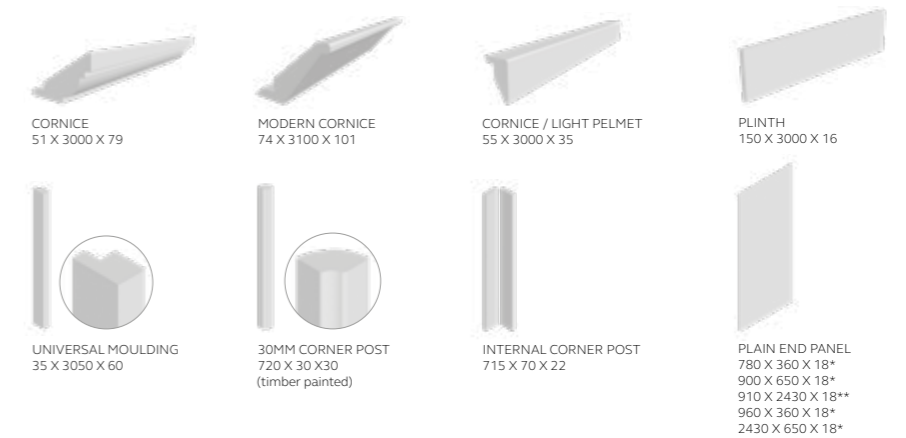

CORNICE 51 X 3000 X 79 MODERN CORNICE 74 X 3100 X 101 CORNICE / LIGHT PELMET 55 X 3000 X 35 PLINTH 150 X 3000 X 16

UNIVERSAL MOULDING 35 X 3050 X 60 30MM CORNER POST 720 X 30 X 30 (timber painted) INTERNAL CORNER POST 715 X 70 X 22 PLAIN END PANEL 780 X 360 X 18\* 900 X 650 X 18\* 910 X 2430 X 18\*\* 960 X 360 X 18\* 2430 X 650 X 18\*

\* Grain runs up and down height of panels.  
\*\* Grain runs horizontally.

## MADE TO ORDER DRAWERFRONTS & DOORS

PLEASE REFER TO THE CURRENT PRICE LIST FOR (h) & (w) LIMITATIONS.



2 PANEL STANDARD DOOR SLAB DRAWERFRONT

Doors over 1595 require cross rails. Please specify 1, 2 or 3 rails when ordering.

## MADE TO ORDER PLAIN PANELS

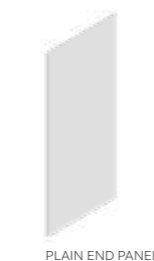

PLAIN END PANEL

## SIZE PARAMETERS:

Height (mm)		Width (mm)	
Min	Max	Min	Max
70	900	100	1200
901	1250	100	900
1251	2500	100	800



## EX-STOCK MADE TO ORDER

Porcelain	Porcelain
Light Grey	Ivory
Cashmere	Mussel
	Light Grey
	Taupe Grey *
	Cashmere
	Dust Grey
	Reed Green *
	Indigo
	Heritage Green
	Graphite

## DOOR SPECIFICATION

<b>Description</b>	Shaker - 5 piece frame with v-groove
<b>Finish</b>	<b>Standard:</b> Ash effect foil <b>Premier:</b> Oak effect foil *
<b>Base material</b>	MDF wrapped in Alkorcell
<b>Door thickness</b>	22mm
<b>Frame width</b>	94mm
<b>Edge colour</b>	As face
<b>Reverse colour</b>	As face

## LEAD TIMES EXCLUDING DELIVERY (WORKING DAYS)

FINISH	STANDARD PRODUCTS	MADE TO ORDER	
		DOORS	PANELS
Foil Ex-stock colours	EX	15	10

\*Premier Foil has an authentic painted Oak woodgrain effect with 3-4% sheen level - this differs from the standard Ash effect foil, therefore it is recommended that they are not mixed.

## STANDARD DRAWERFRONTS & DOORS

- 140 x 297 slab
- 140 x 397 slab
- 140 x 447 slab
- 140 x 497 slab
- 140 x 797 slab
- 140 x 897 slab
- 140 x 997 slab
- 215 x 397 slab
- 215 x 447 slab
- 215 x 497 slab
- 215 x 797 slab
- 215 x 897 slab
- 215 x 997 slab
- 283 x 497
- 283 x 797
- 283 x 897
- 283 x 997
- 355 x 497
- 355 x 797
- 355 x 897
- 355 x 997
- 450 x 397
- 450 x 447
- 450 x 497
- 570 x 297
- 570 x 397
- 570 x 447
- 570 x 497
- 715 x 297
- 715 x 347
- 715 x 397
- 715 x 447
- 715 x 497
- 1495 x 397
- 1495 x 447
- 1495 x 497
- 1595 x 397
- 1595 x 447
- 1595 x 497
- 2155 x 397 with 1 cross rail
- 2155 x 447 with 1 cross rail
- 2155 x 497 with 1 cross rail
- 2250 x 397 with 1 cross rail
- 2250 x 447 with 1 cross rail
- 2250 x 497 with 1 cross rail
- 2155 x 497 mirrored door with 1 cross rail
- 2250 x 497 mirrored door with 1 cross rail

## STANDARD DOORS



## STANDARD ACCESSORIES

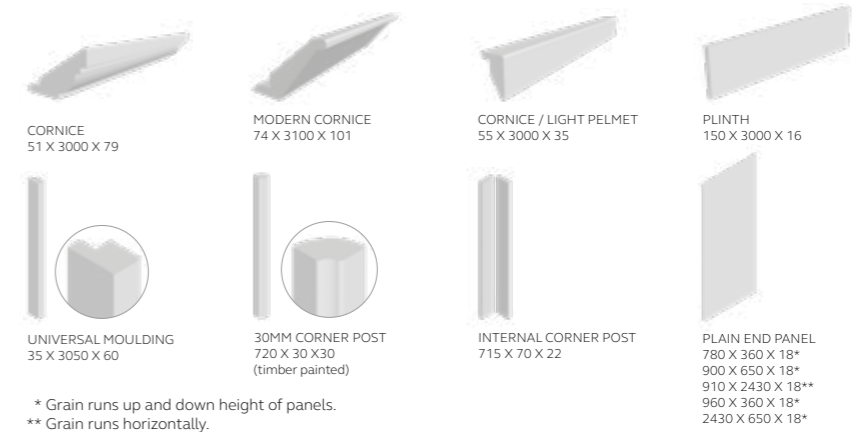

\* Grain runs up and down height of panels.  
\*\* Grain runs horizontally.

## MADE TO ORDER DRAWERFRONTS & DOORS

PLEASE REFER TO THE CURRENT PRICE LIST FOR (h) & (w) LIMITATIONS.



Doors over 1595 require cross rails. Please specify 1, 2 or 3 rails when ordering.

## MADE TO ORDER PLAIN PANELS



## SIZE PARAMETERS:

Height (mm)		Width (mm)	
Min	Max	Min	Max
70	900	100	1200
901	1250	100	900
1251	2500	100	800



## EX-STOCK

## PAINT TO ORDER STANDARD COLOURS

	WHITES/CREAMS	BEIGES	BLUES	GREENS	GREYS/BLACKS	PINKS/REDS
Sanded Ash	Brilliant White	Shell	Pantry Blue	Sage Green	Light Grey	Cashmere
	Porcelain	Taupe Grey	Light Teal	Cardamom	Dust Grey	Vintage Pink
	Ivory	Mussel	Airforce	Reed Green	Monument Grey	Antique Red
		Stone	Parisian Blue	Willow	Gunmetal Grey	
		Stone Grey	Marine	Viridian	Graphite	
		Lava	Slate Blue	Heritage Green	Cannon Black	
		Indigo	Deep Forest			

CMS Colour Match Service

## DOOR SPECIFICATION

Description	5 piece shaker with double step profile
Finish	Ash painted or sanded
Frame material	Ash
Centre panel material	Veneered centre panel
Door thickness	21mm
Frame width	78mm (59mm + 19mm double step)
Edge colour	As face
Reverse colour	As face

## LEAD TIMES EXCLUDING DELIVERY (WORKING DAYS)

FINISH	STANDARD PRODUCT
Sanded Ash	EX
Paint to order standard colours	10
Colour match service	20

## STANDARD DRAWERFRONTS & DOORS

- 115 x 596 slab
- 140 x 296 slab
- 140 x 396 slab
- 140 x 446 slab
- 140 x 496 slab
- 140 x 596 slab
- 140 x 796 slab
- 140 x 896 slab
- 140 x 996 slab
- 175 x 396 slab
- 175 x 496 slab
- 175 x 596 slab
- 140 x 296
- 140 x 396
- 140 x 446
- 140 x 496
- 140 x 596
- 140 x 796
- 140 x 896
- 140 x 996
- 175 x 396
- 175 x 496
- 175 x 596
- 283 x 496
- 283 x 596
- 283 x 796
- 283 x 896
- 283 x 996
- 355 x 496
- 355 x 496 plain frame
- 355 x 596
- 355 x 796
- 355 x 896
- 355 x 996
- 450 x 596
- 495 x 396
- 495 x 596
- 570 x 296
- 570 x 396
- 570 x 446
- 570 x 496
- 570 x 596
- 645 x 596
- 715 x 146 slab
- 715 x 146
- 715 x 256
- 715 x 296
- 715 x 272
- 715 x 272 pair
- 715 x 314
- 715 x 314 pair
- 715 x 320 quadrant door
- 715 x 346
- 715 x 396
- 715 x 396
- 715 x 446
- 715 x 496
- 715 x 496 plain frame
- 715 x 546
- 715 x 596
- 825 x 596
- 895 x 296
- 895 x 346
- 895 x 396
- 895 x 446
- 895 x 496
- 895 x 596
- 980 x 596
- 1215 x 296
- 1215 x 496 plain frame
- 1245 x 296
- 1245 x 396
- 1245 x 446
- 1245 x 496
- 1245 x 596
- 1425 x 596
- 1965 x 296 with 2 cross rails
- 1965 x 396 with 2 cross rails
- 1965 x 496 with 2 cross rails
- 1965 x 596 with 2 cross rails

## STANDARD DOORS



STANDARD DOOR PLAIN FRAME includes clear glass QUADRANT DOOR SLAB DRAWERFRONT

## STANDARD ACCESSORIES

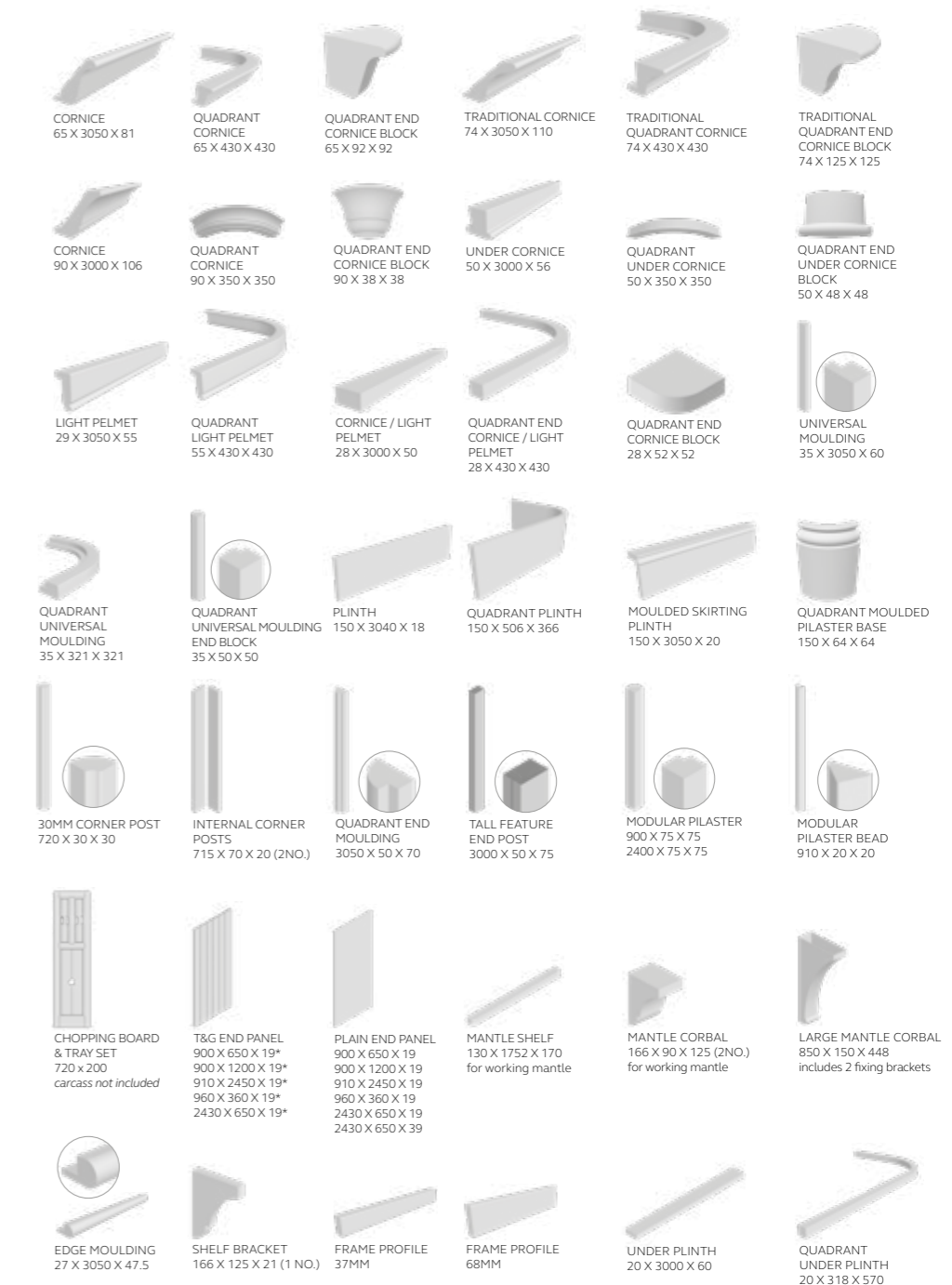

\* The T&G grooving and the timber grain run up and down the panel height.



## MADE TO ORDER DOORS

PLEASE REFER TO THE CURRENT PRICE LIST FOR (h) & (w) LIMITATIONS.



Doors over 1464 require cross rails. Please specify 1, 2 or 3 rails when ordering. Frames exclude glass.

## MADE TO ORDER ACCESSORIES

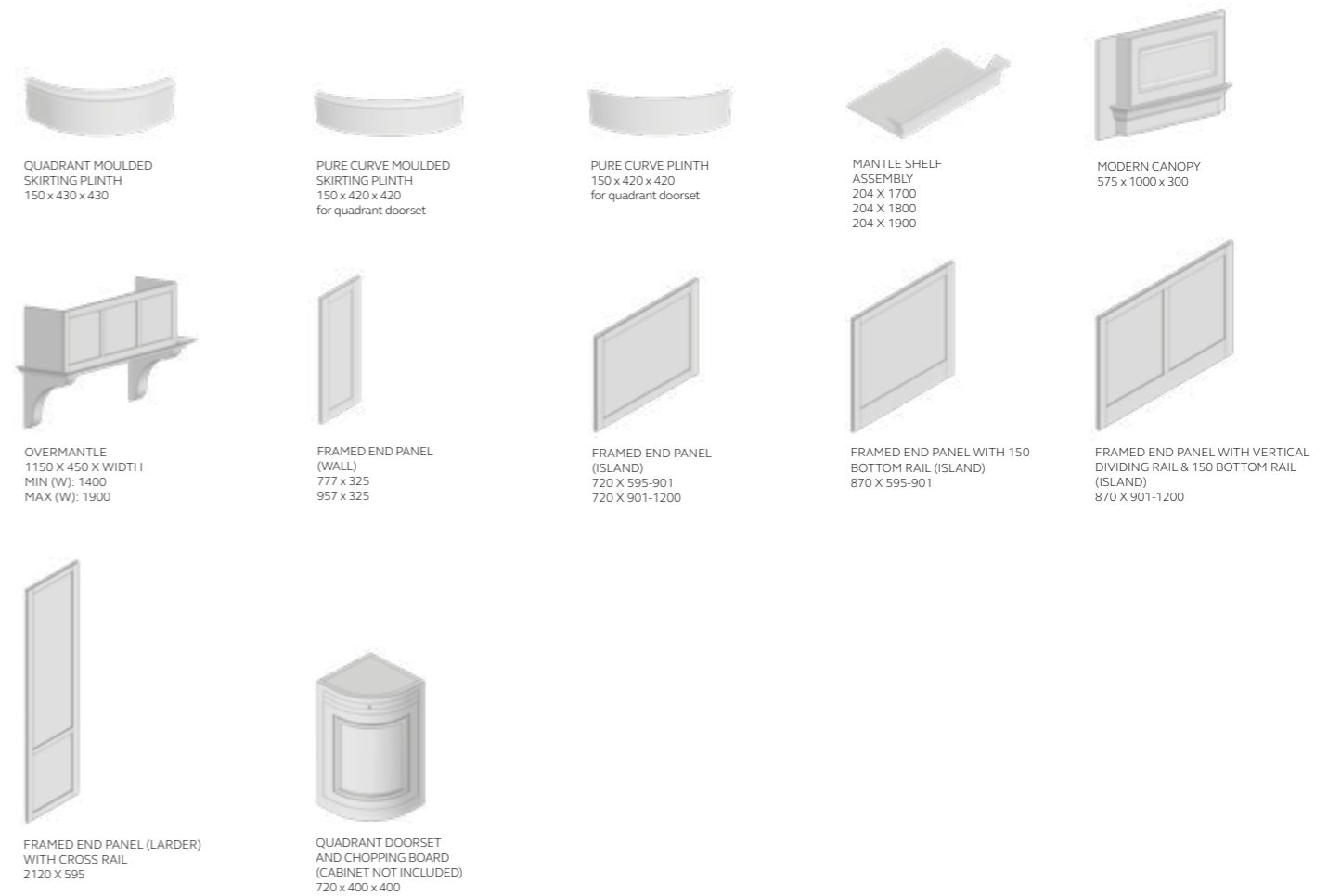

### SANDED

### PAINT TO ORDER STANDARD COLOURS

	WHITES/CREAMS	BEIGES	BLUES	GREENS	GREYS/BLACKS	PINKS/REDS
Sanded Ash	Brilliant White	Shell	Pantry Blue	Sage Green	Light Grey	Cashmere
	Porcelain	Taupe Grey	Light Teal	Cardamom	Dust Grey	Vintage Pink
	Ivory	Mussel	Airforce	Reed Green	Monument Grey	Antique Red
		Stone	Parisian Blue	Willow	Gunmetal Grey	
		Stone Grey	Marine	Viridian	Graphite	
		Lava	Slate Blue	Heritage Green	Cannon Black	
			Indigo	Deep Forest		



### DOOR SPECIFICATION

Description	5 piece shaker with double step profile
Finish	Ash painted or sanded
Frame material	Ash
Centre panel material	Veneered centre panel
Door thickness	21mm
Frame width	78mm (59mm +19mm double step)
Edge colour	As face
Reverse colour	As face

### LEAD TIMES EXCLUDING DELIVERY (WORKING DAYS)

FINISH	MADE TO ORDER & SPECIAL SIZES	
	DOORS	PANELS
Sanded Ash	15	10
Paint to order standard colours	20	15
Colour match service	25	20

## MADE TO ORDER PLAIN PANELS



PLAIN END PANEL

### SIZE PARAMETERS:

Height (mm)		Width (mm)	
Min	Max	Min	Max
70	900	100	1200
901	1250	100	900
1251	2500	100	800



## EX-STOCK PAINT TO ORDER STANDARD COLOURS

	WHITES/CREAMS	BEIGES	BLUES	GREENS	GREYS/BLACKS	PINKS/REDS
Sanded Ash *	Brilliant White	Shell	Pantry Blue	Cardamom	Monument Grey	Cashmere
Light Oak		Taupe Grey	Light Teal	Reed Green	Gunmetal Grey	Vintage Pink
Porcelain		Mussel	Airforce	Willow	Graphite	Antique Red
Ivory		Stone Grey	Parisian Blue	Viridian	Cannon Black	
Light Grey		Lava	Slate Blue	Heritage Green		
Sage Green			Indigo	Deep Forest		
Stone						
Dust Grey						
Marine						

**CMS** Colour Match Service

## DOOR SPECIFICATION

Description	Shaker - 5 piece solid frame with v-groove	
	Oak	Ash
Finish	Oak	Ash painted or sanded
Frame material	Oak	Ash
Centre panel material	Oak veneer	Ash veneer
Door thickness	20mm	
Frame width	93mm	
Edge colour	Oak	As face
Reverse colour	Oak	As face

\* Madison Sanded Ash is only suitable for overpainting.

## LEAD TIMES EXCLUDING DELIVERY (WORKING DAYS)

FINISH	STANDARD PRODUCT
Sanded Ash	EX
Stained Light Oak	EX
Painted ex-stock colours	EX
Paint to order standard colours	10
Colour match service	20

## STANDARD DRAWERFRONTS & DOORS

- 115 x 597 slab
- 140 x 297 slab
- 140 x 397 slab
- 140 x 447 slab
- 140 x 497 slab
- 140 x 597 slab
- 140 x 797 slab
- 140 x 897 slab
- 140 x 997 slab
- 175 x 397 slab
- 175 x 497 slab
- 175 x 597 slab
- 283 x 497
- 283 x 597
- 283 x 797
- 283 x 897
- 283 x 997
- 355 x 497
- 355 x 597
- 355 x 797
- 355 x 897
- 355 x 997
- 450 x 597
- 495 x 397
- 495 x 597
- 570 x 297
- 570 x 397
- 570 x 447
- 570 x 497
- 570 x 597
- 645 x 597
- 715 x 147 slab
- 715 x 257
- 715 x 297
- 715 x 273
- 715 x 273 pair
- 715 x 315
- 715 x 315 pair
- 715 x 320 quadrant door
- 715 x 347
- 715 x 397
- 715 x 397 georgian frame (8 panes)
- 715 x 397 plain frame
- 715 x 447
- 715 x 497
- 715 x 497 plain frame
- 715 x 497 georgian frame (8 panes)
- 715 x 547
- 715 x 597
- 825 x 597
- 895 x 297
- 895 x 347
- 895 x 397
- 895 x 447
- 895 x 497
- 895 x 497 georgian frame (10 panes)
- 895 x 597
- 980 x 597
- 1060 x 497 georgian frame (12 panes)
- 1245 x 297
- 1245 x 397
- 1245 x 447
- 1245 x 497
- 1245 x 597
- 1425 x 597
- 1965 x 597 with 2 cross rails

## STANDARD DOORS



## STANDARD ACCESSORIES

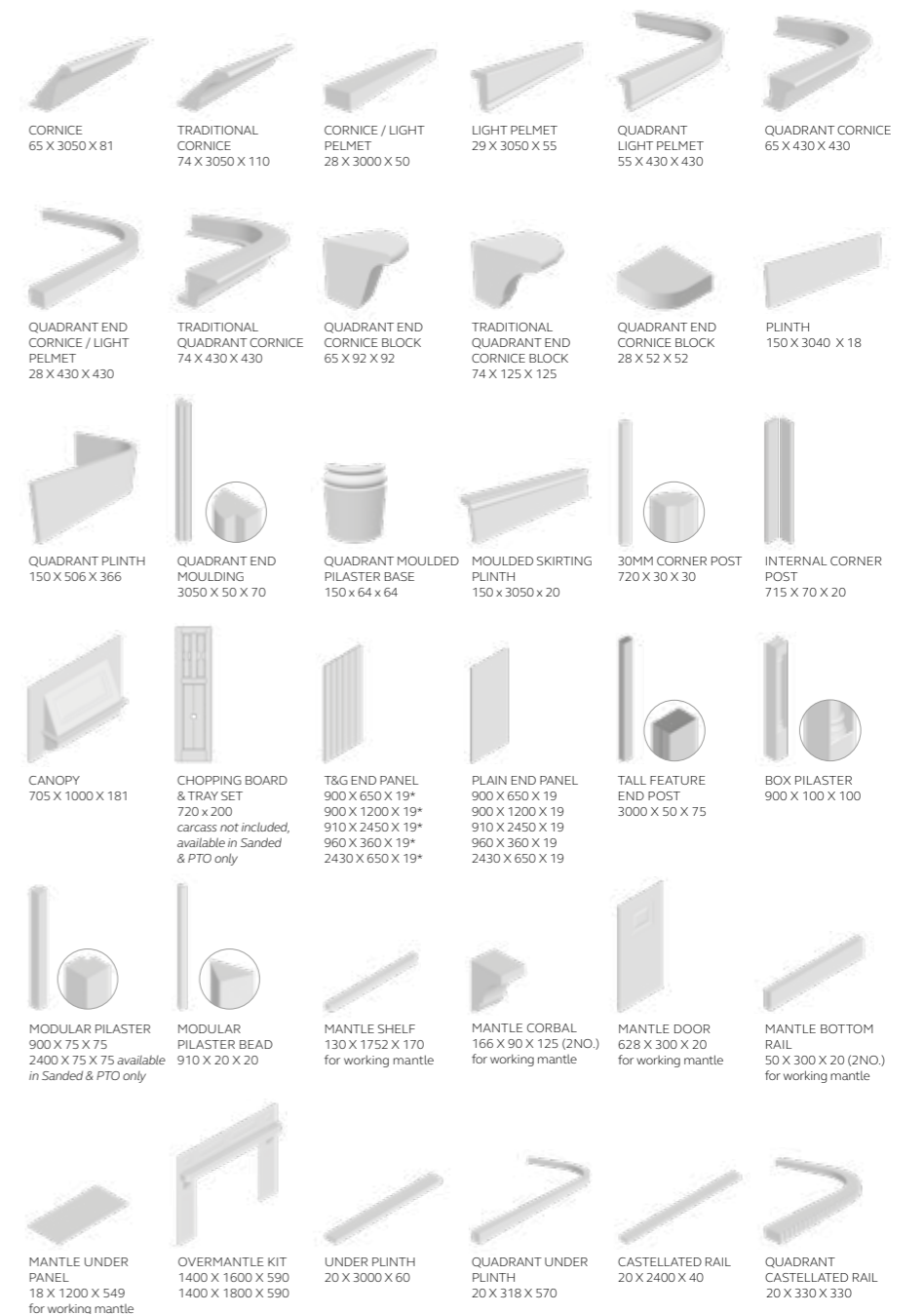

\* The T&G grooving and the timber grain run up and down the panel height.



## MADE TO ORDER DOORS

PLEASE REFER TO THE CURRENT PRICE LIST FOR (h) & (w) LIMITATIONS.

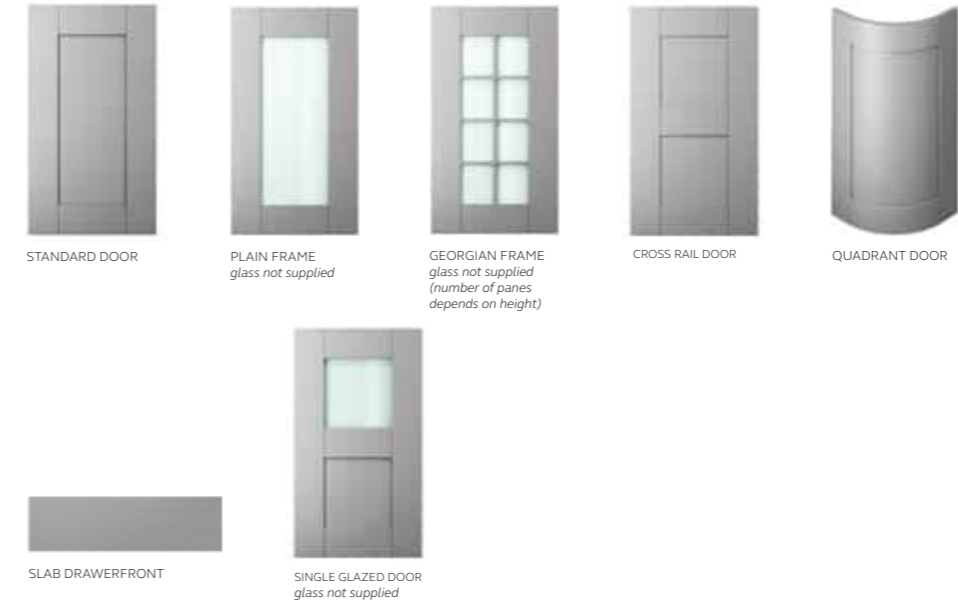

Doors over 1464 require cross rails. Please specify 1, 2 or 3 rails when ordering. Frames exclude glass.

## MADE TO ORDER ACCESSORIES

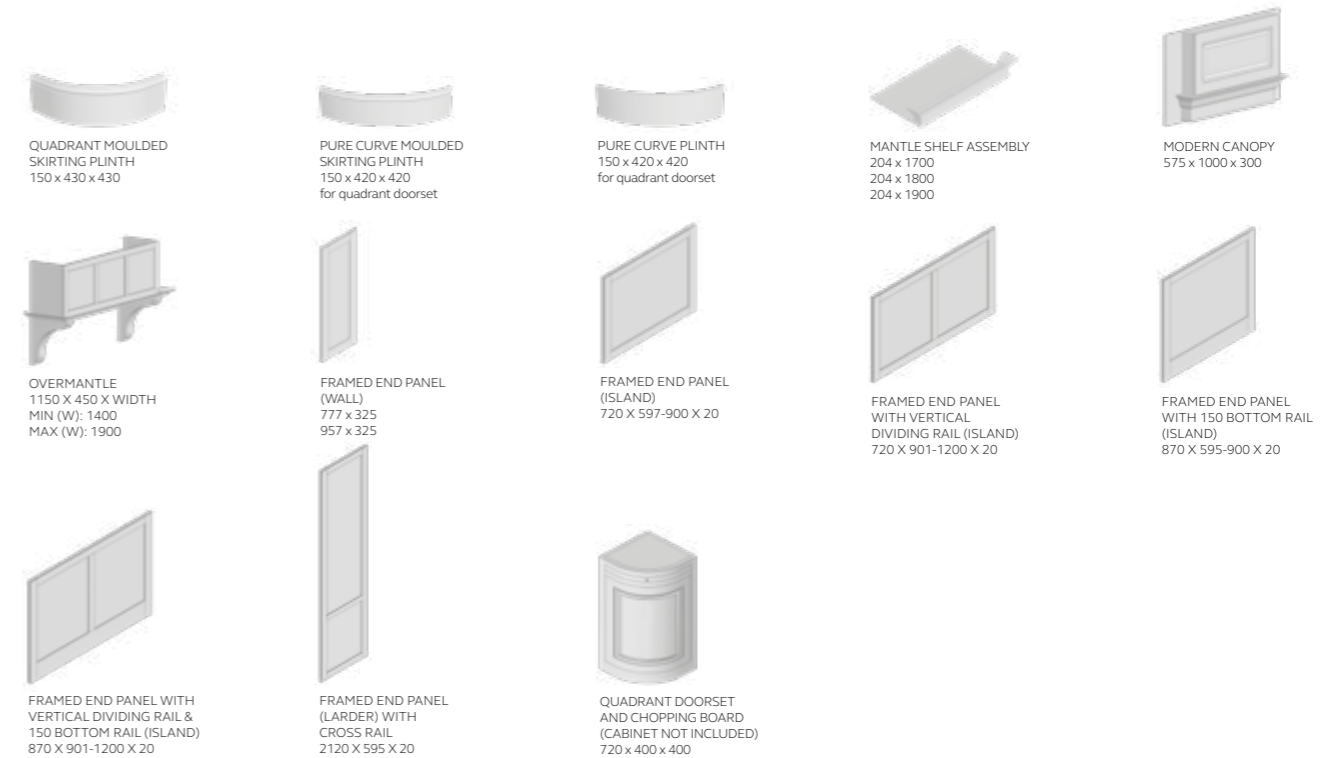

### SANDED

### STAINED

### PAINT TO ORDER STANDARD COLOURS

	WHITES/CREAMS	BEIGES	BLUES	GREENS	GREYS/BLACKS	PINKS/REDS
Sanded Ash	Brilliant White	Shell	Pantry Blue	Sage Green	Light Grey	Cashmere
Light Oak	Porcelain	Taupe Grey	Light Teal	Cardamom	Dust Grey	Vintage Pink
	Ivory	Mussel	Airforce	Reed Green	Monument Grey	Antique Red
		Stone	Parisian Blue	Willow	Gunmetal Grey	
		Stone Grey	Marine	Viridian	Graphite	
		Lava	Slate Blue	Heritage Green	Cannon Black	
		Indigo	Deep Forest			

CMS Colour Match Service

### DOOR SPECIFICATION

Description	Shaker - 5 piece solid frame with v-groove	
	Oak	Ash
Finish	Oak	Ash painted or sanded
Frame material	Oak	Ash
Centre panel material	Oak veneer	Ash veneer
Door thickness	20mm	
Frame width	93mm	
Edge colour	Oak	As face
Reverse colour	Oak	As face

### LEAD TIMES EXCLUDING DELIVERY (WORKING DAYS)

FINISH	MADE TO ORDER & SPECIAL SIZES	
	DOORS	PANELS
Sanded Ash	15	10
Stained Light Oak	20	15
Painted ex-stock colours	20	15
Paint to order standard colours	20	15
Colour match service	25	20

## MADE TO ORDER PLAIN PANELS



PLAIN END PANEL

### SIZE PARAMETERS:

Height (mm)		Width (mm)	
Min	Max	Min	Max
70	900	100	1200
901	1250	100	900
1251	2500	100	800



## STANDARD DRAWERFRONTS & DOORS

- 115 x 597 slab
- 140 x 297 slab
- 140 x 397 slab
- 140 x 447 slab
- 140 x 497 slab
- 140 x 597 slab
- 140 x 797 slab
- 140 x 897 slab
- 140 x 997 slab
- 175 x 397 slab
- 175 x 497 slab
- 175 x 597 slab
- 283 x 497
- 283 x 597
- 283 x 797
- 283 x 897
- 283 x 997
- 355 x 497
- 355 x 597
- 355 x 797
- 355 x 897
- 355 x 997
- 450 x 597
- 495 x 397
- 495 x 597
- 570 x 297
- 570 x 397
- 570 x 447
- 570 x 497
- 570 x 597
- 645 x 597
- 715 x 147 slab
- 715 x 297
- 715 x 271
- 715 x 271 pair
- 715 x 315
- 715 x 315 pair
- 715 x 347
- 715 x 397
- 715 x 397 plain frame
- 715 x 447
- 715 x 497
- 715 x 497 plain frame
- 715 x 547
- 715 x 597
- 825 x 597
- 895 x 297
- 895 x 347
- 895 x 397
- 895 x 447
- 895 x 497
- 895 x 597
- 980 x 597
- 1245 x 297
- 1245 x 397
- 1245 x 447
- 1245 x 497
- 1245 x 597
- 1425 x 597
- 1965 x 297 with cross rail (70/30 alignment)
- 1965 x 597 with cross rail (70/30 alignment)

## STANDARD DOORS



STANDARD DOOR



PLAIN FRAME  
includes clear glass



1965X597 DOOR  
with cross rail

## STANDARD ACCESSORIES



CORNICE  
51 X 3000 X 79



MODERN CORNICE  
74 X 3100 X 101



CORNICE / LIGHT PELMET  
55 X 3000 X 35

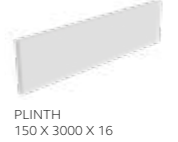

PLINTH  
150 X 3000 X 16



UNIVERSAL MOULDING  
35 X 3050 X 60

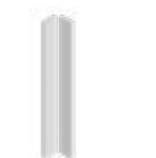

INTERNAL CORNER POST  
715 X 70 X 22

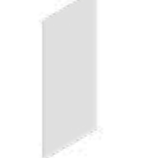

PLAIN END PANEL  
780 X 360 X 18\*  
900 X 650 X 18\*  
910 X 2430 X 18\*\*  
960 X 360 X 18\*  
2430 X 650 X 18\*

\* Grain runs up and down height of panels.  
\*\* Grain runs horizontally.

### EX-STOCK

Porcelain
Light Grey
Taupe Grey
Reed Green
Indigo

### MADE TO ORDER PLAIN PANELS

Porcelain
Light Grey
Taupe Grey
Reed Green
Indigo

### DOOR SPECIFICATION

Description	5 piece narrow shaker with internal bead
Finish	Oak effect foil *
Base material	MDF wrapped in Alkorcell
Door thickness	22mm MDF
Frame width	73mm frame (60mm + 13mm internal bead)
Edge colour	As face
Reverse colour	As face

\* Authentic painted Oak woodgrain effect with 3-4% sheen finish.

### LEAD TIMES EXCLUDING DELIVERY (WORKING DAYS)

FINISH	STANDARD PRODUCTS	MADE TO ORDER PANELS
Foil ex-stock colours	EX	10

### MADE TO ORDER PLAIN PANELS



PLAIN END PANEL

### SIZE PARAMETERS:

Height (mm)		Width (mm)	
Min	Max	Min	Max
70	900	100	1200
901	1250	100	900
1251	2500	100	800



## EX-STOCK

White
Porcelain
Light Grey
Cashmere
Dust Grey
Graphite

## DOOR SPECIFICATION

Description	Slab with integrated J-handle
Finish	High gloss polyurethane
Frame material	MDF
Door thickness	22mm
Edge colour	As face - gloss
Reverse colour	As face - melamine matte

## LEAD TIMES EXCLUDING DELIVERY (WORKING DAYS)

FINISH	STANDARD PRODUCT
Ex-stock colours	EX

## STANDARD DRAWERFRONTS & DOORS

- 115 x 597 slab
- 140 x 297
- 140 x 397
- 140 x 447
- 140 x 497
- 140 x 597
- 140 x 797
- 140 x 897
- 140 x 997
- 175 x 397
- 175 x 497
- 175 x 597
- 283 x 497
- 283 x 597
- 283 x 797
- 283 x 897
- 283 x 997
- 355 x 497
- 355 x 597
- 355 x 797
- 355 x 897
- 355 x 997
- 450 x 597
- 495 x 597
- 570 x 297
- 570 x 397
- 570 x 447
- 570 x 497
- 570 x 597
- 645 x 597
- 715 x 147
- 715 x 257
- 715 x 271 pair
- 715 x 297
- 715 x 311 pair
- 715 x 347
- 715 x 397
- 715 x 447
- 715 x 497
- 715 x 547
- 715 x 597
- 895 x 297
- 895 x 347
- 895 x 397
- 895 x 447
- 895 x 497
- 895 x 597
- 980 x 597
- 1245 x 297
- 1245 x 397
- 1245 x 447
- 1245 x 497
- 1245 x 597
- 1245 x 597 appliance door
- 1965 x 497 larder door with vertical handle
- 1965 x 597 larder door with vertical handle
- 715 x 320 quadrant door for wall and base units

## STANDARD DOORS

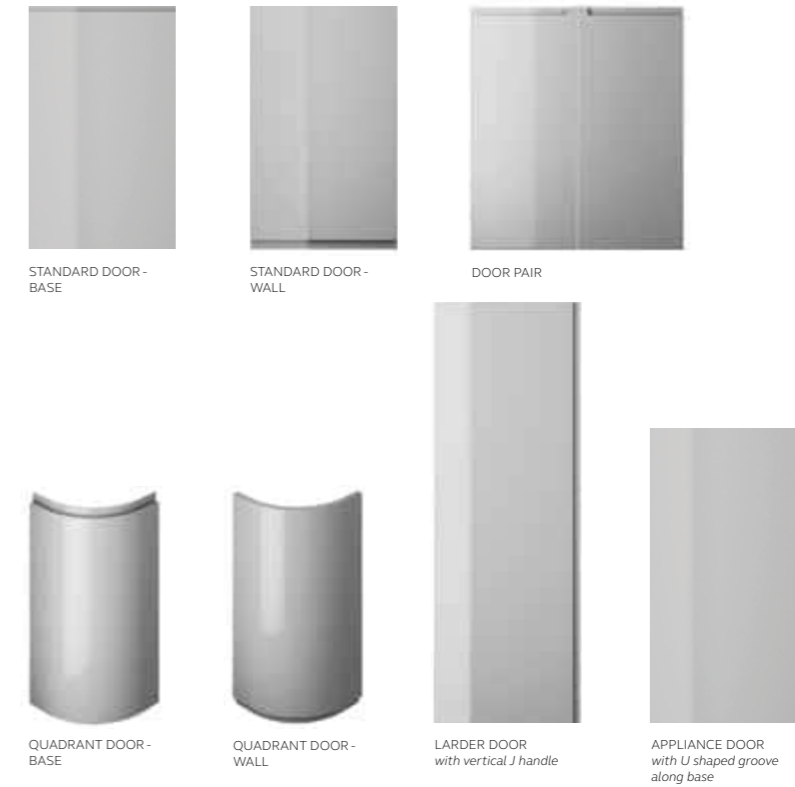

## STANDARD ACCESSORIES

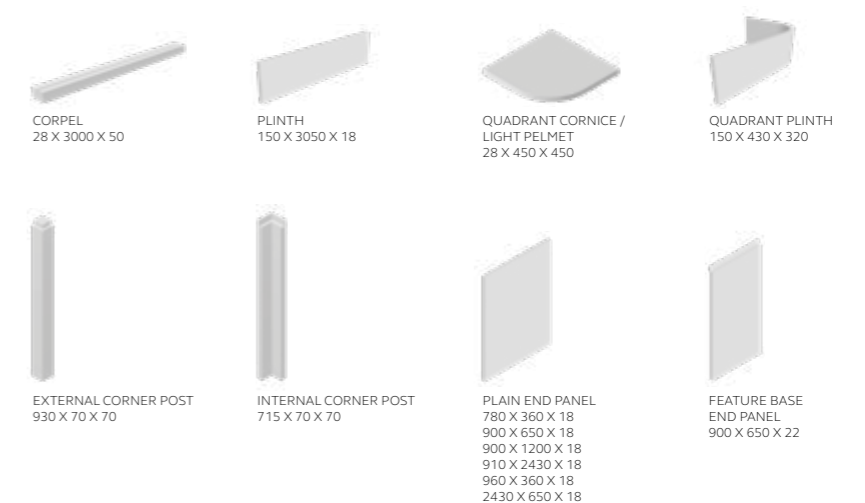



## STANDARD DRAWERFRONTS & DOORS

- 115 x 597 slab
- 140 x 297
- 140 x 397
- 140 x 447
- 140 x 497
- 140 x 597
- 140 x 797
- 140 x 897
- 140 x 997
- 175 x 397
- 175 x 497
- 175 x 597
- 283 x 497
- 283 x 597
- 283 x 797
- 283 x 897
- 283 x 997
- 355 x 497
- 355 x 597
- 355 x 797
- 355 x 897
- 355 x 997
- 450 x 597
- 495 x 597
- 570 x 297
- 570 x 397
- 570 x 447
- 570 x 497
- 570 x 597
- 645 x 597
- 715 x 147
- 715 x 257
- 715 x 271 pair
- 715 x 297
- 715 x 311 pair
- 715 x 347
- 715 x 397
- 715 x 447
- 715 x 497
- 715 x 547
- 715 x 597
- 895 x 297
- 895 x 347
- 895 x 397
- 895 x 447
- 895 x 497
- 895 x 597
- 980 x 597
- 1245 x 297
- 1245 x 397
- 1245 x 447
- 1245 x 497
- 1245 x 597
- 1245 x 597 appliance door
- 1965 x 497 larder door with vertical handle
- 1965 x 597 larder door with vertical handle
- 715 x 320 quadrant door for wall and base units

## STANDARD DOORS



## STANDARD ACCESSORIES

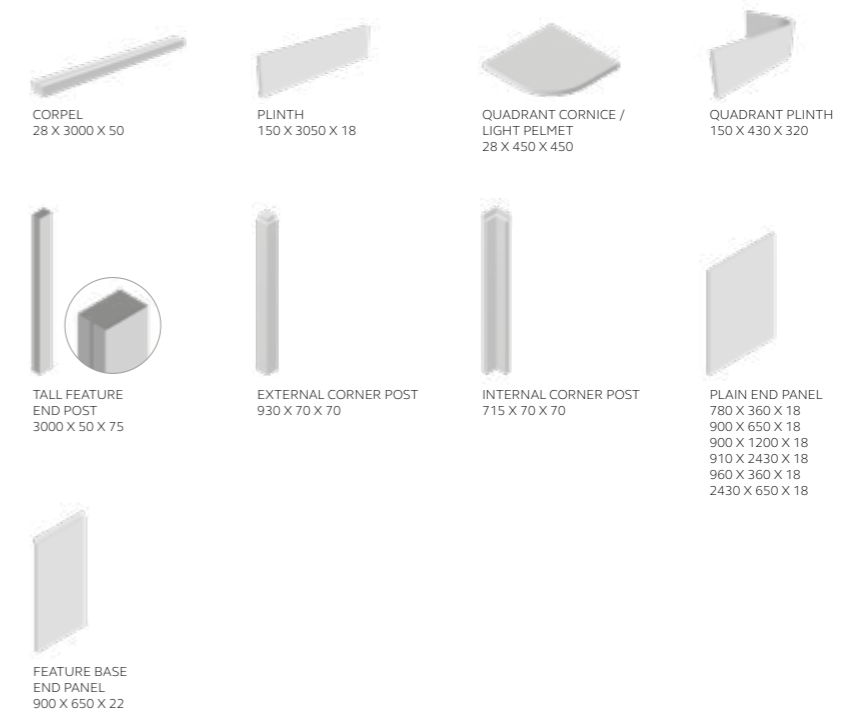

## EX-STOCK

## PAINT TO ORDER STANDARD COLOURS

	WHITES/CREAMS	BEIGES	BLUES	GREENS	GREYS/BLACKS	PINKS/PURPLES
Primed	Ivory	Shell	Pantry Blue	Sage Green	Monument Grey	Vintage Pink
White		Taupe Grey	Light Teal	Cardamom	Gunmetal Grey	Antique Red
Porcelain		Mussel	Airforce	Reed Green	Cannon Black	
Light Grey		Stone	Parisian Blue	Willow		
Cashmere		Stone Grey	Slate Blue	Viridian		
Dust Grey		Lava	Indigo	Heritage Green		
Marine				Deep Forest		
Graphite						



## DOOR SPECIFICATION

Description	Slab with integrated J-handle
Finish	Smooth matte finish
Frame material	MDF
Door thickness	22mm
Edge colour	As face
Reverse colour <span>EX</span>	As face - melamine matte*
Reverse colour <span>PTO</span>	As face - painted

\*Please note: our primed product comes with a White reverse.

## LEAD TIMES EXCLUDING DELIVERY (WORKING DAYS)

FINISH	STANDARD PRODUCT
Primed	<span>EX</span>
Painted ex-stock colours	<span>EX</span>
Paint to order standard colours	<span>10</span>
Colour match service	<span>20</span>



## EX-STOCK

Sanded Ash
Light Oak
Porcelain
Ivory
Mussel
Light Grey
Taupe Grey
Sage Green
Stone
Dust Grey
Reed Green
Marine

## PAINT TO ORDER STANDARD COLOURS

WHITES/CREAMS	BEIGES	BLUES	GREENS	GREYS/BLACKS	PINKS/PURPLES
Brilliant White	Shell	Pantry Blue	Cardamom	Monument Grey	Cashmere
	Stone Grey	Light Teal	Willow	Gunmetal Grey	Vintage Pink
	Lava	Airforce	Viridian	Graphite	Antique Red
		Parisian Blue	Heritage Green	Cannon Black	
		Slate Blue	Deep Forest		
		Indigo			

CMS Colour Match Service

## DOOR SPECIFICATION

Description	Shaker - 5 piece solid frame with internal bead	
	Oak	Ash
Finish	Oak	Ash painted or sanded
Frame material	Oak	Ash
Centre panel material	Oak veneer	Ash veneer
Door thickness	20mm	
Frame width	93mm (84mm + 9mm) bead detail	
Edge colour	Oak	As face
Reverse colour	Oak	As face

## LEAD TIMES EXCLUDING DELIVERY (WORKING DAYS)

FINISH	STANDARD PRODUCT
Sanded Ash	EX
Stained Light Oak	EX
Painted ex-stock colours	EX
Paint to order standard colours	10
Colour match service	20

## STANDARD DRAWERFRONTS & DOORS

- 115 x 597 slab
- 140 x 297 slab
- 140 x 397 slab
- 140 x 447 slab
- 140 x 497 slab
- 140 x 597 slab
- 140 x 797 slab
- 140 x 897 slab
- 140 x 997 slab
- 175 x 397 slab
- 175 x 497 slab
- 175 x 597 slab
- 283 x 497
- 283 x 597
- 283 x 797
- 283 x 897
- 283 x 997
- 355 x 497
- 355 x 497 plain frame
- 355 x 597
- 355 x 797
- 355 x 897
- 355 x 997
- 450 x 597
- 495 x 397
- 495 x 597
- 570 x 297
- 570 x 397
- 570 x 447
- 570 x 497
- 570 x 597
- 645 x 597
- 715 x 147 slab
- 715 x 257
- 715 x 297
- 715 x 273
- 715 x 273 pair
- 715 x 315
- 715 x 315 pair
- 715 x 320 quadrant door
- 715 x 347
- 715 x 397
- 715 x 397 georgian frame (6 panes)
- 715 x 397 plain frame
- 715 x 447
- 715 x 497
- 715 x 497 plain frame
- 715 x 497 georgian frame (6 panes)
- 715 x 547
- 715 x 597
- 825 x 597
- 895 x 297
- 895 x 347
- 895 x 397
- 895 x 447
- 895 x 497
- 895 x 497 georgian frame (8 panes)
- 895 x 597
- 980 x 597
- 1060 x 497 georgian frame (10 panes)
- 1245 x 297
- 1245 x 397
- 1245 x 447
- 1245 x 497
- 1245 x 597
- 1425 x 597
- 1965 x 597 with 2 cross rails

## STANDARD DOORS



## STANDARD ACCESSORIES

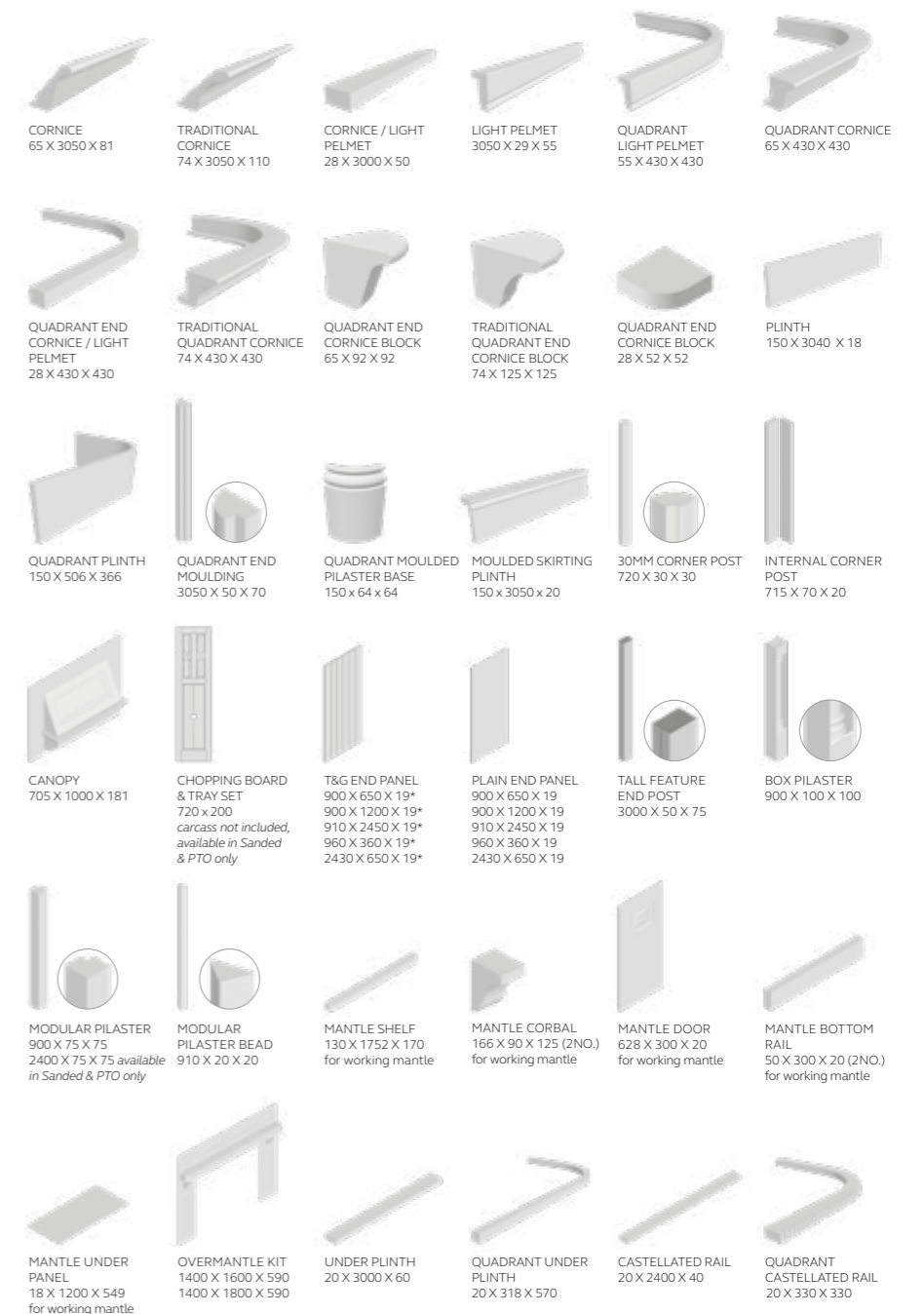

\* The T&G grooving and the timber grain run up and down the panel height.



## MADE TO ORDER DOORS

PLEASE REFER TO THE CURRENT PRICE LIST FOR (h) & (w) LIMITATIONS.



STANDARD DOOR



PLAIN FRAME  
glass not supplied



GEORGIAN FRAME  
glass not supplied  
(number of panes depends on height)



CROSS RAIL DOOR



QUADRANT DOOR



SLAB DRAWERFRONT



SINGLE GLAZED DOOR  
glass not supplied

Doors over 1464 require cross rails. Please specify 1, 2 or 3 rails when ordering. Frames exclude glass.

## MADE TO ORDER ACCESSORIES



QUADRANT MOULDED SKIRTING PLINTH  
150 x 430 x 430



PURE CURVE MOULDED SKIRTING PLINTH  
150 x 420 x 420 for quadrant doorset



PURE CURVE PLINTH  
150 x 420 x 420 for quadrant doorset



MANTLE SHELF ASSEMBLY  
204 x 1700  
204 x 1800  
204 x 1900



MODERN CANOPY  
575 x 1000 x 300



OVERMANTLE  
1150 X 450 X WIDTH  
MIN (W): 1400  
MAX (W): 1900



FRAMED END PANEL (WALL)  
777 x 325  
957 x 325



FRAMED END PANEL (ISLAND)  
720 X 597-900 X 20



FRAMED END PANEL WITH VERTICAL DIVIDING RAIL (ISLAND)  
720 X 901-1200 X 20



FRAMED END PANEL WITH 150 BOTTOM RAIL (ISLAND)  
870 X 595-900 X 20



FRAMED END PANEL WITH VERTICAL DIVIDING RAIL & 150 BOTTOM RAIL (ISLAND)  
870 X 901-1200 X 20

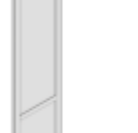

FRAMED END PANEL (LARDER) WITH CROSS RAIL  
2120 X 595 X 20



QUADRANT DOORSET AND CHOPPING BOARD (CABINET NOT INCLUDED)  
720 X 400 X 400

## SANDED

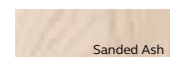

## OAK



## PAINT TO ORDER STANDARD COLOURS

WHITES/CREAMS	BEIGES	BLUES	GREENS	GREYS/BLACKS	PINKS/REDS
Brilliant White	Shell	Pantry Blue	Sage Green	Light Grey	Cashmere
Porcelain	Taupe Grey	Light Teal	Cardamom	Dust Grey	Vintage Pink
Ivory	Mussel	Airforce	Reed Green	Monument Grey	Antique Red
	Stone	Parisian Blue	Willow	Gunmetal Grey	
	Stone Grey	Marine	Viridian	Graphite	
	Lava	Slate Blue	Heritage Green	Cannon Black	
		Indigo	Deep Forest		



## DOOR SPECIFICATION

Description	Shaker - 5 piece solid frame with internal bead	
	Oak	Ash
Finish	Oak	Ash painted or sanded
Frame material	Oak	Ash
Centre panel material	Oak veneer	Ash veneer
Door thickness	20mm	
Frame width	93mm (84mm + 9mm bead detail)	
Edge colour	Oak	As face
Reverse colour	Oak	As face

## LEAD TIMES EXCLUDING DELIVERY (WORKING DAYS)

FINISH	MADE TO ORDER & SPECIAL SIZES	
	DOORS	PANELS
Sanded Ash	15	10
Stained Light Oak	20	15
Painted ex-stock colours	20	15
Paint to order standard colours	20	15
Colour match service	25	20

## MADE TO ORDER PLAIN PANELS



PLAIN END PANEL

## SIZE PARAMETERS:

Height (mm)		Width (mm)	
Min	Max	Min	Max
70	900	100	1200
901	1250	100	900
1251	2500	100	800



## STANDARD DRAWERFRONTS & DOORS

- 1 115 x 597 slab
- 1 140 x 297 slab
- 1 140 x 397 slab
- 1 140 x 447 slab
- 1 140 x 497 slab
- 1 140 x 597 slab
- 1 140 x 797 slab
- 1 140 x 897 slab
- 1 140 x 997 slab
- 1 175 x 397 slab
- 1 175 x 497 slab
- 1 175 x 597 slab
- 2 283 x 497
- 2 283 x 597
- 2 283 x 797
- 2 283 x 897
- 2 283 x 997
- 2 355 x 497
- 2 355 x 597
- 2 355 x 797
- 2 355 x 897
- 2 355 x 997
- 3 355 x 497 plain frame
- 4 450 x 597
- 4 495 x 397
- 4 495 x 597
- 4 570 x 297
- 4 570 x 397
- 4 570 x 447
- 4 570 x 497
- 4 570 x 597
- 4 645 x 597
- 5 715 x 147 slab
- 6 715 x 273
- 6 715 x 273 pair
- 6 715 x 297
- 6 715 x 315
- 6 715 x 315 pair
- 6 715 x 347
- 6 715 x 397
- 6 715 x 447
- 6 715 x 497
- 6 715 x 547
- 6 715 x 597
- 7 715 x 397 plain frame
- 7 715 x 497 plain frame
- 8 715 x 397 georgian frame
- 8 715 x 497 georgian frame
- 8 895 x 497 georgian frame
- 8 1060 x 497 georgian frame
- 9 825 x 597
- 9 895 x 297
- 9 895 x 347
- 9 895 x 397
- 9 895 x 447
- 9 895 x 497
- 9 895 x 597
- 10 980 x 597
- 10 1245 x 297
- 10 1245 x 397
- 10 1245 x 447
- 10 1245 x 497
- 10 1245 x 597
- 10 1425 x 297
- 11 1965 x 597 with 2 cross rails

## STANDARD DRAWERFRONTS & DOORS



STANDARD DOOR



PLAIN FRAME  
includes clear glass



GEORGIAN FRAME  
includes clear glass  
(number of panes depends on height)

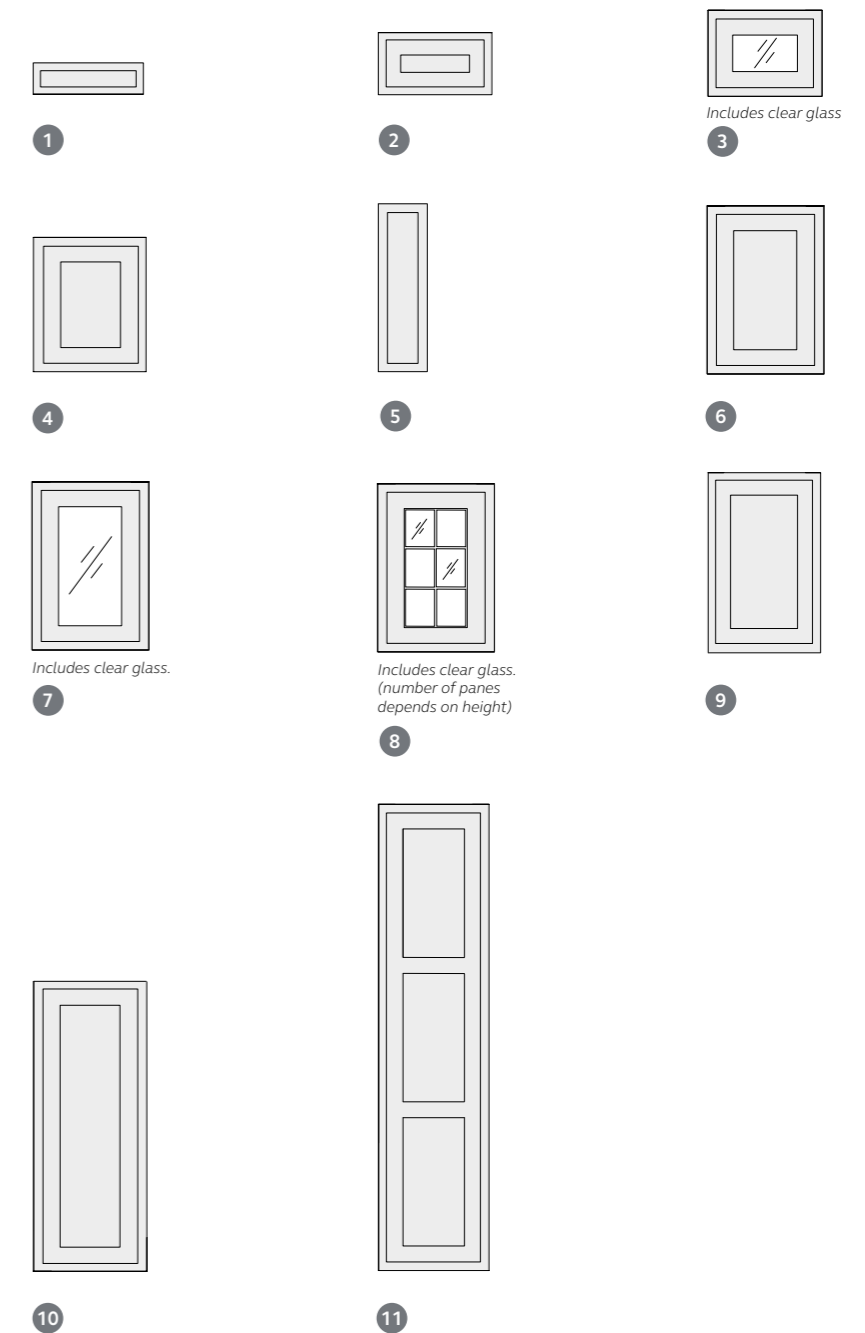

## SANDED

## PAINT TO ORDER STANDARD COLOURS

	WHITES/CREAMS	BEIGES	BLUES	GREENS	GREYS/BLACKS	PINKS/PURPLES
Sanded Ash	Brilliant White	Shell	Pantry Blue	Sage Green	Light Grey	Cashmere
	Porcelain	Taupe Grey	Light Teal	Cardamom	Dust Grey	Vintage Pink
	Ivory	Mussel	Airforce	Reed Green	Monument Grey	Antique Red
		Stone	Parisian Blue	Willow	Gunmetal Grey	
		Stone Grey	Marine	Viridian	Graphite	
		Lava	Slate Blue	Heritage Green	Cannon Black	
		Indigo	Deep Forest			



## DOOR SPECIFICATION

Description	Inframe effect shaker - 5 piece solid frame with internal bead
Finish	Ash painted any standard colour
Frame material	Ash
Centre panel material	Ash veneer
Door thickness	20mm
Frame width	93mm; includes 28mm routed frame & 5mm routerline
Edge colour	As face
Reverse colour	As face

## LEAD TIMES EXCLUDING DELIVERY (WORKING DAYS)

FINISH	STANDARD PRODUCT
Sanded Ash	7
Paint to order standard colours	10
Colour Match Service	20

# WINSLOW KITCHEN

## STANDARD ACCESSORIES



CORNICE  
65 X 3050 X 81



TRADITIONAL CORNICE  
74 X 3050 X 110



CORNICE / LIGHT PELMET  
28 X 3000 X 50



LIGHT PELMET  
55 X 3050 X 29



QUADRANT END CORNICE BLOCK  
65 X 92 X 92



TRADITIONAL QUADRANT END CORNICE BLOCK  
74 X 125 X 125



QUADRANT END CORNICE BLOCK  
28 X 52 X 52



PLINTH  
150 X 3040 X 18



QUADRANT END MOULDING  
3050 X 50 X 70



QUADRANT MOULDED PILASTER BASE  
150 X 64 X 64



MOULDED SKIRTING PLINTH  
150 X 3050 X 20



30MM CORNER POST  
720 X 30 X 30



INTERNAL CORNER POST  
715 X 70 X 20



CANOPY  
705 X 1000 X 181  
(no router frame)



CHOPPING BOARD & TRAY SET  
carcass not included  
720 X 200



T&G END PANEL  
900 X 650 X 19\*  
900 X 1200 X 19\*  
910 X 2450 X 19\*  
960 X 360 X 19\*  
2430 X 650 X 19\*



PLAIN END PANEL  
900 X 650 X 19  
900 X 1200 X 19  
910 X 2450 X 19  
960 X 360 X 19  
2430 X 650 X 19

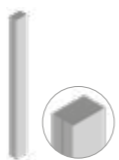

TALL FEATURE END POST  
3000 X 50 X 75

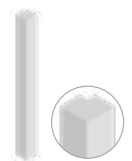

MODULAR PILASTER  
900 X 75 X 75  
2400 X 75 X 75

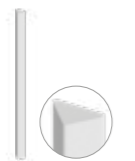

MODULAR PILASTER BEAD  
910 X 20 X 20



MANTLE SHELF  
130 X 1752 X 170  
for working mantle



MANTLE CORBAL  
166 X 90 X 125 (2NO.)  
for working mantle



MANTLE DOOR  
628 X 300 X 20  
for working mantle  
(includes router frame)



MANTLE BOTTOM RAILS  
50 X 300 X 20 (2NO.)  
for working mantle



MANTLE UNDER PANEL  
18 X 1200 X 549  
for working mantle



OVERMANTLE KIT  
1400 X 1600 X 590  
1400 X 1800 X 590



UNDER PLINTH  
20 X 3000 X 60



CASTELLATED RAIL  
20 X 2400 X 40





## MADE TO ORDER DRAWERFRONTS & DOORS

PLEASE REFER TO THE CURRENT PRICE LIST FOR (h) & (w) LIMITATIONS.



STANDARD DOOR

PLAIN FRAME  
glass not supplied

GEORGIAN FRAME  
glass not supplied  
(number of panes depends on height)

CROSS RAIL DOOR

SLAB DRAWERFRONT



SINGLE GLAZED DOOR  
glass not supplied

Doors over 1464 require cross rails. Please specify 1, 2 or 3 rails when ordering. Frames exclude glass.

## MADE TO ORDER ACCESSORIES

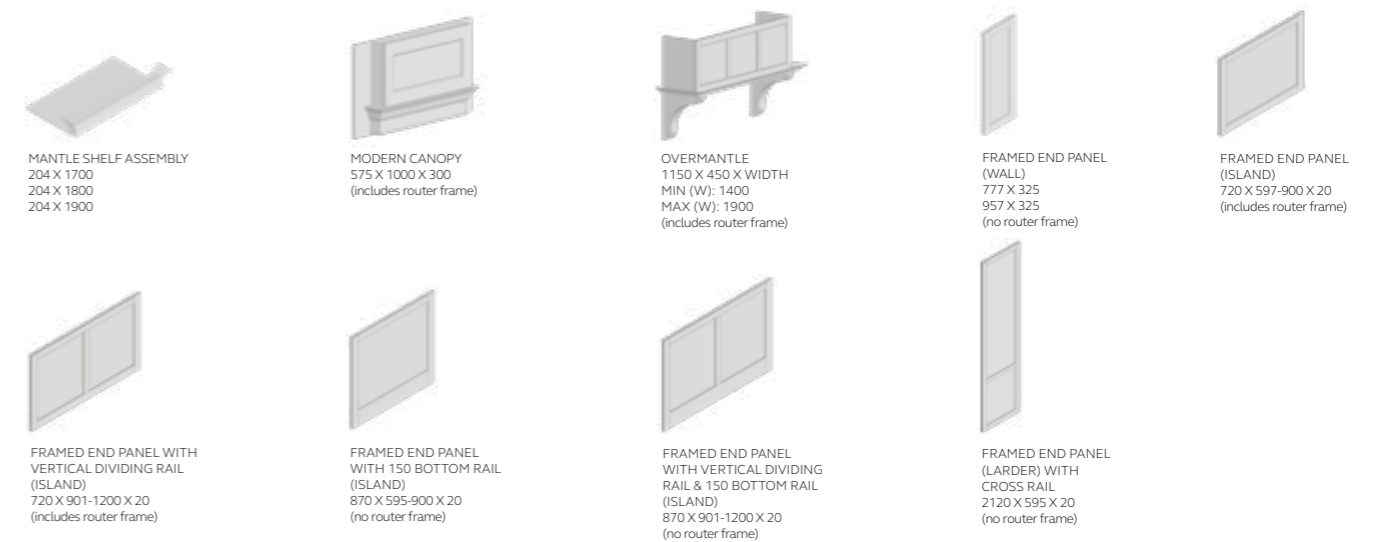

MANTLE SHELF ASSEMBLY  
204 X 1700  
204 X 1800  
204 X 1900

MODERN CANOPY  
575 X 1000 X 300  
(includes router frame)

OVERMANTLE  
1150 X 450 X WIDTH  
MIN (W): 1400  
MAX (W): 1900  
(includes router frame)

FRAMED END PANEL (WALL)  
777 X 325  
957 X 325  
(no router frame)

FRAMED END PANEL (ISLAND)  
720 X 597-900 X 20  
(includes router frame)

FRAMED END PANEL WITH VERTICAL DIVIDING RAIL (ISLAND)  
720 X 901-1200 X 20  
(includes router frame)

FRAMED END PANEL WITH 150 BOTTOM RAIL (ISLAND)  
870 X 595-900 X 20  
(no router frame)

FRAMED END PANEL WITH VERTICAL DIVIDING RAIL & 150 BOTTOM RAIL (ISLAND)  
870 X 901-1200 X 20  
(no router frame)

FRAMED END PANEL (LARDER) WITH CROSS RAIL  
2120 X 595 X 20  
(no router frame)

## SANDED

## PAINT TO ORDER STANDARD COLOURS

	WHITES/CREAMS	BEIGES	BLUES	GREENS	GREYS/BLACKS	PINKS/PURPLES
Sanded Ash	Brilliant White	Shell	Pantry Blue	Sage Green	Light Grey	Cashmere
	Porcelain	Taupe Grey	Light Teal	Cardamom	Dust Grey	Vintage Pink
	Ivory	Mussel	Airforce	Reed Green	Monument Grey	Antique Red
		Stone	Parisian Blue	Willow	Gunmetal Grey	
		Stone Grey	Marine	Viridian	Graphite	
		Lava	Slate Blue	Heritage Green	Cannon Black	
		Indigo	Deep Forest			



## DOOR SPECIFICATION

Description	Inframe effect shaker - 5 piece solid frame with internal bead
Finish	Ash painted any standard colour
Frame material	Ash
Centre panel material	Ash veneer
Door thickness	20mm
Frame width	93mm; includes 28mm routered frame & 5mm routerline
Edge colour	As face
Reverse colour	As face

## LEAD TIMES EXCLUDING DELIVERY (WORKING DAYS)

FINISH	MADE TO ORDER & SPECIAL SIZES	
	DOORS	PANELS
Sanded Ash	15	10
Paint to order standard colours	20	15
Colour Match Service	25	20

## MADE TO ORDER PLAIN PANELS



PLAIN END PANEL

## SIZE PARAMETERS:

Height (mm)		Width (mm)	
Min	Max	Min	Max
70	900	100	1200
901	1250	100	900
1251	2500	100	800



## EX-STOCK



## DOOR SPECIFICATION

Description	Slab
Finish	High gloss polyurethane
Base material	MDF
Door thickness	18mm
Edge colour	As face - gloss
Reverse colour	As face - melamine matte

## LEAD TIMES EXCLUDING DELIVERY (WORKING DAYS)

FINISH	STANDARD PRODUCT
Painted ex-stock colours	EX

## STANDARD DRAWERFRONTS & DOORS

- 115 x 597
- 140 x 297
- 140 x 397
- 140 x 447
- 140 x 497
- 140 x 597
- 140 x 797
- 140 x 897
- 140 x 997
- 140 x 1197
- 175 x 397
- 175 x 497
- 175 x 597
- 283 x 497
- 283 x 597
- 283 x 797
- 283 x 897
- 283 x 997
- 283 x 1197
- 355 x 497
- 355 x 597
- 355 x 797
- 355 x 897
- 355 x 997
- 355 x 1197
- 450 x 597
- 495 x 597
- 570 x 297
- 570 x 397 sample door
- 570 x 447
- 570 x 497
- 570 x 597
- 645 x 597
- 715 x 147
- 715 x 257
- 715 x 267
- 715 x 275
- 715 x 275 pair
- 715 x 297
- 715 x 315
- 715 x 315 pair
- 715 x 320 quadrant door
- 715 x 347
- 715 x 397
- 715 x 447
- 715 x 497
- 715 x 497 plain frame
- 715 x 547
- 715 x 597
- 895 x 297
- 895 x 347
- 895 x 397
- 895 x 447
- 895 x 497
- 895 x 497 plain frame
- 895 x 597
- 980 x 597
- 1245 x 297
- 1245 x 397
- 1245 x 447
- 1245 x 497
- 1245 x 597
- 1965 x 497
- 1965 x 597

## STANDARD DOORS



STANDARD DOOR



PLAIN FRAME  
includes frosted glass



QUADRANT DOOR

## STANDARD ACCESSORIES



CORNICE / LIGHT PELMET  
28 X 3000 X 50



PLINTH  
150 X 3050 X 18



QUADRANT CORNICE  
28 X 450 X 450



QUADRANT PLINTH  
150 X 430 X 320

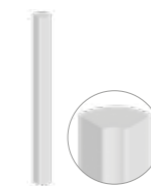

30MM CORNER POST  
715 X 30 X 30

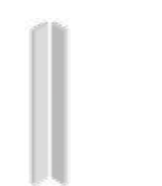

INTERNAL CORNER POST  
715 X 70 X 18



PLAIN END PANEL  
780 X 360 X 18  
900 X 650 X 18  
900 X 1200 X 18  
910 X 2430 X 18  
960 X 360 X 18  
2430 X 650 X 18

# ZOLA GLOSS HANDLELESS KITCHEN

EX  
EX-STOCK

ORDER ONLINE  
ONLINE.UFORM.CO.UK

DOORS &  
ACCESSORIES



## EX-STOCK

White
Porcelain
Light Grey
Cashmere
Dust Grey
Graphite

## DOOR SPECIFICATION

Description	Slab
Finish	High gloss polyurethane
Base material	MDF
Door thickness	18mm
Edge colour	As face - gloss
Reverse colour	As face - melamine matte

## LEAD TIMES EXCLUDING DELIVERY (WORKING DAYS)

FINISH	STANDARD PRODUCT
Painted ex-stock colours	EX

## HANDLELESS DOORS & ACCESSORIES

160 x 497
160 x 597
160 x 797
160 x 897
160 x 997
160 x 1197
325 x 497
325 x 597
325 x 797
325 x 897
325 x 997
325 x 1197
490 x 597
685 x 147
685 x 297
685 x 315
685 x 315 pair
685 x 347
685 x 397
685 x 447
685 x 497
685 x 597

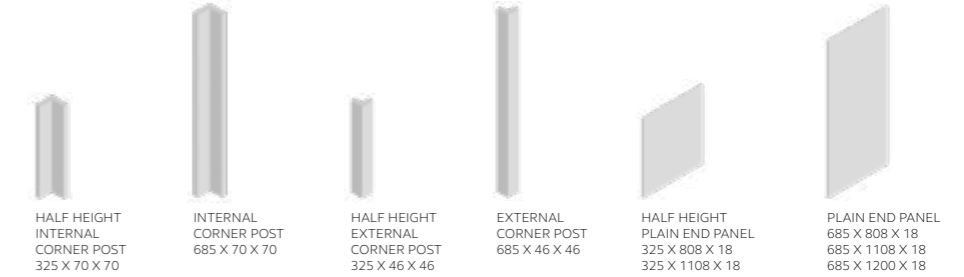

## HANDLELESS KITS

### HALF HEIGHT L-SHAPE PANEL & POST KIT FOR BASE UNIT



### FULL HEIGHT L-SHAPE PANEL & POST KIT FOR BASE UNIT



### HALF HEIGHT C-SHAPE PANEL & POST KIT FOR 900 & 1200 WIDE ISLANDS



### FULL HEIGHT C-SHAPE PANEL & POST KIT FOR 900 & 1200 WIDE ISLANDS



### HALF HEIGHT L SHAPE PANEL & POST KIT FOR BASE UNIT\*

CODE	KIT INCLUDES
prefix-325600LPANPKT	1 x half height external corner post 1 x plain end panel 325 x 808 2 x mdf fixing batons

### FULL HEIGHT L SHAPE PANEL & POST KIT FOR BASE UNIT

CODE	KIT INCLUDES
prefix-685600LPANPKT	1 x external corner post 1 x plain end panel 685 x 808 2 x mdf fixing batons

### HALF HEIGHT C SHAPE PANEL & POST KIT FOR 900 WIDE ISLAND\*

CODE	KIT INCLUDES
prefix-325900CPANPKT	2 x half height external corner posts 1 x plain end panel 325 x 808 2 x mdf fixing batons

### FULL HEIGHT C SHAPE PANEL & POST KIT FOR 900 WIDE ISLAND

CODE	KIT INCLUDES
prefix-685900CPANPKT	2 x external corner posts 1 x plain end panel 685 x 808 2 x mdf fixing batons

### HALF HEIGHT C SHAPE PANEL & POST KIT FOR 1200 WIDE ISLAND\*

CODE	KIT INCLUDES
prefix-3251200CPANPKT	2 x half height external corner posts 1 x plain end panel 325 x 1108 3 x mdf fixing batons

### FULL HEIGHT C SHAPE PANEL & POST KIT FOR 1200 WIDE ISLAND

CODE	KIT INCLUDES
prefix-6851200CPANPKT	2 x half height external corner posts 1 x plain end panel 685 x 1108 3 x mdf fixing batons

Please refer to pages 286-291 for fitting details.

\* Please note: 2 panel kits are required for each half-height base run / island end solution.



## STANDARD DRAWERFRONTS & DOORS

- 115 x 597
- 140 x 297
- 140 x 397
- 140 x 447
- 140 x 497
- 140 x 597
- 140 x 797
- 140 x 897
- 140 x 997
- 140 x 1197
- 175 x 397
- 175 x 497
- 175 x 597
- 283 x 497
- 283 x 597
- 283 x 797
- 283 x 897
- 283 x 997
- 283 x 1197
- 355 x 497
- 355 x 597
- 355 x 797
- 355 x 897
- 355 x 997
- 355 x 1197
- 450 x 597
- 495 x 597
- 570 x 297
- 570 x 397 sample door
- 570 x 447
- 570 x 497
- 570 x 597
- 645 x 597
- 715 x 147
- 715 x 257
- 715 x 267
- 715 x 275
- 715 x 275 pair
- 715 x 297
- 715 x 315
- 715 x 315 pair
- 715 x 320 quadrant door
- 715 x 347
- 715 x 397
- 715 x 447
- 715 x 497
- 715 x 497 plain frame
- 715 x 547
- 715 x 597
- 895 x 297
- 895 x 347
- 895 x 397
- 895 x 447
- 895 x 497
- 895 x 497 plain frame
- 895 x 597
- 980 x 597
- 1245 x 297
- 1245 x 397
- 1245 x 447
- 1245 x 497
- 1245 x 597
- 1965 x 497
- 1965 x 597

## STANDARD DOORS



STANDARD DOOR



PLAIN FRAME  
includes frosted glass



QUADRANT DOOR

## STANDARD ACCESSORIES

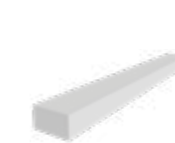

CORNICE / LIGHT PELMET  
28 X 3000 X 50



PLINTH  
150 X 3050 X 18



QUADRANT CORNICE  
28 X 450 X 450



QUADRANT PLINTH  
150 X 430 X 320



30MM CORNER POST  
715 X 30 X 30

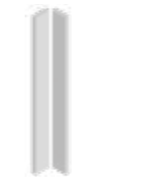

INTERNAL CORNER POSTS  
715 X 70 X 18

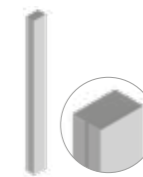

TALL FEATURE  
END POST  
3000 X 50 X 75

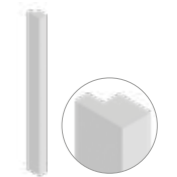

UNIVERSAL MOULDING  
35 X 3050 X 60



QUADRANT UNIVERSAL  
MOULDING  
35 X 321 X 321

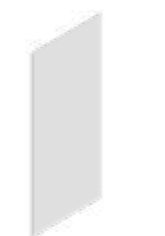

PLAIN END PANEL  
780 X 360 X 18  
900 X 650 X 18  
900 X 1200 X 18  
910 X 2430 X 18  
960 X 360 X 18  
2430 X 650 X 18

## EX-STOCK

## PAINT TO ORDER STANDARD COLOURS

	WHITES/CREAMS	BEIGES	BLUES	GREENS	GREYS/BLACKS	PINKS/REDS
Primed	Brilliant White	Shell	Pantry Blue	Sage Green	Light Grey	Cashmere
	Porcelain	Taupe Grey	Light Teal	Cardamom	Dust Grey	Vintage Pink
	Ivory	Mussel	Airforce	Reed Green	Monument Grey	Antique Red
		Stone	Parisian Blue	Willow	Gunmetal Grey	
		Stone Grey	Marine	Viridian	Graphite	
		Lava	Slate Blue	Heritage Green	Cannon Black	
			Indigo	Deep Forest		



## DOOR SPECIFICATION

Description	Slab
Finish	Smooth matte painted
Base material	MDF
Door thickness	18mm
Edge colour	As face
Reverse colour	As face*

\*Please note: our primed product comes with a White reverse.

## LEAD TIMES EXCLUDING DELIVERY (WORKING DAYS)

FINISH	STANDARD PRODUCT
Primed	EX
Paint to order standard colours	10
Colour match service	20

# ZOLA MATTE HANDLELESS KITCHEN

EX EX-STOCK | PTO PAINT TO ORDER | CMS COLOUR MATCH

ORDER ONLINE  
ONLINE.UFORM.CO.UK

DOORS & ACCESSORIES



## HANDLELESS DOORS & ACCESSORIES

160 x 497
160 x 597
160 x 797
160 x 897
160 x 997
160 x 1197
325 x 497
325 x 597
325 x 797
325 x 897
325 x 997
325 x 1197
490 x 597
685 x 147
685 x 297
685 x 315
685 x 315 pair
685 x 347
685 x 397
685 x 447
685 x 497
685 x 597



## EX-STOCK

## PAINT TO ORDER STANDARD COLOURS

EX-STOCK	WHITES/CREAMS	BEIGES	BLUES	GREENS	GREYS/BLACKS	PINKS/REDS
Primed	Brilliant White	Shell	Pantry Blue	Sage Green	Light Grey	Cashmere
	Porcelain	Taupe Grey	Light Teal	Cardamom	Dust Grey	Vintage Pink
	Ivory	Mussel	Airforce	Reed Green	Monument Grey	Antique Red
		Stone	Parisian Blue	Willow	Gunmetal Grey	
		Stone Grey	Marine	Viridian	Graphite	
		Lava	Slate Blue	Heritage Green	Cannon Black	
			Indigo	Deep Forest		

CMS Colour Match Service

## DOOR SPECIFICATION

Description	Slab
Finish	Smooth matte painted
Base material	MDF
Door thickness	18mm
Edge colour	As face
Reverse colour	As face*

\*Please note: our primed product comes with a White reverse.

## LEAD TIMES EXCLUDING DELIVERY (WORKING DAYS)

FINISH	STANDARD PRODUCT
Primed	EX
Paint to order standard colours	10
Colour match service	20

## HANDLELESS KITS

### HALF HEIGHT L-SHAPE PANEL & POST KIT FOR BASE UNIT



### HALF HEIGHT L SHAPE PANEL & POST KIT FOR BASE UNIT\*

CODE	KIT INCLUDES
prefix-325600LPANPTKT	1 x half height external corner post 1 x plain end panel 325 x 808 2 x mdf fixing batons

### FULL HEIGHT L-SHAPE PANEL & POST KIT FOR BASE UNIT

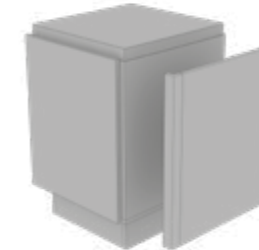

### FULL HEIGHT L SHAPE PANEL & POST KIT FOR BASE UNIT

CODE	KIT INCLUDES
prefix-685600LPANPTKT	1 x external corner post 1 x plain end panel 685 x 808 2 x mdf fixing batons

### HALF HEIGHT C-SHAPE PANEL & POST KIT FOR 900 & 1200 WIDE ISLANDS



### HALF HEIGHT C SHAPE PANEL & POST KIT FOR 900 WIDE ISLAND\*

CODE	KIT INCLUDES
prefix-325900CPANPTKT	2 x half height external corner posts 1 x plain end panel 325 x 808 2 x mdf fixing batons

### FULL HEIGHT C-SHAPE PANEL & POST KIT FOR 900 & 1200 WIDE ISLANDS



### FULL HEIGHT C SHAPE PANEL & POST KIT FOR 900 WIDE ISLAND

CODE	KIT INCLUDES
prefix-685900CPANPTKT	2 x external corner posts 1 x plain end panel 685 x 808 2 x mdf fixing batons

### HALF HEIGHT C SHAPE PANEL & POST KIT FOR 1200 WIDE ISLAND\*

CODE	KIT INCLUDES
prefix-3251200CPANPTKT	2 x half height external corner posts 1 x plain end panel 325 x 1108 3 x mdf fixing batons

### FULL HEIGHT C SHAPE PANEL & POST KIT FOR 1200 WIDE ISLAND

CODE	KIT INCLUDES
prefix-6851200CPANPTKT	2 x half height external corner posts 1 x plain end panel 685 x 1108 3 x mdf fixing batons

Please refer to pages 286-291 for fitting details.

\* Please note: 2 panel kits are required for each half-height base run / island end solution.



## EX-STOCK MADE TO ORDER

White	White
Porcelain	Porcelain
Light Grey	Light Grey
Cashmere	Cashmere
Dust Grey	Dust Grey
Indigo	Indigo
Graphite	Graphite

## DOOR SPECIFICATION

Description	Slab
Finish	Soft touch matte PET foil and lacquered
Frame material	MDF
Door thickness	18mm
Edge colour	As face - ABS
Reverse colour	As face - melamine matte

## LEAD TIMES EXCLUDING DELIVERY (WORKING DAYS)

FINISH	STANDARD PRODUCTS	MADE TO ORDER DOORS & PANELS
PET Foil	EX	10

## STANDARD DRAWERFRONTS & DOORS

- 115 x 597
- 140 x 297
- 140 x 397
- 140 x 447
- 140 x 497
- 140 x 597
- 140 x 797
- 140 x 897
- 140 x 997
- 140 x 1197
- 175 x 397
- 175 x 497
- 175 x 597
- 283 x 497
- 283 x 597
- 283 x 797
- 283 x 897
- 283 x 997
- 283 x 1197
- 355 x 497
- 355 x 597
- 355 x 797
- 355 x 897
- 355 x 997
- 355 x 1197
- 450 x 597
- 495 x 597
- 570 x 297
- 570 x 397 sample door
- 570 x 447
- 570 x 497
- 570 x 597
- 645 x 597
- 715 x 147
- 715 x 275
- 715 x 275 pair
- 715 x 297
- 715 x 315
- 715 x 315 pair
- 715 x 347
- 715 x 397
- 715 x 447
- 715 x 497
- 715 x 547
- 715 x 597
- 895 x 297
- 895 x 347
- 895 x 397
- 895 x 447
- 895 x 497
- 895 x 597
- 980 x 597
- 1245 x 297
- 1245 x 397
- 1245 x 447
- 1245 x 497
- 1245 x 597
- 1965 x 497
- 1965 x 597

## STANDARD DOORS



STANDARD DOOR

## STANDARD ACCESSORIES



CORNICE / LIGHT PELMET  
28 X 3000 X 50



PLINTH  
150 X 3050 X 16

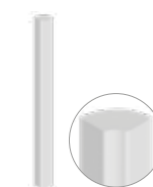

30MM CORNER POST  
715 X 30 X 30



INTERNAL CORNER POST  
715 X 70 X 18



UNIVERSAL MOULDING  
35 X 3050 X 60



PLAIN END PANEL  
780 X 360 X 18  
900 X 650 X 18  
900 X 1200 X 18  
910 X 2430 X 18  
960 X 360 X 18  
2430 X 650 X 18

## MADE TO ORDER DOORS & PANELS



## SIZE PARAMETERS:

	Height (mm)		Width (mm)	
	Min	Max	Min	Max
Drawers/Doors	70	900	100	1200
Doors/Panels	901	1250	100	900
Tall Doors/Panels	1251	2500	100	800

# ZOLA SOFT-MATTE HANDLELESS KITCHEN



ORDER ONLINE  
ONLINE.UFORM.CO.UK

DOORS &  
ACCESSORIES



## HANDLELESS DOORS & ACCESSORIES

160 x 497
160 x 597
160 x 797
160 x 897
160 x 997
160 x 1197
325 x 497
325 x 597
325 x 797
325 x 897
325 x 997
325 x 1197
685 x 147
685 x 297
685 x 315
685 x 315 pair
685 x 347
685 x 397
685 x 447
685 x 497
685 x 597



## HANDLELESS KITS

### HALF HEIGHT L-SHAPE PANEL & POST KIT FOR BASE UNIT

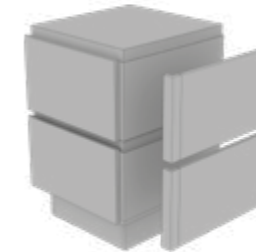

### HALF HEIGHT L SHAPE PANEL & POST KIT FOR BASE UNIT\*

CODE	KIT INCLUDES
prefix-325600LPANPTKT	1 x half height external corner post 1 x plain end panel 325 x 808 2 x mdf fixing batons

### FULL HEIGHT L-SHAPE PANEL & POST KIT FOR BASE UNIT

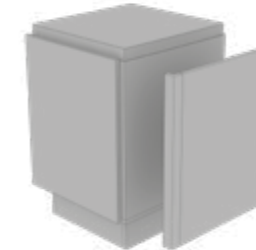

### FULL HEIGHT L SHAPE PANEL & POST KIT FOR BASE UNIT

CODE	KIT INCLUDES
prefix-685600LPANPTKT	1 x external corner post 1 x plain end panel 685 x 808 2 x mdf fixing batons

### HALF HEIGHT C-SHAPE PANEL & POST KIT FOR 900 & 1200 WIDE ISLANDS



### HALF HEIGHT C SHAPE PANEL & POST KIT FOR 900 WIDE ISLAND\*

CODE	KIT INCLUDES
prefix-325900CPANPTKT	2 x half height external corner posts 1 x plain end panel 325 x 808 2 x mdf fixing batons

### FULL HEIGHT C-SHAPE PANEL & POST KIT FOR 900 & 1200 WIDE ISLANDS



### FULL HEIGHT C SHAPE PANEL & POST KIT FOR 900 WIDE ISLAND

CODE	KIT INCLUDES
prefix-685900CPANPTKT	2 x external corner posts 1 x plain end panel 685 x 808 2 x mdf fixing batons

### HALF HEIGHT C SHAPE PANEL & POST KIT FOR 1200 WIDE ISLAND\*

CODE	KIT INCLUDES
prefix-3251200CPANPTKT	2 x half height external corner posts 1 x plain end panel 325 x 1108 3 x mdf fixing batons

### FULL HEIGHT C SHAPE PANEL & POST KIT FOR 1200 WIDE ISLAND

CODE	KIT INCLUDES
prefix-6851200CPANPTKT	2 x half height external corner posts 1 x plain end panel 685 x 1108 3 x mdf fixing batons

Please refer to pages 286-291 for fitting details.

\* Please note: 2 panel kits are required for each half-height base run / island end solution.

## MADE TO ORDER DOORS & PANELS



### SIZE PARAMETERS:

	Height (mm)		Width (mm)	
	Min	Max	Min	Max
Drawers/Doors	70	900	100	1200
Doors/Panels	901	1250	100	900
Tall Doors/Panels	1251	2500	100	800

## EX-STOCK MADE TO ORDER

EX-STOCK	MADE TO ORDER
White	White
Porcelain	Porcelain
Light Grey	Light Grey
Cashmere	Cashmere
Dust Grey	Dust Grey
Indigo	Indigo
Graphite	Graphite

## DOOR SPECIFICATION

Description	Slab
Finish	Soft touch matte PET foil and laquered
Frame material	MDF
Door thickness	18mm
Edge colour	As face
Reverse colour	As face - melamine matte

## LEAD TIMES EXCLUDING DELIVERY (WORKING DAYS)

FINISH	STANDARD PRODUCTS	MADE TO ORDER DOORS & PANELS
PET Foil	EX	10



**EX-STOCK** **MADE TO ORDER**

	White		White
	Cashmere		Porcelain
	Graphite		Light Grey
			Cashmere
			Dust Grey
			Indigo
			Graphite

**DOOR SPECIFICATION**

Description	Slab
Finish	Soft touch matte PET foil and lacquered
Frame material	MDF
Door thickness	18mm
Edge colour	As face - ABS
Reverse colour	As face - melamine matte

**LEAD TIMES EXCLUDING DELIVERY (WORKING DAYS)**

FINISH	STANDARD PRODUCTS	MADE TO ORDER DOORS & PANELS
PET Foil	EX	10

**STANDARD DRAWERFRONTS & DOORS**

- 140 x 297
- 140 x 397
- 140 x 447
- 140 x 497
- 140 x 797
- 140 x 897
- 140 x 997
- 215 x 397
- 215 x 447
- 215 x 497
- 215 x 797
- 215 x 897
- 215 x 997
- 283 x 497
- 283 x 797
- 283 x 897
- 283 x 997
- 355 x 497
- 355 x 797
- 355 x 897
- 355 x 997
- 450 x 397
- 450 x 447
- 450 x 497
- 570 x 297
- 570 x 397
- 570 x 447
- 570 x 497
- 715 x 297
- 715 x 347
- 715 x 397
- 715 x 447
- 715 x 497
- 1495 x 397
- 1495 x 447
- 1495 x 497
- 1595 x 397
- 1595 x 447
- 1595 x 497
- 2155 x 397
- 2155 x 447
- 2155 x 497
- 2250 x 397
- 2250 x 447
- 2250 x 497

**STANDARD DOORS**

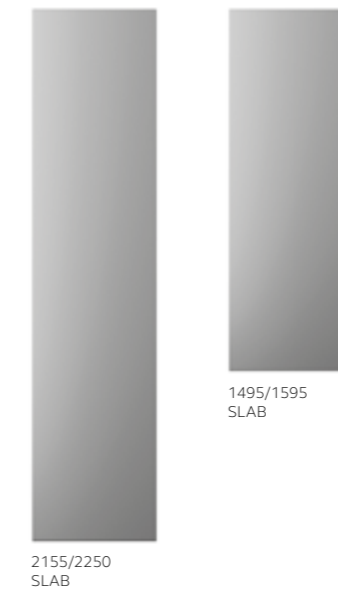

2155/2250 SLAB

1495/1595 SLAB

**STANDARD ACCESSORIES**

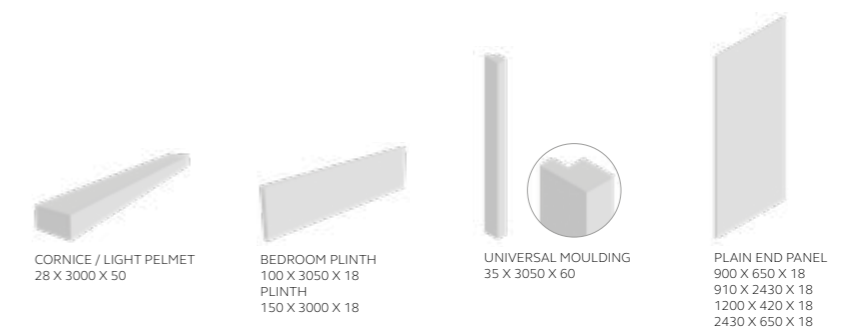

CORNICE / LIGHT PELMET  
28 X 3000 X 50

BEDROOM PLINTH  
100 X 3050 X 18  
PLINTH  
150 X 3000 X 18

UNIVERSAL MOULDING  
35 X 3050 X 60

PLAIN END PANEL  
900 X 650 X 18  
910 X 2430 X 18  
1200 X 420 X 18  
2430 X 650 X 18

**MADE TO ORDER DOORS & PANELS**



**SIZE PARAMETERS:**

	Height (mm)		Width (mm)	
	Min	Max	Min	Max
Drawers/Doors	70	900	100	1200
Doors/Panels	901	1250	100	900
Tall Doors/Panels	1251	2500	100	800



## *Universal accessories.*

CHOPPING BOARD SET	112
CIRCULAR TIMBER TOP	112
PANTRY LADDER & RAIL KIT	112
TOWEL RAIL KIT	113
BENCH SLATS	113
PANTRY SPICE RACK	113
SHELF BRACKET	114
SPICE DRAWER AND TRAY SET	114
TRAY AND CHOPPING BOARD SET	114
WINE GLASS HOLDER	115
WINE RACK RAIL	115
DOVETAIL DRAWERS: PLANT-ON	116
DOVETAIL DRAWERS: INFRAME	118
INFRAME HINGES AND FITTINGS	120
FURNITURE LEGS	120

DESIGN NOTES

A series of horizontal dotted lines for taking design notes.



u form

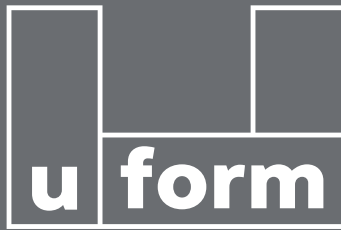

Stay connected

*uform.co.uk*

