

the Infuser™

Instruction Book - BES840



Breville®



Contents

2	Breville Recommends Safety First
6	The Infuser™ Features
7	Components
9	Functions
20	Care & Cleaning
25	Troubleshooting
29	Coffees to try

BREVILLE RECOMMENDS SAFETY FIRST

At Breville we are very safety conscious. We design and manufacture consumer products with the safety of you, our valued customer, foremost in mind. In addition we ask that you exercise a degree of care when using any electrical appliance and adhere to the following precautions.

IMPORTANT SAFEGUARDS

**READ ALL
INSTRUCTIONS BEFORE
USE AND SAVE FOR
FUTURE REFERENCE**

- Carefully read all instructions before operating and save for future reference.
- Remove and safely discard any packaging material and promotional labels or stickers before using the Breville Infuser™ for the first time.
- To eliminate a choking hazard for young children, remove and safely discard the protective cover fitted to the power plug of this appliance.
- Do not place the Breville Infuser™ near the edge of a bench or table during operation. Ensure the surface is level, clean and free of water and other substances.
- Do not use the Breville Infuser™ on a sink drain board.
- Do not place the Breville Infuser™ on or near a hot gas or electric burner, or where it could touch a heated oven.
- Always ensure the Breville Infuser™ is properly assembled before

- connecting to power outlet and operating. Follow the instructions provided in this book.
- The appliance is not intended to be operated by means of an external timer or separate remote control system.
 - Do not use attachments other than those provided with the Breville Infuser™.
 - Do not attempt to operate the Breville Infuser™ by any method other than those described in this book.
 - Use only cold, tap water in the water tank. Do not use any other liquid.
 - Never use the Breville Infuser™ without water in the water tank.
 - Ensure the portafilter is firmly inserted and secured into the brewing head before using the machine.
 - Never remove the portafilter during the brewing operation as the machine is under pressure.
 - Do not move the Breville Infuser™ whilst in operation.
 - Do not leave the Breville Infuser™ unattended when in use.
 - Do not touch hot surfaces. Allow the Breville Infuser™ to cool down before moving or cleaning any parts.
 - Do not place anything, other than cups for warming, on top of the Breville Infuser™.
 - Always switch off the Breville Infuser™ by pressing the POWER button to 'Off', switch off at the power outlet and unplug if appliance is to be left unattended, if not in use, before cleaning, before attempting to move the appliance, disassembling, assembling and when storing the appliance.
 - Keep the appliance and accessories clean. Follow the cleaning instructions provided in this book.

WARNING

To avoid the risk of injury, do not open the brew chamber during the brew process.

IMPORTANT SAFEGUARDS FOR ALL ELECTRICAL APPLIANCES

- Unwind the power cord fully before use.
- Do not let the power cord hang over the edge of a bench or table, touch hot surfaces, or become knotted.
- To protect against electric shock do not immerse power cord, power plug or appliance in water or any other substance.
- This appliance is not intended for use by persons (including children) with reduced physical, sensory or mental capabilities, or lack of experience or knowledge, unless they have been given supervision or instruction concerning use of the appliance by a person responsible for their safety.
- Children should be supervised to ensure they do not play with the appliance.
- Cleaning and user maintenance shall not be made by children unless they are aged from 8 years and above and supervised. Keep the appliance and its cord out of reach of children aged less than 8 years.
- This appliance can be used by children aged from 8 years and above if they have been given supervision or instruction concerning use of the appliance in a safe way and understand the hazards involved.
- It is recommended to regularly inspect the appliance. Do not use the appliance if power cord, power plug or appliance becomes damaged in anyway. Return the entire appliance to the nearest

authorised Breville Service Centre for examination and/or repair.

- Any maintenance other than cleaning should be performed at an authorised Breville Service Centre.
- This appliance is recommended for household use only. Do not use this appliance for anything other than its intended use. Do not use in moving vehicles or boats. Do not use outdoors. Misuse may cause injury.

- The installation of a residual current device (safety switch) is recommended to provide additional safety protection when using electrical appliances. It is advisable that a safety switch with a rated residual operating current not exceeding 30mA be installed in the electrical circuit supplying the appliance. See your electrician for professional advice.

 **WARNING**

Fully unwind the cord before use.

**FOR HOUSEHOLD USE ONLY
SAVE THESE INSTRUCTIONS**



The Infuser™ Features

PID TEMPERATURE CONTROL

Electronic PID temperature control for increased temperature stability.

THERMOCOIL HEATING SYSTEM

Integrated stainless steel water coil accurately controls water temperature.

COMMERCIAL STYLE STEAM WAND

Stainless steel 360° swivel-action steam wand for effortless milk texturing.

INSTANT HOT WATER

Dedicated hot water outlet for making Americanos or pre-heating cups.

LOW PRESSURE PRE-INFUSION

Applies low water pressure at the start of the extraction to gently expand grinds for an even extraction.

ESPRESSO PRESSURE GAUGE

Monitors espresso extraction pressure.

VOLUMETRIC CONTROL

Preset 1 & 2 cup volumes, manual over-ride or reprogrammable shot volumes.

DRY PUCK FEATURE

Removes excess water from the ground coffee in the filter basket after extraction for easy disposal of the coffee puck.

THE RAZOR™ DOSE TRIMMING TOOL

Patented twist blade trims down the puck to the right level for precision dosing and a consistent extraction.

ADJUSTABLE TEMPERATURE CONTROL

For optimum coffee flavor.



Components

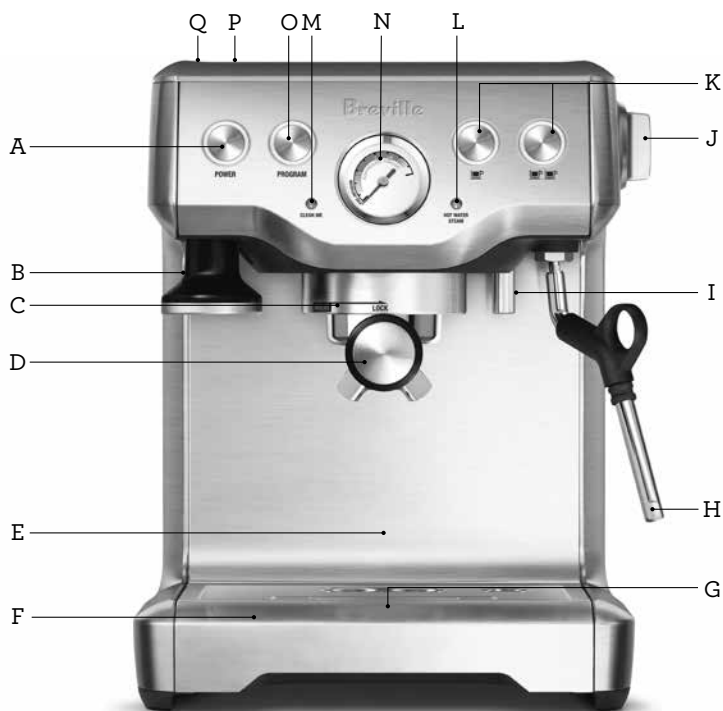

- A. **POWER button** light flashes while machine is heating.
- B. **Integrated & removable 54mm tamper**
- C. **Group head** for easy positioning of the portafilter.
- D. **54mm stainless steel portafilter** with commercial style spouts.
- E. **Extra-tall cup clearance** for tall mugs.
- F. **Removable drip tray** with Empty Me! tray full indicator.
- G. **Storage tray** (located behind drip tray) Houses accessories when not in use.
- H. **360° swivel action steam wand** adjusts to the perfect position for texturing.
- I. **Dedicated hot water outlet** delivers instant hot water for Americanos & pre-heating cups.
- J. **Steam/Hot Water dial**
- K. **1 CUP and 2 CUP buttons** with preset, manual over-ride or reprogrammable shot volumes.
- L. **Steam/Hot Water light** Illuminates to indicate that the steam/hot water function is selected.
- M. **DESCALE/CLEAN light** Illuminates when a cleaning cycle is required.
- N. **Espresso pressure gauge** monitors espresso extraction pressure.
- O. **Program button** reprograms the preset 1 CUP and 2 CUP shot volumes.
- P. **Cup warming tray**
- Q. **61 fl.oz (1.8L) removable water tank** with replaceable water filter.

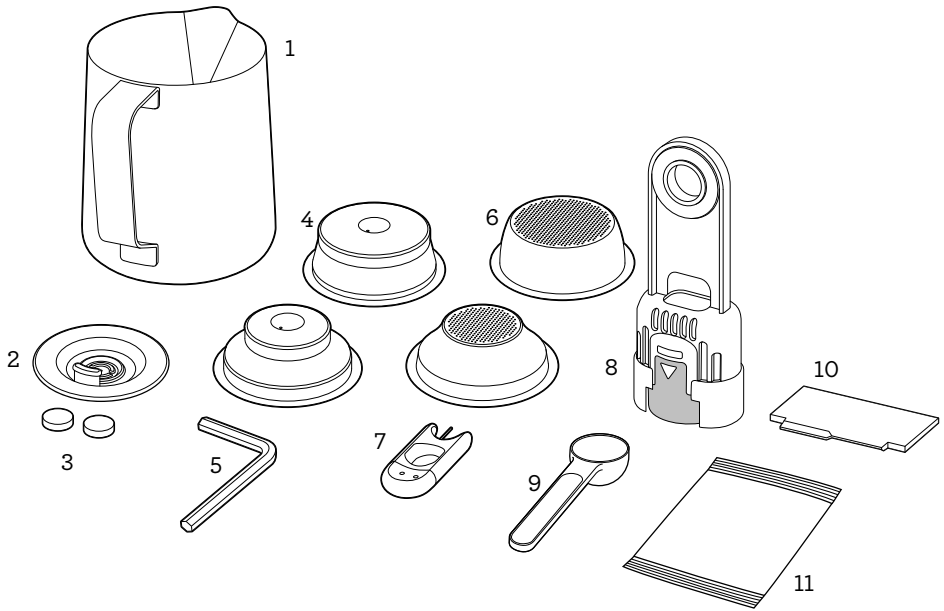

ACCESSORIES

1. **Stainless steel milk jug**
2. **Cleaning disc**
3. **Cleaning tablets**
4. **Dual Wall filter baskets**
(1 cup & 2 cup) Use with pre-ground coffee.
5. **Allen key**
6. **Single Wall filter baskets**
(1 cup & 2 cup) Use when grinding fresh whole coffee beans.
7. **Cleaning tool**
8. **Water filter holder and filter**
9. **Coffee scoop**
Measures the amount of ground coffee for the filter baskets.
10. **The Razor™ precision dose trimming tool**
11. **Descaling powder**

All parts that come into contact with coffee and water are BPA Free.



Functions

BEFORE FIRST USE

Machine Preparation

Remove and discard all labeling and packaging materials attached to your espresso machine. Ensure you have removed all parts and accessories before discarding the packaging.

Clean parts and accessories (water tank, portafilter, filter baskets and jug) using warm water and a gentle dish washing liquid and rinse well. Wipe the outer housing and drip tray with a soft damp cloth and dry thoroughly. Do not immerse the outer housing, power cord or power plug in water or any other liquid.

The water filter located inside the water tank will need to be removed before washing the water tank.

CONDITIONING THE WATER FILTER

- Remove filter from the plastic bag and soak in a cup of water for 5 minutes.
- Rinse filter under cold running water.
- Insert the filter into the filter holder.
- Set the dial date 2 months ahead.
- To install filter, push down to lock into place.
- Slide the water tank into position and lock into place.



NOTE

To purchase water filters, contact Breville Consumer Support.

FIRST USE

Initial Start Up

- Fill tank with water
- Press POWER on
- A pumping sound will be heard. The machine will reach operating temperature and go into STANDBY mode.

FLUSHING THE MACHINE

It is recommended to complete a water flushing operation, without ground coffee, to ensure the machine has been conditioned.

When the machine has reached STANDBY mode, run the following 2 steps.

- Press the 2 CUP button to run hot water through the group head for 30 seconds.
- Activate hot water for 10 seconds.
- Repeat this cycle until the water tank is empty.



NOTE

Do not clean any of the parts or accessories in the dishwasher.

FILLING THE WATER TANK

- Ensure the water filter is securely fitted inside the tank.
- Fill the water tank with cold tap water to the maximum mark on the side of the tank and slide the water tank back into position at the back of the machine.
- Plug the power cord into power outlet and switch On at power point.
- Press the POWER button to On. The POWER button surround will flash while the machine is heating. When the correct temperature has been reached, all the button surrounds on the control panel will illuminate.



NOTE

Check the water level before use and replace the water daily. The water tank should be filled with fresh, cold tap water before each use.

Do not use mineral or distilled water or any other liquid.

TAMPING THE GROUND COFFEE

- Once the grind function has been completed, carefully withdraw the portafilter from the grinding cradle, being careful not to spill any ground coffee, tap down to collapse and using the integrated tamper, tamp down firmly (approx. 15-20 kg of pressure).

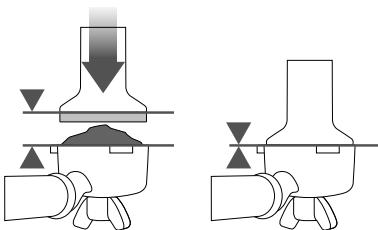

TRIMMING THE DOSE

The Razor™ precision dose trimming tool allows you to trim the puck to the right level for a consistent extraction.



Insert the Razor™ into the coffee basket until the shoulders of the tool rest on the rim of the filter basket. The blade of the dosing tool should penetrate the surface of the tamped coffee.

Rotate the Razor™ dosing tool back and forth while holding the portafilter on an angle over the knock box to trim off excess coffee.

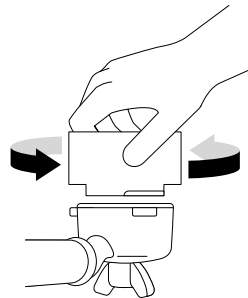

Your coffee filter basket is now dosed with the correct amount of coffee.



NOTE

When using a finer espresso grind for the Single Wall Filter basket, you will need to increase the grind amount to ensure the filter is correctly dosed.

PRE-PROGRAMMED SHOT VOLUME – 1 CUP

Press the 1 CUP once. A preset volume of approximately 30mls will be extracted. The machine will automatically stop once the preset volume has been extracted.



NOTE

The amount of espresso extracted in the cup will vary depending on your grind size and dose amount.

PRE-PROGRAMMED SHOT VOLUME – 2 CUP

Press the 2 CUP button once. A preset volume of approx. 60mls will be extracted. The machine will automatically stop once the preset volume has been extracted.

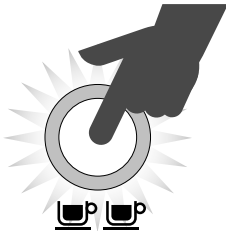

NOTE

Pressing the 1 CUP or 2 CUP buttons during a programmed espresso will immediately stop the extraction.

PROGRAMMING SINGLE ESPRESSO

1. To begin programming, press the PROGRAM button once. The machine will beep once and the program button will begin to flash. This indicates the machine is in programming mode.
2. Press 1 CUP button to start espresso extraction. Press 1 CUP again once desired volume of espresso has been extracted. The machine will beep twice to indicate the new 1 CUP volume has been set.







PROGRAMMING DOUBLE ESPRESSO

1. To begin programming, press the PROGRAM button once. The machine will beep once and the program button will begin to flash. This indicates the machine is in programming mode.
2. Press 2 CUP button to start espresso extraction. Press 2 CUP again once desired volume of espresso has been extracted. The machine will beep twice to indicate the new 2 CUP volume has been set.

ADVANCED TEMPERATURE SETTING

The water temperature can be increased or decreased by 1°C or 2°C if desired.

Coffee of different origins or roast profiles may need a different espresso brew water temperature to optimise their flavour. If your espresso is tasting slightly “ashy” decrease the brew water temperature by 1°C. If your espresso is tasting slightly “sour” increase your brew water temperature by 1°C.

INDICATOR	DESCRIPTION
 POWER	DEFAULT TEMPERATURE
 PROGRAM	-2°C
 1 CUP	+2°C
 2 CUP	SELECT
 DESCALE/CLEAN	-1°C
 HOT WATER STEAM	+1°C

To amend temperature settings:

- With the machine OFF, press and hold the 1 cup button and then simultaneously press and hold the power button.

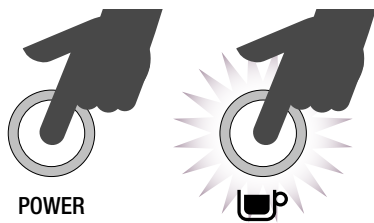

- A beep will sound to indicate that the temperature settings can now be changed.
- The LED of the last saved setting will be illuminated. See table on left.
- Pressing the 2 cup button to allows you to toggle between the different settings.



- Please note that if the 2 cup button is not pressed within 10 seconds, the machine will return to STANDBY mode and the above steps will have to be repeated
- After you have made a selection, 2 beeps will sound to indicate that your setting has been saved.
- The machine will then return to STANDBY mode.

RESETTING DEFAULT VOLUMES

To reset the machine to the default 1 CUP and 2 CUP shot volumes, press and hold the PROGRAM button until the machine beeps three times. Release the PROGRAM button. The machine will return to its original default setting.



Default settings: 1 CUP shot volume is approx. 30ml. 2 CUP is approx. 60ml.

MANUAL SHOT VOLUME

Manually control low pressure pre-infusion time and shot volume without re-programming the pre-set shot volume.

- Press and hold the 1 CUP or 2 CUP button. The extraction will enter low pressure pre-infusion until the button is released
- When the 1 CUP or 2 CUP button is released, extraction will continue at full pressure.
- Press the 1 CUP or 2 CUP button again once the desired volume of espresso has been extracted

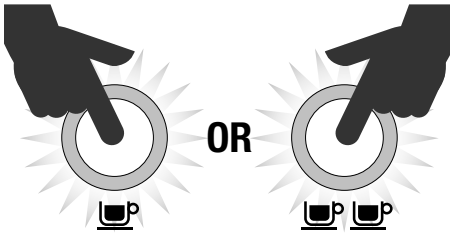

NOTE

For optimal flavour when using a 1 CUP filter, you should extract approx. 30ml. When using a 2 cup filter, you should extract approx. 60ml.

WARNING

The metal parts of the portafilter will be very hot.

ESPRESSO PRESSURE GAUGE LOW PRESSURE PRE-INFUSION

The gauge needle will be positioned in the pre-infusion zone at the start of the extraction indicating the machine is in low pressure pre-infusion mode.

The low pressure pre-infusion gradually increases water pressure to gently expand grinds for an even extraction before increasing to full pressure.

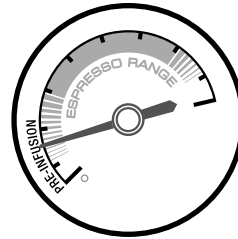

IDEAL ESPRESSO ZONE

During extraction, the gauge needle when positioned in the middle zone, indicates the espresso will be extracted at the ideal pressure.

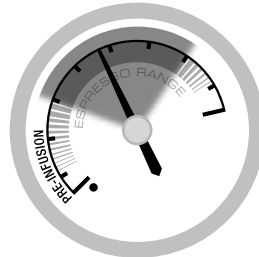

UNDER EXTRACTED ZONE

During extraction, the gauge needle when positioned in the lower zone, indicates the espresso has been extracted with insufficient pressure.

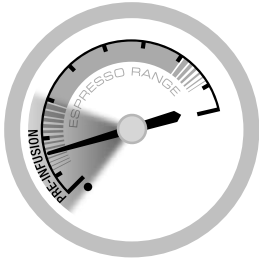

This occurs when the water flow through the ground coffee is too fast and results in an under extracted espresso that is watery and lacks crema and flavour.

Causes for under extraction include the grind being too coarse and/or insufficient coffee in filter and/or under tamping.

OVER EXTRACTED ZONE

The gauge needle, when positioned in the upper zone during extraction, indicates the espresso has been extracted with too much pressure.

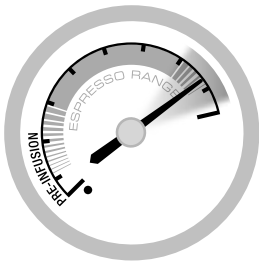

This occurs when the water flow through the ground coffee is too slow and results in an over extracted espresso that is very dark and bitter with a mottled and uneven crema.

Causes for over extraction include the grind being too fine and/or too much ground coffee in filter and/or over tamping.

TEXTURING MILK

The Infuser™ comes with a commercial style steam wand.

TEXTURING MILK

- Turn the STEAM/HOT WATER selector dial to the steam position. The STEAM/HOT WATER light will flash to indicate the machine is heating to create steam.

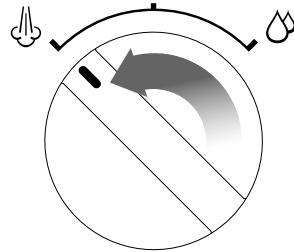

- When the STEAM/HOT WATER light stops flashing the steam wand is ready for use.
- Before inserting the steam wand into the milk, pause the steam by returning the dial back to the STANDBY position. This will avoid the milk splashing out of the jug (this pause function lasts for 6 seconds before exiting steam mode).
- Insert the wand into the milk and return the dial back to the steam position to texture milk.
- To stop the steam return the Steam dial to the STANDBY position and remove the jug.

NOTE

When the espresso machine creates steam, a pumping noise can be heard. This is the normal operation of the 15 bar pump.



NOTE

After 5 minutes of continuous steaming, the machine will automatically disable the steam function. The STEAM/HOTWATER light will flash. When this occurs return the steam dial to the STANDBY position.

HOT WATER

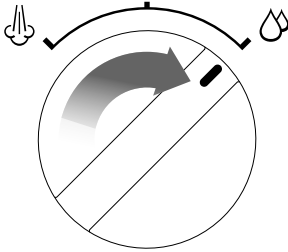

- Turn the STEAM/HOT WATER selector dial to the Hot Water position.
- To stop the hot water, return the STEAM/HOT WATER dial to the STANDBY position.

AUTO PURGE

For extracting espresso immediately after using the steam function, this machine features an auto-purge function.

The auto purge function ensures the ground coffee will not be burnt by the initial water flow from the thermocoil being too hot. The water is automatically released internally into the drip tray ensuring that the thermocoil is at optimal temperature for extracting espresso

Your espresso will always be extracted at the optimal temperature ensuring only the best flavours are extracted.

PRE-HEATING

Heating your cup or glass

A warm cup will help maintain the coffee's optimal temperature. Preheat your cup by rinsing with hot water and place on the cup warming tray.

Heating the portafilter and filter basket

A cold portafilter and filter basket can reduce the extraction temperature enough to significantly affect the quality of your espresso. Ensure the portafilter and filter basket are preheated with hot water before initial use.



NOTE

Wipe the filter and portafilter dry before dosing with ground coffee as moisture can encourage 'channeling' where water bypasses the ground coffee during extraction.

SINGLE WALL FILTERS

The Single Wall filters (1 & 2 CUP) are designed to be used with freshly ground coffee and allow you to experiment with grind, dose, and tamp to create a more balanced espresso.

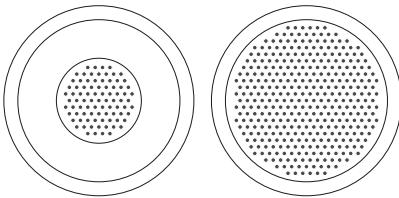

The Single Wall filters have no markings on the underside of the filter.

DUAL WALL CREMA SYSTEM FILTERS

The Dual Wall filters (1 & 2 CUP) are designed to be used with pre-ground coffee and regulate the pressure to help optimise extraction regardless of the grind, dose or tamp pressure.

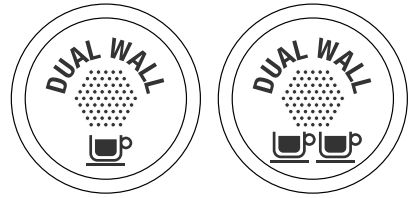

The Dual Wall filters have DUAL WALL stamped on the underside of the filter.

THE GRIND

If grinding coffee beans, the grind size should be fine but not too fine. The grind size will affect the rate at which the water flows through the ground coffee in the filter basket and the taste of the espresso.

If the grind is too fine (looks like powder and feels like flour when rubbed between fingers), the water will not flow through the coffee when under pressure. The resulting espresso will be **OVER EXTRACTED**, dark in colour and bitter in flavour

If the grind is too coarse the water will flow through the ground coffee in the filter basket too quickly. The resulting espresso will be **UNDER EXTRACTED** lacking in colour and flavour.

COFFEE DOSE AND TAMPING

- Wipe coffee basket with a dry cloth.
- If using Single Wall filter baskets, grind enough coffee to fill the coffee basket. You may need to experiment with the amount of coffee to achieve the correct dose.
- Tap the portafilter several times to distribute the coffee evenly in the filter basket.
- Tamp down firmly (using approx. 15-20kgs of pressure). The amount of pressure is not as important as consistent pressure every time.

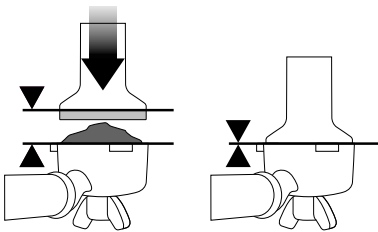

- As a guide to dose, the top edge of the metal cap on the tamper should be level with the top of the filter basket AFTER the coffee has been tamped.
- Wipe excess coffee from the rim of the filter basket to ensure a proper seal in the group head is achieved.

TRIMMING THE DOSE

The Razor™ precision dose trimming tool allows you to trim the puck to the right level for a consistent extraction.



Insert the Razor™ into the coffee basket until the shoulders of the tool rest on the rim of the filter basket. The blade of the dosing tool should penetrate the surface of the tamped coffee.

Rotate the Razor™ dosing tool back and forth while holding the portafilter on an angle over the knock box to trim off excess coffee.

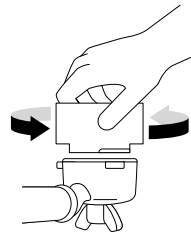

Your coffee filter basket is now dosed with the correct amount of coffee.

EXTRACTION GUIDE

	GRIND	GRIND DOSE	TAMP	SHOT TIME
OVER EXTRACTED BITTER • ASTRINGENT	TOO FINE	TOO MUCH USE RAZOR TO TRIM	15-20KG	OVER 35 SEC
BALANCED	OPTIMUM	8-11g (1 CUP) 16-19g (2 CUP)	(15-20kg)	25-30 SEC
UNDER EXTRACTED UNDERDEVELOPED • SOUR	TOO COARSE	TOO LITTLE INCREASE DOSE & USE RAZOR TO TRIM	15-20KG	UNDER 20 SEC

PURGING THE GROUP HEAD

- Before placing the portafilter into the group head, run a short flow of water through the group head by pressing the 1 CUP or 2 CUP button. This will purge any ground coffee residue from the group head and stabilise the temperature prior to extraction.

INSERTING THE PORTAFILTER

Place the portafilter underneath the group head so that the handle is aligned with the INSERT position. Insert the portafilter into the group head and rotate the handle towards the centre until resistance is felt.

EXTRACTING ESPRESSO

- Place pre-warmed cup(s) beneath the portafilter and press the 1 CUP or 2 CUP button for the required volume.
- As a guide, the espresso will start to flow after 8-12 seconds (infusion time) and should be the consistency of dripping honey.
- If the espresso starts to flow before 7 seconds you have either under dosed the filter basket and/or the grind is too coarse. This is an UNDER-EXTRACTED shot.
- If the espresso starts to drip but doesn't flow after 12 seconds, then you have either over dosed the filter basket and/or the grind is too fine. This is an OVER-EXTRACTED shot.

A great espresso is about achieving the perfect balance between sweetness, acidity and bitterness.

The flavour of your coffee will depend on many factors, such as the type of coffee beans, degree of roast, freshness, coarseness or fineness of the grind, dose of ground coffee, and tamping pressure.

Experiment by adjusting these factors just one at a time to achieve the taste of your preference.

TEXTURING MILK

There are two phases to texturing milk. The first is stretching the milk to aerate it and the second is swirling the milk to make it silky smooth. These two operations should blend into one.

- Always start with fresh cold milk.
- Fill the jug just below the V at the bottom of the spout.
- Position the steam tip over the drip tray and turn on the steam system, purging any condensed water.
- Turn the steam dial to the STANDBY position, insert steam wand tip into milk and turn dial back to STEAM position.
- Insert the steam tip 1-2cm below the surface of the milk close to the right hand side of the jug at the 3 o'clock position.
- Keep the tip just under the surface of the milk until the milk is spinning clockwise, producing a vortex (whirlpool effect).

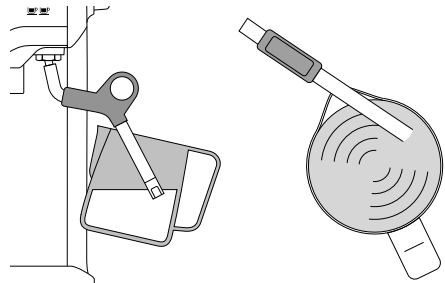

- With the milk spinning, slowly lower the jug. This will bring the steam tip to the surface of the milk & start to introduce air into the milk. You may have to gently break the surface of the milk with the tip to get the milk spinning fast enough.
- Keep the tip at or slightly below the surface, continuing to maintain the vortex. Texture the milk until sufficient volume is obtained.
- Lower the tip beneath the surface, but keep the vortex of milk spinning. The milk is at the correct temperature (60-65°C) when the jug is hot to touch.

- Move the steam dial to the STANDBY position before taking the tip out of the milk.
- Set the jug to one side, turn steam on to purge out any residual milk from the steam wand and wipe steam wand with a damp cloth.
- Tap the jug on the bench to collapse any bubbles.
- Swirl the jug to polish and re-integrate the texture.
- Pour milk directly into the espresso.
- The key is to work quickly, before the milk begins to separate.

HINTS & TIPS

1. Use freshly roasted coffee beans, with a 'roasted on' date and use within 5-20 days of 'roasted on' date.
2. Grind beans immediately before brewing as ground coffee quickly loses its flavour and aroma.
3. Store coffee beans in a cool, dark and dry container. Vacuum seal if possible.
4. Buy coffee beans in small batches to reduce the storage time and store no more than one week's supply at any time.



Care & Cleaning

INSTALLING/REPLACING THE FILTER IN THE WATER TANK

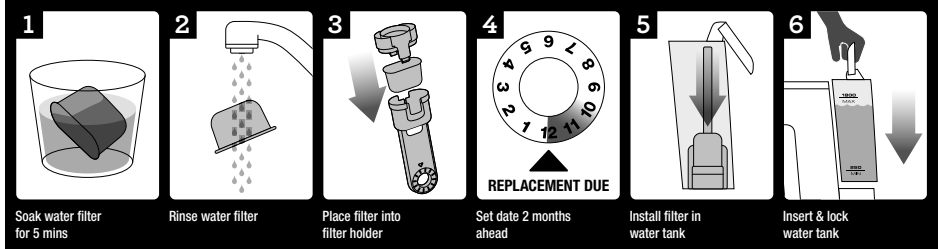

The water filter provided helps to prevent scale build up which over time can affect the performance of your machine, potentially causing blockages and heating problems

Replacing the water filter every two months will reduce the need to de-scale the machine.

If you live in a hard water area, we recommend you change the water filter more frequently.

Replacing The Water Filter

- Remove the filter from the plastic bag, and soak in a cup of water for 5 minutes
- Rinse the filter under cold running water for 5 seconds
- Insert the filter into the filter holder
- Set the date dial 2 months ahead
- To install, push down to lock into place

The water filter can be removed from the water tank during operation if not required.



NOTE

For replacement water filters contact Breville Customer Service Centre.

PORTAFILTER CLEANING

Periodically run water through the machine with the portafilter in place, but without any ground coffee, to rinse out any residual coffee particles.

CLEANING CYCLE

The espresso machine features an in-built cleaning cycle which should be carried out periodically. The DESCALE/CLEAN light will automatically illuminate (flashing) to indicate when a cleaning cycle is required.

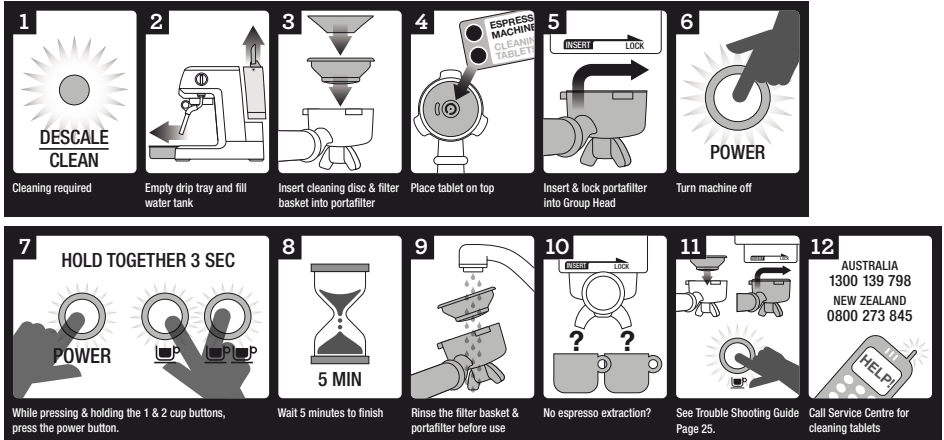

CLEANING CYCLE PROCESS GUIDE

If cleaning is required, simply follow the steps below and refer to the Machine Cleaning Cycle guide.

1. Insert the cleaning disc into the one or two cup filter basket.
2. Place the filter basket into the portafilter.
3. Put 1 cleaning tablet into the filter.
4. Lock the portafilter into the group head.
5. Turn the machine OFF.
6. Simultaneously press and hold the 1 CUP, 2 CUP and POWER button for 3 seconds.
7. While pressing & holding the 1 & 2 cup buttons, press the power button.
8. If the tablet has not dissolved, repeat steps 5 to 7 until tablet has dissolved.

DESCALING



NOTE

Ensure that the water filter is removed from the water tank before adding the descaling powder when descaling the machine.

After regular use, hard water can cause mineral build up in and on many of the inner functioning components, reducing the brewing flow, brewing temperature, power of the machine, and taste of the espresso.

We advise you to undertake the descaling processes outlined below when the 'DESCALE/CLEAN' indicator is illuminated (solid on).

Refer to CLEANING CYCLE on page 21 when the 'DESCALE/CLEAN' indicator is flashing.

Check if descaling is required

1. Check if the 'DESCALE/CLEAN' light is illuminated (solid on), descaling is required.



WARNING

Do not immerse power cord, power plug or appliance in water or any other liquid. The water tank should never be removed or completely emptied during descaling.

Priming machine for descaling function



2. Dissolve one Breville Descaling powder sachet into one litre of water then fill the water tank.
3. Press and hold the 2-CUP button and then press and hold the POWER button simultaneously to enter the Descale mode. The unit will heat up as part of commencing the descaling action, during the heating processes the POWER button should flash continuously. The machine will indicate it is ready for descaling when the POWER button, 1 CUP button, DESCALE/CLEAN indicator and HOT WATER/ STEAM indicator are all illuminated (solid on).

Descaling the coffee component

4. Press the 1-CUP button to start the descaling for the coffee component of the machine. Descaling coffee component takes approximately 25 seconds. The 1 CUP button should flash continuously and remain constant once the descaling process has finished. To terminate the descaling within 25 seconds, press the 1 CUP button again.

Descale the Steam and hot water components

Descaling steam and hot water takes approximately 13 seconds and 8 seconds respectively. Descaling can be terminated prematurely by turning the steam dial to STANDBY.

5. Descale Steam component by turning the steam dial RIGHT towards the  icon.
6. Descale Hot water component by turning the steam dial to the LEFT towards the  icon.

Repeat processes to complete descaling

After the above processes about half (0.5 litre) of the descale solution should be left in the water tank.

7. Repeat steps 4-6 above to complete the descaling process to empty the solution in the tank.

Descaling Solution Rinse

8. After descaling, remove the water tank and rinse thoroughly then refill with fresh cold water to the maximum capacity (2 litres) and repeat steps 4-6 to further cleanse the machine of any residue of the cleaning solution thoroughly.
9. Press 'POWER' to quit the descaling process. This will be indicated by the LED lights switching off.



NOTE

The machine turns off automatically if there is no action for 5 minutes in descaling mode. To resume descaling, please start from step 3.

CLEANING THE STEAM WAND



- The steam wand should always be cleaned after texturing milk.
- Wipe the steam wand with a damp cloth, and then with the steam wand directed back into the drip tray, briefly set the steam dial to the STEAM position. This will clear any remaining milk from inside the steam wand.
- Ensure the steam dial is in the STANDBY position. Press the POWER button to Off and allow the machine to cool.
- If the steam wand remains blocked, use the pin on the cleaning tool to clear the opening.
- If the steam wand continues to be blocked, the tip of the steam wand can be removed by using the spanner in the middle of the cleaning tool.
- Unscrew the tip with the cleaning tool.
- Soak the tip in hot water before using the pin on the cleaning tool to unblock. Replace the tip back onto the steam wand and secure with the cleaning tool.

CLEANING / UNBLOCKING THE FILTERS, PORTAFILTER AND GROUP HEAD

Periodically run water through the machine with the portafilter in place, but without any ground coffee, to rinse out any residual coffee particles.

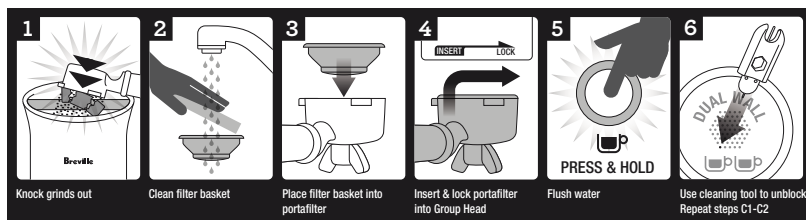

Should the fine holes in the filters become blocked follow the steps below:

1. Place the filter into the portafilter. Run water through the machine with the filter and portafilter, without any ground coffee, in place.
2. The fine pin on the cleaning tool can be used to clear the filter basket holes.
3. To clean the Single Wall filters simply run water through the portafilter using the manual pour function by holding down the 1 CUP button.
4. For a thorough clean of the filters, run a cleaning cycle of the machine with the portafilter and filter in place

CLEANING THE OUTER HOUSING / CUP WARMING PLATE

The outer housing and tray warming plate can be cleaned with a soft, damp cloth. Then polish with a soft, dry cloth.

Do not use abrasive cleansers, pads or cloths which can scratch the surface.

CLEANING THE DRIP TRAY

The drip tray should be removed, emptied and cleaned at regular intervals, particularly when the drip tray full indicator is showing EMPTY ME!.

Remove grill and EMPTY ME! indicator from the drip tray. Wash the drip tray with warm soapy water, using a non-abrasive washing liquid, rinse and dry thoroughly. The EMPTY ME! indicator can be removed from the drip tray by pulling upwards to release the side latches.

The drip tray base and cover are dishwasher safe.

CLEANING THE STORAGE TRAY

The storage tray can be removed after the drip tray is removed then cleaned with a soft, damp cloth (do not use abrasive cleansers, pads or cloths which can scratch the surface).

STORING YOUR MACHINE

Before storing, press the POWER button to off, turn the STEAM/HOT WATER dial to STANDBY switch Off at the power outlet and unplug.

Insert all accessories into position or into the storage tray.

Store upright. Do not place anything on top.



WARNING

Do not immerse power cord, power plug or appliance in water or any other liquid. The water tank should never be removed or completely emptied during decalcifying.



Troubleshooting

PROBLEM	POSSIBLE CAUSES	WHAT TO DO
When the machine is switched On, the STEAM/HOT WATER lights is flashing.	<ul style="list-style-type: none">• STEAM/HOT WATER dial is not in STANDBY position	Turn the STEAM/HOT WATER dial to 'STANDBY' position. Machine will commence normal heat up procedure.
Coffee does not run through	<ul style="list-style-type: none">• Machine is not turned On or plugged in	Ensure the machine is plugged in, switched On at the power outlet and the POWER button is pressed On.
	<ul style="list-style-type: none">• Water tank is empty	Refer to 'Filling The Water Tank', page 10.
	<ul style="list-style-type: none">• Coffee grind is too fine	Ensure you use a suitable espresso grind. Refer to 'The Grind' on page 16.
	<ul style="list-style-type: none">• Too much coffee in the filter	Refer to 'Coffee Dose & Tamping', page 10 and 17.
	<ul style="list-style-type: none">• Coffee tamped too firmly	Refer to 'Coffee Dose and Tamping' on page 17.
	<ul style="list-style-type: none">• The filter is blocked	Clean the filters. Refer to 'Cleaning The Filters', page 24.
Coffee runs out too quickly	<ul style="list-style-type: none">• The coffee grind is too coarse	Ensure you use a suitable espresso grind. Refer to 'The Grind' on page 16.
	<ul style="list-style-type: none">• Not enough ground coffee in the filter	Refer to 'Coffee Dose and Tamping', page 10 and 17.
	<ul style="list-style-type: none">• Ground coffee not tamped firmly enough	Refer to 'Coffee Dose and Tamping', page 17 .

PROBLEM	POSSIBLE CAUSES	WHAT TO DO
Coffee is too cold	<ul style="list-style-type: none"> • Cups not preheated 	Preheat cups. Refer to 'Pre-heating Cup or Glass' on page 16.
	<ul style="list-style-type: none"> • Milk not heated enough (if making a cappuccino or latté) 	When the base of the jug becomes too hot to touch this is when the milk is heated at the correct temperature. Refer to 'Texturing Milk', page 18.
No crema	<ul style="list-style-type: none"> • Coffee is not tamped firmly enough 	Refer to 'Coffee Dose and Tamping', page 17.
	<ul style="list-style-type: none"> • Coffee grind is too coarse 	Ensure you use a suitable espresso grind. Refer to 'The Grind' on page 16.
	<ul style="list-style-type: none"> • Ground coffee is not fresh 	Change old beans with fresh roasted or pre-ground. Ground coffee should not be kept for longer than a week.
	<ul style="list-style-type: none"> • Filter holes are blocked 	Use the fine pin on the cleaning tool to clear the holes. Refer to 'Cleaning The Filters', page 24.
Machine is making pulsing/pumping sound while extracting coffee or steaming milk	<ul style="list-style-type: none"> • The machine is carrying out the normal operation of the 15 bar pump 	No action require as this is the normal operation of the machine.

PROBLEM	POSSIBLE CAUSES	WHAT TO DO
Coffee runs out around the edge of the filter holder	<ul style="list-style-type: none"> Filter holder is not inserted in the group head properly 	Insert filter holder to align into 'LOCK' position in group head. Refer to 'Inserting The Portafilter', page 17.
	<ul style="list-style-type: none"> There are coffee grounds around the filter rim 	Clean any excess ground coffee from the rim of the filter holder to ensure a proper fit into the brew head.
	<ul style="list-style-type: none"> Too much ground coffee in the filter 	Refer to 'Coffee Dose & Tamping', page 10.
	<ul style="list-style-type: none"> Ground coffee has been tamped too firmly 	Refer to 'Coffee Dose & Tamping', page 17.
	<ul style="list-style-type: none"> Incorrect filter for amount of ground coffee used 	Ensure you use the small filter for 1 cup of coffee and the larger filter for 2 cups of coffee.
Coffee extracts as drops from the portafilter	<ul style="list-style-type: none"> The water tank is empty or low 	Refer to 'Filling The Water Tank', page 10.
	<ul style="list-style-type: none"> Coffee grind is too fine Too much coffee in basket 	Ensure you use a suitable espresso grind. Refer to 'The Grind' on page 16.
	<ul style="list-style-type: none"> Machine is blocked by mineral deposits 	Decalcify the machine. Refer to 'Descaling', page 22
Machine is making a loud and continuous pumping noise	<ul style="list-style-type: none"> Water tank is empty 	Refer to 'Filling The Water Tank', page 10 .
	<ul style="list-style-type: none"> Water tank is not securely in place 	Refer to 'Filling The Water Tank', page 10 .

PROBLEM	POSSIBLE CAUSES	WHAT TO DO
No steam is generated	• Machine is not turned On	Ensure the machine is plugged in, switched On at the power outlet and the POWER button is pressed On.
	• Water tank is empty	Refer to 'Filling The Water Tank', page 10.
	• Steam Dial is not in STEAM/HOT WATER dial position	Turn the STEAM/HOT WATER dial to the STEAM position.
	• Steam Wand is blocked	Use the pin on the cleaning tool to clear the opening. If the steam wand continues to be blocked remove the tip of the steam wand using the spanner in the middle of the cleaning tool. Refer to 'Cleaning steam wand', page 23.
No hot water	• Empty tank	Fill tank
Milk is not creamy after texturing	• Not enough steam	Steam wand may be blocked. Refer to 'Cleaning steam wand', page 23.
		Use cold fresh milk. Refer to 'Texturing Milk', page 18.
Machine is not working		The safety thermal-cut may have activated due to the pump overheating. Turn the machine off and allow to cool for about 30-60 minutes.
Pressure Gauge is not working	• Incorrect dose or not enough coffee in the filter basket.	Use the supplied 'Razor' to ensure the correct dose of coffee in the portafilter.
	• Using old roasted coffee beans beyond expiry date.	Use freshly roasted coffee within four weeks of roasted date.
	• The coffee grind is too coarse.	Adjust the grind to a finer setting. Use a rubber disc and place inside the one cup filter basket (no coffee) and run a shot; when the needle moves, then pressure gauge dial is working.



Coffees to try

CAPPUCCINO

A single shot of espresso with textured milk, garnished with drinking chocolate.



MACCHIATO

Traditionally served short, the macchiato is also poured as a long black with a dash of milk or a dollop of textured milk.



ESPRESSO

Intense and aromatic, it is also known as a short black and is served in a small cup or glass.



AMERICANO

Add hot water first, then a shot of espresso (single or double) so that cream is maintained. Also known as a long black.



LATTÉ

A latté consists of a single espresso with textured milk and approx. 10mm of foam.



RISTRETTO

A ristretto is an extremely short espresso of approximately 15ml, distinguished by its intense flavor and aftertaste.





Notes



Notes

Breville Customer Service Centre

Australian Customers

Phone: 1300 139 798

Web: www.breville.com

New Zealand Customers

Phone: 0800 273 845

Web: www.breville.com

Breville®

Master Every Moment™

Breville, the Breville logo, Bambino, ThermoJet, Breville Assist and Master Every Moment are trademarks of Breville Pty Ltd ("Breville").
A.B.N. 98 000 092 928. Copyright Breville Pty. Ltd. 2021.

Due to continued product improvement, the products illustrated/photographed in this booklet may vary slightly from the actual product.

BES840 ANZ K21