

---

EC9885

# La Specialista MAESTRO

COFFEE MAKER

Instructions for use.



---

**DeLonghi**

**A**

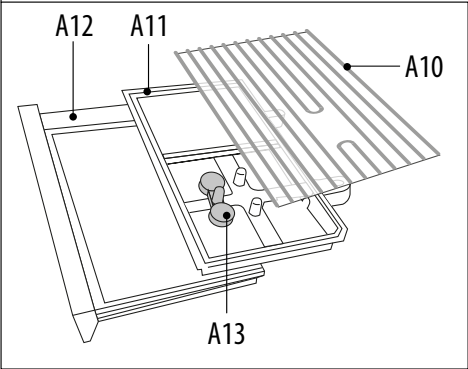
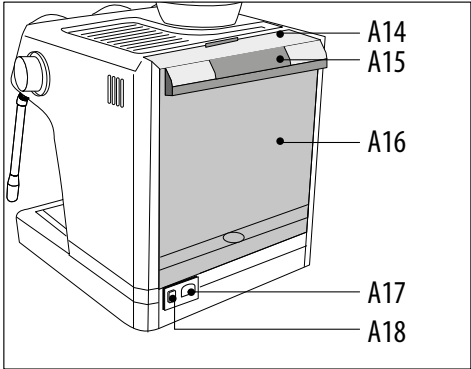
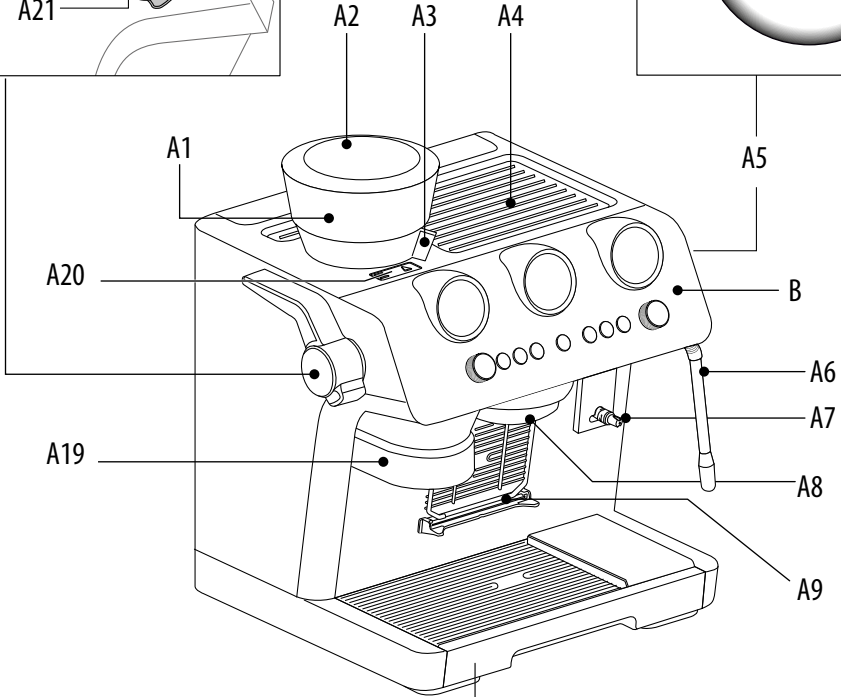
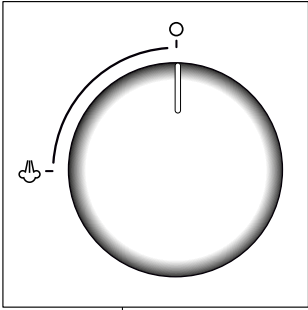
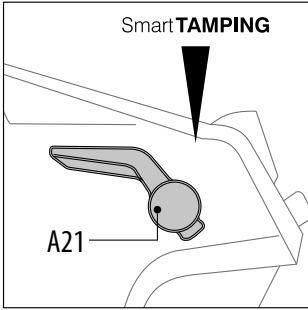

**B**

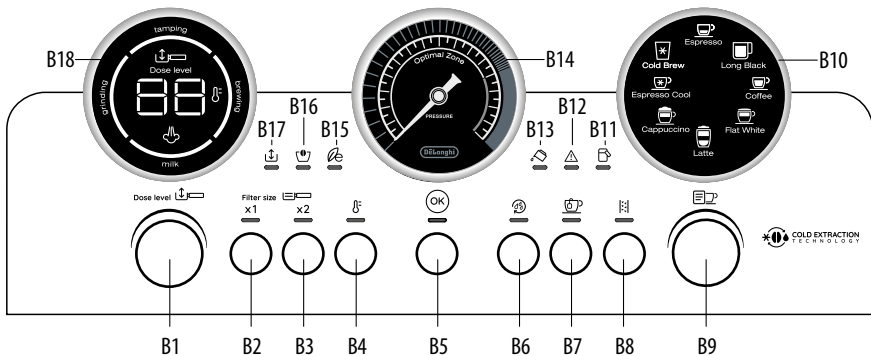

**C\***

**D**

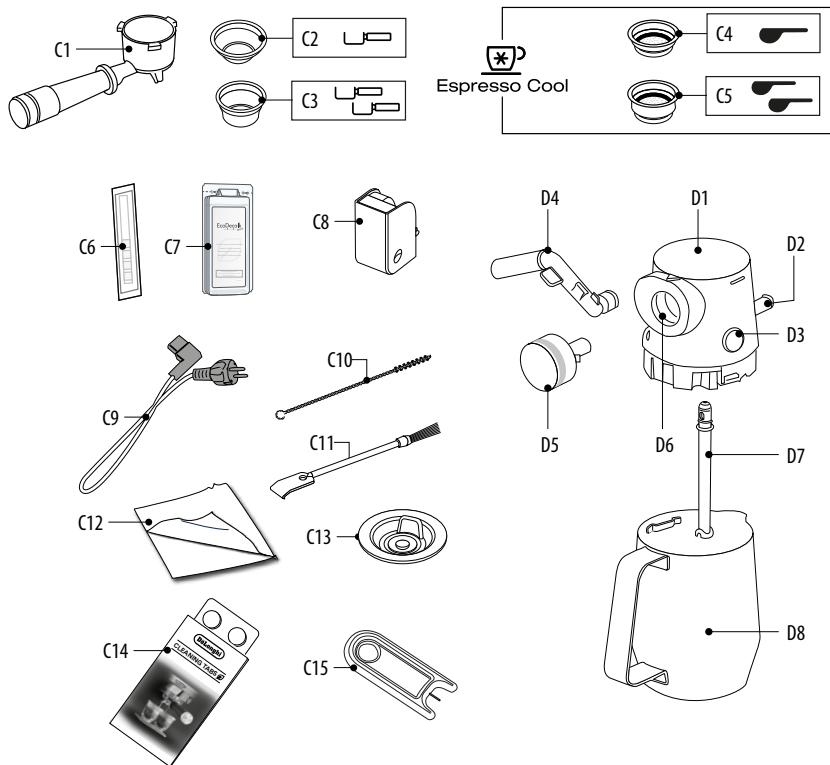

## 1. DESCRIPTION

### 1.1 Description of appliance - A

- A1. Beans container
- A2. Beans container lid
- A3. Grind selector (fine to coarse)
- A4. Cup tray
- A5. Steam dial
- A6. Steam wand and nozzle
- A7. Lattecrema connection
- A8. Coffee outlet
- A9. Cup grille for espresso
- A10. Cup grille for glasses or mugs
- A11. Drip tray grille
- A12. Drip tray
- A13. Drip tray water level indicator
- A14. Water tank lid
- A15. Water tank extraction handle
- A16. Water tank
- A17. Power cord connector socket
- A18. Main switch (ON/OFF)
- A19. Coffee grinder outlet (tamping station)
- A20. Cover to access the coffee grinder coffee guide
- A21. Presser lever

### 1.2 Description of control panel - B

- B1. Coffee dose dial
- B2. "x1" button: to use the 1 coffee filter
- B3. "x2" button: to use the 2 coffees filter
- B4. Coffee Temperature button
- B5. "OK" button: to deliver the drink/confirm
- B6. "Active Rinse" button
- B7. Hot water button
- B8. "Descaling" button
- B9. Drink selector dial
- B10. Drink selected light:

#### Hot Espresso based drinks

- Espresso
- Long Black
- Coffee

#### Cold coffee based drinks

- Espresso Cool
- Cold Brew

#### Milk based drinks

- Cappuccino
  - Flat White
  - Latte
- B11. "Milk clean" light

- B12. "General alarm" light
- B13. "No water" light
- B14. Pressure gauge
- B15. "Energy saving" light
- B16. "No beans container" light
- B17. "Anti-clogging" light
- B18. Led module process:
  - Indicates the operation the appliance is running
  - The setting of the dose level
  - The infusion temperature setting
  - The selected setting (see "9. Menu settings")

### 1.3 Description of accessories - C\*

(\* The accessories may vary in type and number depending on the model.)

- C1. Portafilter
- C2. 1-cup coffee filter
- C3. 2-cups coffee filter
- C4. 1-cup Espresso cool filter
- C5. 2-cups Espresso cool filter
- C6. "Water hardness test" indicator paper
- C7. Descaler
- C8. Descaling accessory
- C9. Removable power cord
- C10. Tube brush
- C11. Cleaning brush
- C12. Cloth
- C13. Coffee outlet cleaning disk accessory
- C14. Coffee outlet cleaning tabs
- C15. Accessory for cleaning the steam wand

### 1.4 Recommended optional cleaning accessories

Visit [Delonghi.com](http://Delonghi.com) for more information.

ECO MULTICLEAN  **Cleaner**  
EAN: 8004399333307

### 1.5 Description of LatteCrema - D

- D1. Milk container lid
- D2. Milk container connector
- D3. Lid release button
- D4. Milk spout (adjustable height)
- D5. Froth selection knob
- D6. Knob housing
- D7. Milk intake tube
- D8. Milk container

## 2. PREPARING YOUR MACHINE FOR FIRST USE

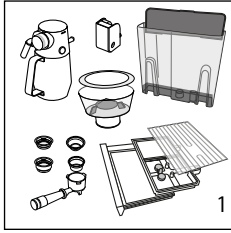

1. Wash and dry all accessories (including water tank) with warm water and washing-up liquid.

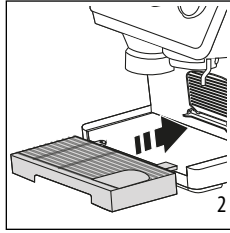

2. Insert the drip tray (A12) complete with cup grill (A10) and (A11).

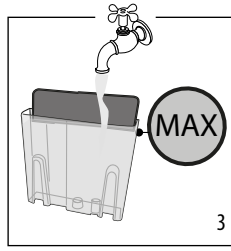

3. Remove the water tank (A16) and fill with fresh clean water\*, taking care not to exceed the MAX level.

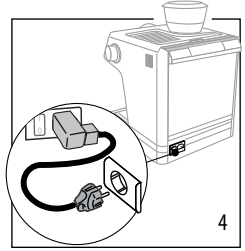

4. Plug the power cord connector (C9) into the socket (A17) at the back of the machine, then plug into the mains socket.

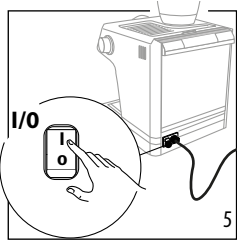

5. Make sure the main switch (A18) at the back of the machine is pressed and in the I position.

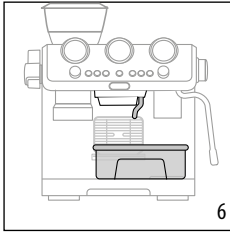

6. Place a container with a minimum capacity of 100 ml under the hot water spout (close to the coffee outlet (A8)).

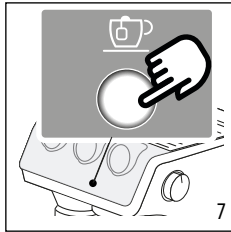

7. Press  (B7) to rinse.

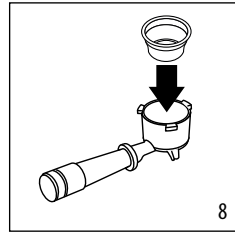

8. Insert the coffee filter in the portafilter (C1).

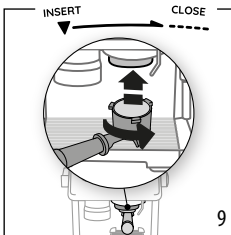

9. Attach the portafilter filter to the machine. To attach correctly, align the portafilter handle with the lower arrow, then turn the handle to the right until it is aligned in the "CLOSE" position.

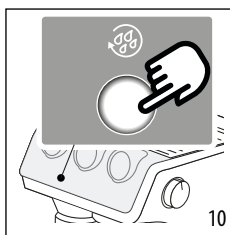

10. Place a container under the portafilter and frothing wand and press  (B6).

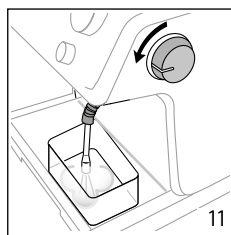

11. Open the steam dial (A5) to deliver steam for at least 5 seconds. For optimal steam performance we recommend you repeat this action 3 or 4 times. This is to purge the steam wand before frothing or steaming your milk.

### \* What water to use

- Potable fresh water is mandatory.
- Do not use sparkling (carbonated) or distilled water
- **Cold extraction technology:** before making cold brewed drinks, empty out the water tank (A16), rinse thoroughly and refill with fresh potable water.

### 3. COFFEE DELIVERY

#### Step 1-grinding

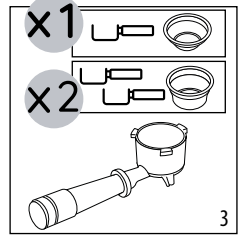
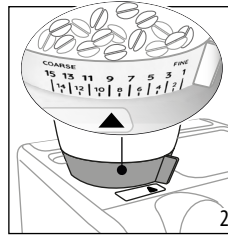
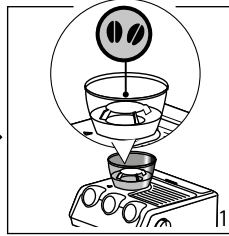
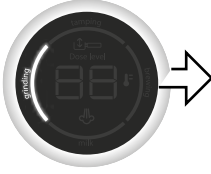

1. Add beans to beans container (A1) Fresh is best; fill in just with the quantity you need.
2. Check that the ground selector (A3) is set to 9 (factory setting).
3. Select 1-cup (C2) or 2-cups (C3) coffee filter and place in the portafilter (C1).

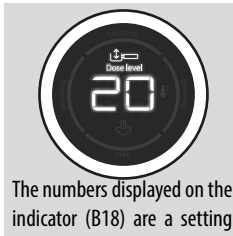
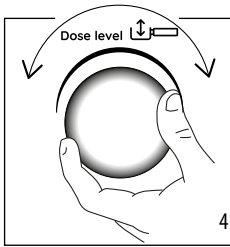

The numbers displayed on the indicator (B18) are a setting reference once the right level of coffee in the portafilter is reached. They do not correspond to grinder settings or to measurement units (gr/oz) or to grinding time. Refer to "3.1 Adjust dose" for suggestions.

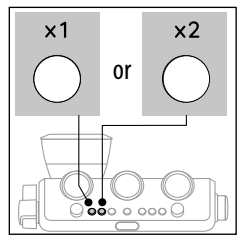
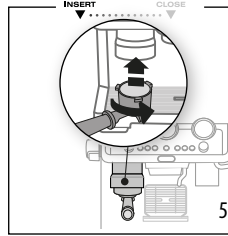

4. Set the dose level by adjusting the coffee dose dial (B1) starting from number "1" on the led module indicator (B18) ("1" corresponds to the min. position).
5. Attach the portafilter to the outlet of the coffee grinder (A19), aligning it with the lower arrow, then turn the handle to the right until it is aligned in the "CLOSE" position (▲).
6. When using the 1-cup filter (C2) or (C4), press the "X1" button (B2). When using the 2-cups filter (C3) or (C5), press the 2x button (B3): this will also double the quantity of espresso coffee delivered. The grinding step begins and stops automatically.

#### 3.1 Adjust dose

Each variety of coffee beans can behave differently during grinding and this is the reason why setting the dose at the beginning might require extra care.

With this illustration we give you some indications on how to regulate the dose. Please note these suggested setting ranges, based on the roasting level, are certainly a good starting point, but they might slightly vary depending on specific composition of your coffee beans.

1. Set the dose turning the "coffee dose dial" (B1) starting from the minimum position (number "1" on the "led module process" (B18)).
2. Look at which roasting level your coffee is and based on that, turn the dial slowly, referencing the ranges.

Step 2-tamping

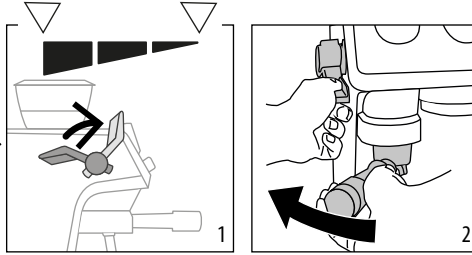
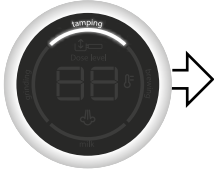

1. After grinding, pull the lever (A21) down fully (do not remove portafilter). For best results, repeat the tamping stroke twice turning the lever to the at-rest position each time.
2. Pull the portafilter out while the tamper is still down for polished finish of coffee. Once it is done, place back the lever in its original position.

3. Check the dose (see "3.2 Achieve perfect dose").

3.2 Achieve perfect dose

Under dose	★ PERFECT DOSE	Over dose
<ul style="list-style-type: none"> <li>• The coffee ground quantity in the filter is not enough.</li> <li>• To increase coffee quantity, turn clockwise the coffee dose dial (B1) to increase the number on the display (B18) one by one.</li> </ul>	<ul style="list-style-type: none"> <li>• The filter is filled up to the level of the mark</li> <li>• The coffee dose dial (B1) is correctly set</li> </ul>	<ul style="list-style-type: none"> <li>• Too much ground coffee in the filter.</li> <li>• Next grinding, reduce the coffee quantity by turning anti-clockwise the coffee dose dial (B1) to decrease the number on the display (B18) one by one.</li> </ul>

### 3.3 Rinsing before preparing drinks

At every use of the machine is strongly recommended to run a hot rinse to purge the shower with the dedicated button (B6). In addition, when preparing a cold drink after a hot drink and viceversa the results in cup could not be at the ideal temperature: it is therefore recommended, before brewing, to run an additional rinse.

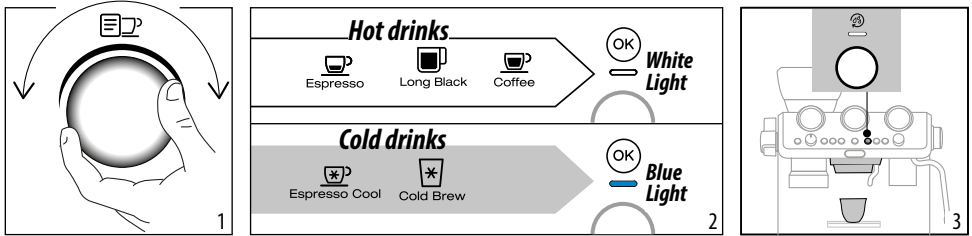

1. Select the beverage you want to prepare.
2. The OK light turns white if you selected a hot drink or blue if you selected a cold drink.
3. Press the  button: hot or cold water runs from the coffee outlet (A8) (in this way the coffee circuit will heat up or cool down).

### Step 3-brewing

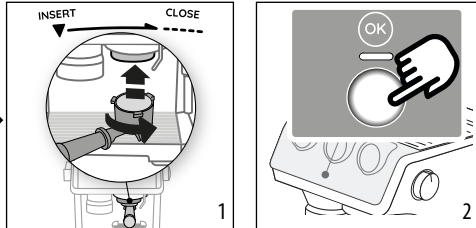
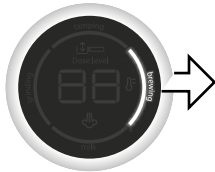

1. Attach the portafilter (C1) to the coffee outlet (A8).
2. Press OK (B5) to start

## 4. ACHIEVE ESPRESSO PERFECTION

Extracting the perfect espresso is an art and might take a couple of tries. Be ready to adjust the coarseness of the grind and always make sure to have the tamped ground coffee at the indicator line in the filter (perfect dose) to be able to reach perfect extraction.

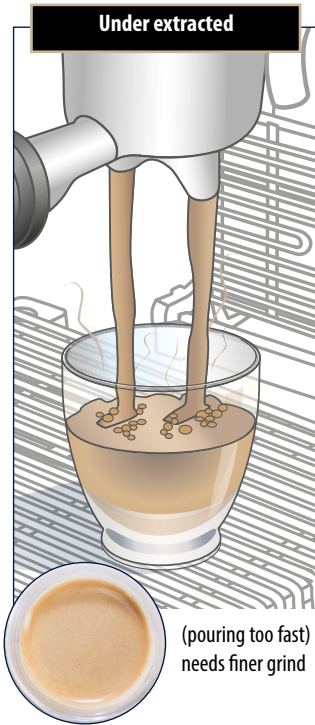

- Flowing fast like water
- Light and pale Crema

### To make it perfect:

- Adjust grinding setting to a finer setting 1 step at a time.

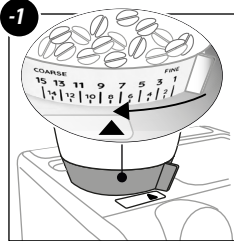

- Make sure ground coffee quantity reaches the “perfect dose”: if not, adjust the coffee dose dial (B1) (see “3.2 Achieve perfect dose”).

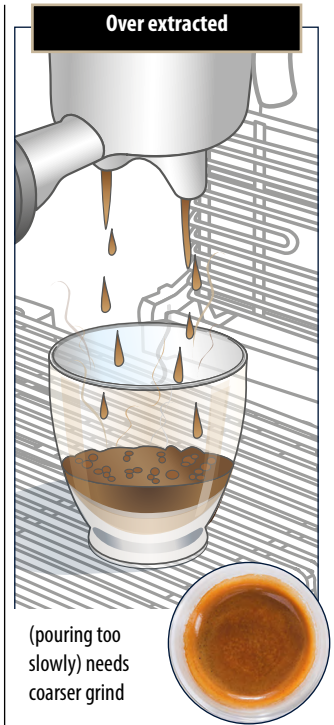
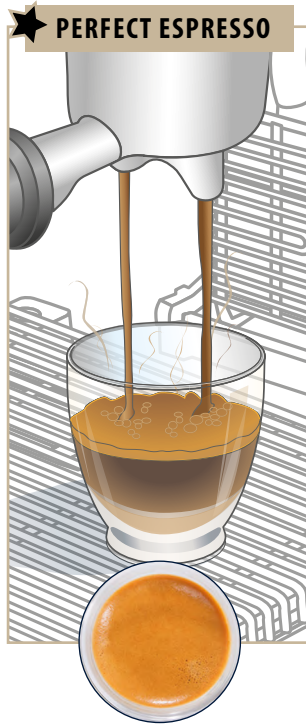

- Flowing in drips or not at all
- Crema very dark and not uniformed

### To make it perfect:

- Adjust grinding setting to a coarser setting 1 step at a time.

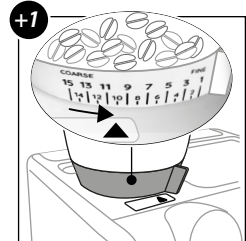

- Make sure ground coffee quantity reaches the “perfect dose”: if not, adjust the coffee dose dial (B1) (see “3.2 Achieve perfect dose”).

## 5. ESPRESSO COOL DELIVERY

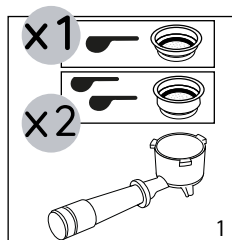

1. Insert the dedicated filter for Espresso cool (C4) or (C5).

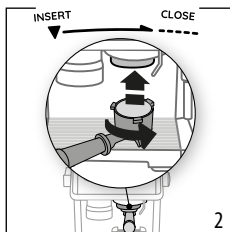

2. Proceed preparing the perfect dose (see "3. Coffee delivery" Steps 1- grinding & 2- tamping), then attach the portafilter (C1) to the coffee outlet (A8).

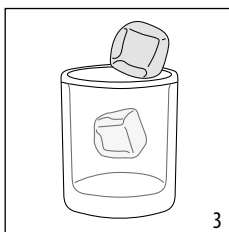

3. Add 1 or 2 ice cubes in the glass.

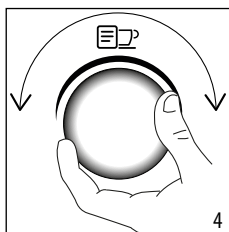

4. Select "Espresso cool".

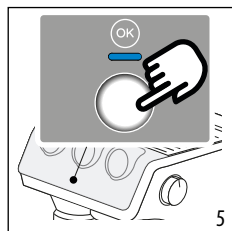

5. Press OK (B5) to start brewing (OK turned blue to indicate that a cold drink is selected). Coffee delivery stops automatically.

### Please note:

- **Cold Extraction Technology:** Fresh water is best: be sure the water in the tank (A16) is fresh. If the water is a couple of days old, empty and rinse the water tank thoroughly.

## 6. COLD BREW DELIVERY

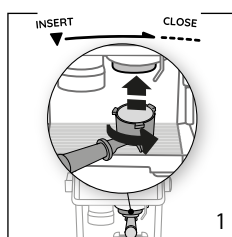

6. Proceed preparing the perfect dose (see "3. Coffee delivery" Steps 1- grinding & 2- tamping), then attach the portafilter (C1) to the coffee outlet (A8).

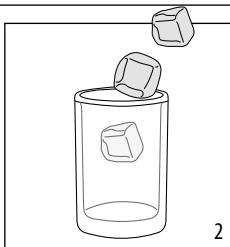

7. Add 2 or 3 ice cubes in the glass

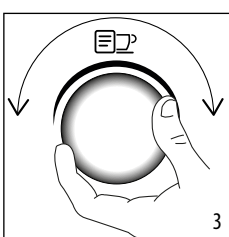

8. Select "Cold brew" by turning the drink selector dial (B9).

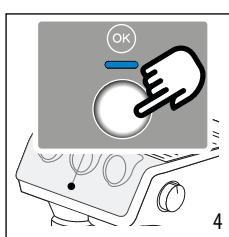

9. Press OK (B5) to start brewing (OK turned blue to indicate that a cold drink is selected). Coffee delivery stops automatically.

### Please note:

- As no pressure is produced to brew this drink, the pressure gauge (B14) will not turn to a higher position.
- **Cold Extraction Technology:** Fresh water is best: be sure the water in the tank is fresh. If the water is a couple of days old, empty and rinse the water tank thoroughly. Potable fresh water is mandatory.

## 7. MAKING MILK DRINKS

### Manual frothing

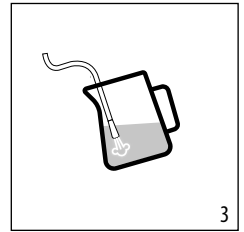
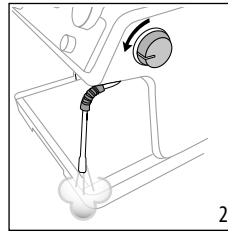
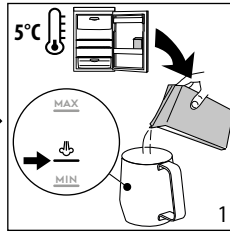
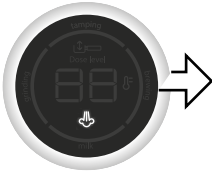

1. Fill the milk container (D8) with fresh cold milk from the refrigerator (5°C) up to . Milk will up to triple in volume.
2. Turn the steam dial (A5) on briefly to purge condensation. Make sure the steam wand (A6) is pointing away from you.
3. To make the froth, put the nozzle on the surface of the milk and air will catch by the mixing of milk and steam.

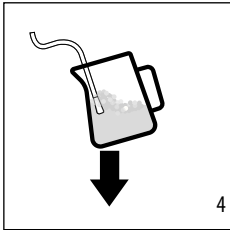

4. Keep the steam nozzle just on the surface, careful not to make big bubbles by letting too much air in.
5. Insert the steam nozzle just under the milk: this create a vortex. Once the desired temperature is reached turn the steam dial (A5) off and wait till steam stops completely before removing the milk container.

### Cleaning the steam wand (A6)

1. After every use, remove with a soft damp cloth any milk residues from the steam wand. For perfect cleaning, we recommend Eco MultiClean: it ensures hygiene by removing milk proteins and fats and can be used to clean the whole machine.
2. Use the steam for a deeper cleaning.
3. To maintain the better usability of the steam wand, we suggest to use the cleaning accessory (C15) for opening the hole of the nozzle.

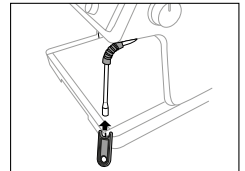
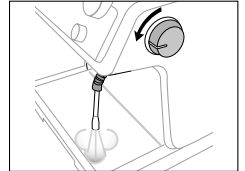
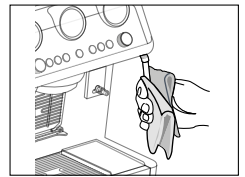

### Barista tips:

- Fresh cold whole milk is recommended for best results. Dairy and Non Dairy alternatives will vary in ease of texturing depending on type.
- After foaming milk, eliminate unwanted bubbles by swirling the milk container (D8).

### Automatic milk beverages

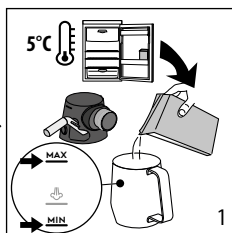
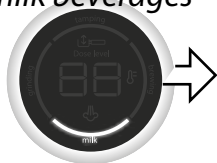

1. Fill the milk container (D8) with fresh cold milk from the refrigerator (5°C).



2. Close with the lid (D1).

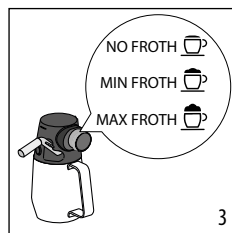

3. Turn the knob (D5) to select the desired froth.

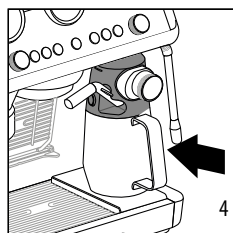

4. Attach the Lattecrema to the machine's connection (A7).

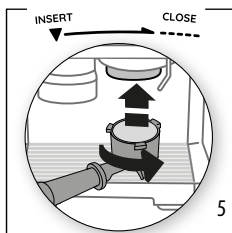

5. Prepare the perfect dose (see "3. Coffee delivery"-Steps 1- grinding & 2- tamping) and attach the portafilter.

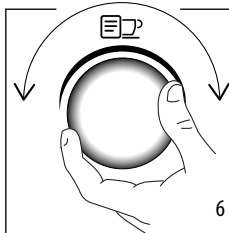

6. Select your drink.

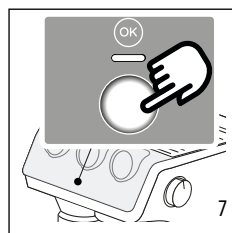

7. Press OK (B5) to start brewing. The appliance automatically brews coffee and milk in sequence.

### Cleaning Lattecrema after every use

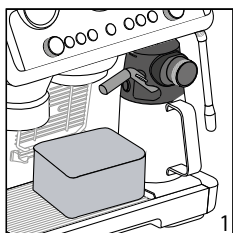

1. Leave the Lattecrema in the machine (you do not need to empty it). Place a cup or other recipient under the frothed milk spout (D4).

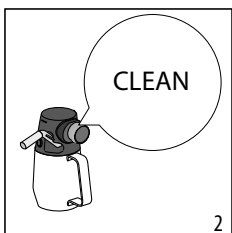

2. Turn the froth selection knob (D5) to "Clean".

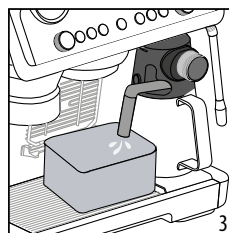

3. Cleaning automatically starts and stops.  
**Watch out:** Remember, after cleaning, to turn the knob back on foam setting.

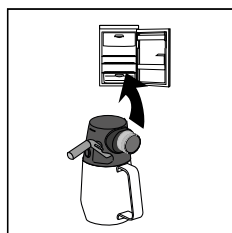

4. Remove the Lattecrema and put it in the refrigerator keeping in mind the following suggestions:

### Preparing several drinks in succession:

- Every time a milk-based drink has been prepared, the “Milk clean light” (B11) turns on to indicate that the carafe has to be cleaned (Clean function). Proceed with cleaning of the carafe after the final preparation.

### After multiple preparations, the milk container is empty or the milk that remains is not enough to make further drinks

- Having carried out the cleaning step (“Clean” function), disassemble the milk carafe and clean all components, proceeding as described in section “8.3 Thorough cleaning of Lattecrema”

### After multiple preparations, there is enough milk left in the container to make further drinks

- Having carried out the cleaning step (“Clean” function), remove the milk carafe and put it straight in the refrigerator. The carafe containing milk can be kept in the refrigerator no more than 2 days, after which time all components should be cleaned as described in the section “8.3 Thorough cleaning of Lattecrema”.

#### **Important:**

If the milk carafe is left out of the refrigerator for more than 30 minutes, disassemble and clean all components, proceeding as described in the section “8.3 Thorough cleaning of Lattecrema”.

### Following preparation of milk-based drinks — general notes:

- If the milk carafe is not cleaned, the “Milk clean light” (B11) stays on as a reminder that cleaning is required. To start the function, see “Cleaning Lattecrema after every use”
- In certain cases, the machine will need to heat up before cleaning can take place.
- Wait until the Clean function has finished, to ensure it is completed correctly. The function is automatic. It must not be stopped while in progress.

**Please note:** For perfect cleaning, we recommend Eco MultiClean: it ensures hygiene by removing milk proteins and fats and can be used to clean the whole machine.



## 8.1 Milk recipes



Drink	Recommended knob position	Approx. Quantity (ml)	X2 (ml)
Cappuccino	MED	150	230
Flat White	MIN	150	230
Latte	MED-MIN	250	330

- **Double dose milk drinks:** Fill the milk container with a sufficient quantity of milk, not exceeding the MAX level marked on the container (D8). Each mark on the side of the container corresponds to about 100 ml/ 3.38 fl oz of milk.
- Using fresh cold full cream milk will achieve the best results.

## 8.2 Milk froth knob positions:

	<b>CLEAN</b>	<b>MAX Froth</b> 	<b>MED Froth</b> 	<b>MIN Froth</b> 		<b>INSERT</b>
	To clean LatteCrema System after each use					To extract or insert the froth selection knob (D5)

### 8.3 Thorough cleaning of Lattecrema

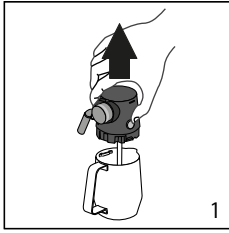

1. Push the release button (D3) and lift the milk container lid (D1);

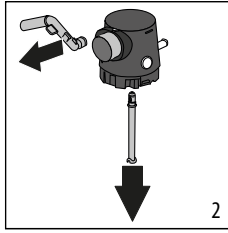

2. Remove the milk spout (D4) and milk intake tube (D7);

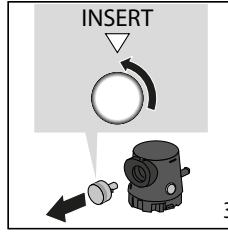

3. Turn the froth selection dial (D5) to "Insert" position and extract it.

4. Wash in a dishwasher (recommended) or by hand, as indicated below:

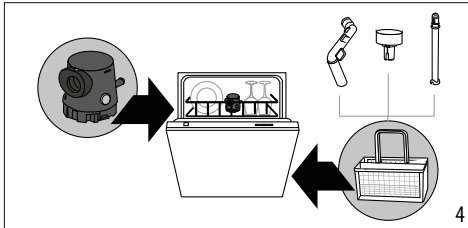

- **In a dishwasher:** Rinse all components with warm drinking water (at least 40 °C): place the lid of the carafe in the top basket of the dishwasher, standing upright on its edge, and the smaller detachable parts (outlet tube, intake tube, dial) in the cutlery basket. Run a wash program at 50 °C e.g. Eco Standard

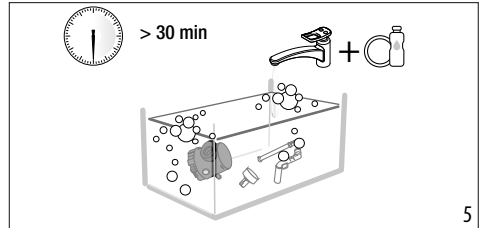

- **By hand:** Rinse all components carefully with warm drinking water (at least 40°C) to ensure that all visible residues are removed: make sure the water passes through the holes. Immerse all components (including the milk container) in a solution of warm drinking water (at least 40°C) and washing-up liquid for at least 30 minutes. Rinse all components thoroughly with warm drinking water, rubbing them individually between fingers and thumbs.

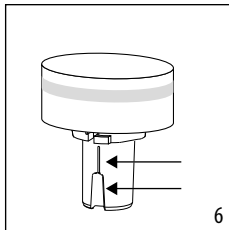

5. Make sure there are no milk residues left in the cavity and the channel on the underside of the dial. If necessary, scrape with a toothpick.

6. Check that the intake tube and the outlet tube are not clogged with milk residues;











7. Dry the components with a clean dry cloth;







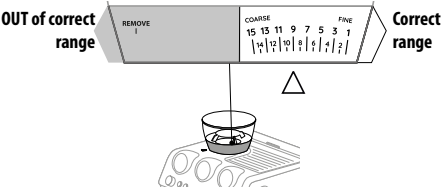





8. Reassemble all components of the milk carafe.

**Please note:**

The machine will give a reminder periodically of the need for thorough cleaning of the milk carafe, and indicate the full sequence of steps.

## 8. EXPLANATION OF LIGHTS

LIGHTS	EXPLANATION OF LIGHTS	OPERATION
All the lights flash briefly	Turning the machine on	Self-diagnosis
 permanently on	The appliance is being turned on for the first time and the water circuit must be filled	Proceed as described in section "2. Preparing your machine for first use"
 on	Energy saving is enabled	If you want to disable the function, see section "9. Menu settings"
 on (orange)	The beans container (A1) is empty	Fill the beans container
 flashing (orange)	You are trying to grind coffee but the beans container (A1) is empty	Fill the beans container
 on	Insufficient water in tank (A16) or water tank not inserted correctly	Fill the tank or extract the tank and put it back correctly
 flashing	You are trying to deliver a drink but water tank (A16) is empty	Fill the tank
 on (red)	General alarm	Contact Customer Services
 on (orange)	The coffee outlet (A8) requires cleaning	
 on (red)	The finess of the grind selector (A3) is incorrect (or out of correct range) (see picture above)	Move the selector within the 15 levels from coarse to fine, keeping in mind to: <ul style="list-style-type: none"> <li>• Always adjust the coffee grinder during the grinding</li> <li>• Adjust one grinding level at a time and make at least 5 coffees before adjusting again</li> </ul>
	The coffee beans container (A1) is not completely insert: the machine does not work for safety reasons	Check that the bean container is completely locked (see fig. 5 - section "11.6 Cleaning the beans container housing")
		
 flashing (red)	You started grinding but the finess of the grind selector (A3) is incorrect (or out of correct range) (see picture above)	Move the selector within the 15 levels from coarse to fine, keeping in mind to: <ul style="list-style-type: none"> <li>• Always adjust the coffee grinder during the grinding</li> <li>• Adjust one grinding level at a time and make at least 5 coffees before adjusting again</li> </ul>
	You started grinding but the coffee beans container (A1) is not completely insert: the machine does not work for safety reasons	Check that the bean container is completely locked (see fig. 5 - section "11.6 Cleaning the beans container housing")
...→		

LIGHTS	EXPLANATION OF LIGHTS	OPERATION
 on (red)	After every use, the Lattecrema must be cleaned	When all the milk drinks are ready, proceed with automatic cleaning turning the knob (D5) to Clean
 on	The appliance is on and ready for use	The appliance is at the right temperature to deliver steam. To deliver steam, turn the steam dial (A5)
 flashing	The appliance is on and energy saving is enabled. The steam dial (A5) is in the steam delivery position	The light flashes to indicate that the appliance is preparing to deliver steam. Delivery begins as soon as the appliance is at temperature
	The appliance is heating up to be ready for use	The appliance is at temperature when the light remains on steadily
	The appliance is delivering steam	
 on (orange)	Descaling must be performed	Descale the appliance as described in section "13. Descaling"
 flashing (orange)	Descaling is underway	Complete the operation as described in section "13. Descaling": the light comes white when the rinsing cycle of descaling is underway
 on (white)	The rinsing cycle of descaling must be performed	
 flashing (white)	The rinsing cycle of descaling is underway	
 flashing (white)	The hot active rinse is underway	
 flashing (blue)	The cold active rinse is underway	
 +  flashing	If the water softener filter is present, an air bubble may have been released inside the circuit, obstructing delivery	Press the button (B7) corresponding to the  light. Delivery begins and stops automatically.
	The grinding is too fine and the coffee is delivered too slowly or not at all	Extract the portafilter (C1) and repeat the operations to make the perfect dose ( see "3.1 Adjust dose" and "3.2 Achieve perfect dose").
	The coffee filter is blocked.	Rinse the filters under abundant running water or by Active Rinse function (B6).
	The water tank (A16) has been inserted incorrectly and the valves on the bottom are not open	Press the water tank down lightly to open the valves on the bottom
	Scale in the water circuit	Descal as described in section "13. Descaling"
 blinking	The funnel of the coffee grinder is clogged	Clean as described in section "11.9 Cleaning the "Smart tamping station"". If the problem persists, access the funnel by opening the flap (A20) and clear the blockage using the tube brush (C10)
		Check that the coffee filter being used matches the number of cups selected
		Reduce the coffee dosage by turning the dial (B1)

## 9. MENU SETTINGS

**1. Enter the setting menu:** press both buttons for 3 seconds, until light changes

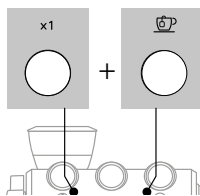

**2. Select the setting:** select the drink corresponding to the setting you want to check and/or change

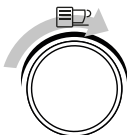

Drink	Corresponding setting	How to enter & change	Reference on the Led module process (B18)
Espresso	Extra grinding adjustment <i>Enable extra time in the grinder only to compensate wear (see "Efficient grinding")</i>	Press  to enter and press again to change	= OFF = ON
Long Black	Water hardness	Press  to enter and press again to display the number shown corresponding to the squares in the water hardness text	
Coffee	Auto off	Press  to enter and press again to change	= 5 minutes = 90 minutes = 180 minutes
Flat White	Energy saving	Press  to enter and press again to change	= OFF = ON
Latte	Beep	Press  to enter and press again to change	= OFF = ON
Cappuccino	Reset to default values	Keep pressed the <b>OK</b> button for 5 seconds to reset	--
Espresso Cool  Cold Brew	Statistics	Press <b>OK</b>	See chapter "How to read the statistics"

**3. Save new settings by pressing the OK button (B5)** (After 30 seconds of inactivity, the machine will automatically exit the settings menu).

## 10. CUSTOMISING THE QUANTITY OF COFFEE DRINKS

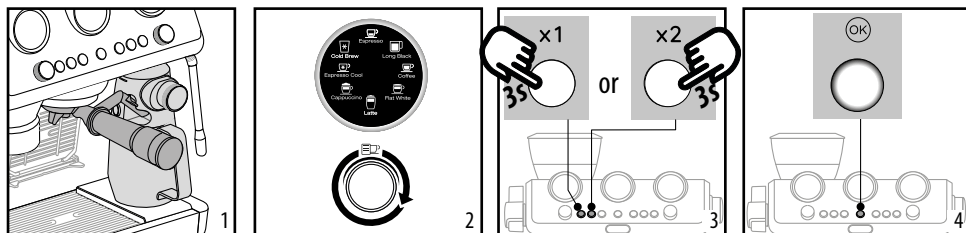

1. Prepare the appliance to deliver the drink you want to make. Prepare the perfect dose ("3.1 Adjust dose" and "3.2 Achieve perfect dose") and attach the portafilter (C1) to the coffee outlet (A8): if you have to customize a milk based drink, prepare and attach the Lattecrema .
2. Turn the dial (B9) to select the drink to be programmed.
3. Press the 1-cup or 2-cup button "1x" (B2) or "2x" (B3) and hold for at least 3 seconds, until the indicator for the selected drink starts blinking to confirm that the machine is in programming mode.
4. Press the OK button (B5) to start delivering the drink. The lights corresponding to the OK button flashes.

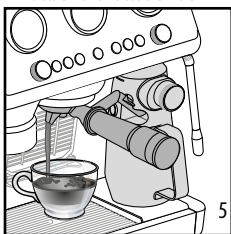

5. When you have reached the desired quantity of the drink, press the OK button again. If the recipe includes another ingredient, it starts delivery: when you have reached the desired quantity, press the OK button again.

### Please note:

- Drinks can be programmed, but the delivery of steam and hot water can not.
- Programming changes the quantity of drinks delivered, but not of ground coffee.
- When a programmed drink is selected, the corresponding indicator blinks briefly.
- After 30 seconds of inactivity, the machine will automatically exit the programming mode.
- **My LatteArt** is not programmable.

Coffee Recipe	Default quantity (ml)	Programmable quantity (ml)
Espresso	≈ 35	from ≈ 15 to ≈ 90
Espresso X2	≈ 70	from ≈ 30 to ≈ 180
Coffee	≈ 80	from ≈ 50 to ≈ 120
Coffee X2	≈ 160	from ≈ 120 to ≈ 240
Long Black	≈ 100	<ul style="list-style-type: none"> <li>• water: from ≈ 25 to ≈ 120ml</li> <li>• espresso: from ≈ 25 to ≈ 60 ml</li> </ul>

Coffee Recipe	Default quantity (ml)	Programmable quantity (ml)
Long Black X2	≈ 200	<ul style="list-style-type: none"> <li>• water: from ≈ 50 to ≈ 240 ml</li> <li>• espresso: from ≈ 50 to ≈ 120 m</li> </ul>
Cold Brew	≈ 110 / 3.72	≈ 90 to ≈ 130
Cold Brew 2x	≈ 180 / 6.08	≈ 160 to ≈ 220
Espresso Cool	≈ 40/ 1.35	≈ 30o ≈ 50
Espresso Cool 2X	≈ 80 / 2.70	≈ 60 to ≈ 110







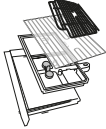
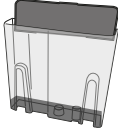

## 11. CLEANING AND MAINTENANCE

### Important!

- Do not use solvents, abrasive detergents or alcohol to clean the coffee machine.
- Do not use metal objects to remove encrustations or coffee deposits as they could scratch metal or plastic surfaces.
- If the appliance is not used for more than a week, before using it again, we recommend you perform a rinse cycle.

### Danger!

- While cleaning, never immerse the coffee maker in water. It is an electrical appliance.
- Before cleaning the outside of the appliance, turn it off, unplug from the mains socket and allow to cool.

					
	×	✓	×	×	×
ECO MULTICLEAN 	✓	×	×	×	×
	✓	×	×	✓	×
	×	✓	✓	✓	✓
	×	✓	✓	×	✓

### 11.1 Cleaning the drip tray

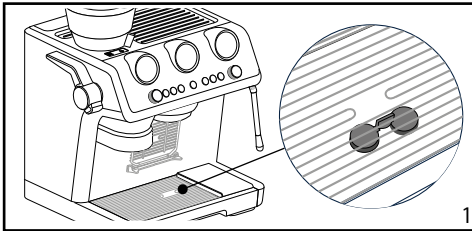

1. The drip tray is fitted with a level indicator (A13) showing the amount of water it contains. Before the indicator protrudes from the cup grille (A10), the drip tray (A12) must be emptied and cleaned, otherwise the water may overflow the edge and damage the appliance, the surface it rests on or the surrounding area.

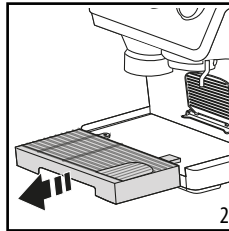

2. Remove the drip tray.

3. Remove the cup grilles (A9) and level indicator (A13), empty the water and clean all the components with a cloth, then reassemble the drip tray. All the components are dishwasher safe.
4. Put the drip tray back in place.

### 11.2 Cleaning the espresso cup grille

1. Extract the grille (A9) by pulling it from the left, then removing it from the support. Clean the support with a cloth and wash the grille (dishwasher safe).
2. Put the grille back on the support from the right side, then push until it is correctly attached.

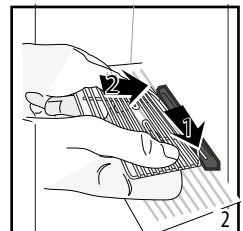
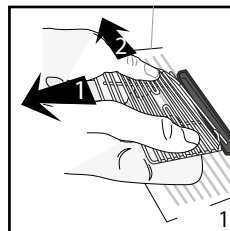

### 11.3 Coffee filters (C2) and (C3) cleaning and maintenance

The filters must always be clean with warm water and washing up liquid and free from all coffee residues.

Always rinse the filters under abundant running water or by Active Rinse function (B6).

### 11.4 Cleaning the "Espresso Cool" filters (C4) and (C5)

These filters have been developed to deliver optimal extraction results with this recipe. The filters must always be clean with warm water and washing up liquid and free from all coffee residues.

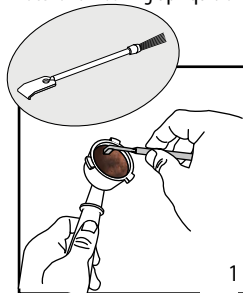

1. After using the appliance, use the scraper tool (C11) to remove the exhausted coffee dose.

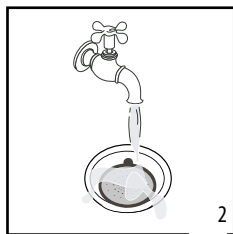

2. Always clean and rinse the filters under abundant running water.

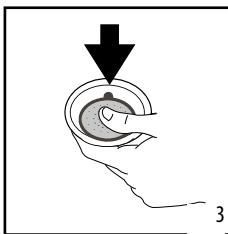

3. Push the perforated filter to make sure it is always correctly inserted in its housing.

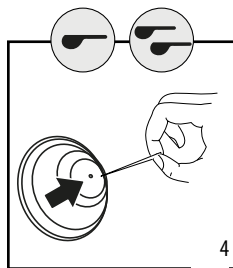

4. Make sure the hole underneath is free from all residues. If still dirty, and in any case always at least once a month, clean the coffee filters thoroughly:

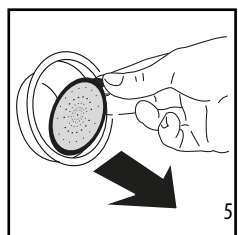

5. Extract the perforated filter by pulling the tab.

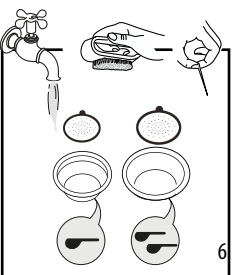

6. Rinse the filters under running water.

7. Make sure the holes are not blocked. If necessary, clean with a pin.).

8. Dry all the components with a cloth.

9. Put the perforated filter back in the housing and press as far as it will go.

### 11.5 Cleaning of the coffee outlet

When the  light comes on (orange) (B12), you have to proceed cleaning the coffee circuit. To run the cleaning, you have to purchase dedicated cleaning tabs for coffee makers. For more info, please visit [Delonghi.com](http://Delonghi.com).

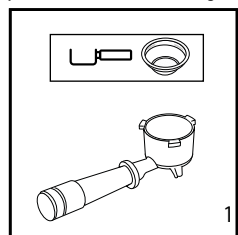

1. Insert the 1-cup coffee filter (C2) in the portafilter (C1).

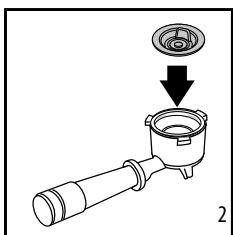

2. Put on the coffee filter the special disk accessory (C13) and press it to the bottom.

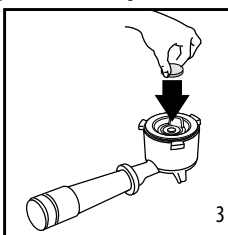

3. Put on the accessory the cleaning tab.

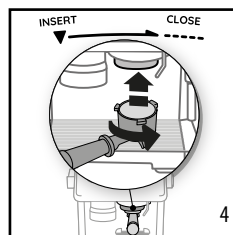

4. Attach the portafilter to the coffee outlet (A8).



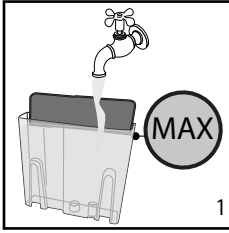

## Cleaning of the coffee outlet

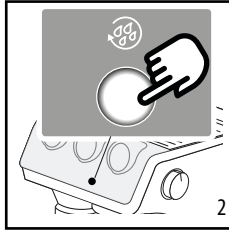

5. Fill the water tank (A16). Make sure the drip tray (A12) is empty.



6. Keep pressed the  button (B6), until the related light start blinking (white). After few minutes the cleaning stops automatically.

- Remove the portafilter (C1) and the cleaning disk accessory (C13).
- Wash the portafilter (C1) and the filter under tap water;
- Insert the portafilter (C1) again and make a rinse by pressing the  button (blue) (B6): we suggest to put a container under the portafilter.
- Remove and empty the drip tray (A12).

### **Please note:**

This procedure can start by pressing the  button (B6) for some seconds. To delete this option, press the same button for 10 seconds.

## 11.6 Cleaning the beans container housing

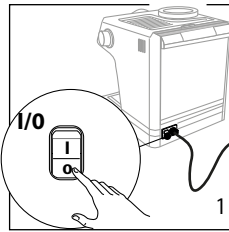

1. Turn the machine off.

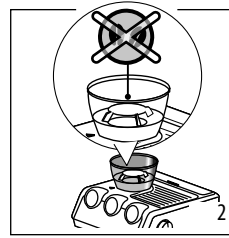

2. Make sure the beans container (A1) is empty. If necessary, operate the coffee grinder without beans to empty it.

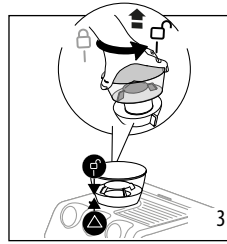

3. Release the beans container by turning it anticlockwise and extract from the appliance.

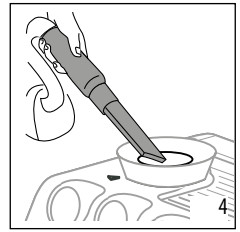

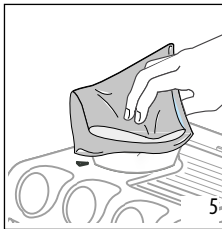

4. Remove coffee residues using a vacuum cleaner.

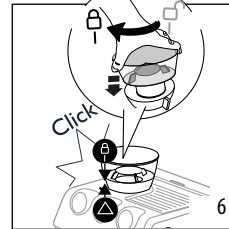

5. Clean the beans container housing with a damp cloth and dry.



6. Put the container back inserting it in the coffee grinder. The container is correctly inserted when the arrow  is lined up with the  symbol and you hear a "click".

## 11.7 Cleaning the burr

When cleaning the beans container (A1), clean the container housing and upper burr with a damp cloth. The burr can be removed and replaced by an authorised customer services centre.

You may also need to remove the burr if it becomes blocked with foreign matter. If this occurs, remove the beans container and clean as follows:

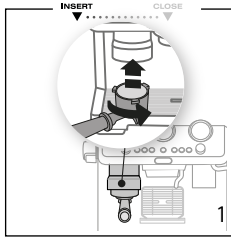

1. Attach the portafilter (C1) and operate the grinder without beans to free the coffee funnel.

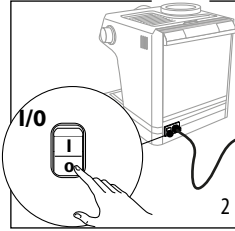

2. Turn the machine off.

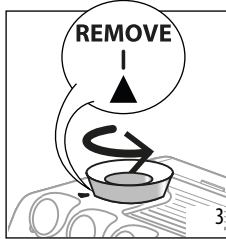

3. Turn the grind selector (A3) anticlockwise as far as it will go to the "REMOVE" position.

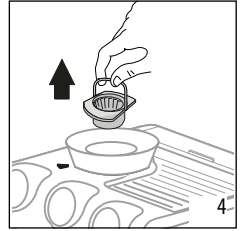

4. Extract the upper burr, gripping it by the handle.

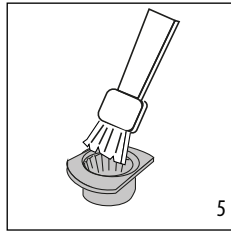

5. Clean the burr with a brush (not included) and remove the coffee residues using a vacuum cleaner.

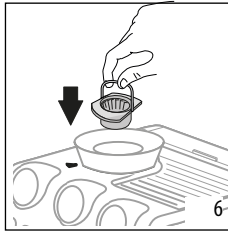

6. Put the upper burr back in place.

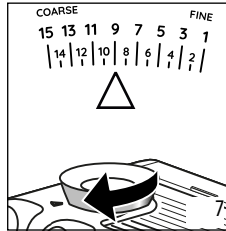

7. Turn the grind selector to select the desired grinding level.

Make sure the burr is inserted correctly by pulling it by the handle. If it is correctly inserted, it will not move.

## Efficient grinding

The burrs are subject to wear over time. This means that with continuous and regular use, the dial (B1) will need to be turned toward the higher numbers in order to obtain the perfect dose. Once a setting of between 30 and 40 has been reached, the extra grinding range becomes necessary (see section "9. Menu settings" – "Extra grinding adjustment").

When the quantity of ground coffee becomes less than expected, contact a service centre to have the burrs replaced. With the new burrs fitted, adjust the coffee grinder by accessing the settings menu and selecting the first range of the extra grinding adjustment. Now turn the quantity adjustment dial (B1) to the Min position and set the quantity as for first-time use (see "3.2 Achieve perfect dose").

## 11.8 Replacing the burrs

When the quantity of coffee becomes even less, contact a customer services centre to have the burrs replaced, then adjust the grinder again as follows entering the setting menu ("9. Menu settings") and selecting the first range of the "Extra grinding adjustment".

Then turn the ground coffee quantity dial (B1) to minimum position and set the dose like a first use (see "3.2 Achieve perfect dose").

### 11.9 Cleaning the “Smart tamping station”

1. Clean the attachment area with a brush;
2. Pull the lever (A21) as far as it will go and clean the presser cylinder with a brush. Then release the lever.
3. Use the tube brush (C10) to clean the coffee funnel.

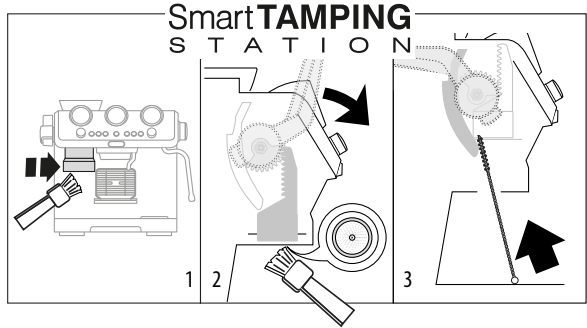

### 11.10 Water tank

Periodically (about once a month) clean the water tank (A16).

1. Take out the water tank and rinse with drinking water;
2. Empty the water tank and clean with warm water (40°C/104°F approx), wiping if necessary with a clean, non-abrasive cloth. Rinse thoroughly under running water;
3. Fill the water tank with fresh drinking water up to the MAX level and return it to the machine.

**Please note:**

If the machine has not been used for more than 3 days, clean the water tank as described above.

### 11.11 Cleaning circuit of the machine

If the machine has not been used for more than 3-4 days, it is strongly recommended to run 3 hot rinses as follows:







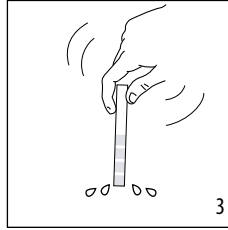
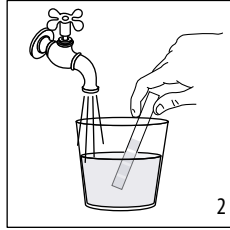
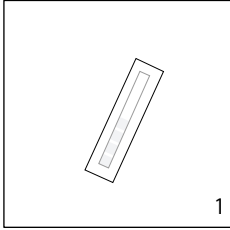



1. Place a container under the coffee outlet (A8);
2. Check the “OK” light (B5) is white (ready for hot preparation): if not, select a hot coffee preparation by turning the drink selector dial (B9)
3. Press the  button: the rinse stops automatically.
4. Repeat 2 more times.

## 12. WATER HARDNESS

The  descale light (B8) comes on after a period of time established according to water hardness. The machine can also be programmed according to the actual hardness of the water supply in the various regions, in which case descaling may be required less frequently.



1. Remove the "TOTAL HARDNESS TEST" indicator paper (C6) from its pack.
2. Immerse the paper completely in a glass of water for one second.
3. Remove the paper from the water and shake lightly.
4. After about a minute, 1, 2, 3, or 4 red squares form, depending on the hardness of the water. Each square corresponds to one level.
5. Set the appliance as indicated in section "9. Menu settings".

Total Hardness Test result	Level (displayed on the led module process (B18))
	 pure water
	 soft water
	 medium water
	 hard water
	 very hard water

### 13. DESCALING

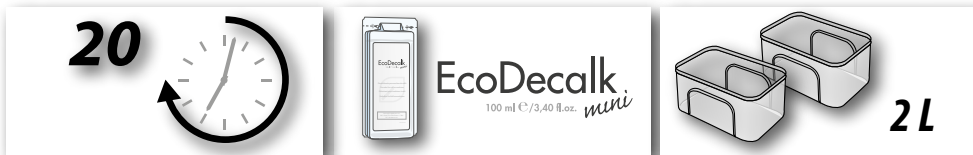

**Please note**

- Before use, read the instructions and the labelling on the descaler pack.
- It is important to use De'Longhi descaler only. Using unsuitable descaler and/or performing descaling incorrectly may result in faults not covered by the manufacturer's guarantee.
- Descaler could damage delicate surfaces. If the product is accidentally spilt, dry immediately.

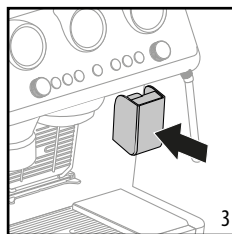
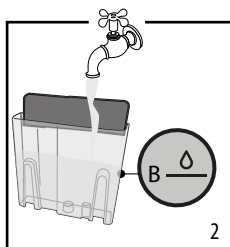
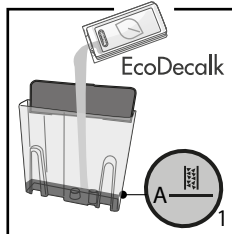
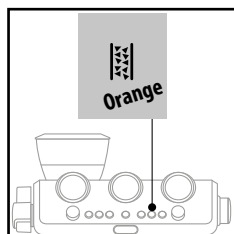

Descalc the appliance when the  light (B8) comes on (orange).

**Please note**

- If you want anticipate the cleaning cycle, press the descaling button (fig. 5) for 3 seconds.
- In case you start the descaling cycle by mistake, you can press the descaling button (fig. 5) for 10 seconds; the rinsing cycle can not be stopped (from step 9).

1. (IF PRESENT, REMOVE THE WATER SOFTENER DEVICE). Pour the descaler into the tank up to the level  A marked inside the tank (equal to one 100ml packet).

2. Add water (1 liter) up to the level  B. Then put the water tank back in the appliance.

3. Insert the dedicated accessory (C8) to the Latte Crema connection (A7).

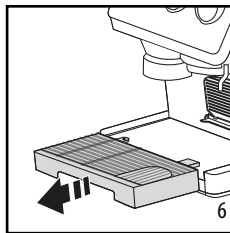
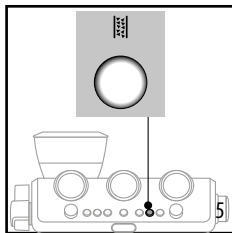
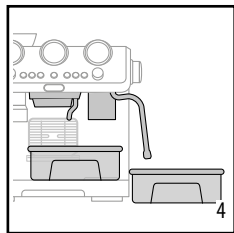

4. Make sure the portafilter is not attached and position a recipient under the coffee outlet, hot water spout and the other recipiente under the steam wand.

5. Keep pressed the  button until the corresponding light begins to blink: descaling starts.

6. Extract and empty the drip tray, then put back in the applianc

7. The descale programme starts and the descaler liquid comes out of the steam wand and coffee outlet. The descale programme removes limescale deposits from inside the appliance by automatically performing a series of rinses and pauses until the tank is empty.

See next page



## DESCALING

Delivery stops and the  light turns to white. This indicates that it is necessary to proceed with rinsing: see next page.

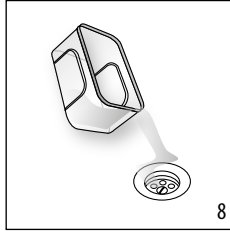

8. Empty the recipients used to collect the descaler solution and replace them empty.

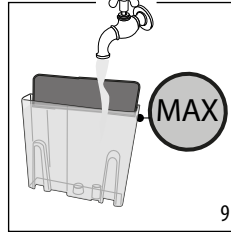

9. Remove the water tank, empty any residues of descaler solution, rinse with running water and fill with fresh water up to the MAX level. Put the tank back in its housing.

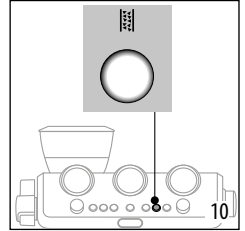

10. Keep pressed the  button until the corresponding light begins to blink: rinsing starts.

11. When rinsing is complete, delivery stops and the appliance prepares to be used again.

12. Empty the recipients used to collect the rinse water.

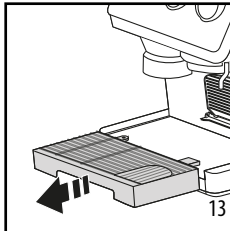



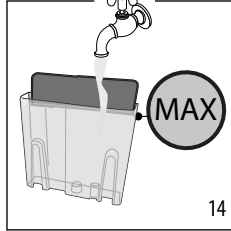

13. Extract and empty the drip tray, then put back in the appliance.



14. Empty, rinse, then fill the water tank with fresh water and replace it.

Now the appliance is ready to use.

## 14. TROUBLESHOOTING

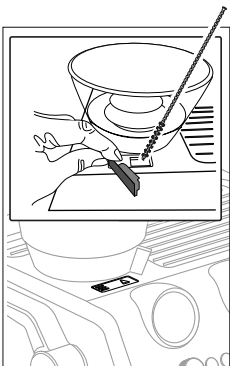

PROBLEM	CAUSE	SOLUTION
There is water in the drip tray (A12)	It is normal: due to the internal water circuits operations	Regularly empty and clean the drip tray
No espresso coffee is delivered	No water in the tank (A16)	Fill the tank
	The  light is on to indicate that the coffee or steam circuit is empty	Press the button corresponding to the  light to fill the circuit
	The coffee filter is blocked	Rinse the filters under abundant running water or by Active Rinse function (B6).
	The tank has been inserted incorrectly and the valves on the bottom are not open	Press the tank down lightly to open the valves on the bottom
	Scale in the water circuit	Descale as described in section "13. Descaling"
	Coffee grind too fine	Adjust coffee dose and grinding
The portafilter cannot be attached to the machine	The ground coffee has not been pressed or is too much	Repeat grinding with new settings. Reduce the powder quantity: check if the filter (single or double filter) is the same size as the selector of grinding quantity (1x or 2x button)
The espresso coffee drips from the edges of the portafilter rather than the holes	The portafilter is inserted incorrectly	Attach the portafilter correctly and rotate firmly as far as it will go
	The espresso boiler gasket has lost elasticity or is dirty	Have the espresso boiler gasket replaced by Customer Services
	The coffee filter is clogged	Rinse the filters under abundant running water or by Active Rinse function (B6).
The coffee crema is too light (delivered from the spout too fast)	The appliance settings need reviewing	Refer to coffee guide for suggestions
The coffee crema is too dark (delivered from the spout too slowly)	The appliance settings need reviewing	Refer to coffee guide for suggestions
No milk froth is formed when making cappuccino with Lattecrema	Milk not cold enough	Always use milk at refrigerator temperature
	The froth selection knob (D5) is not in the correct position	Check and turn to the right position the froth selection knob (  max froth;  med froth;  min froth )
	The Lattecrema is dirty	Clean the cappuccino maker as described in section "8.3 Thorough cleaning of Lattecrema"
	Scale in the water circuit	Descale as described in section "13. Descaling"
At the end of descaling, the appliance requests a further rinse	During the rinse cycle, the water tank has not been filled to the MAX level	Complete the rinse cycle from point (8) of section "13. Descaling"
		...→









PROBLEM	CAUSE	SOLUTION
The appliance does not grind the coffee	There is foreign matter that cannot be ground in the coffee grinder	Clean the burrs as described in section “11.7 Cleaning the burr”, making sure you remove all the beans from the beans container (A1) before extracting it. Before putting the burr back, vacuum all residues from the housing (fig.14)
	The coffee beans container is not in the right position	The container is correctly inserted when the arrow ▲ is lined up with the  symbol and you hear a “click”.
If you want to change the type of coffee	You must remove all the beans present in the machine	<ul style="list-style-type: none"> <li>• Empty the beans container (if necessary, operate the coffee grinder without beans or use a vacuum cleaner to remove any remaining beans)</li> <li>• Attach the portafilter and operate the coffee grinder a number of times without beans to free the grinder. Attach the portafilter to the outlet of the grinder (A19), lining it up with “INSERT”, then turning it to the right. Grinding begins when the portafilter reaches the CLOSE position and stops automatically. Repeat until the filter is empty</li> <li>• Place the new coffee in the beans container</li> <li>• If the amount of coffee ground is not enough to reach the perfect dose, proceed setting the appliance as for the first use</li> </ul>
<p>After grinding, the coffee filter is empty</p> <p>After tamping, there is too much coffee in the filter</p>	The coffee grinder coffee funnel is clogged	<p>Clean as described in section “11.9 Cleaning the “Smart tamping station””. If the problem persists, access the guide by opening the hatch and free it using the brush)</p> 
		...→



PROBLEM	CAUSE	SOLUTION
After grinding, the ground coffee in the filter does not reach the "perfect dose"	The "Smart Tamping Station" needs cleaning	Clean as described in section "11.9 Cleaning the "Smart tamping station"", then grind again
	The quantity of ground coffee needs adjusting	Adjust the quantity of coffee with the dial (B1). If the dial is already in the max. position, select the second range of grinding adjustment (see "9. Menu settings"- "Extra grinding adjustment"). If the problem persists, replace the burrs as described in section "11.8 Replacing the burrs"
	Over time the burrs wear down	Replace the burrs as described in section "11.8 Replacing the burrs"































## 15. HOW TO READ THE STATISTICS

When you contact the Customer Service Centre, the statistics info could be useful. Please follow this procedure:

- Enter the menu by pressing both buttons "x1" (B2) and  (B7) for 3 seconds;
- Turn the dial (B9) to select  Espresso Cool OR  Cold Brew ;
- Press the "OK" (B5);
- Once entered in the menu select the desired data rotating the drink selector dial (B9) according to the next chart:

Drink selection	Counter
 Espresso	Total count of Hot drinks
 Long Black	--
 Coffee	--
 Flat White	Total count of Steam preparations
 Latte	--
 Cappuccino	--
 Espresso Cool	Total count of Cold drinks
 Cold Brew	Total count of Descalings

- Check the lights corresponding to x1, x2, , OK,  to read the statistics:

Lights on control panel	Drink count	Descalc count
    	Up to 100	Up to 1
    	Between 100 - 1000	Between 2 - 10
    	Between 1000 - 3000	Between 10 - 30
    	Between 3000 - 6000	Between 30 - 60
    	Between 6000 - 11000	Between 60 - 110
    	More than 11000	More than 110

- After 30 seconds of inoperation, the machine automatically exits from the menu setting and it is ready to use.

## 16. TECHNICAL DATA

Voltage:	220-240 V~ 50-60 Hz
Power:	1600 W
Pressure:	1.9 MPa (19 bar)
Water tank capacity:	2,5l
Dimensions LxDxH:	360x365x470 mm
Weight:	16 kg
Beans container capacity:	250 g

De'Longhi reserves the right to modify the technical specification and styling of its products at any moment, without compromising their functionality and quality.

**Register Now**

[www.delonghi.com/register](http://www.delonghi.com/register)

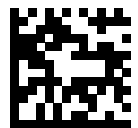

57132C9253\_00\_1024