

**⚠ WARNING!**

- **Risk of child entrapment. Before you throw away your old appliance:**
- Take off the doors.
- Leave the shelves in place so that children may not easily climb inside. Cut the connection cable (as close to the appliance as you can).
- If this appliance you are replacing features a spring lock (latch) on the door or lid, be sure to make that spring lock unusable before you discard the old appliance. This will prevent it from becoming a death trap for a child.

# DEVANTI

## Instruction Manual

**BF-D-98L-BK(SC-98B)**

**BF-D-130L-BK(SC-130B)**

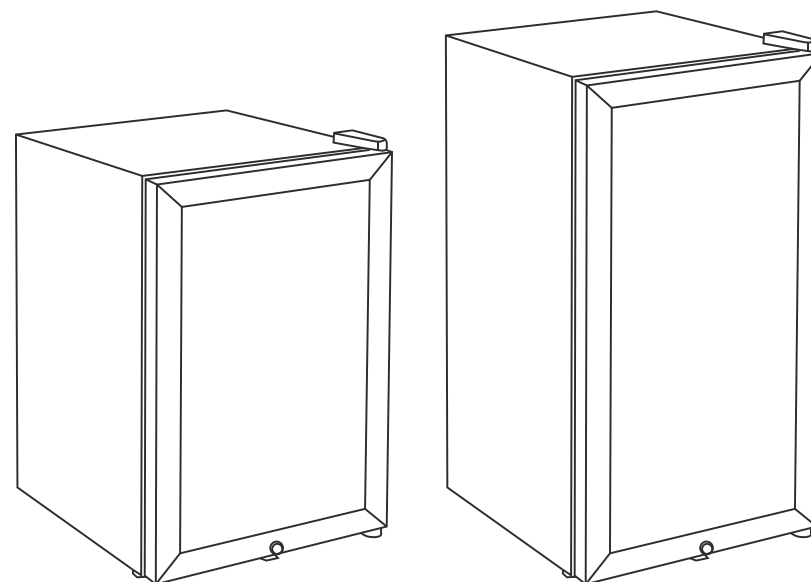

## Important Safeguards

### READ ALL INSTRUCTIONS

Read this manual thoroughly before first use, even if you are familiar with this type of product. The safety precautions enclosed herein reduce the risk of fire, electric shock and injury when correctly adhered to. Keep the manual in a safe place for future reference, along with the completed warranty card, purchase receipt and carton. If applicable, pass these instructions on to the next owner of the appliance. Always follow basic safety precautions and accident prevention measures when using an electrical appliance, including the following:

#### Electrical safety and cord handling

- Make sure your outlet voltage and circuit frequency correspond to the voltage stated on the appliance rating label. If this is not the case, contact the after sales support line and do not use the refrigerator.
- Do not use any other appliance at the same time on the same electrical circuit as it may overload the circuit and blow the fuse or circuit breaker.
- To protect against fire and electric shock, do not immerse the cord, plug, power base or the Retro Under Counter Fridge body itself in water or other liquid. Do not expose the electrical connections to water.
- The cord should be run in such a way that there will be no risk of anyone pulling it inadvertently or tripping over it.
- Do not kink, bend, squash, strain or damage the power cord and protect it from sharp edges and heat.
- Grip the plug when disconnecting, do not pull the cord.
- Do not let the cord hang over the edge of a table or bench top. Do not let it touch hot surfaces.
- Do not pick up or operate the appliance if the power supply cord or plug is damaged, or after it malfunctions or has been dropped or damaged in any way.
- In case of damage, contact the after sales support line for advice.
- A damaged cord or plug must be replaced by the manufacturer or a qualified person in order to avoid a hazard.
- Make sure all electrical connections are clean and dry before switching on.
- Do not use this appliance in conjunction with an extension cord.
- Unplug the appliance from the power outlet when not in use and before cleaning, servicing, maintenance or moving the appliance.
- This appliance is not intended to be operated by means of an external timer or separate remote control system.

#### Going away?

- **Short vacation:** Leave the fridge operating during vacations of less than a month.
- **Long vacation:** If you are not going to use the fridge for longer periods, remove all food and unplug the power cord. Clean and dry the interior thoroughly. To prevent odour and mould growth, leave the door open slightly, blocking it open, if necessary. (Restrict children's access to the room with the open fridge to avoid creating a child entrapment risk.)

#### Moving the fridge

- Unplug the fridge and remove all food from inside. Securely tape down the drawer and shelves and tape the door shut. Turn the levelling feet up to the base to avoid damage.
- **CAUTION:** Never pick up the refrigerator by the door.
- Protect the outside of the unit with a blanket or similar soft material and make sure the fridge stays secure in the upright position during transportation.

#### Disposal of Old Appliances

**Be sure to make any locks unusable, remove any door(s) and discard separately. Warning - chemical hazard: do not allow children to play with the old appliance. Contact your local authority for disposal procedures.**

- Before disposing of an old appliance, please make sure it is switched off and safe. Unplug the appliance and break any locks in order to avoid children becoming trapped.
- Please note: refrigeration system contains gas and refrigerants which require specialised waste disposal. Some vulnerable materials in a refrigerator are not damaged prior to disposal. You can contribute to environment awareness by insisting on an appropriate non-polluting method of disposal.

#### Disposal of Packaging

**Do not allow children to play with the packaging, and dispose of plastic bags safely.**

- The cardboard may be broken or cut into smaller pieces and recycled. Any wrapping cover is made of polyethylene. The polyethylene pads and padding contain no fluorochloric hydrocarbons, and as such are most suitable for adequate recycling.

## Maintenance & Cleaning

**Disconnect the appliance from the power supply before cleaning.**

### Internal Cleaning

- Do not pour water over the appliance.
- The cavity should be cleaned periodically using a solution of bicarbonate of soda and lukewarm water (5ml to 0.5 litre of water)
- Clean the accessories separately with soap and water. Do not put them in the dishwasher.
- Do not use abrasive products, detergents or soaps.
- After washing, rinse with clean water and dry carefully.
- When you have finished cleaning reconnect the plug with **dry hands**.

### External Cleaning

- Wash the outer cabinet with warm soapy water. Do NOT use abrasive products.
- There are sharp edges on the underside of the product so care should be taken when cleaning.
- Once or twice a year dust the rear of the appliance and the compressor at the back of the appliance, with a brush or vacuum cleaner, as an accumulation of dust will affect the performance of the appliance and cause increased energy consumption.

#### **WARNING!**

- Never clean the unit with an abrasive, acid, oil or solvent based cleaning agent, or with abrasive pads or scourers. Never use flammable fluids or sprays for cleaning as the fumes from these substances can create a fire hazard or explosion.
- Never clean the appliance with a steam cleaner. Moisture could accumulate in the electrical components, danger of electric shock! Hot vapours can lead to the damage of plastic parts.
- The appliance must be completely dry before it is placed back into service.
- Ethereal oils and organic solvents can attack plastic parts, e.g. lemon juice or the juice from orange peel, or cleansers that contain acetic acid. Do not allow such substances to come into contact with the appliance parts.

## Usage conditions and restrictions

- This product is not intended for commercial use. Do not use it outdoors.
- Only use this refrigerator as described in this manual. Any other use is not recommended and may cause fire, electric shock or injury.
- Improper installation and the use of accessories not recommended by the appliance manufacturer may result in fire, electric shock or personal injury and will invalidate your warranty.
- We assume no responsibility for any eventual damages caused by improper or faulty use.
- This appliance is not intended for use by persons (including children) with reduced physical, sensor or mental capabilities, or lack of experience and knowledge, unless they have been given supervision or instruction concerning use of the appliances by a person responsible for their safety.
- Children should be supervised to ensure they do not play with the appliance.
- Close supervision is necessary when any appliance is used by or near children.
- Do not use chemical, steel wool or abrasive cleaners to clean the outside of the unit, as these will scratch the metal surface.
- Do not operate the unit near liquids (kitchen sink, water basins, taps etc).
- Ensure that all the parts are correctly assembled before operation.
- Maintain the appliance in accordance with the instructions to ensure that it functions properly.
- If there is a product malfunction, or if it has been damaged in any way, call the after sales support for assistance.
- Immediately unplug the appliance if fire or smoke is emitted.
- Place the product on a straight, rigid and stable surface, away from sources of direct sunlight or excessive heat.
- Do not place the product near heat sources such as radiators, heat registers, stoves or other appliances that produce heat.
- Do not place the product near other items that may damage it, such as naked flame sources (lit candles) or objects containing water (a vase or fish bowl).
- Take care that no objects fall and no liquids are spilled into any openings.

**⚠ WARNING!**

- **Prevent overheating:** Place the product in a sufficiently aerated place. Ensure that air can circulate freely around the back of the refrigerator. To ensure best performance, leave a distance of about 100mm to all sides of the fridge.
- This appliance features a short power cord to reduce the risk of being entangled, and to reduce the risk of tripping. An extension cord or longer detachable cord is not recommended for use with this product.
- There are no user-serviceable parts inside. Do not attempt to service this product. Please call our after sales support for instructions.

**FLAMMABLE - REFRIGERANT GAS WARNINGS**

**⚠ Danger!** Risk of fire or explosion. Flammable refrigerant used. To be repaired only by trained service personnel. Do not puncture refrigerant tubing.

**Safety information**

**⚠ Caution!** Risk of fire or explosion. Flammable refrigerant used. Consult repair manual/owner’s guide before attempting to service this product. All safety precautions must be followed.

**⚠ Caution!** Risk of fire or explosion. Dispose of property in accordance with federal or local regulations. Flammable refrigerant used.

**⚠ Caution!** Risk of fire or explosion due to puncture of refrigerant tubing; follow handling instructions carefully. Flammable refrigerant used.

- The refrigerant isobutane (R600a) is contained within the refrigerant circuit of the appliance, a gas with a high level of environmental compatibility, which is nevertheless flammable. During transportation and installation of the appliance, ensure that none of the components of the refrigerant circuit become damaged.
- **WARNING: Do not damage the refrigerant circuit! Never use an appliance with a damaged refrigerant circuit!** If the refrigerant circuit becomes damaged, avoid proximity to open fires and all types of heat and ignition sources. Thoroughly ventilate the room in which the appliance is located.
- It is hazardous for anyone other than an authorised service person to service this appliance.
- The room for installing the appliance must be at least 1m³ per 8g of refrigerant. The amount and type of refrigerant in the appliance can be found in the Technical Specifications.

**Trouble shooting**

Problem	Solution
Smell/odour	<p>Check all the food and drink that is in the fridge is in date and correctly packaged. If it isn't then it should be removed immediately or repackaged.</p> <p>Check for spillages on each shelf, rack and drawer. You may need to remove the drawers to check that no spillages have settled underneath them. Spillages that have not been cleaned and have been left can cause smells and unwanted odours.</p>
The doors do not close properly	Ensure there are no obstructions preventing door closure.
	Check the door compartments and shelves are correctly in place.
	Check the door seal is not warped or torn.
Unusual noises	Check the appliance is level.
	Check that the appliance is on a flat, level surface and is stable.
	Check the spacing's around the appliance and ensure it is not touching other items.
	<b>Bubbling and gurgling sound:</b> • This noise is emitted as the coolant fluid flows through the pipes within the system. This is normal.
	<b>Water flowing sound:</b> • This is the normal sound of water flowing into the drain trough during the defrosting process.
The fridge door will not open.	<b>If the appliance is operating noisily (compressor noise):</b> This is normal. This noise indicates that the compressor is operating normally. As the compressor is being energized, it might run a bit more noisily for a short period of time.
	Contraction and expansion of the inside walls may cause popping and cracking noises.
The compressor runs continuously.	If the door has just been opened, leave it for a few minutes to allow the air pressure to equalise before trying again.
	The temperature is set too cold: select a lower(warmer) setting.
	The door is open, or something is obstructing proper door closure.
	The door gaskets are worn, dirty or damaged.
	Large quantities of food have been added to the fridge.
The external fridge surface is warm.	The room temperature is hotter than usual.
	The exterior walls can be warmer than room temperature. This is normal while the compressor works to transfer heat from inside the fridge cabinet.

## Trouble shooting

Problem	Solution
The fridge doesn't work	Check that the appliance is switched on.
	Check that there has not been a power cut.
	Check that the plug is not faulty.
	Check that the fuse has not blown.
	Check that the voltage is correct for the appliance.
	Are there any faults with the socket? For this purpose, try the plug of your appliance by connecting it to a socket which you are sure is working.
The temperature inside the appliance is not cold enough	Check that there is not too much food in the appliance.
	Check that the thermostat is set to a suitable temperature.
	Check that the appliance is not placed in direct sunlight, or too near to a heating source.
	Check that the ambient temperature is within the operation limits of the appliance.
	Are the doors of the appliance opened frequently? Once the door is opened, the humidity found in the air in the room enters the appliance, especially if the humidity levels in the room are very high. The more frequently the door is opened in humid conditions the more chance of the build up of moisture.
	The door is not closed completely.
	The door gasket does not seal properly.
	The cooler does not have the correct clearances at the sides/back.
The temperature within the appliance is too cold	Increase the working temperature by adjusting the thermostat to a lower setting. The highest setting should only be used as a rapid cool setting and should only be set 2 hours before a large amount of food is placed in the fridge. If this is not done the temperature in the fridge compartment could fall below 0°C as the compressor will run continuously.
	Hot and humid weather increases the internal rate of frost build-up. This is normal. Open the door less often and make sure it is always properly closed.
Moisture forms on the inside or outside walls of the fridge	Hot and humid weather increases the internal rate of frost build-up. This is normal.
	Open the door less often and make sure it is always properly closed.
The outer surfaces of the appliance are wet	Condensation will form on the outside of the cooler if it operates in moist areas, simply wipe it dry.

## General safety

### WARNING!



Do not use other electrical appliances (such as ice cream makers) inside of refrigerating appliances, unless they are approved for this purpose by the manufacture.

- Do not store explosive substances such as aerosol cans with a flammable propellant in this appliance.
- During transportation and installation of the appliance, be certain that none of the components of the refrigerant circuit are damaged.
- Avoid open flames and sources of ignition.
- Thoroughly ventilate the room in which the appliance is situated.
- It is dangerous to alter the specifications or modify this product in any way.
- Any damage to the cord may cause a short circuit, fire and/or electric shock.

### WARNING!

- **This appliance is heavy.** Care should be taken when moving it. To avoid back or other injury, consider a two person lift or mechanical aid when installing it. Failure to do so can result in back or other injury.
- Avoid prolonged exposure of the appliance to direct sunlight.
- This appliance is intended to be used in household only.

### WARNING!

- Any electrical components (plug, power cord, compressor and etc.) must be replaced by a certified service agent or qualified service personnel.
- **DO NOT USE AN EXTENSION CORD.** Use an exclusive wall outlet. Do not connect your refrigerator to extension cords or in an outlet used by any other appliance.
- Make sure that the power plug is not squashed or damaged by the back of the appliance. A squashed or damaged power plug may overheat and cause a fire.

### WARNING!

- To ensure product safety, please avoid direct sunlight after power off to cause temperature rise.
- (The interior made with HIPS, heat resistance can not exceed 60°C/140°F.)

## Safety information

- Before first use, it is advisable to wait at least eight hours before connecting the appliance to allow the oil to flow back in the compressor.
- Adequate air circulation should be around the appliance, lacking this leads to overheating. To achieve sufficient ventilation follow the instructions relevant to installation.
- The appliance must not be located close to radiators or cookers.
- Make sure that the mains plug is accessible after the installation of the appliance.

## Daily use

- Do not put **hot** food in the appliance.
- Store pre-packed food in accordance with the food manufactures instructions.
- **WARNING!** Do not use mechanical devices or other means to accelerate the defrosting process. Never use a sharp or metal instrument to remove frost or clean the appliance. Use a plastic scraper, if necessary.
- Appliance storage recommendations should be strictly adhered to. Refer to relevant instructions.
- If the refrigerator is unplugged, turned off or has lost power, you must wait 3 to 5 minutes before restarting the unit. If you attempt to restart before this time delay, the refrigerator will not start.

## Energy saving tips

- Place the fridge in the coolest area of the room, away from heat-producing appliances and out of direct sunlight.
- Let heated food and beverages cool to room temperature before placing them into the fridge.
- Do not overload the fridge as it forces the compressor to run longer.
- Wrap foods properly and wipe containers dry before placing them in the fridge. This cuts down on frost build-up inside the fridge.
- Do not line any fridge storage bin with aluminum foil, wax paper or paper towels. Liners interfere with cold air circulation, reducing cooling efficiency.
- Position food so that air can circulate freely around it.
- Do not leave the fridge door open for longer than required.
- Make sure no food touches the back of the compartment.
- Don't set the thermostat on exceeding cold temperatures.

# SAVE THESE INSTRUCTIONS

## Installing the refrigerator

- Before installing your new fridge, read all safety instructions in this manual, then follow the instructions below:
- Place the fridge on a sturdy, level floor for quieter operation. Ensure that the floor is strong enough to support the fridge when it is fully loaded.
- If the refrigerator is to be placed on carpet, support it with a wooden board underneath. **Be aware that placing the refrigerator on carpet may mean that heat from the compressor may cause the carpet to fade.**
- **This appliance is designed to be freestanding only and should not be recessed or built in.**
- Do not tilt the fridge more than 45° from upright when moving it.
- Avoid areas where the appliance would be exposed to direct sunlight, sources of heat (stove, heater, radiator, etc.), extreme cold ambient temperatures or excessive moisture and high humidity. Installing it in the coolest area of the room will save energy consumption and running costs.

### **⚠ WARNING!**

- **Handle with care!** Do not apply force to any part such as the condenser or door. The metal rails on the bottom underneath of this refrigerator may have sharp edges, so always unpack and handle with care. Do not drag the unit: place it carefully in position to avoid scratching the floor.

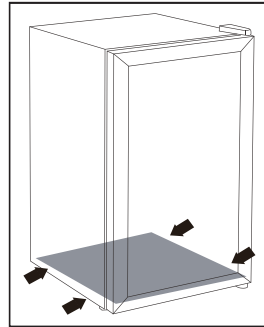

### Space requirements

- Place the unit so there is enough space for the door to open.
- Ensure that air can circulate freely around the back of the cabinet, which is necessary to cool the compressor and condenser. Allow at least 100mm clear space at the back and 50mm at the sides of the unit.

### Levelling

- The appliance must be installed level in order to work properly. If the unit is not level, the doors and magnetic seal alignments will not be covered properly.
- To level the unit, adjust one or both levelling feet at the base of the unit.

## Parts List

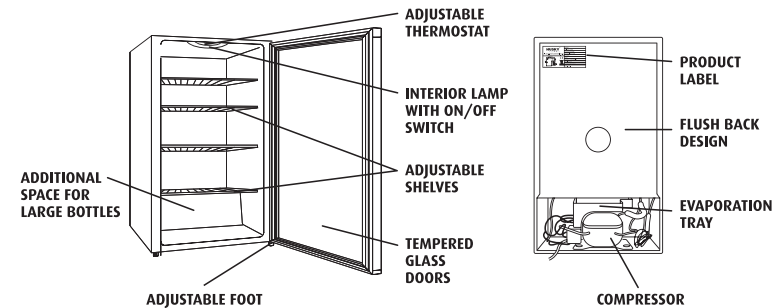

There are several types of controller/thermostat for different models. Please check which type of controller on your unit.

### Mechanical Controller

- The mechanical thermostat temperature control and the LIGHT on/off switch is located at below places:

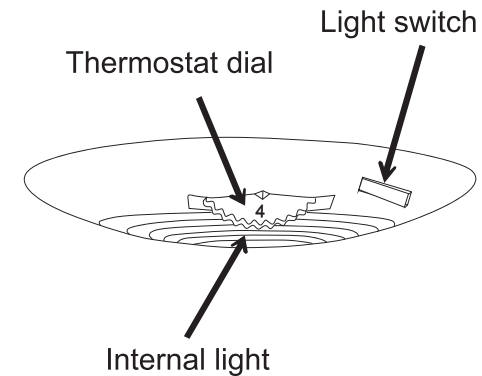

### Setting the Temperature Control:

- To start the refrigerator, turn the temperature control to the position corresponding to the desired cooling. The temperature of the refrigerator is controlled by adjusting/ setting the thermostat control knob, located on the top in the cabinet.
- The settings 0(OFF) - 7(MAX) regulate the interior temperature of the refrigerator. Setting 1(MIN) = lowest setting (warmest internal temperature)  
Setting 7(MAX) = Highest setting (Coldest internal temperature)

## REVERSIBLE DOOR

You will need to tilt the fridge backward to access the lower hinge which holds screws. Do not tilt more than 45 degrees and do not lay the fridge flat on its side.

Reversing the door:

1. Remove the top plastic hinge cover and set aside

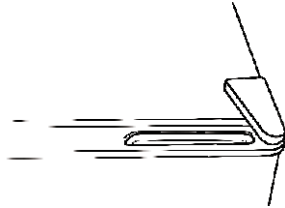

2. Unscrew the 3 screws from the metal bracket and set aside, carefully remove the door and place it on a cushioned surface.

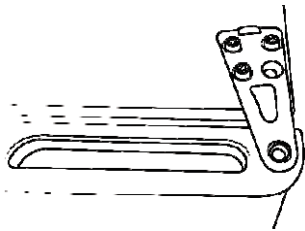

3. Tilt the fridge backward no more than 45 degrees, unscrew the bottom hinge and front feet, repositioning the front feet to the bottom hinges original location and the bottom hinge to the front feet's original position.
4. Remove the plastic insert on the opposite side of the top hinge. Now fix the top door bracket to that side using the previously removed screws. Place the removed plastic insert to the now vacant slot on the opposite side of the bracket.

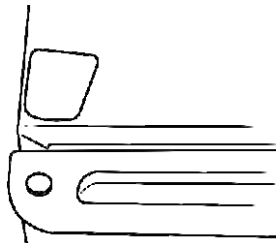

5. After completing the above steps, finally reverse the glass door to another side. Ensure to place the top plastic hinge cover (1) back on the top hinge.

## Getting Started

### Unpacking

- This product has been packaged to protect it against transportation damage. Remove all packaging materials from around and inside the appliance, **but do not remove any foam insulation surrounding the pipes at the back.** Keep the original packaging carton and materials in a safe place; it will help prevent any damage if the product needs to be transported in the future, and you can use it to store the appliance when it is not in use. In the event that the carton is to be disposed of, please recycle all packaging materials where possible.
- Plastic wrapping can be a suffocation hazard for babies and young children, so ensure all packaging materials are out of their reach and disposed of safely.
- Parts: Check to ensure you have all the parts pictured on the previous page spread.
- Unwind the power cord to its full length and inspect it for damage. Do not use the appliance if the appliance or its cord have been damaged or are not working properly. **In case of damage, contact our after sales support line for advice on examination, repair or return of the damaged product.**
- Make sure the refrigerator is disconnected from the power supply before cleaning the interior surfaces and all internal accessories with lukewarm water, a soft cloth and a neutral/mild soap/detergent. This will remove any dust from transit and storage and help remove the typical smell of a brand new product. Then dry thoroughly. **Important:** do not use harsh or abrasive detergents or powders as these will damage the finish.

# 说明书规格页

全书黑白印刷 4页

143x210mm

105克铜版纸

骑马钉

注：以上是技术要求 不用印在说明书