

Sunbeam

DURACERAMIC™ ELECTRIC FRYWARE RANGE

User Guide

This user guide covers the use and care
of the following Sunbeam Electric Fryware:
FP6000 DURACERAMIC BANQUET FRYPAN
SK6000 DURACERAMIC SKILLET



Contents

Sunbeam's Safety Precautions	1
Features of your Sunbeam Fryware	
DuraCeramic™ Banquet Frypan - FP6000	2
DuraCeramic™ Skillet - SK6000	4
Temperature setting guide	6
Using your Sunbeam Fryware	7
Cooking with your Sunbeam Fryware	8
Care and Cleaning	10
Frypan Recipes	11
Skillet Recipes	18

Important instructions – retain for future use.

تأكد من تفهم احتياطات السلامة المذكورة اعلاه

請務必理解上述的安全預防措施。

Assurez-vous que les précautions ci-dessus relatives à la sécurité sont bien comprises

Versichern Sie sich, dass die obenstehenden Sicherheitsmaßnahmen Verstanden werden

Βεβαιώνετε πως οι παραπάνω προφυλάξεις ασφαλείας γίνονται κατανοητές

Pastikan bahwa tindakan-tindakan keselamatan seperti di atas dimengerti anda

Accertatevi che le suddette norme di sicurezza siano comprese a dovere

上記の注意事項をよくお読みになり、安全を御確認ください

Уверете се дека погоре споменатите мерки на претпазливост се добро разбрани

Asegúrese de que las precauciones de seguridad precedentes sean bien comprendidas

کاری بکنید کہ احتیاط‌های بالا حتماً درک بشوند

ต้องแน่ใจว่า ข้อควรระวังเรื่องความปลอดภัยข้างต้น เป็นที่เข้าใจกันดี

Yukarda belirtilen güvenlik önlemlerinin anlaşılığından emin olunuz

Xin kiểm chắc rằng những biện pháp làm an toàn kể trên được hiểu rõ

Sunbeam's Safety Precautions

SAFETY PRECAUTIONS FOR YOUR SUNBEAM FRYPAN.

- Use your frypan at least 200mm away from walls and curtains.
- Do not immerse the control probe in water.
- If using a plastic spatula do not leave in cooking vessel when hot.
- The frypan must only be used with the control probe provided.
- Avoid using on metal surfaces e.g. sink, hotplate.
- Remove the control probe before cleaning the frypan.
- After cleaning the frypan ensure that the control probe Inlet area is completely dry before using again.

Sunbeam is very safety conscious when designing and manufacturing consumer products, but it is essential that the product user also exercise care when using an electrical appliance. Listed below are precautions which are essential for the safe use of an electrical appliance:

- Read carefully and save all the instructions provided with an appliance.
- Always turn the power off at the power outlet before you insert or remove a plug. Remove by grasping the plug - do not pull on the cord.
- Turn the power off and remove the plug when the appliance is not in use and before cleaning.
- Do not use your appliance with an extension cord unless this cord has been checked and tested by a qualified technician or service person.
- Always use your appliance from a power outlet of the voltage (A.C. only) marked on the appliance.
- This appliance is not intended for use by persons (including children) with reduced physical, sensory or mental capabilities, or lack of experience and knowledge, unless they have been given supervision or instruction concerning use of the appliance by a person responsible for their safety.
- Children should be supervised to ensure that they do not play with the appliance.
- The temperature of accessible surfaces may be high when the appliance is operating.
- Never leave an appliance unattended while in use.
- Do not use an appliance for any purpose other than its intended use.
- Do not place an appliance on or near a hot gas flame, electric element or on a heated oven.
- Do not place on top of any other appliance.
- Do not let the power cord of an appliance hang over the edge of a table or bench top or touch any hot surface.
- Do not operate any electrical appliance with a damaged cord or after the appliance has been damaged in any manner. If damage is suspected, return the appliance to the nearest Sunbeam Appointed Service Centre for examination, repair or adjustment.
- For additional protection, Sunbeam recommend the use of a residual current device (RCD) with a tripping current not exceeding 30mA in the electrical circuit supplying power to your appliances.
- Do not immerse the appliance in water or any other liquid unless recommended.
- Appliances are not intended to be operated by means of an external timer or separate remote control system.
- This appliance is intended to be used in household and similar applications such as: staff kitchen areas in shops, offices and other working environments; farm houses; by clients in hotels, motels and other residential type environments; bed and breakfast type environments.

If you have any concerns regarding the performance and use of your appliance, please visit www.sunbeam.com.au or contact the Sunbeam Consumer Service Line.

Ensure the above safety precautions are understood.

Features of your Sunbeam DuraCeramic™ Banquet Frypan - FP6000

Steam Vent

Fixed steam vent controls the moisture level during cooking.

DuraCeramic™ cooking surface

Unique DuraCeramic™ coating cooks food faster with higher scratch resistance and 4X more durable than non-stick coatings. Superior food release ensures fast and easy clean-up.

Cool touch handles and lid knob

For safer cooking and carrying of the frypan

Control probe inlet

Tilt & baste lever

When the lever is in the lowered position the cooking pan is tilted, forcing juices to collect at one end of the pan. Both hands are then free for basting.

Dishwasher safe

The pan, base and lid are dishwasher safe and fully immersible.

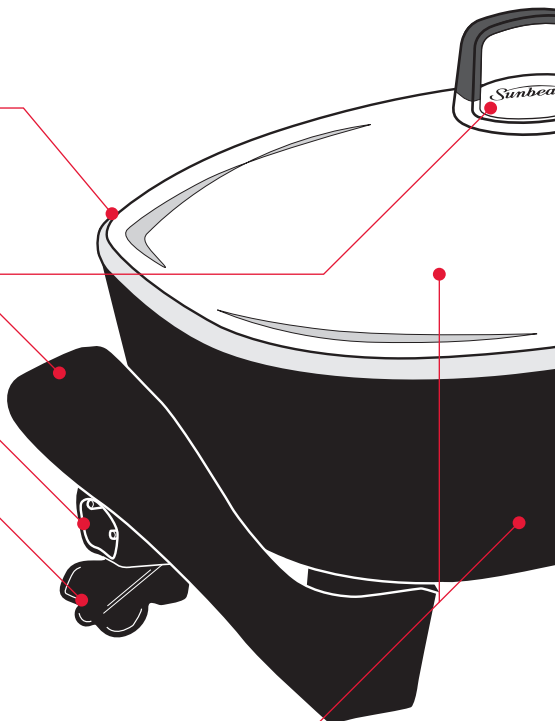

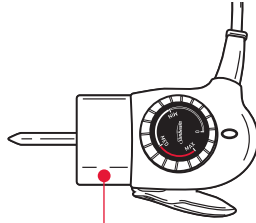

Trigger release control probe

The probe is thermostatically controlled and incorporates an indicator light that switches off automatically when the selected temperature has been reached, it then cycles on and off to indicate that the temperature is being maintained.

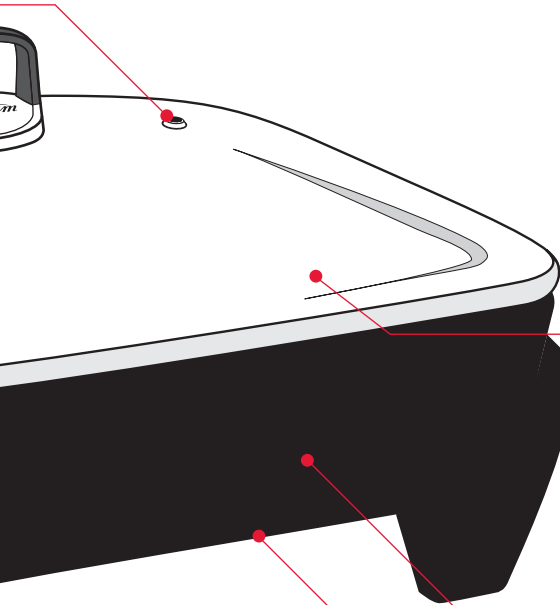

Glass lid

The clear glass lid allows you to monitor the cooking process without lifting the lid and allowing the heat to escape, ensuring the selected temperature is maintained.

Extra large cooking vessel

The large rectangular frypan (38cm (15") x 29.5cm (11.5")) is 78mm deep, ideal for cooking 2 chickens, roasts, family size meals or liquid based dishes.

Cast-in rectangle element

The powerful 2400 watt rectangle element is completely cast into the heavy duty base providing superior heat distribution, faster heating and a longer element life.

Features of your Sunbeam DuraCeramic™ Skillet - SK6000

Integrated knob & adjustable steam vent

Allows you to accurately control moisture levels during cooking.

Cool touch handle and lid knob

For safer cooking and carrying of your skillet.

Control probe inlet

Cast-in element

The 1200 watt element is completely cast into the heavy duty base providing superior heat distribution, faster heating and a longer element life.

Dishwasher safe

The pan and base are dishwasher safe and fully immersible making cleaning a breeze.

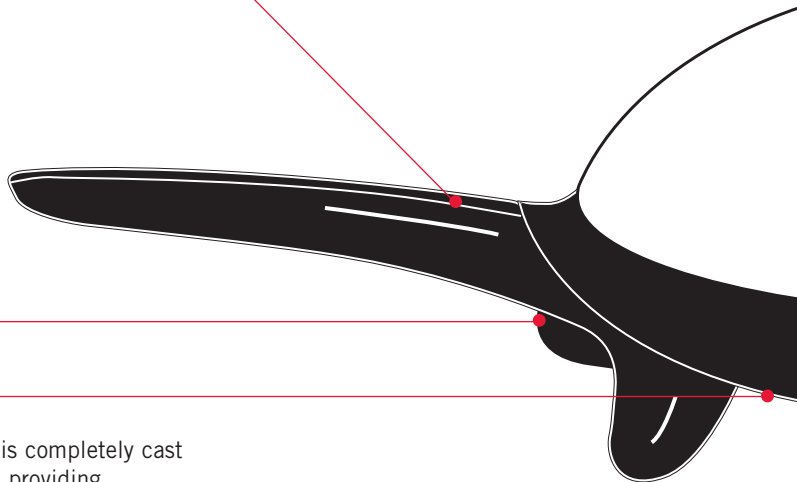

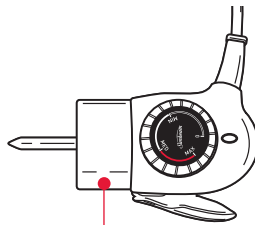

Trigger release control probe

The probe is thermostatically controlled and incorporates an indicator light that switches off automatically when the selected temperature has been reached, it then cycles on and off to indicate that the temperature is being maintained.

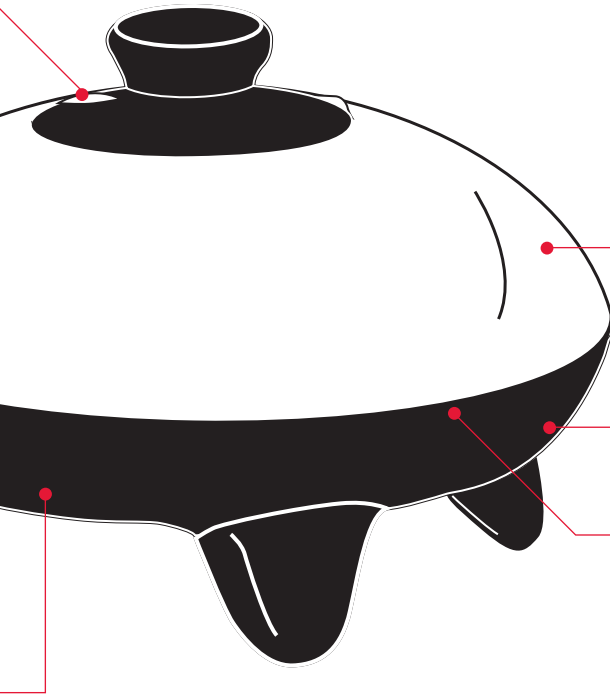

High domed metal lid

Turns your skillet into a compact oven. Ideal for small roasts, chicken or steaming.

25cm (10") electric skillet

DuraCeramic™ cooking surface

Unique DuraCeramic™ coating cooks food faster with higher scratch resistance and 4X more durable than non-stick coatings. Superior food release ensures fast and easy clean-up.

Temperature setting guide

Trigger Release Control Probe

The probe is thermostatically controlled and incorporates an indicator light which switches off automatically when the temperature selected has been reached and then cycles on and off to indicate that the selected temperature is being maintained. The trigger release makes removal of the probe easy.

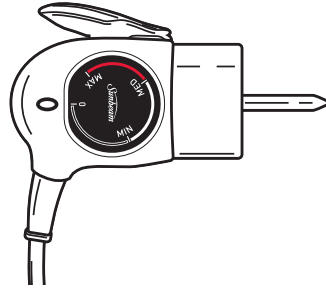

The settings on the dial represent the following temperatures approximately. Pre-heat your frypan on MAX setting then change to your desired setting.

DIAL SETTING	CELCIUS (approx)	USES	TEMPERATURE
MIN	50°C - 70°C	Keeping food warm	LOW
MIN/MED	80°C - 105°C	Simmering, slow cooking	
MED	120°C - 140°C	Pan frying	MEDIUM
MED/MAX	150°C - 175°C	Shallow frying, roasting	
MAX	190°C - 210°C	Searing and sealing	HIGH

Note: The temperature settings are a guide only and may require adjustment to suit various foods and individual tastes. When the dial is set to a MIN setting, it is quite normal for food to stop and start bubbling, as the thermostat maintains the selected temperature.

Using your Sunbeam Fryware

Before the first use: Wash, rinse and dry your fryware and lid.

1. Insert the control probe into the inlet on the fryware.
2. Plug the cord into a 230-240V power outlet and turn the power on.
3. Pre heat the fryware on MED/MAX setting. Then set the control probe dial to the desired temperature setting. Refer to page 6 for the temperature guide.

Note: The light on the control probe will illuminate and will remain on until the set temperature is reached. It will then cycle on and off throughout cooking, as the temperature is maintained by the thermostat. On initial heating of the frypan, it is recommended that the temperature be allowed to cycle (the light cycling on and off) several times. This will help the cooking surface to adjust to a more accurate cooking temperature.

Using the tilt & baste lever

(Models FP6000)

The tilt & baste lever is positioned under the inlet where the control probe is inserted. To tilt the frypan, push the lever down. This allows the fat and juices to drain from the food for crisp, low fat cooking. It also makes it easier to baste food and serve sauces or gravy.

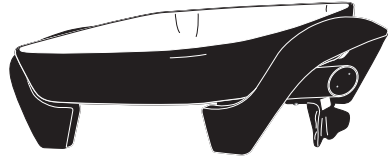

Trigger release control probe

The probe is thermostatically controlled and incorporates an indicator light which switches off automatically when the temperature selected has been reached. It then cycles on and off to indicate that the selected temperature is being maintained.

Cooking with your Sunbeam Fryware

Baking

(Models FP6000)

Your frypan can be used for baking cakes, with deliciously moist results.

1. Preheat the frypan to MAX setting, with the lid on.
2. Elevate the cake pan or tray from the base of the frypan using a small wire rack.

Cooking times will be longer than those of a conventional oven.

Basting

(Models FP6000)

The tilt & baste lever makes basting easy as it allows the juices to drain to one side of the pan. Reduce the temperature to prevent any fat and juices splattering. Position the pan tilt lever and spoon the juices over the food as desired.

Browning and Sealing Meat

(All models)

It is necessary to brown and seal meat in many recipes. Meat retains its juices and the flavours develop after browning and sealing. This also prevents it from sticking when baking or roasting. Preferably use meat that is at room temperature, as this reduces the cooking time.

1. Preheat the frypan to MED/MAX setting.
2. Brown meat on all sides, with the lid off.
3. After sealing, reduce the temperature to MED setting and replace the lid until the meat is cooked as desired.

Cooking with your Sunbeam Fryware continued

Frying

(All models)

The frypan is ideal for shallow or dry frying. Deep frying is not particularly suitable as the frypan has shallow sides and a greater surface area, which results in heat loss and the possible overflow of oil.

Pan frying: Suitable for eggs, omelettes, bacon, sausages, steaks and chicken pieces. Preheat to MED setting with a little oil to add flavour. The DuraCeramic™ cooking surface does not require a large amount of oil. Steaks should only be turned once during cooking.

Shallow frying: Suitable for vegetable pieces e.g roast pumpkin and potato, and crumbed food. Preheat on MED setting with sufficient oil so that the food is half immersed. Cook food with the lid off.

Sautéing: Preheat on MED setting with a little oil to add flavour.

Stir frying: Food is cooked quickly, over a high heat and vegetables retain their flavour and crispness. For best results and even cooking, cut food into even sized, smaller pieces.

1. Preheat the frypan on MED/MAX setting with a little oil.
2. Slice meat into strips. Coat meat in a little oil and stir-fry in batches until browned. This prevents meat from stewing.
3. Add vegetables and seasoning, stirring continuously. Vegetables which take longer to cook, such as carrots, should be cooked first, adding the other ingredients later. Cook until the vegetables are crisp. Return the meat back into the pan when the vegetables are almost cooked. The lid can be in position in the last few minutes of cooking.

Roasting

(All models)

Meat and poultry: The frypan is ideal for roasting meat and poultry, as the meat retains the flavour and juices.

1. Preheat the frypan to MED/MAX setting. Use only a small amount of oil for less fatty joints and no oil for fattier joints of meat.
2. Brown and seal the meat on all sides and position the lid.
3. After browning, turn the dial to MED setting to cook the meat as desired. Turn meat occasionally during cooking to ensure even cooking.
4. Remove meat from pan and cover with foil. Allow meat to rest for 5-10 minutes, meanwhile you can make a gravy from the juices in the frypan.

Vegetables: Cut into even sized pieces. Add to the frypan 45-60 minutes before serving. For crisper vegetables, remove the meat and increase the heat for the last few minutes of cooking.

Roasting times:

Note: These times are for well done. Reduce the times to suit personal taste.

PORK	30-40 minutes per 500g after browning.
VEAL	30-40 minutes per 500g after browning.
BEEF	20-25 minutes per 500g after browning.
LAMB	25-30 minutes per 500g after browning.
CHICKEN	30-35 minutes per 500g after browning.

Care and Cleaning

Always turn the power off and remove the plug from the power outlet after use and before cleaning. Appliance is best cleaned whilst still warm.

Control probe

If cleaning is necessary, wipe over with a damp cloth.

Note: The control probe must be removed before the frypan or skillet is cleaned and the control probe inlet must be dried before the frypan or skillet is used again.

Important: Do not immerse the control probe in water or any other liquid.

Store the control probe carefully. Do not knock or drop it as this can damage the probe. If damage is suspected, return the control probe to your nearest Sunbeam Appointed Service Centre for inspection.

High domed metal lid (SK6000)

Wash the lid in warm soapy water using a soft sponge, rinse and dry thoroughly. Metal scourers will scratch the surface and should be avoided. Some food such as tomato paste and curry may stain the surface. This staining may be removed or reduced by rubbing with a cream cleanser or a paste of bicarbonate of soda and water.

Note: Do not place metal lid in a dishwasher.

Glass lid (FP6000)

Wash the lid in warm soapy water using a soft sponge, rinse and dry thoroughly. Alternatively, wash the lid in a dishwasher.

To clean DuraCeramic™ and exterior surface

- Remove excess foods with paper towel whilst the frypan or skillet is still warm.
- When cleaning the DuraCeramic™ coating do not use metal (or other abrasive) scourers. After cleaning, dry the frypan/skillet and lid with a soft cloth before storing.
- Wash the pan and base in hot soapy water or in a dishwasher.
- The heating element is totally sealed, making the frypan or skillet safe to fully immerse in water, or place in a dishwasher.
- For stubborn food build up, use a cream based multi purpose cleanser and a damp soft cloth. Rinse frypan or skillet as per cleanser instructions.

Frypan Recipes

The following recipes are also suitable for your DuraCeramic™ Skillet.

Note: The temperature settings stated in these recipes are a guide only and will vary.

Corn Fritters

Makes approx. 20

- 1 cup self raising flour
 - ½ teaspoon bicarbonate soda
 - ½ teaspoon sweet paprika
 - ½ teaspoon ground coriander
 - ⅔ cup buttermilk
 - 2 eggs
 - 2 cups corn kernels
 - 1 small red capsicum, diced finely
 - 3 small green onions, sliced
 - 2 tablespoons chopped fresh parsley
 - 1 tablespoon chopped fresh coriander
 - Sea salt and freshly ground black pepper
 - Olive oil
 - Tomato chilli jam, to serve
1. Combine flour, soda, paprika in a bowl; whisk through buttermilk and eggs to form a batter.
 2. Combine corn, capsicum, green onions, parsley and coriander in a large bowl. Stir through the batter; season with salt and pepper.
 3. Heat frypan on MED/MAX setting. Drizzle a little olive oil in frypan and spoon tablespoonfuls of mixture into pan. Cook fritters for 2-3 minutes on each side until golden.
 4. Serve with tomato chilli jam if desired.

Beef Stroganoff

Serves 4

- 2 tablespoons plain flour
 - 1 kg beef strips
 - 2 tablespoons olive oil
 - 2 small cloves garlic, crushed
 - ¼ cup tomato paste
 - 1 cup beef stock
 - 250g button mushrooms, sliced
 - ⅓ cup sour cream
 - Salt and freshly ground black pepper
1. Dust beef in flour, shaking off excess flour. Heat oil in frypan on MED setting; cook beef in batches until browned.
 2. Return all beef to pan and add remaining ingredients, except sour cream. Cover and cook on MIN/MED setting for about 45 minutes or until the beef is tender.
 3. Stir through sour cream. Season with salt and pepper. Serve with buttered noodles.

Frypan recipes continued

Gyoza (Japanese Dumplings) Makes approx. 50

150g pork mince
150g chicken mince
2 tablespoons kecap manis (sweet soy)
1 teaspoon sugar
1 tablespoon mirin
1 egg
2 teaspoons sesame oil
2½ cups Chinese cabbage, shredded finely
⅓ cup finely chopped water chestnuts
4 green onions, chopped finely
50 sheets gow gee wrappers
vegetable oil for pan frying

Dipping Sauce

2 tablespoons kecap manis
1 tablespoon black vinegar

1. Combine all ingredients in a bowl and mix well.
2. Lay several sheets of gow gee wrappers out onto a bench top. Have a tray lined with baking paper ready to place the prepared gyoza onto.
3. Place a rounded teaspoon of filling into the centre of the wrapper. Moisten the edges with a little water. Fold the wrapper over the filling but before sealing carefully pleat on one side. The pastry will look plain on one side but have a small pleat on the other. Gently press the pastry to seal. Repeat with remaining wrappers.
4. Heat frypan on MED/MAX setting. Heat 1 tablespoon of oil in the frying pan and place the dumplings, in batches, into the pan, pleat side up. Cook until the dumplings are golden on the bottom. Do not turn. Carefully pour enough water in the frying pan so that the dumplings are

half covered. Place the lid on the frypan and cook, covered for 1 minute. Remove lid and cook, uncovered, until all the water has evaporated. Remove from pan, repeat with remaining dumplings.

Note: The water should be simmering the entire time. If this does not happen increase the heat to MAX setting.

5. Serve with dipping sauce.

Tip: Kecap manis, mirin and black vinegar are available at Asian grocery stores, or in the international section of supermarkets.

Frypan recipes continued

Spanish Paella

- 2 small raw blue swimmer crabs
- 8 large green prawns
- 8 small black mussels
- 3½ cups fish/chicken stock
- 1 teaspoon saffron threads
- 180g chorizo sausage, sliced
- 200g chicken thighs, halved
- 1 tablespoon extra virgin olive oil
- 1 medium onion, chopped finely
- 1 clove garlic, crushed
- ¼ teaspoon smoked paprika
- 1 x 400g canned tomatoes
- 1½ cups Arborio or Spanish rice
- 300g whole pipis, purged
- ½ cup frozen peas
- 1 small roasted red capsicum, sliced

1. Remove flap from the undersides of crabs then flip crab over. Place your thumb under the shell between the two back legs and slowly pull the shell away from the body. Discard. Remove the feather-like gills and front feelers and discard. Carefully rinse the crab if needed – do not put under running water. Using a sharp knife cut the body in half; then cut between the smaller legs to make 4 pieces. Crack the large nippers with crab crackers; this will help the heat get into the shell.
2. Peel four of the prawns and devein. Leave the other four whole for presentation. Clean and de-beard mussels.
3. Place stock and saffron in a saucepan and heat gently to infuse. Cover and keep warm.
4. Heat the electric frypan on MED/MAX setting. Cook chorizo in pan until golden; drain on paper towelling.

Serves 6-8

5. In same pan cook the chicken thighs and whole prawns in chorizo oil until just cooked through; set aside.
6. Reduce heat to MED setting and add extra virgin olive oil, if needed, in electric frypan and cook onions and garlic until the onions are translucent; add paprika and cook for a further 30 seconds.
7. Add tomatoes and cook on MED setting for 2-3 minutes. Add rice and cook, stirring until well coated. Add stock and stir to combine. Reduce heat to MIN/MED setting and cook, covered for 10 minutes.
8. After 10 minutes check rice, add a little water if the rice looks too dry. Cook, covered, for a further 5 minutes if the rice is still quite hard.
9. Arrange raw seafood, chicken, chorizo, whole prawns, peas, roasted capsicum, over rice and cook, covered for a further 5 minutes or until the seafood is cooked and the rice is tender. Turn heat off and keep covered for 5 minutes before serving.

Frypan recipes continued

Family Beef Casserole with Semi Dried Tomatoes

Serves 6-8

2 kg chuck steak, cut into 2cm cubes
½ cup flour
3 tablespoons olive oil
2 bunches of spring onion, stalk trimmed, peeled and left whole
2 cloves garlic, crushed
⅓ cup tomato paste
½ cup red wine
3 carrots, diced
3 celery stalks, sliced
1 cup beef stock
1 cup water
2 tablespoons chopped fresh thyme
2 bay leaves
1 cup semi dried tomatoes
Salt and freshly ground black pepper

1. Dust beef in flour, shaking off excess flour. Heat oil in frypan and cook beef in batches until brown. Set aside.
2. To the same pan, add onion and garlic, cook, stirring for 1-2 minutes, or until onion starts to colour. Stir through tomato paste and cook for 1 minute.
3. Add wine and allow alcohol to evaporate and liquid to reduce slightly. About 2 minutes.
4. Place beef, vegetables, stock, water, thyme and bay leaves in frypan. Cover and cook on setting 4 for 1 hour, stirring occasionally. After 1 hour add tomatoes and cook for a further 20-30 minutes or until beef is tender.
5. Season to taste and serve hot with mashed potatoes or rice.

Penne Boscaiola

Serves 4

6 rashers bacon
200g sliced button mushrooms
⅔ cup white wine
300ml cream
Salt and freshly ground black pepper
500g penne
shaved parmesan, to serve

1. Have a large pot of boiling water ready.
2. Remove rind from bacon and slice into 5mm pieces.
3. Heat frypan on MED/MAX setting. Cook bacon until golden. Add mushrooms and stir through.
4. Add wine and cook, stirring, until the wine has reduced by half. Add cream and cook, stirring occasionally, until the sauce has thickened slightly.
5. Cook pasta until just tender, drain and add to sauce and stir through. Season with salt and pepper. Serve immediately with shaved parmesan.

Frypan recipes continued

Pan Fried Chicken Breast with Salsa Verde

1-2 tablespoons olive oil
6 chicken breast fillets

Salsa Verde

1 cup fresh flat leaf parsley
½ cup dill
½ cup fresh mint leaves
2 cloves garlic
1 tablespoon small capers
1 tablespoon grated lemon rind
Sea salt and freshly ground black pepper
¾ cup extra virgin olive oil

1. Heat frypan on MED/MAX setting. Add oil and cook chicken, uncovered, until browned on both sides and cooked through. Remove from heat and serve with Salsa Verde.
2. To make the Salsa Verde, blend or process all ingredients until a chunky sauce texture is achieved.

Tip: Salsa Verde also goes very well with pan fried fish fillets.

Serves 6

Pan Fried Fish with Garlic and Lemon Serves 4

4 (800g) white fish fillets
2 tablespoons olive oil
2 cloves garlic, crushed
2 tablespoons lemon juice
2 eschalots, minced
¼ cup shredded fresh basil leaves
Sea salt and freshly ground black pepper
Steamed new potatoes or mash, to serve
Steamed broccolini, to serve

1. Place fish in a shallow baking dish. In a small bowl combine the garlic, lemon juice, eschalots, basil, salt and pepper and mix well.
2. Pour marinade over fish and allow to sit at room temperature for 20 minutes.
3. Heat frypan on MAX setting. Add oil and cook fish for 3-5 minutes on both sides until just cooked through.

Note: Cooking time will vary depending on the thickness of each fillet.

4. Serve fish with potatoes and steamed broccolini.

Frypan recipes continued

Lamb Tagine

Serves 4-6

2 tablespoons olive oil
8 lamb shanks, fat trimmed
1 large onion, sliced thinly
2 cloves garlic, crushed
1½ tablespoons Moroccan dried spice mix
1 tablespoon tomato paste
1 x 400g can chopped peeled tomatoes
1 cup chicken stock
1 cinnamon stick
3 cardamom pods, cracked
Salt and freshly ground black pepper
1 x 400g tin chickpeas, drained and rinsed
1 large sweet potato, peeled and chopped into 2 cm dice
1 cup fresh coriander, roughly chopped
Cous cous, to serve

1. Heat oil in frypan on MED/MAX setting. Cook lamb shanks in batches for 3-5 minutes or until evenly brown all over; remove from heat.
2. Reduce heat to MED setting, and add onion and garlic to frypan and cook for 5 minutes, or until onion has softened and coloured. Add spice mix and cook until fragrant. Stir through tomato paste.
3. Return the lamb shanks to the frypan with tomatoes, stock, cinnamon, and cardamom. Cover and cook, on MIN/MED setting, turning and stirring occasionally for 2 hours. After 2 hours add chickpeas, sweet potato and cook, covered until the sweet potato is tender.
4. Season to taste with salt and pepper. Stir through chopped coriander, serve with cous cous.

Roast Chicken with Stuffing

Serves 4

1.2kg whole fresh chicken
Salt and freshly ground black pepper

Stuffing

1 onion, chopped finely
2 teaspoons olive oil
3 cups fresh bread crumbs
30g butter, softened
1 teaspoon grated lemon rind
2 tablespoons chopped fresh parsley
2 teaspoons chopped fresh thyme

1. Wash and clean chicken thoroughly. Pat dry with paper towelling.
2. To make stuffing, cook onion in oil until softened. Add to remaining stuffing ingredients and mix well.
3. Place the stuffing inside the cavity of the chicken. Tuck the wings back and tie the base of the chicken with cooking string so that the legs are crossed and securely positioned.
4. Preheat frypan on MED/MAX setting. Brush chicken with a little oil and salt and pepper.
5. Brown chicken on all sides; reduce heat to MED setting and cook, covered, for about 1½ hours or until cooked through.

Tip: If cooking roast vegetables, place in frypan $\frac{3}{4}$ to 1 hour before the end of cooking.

Frypan recipes continued

Roast Lamb

Serves 4-6

- 1 leg lamb
- 4-6 garlic cloves, sliced
- 3-4 sprigs fresh rosemary, snipped into small pieces
- 2 tablespoons olive oil
- Salt and freshly ground black pepper
- 6 small picking onions
- 400g pumpkin, cut into chunks
- ½ bunch baby carrots, trimmed
- 2 potatoes, peeled, chopped
- 1 sweet potato, peeled and thickly sliced

1. Using a small sharp knife, pierce the lamb all over, making indentations about 2cm deep. Push a piece of garlic into each slit and a small piece of rosemary. The rosemary should be poking out slightly.
2. Heat frypan to MAX setting. Add oil and brown lamb all over. Season with salt and pepper; add onions to pan. Reduce heat to MED setting. Cook lamb, covered, for about 1 hour and 15 minutes.
3. Add vegetables to pan and cook for a further 25 minutes. Remove lamb and allow to rest, covered, until the vegetables are cooked as desired.

Skillet Recipes

The following recipes are also suitable for your DuraCeramic™ Skillet. Please note that it will be necessary to cook in batches.

Individual Sticky Date Puddings

Serves 8

200g coarsely chopped dried dates
1 teaspoon bicarbonate soda
1¼ cups boiling water
60ml olive oil
1 cup firmly packed brown sugar
1 cup self raising flour
¼ teaspoon mixed spice
2 eggs

Butterscotch sauce

160g butter
⅔ cup firmly packed brown sugar
1 cup (250ml) thickened cream

1. Preheat frypan on MIN/MED setting with the lid on. Grease 8 individual 1-cup capacity metal moulds.
2. Place dates, soda and boiling water into a blender or food processor. Place lid on and allow the mixture to stand for 5 minutes.
3. Add oil and sugar and pulse 3 times.
4. Add remaining ingredients and pulse mixture until just combined. Scrape down sides of bowl if necessary. Do not over process.
5. Pour mixture into prepared moulds. Place moulds in frypan and carefully pour enough boiling water to come half way up the sides of the moulds. Cook for about 25 minutes or until cooked when tested with a wooden skewer. Carefully remove from frypan; stand for 5 minutes before turning out onto a wire rack.
6. Serve pudding with butterscotch sauce. To make sauce, heat all ingredients in a small saucepan over a low heat until combined.

Caramelised Bananas with

Serves 4

Hot Chocolate Sauce and Whipped Cream

4 large bananas
¼ cup firmly packed brown sugar
1 teaspoon cinnamon
Whipped cream, to serve
Hot chocolate sauce
100g dark chocolate, chopped
30g white marshmallows, chopped
150ml thickened cream

1. Preheat frypan on MIN/MED setting.
2. Cut bananas in half lengthways, leaving the skin on. Sprinkle the combined sugar and cinnamon over the cut bananas. Press gently into the banana.
3. Place bananas, cut side down and cook, uncovered, for about 6 minutes or until the sugar has caramelised and the banana has softened. Serve bananas with hot chocolate sauce and whipped cream.
4. To make the hot chocolate sauce, combine all ingredients in a small saucepan and cook, stirring, over a low heat, until melted.

Skillet recipes continued

Spiced Rhubarb and Berry Compote Serves 4-6

2 bunches of rhubarb, cut into 2cm pieces
500g frozen mixed berries
¾ cup sugar
1 cinnamon stick
3 whole cloves
1 teaspoon grated orange rind

1. Combine all ingredients into the frypan. Cook, stirring gently, on MED/MAX setting until the sugar dissolves. Cover and cook on MED setting for about 15 minutes or until the rhubarb is tender.
2. Serve hot with ice cream, custard or with your favourite pudding.

Buttermilk Pancakes Makes 8

1 cup self raising flour
2 tablespoons sugar
½ teaspoon bicarbonate of soda
1 egg, lightly beaten
2 tablespoons vegetable oil
1 cup buttermilk
60g butter

1. Sift dry ingredients into a large bowl. Make a well in the centre.
2. Whisk the combined wet ingredients into the dry ingredients until smooth.
3. Heat skillet on MED setting. Melt some of the butter and spoon ¼ cupfuls of mixture at a time into the skillet. Turn the pancakes once the bottom is golden and the tops starts to bubble. Cook until the underside is golden.
4. Serve with extra butter and maple syrup.

Pikelets

1 egg
¼ cup sugar
1 cup self raising flour
¾ cup milk
pinch salt
butter for frying

Makes approx. 12

1. Beat egg and sugar with an electric mixer until light and creamy.
2. Add flour, milk and salt and beat until smooth.
3. Heat skillet on MED/MAX setting. Melt a little butter in skillet and wipe away any excess with paper towelling.
4. Spoon heaped spoonfuls of batter in skillet and cook on both sides until golden.
5. Serve with butter, jam, cream or chocolate hazelnut spread.

For savoury pikelets: Reduce sugar to 2 tablespoons and stir through chopped fresh herbs of choice. Top with slices of prosciutto, goats cheese and rocket, or cream cheese, smoked salmon and capers.

Skillet recipes continued

Scrambled Eggs

4 large eggs
2/3 cup thickened cream
Salt and freshly ground black pepper
20g butter
Toast, to serve

1. In a medium bowl, whisk the eggs, cream, salt and pepper until well combined. Heat butter in skillet over a medium heat until it bubbles.
2. Pour in the egg mixture and cook, stirring with a wooden spoon, until the eggs are just starting to firm but are still quite moist.
3. Serve immediately with hot, buttered toast.

Sweet Crepes

Makes approx. 16 crepes

3 eggs
60g butter, melted
1 3/4 cups milk
250g plain flour
2 tablespoons caster sugar

1. Place crepe ingredients into a blender jug and blend on low for about 20 seconds or until combined. Strain into a jug and stand for 30 minutes.
2. Heat skillet on MED/MAX setting. Pour about 1/4 cup of batter into the greased pan. Tilt the pan to spread the mixture evenly. Cook over a low heat on both sides until golden. Repeat with remaining mixture.
3. Serve crepes with lemon juice and sugar or hazelnut spread.

Serves 2

Omelette with Porcini Mushrooms

Serves 2

40g dried porcini mushrooms
4 eggs
Salt and freshly ground black pepper
butter
1/4 cup grated parmesan cheese

1. Soak mushrooms in hot water for 10 minutes; drain and roughly chop.
2. Whisk eggs, mushrooms, salt and pepper in a medium bowl until combined.
3. Melt butter in skillet on MED/MAX setting; once bubbles have subsided pour in egg mixture. Once the egg mixture has begun to cook underneath use a wooden spoon to bring in the edges of the egg mixture into the centre of the skillet (this creates height in your omelette). Do this 2-3 times then allow the omelette to brown slightly underneath and almost set on the top.
4. Sprinkle the cheese over half of the omelette, then using a spatula, carefully fold the omelette in half. Cook for a further 30 seconds.
5. Carefully tip omelette onto a serving plate.

12 Month Replacement Guarantee

This Sunbeam product is covered by a 12 month replacement or repair warranty, which is in addition to your rights under the Australian Consumer Law (if your product was purchased in Australia) or New Zealand Consumer Guarantees Act (if your product was purchased in New Zealand).

Upon receipt of your claim, Sunbeam will seek to resolve your difficulties or, if the product is defective, advise you on how to obtain a replacement or refund.

To assist us in managing warranty claims, we recommend you register your product as soon as practicable after purchase by creating a MySunbeam account on our website and uploading a copy of your original receipt.

In order to make a claim under our warranty, you must have the original proof of purchase documentation for the product and present it when requested (if not already uploaded to our website).

Should your product develop any defect within 12 months of purchase because of faulty materials or workmanship, we will replace or repair it, at our discretion, free of charge. A product presented for repair may be replaced by a refurbished product of the same type rather than being repaired. Refurbished parts may be used to repair the product.

Our replacement or repair warranty only applies where a defect arises as a result of faulty material or workmanship during the warranty period. Your warranty does not cover misuse or negligent handling (including damage caused by failing to use the product in accordance with this instruction booklet), accidental damage, or normal wear and tear.

Your warranty does not:

- cover freight or any other costs incurred in making a claim, consumable items, accessories that by their nature and limited lifespan require periodic renewal (such as filters and seals) or any consequential loss or damage; or
- cover damage caused by:
 - power surges, power dips, voltage supply problems, or use of the product on incorrect voltage;

- servicing or modification of the product other than by Sunbeam or an authorised Sunbeam service centre;
- use of the product with other accessories, attachments, product supplies, parts or devices that do not conform to Sunbeam specifications; or
- exposure of the product to abnormally corrosive conditions; or

- extend beyond 3 months if the product is used in commercial, industrial, educational or rental applications.

The benefits given to you by our warranty are in addition to other rights and remedies under law in relation to the product.

In Australia our goods come with guarantees that cannot be excluded under the Australian Consumer Law. You are entitled to a replacement or refund for a major failure and for compensation for any other foreseeable loss or damage. You are also entitled to have the goods repaired or replaced if the goods fail to be of acceptable quality and the failure does not amount to a major failure.

Our goods also come with guarantees that cannot be excluded under the New Zealand Consumer Guarantees Act.

If your warranty claim is not accepted, we will inform you and if requested to do so by you, repair the product provided you pay the usual charges for such repair. You will also be responsible for all freight and other costs.

Should your product require repair or service after the warranty period, contact your nearest Sunbeam service centre. For a complete list of Sunbeam's service centres, visit our website or call our customer service line for advice on 1300 881 861 in Australia, or 0800 786 232 in New Zealand.

Should you experience any difficulties with your product during the warranty period, please contact our customer service line for advice on 1300 881 861 in Australia, or 0800 786 232 in New Zealand.

Australia

www.sunbeam.com.au
1300 881 861
Units 5 & 6,
13 Lord Street,
Botany NSW 2019
Australia

New Zealand

www.sunbeam.co.nz
0800 786 232
Level 6, Building 5,
Central Park,
660-670 Great South Road,
Greenlane, Auckland
New Zealand

Need help with your appliance?

Contact our customer service team or visit our website for information and tips on getting the most from your appliance.

Australia | **visit** www.sunbeam.com.au
phone 1300 881 861
mail Units 5 & 6, 13 Lord Street,
Botany NSW 2019 Australia.

New Zealand | **visit** www.sunbeam.co.nz
phone 0800 786 232
mail Level 6, Building 5,
Central Park,
660-670 Great South Road,
Greenlane, Auckland.

Sunbeam Corporation Limited | ABN 45 000 006 771
Sunbeam Corporation is a division of GUD Holdings Limited.

DuraCeramic is a trade mark of Sunbeam Corporation.

Sunbeam is a registered trade mark.

Made in China to Sunbeam's specification.

Due to minor changes in design or otherwise,
the product you buy may differ slightly from the one shown here.

Approved by the appropriate electrical regulatory authorities.

©Sunbeam Corporation Limited 2016.

05/16
GCDS-SUN45907-SL