

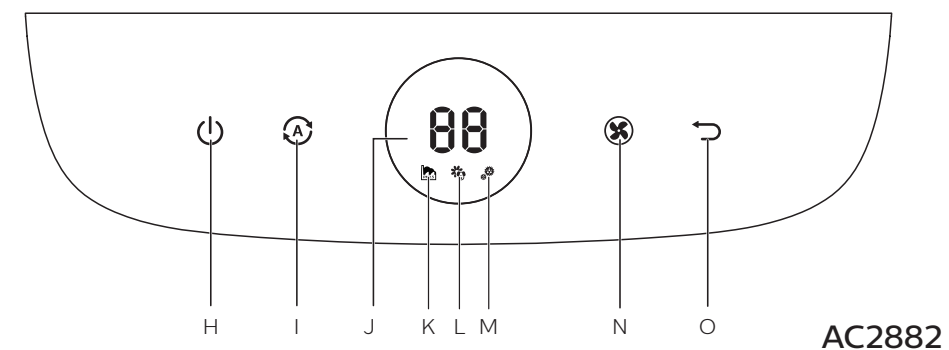

PHILIPS
AC2887
AC2882

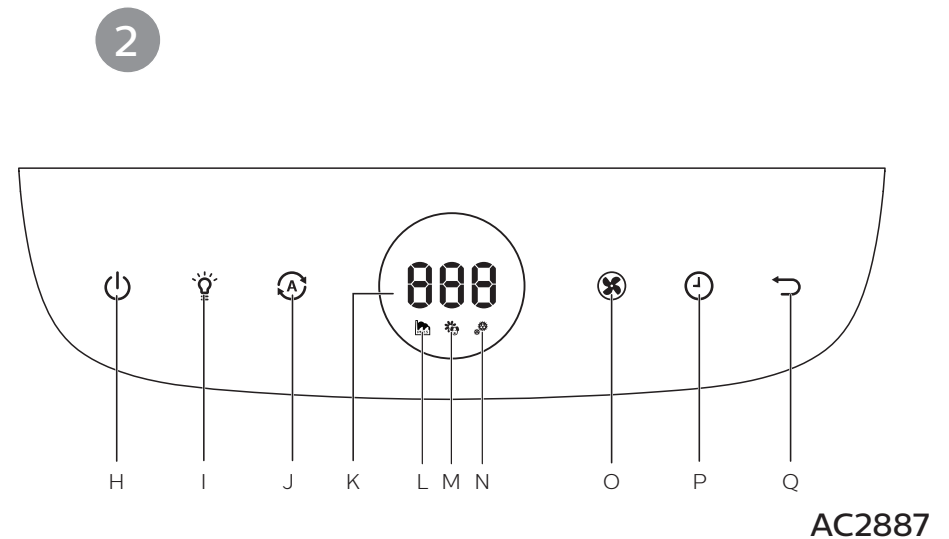

User manual

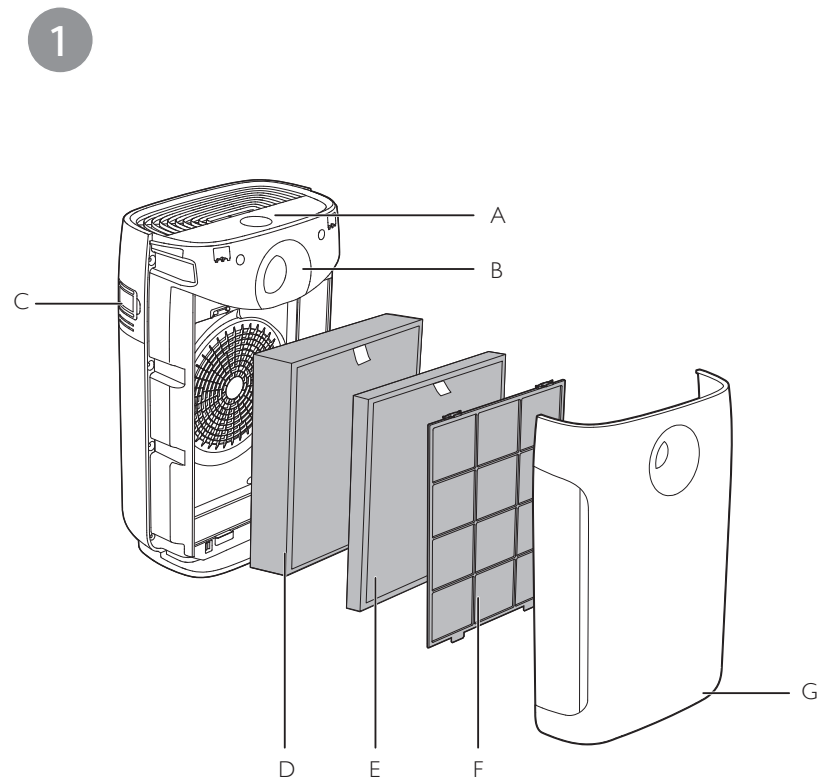

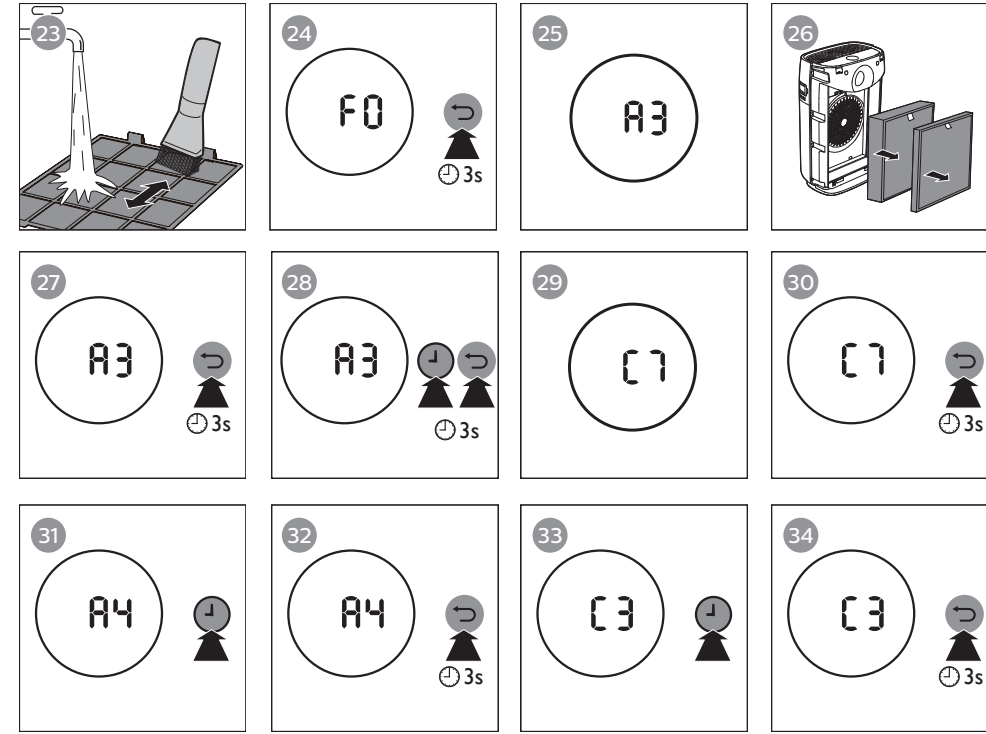
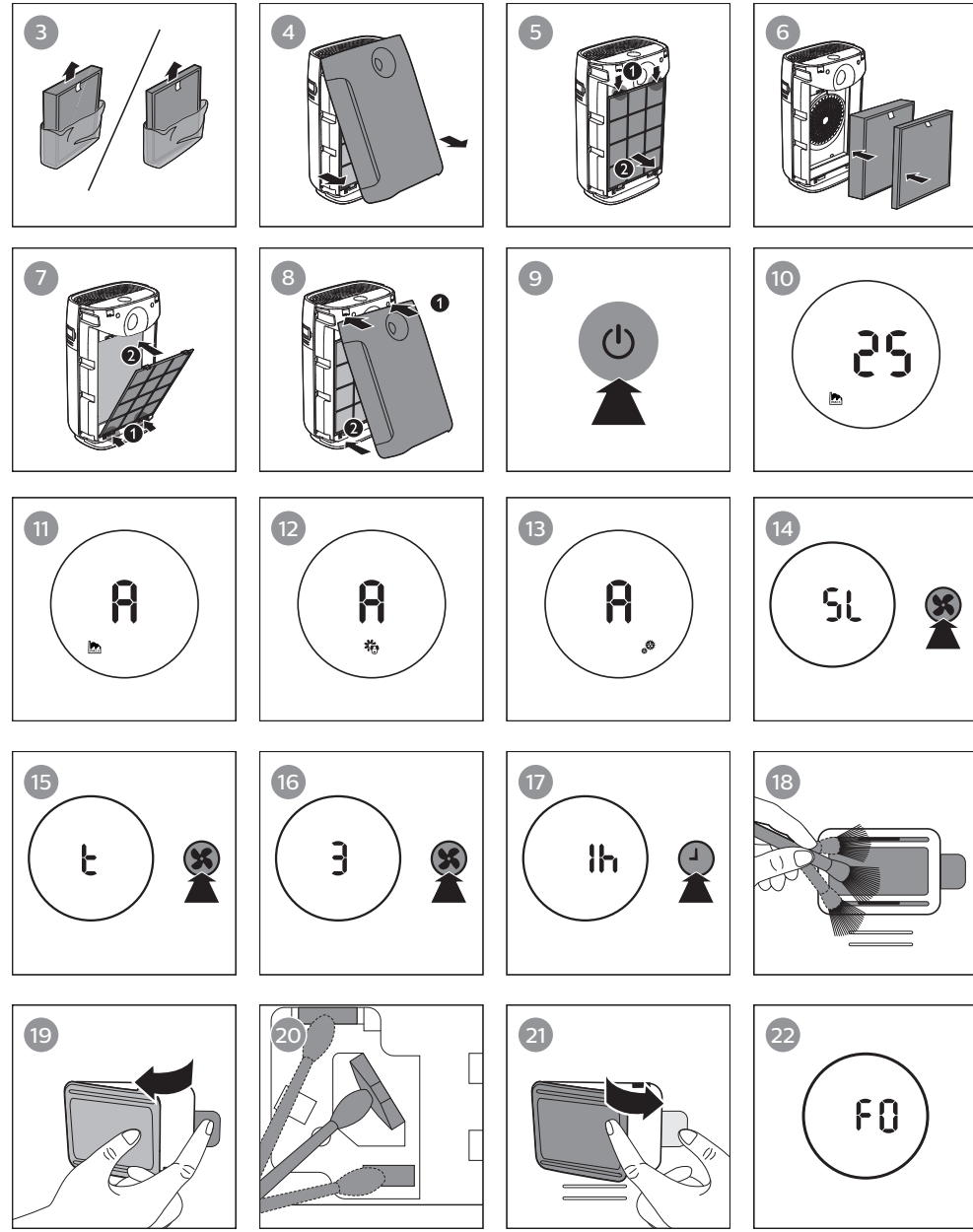

Contents

1 Important	2
Safety	2

2 Your air purifier	5
Product overview (fig. ①)	5
Controls overview (fig. ②)	5

3 Getting started	6
Installing filters	6

4 Using the appliance	6
Understanding the air quality light	6
Switching on and off	6
Changing the Auto mode setting	7
Changing the fan speed	7
Setting the timer	8
Using the light on/off function	8

5 Cleaning	9
Cleaning schedule	9
Cleaning the body of the appliance	9
Cleaning the air quality sensor	9
Cleaning the pre-filter (fig. ②②)	9

6 Replacing the filter	10
Understanding the healthy air protect lock	10
Replacing the filters (fig. ②⑤)	10
Filter force reset	11
Filter type change	11

7 Troubleshooting	13
--------------------------	-----------

8 Guarantee and service	15
Order parts or accessories	15

9 Notices	15
Electromagnetic fields (EMF)	15
Recycling	16

1 Important

Safety

Read this user manual carefully before you use the appliance, and save it for future reference.

Danger

- Do not let water or any other liquid or flammable detergent enter the appliance to avoid electric shock and/or a fire hazard.
- Do not clean the appliance with water, any other liquid, or a (flammable) detergent to avoid electric shock and/or a fire hazard.
- Do not spray any flammable materials such as insecticides or fragrance around the appliance.

Warning

- Check if the voltage indicated on the appliance corresponds to the local power voltage before you connect the appliance.

- If the power cord is damaged, you must have it replaced by Philips, a service center authorized by Philips, or similarly qualified persons in order to avoid a hazard.
- Do not use the appliance if the plug, the power cord, or the appliance itself is damaged.
- This appliance can be used by children aged from 8 years and above and persons with reduced physical, sensory or mental capabilities or lack of experience and knowledge if they have been given supervision or instruction concerning use of the appliance in a safe way and understand the hazards involved. Child shall not play with the appliance. Cleaning and maintenance shall not be made by children without supervision.
- Do not block the air inlet and outlet, e.g. by placing items on the air outlet or in front of the air inlet.

- Make sure that foreign objects do not fall into the appliance through the air outlet.

Caution

- This appliance is not a substitute for proper ventilation, regular vacuum cleaning, or use of an extractor hood or fan while cooking.
- If the power socket used to power the appliance has poor connections, the plug of the appliance becomes hot. Make sure that you plug the appliance into a properly connected power socket.
- Always place and use the appliance on a dry, stable, level, and horizontal surface.
- Leave at least 20cm free space behind and on both sides of the appliance and leave at least 30cm free space above the appliance.
- Do not place anything on top of the appliance.
- Do not sit or stand on the appliance. Sitting or standing on the appliance may lead to potential injury.
- Do not place the appliance directly below an air conditioner to prevent condensation from dripping onto the appliance.
- Make sure all filters are properly installed before you switch on the appliance.
- Only use the original Philips filters specially intended for this appliance. Do not use any other filters.
- Combustion of the filter may cause irreversible human hazard and/or jeopardize other lives. Do not use the filter as fuel or for similar purpose.
- Avoid knocking against the appliance (the air inlet and outlet in particular) with hard objects.
- Always lift or move the appliance by the handle on back side of the appliance.

- Do not insert your fingers or objects into the air outlet or the air inlet to prevent physical injury or malfunctioning of the appliance.
- Do not use this appliance when you have used indoor smoke-type insect repellents or in places with oily residues, burning incense, or chemical fumes.
- Do not use the appliance near gas appliances, heating devices or fireplaces.
- Always unplug the appliance after use and before cleaning, or carrying out other maintenance or replacing the filters.
- Do not use the appliance in a room with major temperature changes, as this may cause condensation inside the appliance.
- To prevent interference, place the appliance at least 2 meters away from electrical appliances that use airborne radio waves such as TVs, radios, and radio-controlled clocks.
- The appliance is only intended for household use under normal operating conditions.
- Do not use the appliance in wet surroundings or in surroundings with high ambient temperatures, such as the bathroom, toilet, or kitchen.
- The appliance does not remove carbon monoxide (CO) or radon (Rn). It cannot be used as a safety device in case of accidents with combustion processes and hazardous chemicals.
- If you need to move the appliance, disconnect the appliance from the power supply first.
- Do not move the appliance by pulling its power cord.
- Always cleanse your hands after changing the filters.

2 Your air purifier

Congratulations on your purchase, and welcome to Philips!

To fully benefit from the support that Philips offers, register your product at www.philips.com/welcome.

Product overview (fig. ①)

- A Control panel
- B Air quality light
- C Air quality sensors
- D NanoProtect filter HEPA Series 3 (FY2422)*
- E NanoProtect filter AC (FY2420)*
- F Pre-filter
- G Front panel

* Hereinafter referred to as air purification filter

Controls overview (fig. ②)

For AC2887

- H On/Off button
- I Light dimming button
- J Auto mode button
- K Display screen
- L General mode icon
- M Allergen mode icon
- N Bacteria&Virus mode icon
- O Fan speed button
- P Timer button
- Q Reset button

For AC2882

- H On/Off button
- I Auto mode button
- J Display screen
- K General mode icon
- L Allergen mode icon
- M Bacteria&Virus mode icon
- N Fan speed button
- O Reset button

3 Getting started

Installing filters

Note

- Make sure that the appliance is unplugged before installing the filters.

Before using the appliance, remove all packaging materials of the filters and place the filters into the appliance as described as follows.

Note

- Make sure that the side with the tag is pointing towards you.

- 1 Remove all packaging materials of the air purification filters (fig. ③).
 - 2 Pull the bottom part of the front panel to remove it from the appliance (fig. ④).
 - 3 Press the two clips down and pull the pre-filter towards you (fig. ⑤).
 - 4 Put the unpacked air purification filters back into the appliance (fig. ⑥).
 - 5 Put the pre-filter back into the appliance (fig. ⑦).
- #### Note
- Make sure that the side with the two clips is pointing towards you, and that all hooks of the pre-filter are properly attached to the purifier.
- 6 To reattach the front panel, mount the panel onto the top of the appliance first (1). Then, gently push the panel against the body of the appliance (2) (fig. ⑧).



4 Using the appliance

Understanding the air quality light

Air quality light color	Air quality level
Blue	Good
Blue-Purple	Fair
Purple-Red	Poor
Red	Very poor

The air quality light automatically goes on when the appliance is switched on, and lights up all colors in sequence. In a short time the air quality sensors select the color that corresponds to the ambient air quality.

Switching on and off

- 1 Put the plug of the appliance in the power socket.
- 2 Touch  to switch on the appliance (fig. ⑨).
 - ↳ The appliance beeps.
 - ↳ The appliance operates under the General mode by default.
 - ↳ After measuring the air quality for a short time, the air quality sensor automatically selects the color of the air quality light.
 - ↳ For AC2887, "---" displays on the screen when the appliance is warming up. After measuring the particle matters in the air, the appliance goes to auto mode with  displayed on the screen (fig. ⑩).



- ↳ For AC2882, after measuring the particle matters in the air, the appliance goes to auto mode with  displayed on the screen (fig.11).

3 Touch and hold  for 3 seconds to switch off the appliance.

Note



- After the appliance is switched off by the on/off button , if the plug is still in the power socket, the appliance will operate under the previous settings when it is switched on again.

Changing the Auto mode setting

You can choose the General mode () , the Allergen mode () and the Bacteria&Virus mode () .



General mode

A smart auto-setting that automatically adjusts the air purifier's settings to the ideal level.

- Touch the Auto mode button  to select the General mode (fig.11).
 - ↳ Auto () and  display on the screen.



Allergen mode

The specially designed Allergen mode can effectively remove common allergens such as pollen and pet dander.



- Touch the Auto mode button  to select the Allergen mode (fig.12).
 - ↳ Auto () and  display on the screen.

Bacteria&Virus mode

This specially designed mode can help remove particles which are the size of certain bacteria and viruses. Tested with Staphylococcus albus and Influenza A (H1N1) only.



- Touch the Auto mode button  to select the Bacteria&Virus mode (fig.13).
 - ↳ Auto (A) and  display on the screen.

Changing the fan speed



There are several fan speeds available. You can choose the Sleep mode () , speed 1, 2, 3 or Turbo mode () .

Sleep (SL)

In Sleep mode, the appliance operates quietly under very low speed.

- Touch the fan speed button  to select the Sleep mode () (fig.14).

Note



- In sleep mode, " SL" displays on the screen for one minute. After that, all the lights will go off and the display screen will be dimmed with "" displayed.
- You can turn on the lights manually by touching .

Manual

- Touch the fan speed button  repeatedly to select the fan speed you need (fig.16).

Turbo (t)

In Turbo mode, the appliance operates under the highest speed.

- Touch the fan speed button  to select the turbo mode () (fig. 15).

Setting the timer

Note

- The timer function is only applicable for AC2887.

With the timer, you can let the appliance operate for a set number of hours. When the set time has elapsed, the appliance will automatically switch off.

- Touch the timer button  repeatedly to choose the number of hours you want the appliance to operate (fig. 17).
 - ↳ The timer is available from 1 to 12 hours.

To deactivate the timer, touch the timer button  repeatedly until "----" displays on the screen.

Note



- If you have set the timer once, next time when you use the timer, it starts from the previous setting time.

Using the light on/off function

Note

- The light dimming function is only applicable for AC2887.

With the light dimming button, you can switch on or off the air quality light, the display screen and the function indicators if needed.

- 1 Touch the light dimming button  once, the air quality light will be dimmed.
- 2 Touch the light dimming button  again, the air quality light will go off. The display screen and the function indicators will still be on, but the lights will be dimmed with "—" displayed on the screen.
- 3 Touch the light dimming button  for the third time, all lights will be on again.

5 Cleaning

Note

- Always unplug the appliance before cleaning.
- Never immerse the appliance in water or any other liquid.
- Never use abrasive, aggressive, or flammable cleaning agents such as bleach or alcohol to clean any part of the appliance.
- Only the pre-filter is washable. The air purification filter is not washable nor vacuum cleanable.

Cleaning schedule

Frequency	Cleaning method
When necessary	Wipe the surface of the appliance with a soft dry cloth
When FO displays on the screen	Clean the pre-filter
Every two months	Clean the air quality sensors

Cleaning the body of the appliance

Regularly clean the inside and outside of the appliance to prevent dust from collecting.

- 1 Wipe away dust with a soft dry cloth from the body of the appliance.
- 2 Clean the air outlet with a soft dry cloth.

Cleaning the air quality sensor

Clean the air quality sensor every 2 months for optimal functioning of the purifier. Clean them more frequently if you use the purifier in a dusty environment.

Note

- When the humidity level in the room is very high, it is possible that condensation develops on the air quality sensor. As a result, the air quality light may indicate that the air quality is bad even though it is good. In this case you have to clean the air quality sensor or use one of the manual speed settings.

- 1 Clean the air quality sensor inlet and outlet with a soft brush (fig. 18).
- 2 Remove the air quality sensor cover (fig. 19).
- 3 Clean the air quality sensor, the dust inlet and the dust outlet with a lightly moistened cotton swab (fig. 20).
- 4 Dry them with a dry cotton swab.
- 5 Reattach the air quality sensor cover (fig. 21).

Cleaning the pre-filter (fig. 22)

Filter alert light status	Follow this
FO displays on the screen	Clean the pre-filter

- 1 Pull the bottom part of the front panel to remove it from the appliance (fig.④).
- 2 Press the two clips down and pull the pre-filter towards you (fig.⑤).
- 3 Wash the pre-filter under a running tap. If the pre-filter is very dirty, use a soft brush to brush away the dust (fig.②③).
- 4 Air dry the pre-filter.

Note

- Make sure that the pre-filter is completely dry. If it is still wet, bacteria may multiply in it and shorten the lifetime of the pre-filter.
- Cleanse your hands after changing the filter.

- 5 Put the pre-filter back into the appliance (fig.⑦).

Note

- Make sure that the side with the two clips is pointing towards you, and that all hooks of the pre-filter are properly attached to the purifier.

- 6 To reattach the front panel, mount the panel onto the top of the appliance first (1). Then, gently push the panel against the body of the appliance (2) (fig.⑧).
- 7 Touch and hold the reset button  for 3 seconds to reset the pre-filter cleaning time (fig.②④).

6 Replacing the filter

Understanding the healthy air protect lock

This appliance is equipped with the healthy air protect lock to make sure that the air purification filter is in optimal condition when the appliance is operating. When the filters are almost expired, the filter code displays on the screen to indicate that you need to replace the filters.

If the filters are not replaced in 14 days, the appliance will stop operating and get locked.

Replacing the filters (fig.②⑤)

Note

- The air purification filters are not washable nor vacuum cleanable.
- Switch off the appliance before replacing the filters.

Filter alert light status	Follow this
A3 displays on the screen	Replace the NanoProtect filter HEPA Series 3 (FY2422)
C7 displays on the screen	Replace the NanoProtect filter AC (FY2420)
A3 and C7 display on the screen alternately	Replace both filters

- 1 Take out the expired air purification filter according to the filter code displayed on the screen, and gently put the expired filter into the trash bin (fig. 26).

Note



- Do not touch the pleated filter surface, or smell the filters as they have collected pollutants from the air.



- 2 Remove all packaging material of the new filters (fig. 3).
- 3 Place the new filters into the appliance (fig. 6).
- 4 Touch and hold the reset button  for 3 seconds to reset the filter lifetime counter (fig. 27).

Note





- Cleanse your hands after changing the filter.

Filter force reset

- 1 Touch  and  simultaneously for 3 seconds to enter the filter force reset mode (fig. 28).
 - ↳ Code (A3) of the NanoProtect filter HEPA Series 3 displays on the screen.



- 2 Touch and hold  for 3 seconds to force reset the filter lifetime of the NanoProtect filter HEPA Series 3 (fig. 27).
- 3 Code (C7) of the NanoProtect filter AC displays on the screen after the lifetime of the NanoProtect filter HEPA Series 3 has been reset (fig. 29).
- 4 Touch and hold  for 3 seconds to force reset the filter lifetime of the NanoProtect filter AC and exit the filter force reset mode (fig. 30).

Filter type change

- 1 Touch  and  simultaneously for 3 seconds to enter the filter type change mode (fig. 28).
 - ↳ Code (A3) of the NanoProtect filter HEPA Series 3 displays on the screen.
- 2 Touch  to select the filter code of the new filter you will use (fig. 31).
- 3 Touch and hold  for 3 seconds to confirm the filter code of the new filter (fig. 32).

Note

- After you have selected the filter code of the new filter using the  button, if you do not touch any other buttons in 10 seconds, the appliance will automatically confirm the filter code of the new filter.

- 4 Code (C7) of the Nanoprotect filter AC displays on the screen after the first filter type has been changed (fig. 29).
- 5 Touch  to select the new filter code of the second filter (fig. 33).
- 6 Touch and hold  for 3 seconds to confirm the filter code of the

second filter and exit the filter type change mode (fig. 34).



Note

- After you have selected the filter code of the new filter using the  button, if you do not touch any other buttons in 10 seconds, the appliance will automatically confirm the filter code of the new filter.





Note

- Refer to the separate leaflet that comes with the filter for more information on different filter combinations for your choice.

7 Troubleshooting

This chapter summarizes the most common problems you could encounter with the appliance. If you are unable to solve the problem with the information below, contact the Consumer Care Center in your country.

Problem	Possible solution
The appliance does not work even though it is plugged in.	<ul style="list-style-type: none">The filter replacement code has been displaying on the screen but you have not replaced the corresponding filter yet. The appliance will be locked if you keep using the expired filter. In this case, replace the filter and reset the filter lifetime counter.
The appliance does not work even though it is switched on.	<ul style="list-style-type: none">The filter replacement code has been on continuously but you have not replaced the corresponding filter, and the appliance is now locked. In this case, replace the filter and reset the filter lifetime counter.
The appliance accidentally powers off.	<ul style="list-style-type: none">The appliance restarts automatically and goes to the previous mode when the power resumes.
The airflow that comes out of the air outlet is significantly weaker than before.	<ul style="list-style-type: none">The pre-filter is dirty. Clean the pre-filter (see chapter "Cleaning").
The air quality does not improve, even though the appliance has been operating for a long time.	<ul style="list-style-type: none">One of the filters has not been placed in the appliance. Make sure that all filters are properly installed in the following order, starting with the innermost filter: 1) NanoProtect filter HEPA Series 3; 2) pre-filter.The air quality sensor is wet. The humidity level in your room is high and causes condensation. Make sure that the air quality sensor is clean and dry (see chapter "Cleaning").
The color of the air quality light always stays the same.	<ul style="list-style-type: none">The air quality sensor is dirty. Clean the air quality sensor (see chapter "Cleaning").

Problem	Possible solution
<p>The appliance produces a strange smell.</p>	<ul style="list-style-type: none"> The first few times you use the appliance, it may produce a plastic smell. This is normal. However, if the appliance produces a burnt smell, contact your Philips dealer or an authorized Philips service centre. The appliance may also produce an unpleasant smell when the filter is dirty. In this case, clean or replace the filter concerned.
<p>The appliance is extra loud.</p>	<ul style="list-style-type: none"> If the appliance is too loud, you can change the fan speed to a lower fan speed level. When using the appliance in a bedroom at night, choose the sleep mode.
<p>The appliance still indicates that I need to replace a filter, but I already did.</p>	<ul style="list-style-type: none"> Perhaps you did not reset the filter lifetime counter. Plug in the appliance, touch  to switch on the appliance, and touch and hold the reset button  for 3 seconds.
<p>Error codes "E1", "E2", "E3" or "E4" displays on the screen.</p>	<ul style="list-style-type: none"> The appliance has malfunctions. Contact the Consumer Care Center in your country.

8 Guarantee and service

If you need information or if you have a problem, please visit the Philips website at www.philips.com or contact the Philips Consumer Care Center in your country (you find its phone number in the worldwide guarantee leaflet). If there is no Consumer Care Centre in your country, go to your local Philips dealer.

Order parts or accessories

If you have to replace a part or want to purchase an additional part, go to your Philips dealer or visit www.philips.com/support.

If you have problems obtaining the parts, please contact the Philips Consumer Care Center in your country (you can find its phone number in the worldwide guarantee leaflet).

9 Notices

Electromagnetic fields (EMF)

This Philips appliance complies with all applicable standards and regulations regarding exposure to electromagnetic fields.

Compliance with EMF

Philips Domestic Appliances Holding B.V. manufactures and sells many products targeted at consumers, which, like any electronic apparatus, in general have the ability to emit and receive electromagnetic signals.

One of Philips' leading Business Principles is to take all necessary health and safety measures for our products, to comply with all applicable legal requirements and to stay well within the EMF standards applicable at the time of producing the products.

Philips is committed to develop, produce and market products that cause no adverse health effects. Philips confirms that if its products are handled properly for their intended use, they are safe to use according to scientific evidence available today.

Philips plays an active role in the development of international EMF and safety standards, enabling Philips to anticipate further developments in standardization for early integration in its products.

Recycling

Do not throw away the product with the normal household waste at the end of its life, but hand it in at an official collection point for recycling. By doing this, you help to preserve the environment.

Follow your country's rules for the separate collection of electrical and electronic products. Correct disposal helps prevent negative consequences for the environment and human health.