

EAZE.TALK

FLEXIBLE, INSPIRING,
UNIQUELY COMBINABLE

Removable cushion that can be positioned as desired

Zip is available in 4 colours

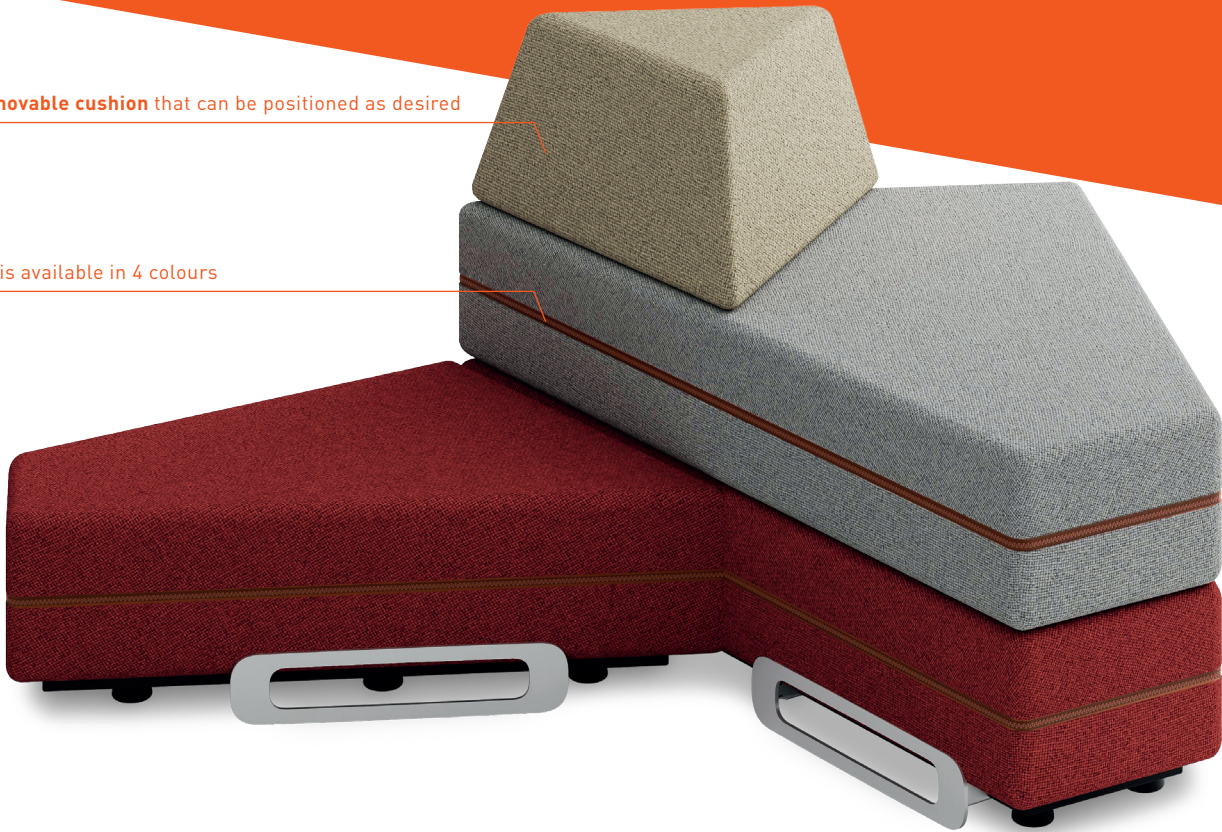

Upholstery bracket for secure positioning

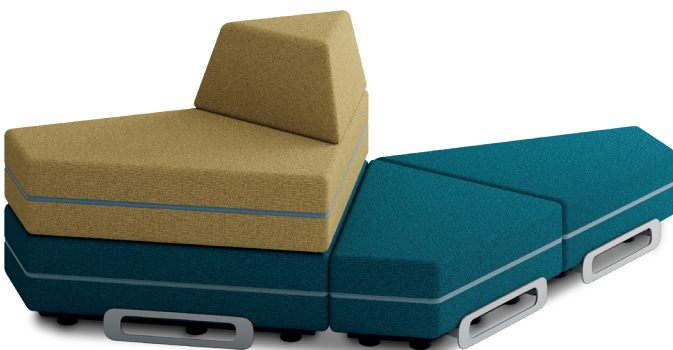

The upholstery can be made in two colours, as you wish.



reddot winner 2026



SYSTEM OVERVIEW

Cushion cover

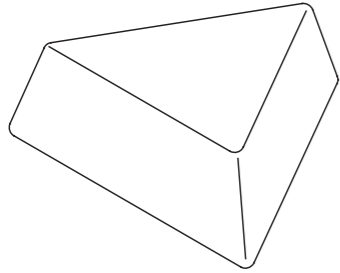

Small cushion
1,040 x 760 x 760 x 280 mm,
cushion height 200 mm

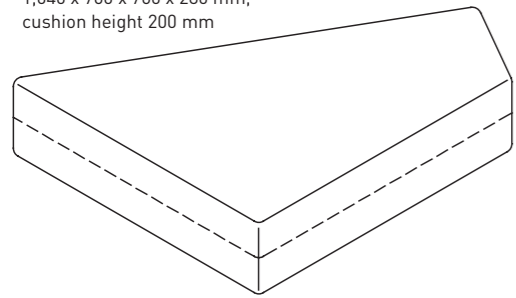

Large cushion
1,420 x 1,040 x 1,040 x 380 mm,
cushion height 200 mm

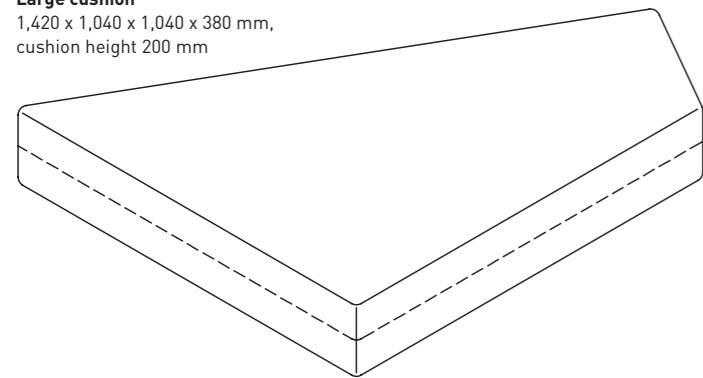

Small base unit

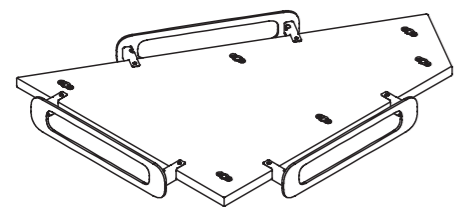

Chaining

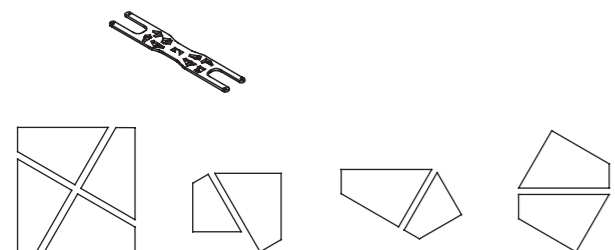

SAMPLE CONFIGURATION

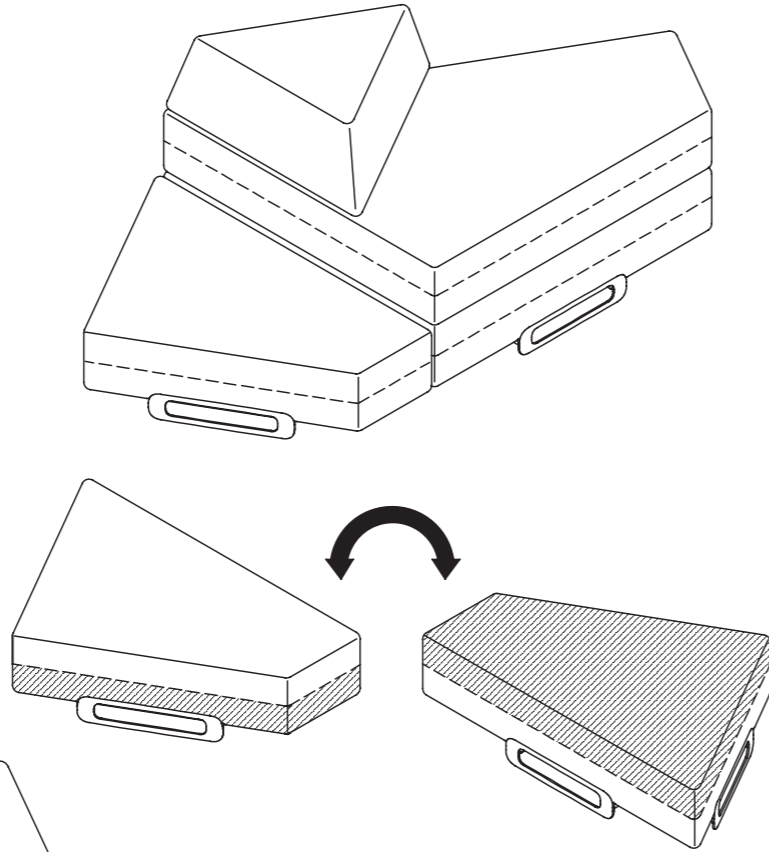

Rotating the base plate and the cushion unit through 180 degrees opens up a whole range of new configuration options. The glides can be repositioned tool-free.

Large base unit

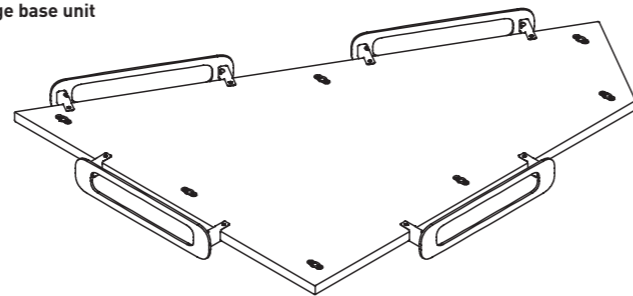

Glides
for carpets or hard floors

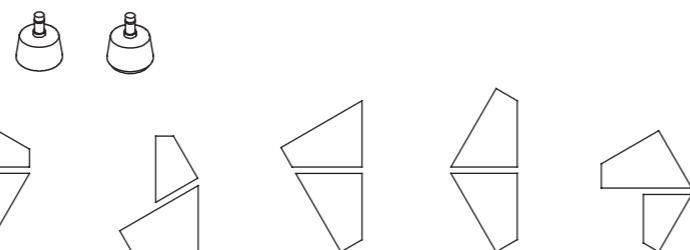

FABRICS AND EXAMPLES OF COMBINATIONS

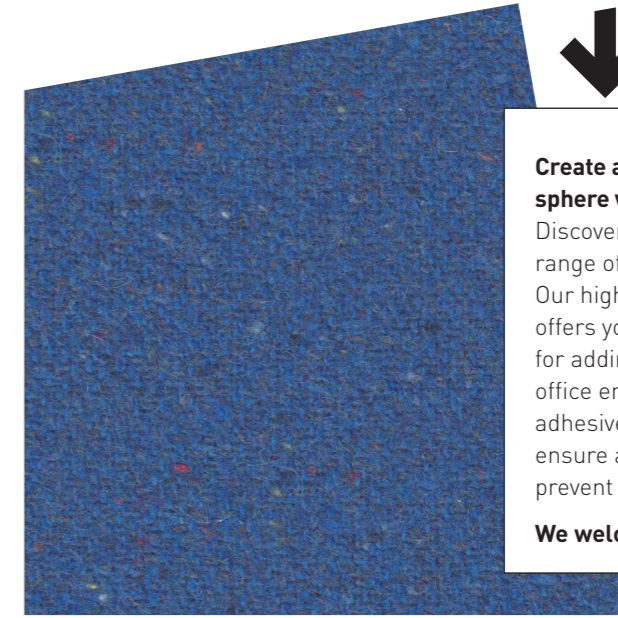
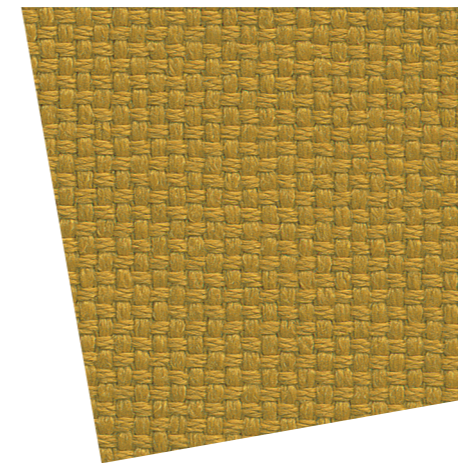
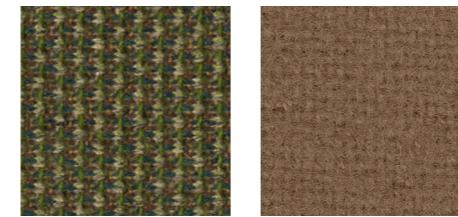
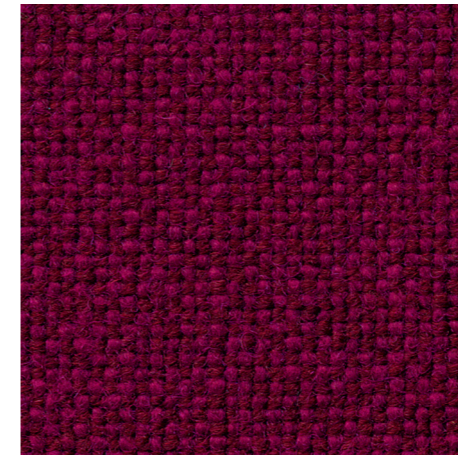
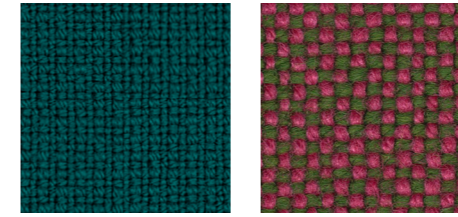

Create a more welcoming atmosphere with cosy, tactile fabrics.
Discover how we combine a wide range of colours with sustainability. Our high-quality fabric collection offers you a wealth of design options for adding splashes of colour to your office environment. The strong self-adhesive properties of each fabric ensure a secure hold and effectively prevent slipping.
We welcome fabric combinations!

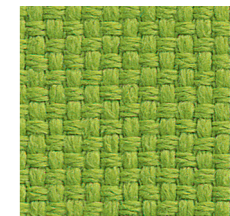
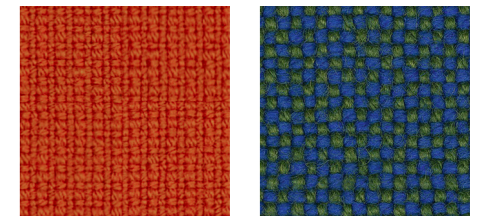
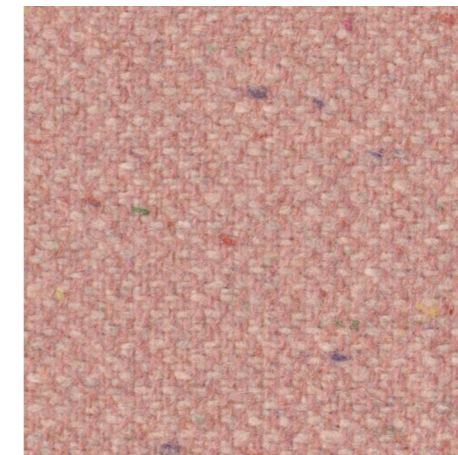

FORM FOLLOWS FLEXIBILITY



All images have been modified using AI

EAZE.TALK INFOCARD



	EAZE.TALK
Basic element	25 mm compressed chipboard, black
Glider	Black, for carpets or hard floors
Chaining	5 mm flat steel, black Length 350 mm, width 60 mm
Upholstery holder	Powder-coated steel
Large cushion	1,420 x 1,040 x 1,040 x 380 mm, cushion height 200 mm
Small cushion	1,040 x 760 x 760 x 280 mm, cushion height 200 mm
Cushion cover	760 x 760 x 760 mm, cushion height 250 mm
Zip	A visible element running around the centre, single-colour top cushion with concealed zip, concealed
Seat height with base unit	1 cushion: 260 mm 2 cushions: 460 mm

1 | SIMPLE CONCATENATION

The base elements are securely connected to one another by the linking element. This creates a stable unit that can also be easily reconfigured if necessary.

1

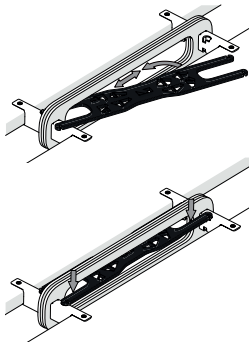

2 | DESIGN FREEDOM

Cushions can be used directly on the floor without a base unit and can be combined in a variety of ways.



3 | BASIC ELEMENT

Base units are available in two sizes. Glides can be fitted on either side of the base panel, allowing it to be rotated and used in a new orientation. Upholstery brackets are available in textured black, textured white, aluminium, metallic anthracite, yellow gold, quartz green, ant red and muted turquoise.

4 | THE ZIP AS A DESIGN FEATURE

The zip can be used to combine two different fabrics or to add a splash of colour between the cushions. This makes it possible to change the cover.

