

BASIC.4 + JET.II + VALYOU

# TRUE EVERYDAY HEROES FOR TEAMWORK AND CONCENTRATION

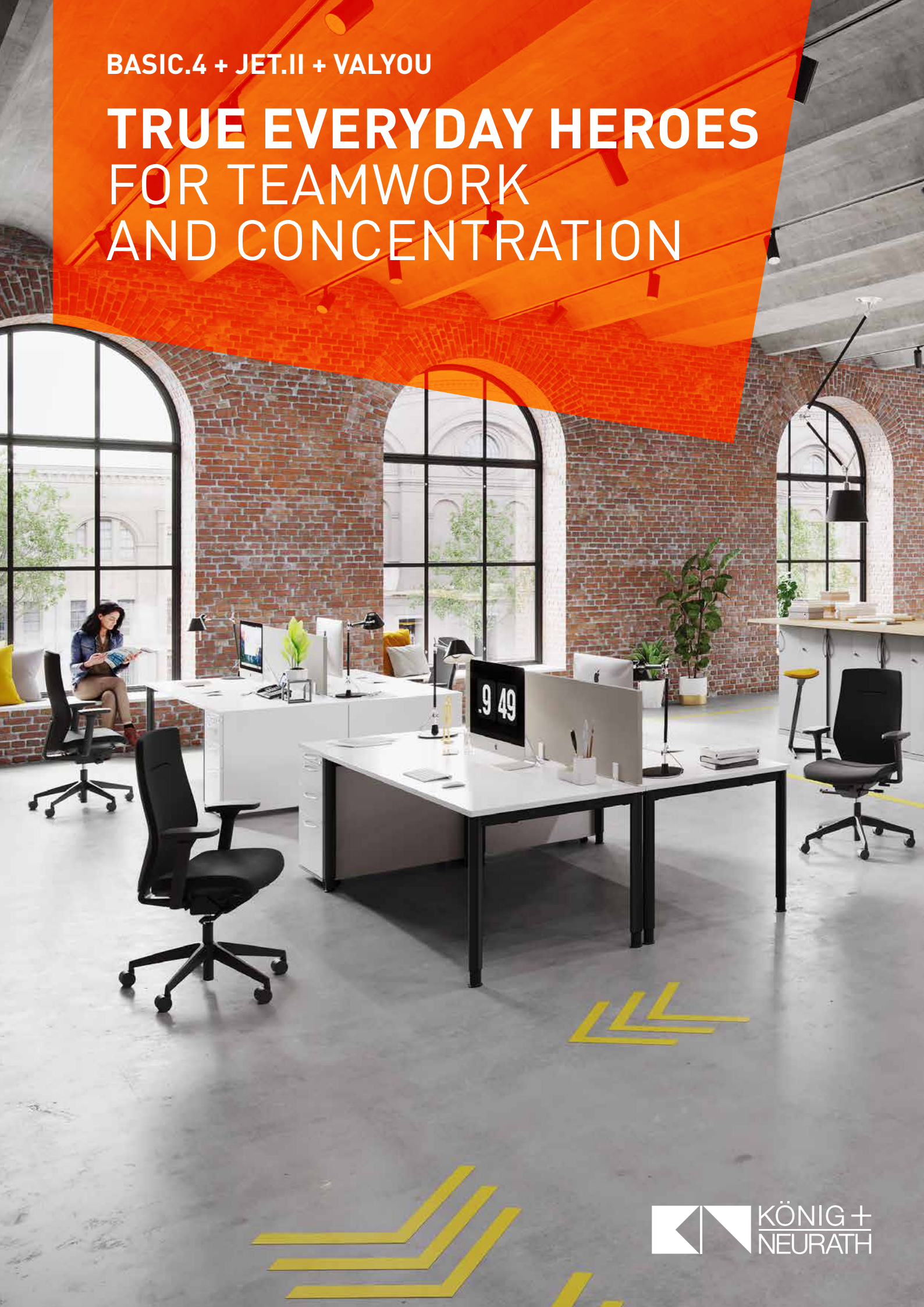



People work effectively and successfully if their environment matches their work culture and supports it. And that's our specialist field!

As one of the leading providers of office furniture, seating and room systems, we develop integrated solutions for individual work cultures.

Dialogue or concentration, team or single workstation: **BASIC.4**, **JET.II** and **VALYOU** are fuss-free partners for a whole range of work scenarios. Reduced to the essentials and pleasantly understated in design, these products are true everyday heroes – without all the hype. See for yourself!

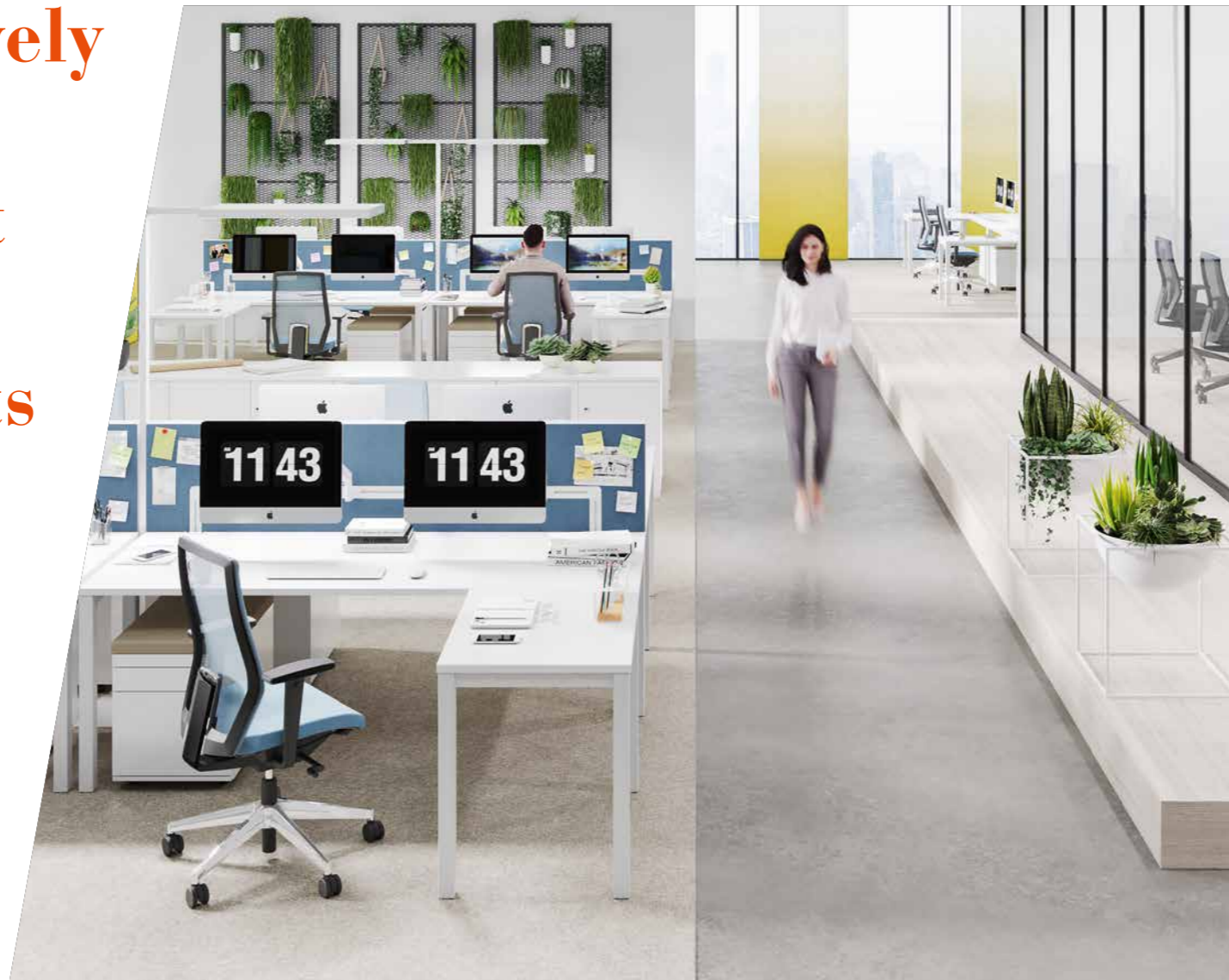





Products:  
BASIC.4, JET.II, pedestals, NET.WORK.PLACE elements,  
MOVE.MIX bar stools, meeting table, HORIZONTE

## TEAMS WORK - AND OUR FURNITURE HELPS THIS HAPPEN!

Many workplace success stories start in a team – as a result of interaction between a variety of skills and characters. It's a smart idea to allow scope for them all! You might assume it's not that easy in an open office environment? You probably think it's either teamwork or concentration? **BASIC.4** and **JET.II** give you the perfect basis to ensure that both can be a success.



Acoustic screens ensure that your employees can concentrate fully – even at team workstations.



# BOTH CONCENTRATED AND OPEN MINDED IN THE OPEN SPACE

Furnishing is straightforward with **BASIC.4** and **JET.II** – so you're ready for anything a day at the office might throw at you. Single workstations in open space offices, with the meeting going on right next door? **BASIC.4** and **JET.II** become an integral part of your design, so you and your employees can rely on them in the most varied situations.



Products:  
BASIC.4, JET.II, pedestals, NET.WORK.PLACE Organic elements,  
QUICK.II, ACTA.CLASSIC, QUIET.BOX Organic



# BEST CHANCES OF SUCCESS FOR YOUR MEETING

Sharing results or driving creativity. Developing something big together – or the little details: meetings can accelerate successes and encourage ideas. We support you in this with BASIC.4 and JET.II: **BASIC.4 as a meeting solution** offers space for materials and gatherings; your team can sit comfortably on **JET.II visitor chairs**. The JET.II family offers a space-saving, easily stored solution that's ideal for those occasional mini meetings: the stacking cantilever variant.

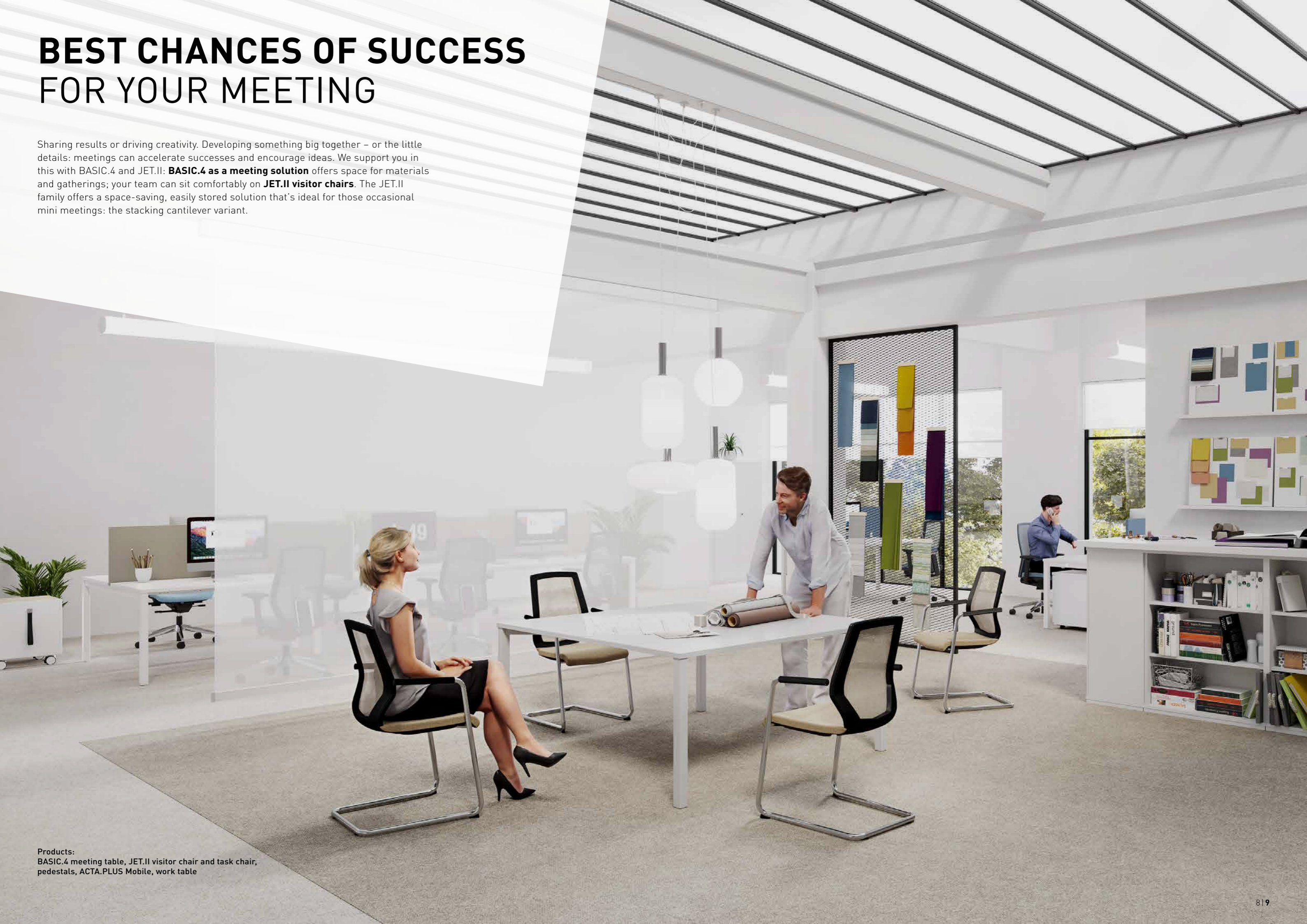

Products:  
BASIC.4 meeting table, JET.II visitor chair and task chair,  
pedestals, ACTA.PLUS Mobile, work table



# YOUR WORKSTATIONS: TEMPORARY. YOUR SUCCESSES: LASTING!

One room. One working day. And the most wide-ranging tasks performed by a rotating team: Stay open-minded – and generous in design! Plentiful ideas and creative dialogue take a seat alongside planning and controlling at the **BASIC.4 bench system**. Ideal for any work culture with a need for temporary workstations and a desire to provide them in an attractive setting.



ACTA.PLUS lockers with a variety of locking mechanisms provide an attractive storage facility for temporary workstations.

Products:  
BASIC.4 bench system, VALYOU, ACTA.PLUS lockers and wardrobe,  
pedestals, NET.WORK.PLACE elements, INSIDE.50 counter, PUBLICA bar stools



Furnishing is straightforward –  
be ready for anything a day  
at the office might throw at you

**BASIC.4**  
**JET.II**  
**VALYOU**

# TRUE EVERYDAY HEROES – WITHOUT ALL THE HYPE

## JET.II

- + Individual weight setting from 45 to 120 kg
- + 2 mechanisms – for any requirements
- + 2 seat upholstery options – hard or soft
- + 4 backrest variants – with or without lumbar support
- + 6 armrests – with different functions and designs
- + Backrest height adjustable through 60 mm



# JET.II, BASIC.4 AND VALYOU



## BASIC.4

- + Modular, functional workstation system
- + Tool-free height adjustment via screw / Allen key
- + 2 leg frame variants – square tube and round tube
- + Adapters for extras such as desk screens and accessories
- + Diverse extensions and add-ons

## VALYOU

- + Weight setting from 45 to 130 kg
- + Ergonomically correct sitting thanks to the Synchronat – automatic adjustment to the body weight
- + Fine adjustment to weight setting and seat height
- + Ready to use or partially assembled – supplied in a transport box





# SINGLE DESK OR BENCH - BASIC.4 GROWS WITH YOUR REQUIREMENTS

**FLYBY SCREEN**  
Fully flexible with tool rail, pinboard function or acoustic option (fitted behind desk)



**DESK SCREEN**  
Also available with tool rail which fits on the adapter



**CPU BRACKET METAL**  
Can be fitted inside or outside the frame

**MODESTY PANEL**  
Retrofittable visual screening, perforated pattern

**SQUARE TUBE**

**SQUARE TUBE MITRED DETAIL**

**ROUND LEG**



**DESK SCREEN WITH TOOL RAIL**  
Strong enough to support a variety of storage elements



**DESK SCREEN WITH RAIL**  
For sturdy mounting of flatscreens or shelf elements



**DESK SCREEN**  
Suitable for use as a central divider



**CLAMP-ON SCREEN**  
For screening from the sides

**ACOUSTIC SCREEN**  
Free-standing with metal tray and felt pad

**HEADER TOP**  
Extension to increase desk space

**DISCOVER**  
more screen variants for visual and acoustic protection in our product portfolio

**SQUARE TUBE**  
Mitre-cut frame with floating desk top

**SQUARE TUBE FRAME**  
With floating desk top

**STANDARD SQUARE TUBE FRAME**  
With flush-fitting desk top

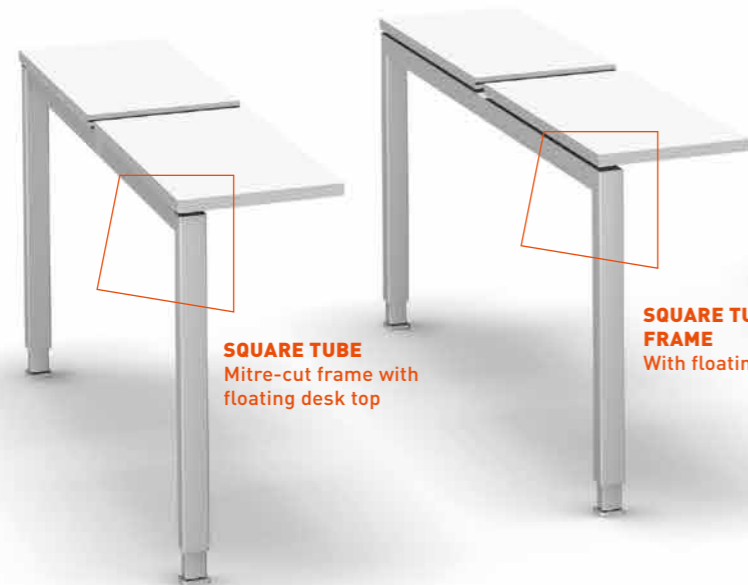



# DETAILS

**1 | SHADOW GAP**

Premium look thanks to square tube mitre-cut frame – available with 13 mm or 25 mm worktop.



1

**2 | FRAME TYPES**

Square tube or round tube – available with 13 mm or 25 mm worktop.



2

**6 | FIXED HEIGHT**

720 mm for leg frame without height adjustment.



6

**7 | INCREMENTAL HEIGHT ADJUSTMENT**

Spring-assisted height-adjustment from 650 to 850 mm.



7

**8 | INFINITELY VARIABLE HEIGHT ADJUSTMENT**

Integral screw thread allows infinitely variable adjustment – round tube frame 680 to 760 mm, square frame 680 to 820 mm.



8

**3 | TOOL-FREE ASSEMBLY**

Worktop attaches with clips so it can be lifted off easily without tools.



3

**4 | CPU-HOLDER**

Can be mounted on the inside or outside of the frame as required.



4



6



7



8

**5 | BOLTED FRAMES**

Sturdy and simple to assemble, reconfigure and transport.

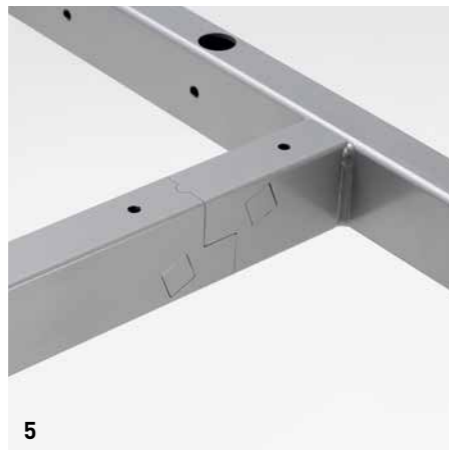

5



5



9



9

**9 | ADAPTER**

Allows a variety of screens and socket variants to be attached.



# DETAILS

**10 | DESK SCREEN WITH RAIL**  
For attaching flatscreens.

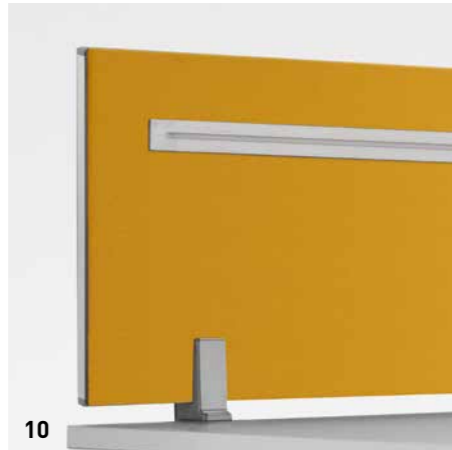

**11 | RAIL ON BOTH SIDES**  
Can be used for organiser elements or flatscreen holders – with intelligent cable management.



**12 | MODESTY PANEL**  
For visual screening of the area below the desk, perforated pattern – retrofittable.



**13 | FABRIC-COVERED DESK SCREEN**  
Available in various colours and with aluminium tool rail.

**14 | CABLE COVER**  
Easy push-to-open feature with socket mounting strip including four-gang socket.



# DETAILS DOUBLE BENCH DESK TOP

**15 | BRUSH SEAL**  
Allows cables to be concealed and positioned exactly where needed.

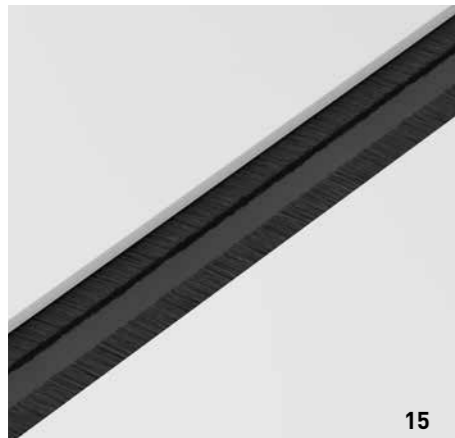

**16 | BRUSH SEAL WITH RECESS**  
For precise positioning of a large number of cables.

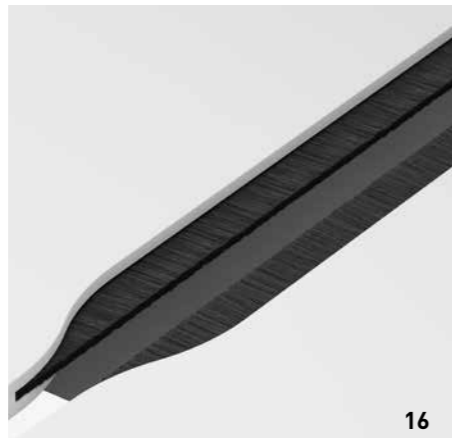

**17 | OPEN SLIDING TOP**  
Easy access to the central cable tray and electrics.

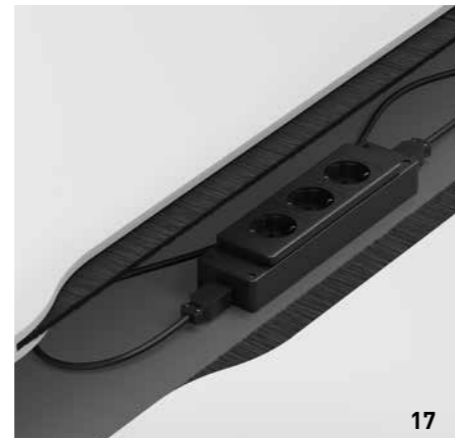

# POSSIBLE COMBINATIONS

**3-seater workstation**  
with visual screening for focused working (leg frame: square tube with floating desk top)



**Bench system for meetings**  
with header top and mobile screens (leg frame: square tube, mitre-cut, with floating desk top)

**Bench system for temporary working**  
with header top for meetings, centre screens and clip-on panels plus shortened central leg frame (leg frame: square tube)





# SURFACE FINISHES

DESK TOP SURFACES			FRAME COLOURS	
MFC SOLID COLOUR	MFC WOOD EFFECT	VEENER	POWDER-COATED METAL	TEXTURED FINISH
				
<b>GK</b> Grey	<b>AA</b> Acacia	<b>AH</b> Canadian maple unstained	<b>AL</b> Aluminium coloured	<b>KSS</b> Black
				
<b>GW</b> Off-white	<b>AO</b> Maple	<b>BH</b> Beech unstained	<b>AM</b> Anthracite metallic	
				
<b>KH</b> Light grey	<b>ET</b> Oak natural	<b>CK</b> American cherry	<b>GC</b> Chrome	
				
<b>KT</b> Aluminium coloured	<b>MB</b> Beech	<b>EN</b> Oak natural	<b>GK</b> Grey	
				
<b>UM</b> Melange	<b>NM</b> Walnut	<b>SN</b> American walnut natural	<b>GW</b> Off-white	
				
<b>WI</b> Pure white	<b>UL</b> Elm		<b>KH</b> Light grey	
				
			<b>KS</b> Black RAL 9011	
				
			<b>WI</b> Pure white	

Subject to technical and programme alterations, printing and other errors. Printed colours may vary from actual colours.

# PRODUCT OVERVIEW

		Single workstation	Bench
<b>Legs/Frame</b>			
Square tube	With loosely laid desk top	■	■
	With floating desk top	-	□
	With floating desk top and mitre cut	■	□
Round tube	With loosely laid desk top	■	-
<b>Dimensions single workstation</b>			
Widths	800 mm, 1000 mm, 1200 mm, 1600 mm, 1800 mm, 2000 mm	■	-
Depths	600 mm, 800 mm, 900 mm, 1000 mm	■	-
<b>Dimensions bench</b>			
Widths	1200 mm, 1400 mm, 1600 mm, 1800 mm, 2000 mm	-	■
Depths	Single bench 800 mm, double bench 1600 mm	-	■
<b>Height adjustment</b>			
Fixed	720 mm with 13 mm top	□	-
	732 mm with 25 mm top	□	■
Increments	Adjustable in 20 mm increments between 650 mm and 850 mm with Allen key supplied	□	-
Infinitely variable	From 680 to 760 mm by rotating the foot of the round leg, from 680 to 820 mm for the square leg	■	□
<b>Worktop</b>			
Chipboard	13 mm or 25 mm thick MFC panel, removable without tools	■	-
	25 mm thick MFC panel, removable without tools	-	■
Veneer	25 mm thick veneered panel, removable without tools	■	-
<b>Electrics</b>			
Horizontal	Cable tray or cable clip	□	□
Vertical	Umbilical	□	□
Cut-outs	Cut-outs can be equipped with adapters to support "third level" accessories	□	-
Sliding top		■	■
<b>Accessories</b>			
3rd level	Adapters	□	-
At sides	CPU holder, printer tray	□	□
Below the top	Modesty panel	□	-
Configurations	Various link modules such as desk extensions (not for mitre-cut base frame)	□	-
Desk screens	Rail, aluminium organiser panel, INSIDE.25, INSIDE.50, fabric cover, felt screen, TWS	□	-
	Rail, INSIDE.25, fabric cover, felt screen	-	□
<b>Options</b>			
Brush seal		-	□
Cable management recess		-	□

■ Standard □ Optional





# JET.II

# DETAILS



**1 | MESH LUMBAR SUPPORT**

Adjustable support for the lumbar region.



**2 | UPHOLSTERED LUMBAR SUPPORT**

Integral part of the back upholstery and infinitely adjustable.



**3 | SYNCHRO MECHANISM**

Comfortable sitting concept with customised weight setting.



**4 | I-SEATING® MECHANISM**

Intuitive sitting thanks to automatic weight setting - ideal for temporary workstations.



**5 | STARBASE TYPES**

Black plastic or die-cast aluminium in lacquered, polished or chrome finish.



**6 | COUNTER CHAIR**

Ideal for the reception area or exhibition stand.



**7 | FULLY-UPHOLSTERED ANTI-STATIC MODEL**

With special upholstery, castors, starbase chrome or aluminium polished and with conductive properties.



# ENDLESS OPTIONS

**JET.II is individually configurable, boasting numerous design variants for posture, back/armrests, as well as a selection of fabric qualities.**

The ERGONOMIE PLUS option features premium outfitting – with synchro mechanism, 4D Plus multifunctional armrests and 100 mm seat depth adjustment to bring it into line with the NPR directive.

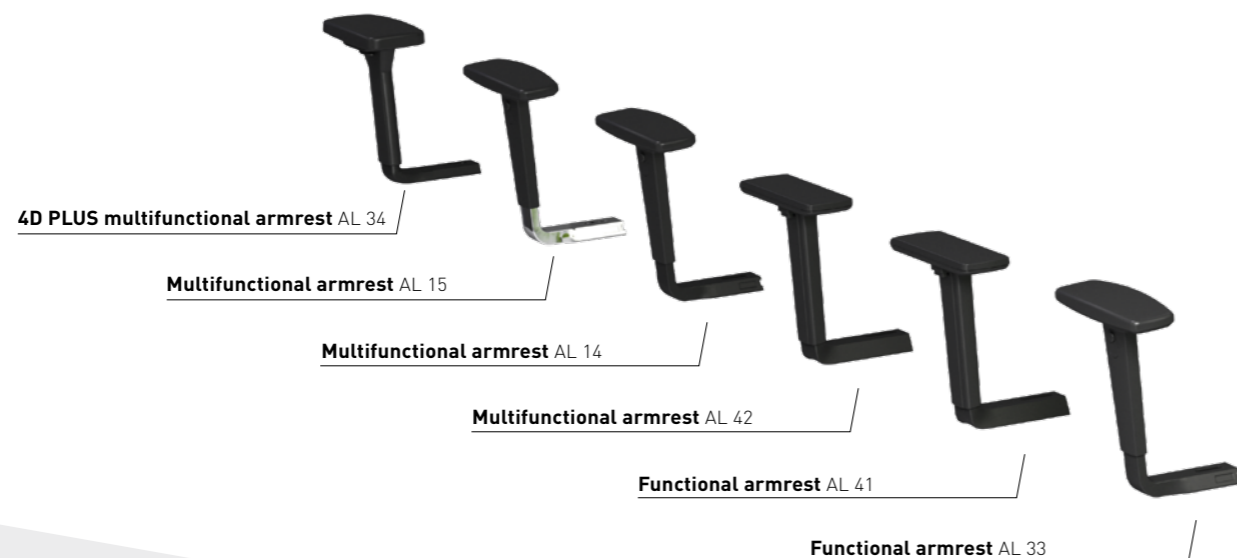

## MECHANISMS FOR HEALTHY, DYNAMIC SITTING

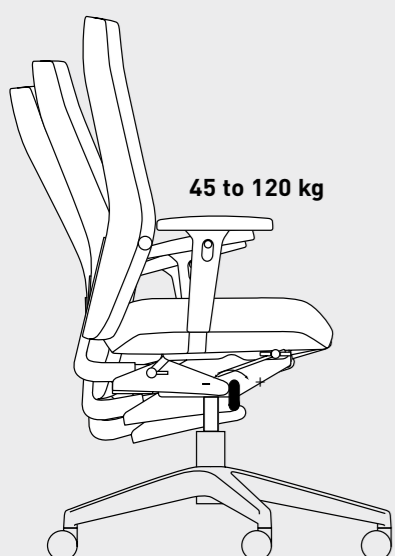

**SYNCHRO MECHANISM**  
The seat and backrest move in tandem with the body in a ratio of 1:2.5. The counter-pressure can be adjusted individually.



**I-SEATING® MECHANISM**  
The user's weight is detected and automatically transferred to the backrest in the form of counter-pressure without the need for further manual adjustment – the sitting position is intuitively correct, which means that the chair can be used by different people in rapid succession.

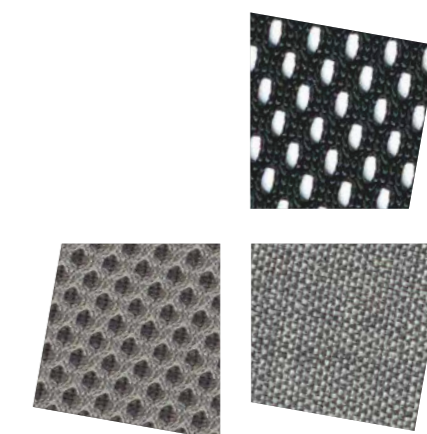

**COMPREHENSIVE FABRIC COLLECTION**  
Discover more than 150 colours, qualities and structures!



# JET.II PRODUCT OVERVIEW



Technology	Task chair	Task chair / Counter chair	Task chair	Counter chair
Mechanism	<b>i-seating® mechanism</b>	<b>Synchro mechanism</b>		
Opening angle	25° (when in use) ■	27° (when in use) ■	■	■
Synchro ratio	1 : 6.9 ■	1 : 2.5 ■	■	■
Weight adjustment	Automatically adjusts to the bodyweight of the user (max. 120 kg) ■	45-120 kg ■	■	■
Seat height adjustment	410-550 mm ■	410-550 mm / 650-850 mm ■	■	■
Seat depth adjustment	70 mm □	70 mm □	□	□
Extra seat depth adjustment	100 mm □	100 mm □	□	-
Forward tilt adjustment	No forward tilt adjustment □	-3° to +3° □	□	□
Backrest lock	5 positions ■	5 positions ■	■	■
Seat upholstery	Foam ■		■	■
Integral shock absorption	Standard ■		■	
<b>Backrest</b>				
	With plastic shell (height-adjustable) ■		■	■
	Fully-upholstered (height-adjustable) ■		■	■
	Mesh fabric back (height-adjustable) ■		■	■
	3D fabric back (height-adjustable) ■		■	■
Lumbar support	Schukra (only for upholstered back), adjustable in curvature and height via backrest □ For mesh fabric back: pressure exerted can be adjusted, height-adjustable via backrest □		□	□
Neck support	Adjustable in depth □		□	□
Clothes hanger	Black □		□	□
<b>Armrests</b>				
Functional armrest	Adjustable in height and width □		□	□
Multifunctional armrest	Adjustable in height, width and depth □		□	□
3D multifunctional armrest	Adjustable in height, width and depth, pads swivel □		□	□
4D Plus multifunctional armrest	Adjustable in height, extra width and depth, pads swivel □		□	□
<b>Dimensions</b>				
Seat height	410-550 mm / Counter chair 650-850 mm			
Seat width	500 mm			
Seat depth	Standard: 420 mm Option: 380-450 mm, with extra seat depth up to 480 mm			
Back width	460 mm (upholstered back) or 455 mm (mesh back)			
Back height	600-660 mm (upholstered and mesh back)			
<b>Colours</b>				
Back and seat shell	Black			
Backrest trim	Black, lacquered in aluminium colour, chrome			
Back support	Black, aluminium-coloured			
Armrests	Black, pad always black, armrest support black /polished aluminium (only for 3D multifunctional armrest)			
Starbase	Various types of starbase are available: black plastic or die-cast aluminium in lacquered, polished or chrome finish			
Castors / glides	Black, 60 mm in diameter			

■ Standard □ Optional



# JET.II VISITOR CHAIRS

**FOUR BACKREST TYPES**  
Plastic shell, fully-upholstered, mesh, 3D mesh

**ARMRESTS**  
Optional

**THREE FRAME TYPES**  
Cantilever model, four-legged model, four-legged model on castors

**GLIDES**  
For carpets and hard floors



**CANTILEVER MODEL**  
Without armrests

**CANTILEVER MODEL**  
With armrests

Optional  
also stackable



**FOUR-LEGGED MODEL**  
With armrests

**FOUR-LEGGED MODEL**  
ON CASTORS  
Only with armrests

## PRODUCT OVERVIEW

Frame		
Cantilever model	Round steel tube, stackable (4x)	■
Four-legged model	Round steel tube, stackable (5x)	■
Backrest		
With plastic shell		■
Fully-upholstered		■
Mesh back		■
Back 3D fabric		■
Armrests		
	Fixed, black plastic wrap	■
Dimensions		
Seat height	435 mm	
Seat width	480 mm	
Seat depth	450 mm	
Back width	445 mm	
Back height	495 mm	
Colours		
Frame	Black/aluminium/anthracite metallic Chrome	
Glides (carpet or hard floor)	Black	
Armrests	In same colour as frame	
Shell	Black	

■ Standard □ Optional





# VALYOU

# DETAILS



**HANDLE**  
To intuitively move the chair, integral to the backrest.

**ARMRESTS**  
Relieve strain on neck and shoulder thanks to individually adjustable armrest top and height.

**LUMBAR SUPPORT**  
Individually adjustable, supports the back.

**MECHANISM**  
Individual seat depth adjustment by 100 mm (NPR) and tilt to max. 21° at the touch of a button.

**OPERATION**  
Select the required seat height or weight setting simply at the touch of a button.



**CONFERENCE CHAIR**  
On four-starbase - in black or chrome.

**COUNTER CHAIR**  
Ergonomic alternative to a bar stool.

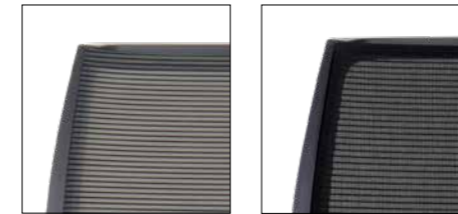

**1 | VERSATILE BACKREST**  
Optionally available in two mesh variants, ribbed fabric or Soft upholstery.



**2 | FRAME-FITTED ARMRESTS**  
Height adjustable to 130 mm – and optionally swivelling.



**3 | ARMREST TOP**  
Swivels through 360° – armrest is adjustable in height, width and depth.

**4 | 2D ARMRESTS**  
Adjustable by 100 mm in height and 45 mm in width.



**5 | LUMBAR SUPPORT**  
Integral part of the backrest – encourages ergonomic sitting by providing extra support in the lumbar region.



**6 | FINE ADJUSTMENT**  
Individual adjustment for personal sitting comfort.



**7 | STARBASE**  
Available in black plastic or polished aluminium – also with glides.

**JUST 2 MINUTES TO SET UP** →  
VALYOU is supplied either ready to use or partially assembled in a transport box.





# VALYOU PRODUCT OVERVIEW



Technology		Task chair	Conference chair	Counter chair
Mechanism	Synchromat	■	■	■
Opening angle	21°	■	■	■
Synchro ratio	1:3	■	■	■
Weight adjustment	45 to 130 kg	■	■	■
Fine adjustment of weight setting		■	■	■
Seat height adjustment		■	■	■
Seat depth adjustment	100 mm (NPR)	■		
	70 mm		■	■
Backrest lock	4 positions, backrest angle can be locked in 2 positions	■	■	■
Seat upholstery	Foam	■	■	■
Backrest				
	Mesh back with black or deep black striped mesh	■	■	■
	Upholstered back with self-supporting, textured fabric	■	■	■
	Soft upholstery	■	■	■
Lumbar support	Plastic, height adjustable	■	■	■
Plastic armrests				
Functional armrest attached to back	Height adjustable through 130 mm	■	■	■
Multifunctional armrest attached to back	Height adjustable through 130 mm, depth adjustable through 60 mm, armrest top swivels by 30°	□		□
Multifunctional armrest 360°,	Height adjustable through 100 mm, width adjustable, armrest top swivels by 360° (clear width complies with NPR standards)	□		□
2D armrest	Height adjustable through 100 mm, width adjustable through 45 mm	□	□	□
Dimensions				
Seat height	405-550 mm / Counter chair 650-850 mm			
Seat width	450 mm			
Seat depth	380-480 mm			
Back width	530 mm			
Back height	540 mm			
Colours				
Plastic parts	Black	■	■	■
Starbase	Black	■	■	■
	Polished aluminium	□		□
	Chrome		□	
Castors / glides	Black, 60 mm in diameter			

■ Standard □ Optional

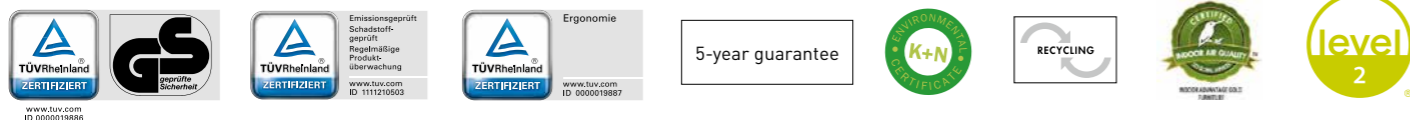

# FABRICS AND COLOURS DESIGN OPTIONS

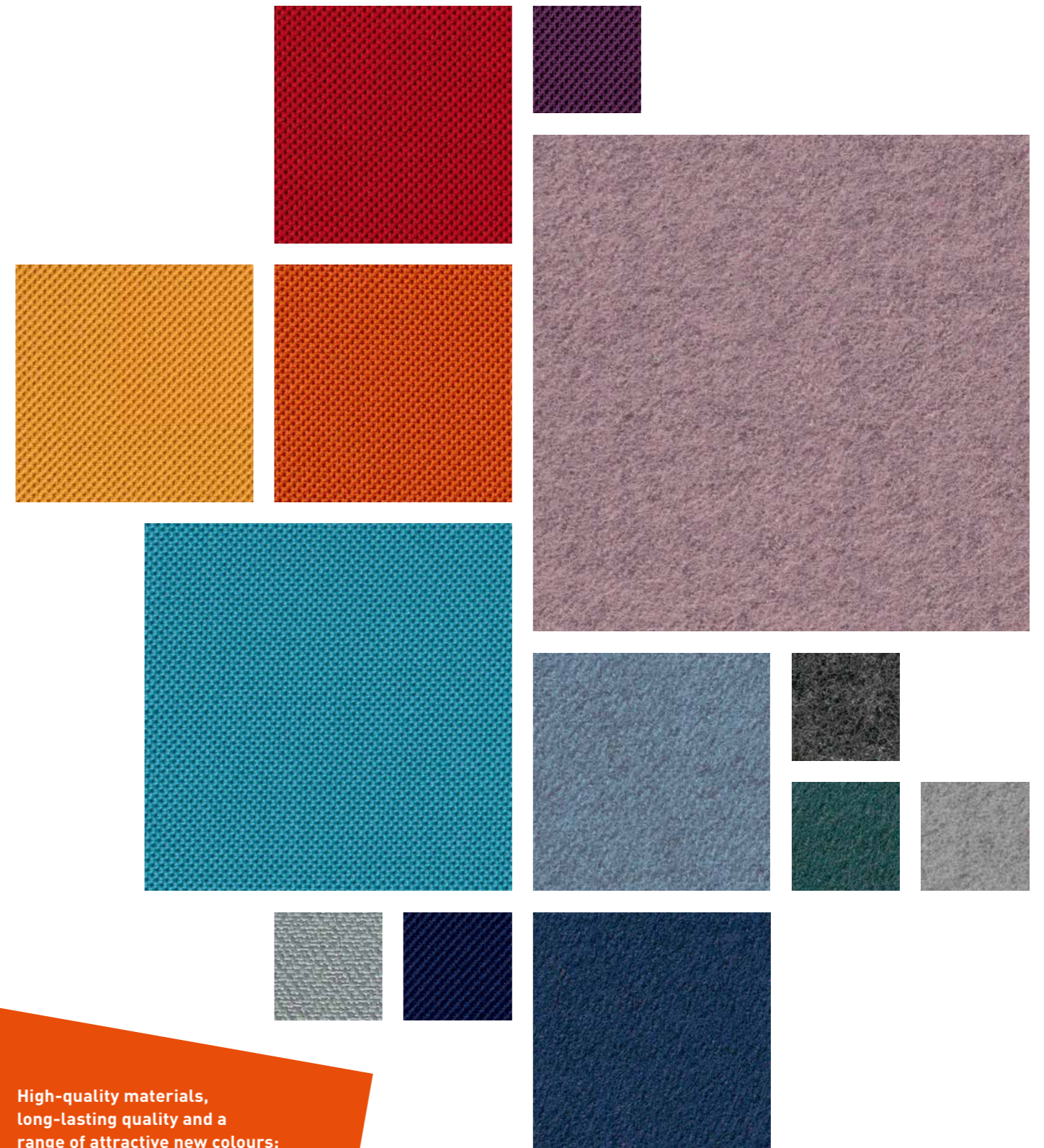

High-quality materials, long-lasting quality and a range of attractive new colours: Our collection makes it easy for you to select light, harmonious and exciting combinations.





**NET.WORK.PLACE Organic**  
Optimum conditions for a better way of working.



**PUBLICA bar stool**  
Sitting comfortably – even at a height.



**QUICK.II**  
Healthy support – wherever you stand.



**ACTA.PLUS lockers**  
Storage options for mobile working environments.



**Pedestal**  
For important personal documents.



**ACTA.PLUS Mobile**  
Storage, wherever it's needed.



**QUIET.BOX Organic**  
Stand-alone furniture unit for more privacy in the office.

# As a leading brand for office furniture and room systems, König + Neurath develops solutions for individual work cultures

Together with specialist retailers, König + Neurath supports its customers throughout the entire process of outfitting offices. With differentiated style collections, design-conscious furniture and digital solutions, the family-owned company, established in 1925, helps its customers to adapt successfully to the changing nature of the workplace.

**Deutschland**

König + Neurath AG  
Büromöbel-Systeme  
Industriestraße 1-3  
61184 Karben  
T +49 6039 483-0  
info@koenig-neurath.de

**Great Britain**

K + N International  
(Office Systems) Ltd  
52 Britton Street  
London EC1M 5UQ  
T +44 20 74909340  
info@koenig-neurath.co.uk

**Nederland**

König + Neurath Nederland  
Office Furniture  
Beethovenstraat 530  
1082 PR Amsterdam  
T +31 20 4109410  
info@konig-neurath.nl

**France**

König + Neurath AG  
Showroom Paris  
66, rue de la Victoire  
75009 Paris  
T +33 1 44632393  
info@koenig-neurath.fr

**Schweiz**

König + Neurath (Schweiz) GmbH  
Büromöbel-Systeme  
St. Gallerstrasse 106 d  
CH-9032 Engelburg / St. Gallen  
T +41 52 7702242  
info@koenig-neurath.de