

Working environment: Reception and waiting area
With NET.WORK.PLACE, LIFE.S Indoor,
LIFE.S Interaction and LIFE.S Stool, PUBLICA,
INSIDE.50 counter

A BETTER RECEPTION A MORE ATTRACTIVE WAITING AREA



First impressions count

Our brain only takes a tenth of a second to form a judgement about a stranger. We decide in an instant whether we think the other person is likeable and can be trusted. And it doesn't just apply to people, but also to rooms. That's reason enough to design reception and waiting areas to be as inviting and welcoming as possible!

Visitors experience your company's character as soon as they step into the foyer.

What's your Corporate Identity like? Do you aim to appear open, flexible and modern? Or would you rather come across as opulent, status-conscious and traditional? We'll show you how skilful room design can create a good first impression with both employees and customers.

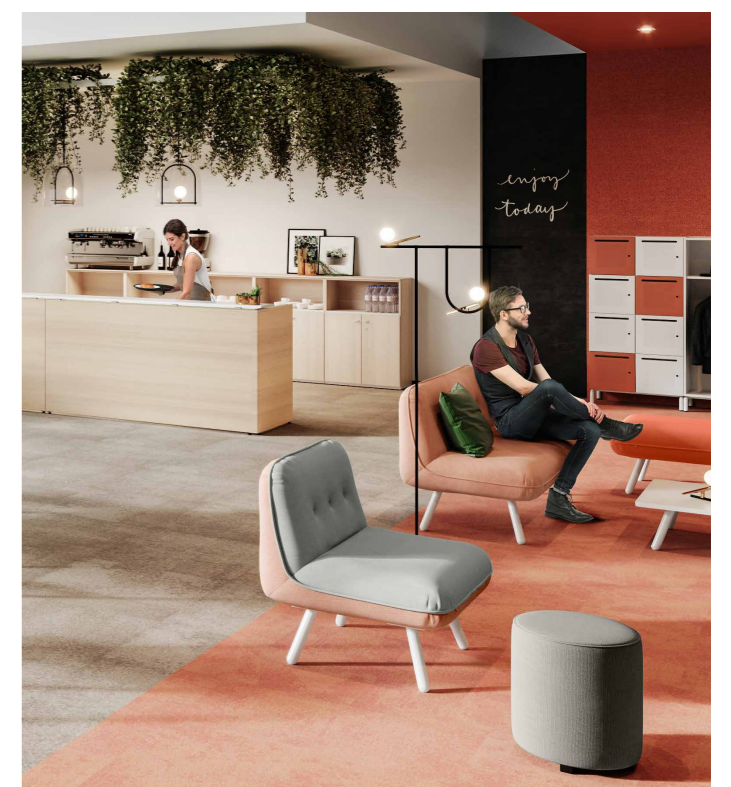



Products:
NET.WORK.PLACE upholstered elements and meeting table, INSIDE.50 counter, LIFE.S Interaction with LIFE.S Stool, PUBLICA bar stool,
TEAM.WORK.SPACE acoustic absorber screen

CUSTOMISED ROOM CONCEPTS FOR MODERN PEOPLE

Welcome to the workplace with urban character, designed on the basis of our **PURE style collection**. As a process companion with 95 years of experience, we analyse individual work cultures and use these as a basis for developing customised room concepts that are unique.

Maybe the **NET.WORK.PLACE** soft seating programme is just the thing for you? It's highly flexible thanks to its **modular 80 scale**: You can use it to furnish a wide range of areas for communication and relaxation, which can be harmoniously integrated into diverse room scenarios. The **INSIDE.50 counter solution** is almost equally versatile.

We invite you to explore over the following pages.

GUARANTEED TO BE TIMELESS: THE QUEST FOR COMFORT

These days, people can work just about anywhere. And relax. So it really doesn't matter how mobile your customers and staff are as they go about their jobs – a thoughtfully designed reception area makes for a pleasant arrival experience, quiet corners are inviting places to relax, and a co-working space provides a forum for ideas.

The **NET.WORK.PLACE lounge chair** encloses you like a cocoon – allowing privacy yet facilitating interaction. Our **podiums** have a workshop character, offering a sophisticated storage solution that's also ideal for agile meetings and presentations. Just like **NET.WORK.PLACE**, both furnishing solutions are created using traditional materials and timeless colours, based on our **TIMELESS style collection**.



Products:
NET.WORK.PLACE upholstered elements, NET.WORK.PLACE lounge chair,
podiums, INSIDE.50 counter, PUBLICA conference chair, ACTIVE.T

WAITING, OR EXPERIENCING TIME CONSCIOUSLY

In our world, where time must always be used efficiently, hardly anyone enjoys waiting any more. And why is that? With an attractive and comfortably designed waiting area, you can invite visitors and guests to spend their free time doing something enjoyable – reading an inspirational book, a cup of coffee, a nice chat or a meditative experience of ... time.

The **PUBLICA benches and chairs** from König + Neurath with their clear-cut design and plenty of customisation potential offer comfort and aesthetic appeal in equal measure.



Whether waiting time is perceived as something enjoyable or not depends very much on the atmosphere. The **large PUBLICA product family** scores points for popularity thanks to its diversity, as well as plenty of sophisticated details.

Products:
PUBLICA bench, PUBLICA contract chair, ACTA.PLUS shelf and wardrobe-style cupboard,
NET.WORK.PLACE side table, INSIDE.50 counter, podiums



Products:
LIFE.S Interaction with LIFE.S Stool, NET.WORK.PLACE Organic elements, NET.WORK.PLACE stool, INSIDE.50 counter,
ACTA.PLUS hinged door cupboard, QUIET.BOX Organic, ACTA.PLUS locker

INSPIRATION - PERFECT FOR EVERYDAY USE

The first impression is key when it comes to being likeable and inspiring trust. Factors that win favour in reception areas include colours, shapes, light and plants. This is where your brand image has most impact. So it can be a good idea to integrate some casual spaces alongside the more formal reception counters: the **INSIDE.50 counter** for instance can be complemented by a café, library or organically designed lounge areas – the result is a versatile multi-purpose space.

For example, **LIFE.S Interaction** invites social interaction. Our multifunctional solution for short meetings is available as a stand-up table with benches for communication and bistro areas.

ENCOURAGE INDIVIDUALITY, ENABLE AGILITY

These days, people can create their own lifestyle and their own persona, by drawing on an almost infinite selection of options. What influence does that have on their jobs? It should reflect their personality. A working environment fosters identification – and itself embraces change.

In fluid transitions between spaces and application concepts, areas for working, reception and waiting all merge into each other. And in the ideal case scenario this pays dividends for the brand and company!



Products:
LIFE.S Indoor, NET.WORK.PLACE Organic,
ACTA.PLUS room divider shelving unit,
INSIDE.50 counter, MOVE.MIX bar stool

“The identity of a company is always expressed through the design of their own premises.”

NET.WORK.PLACE
INSIDE.50 counter
PUBLICA
LIFE.S Interaction
LIFE.S Stool
LIFE.S Indoor

READY FOR A GOOD RECEPTION



NET.WORK.PLACE

- + Modular structure (80 scale) is ideal for creating seating configurations
- + Versatile combinations of individual modules such as single-seaters, two-seaters, corner units, benches, side tables or wall elements
- + Fast and simple adaptation to new situations
- + Electrics can be set up with 230 V connection for flexible working



INSIDE.50 counter

- + Linear, frameless construction for a representative look
- + High variation potential thanks to interchangeable finish materials and colours

NET.WORK.PLACE, INSIDE.50 counter, PUBLICA, LIFE.S Interaction with LIFE.S Stool and LIFE.S Indoor



PUBLICA

- + **Four models:** conference chair, stacking chair, bar stool and bench
- + Wide choice of seat and cushion styles, as well as add-ons such as armrests, seat numbering and writing tablets
- + Tested for loads up to 110 kg

LIFE.S Interaction and LIFE.S Stool

- + For communication and bistro areas
- + Combined with a high bench seat (upholstered)
- + Acoustic canopy and walls for focused working



LIFE.S Indoor

- + For spontaneous meetings (4 to 6 people)
- + Upholstered bench seats
- + With optional wire management and media wall

SQUARE, PRACTICAL, MODULAR!

With **NET.WORK.PLACE** you can create inviting meeting zones for spontaneous discussion and cooperative working, as well as quiet zones in open-space offices.

The **modular 80 scale** means that individual components can be rearranged in different combinations again and again.

Discover our **dialogue workstation** with privacy screening, our **two-seater with removable acoustic hood**, or our space-saving **seating group for lounge and reception areas**.



LOUNGE CHAIR
Gives you a feeling of security thanks to its organic shape, and creates a personal retreat space.



SEATING GROUP
Variable configurations provide a meeting point for get-togethers involving communication.

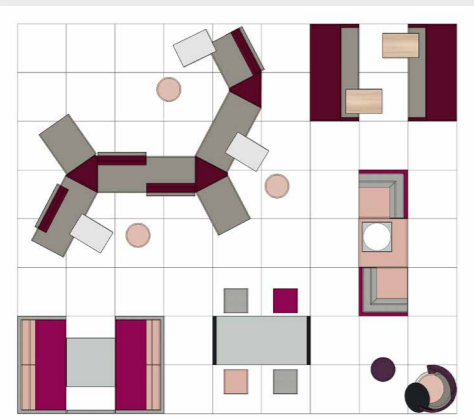
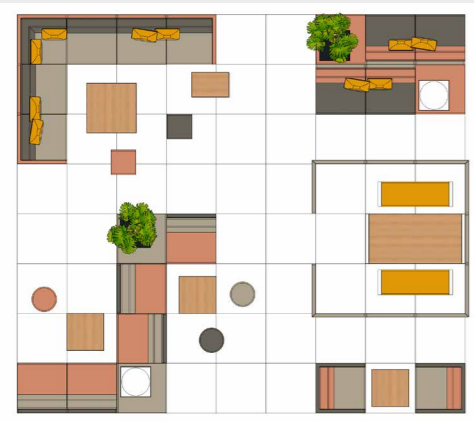

PHONEBOX
As single or 2-seater it provides acoustic and visual screening, and creates an agreeable atmosphere.



DIALOGUE WORKSTATION
In this communicative position the two conversation partners can focus fully on each other, and discuss current topics in a stress-free setting.

A SELECTION OF SURFACE FINISHES AND FABRICS



Subject to technical and programme alterations, printing and other errors. Printed colours may vary from actual colours.

DETAILS



1 | MEDIA FURNITURE
Combination of bridging desk and screen element with monitor holder. One-piece table top with four-gang socket.

2 | BRIDGING DESK SITTING OR STANDING HEIGHT
Optionally with upholstered bench seats on glides with 10 mm levelling adjustment.



3
Top slides diagonally to the required position at the touch of a button.

3 | MEETING TABLE
With a fixed height of 720 mm



4 | POP-UP SOCKETS
For easy access to the mains power supply.

5 | LIGHTING
Fabric-covered module box with lamp shade creates a homely feeling.



6 | OPEN MODULE BOX
With plastic insert and pop-up triple socket.



7 | VELCRO CONNECTIONS
Screen elements can be linked simply and quickly without the need for tools.

8 | FASTENINGS
The upholstered elements are held in place with pairs of connectors.

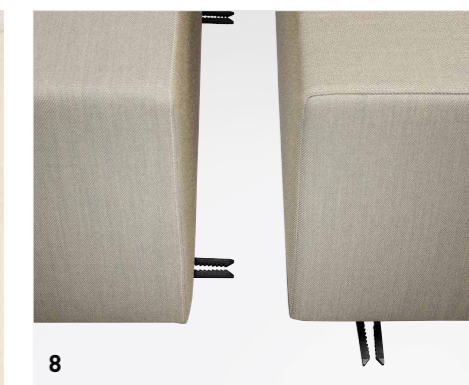

9 | ARMREST SOCKET
For charging laptops etc.



10 | ROUND STOOLS
Complement any seating group and are very versatile.



11 | SWING-OUT WRITING TABLET
Integral sturdy place to put items, with velvety feel and "anti-fingerprint" properties.



12 | LUMBAR CUSHION
The lumbar support is fitted as standard and improves seated comfort.

SYSTEM OVERVIEW

Upholstered furniture

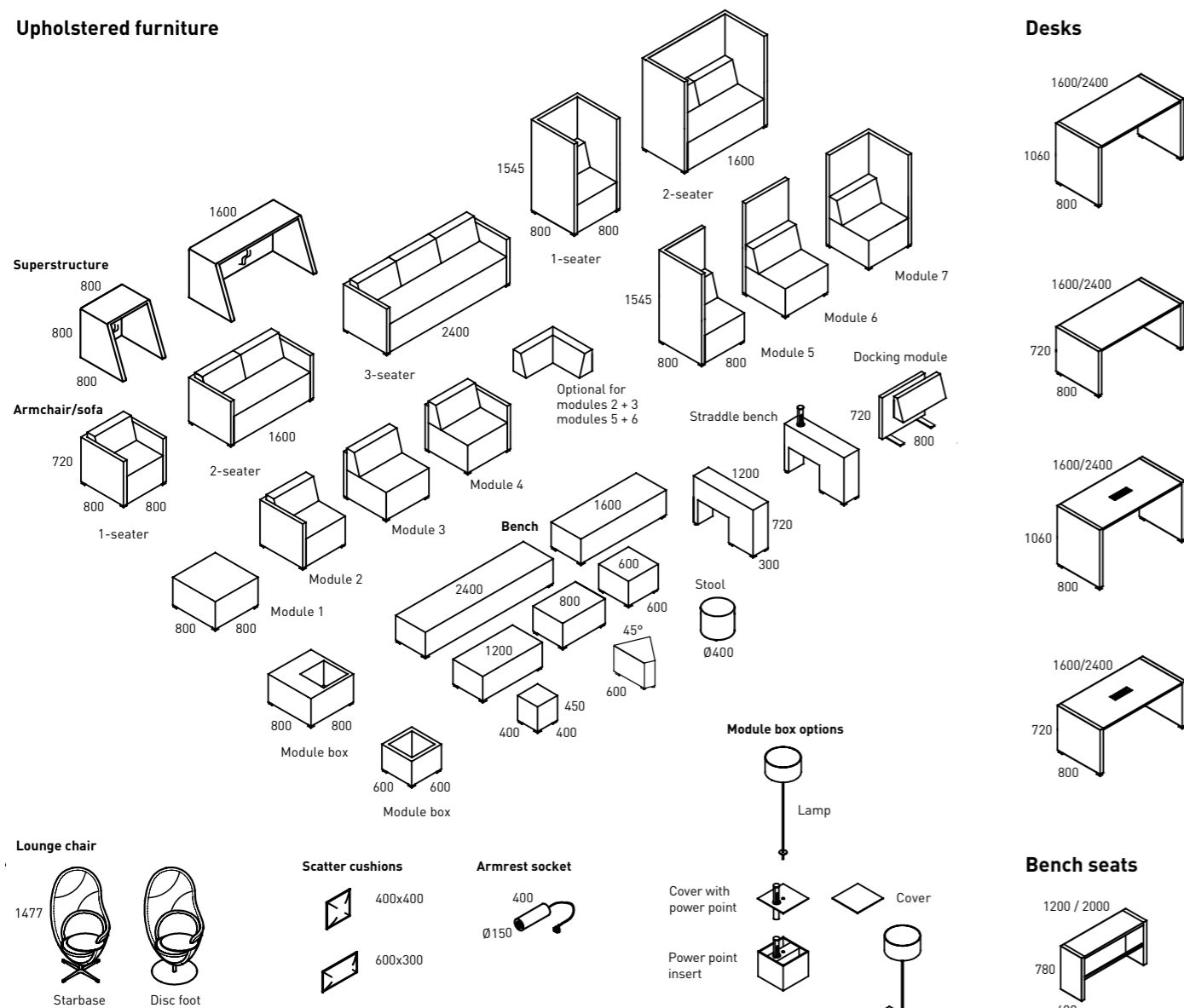

Screen elements

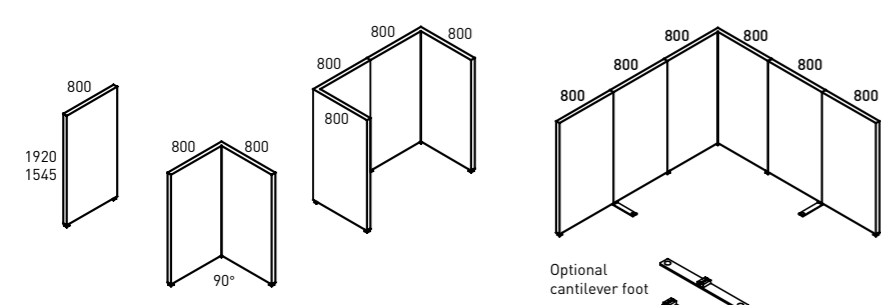

Side tables

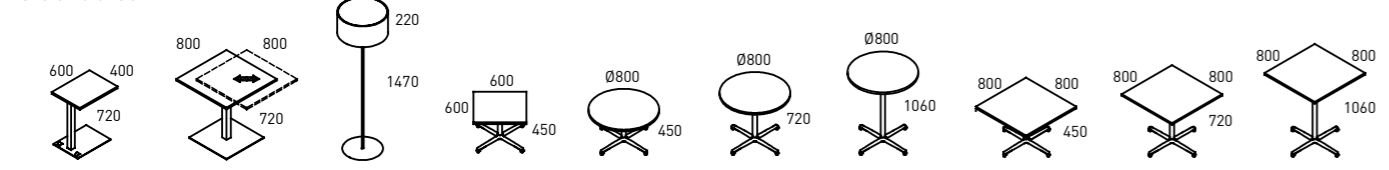

Desks

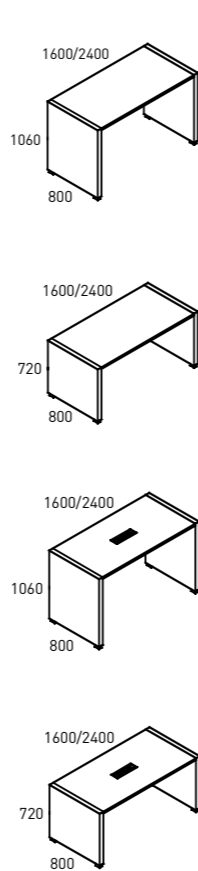

Bench seats

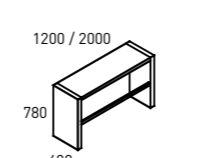

Media furniture

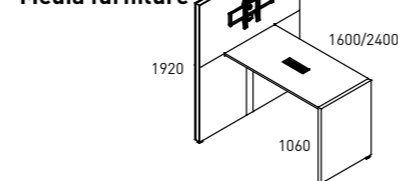

PRODUCT OVERVIEW

Upholstered furniture

1-seater, 2-seater, 3-seater, corner units, stools, intermediate modules, acoustic superstructures, lounge chair	■
Seat height 450 mm, back height 820 mm and 1545 mm with high backrest	■
Scatter cushions in two colours within the same fabric group, 400 x 400 mm, 600 x 300 mm	■
Armrest modules and the seat and back upholstery can be specified in two different colours within the same fabric group	■

Bench seats and module boxes

Width 400, 600, 800, 1200, 1600, 2400 mm	■
Seat height 450 mm, seat depth 600 mm	■
Bench seats for bridging desks, 1200/2000, height 780 mm	■
Straddle bench, height 720 mm, optional double socket, pop-up	■
Docking module, width 800 mm	■
45° bench seat, width 600 mm	■
Stool, Ø 400 mm	■
Armrest socket, Ø 150 mm	■
Module box width x depth: 800 x 800 mm, 600 x 600 mm, closed insert	■
Module box width x depth: 800 x 800 mm, 600 x 600 mm, open insert	□

Bridging desks and bench seats

Bridging desk with one-piece top, optional with rotating electrics	□
Heights 720, 1060 mm, widths 1600, 2400 mm	□
Upholstered bench seats, widths 1200, 1400, 1600, 2000 mm; height 780 mm	□

Screen elements

Fabric-covered panels with Velcro fastener on one side, optional on both sides	■
Heights 1545, 1920 mm, width 800 mm	■
Fabric-covered panel corner module 90°, with Velcro fastener on one side, left	■
Cantilever foot, two-sided / one-sided	■

Media furniture

Media furniture consisting of screen element, bridging desk and monitor holder	■
--------------------------------------------------------------------------------	---

Side tables

Meeting table height 720 mm, optional with diagonally-sliding top	■
Lounge tables on 4-starbase, height 450, 720, 1060 mm	■
Standard lamp, height 1470 mm	■

■ Standard □ Optional



OUR CROWD PLEASER



BACKREST AND SEAT
Upholstered, without upholstery or fully-upholstered - depending on model.



OPTIONAL
Row linking option with/without armrests.

SHELL
Plastic or wood in various styles - depending on model.



FRAME COLOUR
Chrome, white, black, aluminium coloured, anthracite metallic.

GLIDES
Black.

Tested for loads up to 110 kg

COMPREHENSIVE PRODUCT RANGE

CONFERENCE CHAIR



STACKING CHAIR



BAR STOOL



BENCH



DETAILS

1 | FULLY-UPHOLSTERED

Conference chair also available as a fully-upholstered option.

2 | LINEAR ARMREST

Chrome or powder-coated, irrespective of base colour
Armrest pad in black as standard, alternatively in wood.



3 | LINKING AND NUMBERING

Linkable with and without armrests, row and seat numbering is easy to fit.

4 | CHROMIUM ROW LINKING

For linking chairs with two armrests.

5 | FOLD-OUT WRITING TABLET

Optional, retrofittable surface for fitting to the left or right of the frame. Swivel tablet outwards for stacking.

6 | SPACE-SAVING

Can be stacked up to 15 high and mobile thanks to stacking trolley.



7 | STARBASE STYLES

4-starbase on glides or 5-starbase with castors - in white, black or chrome.



8 | PUBLICA BENCH

Available in many different variants: as 2, 3 and 4-seater, in wood or plastic, upholstered, fully-upholstered or without upholstery.

8

PRODUCT OVERVIEW



Frame	Bench	*1, 4-9
Bench	Min. 2, maximum 4 seating elements	■
Armrests		
	Fixed, black plastic wrap or unstained beech or cross-veneered walnut	□
Shell (seat and back)		
	Plastic, black or white	■
	Unstained beech	■
	Cross-veneered walnut	□
	Rectangular (440 x 440 mm)	□
Bench boards	Round (560 mm) for covering the connection nodes	□
Models		
	Without upholstery / upholstered seat / upholstered seat and backrest	■
	Fully-upholstered model	■
Dimensions		
Seat height	420 mm	
Seat width	435 mm	
Seat depth	460 mm	
Back width	425 mm	
Total height	890 mm	
Colours		
Frame	White / black / aluminium coloured / anthracite metallic	■
	Chrome	□
Armrests	White / black / aluminium coloured / anthracite metallic	■
	Chrome	□
Shells		
	Plastic white or black	■
	Unstained beech	■
	Cross-veneered walnut	□
	Fully upholstered	■
Flame-retardant version		□
Weight in kg (from)	18	

■ Standard □ Optional

Frame	Stacking chair	*1, 3-9	Conference chair	*2, 3-9	Bar stool	*1, 5-9
Four-legged model	Square-section steel, stackable (max. 15 chairs)	■	4-starbase on glides	■	Square-section steel, 4-legged frame	■
Armrests						
	Fixed, black plastic wrap or beech	□	Fixed, black plastic wrap or beech	□	—	—
Shell (seat and back)						
	Plastic, white or black	■	Plastic, white or black	■	Beech, lacquered in white or black	■
	Unstained beech	■	Unstained beech	■		
	Cross-veneered walnut	□	Cross-veneered walnut	□		
Models						
	Without upholstery / upholstered seat / upholstered seat and backrest	■	Without upholstery / upholstered seat / upholstered seat and backrest	■	Without upholstery / upholstered seat / upholstered seat and backrest	■
	Fully-upholstered model	■	Fully-upholstered model	■		
Fold-out writing tablet on left or right						
	Powder-coated support	□	—	—	—	—
	Solid core, Fenix Softtouch black	□				
Row linking						
	Black plastic	□	—	—	—	—
Seat and row numbering						
	Black metal, can be attached irrespective of row linking	□	—	—	—	—
Dimensions						
			Without upholstery	Fully-upholstered		
Seat height on glides	420 mm, upholstered 430 mm		365 - 485 mm	370 - 490 mm		790 mm
Seat height on castors	—		395 - 515 mm	400 - 520 mm		—
Seat width	435 mm		435 mm	435 mm		385 mm
Seat depth	460 mm		460 mm	440 mm		430 mm
Back width	425 mm		425 mm	425 mm		370 mm
Total width	Without armrests 490 mm		With 4-starbase: 730 mm			440 mm
Total width	With armrests 600 mm		With 5-starbase: 630 mm			—
Colours						
Frame / starbase	White / black / aluminium coloured / anthracite metallic	■	White / black / aluminium coloured / anthracite metallic	■	White / black / aluminium coloured / anthracite metallic	■
	Chrome	□	Chrome	□	Chrome	□
Armrests	White / black / aluminium coloured / anthracite metallic	■	White / black / aluminium coloured / anthracite metallic	■		
	Chrome	□	Chrome	□		
Fold-out writing tablet						
Support	White / black / aluminium coloured / anthracite metallic	■				
Table top	Fenix Softtouch black	■				
Shells						
	Plastic white or black	■	Plastic white or black	■	Beech, lacquered in white or black	■
	Unstained beech	■	Unstained beech	■		
	Cross-veneered walnut	□	Cross-veneered walnut	□		
Glides	Black	■	Black	■	Black	■
Flame-retardant version		□	—	—	—	—
Weight in kg (from)	6.6		9.2		7.4	



*1

*2

*3

*4

*5

*6

*7

*8

*9

LIFE.S IDEAS

OUR INVITATION TO DIALOGUE

IC 0 2
NIC 0
AWA 2
RDS 0

INNOVATIVE INTERIOR

best of best

SIDE SCREEN
Provides visual and acoustic screening.

TABLE TOP
25 mm thick with rounded corners.

LIFE.S STOOL
Upholstered bench seat with footrest.

EXTENSION TOP
For one or both sides.

CANOPY
Fabric-covered, provides privacy where required.

MONITOR HOLDER
For monitors up to max. 30".

UPHOLSTERED SEAT PAD
Two colours from within the same fabric group can be specified.

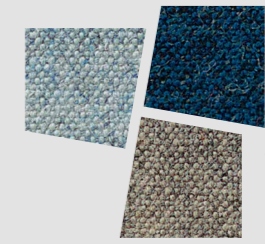

Various fabrics and materials available.

MEDIA WALL
With monitor holder for attaching a flat screen (optional).

TABLE TOP 25 MM
Thick with rounded corners and deep cable tray.

FASTENING
For attaching the media wall to the seating group.

UPHOLSTERED SEAT PAD
Two colours from within the same fabric group can be specified.



Various fabrics and materials available.

DETAILS

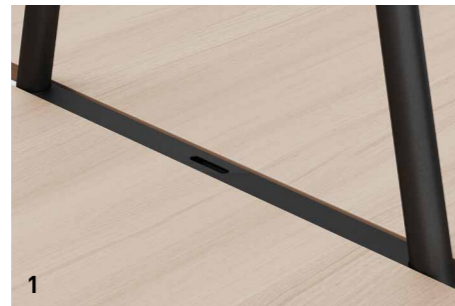

1 | EXTENSION TOP
Extension tops can be added to each side of the stand-up table, incl. connection trim.



2 | MONITOR HOLDER
It is simply clamped to the side screen. For monitors up to max. 30".



3 | SIDE SCREEN
Fabric-covered side screen for visual and acoustic protection can be fitted to the frame.



4 | FABRIC-COVERED CANOPY
Optimum acoustic properties for enhanced ambient acoustics to create a homely atmosphere.

5 | CLIP-DOWN CABLE TRAY
105 mm deep, as an option, it can include a triple power socket and mains lead for tidy cable management.



6 | NET BOX POINT
Direct access to electricity and data, available as an option.



7 | MONITOR HOLDER
For attaching a monitor, max. load of 35 kg.



PRODUCT OVERVIEW



Frame	LIFE.S Interaction	LIFE.S Stool	LIFE.S Indoor
Steel tube Ø 45 mm	■	■	■
Dimensions			
Height	2200 mm	830 mm	Seat height 477 mm
Width	1600 mm	1200 mm	Total width 1600 mm
Depth	1200 mm	Seat depth 320 mm	Seat depth 320 mm
Total height	2250 mm		
Table tops			
Thickness 25 mm, rounded corners	■	—	■
MFC solid colour	■	—	■
MFC wood-effect	■	—	■
Fenix Softtouch	■	—	■
Seat pads			
Upholstered, 40 mm thick, fabric group Economy Two colours from within the same fabric group can be specified	—	■	■
Accessories			
Side screen	<input type="checkbox"/>	—	—
Canopy	<input type="checkbox"/>	—	—
LIFE.S Stool	<input type="checkbox"/>	—	—
Cable chain	<input type="checkbox"/>	—	<input type="checkbox"/>
Media wall with monitor holder (also available as individual item)	—	—	<input type="checkbox"/>
Extensions			
Extension top, on one or both sides	<input type="checkbox"/>	—	—
Monitor holder	<input type="checkbox"/>	—	<input type="checkbox"/>
Electrics			
Range of electrics components incl. cut-outs	<input type="checkbox"/>	—	<input type="checkbox"/>

■ Standard □ Optional



STYLISH RECEPTION AT EYE LEVEL

OVERVIEW OF ELEMENTS AND DETAILS



The reception area is a company's calling card, the first representative point of reference for visitors and employees. The combination of different materials such as melamine, veneer or glass, as well as colours, opens up a vast design potential and underscores the individual corporate culture.

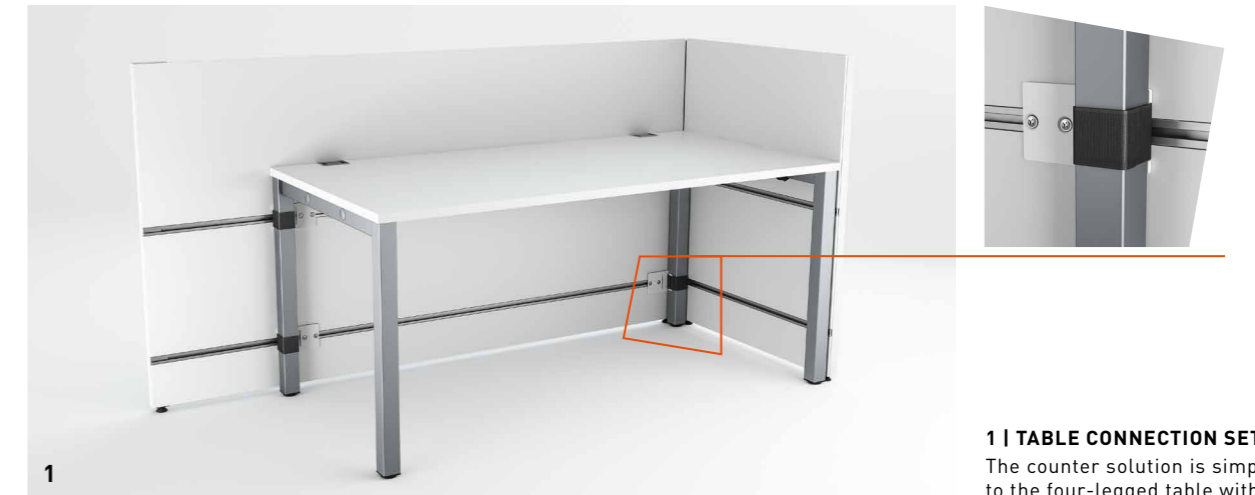
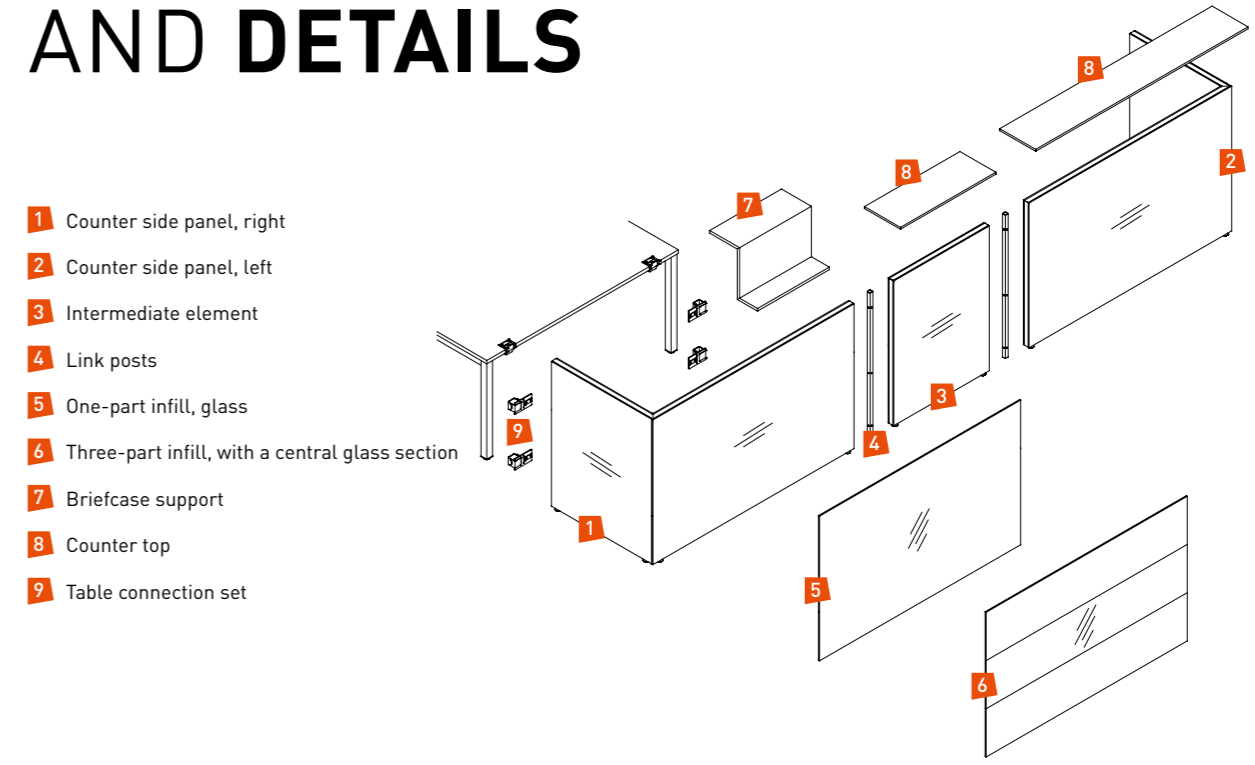

1 | TABLE CONNECTION SET
The counter solution is simply connected to the four-legged table with Velcro fasteners.

MFC SOLID COLOUR

GK Grey	GW Off-white	KH Light grey	9R Medium grey	9T Beige
KT Aluminium coloured	MA Anthracite	SC Black	WI Pure white	

MFC WOOD-EFFECT

AA Acacia	AO Maple	MB Beech	ET Oak natural
NM Walnut	9L Halifax Oak Natural	9S Concrete look	

VENEER

AH Canadian maple unstained	BH Beech unstained	EN Oak natural
CK American cherry	SN American walnut natural	

POWDER-COATED METAL

AL Aluminium coloured	KS Black	WI Pure white

GLASS

GSS Black	GSW Matt white

Subject to technical and programme alterations, printing and other errors. Printed colours may vary from actual colours.

2 | REMOVABLE PANELS
The Velcro fastener allows you to replace fronts quickly. The glass panels are secured with frame bolts.

3 | SHELF
You can attach the briefcase support easily and flexibly.

PRODUCT OVERVIEW



Construction principle

Modular counter system with concealed-frame construction



Counter elements

Side panel on left



Side panel on right



Intermediate and front elements



Dimensions of counter side panels, on left and right

Depth 850 mm, widths 1650, 1850 and 2050 mm, height 1070 mm



Dimensions of intermediate and front elements

Widths 800, 1000, 1600, 1800, 2000 mm, height 1070 mm



Infills

One-part and three-part



MFC, veneer, glass



Accessories

Counter tops depth 300 mm, widths 1600, 1800, 2000 mm



Briefcase support width 600 mm



Link posts height 1070 mm, anthracite metallic



Table connection set for 4-legged tables, metal



Wall connection, square profile, metal



■ Standard



QUIET.BOX Organic

Stand-alone furniture unit for more privacy in the office.



ACTA.PLUS lockers

Storage options for mobile working environments.

As a leading brand for office furniture and room systems, König + Neurath develops solutions for individual work cultures

Together with specialist retailers, König + Neurath supports its customers throughout the entire process of outfitting offices. With differentiated style collections, design-conscious furniture and digital solutions, the family-owned company, established in 1925, helps its customers to adapt successfully to the changing nature of the workplace.



Podiums

Flexible modules for creative interaction.



NET.WORK.PLACE Organic

Modular upholstery elements for reception and communication areas.



ACTA.PLUS room divider shelving unit

Flexible storage for homely space structuring in lounge areas and offices.

Deutschland

König + Neurath AG
Industriestraße 1-3
61184 Karben
T +49 6039 483-0
info@koenig-neurath.de

Great Britain

König + Neurath (UK) Ltd.
Ground and Lower Ground Floor
75 Farringdon Road
London EC1M 3JY
T +44 20 74909340
info@koenig-neurath.co.uk

Nederland

König + Neurath Nederland
Beethovenstraat 530
1082 PR Amsterdam
T +31 20 4109410
info@konig-neurath.nl

France

König + Neurath AG
53, rue de Châteaudun
75009 Paris
T +33 1 44632393
info@koenig-neurath.fr

Schweiz

König + Neurath (Schweiz) GmbH
St. Gallerstrasse 106 d
CH-9032 Engelburg / St. Gallen
T +41 52 7702242
info@koenig-neurath.de

Österreich

König + Neurath AG
Gonzagagasse 1 / Morzinplatz
1010 Wien
T +43 676 4117512
info@koenig-neurath.de

