

TALO.YOU MEETING TABLE

- + **Top shapes** in rectangular, boat, trapezoidal and oval form
- + **Leg frame design** round or square tube A-leg frame, also on castors
- + **Single tables in sizes:**
Width 1,200 to 2,000 mm, depth 700 to 1,200 mm
- + **Linking variants**
with start/end element or with additional intermediate element
- + **Height adjustment**
Motorised height adjustment from 640 to 1,300 mm
- + **Gas lift version**
for meeting tables, adjustable from 720 to 1,220 mm
- + **Fixed height 750 mm and standing height of 1,060 mm**
- + Metal cable tray/clip-down cable tray, plastic clip-down cable tray
- + Wide range of desktop electrics options, cable slot
- + Optional: delivery in component form, boxed



Trapezoidal form



Stadium form



TALO.YOU INFOCARD MEETING TABLE

- 1** Frame with desktop supports
- 2** Metal clip-down cable tray
- 3** Symmetrical T-leg frame
- 4** Square tube frame, FLAT cantilever feet on castors
- 5** FLAT cantilever feet
- 6** STEEL cantilever feet
- 7** Cantilever feet from the TALO.S range
- 8** Round tube frame, CURVE cantilever feet
- 9** FLAT cantilever feet
- 10** A-leg frame - Square
- 11** A-leg frame - Round

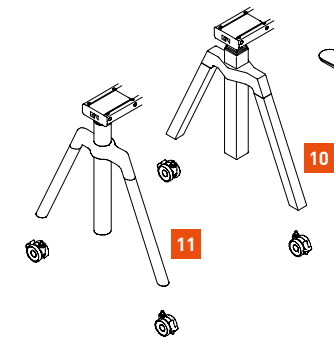
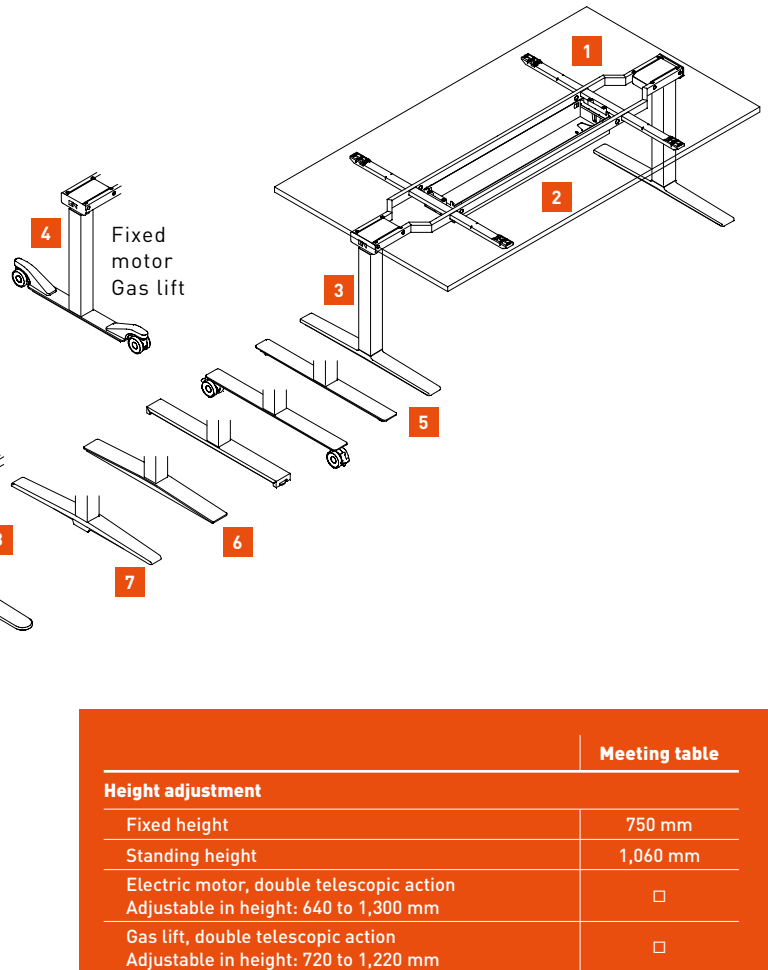

1 | FRAME DESIGN

Square/round tube leg columns are also available with an A-leg frame in steel tube or real wood.

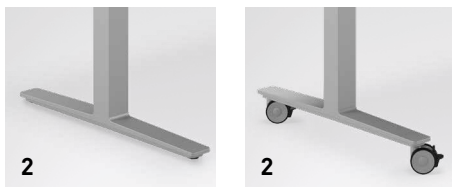

2 | FRAME TYPES

Symmetrical on glides or castors.



3 | FRAME LEGS

Square tube (70 x 70 mm), round tube (Ø 70 mm).

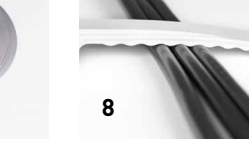
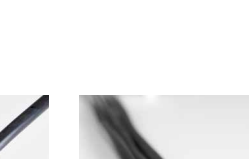
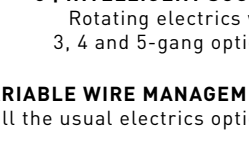
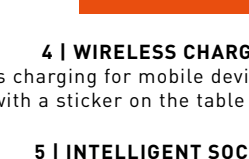
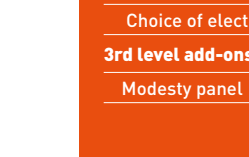
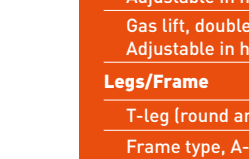
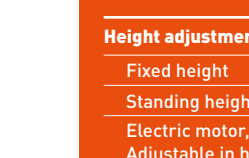
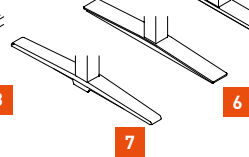
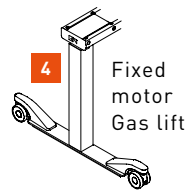

		Meeting table
Height adjustment		
Fixed height		750 mm
Standing height		1,060 mm
Electric motor, double telescopic action Adjustable in height: 640 to 1,300 mm	<input type="checkbox"/>	
Gas lift, double telescopic action Adjustable in height: 720 to 1,220 mm	<input type="checkbox"/>	
Legs/Frame		
T-leg (round and square tube)	<input checked="" type="checkbox"/>	
Frame type, A-leg	<input checked="" type="checkbox"/>	
Design cantilever feet	<input checked="" type="checkbox"/>	
Castors	<input checked="" type="checkbox"/>	
Wire management		
With matching clip-down cable tray or cable clip	<input type="checkbox"/>	
Choice of electrics options	<input type="checkbox"/>	
3rd level add-ons		
Modesty panel	-	

■ Standard □ Optional

4 | WIRELESS CHARGING

Wireless charging for mobile devices, marked with a sticker on the table top.



5 | INTELLIGENT SOCKET

Rotating electrics with 3, 4 and 5-gang options.



6 | VARIABLE WIRE MANAGEMENT

Choose from all the usual electrics options.

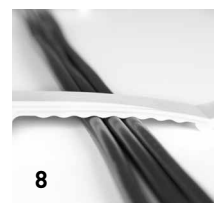

7 | PRACTICAL AND DISCREET:

the cable outlet box made of plastic and stainless steel.

8 | TIDY SOLUTION

This flexible cable clip bundles up to eight cables together under the table top.