

# The Tip System

TipBox - TipRack - TipStack™



Cleanroom quality for  
contamination-free work

Perfect fit on the Transferpette® micro-  
liter pipette and many other pipettes

The tip system for  
any demand

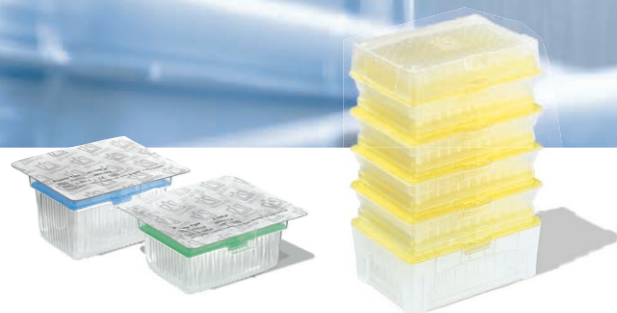

**BRAND. For lab. For life.**

# The cleanest tip technology

In order to guarantee the high quality of our products, from manufacturing through packaging and all the way to the laboratory, BRAND has also optimized the packaging options to comply with the new requirements. Even the primary packaging for the systems, such as the PET outer packaging for the TipRacks (refill units) and the

spacers for the TipStacks, are produced under cleanroom conditions, which guarantees the high purity of the products. All racked pipette tips and filter tips up to 1000 µl are free from DNA, RNases, endotoxins and ATP.

Sterile tips and packaging are manufactured exclusively under BIO-CERT® quality\* certification.

\* BIO-CERT® quality see page 13

## The TipBox-TipRack-TipStack™-System

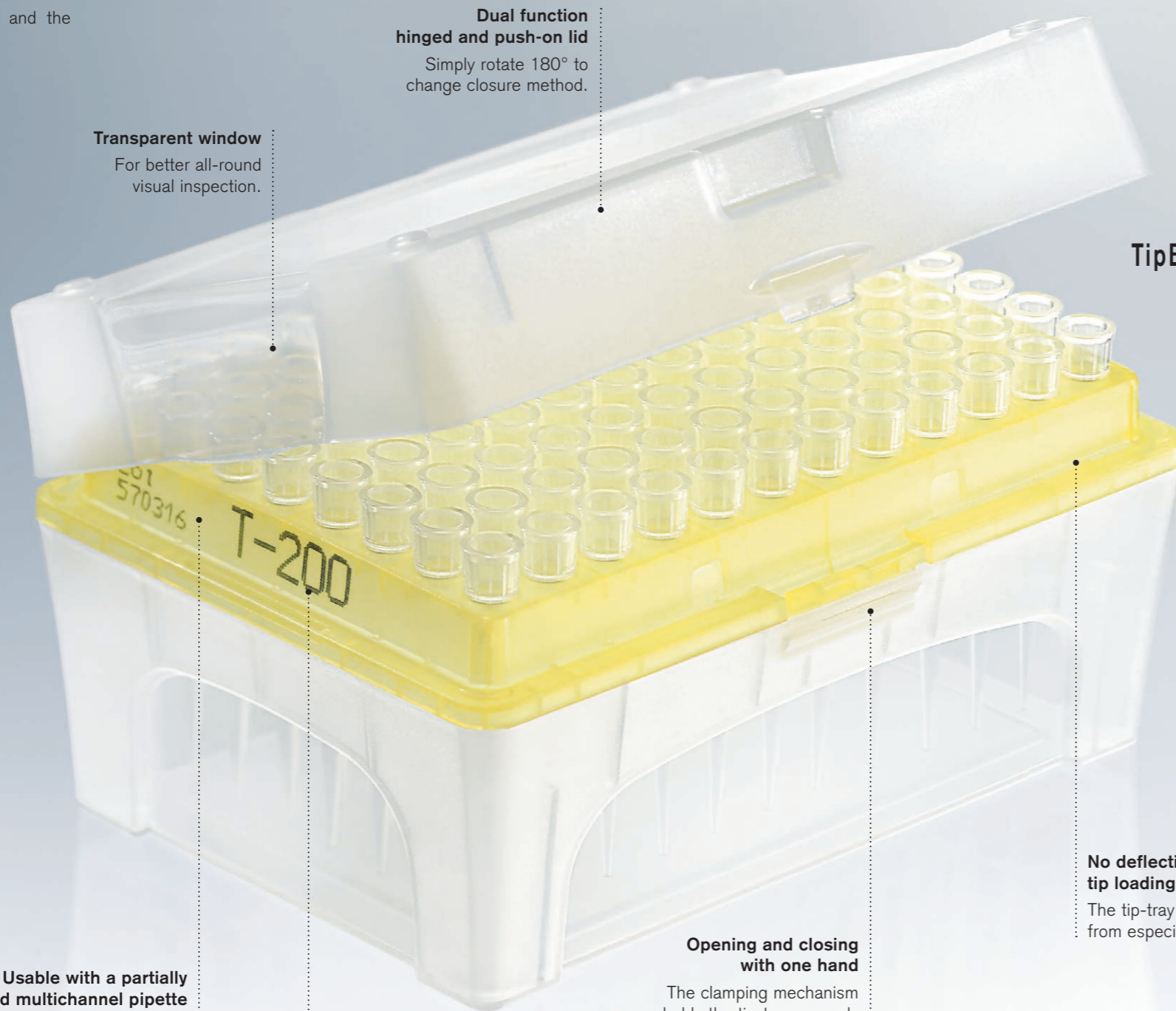

**Transparent window**  
For better all-round visual inspection.

**Dual function hinged and push-on lid**  
Simply rotate 180° to change closure method.

TipBox



TipStack™

**Usable with a partially loaded multichannel pipette**

The rimless tip-tray border enables problem-free loading of individual pipette tips with multichannel instruments.

**Colored tip-trays with side panel labeling**

The contents of the box are always clearly visible. The batch number printed on the pipette ensures traceability.

**Opening and closing with one hand**

The clamping mechanism holds the tip-tray securely in the box.

**No deflection during tip loading**

The tip-tray is fabricated from especially rigid PP.



Low TipBox is optimized for pipette tips and filter tips up to 300 µl, high TipBox up to 1000 µl. Stackable. All sizes available in 96-unit format.



## Consistently high quality

Pipette tips and filter tips are the most frequently used disposables in the laboratory. As processing methods have become increasingly sensitive, the requirements for these disposable items have changed significantly over the years. Starting with the raw materials, here PP, to the tools used and the quality tests carried out, a lot of parameters need to be considered to meet the highest standards both in research and standardized applications.

For the manufacture of pipette tips and filter tips, BRAND exclusively uses raw materials that are free from the additives di(2-hydroxyethyl)methyl dodecyl ammonium (DiHEMA) and 9-octadecanamide (oleamide). Both of these additives are frequently found in PP granules, and can interfere with biological tests, leading to spurious results. Only highly polished tooling equipment is used, so that no parting agents or demolding aids are needed.

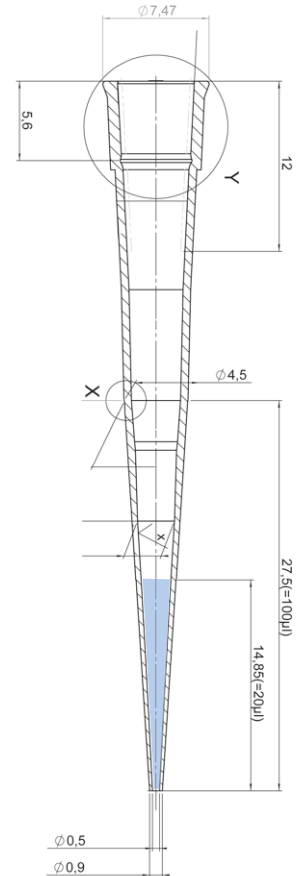

## Cleanroom manufacture



BRAND disposable items for the life sciences are produced using the most advanced cleanroom techniques in one of the world's largest cleanrooms for laboratory disposable items.

The ongoing cleanroom monitoring includes continuous measurements of air particulates, positive air pressure, air exchange rate, room temperature, and the relative humidity, among other things. This ensures that the actual parameters can immediately be checked against the nominal values. Deviations are detected immediately, and suitable countermeasures can be taken before the limit values are exceeded.

The high-precision control of environmental conditions provides a very high degree of stability in the corresponding parameters, especially the room temperature. This uniformity, together with quality testing of the final product by batch, guarantees the consistently high quality in the life science products from BRAND.

For the production of disposable items, Class 8, 7, and 5 manufacturing environments are available. Compliance of our Class 8 cleanroom with ISO 14644-1 is validated and certified by external, independent auditors.

# Pipette tips- and filter tips

Pipette tips and filter tips are manufactured by BRAND in a cleanroom under the most modern production conditions, and are automatically rack packed and packaged.

- Standard and Ultra Low Retention pipette tips
- Graduation for a quick volume check
- All racked tips and filter tips up to 1000 µl are free of DNA (< 40 fg), RNase (< 8.6 fg), endotoxins (< 1 pg) and ATP (< 1 fg)
- Autoclavable at 121 °C (2 bar), acc. DIN EN 285
- Environmentally friendly packaging systems
- CE-marked according to IVD-Directive 98/79 EC

## TipStack™

A tip tower containing 5 filled tip-trays and a TipBox constitute the space-saving refill system for 20 µl, 200 µl and 1000 µl tips. Tightly sealing spacers prevent the tips from getting stuck together, and ensure them to be free from DNA, RNases, endotoxins and ATP.

The sterile TipStacks (BIO-CERT® quality) are supplied with a transfer aid for contamination-free use in a previously sterilized TipBox.

- All components are recyclable
- Reduced amount of waste
- Sterilizable and reusable TipBox
- High purity of the pipette tips and filter tips
- Space-saving design



## TipRack

Compared to the filled TipBoxes, the amount of waste with the refill units is reduced by over 20%. All racked pipette tips and filter tips up to 1000 µl are free of DNA, RNases, endotoxins and ATP. TipRacks in BIO-CERT® quality are sterile according to ISO 11 137 and the AAMI guidelines, a SAL of 10<sup>-6</sup> is obtained.

These racks are supplied with a transfer aid that enables simple, contamination-free transfer into a previously sterilized TipBox. All tip-trays are printed on one side with information on the contents.

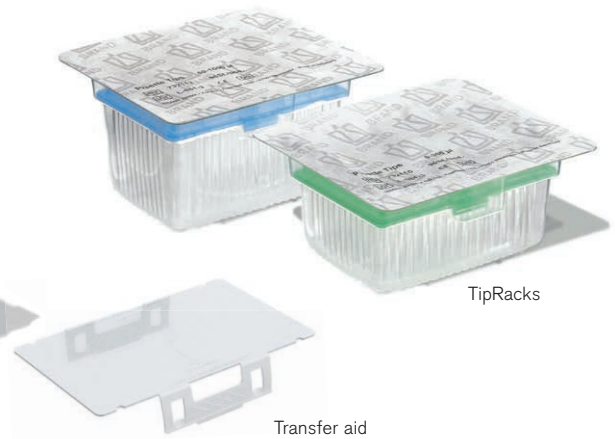

## Sterile handling

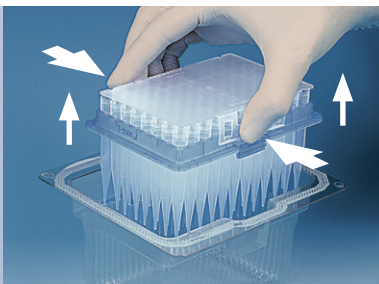

Press the long sides of the transfer aid together, and continue pressing them together while withdrawing the tip-tray. Ensure that the holding straps for the transfer aid are correctly positioned.

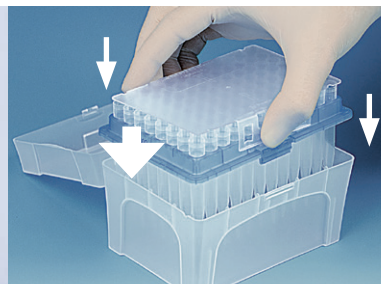

Insert the filled tip-tray perpendicularly from above into the previously sterilized TipBox until it locks into place.



Remove the transfer aid from the mounting plate. Finished – all without tip contact!

## Pipette tips and Filter Tips Sizes and Description



### 0.1 - 20 µl 0.1 - 1 µl (Filter)

The nano-cap™ tip was specially developed for the nano-liter range and hence is ideal for molecular biological applications such as PCR. It is 37 mm long, and features a capillary rise that is even visible to the naked eye at 0.1 µl. The capillary part of the tip conveniently fills gel wells for gel electrophoresis systems from most manufacturers. Suitable for pipettes up to 20 µl. The racked tips are colorless and placed into a grey-colored tip tray.

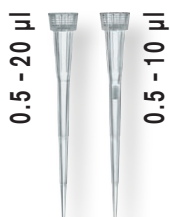

### 0.5 - 20 µl 0.5 - 10 µl (Filter)

The slender design and 46 mm length allow pipetting in microtubes and microplates without touching the walls. Graduation at 2 µl and 10 µl for quick volume check. The racked tips are colorless and placed into a grey-colored tip tray.

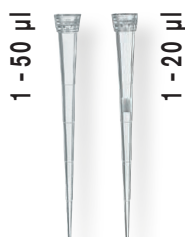

### 1 - 50 µl 1 - 20 µl (Filter)

With a length of 50 mm, the tip is ideal for working down to the bottom of narrow containers. Graduation at 2.5, 10, 25 and 50 µl for quick volume check. The racked tips are colorless and placed into a grey-colored tip tray.

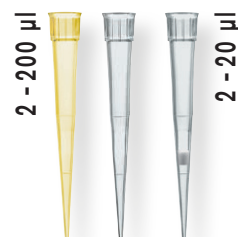

### 2 - 200 µl 2 - 20 µl (Filter)

A tested and proven thin-walled tip. Lighter in weight, 50 mm long and can be used for virtually all pipettes with yellow color code. Graduation at 20 µl and 100 µl for a quick volume check. Bulk tips are yellow colored. The racked tips are colorless and placed into a yellow-colored tip tray.

## Package Types



### Bulk packed in bags, non-sterile

All tips and filter tips are produced under supervised state-of-the-art clean-room conditions and automatically shrink-wrapped in reclosable bags and packaged in cardboard boxes. The batch number is printed on every bag.



### Racked (TipRack), sterile and non-sterile

For TipBox. Refill unit, protected in an environmentally compatible packaging of recyclable PET. Sterile TipRacks are supplied with a transfer aid so that the rack can be put into a previously autoclaved box without hand contact.



### TipBox, sterile and non-sterile

PP. With hinged lid/push-on lid. Two different sizes. Stackable and repeatedly autoclavable at 121 °C (2 bar), acc. DIN EN 285.

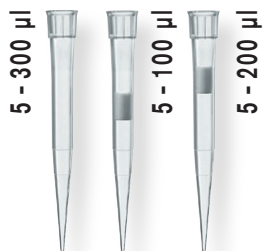

**5 - 300 µl**  
**5 - 100/200 µl (Filter)**

The thin-walled tip is suitable for reverse pipetting and plate washing. It is 53 mm long and can also be used for pipettes with yellow color code. It is particularly suited for working with multichannel pipettes. Graduation at 50 and 100 µl for quick volume check. The racked tips are colorless and placed into a green-colored tip tray.

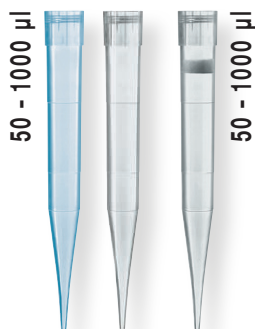

**50 - 1000 µl**  
**50 - 1000 µl (Filter)**

Proven thin-walled tip for routine laboratory and research pipetting. Its length is 70 mm. Graduation at 250, 500 and 1000 µl for a quick volume check. Bulk tips are blue colored. The racked tips are colorless and placed into a blue-colored tip tray.



**0.5 - 5 ml**

Particularly slender shape, at 160 mm length and approx. 9.6 mm diameter! This allows pipetting even from narrow volume measuring equipment such as volumetric flasks with NS 12/21. Suitable for microliter pipette Transferpette® and Thermo Fisher Scientific FINNPIPETTE®.



**1 - 10 ml**

156.5 mm length and approx. 15 mm diameter! Ideal for working with the microliter pipette Transferpette® S 10 ml. Compatible with Eppendorf® systems.



**TipStack™,**  
**sterile and non-sterile**

Space-saving, environmentally compatible refill system for TipBox. 5 racks, each having 96 tips incl. 1 TipBox. Sterile TipStacks are supplied with a transfer aid so that the rack can be put into a previously autoclaved box without hand contact. Each packaging unit contains 2 TipStacks.



**TipBox 5/10 ml,**  
**non-sterile**

The 5 ml and 10 ml tips are only available as a racked tip version in this specially corresponding TipBox.



**Sterile pipette tips** from BRAND are manufactured under certified BIO-CERT® quality\*.

\* BIO-CERT® quality see page 13

# Pipette Tips

## 0.1 - 20 µl



### Pipette tips, 0.1 - 20 µl

	Quantity	Pack of	non-sterile Cat. No.	sterile Cat. No.
bulk	2000	2 bags, 1000 each	<b>7320 02</b>	–
bulk XXL	10000	10 bags, 1000 each	<b>7320 22</b>	–
racked (TipRack)	960	10 TipRacks, 96 each	<b>7321 02</b>	<b>7321 22</b>
TipBox	480	5 boxes, 96 each	<b>7322 02</b>	–
TipBox sterile	960	10 boxes, 96 each	–	<b>7322 22</b>
TipStack™	–	–	–	–

## 0.5 - 20 µl



### Pipette tips, 0.5 - 20 µl

	Quantity	Pack of	non-sterile Cat. No.	sterile Cat. No.
bulk	2000	2 bags, 1000 each	<b>7320 04</b>	–
bulk XXL	10000	10 bags, 1000 each	<b>7320 24</b>	–
racked (TipRack)	960	10 TipRacks, 96 each	<b>7321 04</b>	<b>7321 24</b>
TipBox	480	5 boxes, 96 each	<b>7322 04</b>	–
TipBox sterile	960	10 boxes, 96 each	–	<b>7322 24</b>
TipStack™	960	2 x 5 racks, 96 each	<b>7322 44</b>	<b>7322 64</b>

## 1 - 50 µl



### Pipette tips, 1 - 50 µl

	Quantity	Pack of	non-sterile Cat. No.	sterile Cat. No.
bulk	2000	2 bags, 1000 each	<b>7320 06</b>	–
bulk XXL	10000	10 bags, 1000 each	<b>7320 26</b>	–
racked (TipRack)	960	10 TipRacks, 96 each	<b>7321 06</b>	<b>7321 26</b>
TipBox	480	5 boxes, 96 each	<b>7322 06</b>	–
TipBox sterile	960	10 boxes, 96 each	–	<b>7322 26</b>
TipStack™	–	–	–	–

## 2 - 200 µl



### Pipette tips, 2 - 200 µl (bulk tips are yellow colored)

	Quantity	Pack of	non-sterile Cat. No.	sterile Cat. No.
bulk	1000	1 bag, 1000 each	<b>7320 08</b>	–
bulk XXL	10000	10 bags, 1000 each	<b>7320 28</b>	–
racked (TipRack)	960	10 TipRacks, 96 each	<b>7321 08</b>	<b>7321 28</b>
TipBox	480	5 boxes, 96 each	<b>7322 08</b>	–
TipBox sterile	960	10 boxes, 96 each	–	<b>7322 28</b>
TipStack™	960	2 x 5 racks, 96 each	<b>7322 48</b>	<b>7322 68</b>



**TipBox, with tip-tray,  
empty**

PP. Stackable. Pack of 1.

Model	Cat. No.
up to 50 µl	<b>7329 90</b>
for 200 µl	<b>7329 92</b>
for 300 µl	<b>7329 94</b>
for 1000 µl	<b>7329 96</b>

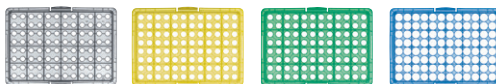

### Pipette tips, 5 - 300 µl

	Quantity	Pack of	non-sterile Cat. No.	sterile Cat. No.
bulk	1000	1 bag, 1000 each	7320 10	–
bulk XXL	10000	10 bags, 1000 each	7320 30	–
racked (TipRack)	960	10 TipRacks, 96 each	7321 10	7321 30
TipBox	480	5 boxes, 96 each	7322 10	–
TipBox sterile	960	10 boxes, 96 each	–	7322 30
TipStack™	–	–	–	–

5 - 300 µl



### Pipette tips, 50 - 1000 µl (bulk tips are blue colored)

	Quantity	Pack of	non-sterile Cat. No.	sterile Cat. No.
bulk	1000	2 bags, 500 each	7320 12	–
bulk XXL	5000	10 bags, 500 each	7320 32	–
racked (TipRack)	960	10 TipRacks, 96 each	7321 12	7321 32
TipBox	480	5 boxes, 96 each	7322 12	–
TipBox sterile	960	10 boxes, 96 each	–	7322 32
TipStack™	960	2 x 5 racks, 96 each	7322 52	7322 72

50 - 1000 µl

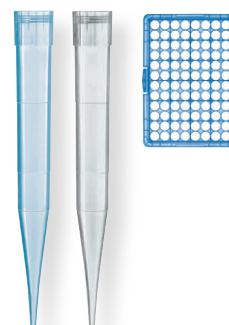

### Pipette tips, 0.5 - 5 ml

	Quantity	Pack of	non-sterile Cat. No.	sterile Cat. No.
bulk	200	1 bag, 200 each	7025 95	–
bulk XXL	1000	5 bags, 200 each	7026 00	–
racked (TipRack)	–	–	–	–
TipBox 5 ml	28	1 box, 28 each	7026 05	–
TipStack™	–	–	–	–

0.5 - 5 ml



### Pipette tips, 1 - 10 ml

	Quantity	Pack of	non-sterile Cat. No.	sterile Cat. No.
bulk	200	2 bags, 100 each	7026 03	–
bulk XXL	1000	10 bags, 100 each	7026 04	–
racked (TipRack)	–	–	–	–
TipBox 10 ml	18	1 box, 18 each	7026 08	–
TipStack™	–	–	–	–

bulk



racked (TipRack)



TipBox



TipStack™

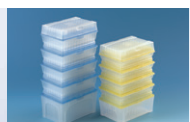

TipBox 5 ml





## Filter Tips

Non-self-sealing filter tips from BRAND have a PE filter that is free from chemical additives. Permeability is controlled by the combination of pore size and filter length, so that no aerosols can reach the pipette shaft. These filters function with consistent reliability. On the other hand, liquids can pass very slowly should they accidentally contact the filter.

Since the filter does not swell as in the case of self-sealing filter tips, the sample can be recovered from the filter by simply actuating the pipette's blow-out function, or by centrifugation if necessary. This is clearly an important advantage of non-self-sealing filters, especially when working with valuable samples. As an added advantage, the absence of filter additives protects samples from contamination.

Pipette tip without filter

Filter tip

### 0.1 - 1 $\mu$ l



#### Filter tips, 0.1 - 1 $\mu$ l

	Quantity	Pack of	non-sterile Cat. No.	sterile Cat. No.
<b>bulk</b>	960	1 bag, 960 each	<b>7325 02</b>	–
<b>racked (TipRack)</b>	960	10 TipRacks, 96 each	<b>7326 02</b>	<b>7326 22</b>
<b>TipBox</b>	480	5 boxes, 96 each	<b>7327 02</b>	–
<b>TipBox sterile</b>	960	10 boxes, 96 each	–	<b>7327 22</b>

### 0.5 - 10 $\mu$ l



#### Filter tips, 0.5 - 10 $\mu$ l

	Quantity	Pack of	non-sterile Cat. No.	sterile Cat. No.
<b>bulk</b>	960	1 bag, 960 each	<b>7325 04</b>	–
<b>racked (TipRack)</b>	960	10 TipRacks, 96 each	<b>7326 04</b>	<b>7326 24</b>
<b>TipBox</b>	480	5 boxes, 96 each	<b>7327 04</b>	–
<b>TipBox sterile</b>	960	10 boxes, 96 each	–	<b>7327 24</b>

### 1 - 20 $\mu$ l



#### Filter tips, 1 - 20 $\mu$ l

	Quantity	Pack of	non-sterile Cat. No.	sterile Cat. No.
<b>bulk</b>	960	1 bag, 960 each	<b>7325 06</b>	–
<b>racked (TipRack)</b>	960	10 TipRacks, 96 each	<b>7326 06</b>	<b>7326 26</b>
<b>TipBox</b>	480	5 boxes, 96 each	<b>7327 06</b>	–
<b>TipBox sterile</b>	960	10 boxes, 96 each	–	<b>7327 26</b>



### Filter tips, 2 - 20 µl

	Quantity	Pack of	non-sterile Cat. No.	sterile Cat. No.
<b>bulk</b>	960	1 bag, 960 each	<b>7325 08</b>	–
<b>racked (TipRack)</b>	960	10 TipRacks, 96 each	<b>7326 08</b>	<b>7326 28</b>
<b>TipBox</b>	480	5 boxes, 96 each	<b>7327 08</b>	–
<b>TipBox sterile</b>	960	10 boxes, 96 each	–	<b>7327 28</b>

2 - 20 µl



### Filter tips, 5 - 100 µl

	Quantity	Pack of	non-sterile Cat. No.	sterile Cat. No.
<b>bulk</b>	960	1 bag, 960 each	<b>7325 10</b>	–
<b>racked (TipRack)</b>	960	10 TipRacks, 96 each	<b>7326 10</b>	<b>7326 30</b>
<b>TipBox</b>	480	5 boxes, 96 each	<b>7327 10</b>	–
<b>TipBox sterile</b>	960	10 boxes, 96 each	–	<b>7327 30</b>

5 - 100 µl



### Filter tips, 5 - 200 µl

	Quantity	Pack of	non-sterile Cat. No.	sterile Cat. No.
<b>bulk</b>	960	1 bag, 960 each	<b>7325 12</b>	–
<b>racked (TipRack)</b>	960	10 TipRacks, 96 each	<b>7326 12</b>	<b>7326 32</b>
<b>TipBox</b>	480	5 boxes, 96 each	<b>7327 12</b>	–
<b>TipBox sterile</b>	960	10 boxes, 96 each	–	<b>7327 32</b>

5 - 200 µl

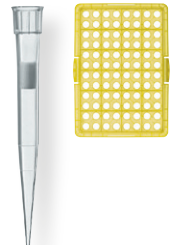

### Filter tips, 50 - 1000 µl

	Quantity	Pack of	non-sterile Cat. No.	sterile Cat. No.
<b>bulk</b>	960	1 bag, 960 each	<b>7325 14</b>	–
<b>racked (TipRack)</b>	960	10 TipRacks, 96 each	<b>7326 14</b>	<b>7326 34</b>
<b>TipBox</b>	480	5 boxes, 96 each	<b>7327 14</b>	–
<b>TipBox sterile</b>	960	10 boxes, 96 each	–	<b>7327 34</b>

50 - 1000 µl



bulk

racked (TipRack)

TipBox





## Ultra Low Retention Pipette Tips

The surfaces of the Ultra Low Retention tips are produced through a special physicochemical process. The homogeneous, defect-free surface thus produced has extremely low surface tension – over 50% less than PTFE (see table). This significantly reduces sample loss and provides substantially higher reproducibility when working with critical media.

- Ideal for biological samples that contain detergents such as TRITON™ X-100, SDS, Tween etc.
- No additives that can be leached out! No siliconization of the surface!
- High chemical resistance. Ideal for working with solvents.
- The tips can be autoclaved at 121 °C (2 bar) without damaging the material properties.

Surface	Surface tension
BRAND® PP Ultra Low Retention	9 mN/m
PTFE	19 mN/m
Silicone	21.5 mN/m
Untreated PP	30 mN/m
Water	72 mN/m

### 0.1 - 20 µl



#### ULR pipette tips, 0.1 - 20 µl

	Quantity	Pack of	non-sterile Cat. No.	sterile Cat. No.
TipBox	480	5 boxes, 96 each	<b>7323 02</b>	–
TipBox sterile	960	10 boxes, 96 each	–	<b>7323 22</b>
TipStack™	–	–	–	–

### 0.5 - 20 µl



#### ULR pipette tips, 0.5 - 20 µl

	Quantity	Pack of	non-sterile Cat. No.	sterile Cat. No.
TipBox	480	5 boxes, 96 each	<b>7323 04</b>	–
TipBox sterile	960	10 boxes, 96 each	–	<b>7323 24</b>
TipStack™	960	2 x 5 racks, 96 each	<b>7323 44</b>	<b>7323 64</b>

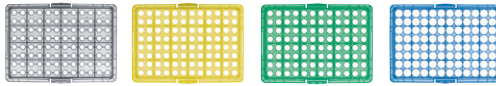

### ULR pipette tips, 1 - 50 µl

	Quantity	Pack of	non-sterile Cat. No.	sterile Cat. No.
TipBox	480	5 boxes, 96 each	7323 06	–
TipBox sterile	960	10 boxes, 96 each	–	7323 26
TipStack™	–	–	–	–

### 1 - 50 µl



### ULR pipette tips, 2 - 200 µl

	Quantity	Pack of	non-sterile Cat. No.	sterile Cat. No.
TipBox	480	5 boxes, 96 each	7323 08	–
TipBox sterile	960	10 boxes, 96 each	–	7323 28
TipStack™	960	2 x 5 racks, 96 each	7323 48	7323 68

### 2 - 200 µl

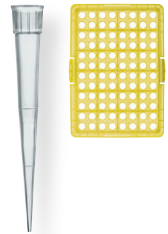

### ULR pipette tips, 5 - 300 µl

	Quantity	Pack of	non-sterile Cat. No.	sterile Cat. No.
TipBox	480	5 boxes, 96 each	7323 10	–
TipBox sterile	960	10 boxes, 96 each	–	7323 30
TipStack™	–	–	–	–

### 5 - 300 µl



### ULR pipette tips, 50 - 1000 µl

	Quantity	Pack of	non-sterile Cat. No.	sterile Cat. No.
TipBox	480	5 boxes, 96 each	7323 12	–
TipBox sterile	960	10 boxes, 96 each	–	7323 32
TipStack™	960	2 x 5 racks, 96 each	7323 52	7323 72

### 50 - 1000 µl

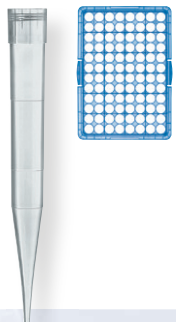

TipBox

TipStack™

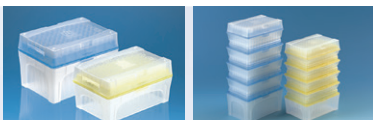

# Ultra Low Retention Filter Tips

## 0.1 - 1 $\mu$ l



### ULR filter tips, 0.1 - 1 $\mu$ l

	Quantity	Pack of	non-sterile Cat. No.	sterile Cat. No.
TipBox	480	5 boxes, 96 each	7328 02	-
TipBox sterile	960	10 boxes, 96 each	-	7328 22

## 0.5 - 10 $\mu$ l

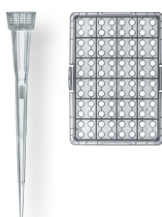

### ULR filter tips, 0.5 - 10 $\mu$ l

	Quantity	Pack of	non-sterile Cat. No.	sterile Cat. No.
TipBox	480	5 boxes, 96 each	7328 04	-
TipBox sterile	960	10 boxes, 96 each	-	7328 24

## 1 - 20 $\mu$ l



### ULR filter tips, 1 - 20 $\mu$ l

	Quantity	Pack of	non-sterile Cat. No.	sterile Cat. No.
TipBox	480	5 boxes, 96 each	7328 06	-
TipBox sterile	960	10 boxes, 96 each	-	7328 26

## 2 - 20 $\mu$ l

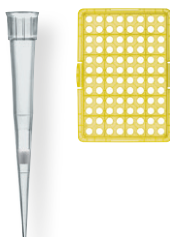

### ULR filter tips, 2 - 20 $\mu$ l

	Quantity	Pack of	non-sterile Cat. No.	sterile Cat. No.
TipBox	480	5 boxes, 96 each	7328 08	-
TipBox sterile	960	10 boxes, 96 each	-	7328 28

## 5 - 100 $\mu$ l

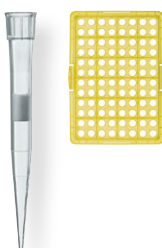

### ULR filter tips, 5 - 100 $\mu$ l

	Quantity	Pack of	non-sterile Cat. No.	sterile Cat. No.
TipBox	480	5 boxes, 96 each	7328 10	-
TipBox sterile	960	10 boxes, 96 each	-	7328 30



### ULR filter tips, 5 - 200 µl

	Quantity	Pack of	non-sterile Cat. No.	sterile Cat. No.
TipBox	480	5 boxes, 96 each	7328 12	-
TipBox sterile	960	10 boxes, 96 each	-	7328 32

5 - 200 µl

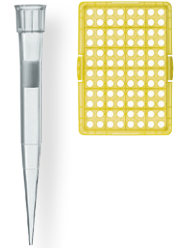

### ULR filter tips, 50 - 1000 µl

	Quantity	Pack of	non-sterile Cat. No.	sterile Cat. No.
TipBox	480	5 boxes, 96 each	7328 14	-
TipBox sterile	960	10 boxes, 96 each	-	7328 34

50 - 1000 µl



#### TipBox



## Comparison chart

### Standard and Ultra Low Retention pipette tips from BRAND

Volume 200 µl, compared with various media and subsequent photometric analysis and conversion.

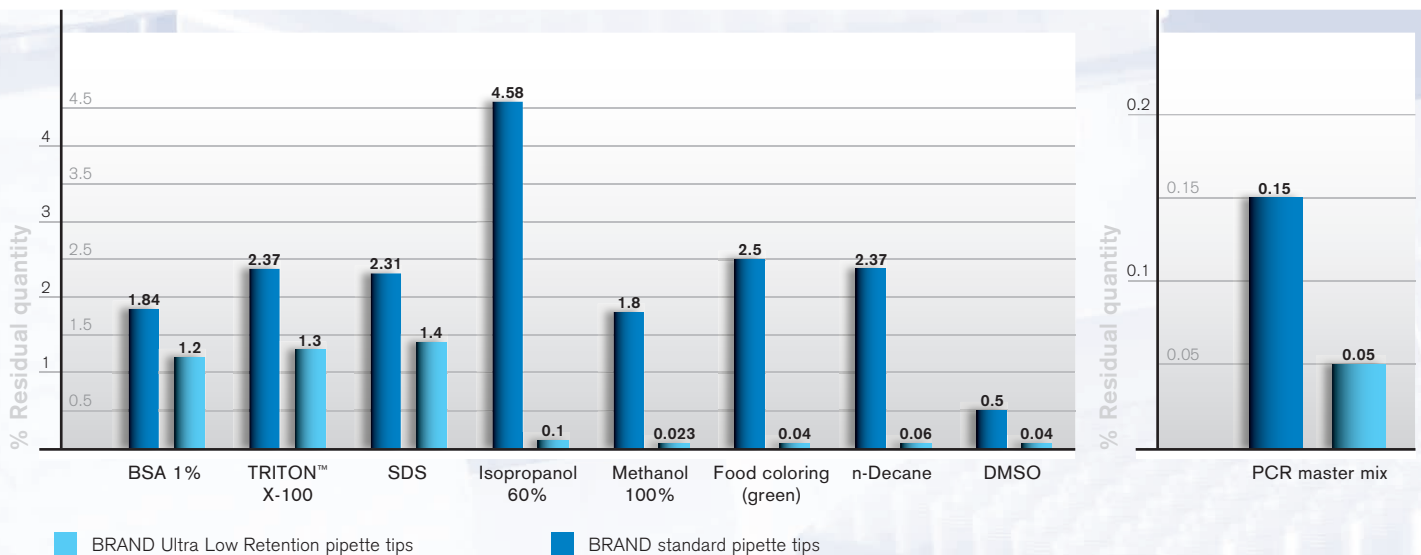

# Pipette Tips and Filter Tips in Standard and Ultra Low Retention Quality

Optimum results are achieved in combination with BRAND microliter pipettes. BRAND quality tips seat perfectly for precise analyses.

Pipette and filter tips from BRAND are tested for BRAND pipettes and most of the pipette types of GILSON®, Thermo Fisher Scientific FINNPIPETTE®, Eppendorf® and BIOHIT®/sartorius®.

The 5 ml tip is exclusively tested for BRAND pipettes and Thermo Fisher Scientific FINNPIPETTE®. The 10 ml tip is tested for BRAND and Eppendorf®.



Note: Pipette shafts can be subject to modification. The fit depends on the manufacturer, pipette type, serial number, and date of manufacture, among other things. We recommend checking the fit of the tips using the free sample bag.

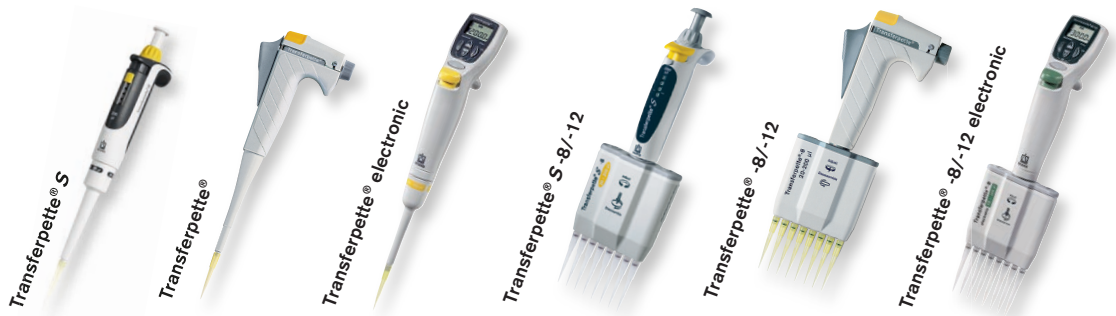

## The right Pipette Tip

Pipette tips Filter tips Volume range	Transferpette® single channel Nominal volume													Transferpette® multichannel Nominal volume												
	1 µl	2.5 µl	5 µl	10 µl	10 µl	20 µl	20 µl	25 µl	50 µl	100 µl	200 µl	200 µl	250 µl	500 µl	1000 µl	2 ml	5 ml	10 ml	10 µl	20 µl	25 µl	50 µl	100 µl	200 µl	300 µl	
0.1 - 20 µl	✓	✓ <sup>2)</sup>		✓ <sup>2)</sup>															✓	✓						
0.5 - 20 µl		✓		✓		✓													✓	✓						
1 - 50 µl		✓ <sup>2)</sup>		✓		✓													✓	✓						
2 - 200 µl <sup>1)</sup>			✓	✓		✓	✓	✓	✓	✓											✓	✓	✓	✓	✓	✓
5 - 300 µl			✓	✓		✓	✓	✓	✓	✓											✓	✓	✓	✓	✓	✓
50 - 1000 µl <sup>1)</sup>											✓	✓	✓	✓												
0.5 - 5 ml																✓	✓									
1 - 10 ml																		✓								
0.1 - 1 µl	✓	✓ <sup>2)</sup>		✓ <sup>2)</sup>															✓							
0.5 - 10 µl		✓		✓		✓													✓	✓						
1 - 20 µl				✓		✓													✓	✓						
2 - 20 µl			✓	✓		✓	✓	✓	✓	✓											✓	✓	✓	✓	✓	✓
5 - 100 µl			✓	✓		✓	✓	✓	✓	✓											✓	✓	✓	✓	✓	✓
5 - 200 µl										✓											✓	✓	✓	✓	✓	✓
50 - 1000 µl														✓	✓											

✓ = Tip volume less than pipette's nominal volume

<sup>1)</sup> Bulk tips are yellow or blue colored, racked tips are colorless in a yellow-colored or blue-colored tip tray

<sup>2)</sup> Calibration and possible adjustment needed

All racked tips and filter tips up to 1000 µl are

## free of DNA and RNases, Endotoxins and ATP

# DNA ATP

**DNA and RNases** RNases are ubiquitous and extremely stable. To protect the RNA molecules from undergoing enzymatic degradation, one must be absolutely certain that plastic items are free from RNases.

Products from BRAND are free from DNA ( $< 4 \times 10^{-14}$  g/tip = 40 fg), to avoid false positive results, e.g., in PCR\*, and free from RNases ( $< 8.6 \times 10^{-15}$  g/tip = 8.6 fg), to make it possible to work with RNA.

**ATP** ATP is an energy-rich, transportable molecule. It is an indicator for living cells. Products from BRAND are free of ATP (ATP concentration  $< 1 \times 10^{-15}$  g/tip = 1 fg) and thus are especially suitable for luminescence measurements, e.g., those employed in the hygiene monitoring field according to the HACCP concept.

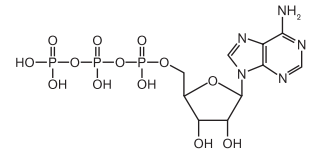

**Endotoxins** Endotoxins refer to the components present in the outer membranes of Gram-negative bacteria. These components are lipopolysaccharides that are released when cells are destroyed. The concentration of endotoxins in products from BRAND is determined by the kinetic-turbidimetric limulus amoebocyte lysate (LAL) test. The detection limit is 0.01 EU/ml. This corresponds to an endotoxin concentration of  $< 1 \times 10^{-12}$  g/tip (1 pg/tip). Freedom from endotoxins is required in pharmaceutical manufacture and cell culture.

## Sterile

Tips and filter tips up to 1000 µl are available in sterile quality. They are manufactured under certified BIO-CERT® quality.

**BIO-CERT®**

# BIO-CERT®

**Sterility** BRAND products are sterilized with beta radiation according to ISO 11 137 and the AAMI Guidelines. The radiation dose is at least 12.1 kGy.

An SAL (sterility assurance level) of  $10^{-6}$  is guaranteed, meaning no more than one part in  $1 \times 10^6$  is contaminated! This level of sterility complies with the requirements of USP 29 and the Ph.Eur.

**BIO-CERT® products are sterile, free from DNA, RNases, endotoxins and ATP.**

**A corresponding certificate is included in delivery.**





BRAND®, BIO-CERT®, Transferpette®, BRAND. For lab. For life.® and the BRAND word and figurative mark are registered trademarks of BRAND GMBH + CO KG, Germany.

Other reproduced brands are the property of the respective owner.

Our technical literature is intended to inform and advise our customers. However, the validity of general empirical values, and of results obtained under test conditions, for specific applications depends on many factors beyond our control. Please appreciate, therefore, that no claims can be derived from our advice. The user is responsible for checking the appropriateness of the product for any particular application.

California Residents: For more information concerning California Proposition 65, please refer to [www.brand.de/calprop65](http://www.brand.de/calprop65)

Subject to technical modification without notice. Errors excepted.

BRAND GMBH + CO KG · P.O. Box 11 55 · 97861 Wertheim · Germany  
Tel.: +49 9342 808-0 · Fax: +49 9342 808-98000 · E-Mail: [info@brand.de](mailto:info@brand.de) · Internet: [www.brand.de](http://www.brand.de)

