



9,000 BTU/H CEILING CASSETTE

SUBMITTAL COVER SHEET

PROJECT NAME _____

LOCATION _____

ARCHITECT _____

ENGINEER _____

CONTRACTOR _____

REFERENCE _____

SUBMITTED BY _____ DATE _____

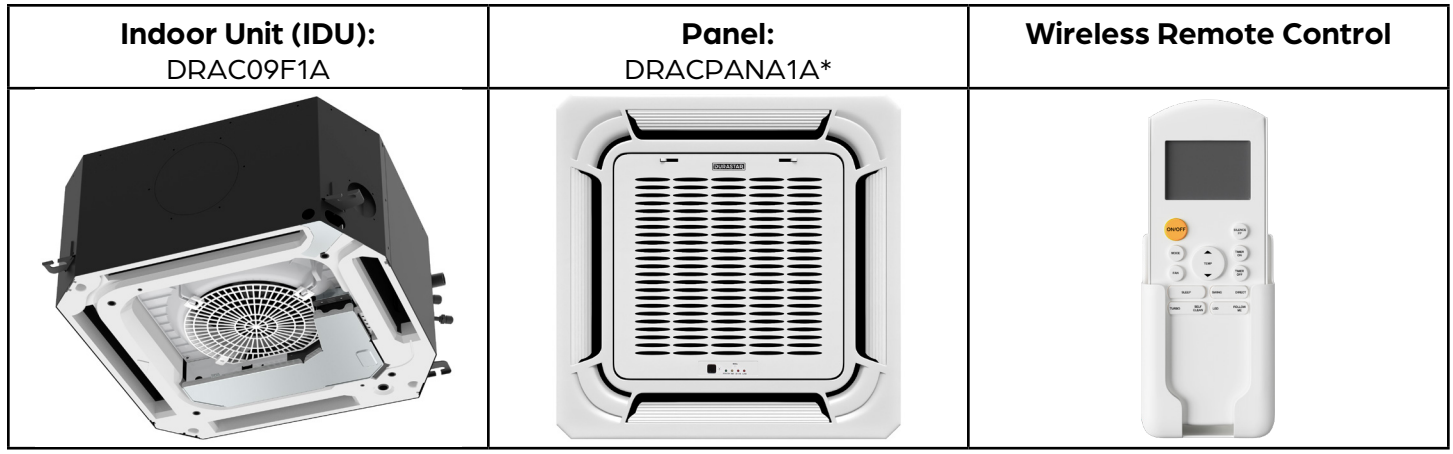

CAPACITIES		
Cooling Capacity (BTU/hr)	Rated	9000
Heating Capacity (BTU/hr)	Rated	10000

ELECTRICAL DATA	
Voltage/Phase/Frequency	208-230V, 1 Phase, 60 Hz

LINE SET REQUIREMENTS	
Connection Type	Flare
Liquid	Ø1/4" (Ø6.35mm)
Gas	Ø3/8" (Ø9.52mm)
Drain Port O.D. / Drain Hose I.D.	Ø1" (Ø25mm)

INDOOR UNIT FAN DATA		
Air Flow (CFM)	Low	257
	Medium	301
	High	374
Type	DC	
RLA	0.465	
Sound Pressure (dB(A))	Low	33
	Medium	37
	High	41

INDOOR UNIT DIMENSIONS		
Unit Dimensions	Width	22 7/16"
	Depth	22 7/16"
	Height	10 1/4"
Carton Dimensions	Width	26 1/2"
	Depth	26 1/2"
	Height	13 1/4"
Net Weight	32.0 lbs.	
Gross Weight	38.1 lbs.	

- PRODUCT FEATURES**
- Wireless Remote Control with "Follow Me" Technology
 - Auto Restart
 - Auto Changeover
 - 24-hour Timer
 - Self Clean Function

*Panel sold separately



Specifications are subject to change without notice.
 © 2021 Ferguson Enterprises LLC
 www.durastar.com



9,000 BTU/H CEILING CASSETTE

DIMENSIONS - DRAC09F1A

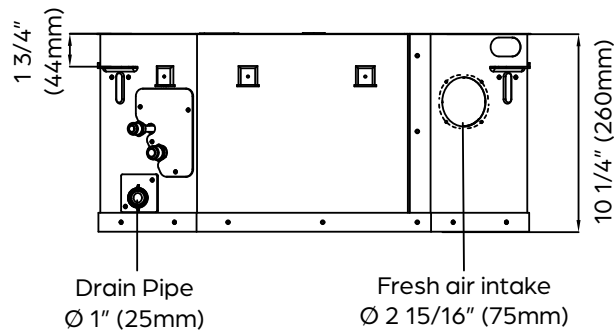
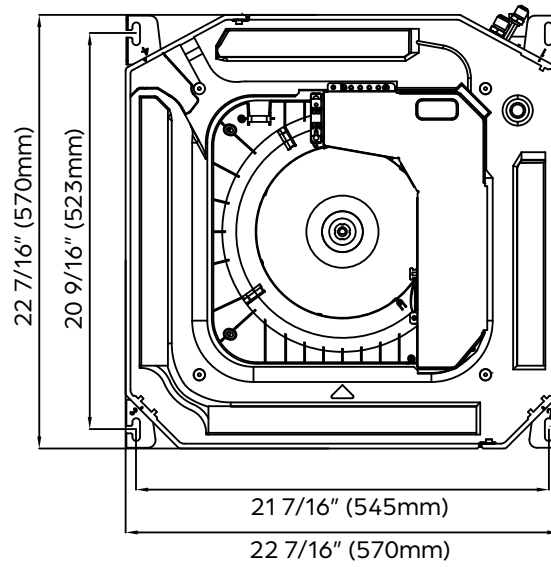

DRACPANA1A:

