

COASTER[®]
FINE FURNITURE

900382B1

CORNER MANTEL

**ASSEMBLY INSTRUCTION
COASTER FINE FURNITUR**

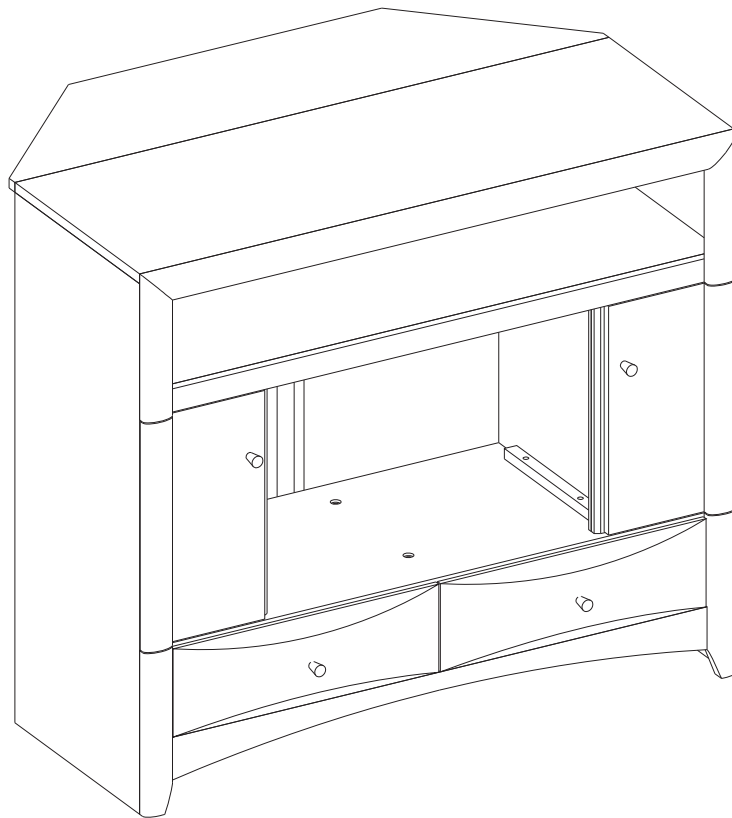

[www.coastercompany .com](http://www.coastercompany.com)

ASSEMBLY TIPS:

- Remove hardware from box and sort by size.
- Please check to see that all hardware and parts are present prior start of assembly.
- Please follow attached instructions in the same sequence as numbered to assure fast & easy assembly.
- Attach the fireplace insert to the completed wood mantel last. Install insert in from the back of the fireplace so as not to scratch the hearth/base.

CARE & CLEANING

1. Dust your fireplace regularly with a soft non-lint producing cloth or household dusting product.
2. You can clean your fireplace with a gentle non-abrasive household cleaner. Make sure to dry your fireplace immediately with a soft cloth or towel.



Warning!

- DO NOT MOVE MANTEL OR INSERT WHILE PLUGGED INTO POWER SUPPLY.
- DO NOT SIT ON ANY PART OF THE MANTEL.

PARTS IDENTIFICATION

(A)

Hearth/Base

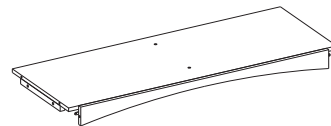

1PC

(B)

Center Left Side Panel

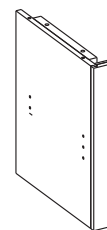

1PC

PARTS IDENTIFICATION

(C)

Center Right Side Panel

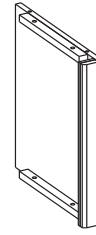

1PC

(D)

Center Shelf

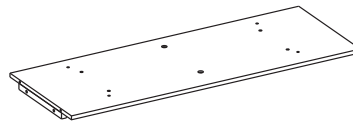

1PC

(E)

Left Side Panel



1PC

(F)

Right Side Panel

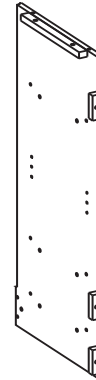

1PC

(G)

Mantel/Top Panel

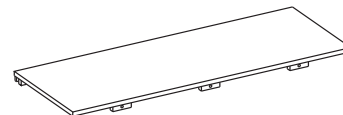

1PC

(H)

Wood Shelf

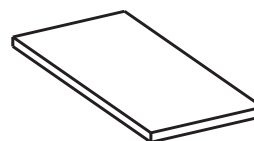

2PC

PARTS IDENTIFICATION

(I) Lower Back Panel  **1PC**

(J) Upper Center Shelf  **1PC**

(K) Center Back Panel  **1PC**

(L) Left Front Door  **1PC**

(M) Right Front Door  **1PC**

(N) Support Divider  **1PC**

(O) Drawer  **2PC**

PARTS IDENTIFICATION

(P) Upper Center Bar  1PC

(Q) Upper Left Bar  1PC

(R) Upper Right Bar  1PC

(S) Lower Left Bar  1PC

(T) Lower Right Bar  1PC

(U) Side Back Panel  2PC

PARTS IDENTIFICATION

(V)

Lower Center Back Panel

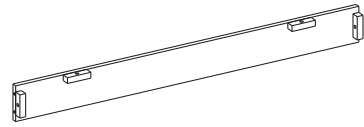

1PC

(W)

"L" Corner Barce



1PC



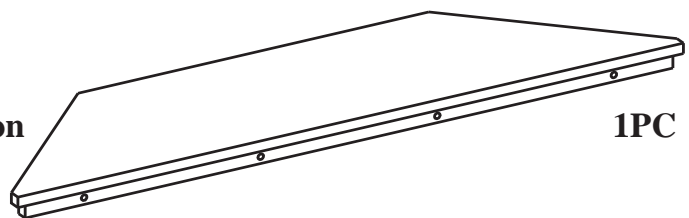

(X)

Top Corner Extension

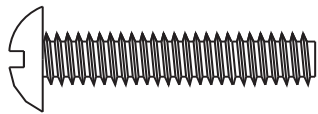
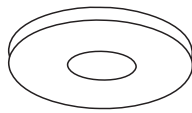

1PC

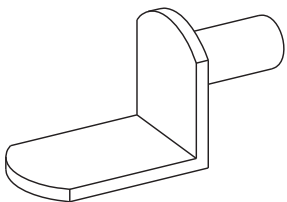
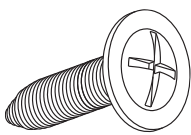
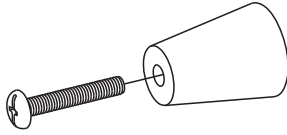
HARDWARE LIST

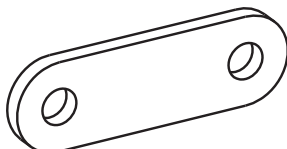
(AA)	Bolt		49PC
(BB)	Washer		49PC
(CC)	Wood Dowel		38PC
(DD)	Shelf Pin		8PC
(EE)	Wood Screw		46PC
(FF)	Knob (with bolt)		4PC
(GG)	Screw		8PC
(HH)	Connection Plate		4PC

