



USER'S GUIDE

**Installation, Operation, and Maintenance for your
portable air conditioner**

PORTABLE AIR CONDITIONER
MODEL- APAC140C

Important Safety Information

Improper handling can cause serious damage to the appliance and/or to the user.

This portable air conditioner is not intended for use by children. Children should be supervised to ensure that they do not play with this product.

Electrical Safety

- This unit is designed for indoor use only.
- Do not use the unit in extremely humid or wet environments.
- Do not wet the housing or control panel.
- Do not pull the unit by the cord.
- Always turn the unit off and unplug it from the socket when cleaning.
- Unplug the unit if it is not going to be used for a long period of time.
- Do not operate the unit with a damaged plug or a loose socket.
- Use only the correct power supply with appropriate amperage.
- If the power cord is damaged, it must be replaced by the manufacturer, a service agent, or qualified technician.
- Do not remove any part of the casing unless instructed by an authorized technician.

General Safety

- This portable air conditioner is not intended to be used by children.
- Do not allow children to play with the controls or drop any objects into the air outlets or vents.
- Do not place objects or let any person sit on top of the unit.
- Only use in the upright position on a flat, level surface and provide at least 20 inches of clearance from any walls or objects.
- Route the power cord carefully to avoid a tripping hazard.
- This unit is intended for domestic and light commercial use only. Do not use the portable air conditioner for industrial use. Any other use may invalidate the warranty.

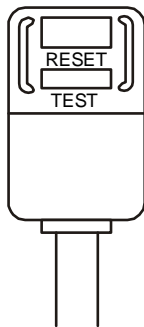

Your portable air conditioner is supplied with a Leakage-Current Detection and Interruption (LCDI) safety plug. This device provides protection to reduce the risk of fire due to arcing faults in the power supply cord. Before using your portable air conditioner, follow the instructions below to ensure that the LCDI plug is working properly:

1. Plug the power cord to a grounded outlet.
2. Press the TEST button on the LCDI plug. This should trip the plug and cut the power to the air conditioner. If the plug does not trip and you are able to turn on the unit, please contact Avallon support.

DO NOT USE YOUR PORTABLE AIR CONDITIONER IF THE TEST FAILS.

Press the RESET button to start using your air conditioner.

Do not use the TEST and RESET buttons as an ON/OFF switch.

Table of Contents

IMPORTANT SAFETY INFORMATION	I
TABLE OF CONTENTS	II
INTRODUCTION	1
PARTS IDENTIFICATION	2
BACK VIEW.....	2
FRONT VIEW.....	2
WINDOW KIT INSTALLATION INSTRUCTIONS	3
PREPARATIONS FOR INSTALLING THE WINDOW KIT.....	3
WINDOW KIT PARTS LIST:.....	3
PARTS FOR CONTINUOUS AND MISTING DRAINAGE.....	3
INSTALLING THE GRATED ADAPTER.....	4
INSTALLING THE WINDOW PLATES.....	5
ATTACHING THE DUCT CONNECTORS TO THE EXHAUST HOSE.....	6
CONNECTING THE DUCT CONNECTOR TO THE UNIT.....	7
CONNECTING THE DUCT CONNECTOR TO THE GRATED ADAPTER.....	7
NOTES ABOUT THE EXHAUST HOSE.....	8
DRAINAGE OPTIONS	9
CONTINUOUS DRAIN.....	9
MISTING DRAIN.....	9
INSTALLING THE BATTERIES.....	11
REMOTE CONTROL LCD INDICATORS	12
OPERATING THE REMOTE CONTROL	13
POWER.....	13
AUTO-RESTART:.....	13
COOLING MODE.....	13
DEHUMIDIFYING MODE.....	13
HEAT MODE.....	13
FAN ONLY MODE.....	14
AUTOMATIC MODE.....	14
FAN SPEED.....	14
CLOCK.....	14
TIMER.....	15
<i>How to set the unit to automatically turn on</i>	<i>15</i>
<i>How to set the unit to automatically turn off</i>	<i>15</i>
FRONT PANEL LIGHTS AND CONTROLS	15
FRONT PANEL LIGHTS.....	15
FRONT PANEL CONTROLS.....	15
ENERGY SAVING GUIDE	16
MAINTENANCE	17
CLEANING THE UNIT.....	17
CLEANING THE PRE-FILTER.....	17
PREPARATION FOR STORAGE.....	17
TROUBLESHOOTING	18
TROUBLESHOOTING CONTINUED.....	19
SPECIFICATIONS	20

Introduction

Thank you for purchasing your Avallon portable air conditioner. Avallon is dedicated to developing products that will enhance your lifestyle with superior quality and distinctive features. Please visit **www.avallon.com** for more information on your product and other Avallon products.

This manual contains important information regarding the proper installation, use and maintenance of your portable air conditioner. Following this manual will ensure that your product will work at its peak performance and efficiency.

Please save the original product packaging in case you need to safely transport your portable air conditioner.

For Your Records:

Please write down the model number and serial number below for future reference. Both numbers are located on the ratings label on the back of your unit and are needed to obtain warranty service. You may also want to staple your receipt to this manual as it is the proof of your purchase, and is also needed for service under your warranty.

Model Number: _____

Serial Number: _____

Date of Purchase: _____

To better serve you, please do the following before contacting customer service:

If you received a damaged product, immediately contact the dealer that sold you the product.

Read and follow this instruction manual carefully to help you install, use and maintain your portable air conditioner.

Read the troubleshooting section of this manual as it will help you diagnose and solve common issues.

Visit us on the web at **http://www.avallon.com** for product guides, additional troubleshooting resources and up-to-date information. If you need service, our friendly customer service representatives are available via email at **service@avallon.com** or by telephone at **1 (866) 471-7427**.

Parts Identification

Front View

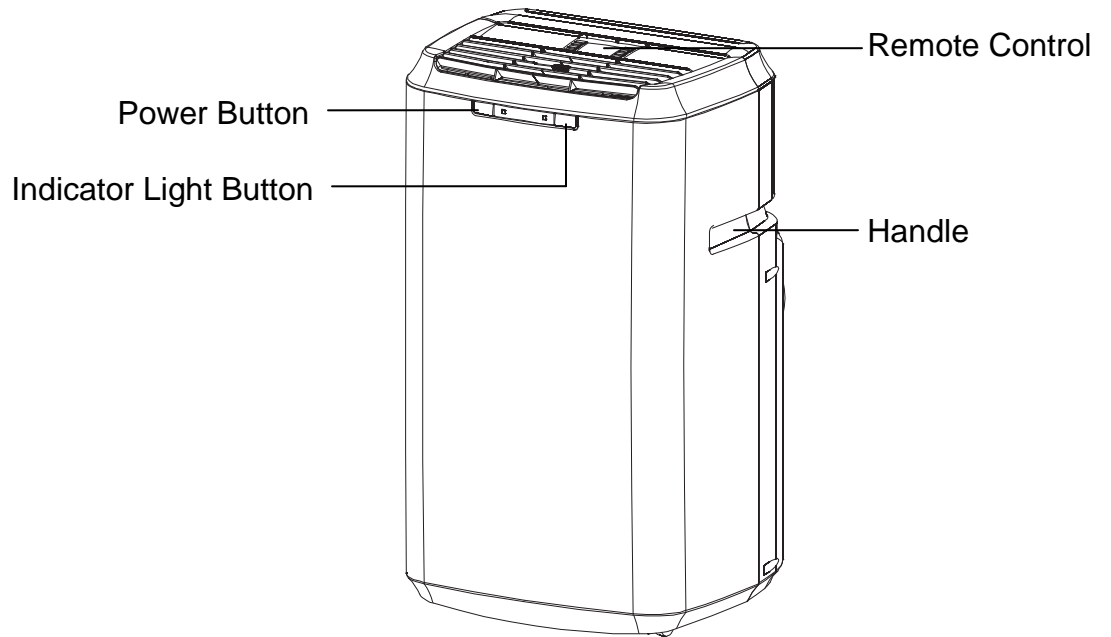

Back View

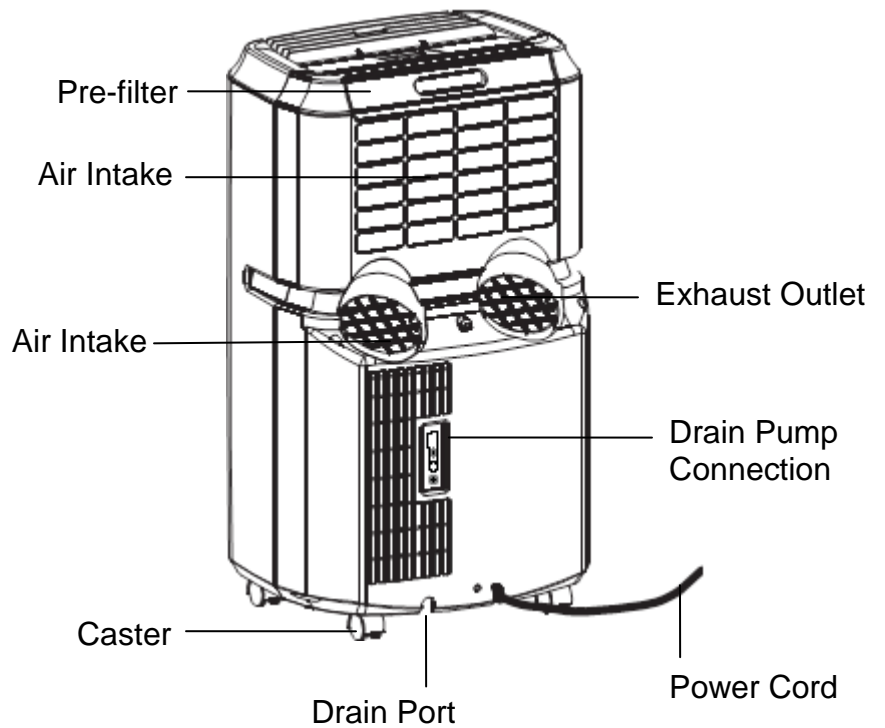

CAUTION: Make sure the drain plug is firmly installed before using the unit to prevent leaking.

Window Kit Installation Instructions

Preparations for installing the window kit

You must vent your portable air conditioner when running it in cooling mode or heat mode (certain models). Your unit includes a window exhaust kit that can be used to vent the unit out a window. Before you begin, make sure you have all the parts necessary for installation.

Window Kit Parts List:

NOTE: There is one duct connector that includes an opening for the water line for use in the misting drain operation. This connector must be installed to the exhaust outlet on the unit. Please review pages 9-10 for more details.

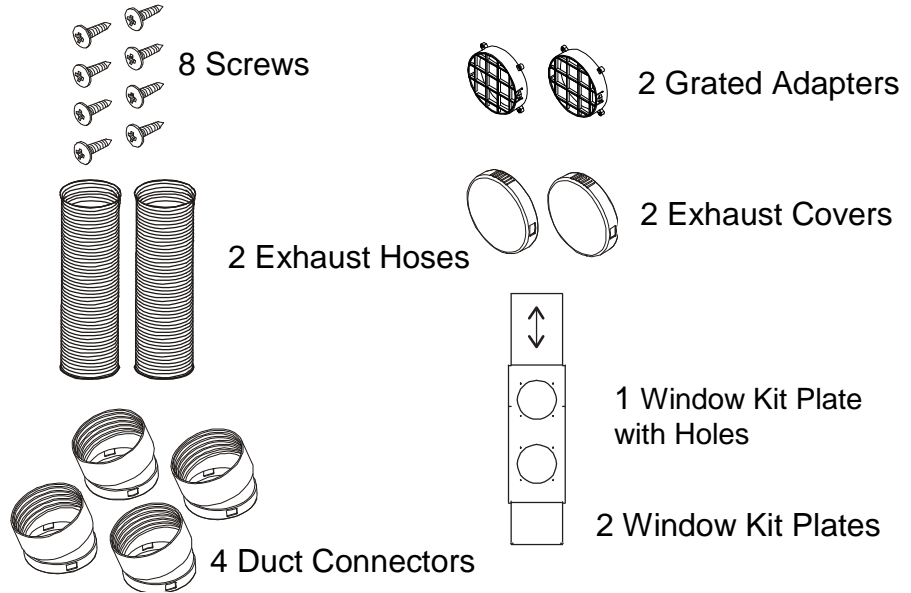

Parts for Continuous and Misting Drainage

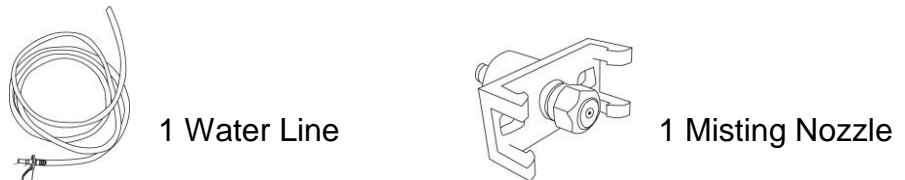

NOTE: Exhaust Covers may be attached to the Grated Adapters. You may need to twist and pull apart to separate them.

NOTE: You may need to contact your electrician if your room's circuit is not able to power your unit.

If you have multiple windows, choose one that is near an electrical outlet that will be able to provide sufficient power to your unit. See the power requirements listed on the product label printed on the side, or on the back of your portable air conditioner. Your window kit can be installed on a horizontal or vertical sliding window as shown in the following pictures:

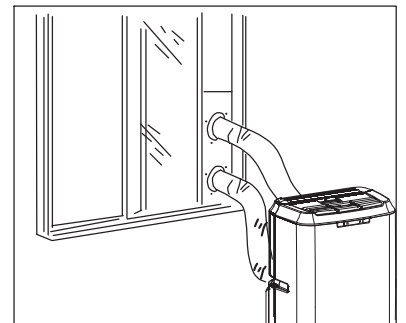
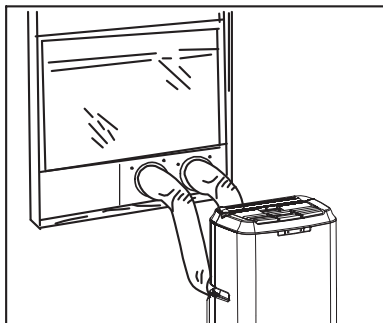

Installing the grated adapter

①

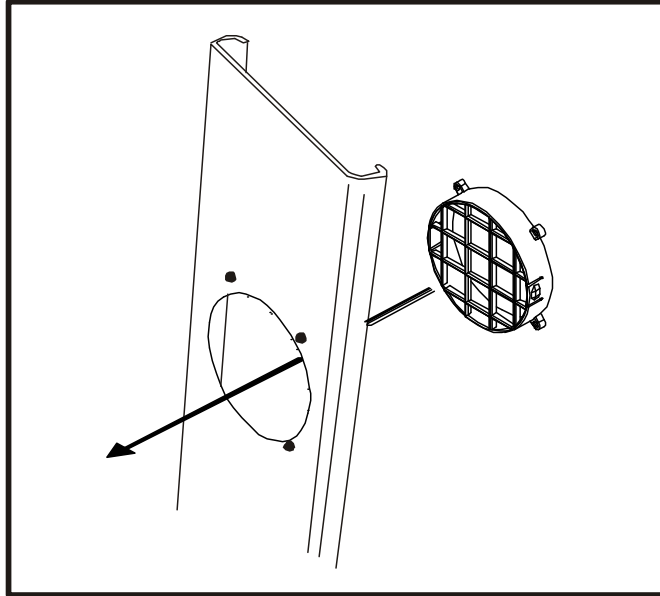

1. Insert the round grated adapters through the back grooved side of the window kit plate with holes.

②

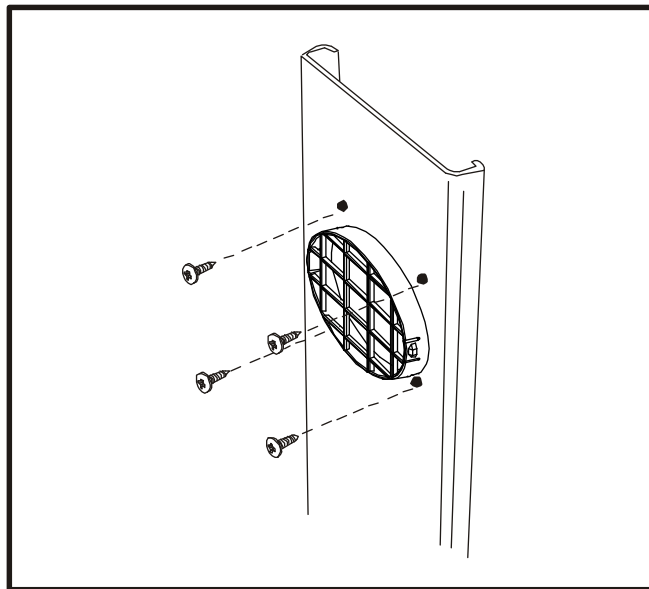

2. Secure the grated adapters by fastening the screws from flat side of the window kit plate to the holes on the grated adapter.

Installing the window plates

3

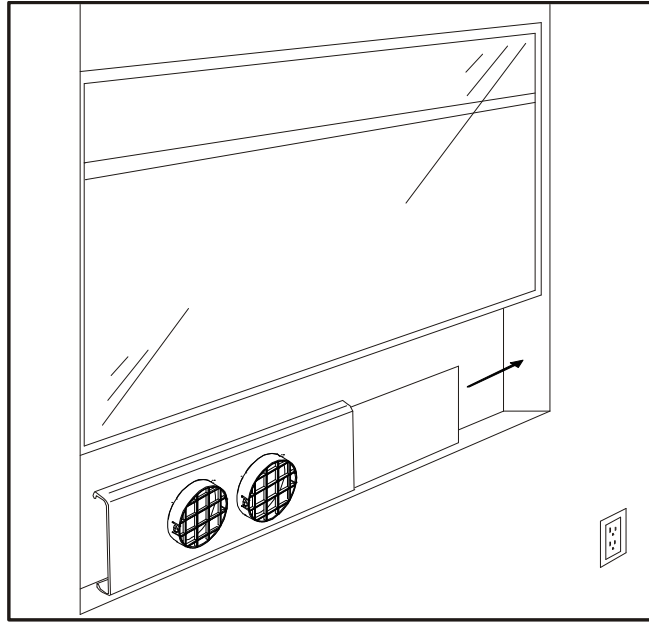

3. Open your window and place the window kit with grooved side facing outward on the window sill. Then, slide the window kit plate to fit the width of the window. You can use screws to secure the window kit plate from sliding.

4

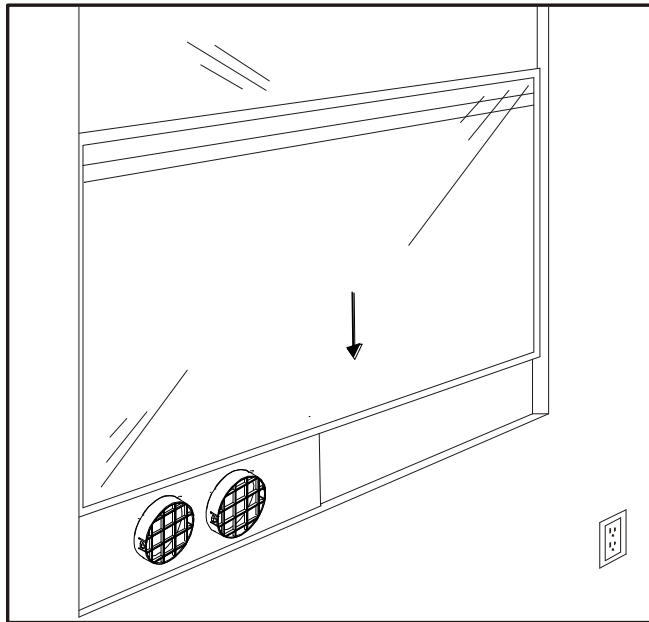

4. Lower the window to secure the window kit in place. You may need to use duct tape to better secure the window kit.

Attaching the duct connectors to the exhaust hose

⑤

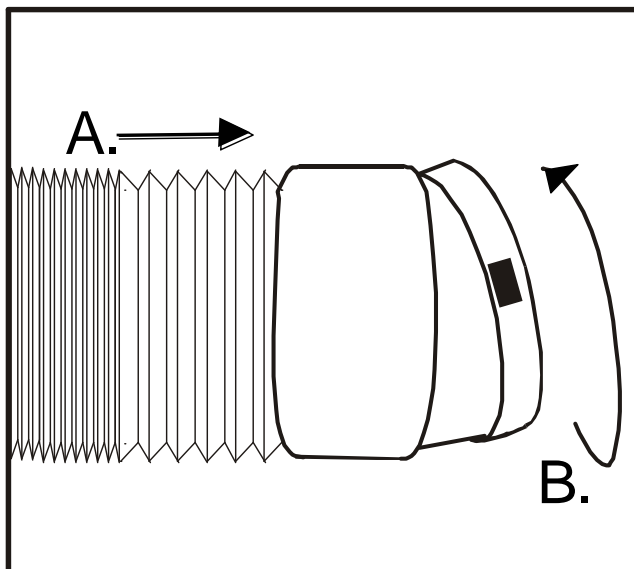

5. Attach the connectors to the hose:
A. Extend the ends of the exhaust hose
B. Thread the duct connector on by turning it clockwise until it stops.

⑥

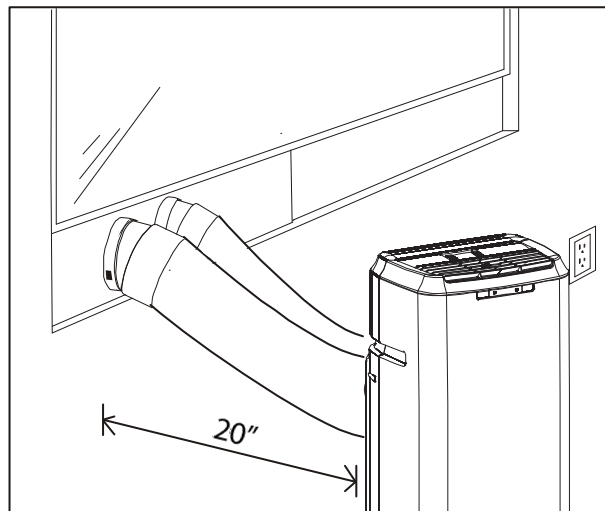

6. Roll the unit towards the window kit. Leave a space that is at least 20 inches to the wall.

Connecting the duct connector to the unit

7

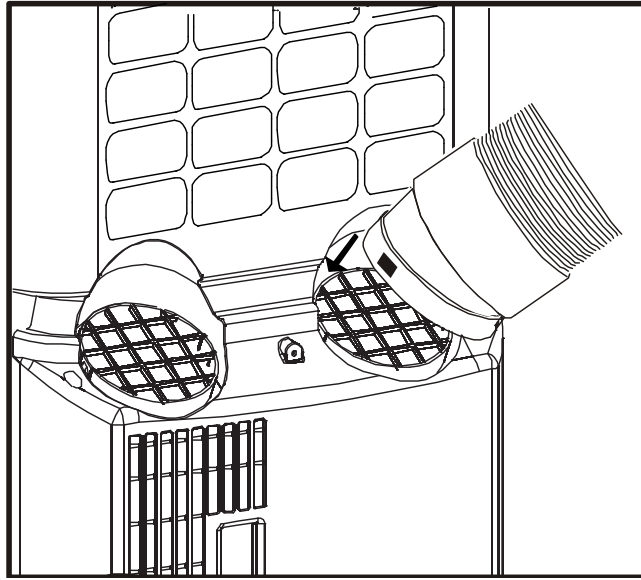

7. Align the slots on the duct connector to the tabs and snap into the back of the unit. In order to use the misting drain feature you will need to attach the duct connector with opening for the water line to the exhaust outlet on the unit.

Connecting the duct connector to the grated adapter

8

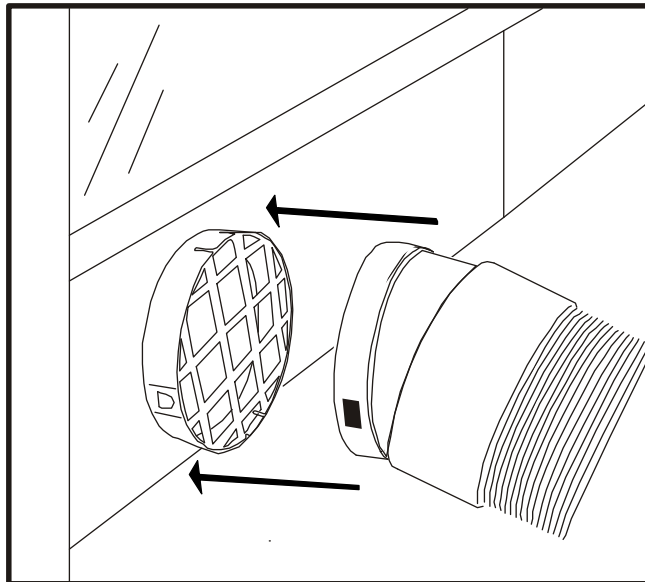

8. Align the slots on the duct connector to the tabs on the grated adapter and snap in place.

After you have installed the exhaust hose and window kit, you can plug in your portable air conditioner and start using it.

Notes about the Exhaust hose

Your portable air conditioner is designed to exhaust condensate water that is collected from the air. This water, in either gaseous or droplet form, will be expelled out the exhaust port of the unit. Please take this into account when deciding how to vent it.

1. The exhaust hose supplied with the portable air conditioner can be extended up to 48 inches; however for maximum efficiency, use the shortest length possible.
2. Try to prevent any kinks or bends in the exhaust hose. Kinks or bends may trap exhaust air which can radiate heat into the room or potentially cause the portable air conditioner to overheat and shut itself off.
3. The exhaust hose supplied with the portable air conditioner has been specifically designed for this air conditioner. Do not lengthen the hose by adding additional hoses or attachments or replace it with any other hose.

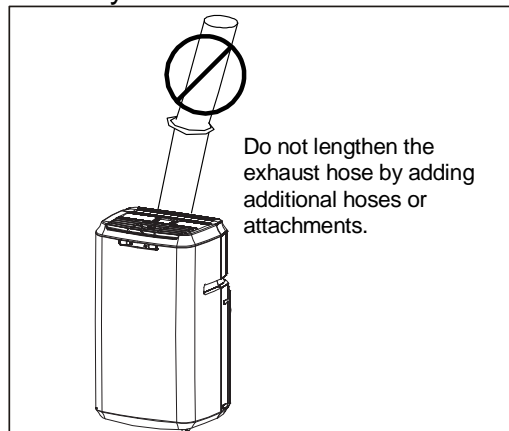

Warning: Longer hoses are not recommended.

Draining the Unit

When the portable air conditioner is in cooling mode, dehumidify mode, or heat mode on certain models, it will remove moisture from the air. The condensed water from the air will be collected in an internal reservoir and will be evaporated and exhausted out of the exhaust hose. However, in very humid conditions, the internal reservoir may fill completely. This causes the air conditioner to turn off to avoid overflowing the internal reservoir. The WATER indicator will light up on the Control Panel.

Direct drainage

1. Remove the rubber drain plug from the drain port.
 2. Connect a drain hose to the drain port.
- The portable air conditioner will now drain through the drain hose.

Drainage Options

Your Avallon portable air conditioner comes with several different options to drain water accumulated during operation. The most common will be the self evaporative mode. The unit will do this automatically. This mode will be sufficient for the most environments. If you are operating the unit in an environment with higher levels of humidity you may choose the other drainage options to help remove the excess water.

Continuous Drain

This unit has the ability for continuous drain. It includes an internal pump to help remove water. The benefit is the unit will push the water to the drain instead of relying on gravity for the water to reach the drain. If there is an obstacle in between the unit and the drain the pump will push the water over that obstacle through the water line. In order to run continuous drain you will need to do the following:

1. Connect the included water line to the unit. You will need to attach the quick connect adapter on the end of the water line to the back of the unit.

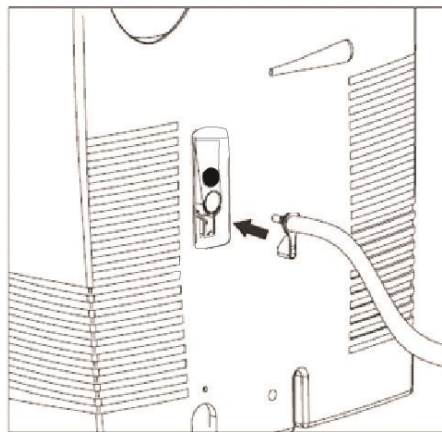

2. Place the other end of the water line (drainage end) into a drain.

The unit will recognize the quick adapter is attached and will automatically engage the water pump. The pump will turn on once the water reservoir becomes full.

Misting Drain

Your unit also includes the unique misting drain option. If a drain is not present this option will allow the unit to remove the excess moisture out the exhaust hose through a mist nozzle. The mist nozzle **MUST** be setup in the exhaust hose and **NOT** the intake hose. In order to run the misting drain option you will need to do the following:

1. Connect the included water line to the unit. You will need to attach the quick connect adapter on the end of the water line to the back of the unit.

NOTE: The water line quick connect includes a trigger to let the unit know a water line is attached. The unit will not pump water out of this drainage hole unless the quick connect water line is attached.

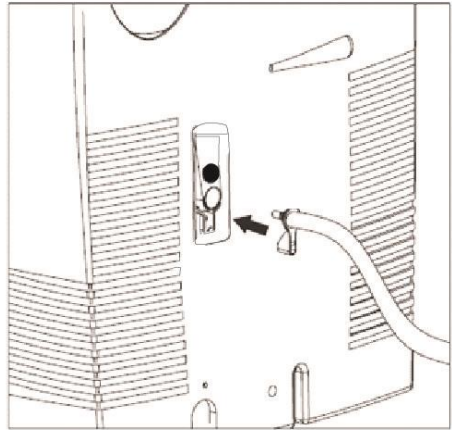

CAUTION: The water line will contain some water if the pump has been in use. If you are going to detach the water line from the unit be sure to keep the end of the water line elevated once it is detached to avoid water spilling. Drain the remaining water in the water line if you are preparing for storage of the unit.

2. Run the remaining water line into the exhaust hose through the opening in the exhaust hose adapter. This adapter **MUST** be installed on the exhaust outlet of the unit. If the adapter is not installed in this position you will need to adjust the adapters. Run the excess water line into the cavity of the exhaust hose.
3. Connect the mist nozzle to the end of the water line. Ensure the water line is attached securely to the mist nozzle.
4. Attach the mist nozzle to the grated adapter. Make sure the mist nozzle is directed to mist outside of the window and not back into the exhaust hose.



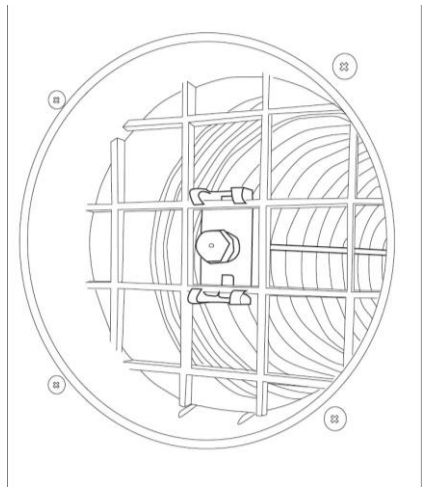





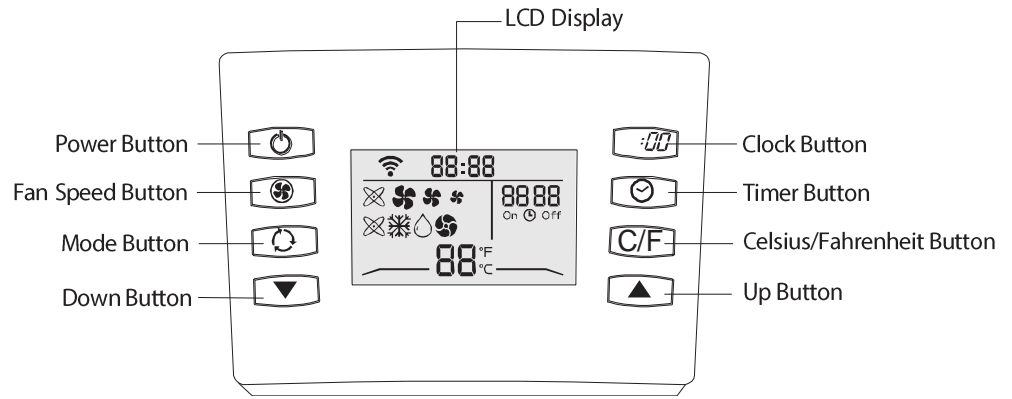







NOTE: It is recommended to attach the misting nozzle in a vertical position on the grated adapter.



The unit will now automatically mist any excess water to the outside. Installing the mist system in the exhaust hose ensures all of the moisture is pushed completely away from the window.

Remote Control Overview



Button	Function
 Power	Powers the unit on or off.
 Fan Speed	Sets the fan speed. The  Automatic,  High,  Medium or  Low indicator will appear depending on the mode you set.
 Mode	Sets the mode. The  Automatic,  Cool,  Dehumidify,  Fan and  heat indicator will appear depending on the mode you set.
 (Down)	Decreases the Temperature, Timer, or Clock settings.
 (Clock)	Used to set the remote control clock
 Timer	Used to enable the timer.
 C/F	Switches the temperature between Celsius/Fahrenheit
 (Up)	Increases the Temperature Timer, or Clock settings.

Installing the batteries

- 1) Remove the cover on the back of the remote control.
- 2) Insert the batteries with the (+) and (-) ends pointing in the correct direction.
- 3) Slide the cover back on.

CAUTION: Use only AAA batteries. Remove the batteries if the remote control will not be used for one month or longer. Do not attempt to recharge batteries not designed to be recharged. All batteries should be replaced at the same time. Do not mix old and new batteries. Do not dispose of batteries in a fire as they may explode.

Remote Control LCD Indicators

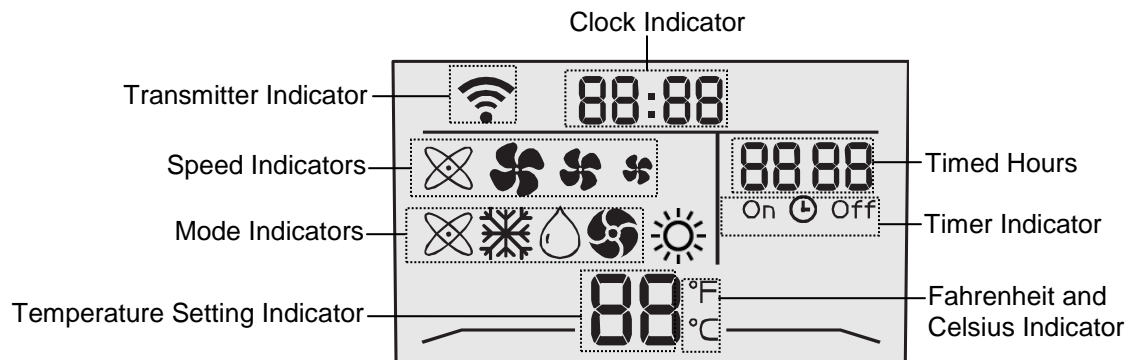

Indicators	
Transmitter	Appears when the Power or Timer button is signaling the unit.
Fan Speed	Shows the set fan speed between Automatic, High, Medium and Low.
Mode	Shows the set mode between Automatic, Cooling, Dehumidify, Fan Only, and Heat.
Temperature Setting	Shows the set temperature.
Fahrenheit and Celsius	Shows if the set temperature is in Fahrenheit or Celsius.
Clock	Shows the Clock's time. The remote control has a 24-Hour clock.
Timed Hours	Shows the number of timed hours when the Timer is enabled.
Timer	Shows if the On Timer or Off Timer is enabled.

Mode Indicator	Function
Automatic	The unit will cool, dehumidify or heat (some models) depending on the ambient temperature. The mode and fan speed changes automatically. The front panel lights will change to reflect the running mode.
Cooling	The unit will cool. The front panel lights will be blue.
Dehumidify	The unit will remove moisture from the air. The front panel lights will be yellow.
Fan Only	The unit will run as a fan and circulate air. The front panel lights will be green.
Heat	<i>Available on certain models.</i> The unit will heat. The front panel lights will be red.

Operating the Remote Control

Power

Use the  Power button to turn the portable air conditioner on and off.







By default when you first use the power button, the unit will begin to operate in cooling mode and the front panel will be illuminated in blue. The unit will remember the last used mode/settings if you shut down and restart.

Auto-Restart: If power to the unit is interrupted, the air conditioner will restart itself in its last used mode/settings once power is restored. The compressor will restart after 3 minutes.

Cooling Mode

Cooling mode cools and dehumidifies the air. If the ambient temperature drops below the temperature you selected, the compressor turns off and the unit functions with the fan only. When the temperature rises above the temperature you selected, the compressor turns on again. The front panel lights will be blue. Whether your desired temperature can actually be reached depends on the ambient conditions. The room temperature remaining above the set temperature is normal.

To operate the unit in cooling mode:



- 1) Make sure the power cord is plugged into a power outlet.
- 2) Press the  Power button on the remote control.
- 3) Press the  Mode button until the  cooling indicator is selected.
- 4) Select the fan speed by using the  Speed button.
- 5) Set the thermostat by using the  Up and  Down buttons. The thermostat is adjustable between 61°F - 89°F in one degree increments. You can switch between Fahrenheit and Celsius by pressing the  button.

NOTE: The exhaust hose must be used in Cooling mode in order to cool a room.

Dehumidifying Mode

During the Dehumidifying mode, the unit will condense water out of the air and exhaust it through the exhaust hose. The ambient temperature in the room will probably drop by a few degrees while using the Dehumidifying mode. The front panel lights will be yellow.

To operate the unit in dehumidifying mode:

- 1) Make sure the power cord is plugged into a power outlet.
- 2) Press the  Power button on the remote control.
- 3) Press the  Mode button until the  dehumidify indicator is selected.





NOTES: If the room temperature is below 77°F, the fan will always run on low speed in this mode. If you do not use the exhaust hose in Dehumidify mode, you must manually drain the water from the unit.

Heat Mode

Only available on certain models

This mode allows the units to run as a heat pump. The unit must be vented for it to expel the cold air out the exhaust.









To operate the unit in heat mode:

- 1) Press the  Mode button until the  heat indicator is selected.
- 2) Set the thermostat by using the  Up and  Down buttons. The thermostat is adjustable between 61°F - 77°F in one degree increments.

Fan Only Mode

Fan Only mode is used to circulate the air in your room. No temperature setting is needed. The front panel lights will be green.

To operate the unit in Fan Only mode:



- 1) Make sure the power cord is plugged into a power outlet.
- 2) Press the  Power button on the remote control.
- 3) Press the  Mode button until the  Fan Only indicator is selected.
- 4) Press the  Speed button to select the fan speed. You can choose between  Automatic,  High,  Medium and  Low.

NOTE: Fan Only mode does not require that the exhaust hose be attached.

Automatic Mode





In Automatic mode, the unit will cool, dehumidify, or heat (certain models) depending on the ambient temperature. As the temperature in the room changes, the mode and fan speed will change automatically. The front panel lights will change depending on the mode.

To operate the unit in Automatic mode:

- 1) Make sure the power cord is plugged into a power outlet.
- 2) Press the  Power button on the remote control.
- 3) Press the  Mode button until the  Automatic indicator is selected.

Fan Speed

The  Fan Speed button is used to change the fan speed while in Cooling and Fan Only modes.

Press the  Fan Speed button to select the fan speed. The  Automatic,  High,  Medium or  Low indicator can be selected.

Note: You will not be able to change the fan speed if the unit is in Automatic or Dehumidify mode.





Clock

The  Clock button is used to set the Clock.

TIP: Use the Chart below:

12-Hour	24-Hour
1:00 PM	13:00
2:00 PM	14:00
3:00 PM	15:00
4:00 PM	16:00
5:00 PM	17:00
6:00 PM	18:00
7:00 PM	19:00
8:00 PM	20:00
9:00 PM	21:00
10:00 PM	22:00
11:00 PM	23:00
12:00 AM	00:00





To set the Clock:

- 1) Press and hold the  Clock button until the Clock indicator starts blinking.
- 2) Set the time by using the  Up and  Down buttons. Holding down the buttons longer than 1 second will change the time in fast mode. The clock is a 24-Hour clock so if it is 6:00 PM you would set the time to be 18:00.
- 3) To save your settings press and hold the  Clock button until the Clock indicator stops blinking.





Timer

The timer can be used to either turn the unit on or off after a number of elapsed hours. The timer is adjustable between 1-24 hours in one hour increments.

How to set the unit to automatically turn on:

- 1) Press the  Timer button while the unit and remote are powered off. The On Timer [On ] indicator will be selected and the timed hour indicator will be blinking.
- 2) Use the  Up and  Down buttons to set the number of hours you want to pass before the unit turns on.
- 3) Press the  Timer button again to set the timer. The timed hour indicator will stop blinking. After the selected time passes, the unit will automatically turn on.

How to set the unit to automatically turn off:

- 1) Press the  Timer button while the unit and remote are powered on. The Off Timer [ Off] indicator will be selected and the timed hour indicator will be blinking.
- 2) Use the  Up and  Down buttons to set the number of hours.
- 3) Press the  Timer button again to set the timer. The timed hour indicator will stop blinking. The unit will automatically turn off after the selected time elapses.

NOTE: To cancel the timer, press  Power button or set it at "00".

Front Panel Lights and Controls

Front Panel Lights

Your portable air conditioner has a front panel that lights up different colors depending on the mode it is running.

Cooling mode will display a blue light.

Dehumidify mode will display a yellow light.

Fan mode will display a green light.

Heating mode (on certain models) will display a red light.

Automatic mode will display the color of the current mode.

If the unit flashes a red light and the unit stops cooling, this indicates that the internal water reservoir is full. Place a pan under the unit, and remove the drain plug to drain the unit.

If the lights flash from left to right and the unit does not work, contact customer service.

Front Panel Controls

 The front panel has an emergency power switch. The power switch can be used when the unit needs to be shut off or turned on without the remote control.



You can turn off the front panel lights by hitting the Lamp Off switch.

Energy Saving Guide

Read and follow the guide below to get the best performance and efficiency from your portable air conditioner:

- Do not cover the air outlet (exhaust) while in use.
- Do not place the unit in front of curtains or drapes- to ensure they do not obstruct the air intake.
- Minimize the length of the exhaust hose.
- Make sure the exhaust hose is as straight as possible and avoid kinks or bends.
- Keep curtains, blinds or drapes closed during the sunniest part of the day.
- Use the timer to operate the unit before it is needed. For example, set the timer to turn on the unit in cooling mode for 3 or more hours to cool the room before you arrive. You may want to operate the unit all day if you live in a warmer climate.
- Minimize the heat sources (direct sunlight, computers, servers, people, etc.) in the room.
- Close all windows and doors.
- Use the unit in a contained room. For example, a room with four walls and a ceiling, instead of a partitioned studio, or warehouse.
- Make sure the unit is on a level surface.
- Minimize the amount of humidity in the room. For example, run the unit as a dehumidifier.
- To prolong the compressor's life, please wait at least 3 minutes before turning the unit back on after shutting it off.
- Inspect and keep the pre-filters clean by cleaning regularly.
- Perform routine maintenance.

Maintenance

Clean the air conditioner and filters regularly to maximize performance and efficiency, and prolong the unit's life. Be sure to always unplug the air conditioner from the power outlet before cleaning.

Cleaning the unit

Use a soft dry cloth to wipe the body clean. If necessary, use lukewarm water to dampen a cloth to clean the unit. Use a soft bristle brush to clean between the vents. Carefully use a vacuum cleaner to clean the condenser coils

Never use abrasive chemicals, volatile substances, gasoline, detergents, chemically treated cloths, or other cleaning solvents that may damage the cabinet exterior.

Never spray water directly on the unit.

Cleaning the pre-filter

To clean the pre-filter, follow the steps below:

- 1) Power off the unit and remove the pre-filter.
- 2) Use a vacuum cleaner or tap the filter lightly to remove loose dust and dirt, then rinse thoroughly under lukewarm running water (below 104°F). You may use a mild soap and water solution if needed. Allow the pre-filter to air dry in a cool and shaded place. Dry thoroughly before reinstalling.

Clean the pre-filter periodically. If the unit is used in a dusty environment you may need to clean it on a weekly basis.

Warning: Never operate the unit without the filter.

Preparation for Storage

If you are not going to be using the unit for an extended period of time, follow the instructions below before storing your unit:

- 1) Drain all the water from the unit's reservoir. Operate the unit in fan mode for a few hours to thoroughly dry any moisture left on the coils inside the unit.
- 2) Power off the unit, and clean or change the filter.
- 3) Unplug and carefully wind the power cord.
- 4) Remove the exhaust hose and duct connectors and keep them in a safe place.

Troubleshooting

Follow the troubleshooting guide below to resolve common issues.

Issue	Possible Cause	Solution
My air conditioner is not functioning at all	Unit is not receiving power	Make sure the unit is plugged in
	LCDI power cord is tripped	Press the Reset button on the LCDI cord
	Insufficient power	Move the unit to another outlet. Check your circuit breaker. (Refer to the rating label on the back of the unit to determine the Amperage draw)
	Water reservoir is full	Drain the unit and restart
	Control panel is disconnected	If no indicator lights turn on, contact customer service
My remote control does not work and the indicator symbols on the remote do not appear	Batteries not installed	Install new batteries
	Bad batteries	Replace the batteries
	Batteries installed incorrectly	Reinstall the batteries correctly
	A defective remote control	Contact customer service
My air conditioner is making a loud noise	The unit is not level.	Make sure the unit is on a level surface
	A foreign object has jammed the fan.	Remove the object from the fan
	The floor below the unit is uneven	Move the unit to a level surface
My air conditioner is making a continuous metallic knocking or pinging sound	Unit may have been shipped on its side	Shut off the unit. Let the unit sit on a level surface for at least 24 hours and restart.
	Damaged compressor	Contact customer service
My air conditioner is leaking	Drain plug is removed	Attach the drain plug
	Cracked base pan	Contact customer service
My air conditioner runs for a little while and then it trips the power cord or the circuit breaker	The air conditioner may be plugged into an outlet that can not supply the correct amount of current	Contact an electrician if the unit works in a different room or circuit
The front control panel lights blink red	Your water reservoir is full.	Drain your unit.

Troubleshooting continued

Issue	Possible Cause	Solution
My air conditioner is not cooling at all	Unit is not operating in cooling mode	Set the unit to be in cooling mode, and lower the set temperature (pg. 12)
	The compressor is not on	The compressor may take up to 3 minutes to turn on, or longer if it is too warm
	The ambient temperature is too high	Lower the room temperature to be below 90°F degrees
	The filter may be dusty or blocked	Clean the filter. (pg. 16)
	Blocked exhaust port	Remove any obstructions in the exhaust hose and port
My air conditioner blows cold air, but does not lower the room temperature	The unit is not vented	The unit must be vented. (pg. 4)
	The area of the room is too large	Minimize the size of the area to be cooled, i.e. adding a drop ceiling. Use more than one unit to cool the area, or use a larger unit
	Open windows and doors	Close any open doors and windows
	Too many heat sources	Remove or shut off additional heat sources such as radio equipment, servers, etc.
	The room/garage may be inadequately insulated	Properly insulate the room to be cooled, i.e. using fiberglass
	The ambient temperature is too high	The unit may not work if the room temperature is above 90°F
	Direct sunlight is heating the room	Close curtains or pull down blinds, and minimize the direct sunlight into the room
	The filter may be dusty or blocked	Clean the filter and replace it if needed
	Dirty condenser coils	Carefully vacuum the coils clean
	Obstructed air intake or exhaust ports	Remove anything blocking the ports

NOTE: If the ambient temperature is above 90°F the unit may not blow cold air.

TIP: Run the unit before it is needed. For example, run the unit in the morning before the area gets hot, and continue to run the unit all day long in order to maintain a low temperature.

Specifications

Description of product	Portable Air Conditioner
Model	APAC140C
Voltage/Frequency	115V/60Hz
Input Power	1250W
Current	10.8A
Color	Grey and Silver
Coolant	R410A
Timer	24 Hour
Dimensions H x W x D	33.7" x 19.5" x 15.7"
Weight	73 lbs

Avallon Product Warranty

Warranty Period	Avallon will be responsible for:	Consumer will be responsible for:
1st year	All costs for repairing or replacing parts and/or unit which proves to be defective. All transportation costs in the first 90 days.	All transportation costs after 90 days.
Limited 2nd-5th year (compressor only)	Repairing or replacing any compressor which proves to be defective. (Labor not included)	Labor and all transportation costs.

This product is warranted by Avallon and is subject to any conditions set forth as follows:

WHAT IS COVERED:

One Year Parts and Labor: For one year from the date of original retail purchase, Avallon will repair or replace any part free of charge including labor that fails due to a defect in materials or workmanship. Avallon will be responsible for all transportation costs for the first 90 days from original purchase date, after 90 days the consumer will be responsible. Labor will be performed free of charge at an authorized Avallon repair facility and will supply new, rebuilt, or refurbished parts free of charge. Avallon may request a defective part be returned in exchange for the replacement part. After the 12 month period, Avallon will no longer be responsible for labor charges incurred or replacement parts. All defective products and parts covered by this warranty will be repaired or replaced on a mail-in basis to an Avallon authorized repair facility.

Five Year Limited Warranty (Compressor- Labor Not Included): In the second through fifth year from the date of original retail purchase, Avallon will replace the compressor free of charge. The consumer will be responsible for all transportation and labor costs. Avallon will supply a new, rebuilt, or refurbished compressor and may request for the defective compressor to be returned in exchange. This limited 5-Year warranty is for the compressor only and does not include labor.

All warranties apply to the original purchaser only, and only covers defects in workmanship experienced during operation of the product under normal service, maintenance, and usage conditions. This warranty applies to the purchase and use of this product in residential settings within the United States of America. All products and parts replaced by Avallon under warranty service become the property of Avallon. All defective products and parts covered by this warranty will be repaired or replaced on a mail-in basis to an Avallon authorized repair facility.

Exceptions: Commercial or Rental Use Warranty: 90 days labor and parts from date of original purchase. No other warranty applies.

OBTAINING WARRANTY SERVICE: If you believe your product is defective, contact Avallon Customer Support for troubleshooting assistance and warranty service at www.avallon.com or call 1-866-471-7427. Before contacting Customer Support you are required to have your model number, serial number and proof of purchase available upon request. Once an Avallon authorized representative has confirmed that your product is defective and eligible for warranty service, the product must be returned to an Avallon authorized repair facility. Avallon is not responsible for damage resulting from shipper mishandling or improper packaging. Do not return a defective product to the place of purchase. Products received without a return authorization number will be refused.

WHAT IS NOT COVERED- The following limitations apply to the coverage of this warranty. This warranty does not cover:

Labor charges for installation, setup or training to use the product. Shipping damage, and any damage caused by improper packaging for shipment to an authorized service center, and any damaged caused by improper voltage or any other misuse, including abnormal service, handling, or usage. Cosmetic damage such as scratches and dents. Normal wear and tear on parts or replacement of parts designed to be replaced, e.g. filters, cartridges, batteries. Service trips to deliver, pick-up, or repair, install the product, or to instruct in proper usage of the product. Damages or operating problems resulting from misuse, abuse, operation outside environmental specifications, uses contrary to instructions provided in the owner's manual, accidents, acts of God, vermin, fire, flood, improper installation, unauthorized service, maintenance negligence, unauthorized installation or modification, or commercial use. Labor, service transportation, and shipping charges for the removal and replacement of defective parts, beyond the initial 12 month period. Products that have been modified to perform outside of specifications without the prior written permission of Avallon. Products lost in shipment, or theft. Products sold AS IS or from an unauthorized reseller. Products that have had their serial numbers removed, defaced, or with serial numbers that have been invalidated. Damage from other than normal household use. Replacement or repair of household fuses, circuit breakers, wiring or plumbing. Damage to personal property from use of product. Damage from service other than from an authorized Avallon-repair facility. Hoses, knobs, lint trays and all attachments, accessories and disposable parts. Any service charges not specifically identified as normal such as normal service area or hours. Any special or consequential damages arising out of the use of the product.

THIS WARRANTY IS IN LIEU OF ANY OTHER WARRANTY, EXPRESS OR IMPLIED, INCLUDING WITHOUT LIMITATION, ANY WARRANTY OF MERCHANTABILITY OR FITNESS FOR A PARTICULAR PURPOSE. TO THE EXTENT ANY IMPLIED WARRANTY IS REQUIRED BY LAW, IT IS LIMITED IN DURATION TO THE EXPRESS WARRANTY PERIOD ABOVE. NEITHER THE MANUFACTURER NOR ITS DISTRIBUTORS SHALL BE LIABLE FOR ANY INCIDENTAL, CONSEQUENTIAL, INDIRECT, SPECIAL, OR PUNITIVE DAMAGES OF ANY NATURE, INCLUDING WITHOUT LIMITATION, LOST REVENUES OR PROFITS, OR ANY OTHER DAMAGE WHETHER BASED IN CONTRACT, TORT, OR OTHERWISE. SOME STATES DO NOT ALLOW THE EXCLUSION OF INCIDENTAL OR CONSEQUENTIAL DAMAGES, SO THE ABOVE EXCLUSION MAY NOT APPLY TO YOU. THIS WARRANTY GIVES YOU SPECIFIC LEGAL RIGHTS. YOU MAY HAVE OTHER RIGHTS THAT VARY FROM STATE TO STATE.



AVALLON GLOBAL, LLC

3736 Bee Cave Rd.
STE 1 #188
West Lake Hills, TX 78746

Toll Free: 1-866-471-7427
Web: <http://www.avallon.com>
E-mail: service@avallon.com

Product contents and specifications may change without notice.

Copyright © 2015 Avallon Global, LLC