

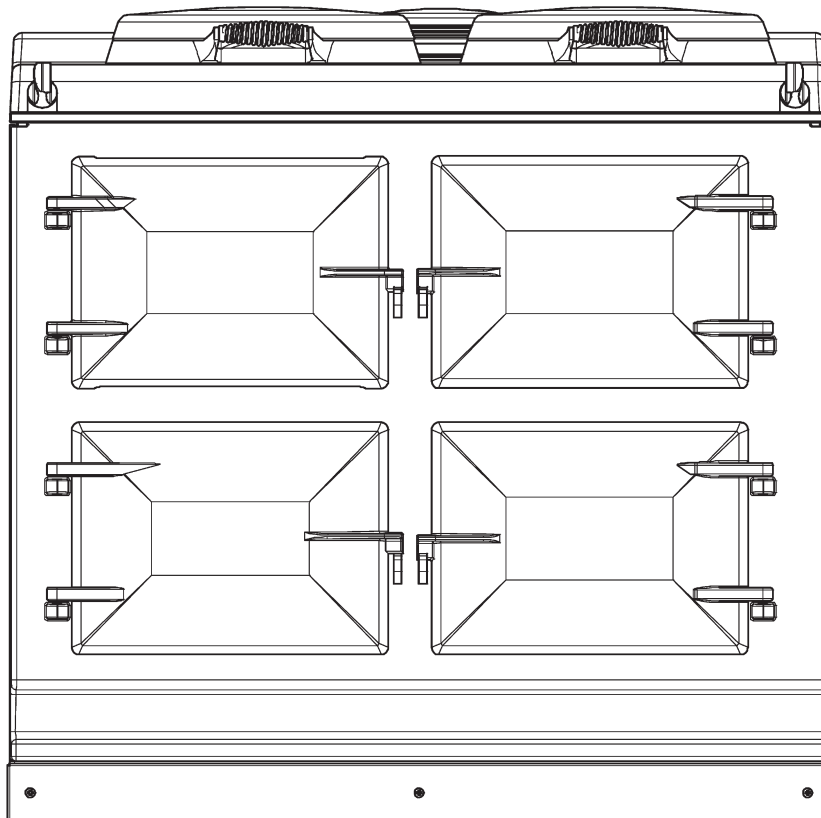

# AGA TOTAL CONTROL

## Model No. - TC3 & TC5



### *Users Instruction*

REMEMBER: when replacing a part on this appliance, use only replacement parts that you can be assured conform to the safety and performance specification that we require. Do not use reconditioned or copy parts that have not been clearly authorized by AGA.

**PLEASE READ THESE INSTRUCTIONS BEFORE USING THIS APPLIANCE**

**IMPORTANT** : SAVE INSTRUCTIONS FOR THE LOCAL INSPECTORS USE  
CUSTOMER: KEEP THESE INSTRUCTIONS FOR FUTURE REFERENCE



For use in USA/Canada

11/12 EOPI 516292

## CONTENTS

3	Warnings
4	Introduction
4	A Brief Description - AGA TC3
5	A Brief Description - AGA TC5
8	How to use your AGA Total Control
9	AGA Total Control Operating Modes
10	General Advice
11	Handset
11	Handset Advice
12	Communication/Handshake
13	The Date/Time Setting Screen
14	Auto Events/Program Screen
15	Information (Home) Screen
16	Power Outages
16	Automatic Update of Time
16	Changing Batteries
17	Using the Zones of the AGA Total Control
17	The Hotplates
17	The Boiling Plate
18	The Simmering Plate
18	The Top Plate
19	The Ovens
20	The Roasting Oven
21	The Baking Oven
22	The Slow Cook Oven
23	AGA TC5 (Hotcupboard Option)
24	Cleaning and Caring
25	Fitting of Oven Shelves
25	Removal of Oven Shelves
25	Fitting and Removal of Oven Doors
26	Service
26	Warranty
28	Error Codes
28	Serial Number
28	Health and Safety
29	AGA Basic Recipes

# WARNINGS

**INCORRECT USE OF THIS RANGE CAN INCREASE THE RISK OF FIRE, ELECTRIC SHOCKS OR INJURY TO PERSONS. PLEASE READ THE FOLLOWING PRECAUTIONS TO REDUCE THESE RISKS.**

**Be sure your appliance is properly installed and grounded by a qualified technician.**

**Never use your appliance for warming or heating the room.**

## USER SERVICING

Do not repair or replace any part of the appliance unless specifically recommended in this manual. All other servicing should be referred to a qualified technician.

## VENTILATING HOODS (WHERE APPLICABLE)

- Clean ventilating hoods frequently, grease should not be allowed to accumulate on the hood or filter.
- When flaming foods under the hood, turn the fan on.

## BASIC RANGE SAFETY PRECAUTIONS

- Materials such as gasoline, vapors and liquids which can catch fire and explode must not be stored in, above or near a range.
- Make sure that nothing is allowed to prevent the flow of air to the electric control compartment.
- Ensure space storage cabinets are capable of supporting the heavy weight of cooking utensils of the range.
- The maximum depth of any cabinets installed above the top of the range must not exceed 330mm (13in)

## CHILD SAFETY

Children are more sensitive to heat than adults, therefore they **MUST** be made aware of the following safety precautions.

1. Do not leave children alone or unsupervised near the range and discourage them from this area.
2. Children should not be allowed to mount any part of the range.
3. Children **MUST** be taught that the range and its utensils can be hot.
4. Children should be taught that the range is not a toy. They should be forbidden to play with the range electric controls behind the outer burner door or any other range parts.
5. Let the heavy, hot utensils cool in a safe place but out of reach of small children.

**CAUTION:** AVOID STORING ITEMS OF INTEREST TO CHILDREN IN ANY CABINETS INSTALLED ABOVE THE RANGE TO PREVENT IT BEING USED TO OBTAIN ACCESS AND POSSIBLE SERIOUS INJURY.

**DO NOT TOUCH SURFACE UNITS OR AREAS NEAR UNITS - SURFACES MAY BE HOT.** Areas near surface units may become hot enough to cause burns, do not touch, or let clothing or other flammable materials contact surface units or areas near units.

## GREASE

**WARNING:** HOT GREASE IS FLAMMABLE. Wipe off any grease deposits on the range top and front. Do not leave containers of cooking fat around the range. In the event of a grease fire, do not remove the pan, cover the pan to extinguish the flame.

**WARNING:** DO NOT USE WATER ON GREASE FIRES - Smother the fire or flame or use dry chemical or foam-type extinguisher.

## RANGE COOKING SAFETY PRECAUTIONS AND HINTS

Never reach directly into a hot oven to add or remove cooking utensils. Instead pull the grid shelf out of its maximum projection and load or remove utensils. Oven gloves will be necessary on utensils removal.

**WEAR PROPER APPAREL** - Loose fitting or hanging garments should never be worn whilst using the appliance.

**STORAGE IN OR ON AN APPLIANCE** - Flammable materials should not be stored in an oven or near surface units.

**NEVER LEAVE BOILING PANS UNATTENDED** - Boilover causes smoking and greasy spillovers may ignite.

**GLAZED COOKING UTENSILS** - Only certain types of glass, glass/ceramic, ceramic, earthenware, or other glazed utensils are suitable for range-top service without breaking due to the sudden change in temperature.

**UTENSIL HANDLES SHOULD BE TURNED INWARD AND NOT EXTEND OVER ADJACENT SURFACE UNITS** - To reduce risk of burns, ignition of flammable materials, and spillage due to unintentional contact with the utensil, the handle of a utensil should be positioned so that it is turned inward, and does not extend over adjacent surface units.

**USE CARE WHEN OPENING OVEN DOOR** - Let hot air or steam escape before removing or replacing food.

**DO NOT HEAT UNOPENED FOOD CONTAINERS** - Build-up of pressure may cause container to burst and result in injury.

**KEEP OVEN VENTS DUCTS UNOBSTRUCTED.**

**USE ONLY DRY POTHOLDERS** - Moist or damp potholders on hot surfaces may result in burns from steam. Do not let the potholder touch hot heating elements. Do not use a towel or other bulky cloth.

# INTRODUCTION

Your new AGA Total Control gives you everything you love about the classic AGA heat storage cooker, but with the added convenience of touchscreen technology and the ability to turn each cooking area on and off, as and when you want it.

Made in the heart of Shropshire, your AGA cooker, like the generations of cookers before it, has been manufactured from cast iron at the Coalbrookdale Foundry. Traditional iron-making skills combined with industrial strength elements enable the ovens and hotplates to heat up rapidly, so you can have them all on, or just one on, depending on the time of day or the size of your army.

The cooking excellence of the AGA cooker has been famous since its inception in the 1920's, and is renowned due to the indirect radiant heat that its cast iron emits rather than just air temperature. And, if you haven't found out already, you'll soon discover that food that is cooked this way retains its natural flavour and succulence, and simply just tastes just better.

So grab a cup of tea, have a read, and prepare to dig into some of the tastiest dishes you're ever likely to make.

## A BRIEF DESCRIPTION - AGA TC3



### Hotplates

The two hotplates are at different heats; the boiling plate being the hottest of the two and the simmering plate at a lower heat. Each hotplate is individually temperature controlled.

#### Boiling Plate

The boiling plate is used for making toast, boiling a kettle, stir-frying and cooking at a high heat.

#### Simmering Plate

The simmering plate is for cooking slower, such as sauces, simmering pans and can also be used direct on for toasted sandwiches, drop scones, non-fat fried eggs and quesadillas.

#### Roasting Oven

The hottest oven for high temperature cooking; pastries, breads, roasting of meat, vegetables and poultry, grilling at the top of the oven and frying on the floor.

#### Baking Oven

A moderate oven for cooking cakes and biscuits, baking fish, lasagne or shepherds pie, plus roasting meat and poultry at a medium heat. Cooking sweets and savoury together is no problem as the flavours do not mix.

#### Slow Cook Oven

Long, slow cooking in the slow cook oven develops flavours and makes the toughest meat tender. Its large capacity means several pans can be stacked here; soup, casserole, steamed rice, steamed carrots and poached pears all cooking simultaneously, without any danger of burning.

## A BRIEF DESCRIPTION - AGA TC5



### Hotplates

The two hotplates are at different heats: the boiling plate being the hottest of the two and the simmering plate at a lower heat. Each hotplate is individually temperature controlled.

#### Boiling Plate

The boiling plate is used for making toast, boiling a kettle, stir-frying and cooking at a high heat.

#### Boiling Plate

The simmering plate is for cooking slower, such as sauces, simmering pans and can also be used direct on for toasted sandwiches, drop scones, no-fat fried eggs and quesadillas.

#### Warming Plate (Hotcupboard)

The warming plate is the ideal resting plate for cooked food.

#### Slow Cooking Oven (Hotcupboard)

Ideal for a broad range of long slow cooking applications such as leg of lamb, pulled pork, belly pork and celebration cake.

**NOTE:** Meat and vegetable dishes should be started on the boiling plate or in the roasting oven.

### Warming Oven (Hotcupboard)

Used for warming plates and serving dishes. Can also be used for resting joints before carving.

#### Roasting Oven

The hottest oven for high temperature cooking; pastries, breads, roasting of meat, vegetables and poultry, grilling at the top of the oven and frying on the floor. The oven, as the others is vented mechanically through an external wall, so the majority of cooking smells are taken to the outside.

#### Baking Oven

A moderate oven for cooking cakes and biscuits, baking fish, lasagne or shepherds pie, plus roasting meat and poultry at a medium heat. Cooking sweet and savoury together is no problem as the flavours do not mix.

#### Simmering Oven

Long, slow cooking in the simmering oven develops flavours and makes the toughest meat tender. Its large capacity means several pans can be stacked here; soup, casserole, steamed rice, steamed carrots and poached pears all cooking simultaneously, without any danger of burning.



### Control Panel

This is situated behind the top left hand door. The control panel contains touch sensitive buttons with a green or orange light (LED indicator) to indicate which zone is activated. An audible beep will confirm selection.



### Handset

Your AGA Total Control cooker also comes with a Handset which can be used to program the ovens. It displays the time, date and program events. The hotplates work on Manual only.

## EQUIPMENT SUPPLIED WITH YOUR AGA TOTAL CONTROL



### Large Size Roasting Pan with Grill Rack

This is designed to slide onto the oven runners without the need for it to sit on an oven grid shelf. The roasting pan can be used with the grill rack, in its high position, for grilling at the top of the roasting oven. It can be used for roasting meat, or poultry with or without the grill rack. Large quantities of roast potatoes can be cooked in this tin. The roasting pan can also be employed for making large sponges or cakes. The grill rack is useful on its own as a cake cooling rack. Can be used in any oven but not recommended for hotplate use.



### Half Size Roasting Pan and Grill Rack

This pan can be slid onto the oven runners width-ways or can sit on an oven grid shelf. The half size roasting pan can be used with the grill rack, in its high position, for grilling at the top of the roasting oven. It can be used for roasting smaller joints of meat, or poultry with or without the grill rack. Roast potatoes can be cooked in this pan. The roasting pan can also be employed for making sponges or cakes. The grill rack is useful on its own as a cake cooling rack. Can be used in any oven but not recommended for hotplate use.

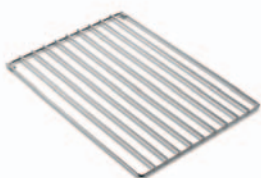

### 1 Floor Grid

This grid is used on the floor of the ovens, in particular the roasting and simmering ovens to protect food needing over 30 minutes cooking from the intensity of the heat from the base element.

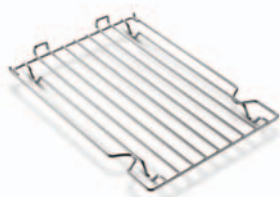

### 3 Oven Grid Shelves

These are for inserting in each oven to provide a surface for dishes and tins which do not fit direct onto the oven runners. They can be used in any oven, as required. See page 25 on how to locate the oven shelves correctly.

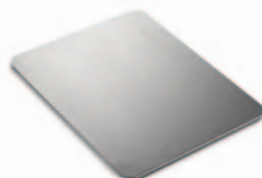

### 1 Cold Plain Shelf

Known as the cold plain shelf because it is recommended this shelf should be kept out of the ovens when not in use. It has two uses one as large baking sheet for scones, biscuits, pastry items and meringues and the other use as a heat deflector to cut off the top heat if food is overbrowning before it is cooked through.

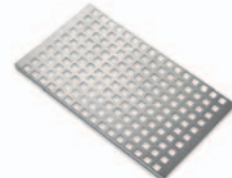

### Roasting Oven Perforated Baffle

A roasting oven perforated baffle is positioned in the top of the roasting oven, in order to optimise cooking performance. For best results, please ensure it is in place at all times, while the oven is in operation, including when grilling. The Installation Engineer will fit this in place. This can also be removed for cleaning.





---

### Toaster

This is for toasting bread on the boiling plate. AGA toast is renowned for its excellence, crisp on the outside and soft in the center. Take thick slices of bread and place in the AGA toaster - if the bread is very moist or very fresh, heat the toaster beforehand to prevent sticking - lift the boiling plate insulated cover and place the toaster direct onto the plate with the handle at an angle from the handle of the cover.

Close the cover and wait for the bread to toast one side - this will take 1-2 minutes dependent upon the variety of bread - open the cover and turn the toaster over and repeat the process to toast the other side. The toaster can also be used for heating pita bread, toasting teacakes and as a cake cooling rack.



---

### Wire Brush

This is for cleaning the raw cast iron surfaces, keeping them clear of crumbs and burnt on debris - which would otherwise affect the boiling performance of pans and the kettle. Use on the hotplates and the ovens. Take care not to touch the enamel surfaces as the wire brush will scratch the finish.



---

### AGA Utensils and Accessories

To get the very best performance from your cooker we recommend AGA saucepans with the thick tri-core bases and stacking lids so that the maximum use of oven space is made and an AGA kettle for boiling water. AGA Accessories can be viewed at your AGA retailer or on [agamarvel.com](http://agamarvel.com).



---

### Getting to know your AGA

If you have not already seen a demonstration, ask your AGA Specialist for details. A demonstration will show you how to get the best from your new AGA and will give you hints and tips. You will also see a selection of AGA utensils and accessories being used.

# HOW TO USE YOUR AGA TOTAL CONTROL

## Getting started







When switching on the AGA cooker for the first few times, there are two things you may notice, neither of which should cause concern.

The AGA cooker will emit an odor for a short while, this is simply due to the protective oil we put on the hotplates and ovens burning off. Due to the newness in the first couple of hours, it is advisable to open the kitchen window while this takes place.

Condensation may occur on the top and front plate whilst the AGA cooker is heating up, caused by the internal insulation drying out. The condensation should be wiped away as soon as possible to prevent staining the enamel.

Your AGA Total Control has the external appearance of a classic AGA heat storage enamelled cast iron cooker. However its flexibility is almost unbounded because in place of a single heat source each cooking zone has its own electrically heated cast iron element(s). The separation of cooking zones, allows a choice of control. You are able to select only those zones that you want, or need, to use.

The control panel is situated behind the top left hand door. It contains touch sensitive buttons with a green or orange light (LED indicator) to indicate which zone is activated. An audible beep will confirm selection. There are eight buttons:

-  Standby/ON
-  Mode  
Manual ▶ Slumber ▶ AUTO ▶ AUTO/Slumber selection
-  Boil (Boiling plate)  
ON/OFF
-  Simmer (Simmering plate)  
ON/OFF
-  Roast (Roasting oven)  
ON/OFF or selected for AUTO or AUTO/Slumber
-  Bake (Baking oven)  
ON/OFF or selected for AUTO or AUTO/Slumber
-  Simmer (Slow cook oven)  
ON/OFF or selected for AUTO or AUTO/Slumber

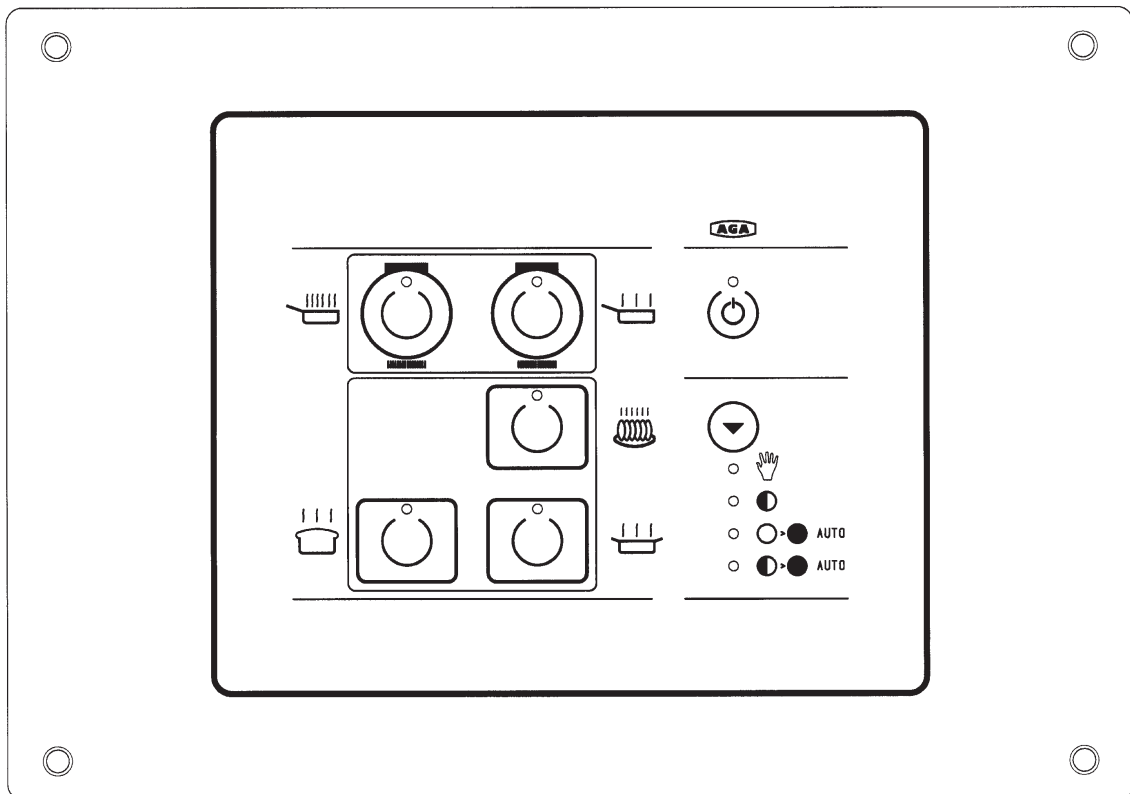



# AGA TOTAL CONTROL OPERATING MODES

The appliance has 4 operating modes:

## Mode Selection Button

Manual ► Slumber ► AUTO ► AUTO/Slumber  
selection can only be made when standby button is on.

## Standby Button

This button must be on i.e. green to operate any part of your AGA Total Control, or for any Timed events.

## Manual *simply select what you require*

Each heat zone (an oven or a hotplate) can be turned on or off as required, just press the appropriate button, a green light will show when a specific zone is in operation.

The green indicator light of the selected zone (s) will flash slowly indicating that the zone (s) is warming up. Once the selected zone (s) is at temperature and ready to use the green light will stop flashing. It is normal for the green light to flash slowly during cooking, this indicates that the heat zone is requesting power. While in Manual mode any zone selected will remain on indefinitely until switched off.

## Slumber *(ovens only)*

In this mode, all three ovens are active, (the roasting and baking oven are pre-set to approximately 248°F, the slow cook oven is pre-set to approximately 212°F).

When selected, the orange indicator light of the ovens will flash slowly, indicating that the ovens are warming up, when 'Slumber' temperature is reached the orange light will stop flashing.

No individual oven can be 'OFF'. However any oven can be switched from 'Slumber' to full heat by one press of its button. When pressed once, the selected oven goes to 'full heat', there will be a flashing green light, when at temperature the light will stop flashing.

Pressing an individual oven button once more returns that oven back to 'Slumber'.

 **AUTO** *(ovens only) - brings selected ovens up to full heat from OFF*

The ovens can be selected to operate once or twice each day.

Each operation is termed an 'event', the start and finish time is chosen by you unless you use the pre-set time.

The handset will have been set up by the installer. It should have the correct time of day set. Unless you have set your own Auto program, it will include the pre-set time (1 Event 7am - 7pm).

See Page 14 to set your own Auto program preferences.

Select 'AUTO' mode.

Select oven (s) for automatic operation, by pressing the appropriate button (s).

The oven (s) selected is indicated by an orange light (unless you have selected 'AUTO' during an 'event' period). During an 'event' period the light will be green.

The oven light will flash green while the oven is heating. When at temperature the green light will stop flashing.

### PLEASE NOTE:

- Don't forget to include time for warm-up.
- Don't forget if you have set the AUTO program and have selected the AUTO mode, an oven or ovens must be selected .
- The hotplates can only be operated manually.
- The last 'AUTO' oven selection is remembered and re-called when 'AUTO' is next selected.
- **DO NOT OPERATE WITH THE APPLIANCE DOORS OPEN**

 **AUTO/Slumber** (ovens only) - brings selected ovens up to full heat from Slumber.

The ovens can be selected to operate once or twice each day.

Each operation is termed an 'event', the start and finish time is chosen by you unless you use the pre-set time.

See Page 14 to set your own Auto program preferences.

Select 'AUTO/Slumber'.

Select oven (s) for automatic operation, by pressing the appropriate buttons.

The oven (s) selected is indicated by an orange light (unless you have selected 'AUTO/Slumber' during an 'event' period). During an 'event' period the light will be green.

The oven (s) selected is indicated by an orange light, the oven light will flash orange until 'Slumber' temperature has been reached.

The oven light will flash green while the oven is heating from 'Slumber' to full temperature during its Auto/Slumber event period. When at full temperature the green light will stop flashing.

## PLEASE NOTE:-

- Don't forget to include time for warm-up.
- Don't forget if you have set the AUTO/Slumber program and have selected the AUTO/Slumber mode, an oven or ovens must be selected .
- The hotplates can only be operated manually.
- All the selected ovens will remain at 'Slumber' between 'events'.
- The last 'AUTO/Slumber' oven selection is remembered and re-called when 'AUTO' is next selected.
- **DO NOT OPERATE WITH THE APPLIANCE DOORS OPEN**

## AUTO and AUTO/Slumber

Changing between any of the four operating modes, will cause the hotplates to switch OFF if in use - this is a built-in safety factor. They can be switched back on after the mode change if required.

## GENERAL ADVICE

Food **SHOULD NOT** be placed into any oven until it is up to normal operating heat i.e. the green light of the selected oven is solid and not flashing.

The oven doors should not be left open for long periods of time during cooking and heating up.

Store the cold plain shelf outside the cooker. Use it cold in the roasting oven to deflect heat from the top of the oven, creating a more moderate oven temperature underneath. It can also be used as a baking sheet.

When an oven or hotplate is at temperature, and is then loaded with food or cold pans/trays, the zone light may flash as the oven and/or hotplate calls for extra heat.

### Warm up times

When a zone is heating up it will be indicated by a flashing green or orange light on the control panel. When a zone has reached temperature a solid green or orange light will indicate it has warmed up, AGA recommends that for full heat to saturate the castings it is best to leave them for one hour for the optimum cooking results.

### Boiling Plate

The boiling plate takes approximately 11 minutes to reach temperature from cold.

### Simmering Plate

The simmering plate takes approximately 8 minutes to reach temperature from cold.

### Roasting Oven

The roasting oven takes approximately 35 minutes to reach temperature from cold, and approximately 15 minutes to reach temperature from 'Slumber'.

### Baking Oven

The baking oven takes approximately 22 minutes to reach temperature from cold, and approximately 15 minutes to reach temperature from 'Slumber'.

### Slow Cook Oven

The slow cook oven takes approximately 45 minutes to reach temperature from cold.

**PLEASE NOTE:** For optimum cooking performance, after the temperature has been reached, we recommend leaving for another 30 minutes for the castings to become heat saturated, particularly relevant if you are cooking a large meal or baking.

**PLEASE NOTE:** The times are based on each zone being operated individually. If a large combination of zones are turned on simultaneously, it may slow down the individual warm up times. If all zones are turned on at the same time it will take approximately one hour for the whole appliance to reach operating temperature.

These times are based on the cooker having a single phase supply of 32 amps @ 230 V. For other power supply configurations, these times may change.

# HANDSET - A HAND HELD CONTROL

The handset displays the time, date and events. Programming is via eight push buttons. The information is displayed via a back-lit LCD screen.

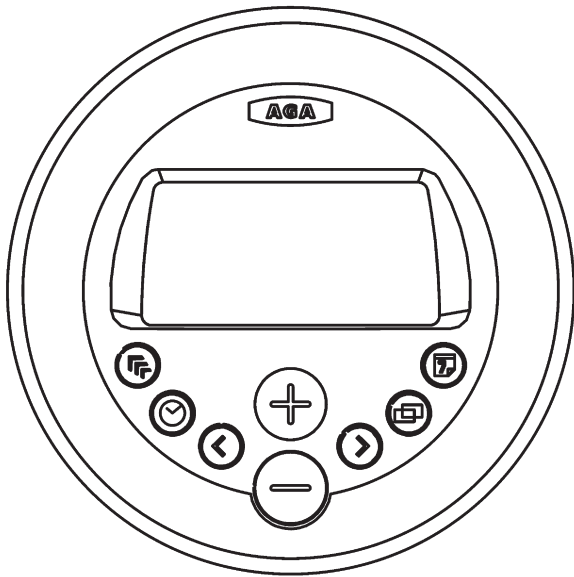









## Screens

The handset has 3 main screens.

1. The Information Home screen (main menu)
2. The Date/Time screen
3. The Events Programming screen

The display will revert to 'sleep' mode after approximately 3 minutes. Simply press the required button to open up any screen.

## Button Operations

-  1. **Communication or 'Handshake' button**  
used initially to synchronise the handset to the AGA Total Control. (On day of installation or in case of replacement handset)
-  2. **Clock button**  
Opens and closes the date and time settings screen.
-  3. **Left/Back Button**  
Moves back and highlights the previous setting.
-  4. **Plus Button**  
Increases the highlighted setting.
-  5. **Minus Button**  
Decreases the highlighted setting.
-  6. **Right/Forward Button**  
Moves forward and highlights the next setting.
-  7. **Copy Button**  
copies the time program from the current day to the following day in the 7-day event calendar screen.
-  8. **7-day event Button**  
Opens and closes the 7-day event calendar screen.

USA  
Model Number AGA TC3  
FCC ID: A2M-AGA-TC3  
FCC ID: A2M-AGA-TC3CKR

This device complies with part 15 of the FCC Rules. Operation is subject to the following two conditions: (1) This device may not cause harmful interference, and (2) this device must accept any interference received, including interference that may cause undesired operation.

CANADA  
Model Number AGA TC3  
IC: 10181A-AGATC3CKR  
  
Model Number AE4M280526  
IC: 10181A-AGATC3

## HANDSET ADVICE

### Operating Distance



The handset will only operate in the same room as the cooker and up to a maximum distance of 13 feet (4 metres) from the appliance. If out of recommended operating range, the handset may show 'Standby'. If this happens move the handset back to within the recommended distance and it should correct itself, see below.

### Handset to AGA Total Control Signal Check

The  (Standby) symbol is shown when in the following situations:-

1. In Standby mode
2. If communications fail
3. There is a power cut
4. If the handset is out of range of the AGA Total Control cooker

When transferring information from or to the controller always operate the handset in front of the cooker, this gives the strongest signal.

If the handset shows  Standby, when the cooker is on, press the  button firmly for 1 second, this will activate the communication link between the cooker and handset.

### Communication/Handshake

For details on initial Communication/Handshake, see Page 12.

### Preview Mode

If the handset is out of range of the cooker or if the appliance is switched off, Preview only mode is available. Changes cannot be made to the programmed events. The  symbol is displayed in the screen and the message 'Preview only' is displayed briefly when the events program screen is first entered.

When in Preview Mode you can review the days by using the  and  buttons. The  and  buttons become inactive and you cannot make any changes.

### Handset Failure

In the unlikely event of handset failure, the appliance would still be operational with the last selected program. The cooker can also be changed to Manual mode from one of the auto modes using the mode button on the control panel. If the handset is damaged or lost, a replacement can be obtained from AGA and re-programmed to suit your appliance.

**DO NOT PLACE THE HANDSET ON ANY HOT SURFACES.**

## COMMUNICATION/HANDSHAKE

This process will be required on the original installation of the AGA Total Control. If the handset is replaced for any reason the new handset will need to be synchronised.

- You will also need to set the time and date.
- You will also be given the option to set your own Auto program preferences.

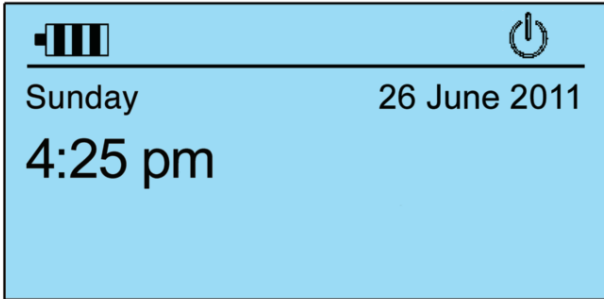

### Step 1

Handshake can be activated 30 seconds after main power has been applied to the cooker. The Standby button on the touch panel must be 'ON'. It must then be completed within 2 minutes, otherwise you will need to repeat the process.

### Step 2

Press and hold  button on the handset for 10 seconds to open the communicate/synchronise screen.

The following screen message then appears.

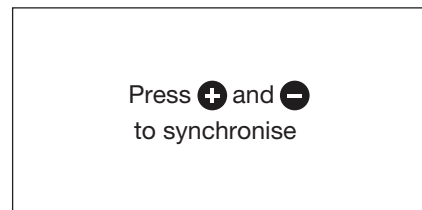



### Step 3

Simultaneously press the  and  buttons, the serial number will be 'found' by the handset.

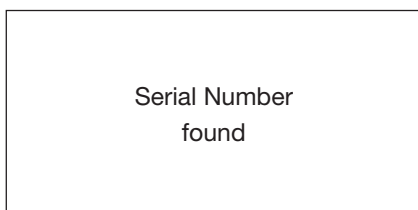
The following screen message then appears briefly.



### Step 4

Use the  and  buttons to choose the language you want the handset text to be in, then press  to confirm the language choice required.

Once time and date has been set the Auto/Event program screen will appear.



### Step 5

Set the correct time and date see Page 13.

### Step 6

You have the option to set your own Auto program at this stage, see Page 13. If you wish to leave until later, then press  it will remain at the pre-set times: 1 Event 7am - 7pm (7 days).

### Notes



-  symbol appears in the top right hand corner of the screen, if the handset is out of range with the cooker or the communication/handshake process has not been completed. When communication is OK then  symbol is displayed.
- The  button can be used to force communication between the cooker and the handset. This function is active once successful initial communication has been made, and the handset is in range.

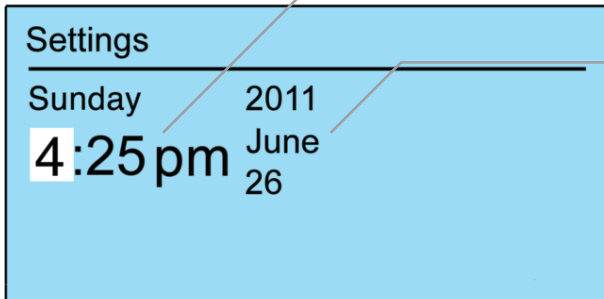

## THE DATE/TIME SETTING SCREEN

Press and hold Clock button  until the screen is displayed.

In this screen the time, date, month and year can be altered/set.



Press the  or  buttons to alter the highlighted time, date, month and year settings.

Press the  or  buttons to cycle between the time, date, month and year.

Press  button at any stage to save the settings and exit the DATE/TIME screen.

'Message sent OK' will appear on the screen when the handset is in range of the cooker.

'Changes stored on handset only' will appear on the screen, when the controller handset is out of range of the cooker.

### Notes

- Even if no changes are made to the time, date, month and year settings, a press of the clock button  is still required, to return to the Home screen.
- The day cannot be changed as the handset automatically knows this information, when the date and year is set.
- The Home screen will automatically appear after the replacement of new batteries.

# AUTO/EVENTS PROGRAM SCREEN

This screen is opened by pressing the 7-day event button .

In this screen, the number of events and the start and end time of events can be set. Each day can have a different number of events, and start and end times, or all seven days can be the same.



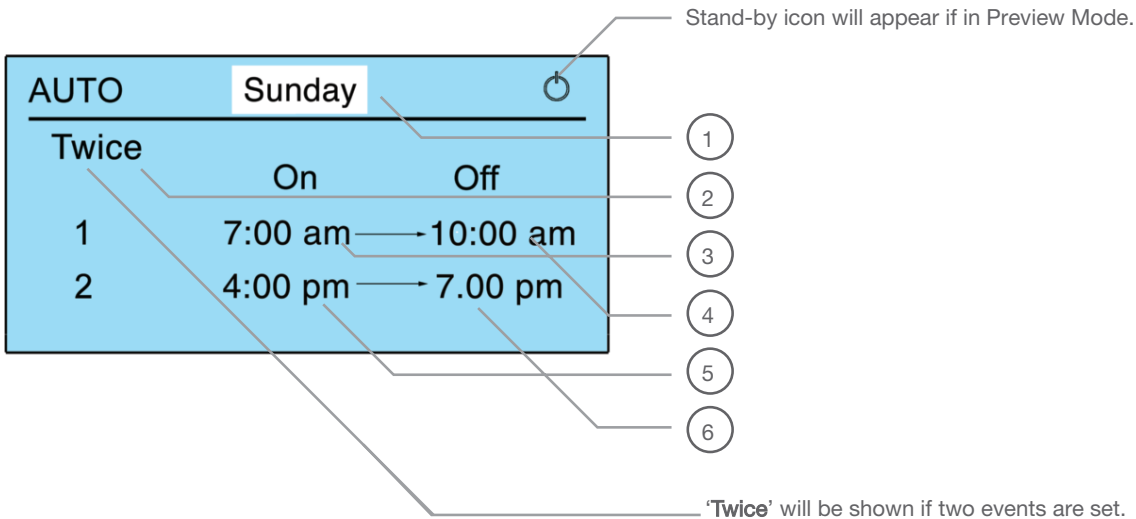









There are pre-set times already programmed, to change to your desired settings follow these instructions. Pre-set times are 1 event 7am - 7pm (7 days).







'Once' will be shown if one event is set.

'No' will be shown if no events are set.

## What you can do



- 1 The current day is shown on the display, this can be changed to the day that you wish to edit by pressing the  and  buttons.
- 2 This shows the number of events in that day. This can be changed from no, once or twice by pressing the  and  buttons.
- 3 This shows the start time of the first event. This can be changed by pressing the  and  buttons.
- 4 This shows the end time of the first event. This can be changed by pressing the  and  buttons.
- 5 This shows the start time of the second event. This can be changed by pressing the  and  buttons.
- 6 This shows the end time of the second event. This can be changed by pressing the  and  buttons.

## How you do it

Press the  or  buttons to navigate through the settings on the screen. When a setting is selected it will be highlighted by a dark box. Pressing the  and  buttons will change the information in this highlighted box.

Press  to copy program settings to next day.

If you have made changes and wish to exit this screen, press the  button. A 'Save Changes' - Yes or No? message will appear on the screen.

Pressing the  and  buttons will highlight Yes or No. Press the  button again to confirm your choice.

**REMEMBER:** After setting the Auto event that an oven selection must be chosen on the touch panel  if you wish to activate the program you have just entered.

## Notes

- Even if no changes are made a press of the  button is still required, to return to the Home screen.

# INFORMATION (HOME) SCREEN

This is the main screen, where information such as time, date, battery life and connectivity is displayed. If you have programmed either of the 'AUTO' modes and they are currently in progress, the next change of event will also be displayed. The information below explains this in more detail.

Press any button on the handset to open this screen, from 'Sleep' mode.

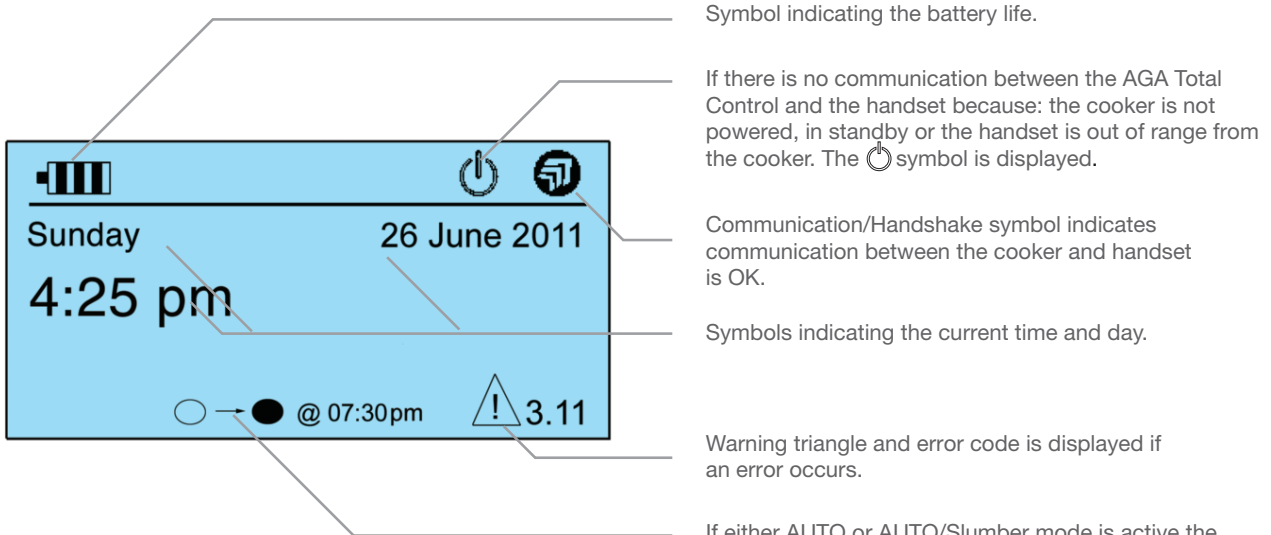

Symbol indicating the battery life.

If there is no communication between the AGA Total Control and the handset because: the cooker is not powered, in standby or the handset is out of range from the cooker. The [power icon] symbol is displayed.

Communication/Handshake symbol indicates communication between the cooker and handset is OK.

Symbols indicating the current time and day.

Warning triangle and error code is displayed if an error occurs.

If either AUTO or AUTO/Slumber mode is active the next event change will be displayed for that day with the relevant symbols to show start and end times.

**NOTE:** If standby icon is shown then event indicator will not be displayed.

## Change of Event Symbols

○ → ● AUTO event on  
(before AUTO event)

● → ○ AUTO event OFF  
(during AUTO event)

◐ → ● AUTO/Slumber event ON  
(before AUTO/Slumber event)

● → ◐ AUTO/Slumber event OFF  
(during AUTO/Slumber event)



### Power Outages under 10 minutes

When the power is restored, the AGA Total Control will resume normal operation as was set prior to the power interruption.

### Power Outages over 10 minutes

Most functions will have turned OFF.

- 'Manual' mode - all zones OFF.
- 'Slumber' mode - hotplates OFF, Slumber ON
- 'AUTO' mode - hotplates OFF, ovens continue with the set programme.
- 'AUTO/Slumber' - hotplates OFF, ovens continue with the set programme.

A 'Power Outage' message may appear on the handset screen, confirm by pressing any button on the handset. Therefore the cooker may not be at temperature when expected.

### Automatic Update of Time

In the event of power cuts the handset will automatically update the controls within the cooker to the correct time on restoration of power. This is provided that the following criteria are met:

1. The handset is sited within range of the cooker
2. The handset has good batteries
3. The handset contains the correct time itself

### Batteries

The handset is fitted with four 'AAA' batteries, which are packed separately. Your installer will insert them when your AGA Total Control cooker is installed. When replacing the batteries, follow these instructions in conjunction with the diagrams.

Remove the handset from its backplate, then remove the battery cover plate from the rear of the handset (Fig. 1). Carefully lever out the batteries commencing with the bottom one first pushing and pulling out on the **positive (+) end only** (Fig. 2). Repeat this procedure to remove the other batteries.

**Always** use long life batteries for replacements - rechargeable batteries are not recommended.

Replace the batteries commencing with the bottom one working to the top (Fig. 3).

Battery life will depend on usage. Replace the batteries when the battery symbol on the handset is down to one bar.

### Care and Cleaning

The handset should be wiped clean using a soft clean cloth. Do not use abrasive cleaning products or submerge the handset in water.

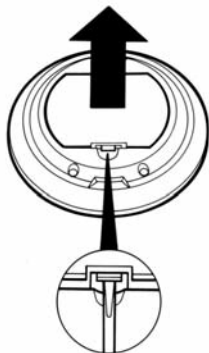

fig 1

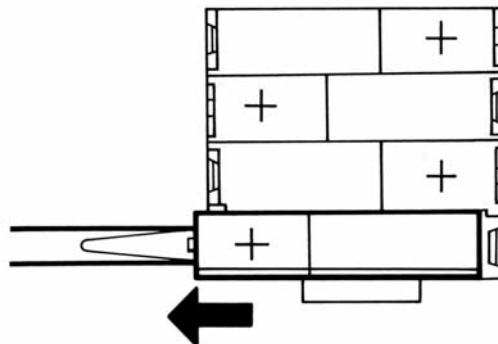

fig 2

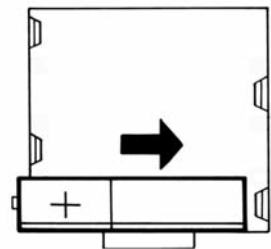

fig 3

## USING THE ZONES OF THE AGA TOTAL CONTROL

The different zones of the AGA Total Control cooker are described in the following pages individually. Recipe suggestions are given for each area or zone with alternative cooking methods - the choice is yours whichever is most convenient to you. For instance you may prefer to use just the hotplates for a quick dinner in the week or there can be a choice of an oven alternative when you have the ovens on during the colder weather or at weekends, when you are doing more cooking.

The classic AGA heat storage cooker is famous for the gentle warmth it emits, with the AGA Total Control you will get warmth only when the cooker is on or warmth to a lesser degree when only parts of it are on.

## THE HOTPLATES

The hotplates are operated manually, make sure the standby button is on then just press the touch control panel of the hotplate you need and a flashing green light will appear, when the hotplate reaches its full preset heat it will become solid green.

The boiling plate is on the left hand side and the simmering plate is on the right hand side of the AGA Total Control. The boiling plate is the hottest with the simmering plate being the cooler of the two. They both have electric elements embedded into the cast iron which heat up in approximately 11 and 8 minutes respectively. The hotplates can be used completely independently from the ovens.

This means the AGA Total Control differs from the classic AGA heat storage cooker in that they can be used for the entire cooking time of appropriate dishes because the design keeps the hotplates at a constant heat, whereas the classic AGA cooker continues to cook on a falling heat so for these we recommend starting on the hotplate(s) then transferring to the ovens, this can be done with the AGA Total Control but is not necessary. For instance, if making a pasta dish with sauce on the AGA Total Control, it can all be done on the hotplates.

The whole hotplate area can be used for cooking and several pans can be accommodated on a single plate at any one time. The hotplates are set very slightly above the top plate to avoid accidental scratching if the pans are pulled to one side. Do not drag the utensils from one plate to another as the enamel will suffer!

The stainless steel insulated covers are brought down over the hotplates when they are not in use. When the hotplates are 'on' the insulated covers will be warm. We **strongly advise** not to put anything such as kettles, saucepans or baking tins directly onto the insulated covers because they will show any scratches – invest in a pair of chef's pads to protect the surface if the covers are to be used as resting places!

Keep the hotplates clear of any burnt on food or crumbs by brushing with the wire brush, supplied with your AGA. Cleaning details can be found on page 24.

## THE BOILING PLATE

The hottest hotplate, the boiling plate is used for boiling, grilling, stir-frying, making toast - indeed anything that requires a high heat. Green vegetables keep their colour when boiled quickly here, or use a steamer over the saucepan to cook more than one vegetable at once.

When stir frying or cooking anything that is inclined to splash we would recommend using an AGA Splash Shield which will protect the insulated cover from splatter, making cleaning simple and easy! Just wash the Splash Shield in hot soapy water or place in a dishwasher between two dinner plates.

Please be advised the boiling plate is too hot to cook food direct on it.

For recipes ideas , see separate recipe book.

- 11 | Eggs in fried bread
- 22 | Chunky Autumn Veg Soup
- 24 | Speedy Chargrilled Chicken and Pesto Pasta
- 30 | Sesame Beef Stir Fry
- 32 | Quick and Easy Mushroom Risotto
- 34 | Pan Fried Sea Bass with Tangy Mango Salsa
- 36 | No Fuss Frittata
- 38 | Chilli Con Carne
- 40 | Good Old Sunday Roast
- 42 | Green vegetables
- 44 | Thai Green Curry
- 52 | Cozy Night in with Venison and Bramble Sauce
- 54 | Marcia's Slow Cooked Pork and Butternut Squash Casserole
- 64 | Fresh Raspberry and Chocolate Cheesecake
- 66 | Poppy Seed and Marmalade Traybake
- 68 | Steamed Banana Pudding drizzled in Butterscotch Sauce
- 82 | Quick Berry Jam

## THE SIMMERING PLATE

The simmering plate is the cooler of the two hotplates and so is used for recipes that require a lower heat such as, making sauces, scrambling eggs, heating milk, slow frying, simmering soups and root vegetables. In addition it can be used direct on as a form of griddle - invaluable for toasted sandwiches, quesadillas, drop scones, searing scallops and even a non-fat fried egg! Slow cooked toast can be made on the simmering plate, no need here to use the AGA toaster.

The same size as the boiling plate the simmering plate is also machined flat to give the best all-over contact with the AGA saucepans, grill pan, frying pan and kettle.

Cleaning details can be found on page 24.

For recipes ideas , see separate recipe book.

- 06 | AGA Porridge
- 08 | Smoked Salmon Scramble
- 11 | No Fat Fried Egg
- 12 | Drop Scones
- 16 | Halloumi and Chargrilled Pepper Summer Salad
- 18 | Quesadillas
- 22 | Chunky Autumn Veg Soup
- 24 | Speedy Chargrilled Chicken and Pesto Pasta
- 44 | Thai Green Curry
- 51 | Poppy's Spinach and Feta Flatbread
- 70 | Cheese and Ham Toasties
- 74 | Double Ginger Cookies
- 78 | Pumpkin Seed and Cranberry Flapjack
- 80 | Quick and Easy Fishcakes
- 82 | Quick Berry Jam
- 94 | Dad's Favourite Steak and Ale Pie
- 96 | Winter Warming Fish Pie

## THE TOP PLATE

The top plate is the enamelled surface surrounding the hotplates. It will become warm when the AGA Total Control hotplates are in use. Although it is not a cooking surface you can use the warmth for a number of useful activities, which more often than not saves time and washing-up! These include warming honey or syrup in the jar, or melting butter or chocolate in a basin - so saving on melting over a saucepan - do please put the basin on a cork mat or folded piece of kitchen towel to avoid scratching the enamel. Although it is a durable and hard-wearing surface vitreous enamel is glass and will show scratch marks!

The top plate when warm can also be used to rest a cup of coffee or tea or dry off awkwardly shaped pans, peelers or food mixer and processor parts.

## THE OVENS

Your AGA Total Control has three ovens, each of which is pre-set at a different heat, just like the classic AGA heat storage cooker. They are named as:

### The Roasting Oven

for high temperature cooking

### The Baking Oven

for moderate temperature cooking

### The Slow Cook Oven

for long slow low temperature cooking

**DO NOT OPERATE THIS APPLIANCE WITH THE DOORS OPEN, SINCE THIS CAN CAUSE A LOCK-OUT.**

Each oven has the same capacity, (able to fit a 28lb (13kg) turkey) and the classic AGA heat-storage cooker techniques can be used such as stacking of saucepans in the slow cook oven. This enables the steaming of root vegetables, rice, steamed pudding, casserole, poaching fruit all in the one oven leaving the hotplates free and reducing steam and cooking smells in the kitchen.

You can have one, two or all three ovens on at their pre-set heat or the roasting and baking ovens can also be at 'Slumber' mode, (the slow cook oven is always at the same heat).

The ovens are made from cast iron, which cooks by a radiant heat and this is the secret of the cooking excellence for which the AGA cooker is renowned. An indirect radiant heat does not dry food out, so it retains its natural moisture and flavor.

### Slumber Mode

In Slumber mode, all three ovens operate like a slow cook oven.

The slow cook oven is always in Slumber, whereas the roasting and baking oven can be set on Slumber mode for either cooking at a low heat, or to generate gentle warmth into the kitchen, or in readiness for turning up to their normal pre-set heat.

Cooking at Slumber in the roasting oven or baking ovens gives the best results for making large rich fruit cakes and meringues as they benefit from the gentle heat of top and base elements to ensure thorough cooking. Other foods which benefit from cooking at Slumber in these ovens are steamed and Christmas Puddings and slow cooking large pieces/cuts of meat - start the cooking process before placing the oven on Slumber.

**Recipes in the separate recipe book cooked on slumber are:**

- 62 | Pears with Cardamom
- 68 | Steamed Banana pudding drizzled in Butterscotch Sauce
- 88 | Fruity Celebration Cake

# THE ROASTING OVEN



The roasting oven is indirectly heated by two elements, one in the base of the oven and the other in the roof. These elements heat the air and the cast iron within to provide cooking results consistent with the classic AGA heat-storage cooker, with the flexibility of being able to turn it to Slumber or Off when not required.

The roasting oven can be used for 'broiling' at the top and 'shallow frying' on the oven floor.

- When cooking on the bottom of the roasting oven for long periods of time (more than 30 minutes), place the floor grid on the bottom of the oven before putting the food into the oven, this lifts the food away from the base element to ensure best cooking results are achieved.

#### A note when cooking on the bottom of the roasting oven.....

- Please leave 1 hour before cooking directly on the bottom of the oven, this is to ensure maximum temperature stabilisation of the base element.
- You can cook directly on the bottom of the roasting oven for short periods of time e.g. pizza, quiche, or foods that take 30 minutes or less.

**NOTE:** The roasting oven perforated baffle should be positioned in the top of the roasting oven in order to optimise cooking performance. It must be in place at all times, while the cooker is in operation, including when grilling. (See diagram for fitment of roasting oven perforated baffle).

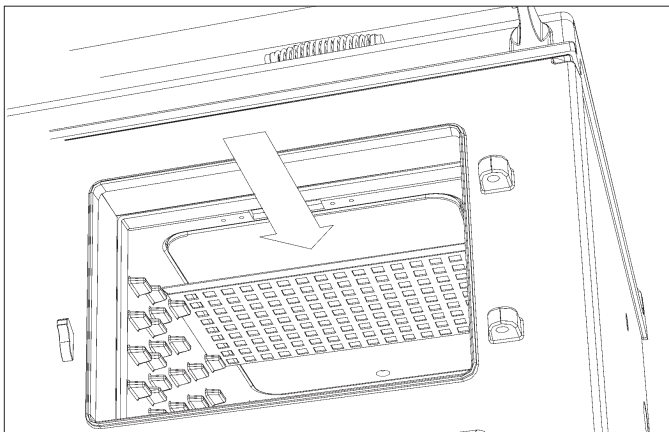

The roasting oven is zoned in heat, meaning it is slightly hotter towards the top than the center and the oven grid shelf set on the oven floor is slightly less hot than the center.

The bottom of the oven can be used as another cooking surface, indeed it is often called a hidden hotplate - for food needing longer than 30 minutes, such as roast potatoes, on the bottom of the oven you will need to use the floor grid for protection, so they do not over brown.

The beauty of the roasting oven is that any fat splashes are burnt off when the oven is at full heat, just brush out occasionally to get rid of carbon deposits.

The roasting oven is excellent for bread and pastries. Quiches in ceramic or pies in Pyrex dishes need not be baked blind as when they are placed on the floor of the oven the pastry cooks from underneath and the filling will set and brown from the all-round heat. As you are aware metal flan pans conduct heat quicker than ceramic so always place them on the floor grid placed on the bottom of the oven to avoid over-base browning.

The specially designed roasting pans and bakeware slide directly onto the runners, so almost every available square inch of space can be used. Food can be protected by the use of the cold plain shelf or shielded by means of the large roasting tin, which means that you can cook food that requires different temperatures at the same time. If food is browning too quickly and you do not want to move it to another oven just slide the cold plain shelf over the food to reduce the top heat.

#### Roasting Oven at Slumber

When the roasting oven is set at Slumber it can be used to cook rich fruit cakes or slow cook roasts, casseroles and curries. With the exception of meringues and rich fruit cakes, food that is to be slow cooked should be brought up to heat before placing in an oven at Slumber. The light will flash orange when heating up to Slumber, then go solid orange when up to temperature.

**For recipe ideas, see separate recipe book.**

- 10 | The Full English
- 14 | Muffins
- 16 | Halloumi and Chargrilled Pepper Summer Salad
- 20 | Broccoli and Goat's Cheese Tart
- 26 | Late Night Cheese on Toast
- 28 | Hearty Veg and Sausage Bake
- 36 | No Fuss Frittata
- 40 | Good Old Sunday Roast
- 42 | Roast Potatoes
- 42 | Roast Parsnips
- 43 | Yorkshire Puddings
- 46 | Stuffed Sea Bass with Roasted Mediterranean Veg
- 48 | Spatchcock Spring Chicken
- 50 | Moroccan Harissa Lamb and couscous
- 60 | Cherry and Almond Tart
- 72 | Homemade Burgers with Chunky Wedges
- 86 | AGA Loaf
- 90 | Classic Cream-Tea
- 92 | The Ultimate Roast Chicken
- 94 | Dad's Favourite Steak and Ale Pie
- 96 | Winter Warming Fish Pie

# THE BAKING OVEN

## Baking Oven at Slumber

When the baking oven is set at Slumber it can be used to cook rich fruit cakes or slow cook roasts, casseroles and curries.

With the exception of meringues and rich fruit cakes, food that is to be slow cooked should be brought up to heat before placing in an oven at Slumber. The light will flash orange when heating up to Slumber, then go solid orange when up to temperature.

**For recipe ideas, see separate recipe book.**

- 14 | Muffins
- 52 | Cosy Night in with Venison and Bramble Sauce
- 53 | Potato Dauphinoise
- 56 | Dawn's Damson Meringue Roulade
- 58 | Rhubarb and Ginger Crumble
- 64 | Fresh Raspberry and Chocolate Cheesecake
- 66 | Poppy Seed and Marmalade Traybake
- 73 | Potato Wedges
- 74 | Double Ginger Biscuits
- 76 | Cheeky Choc-a-lot Cupcakes
- 78 | Pumpkin Seed and Cranberry Flapjack
- 84 | The Victoria Sponge Cake
- 88 | Fruity Celebration Cake



The baking oven is indirectly heated by two elements, one in the base of the oven and the other in the roof. These elements heat the air and the cast iron within to provide cooking results consistent with classic AGA heat-storage cookers, with the flexibility of being able to turn it to Slumber or Off when not required.

This oven is set at a moderate heat, so is ideal for cakes, biscuits; also anything that requires medium heat cooking such as fish pie, lasagne, soufflés, crumble and roulades. Meat and poultry can be cooked here indeed most things that can be cooked in the roasting oven can be cooked in the baking oven but for a longer time.

For the best results when cooking cakes do allow an hour heat up time. Cook cakes together on one shelf if two shelves are used interchange the food to achieve even coloration, as you would with any oven which is zoned in heat.

As with the roasting oven the specially designed roasting pans and bakeware slide directly onto the runners, so almost every available square inch of space can be used. Food can be protected by the use of the cold plain shelf or shielded by means of the large roasting pan, which means that you can cook food that requires different temperatures at the same time. If food is browning too quickly and you do not want to move it to another oven just slide the cold plain shelf over the food to reduce the top heat.



# THE SLOW COOK OVEN



The slow cook oven is indirectly heated by one element in the base of the oven.

This element heats the air and the cast iron within to provide cooking results consistent with the traditional slow cook oven of the classic AGA heat-storage cooker, with the flexibility of being able to turn it to Off when not required. The slow cook oven is always at a simmer or Slumber mode ideal for long slow cooking.

The floor grid is used here to protect items placed on the bottom of the oven such as vegetables for steaming, keeping sauces warm or casseroles cooked for a long time. Always ensure this is in place, before putting food into the oven.

The slow cook oven can be described as a continuation oven, it continues to cook food that has been brought up to heat elsewhere on the cooker with the exception of meringues which are dried out rather than 'cooked'. Therefore the following recipes call for heating the food on the hotplates or in the roasting oven before placing in the slow cook oven,

**For recipe ideas, see separate recipe book.**

- 06 | AGA Porridge
- 32 | Quick and Easy Mushroom Risotto
- 38 | Chilli Con Carne
- 42 | Steamed Carrots
- 50 | Moroccan Harissa Lamb and couscous
- 54 | Marcia's Slow Cooked Pork and Butternut Squash Casserole
- 62 | Pears with Cardamom
- 68 | Steamed Banana Pudding drizzled in Butterscotch Sauce
- 94 | Dad's Favourite Steak and Ale Pie

## User Guidance

- Allow the oven to heat up fully, the longer the oven is on the better, since this helps reduce the amount of moisture created during slow cooking.
- To get the very best performance, we recommend to use AGA cookware with thick bases and stacking lids.
- Do not place dishes directly on to the oven base. Always place onto either a shelf or the floor grid.
- Cuts of meat and poultry should be brought up to heat ideally in the Roasting oven for 30 - 45 minutes, then transfer to the Slow Cook oven.
- This method is unsuitable for stuffed meat and poultry.
- Make sure that pork and poultry reach an internal temperature of at least 167°F.
- Always bring soups, casseroles and liquids to the boil on the hotplate before putting in the oven.
- Always thaw frozen food completely before cooking.
- Root vegetables will cook better if cut into small pieces.
- Adjust seasonings and thickenings at the end of the cooking time.
- Many dried beans for example, dried red kidney beans must be boiled for a minimum of 10 minutes, after soaking, and before inclusion in any dish.

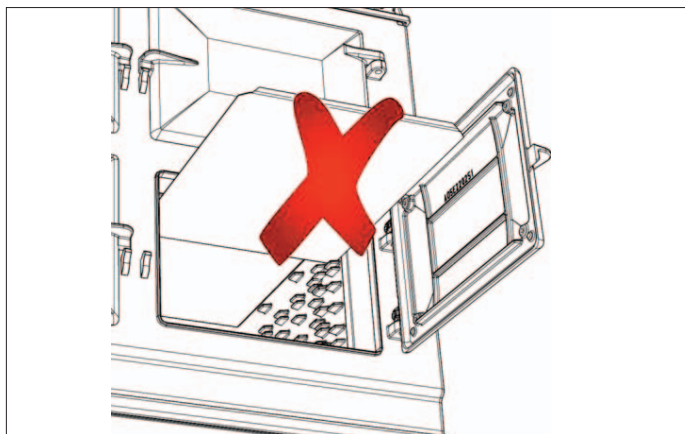

**PLEASE NOTE: DO NOT** store anything in the Slow Cook oven and **DO NOT** use any large cookware such as the cold plain shelf until the oven has reached its operating temperature. Failure to do this may cause the safety function to lock the appliance in the **OFF** position. It is also advisable when using large cookware in the Slow Cook oven to push it to the back of the oven.



## AGA TC5 (HOTCUPBOARD OPTION)

### Slow Cooking Oven plus Warming Oven

These ovens are heated by a single element at the rear of the oven cavity. It is operated by a single push ON-OFF button located on the left hand side of the hotcupboard top plate and can be turned ON and OFF when required.

### Slow Cooking Oven

This oven has similar characteristics of the simmering oven and should be utilised in a similar manner. It delivers a gentler convected heat making it better suited for longer cooking times especially for overnight cooking, for example rich fruit cakes and celebration cakes. The cooking of meringues may also be better suited for this oven.

**NOTE:** These ovens vent into the room, mechanical venting to the outside is not available.

### Points to remember when Slow Cooking:

- Pre-heat the oven for 30 minutes before starting to cook.
- Bring casseroles, soups etc to the boil on the hob and meats started in the roasting oven, before placing in the slow cooking oven.
- Make sure that casseroles have sufficient liquid, particularly when cooking over a long period.
- Use lids on casseroles or foil to cover food whilst it is cooking to retain moisture.
- Make sure all dishes will fit into the oven before preparing food.
- Wrap washed and pricked jacket potatoes in foil before cooking.
- Make sure that meat and poultry is piping hot before eating.
- Always thaw frozen food completely before cooking.





You can also produce crisp, white meringues cooked in the slow cooking oven.

Timings for cooking in the slow cooking oven will depend upon the temperature, quantity and type of dish you are cooking, as a guide for casseroles, a minimum of 3 hours cooking time is recommended.

Keep an eye on the food until you are familiar with the oven.

## IMPORTANT INSTRUCTION

### BE CAREFUL OF THE HOT APPLIANCE.

-  **DO NOT USE A STEAM CLEANER TO CLEAN THIS COOKER.**
-  **DO NOT USE ABRASIVE PADS, CAUSTIC CLEANERS, OVEN CLEANERS OR METAL SCRAPERS TO CLEAN THE SURFACES OF THE ENAMEL.**
-  **THE TOUCH CONTROL PANEL MAY BE CLEANED WITH A DAMP CLOTH AND WARM SOAPY WATER.**
-  **DO NOT USE ANY POWER SPRAYS OR OVEN CLEANERS ON THE CONTROL PANEL.**

### Top Plate and Front Plate

The easiest way to clean the AGA top plate and front plate is to mop up spills as soon as they happen. It may be useful to keep a damp cloth handy to do this. Baked-on food is more difficult to clean but can usually be removed with vitreous enamel cleaner or mild cream cleaners using a damp cloth, or, if necessary a nylon scouring pad. If milk or fruit juice or anything containing acid, is spilt on the cooker, wipe it up immediately. Also clean off any condensation streaks on the front plate around the oven doors or the vitreous enamel maybe permanently discolored.

All that is usually needed to keep the vitreous enamel surfaces of the cooker bright and clean is a daily rub over with a damp soapy cloth followed immediately with a clean, dry cloth to avoid streaks. The AGA E-cloths are excellent for this.

Remember the top plate and the polished covers will scratch if pans or utensils are dragged across them.

### Insulating Covers and Oven Door Linings

The best way to keep the linings clean is to wipe them over after cooking so that splashes do not get baked on (being careful with a hot cooker). Clean the linings when they are cool, the cooker is off.

Linings of the Insulated Covers (lid interior) - the use of an AGA splash shield is recommended to keep the lining free of fat splashes (obtainable from your AGA Retailer). If the linings are marked these are best cleaned when the hotplates are cold. Linings can be cleaned with hot soapy water and /or a cream cleanser. If badly marked then a soapy soap-impregnated pad can be employed - this should be used in a circular motion. The first few times you use a soap-impregnated pad you will see the circular marks but these are reduced and the surface of the linings become shinier each time of use. Do not use excessive water and make sure the linings are dry before closing the covers.

Oven door linings - the linings can be cleaned with hot soapy water and / or a cream cleanser. To deep clean the linings, place a towel on the work surface and carefully lift off the oven door (doors are heavy) and place it enamel side down on the towel padding. Clean with a soapy impregnated pad to remove stubborn marks. Do not immerse the doors in water as they are packed with insulating material which will be damaged by excessive moisture. Needless to say, do not put oven doors in a dishwasher! Dry off before carefully replacing on their hinges.

### Insulating Covers and Oven Door Linings

The tops of the insulating covers (lids) these are stainless steel and can be kept clean by wiping over with a damp cloth and polished up - the AGA E-cloths are excellent for this purpose as they are lint free and eco-friendly. AGA Stainless Steel and Chrome Cleaner are recommended to keep the insulated covers clean and shining, which can be purchased from your AGA Specialist. To clean the oven doors, ensure the ovens are turned off and allowed to cool before cleaning. They may be cleaned with a cream cleaner or soap impregnated pad.

To clean the insulating covers, ensure the hotplates are turned off and allowed to cool before cleaning. They may be cleaned with a cream cleaner or soap impregnated pad.

**DO NOT IMMERSE THE DOORS IN WATER AS THEY ARE PACKED WITH INSULATING MATERIAL WHICH WILL BE DAMAGED BY EXCESSIVE MOISTURE.**

**DO NOT PUT OVEN DOORS IN A DISHWASHER.**

### Ovens

The cast iron ovens help to keep themselves clean, they merely need to be brushed out occasionally with the wire brush supplied.

The ovens are made from cast iron, and are very durable, but they will rust if surface moisture is left on them regularly. Remember to always switch the ovens on, to dry them out after cleaning. This is done by leaving them to heat up until the green light on the control panel turns solid.

Heating up of the ovens periodically, will help burn off any cooking deposits to aid cleaning within the ovens.

### Hotplates

The hotplates are easy to care for, and regular maintenance will ensure long-life. Should the hotplates become soiled, use a sponge, cloth, scouring pad or wire brush to remove burnt-on spills. Rinse off detergents or cleaning agents thoroughly. Hotplates are made from cast iron, and are very durable, but they will rust if surface moisture is left on them regularly. Remember to switch on the plates for a few minutes to dry them after cleaning. Every now and then, apply a thin coating of cooking oil when the hotplates are cold.

### Roasting Pans

The enamelled roasting pans supplied with the AGA Total Control should be cleaned in hot soapy water, soaking if necessary. A nylon scouring pad can also be used. They may also be cleaned in the dishwasher, but with constant use, the enamelled finish will become dull in appearance.

**DO NOT** use caustic cleaners or oven cleaners.

**PLEASE NOTE: Cleaners used for Vitreous Enamel are often unsuitable for use on: chrome and stainless steel components, including the insulating covers, hand-rails and their brackets.**

## FITTING OF OVEN SHELVES

When using the oven shelves for the first time follow Figs. 4 - 7.

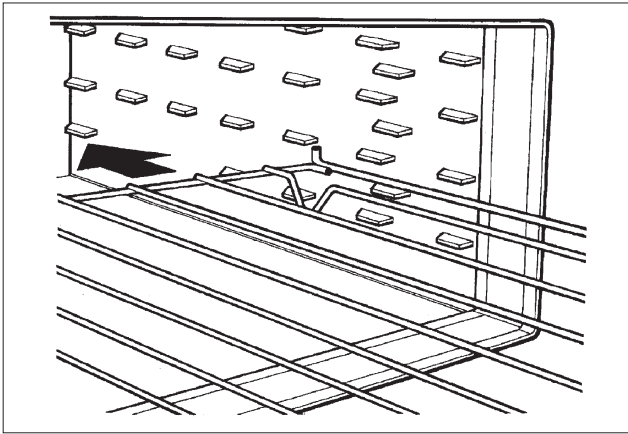

fig 4

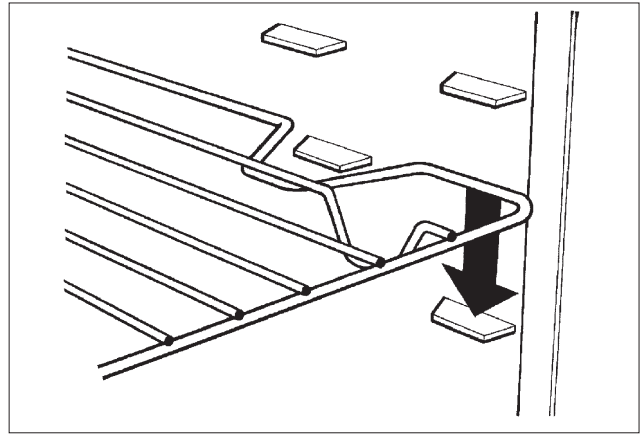

fig 5

## REMOVAL OF OVEN SHELVES

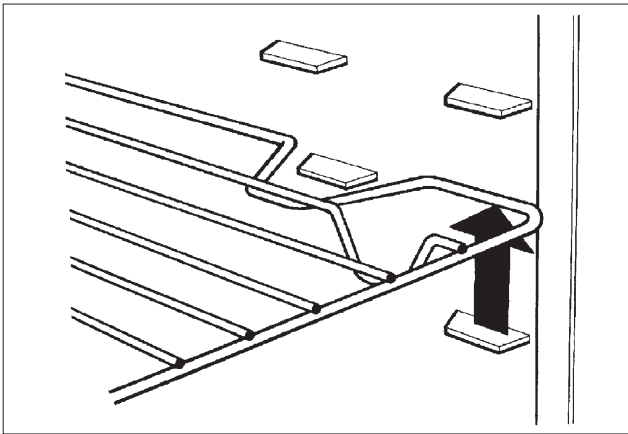

fig 6

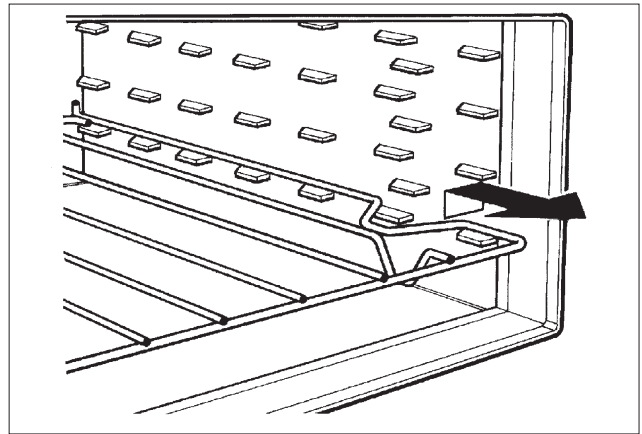

fig 7

## FITTING AND REMOVAL OF OVEN DOORS

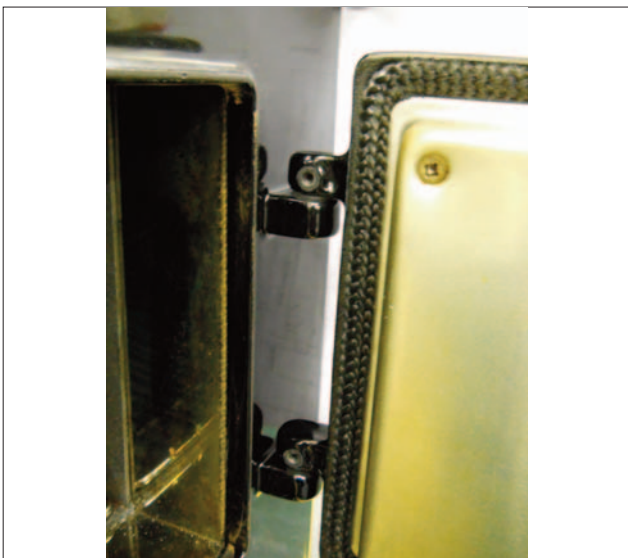

fig 8

DOOR HINGES LOCATED

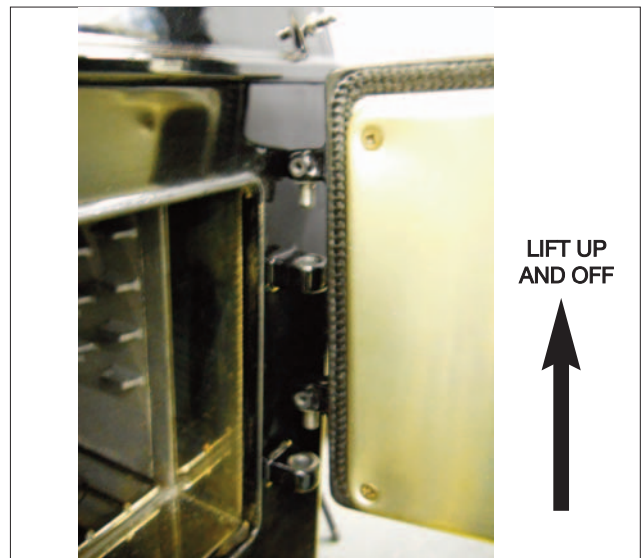

fig 9

ENSURE DOOR IS OPEN BEFORE LIFTING UP AND OFF TO AVOID DAMAGE TO THE ENAMEL

## SERVICE

- In the event of your appliance requiring maintenance, please contact AGA Marvel or your AGA Retailer.
- Your cooker must only be serviced by a qualified engineer, from an authorized AGA Specialist.
- Do not alter or modify the cooker.
- Only the parts specified by the manufacturer, are to be fitted.
- The appliance warranty does not cover Commercial use.

For continued efficient and safe operation of this appliance, it is important that servicing is carried out at regular intervals as recommended by your AGA Retailer. The cooker should be turned OFF in advance of the service so that the appliance will have cooled down sufficiently.

### **A HOT APPLIANCE CANNOT BE SERVICED.**

## WARRANTY

### **WELCOME**

Thank you for choosing an AGA cooker. We are sure that you will be impressed with the performance of your new AGA cooker and with the ongoing service you will receive.

### **PEACE OF MIND**

Every new AGA leaving the factory and installed by an AGA approved outlet carries a 5 year guarantee on parts (certain consumable parts are excluded - for full details see below). This also includes all labor charges for the first 12 months.

### **DISTRIBUTION AND SERVICE NETWORK**

AGA has set up an International Distributor and service network with fully trained service engineers available to support your AGA within the guarantee period. The approved outlet installing your AGA is responsible for providing this warranty.

### **No charge will be made for replacement parts providing:**

- An appliance fault is found.
- The relevant part of the AGA is still covered by the guarantee.
- Regular servicing has been carried out in accordance with the manufacturer's instructions by authorized AGA engineers, using approved spare parts. The service booklet will need to be completed accordingly.

There will be no labor charges during the first 12 months of the warranty.

### **A call out charge may be applicable if:**

- The authorized AGA service engineer who calls at your home finds no fault with the AGA.
- Other parts of your plumbing system or flue, are either faulty or do not comply with the appropriate installation instructions.
- The unit is more than 12 months old.
- If it is deemed the product has been misused.

Please note that invoices for call out repair work carried out during the guarantee period by any third party cannot be accepted.

**In the event of an appliance fault during the guarantee period, please contact your service provider. They will arrange for an engineer to call as soon as possible.**

### **What is not included in the guarantee**

- Consumable parts
- Flues (except integral power and balanced flues).
- Any labor charges not directly connected with the repair or replacement of a faulty component.
- Any consequential loss.
- Any part of the domestic hot water system which is not an integral part of the AGA.
- Accidental or cosmetic damage.
- Routine preventative service and maintenance.
- Any external controls/components not supplied by AGA.
- Oil filled Heat indicators are only covered for 12 months.

## REGULAR SERVICING

Regular maintenance is an essential part of keeping your AGA cooker running safely and efficiently.

Since your AGA can operate continuously it is important to ensure regular servicing is undertaken by AGA Service or your Authorized AGA Distributor. Only genuine AGA spare parts are used.

Please note that routine servicing in accordance with the manufacturer's instructions is also a condition of the warranty agreement.

To ensure your AGA receives this essential maintenance, please contact AGA Service or your Distributor, who will be pleased to help.

### Service Intervals

**(Certain models may vary)**

Oil AGA - every 6 months

Gas and Electric Heat Storage AGA's - every 12 months

Electric 13 amp and AGA Total Control - Interim service 2 1/2 years (30 months)

Full service 5 years (60 months)

## CONSUMABLE PARTS NOT COVERED BY THIS WARRANTY

Oil AGA - oil filters and wicks

Gas Fired AGA's - ignitor electrodes, thermocouples

Electric AGA - Vent and circulation fans are for 2 1/2 years (30 months)

## EXCLUSIONS

This warranty does not cover products which have been altered by the customer or by a third party. Materials, spare parts and specific tools must be as recommended by AGA.

Warranty does not cover misuse, abuse or impact damage. Corrosion caused by incorrect use of chemical cleaners or scratches to chrome or stainless steel components by abrasive cleaning materials are also excluded.

Warranty strictly excludes commercial use. Appliances are covered for domestic use only.

### Flues and Ventilation and External Services:

External services, gas supply, external oil lines, tanks and filters are not covered under this warranty.

This warranty does not cover incorrectly or poorly maintained flue systems or appliances installed on incorrect flue systems of unsuitable material and outside the specification detailed in the product instructions.

Appliances not provided with adequate ventilation as detailed in the product instructions also fall outside this warranty.

*This policy applies to products which carry the AGA name plate and trademark*

*(AGA utensils and accessories are covered by a separate policy)*

*Product fuel conversions are not covered*

**THIS WARRANTY POLICY DOES NOT AFFECT THE OWNERS STATUTORY RIGHTS**

## ERROR CODES

In the unlikely event an error occurs with your AGA Total Control cooker, error codes may be displayed on your handset, for example:

Please provide AGA Service with this information. It will assist the service engineer with diagnosing your fault.

⚠ 3.11

## SERIAL NUMBER

Make a note of your AGA Total Control Serial Number when it is being installed. The serial number can be found behind the magnetic plinth cover.

## HEALTH AND SAFETY

### Consumer Protection

As a responsible manufacturer, we take care to make sure that our products are designed and constructed to meet the required safety standards when properly installed and used.

⚠ This appliance is not intended for use by persons (including children) with reduced physical, sensory or mental capabilities, or lack of experience and knowledge, unless they have been given supervision or instruction concerning use of the appliance by a person responsible for their safety.

⚠ Children should be supervised to ensure that they do not play with the appliance.

⚠ **PLEASE READ THE ACCOMPANYING WARRANTY**  
Any alteration that is not approved by AGA could invalidate the approval of the appliance, operation of the warranty and could also affect your statutory rights.

⚠ **APPLIANCE**

**YOUNG CHILDREN SHOULD BE KEPT AWAY FROM THE APPLIANCE AS SURFACES CAN BECOME HOT TO TOUCH.**

### Deep Fat Frying

- Use a deep pan.
- Never fill the pan more than one-third full of fat or oil.
- Never use a lid on the pan.
- Important: Oil is a fire risk, do not leave pans containing oil unattended.
- In the event of a fire, cover the pan with a lid and turn OFF the appliance.

Smother the flames on the hob preferably with a fire blanket, rather than attempting to remove the pan to the outside.

Burns and injuries are caused almost invariably by picking up the burning pan to carry it outside.

- **Do not hang clothes on the left hand side of the AGA hand-rail. The electrical controls are behind the top left hand door, blocking the air vent can cause excessive control temperatures, and will prevent easy access to the controls.**

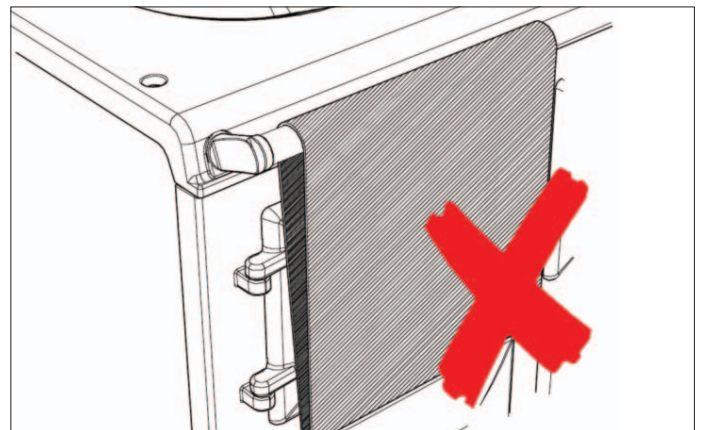

⚠ When the oven(s) are on **DO NOT** leave any oven door open for long periods, this will effect the temperature of the oven and may allow controls to become hot.

⚠ A little smoke and some odor may be emitted when the appliance is first switched on. This is normal and harmless (from oven lagging and starch binder on the element insulation) and will cease after a short period of use.



# AGA BASIC RECIPES

These are some fundamental recipes and methods to complement your first AGA cooking ventures. The real basics to get you started and used to using your AGA Total Control cooker. Relax, enjoy and then try some of our ideas in the Recipe section of this handbook.

## AGA Toast

AGA toast is renowned for its excellence, crisp on the outside and soft in the center. Take thick slices of bread and place in the AGA toaster – if the bread is very moist or very fresh, heat the toaster beforehand to prevent sticking – lift the boiling plate insulated cover and place the toaster direct onto the plate with the handle at an angle from the handle of the cover. Close the cover and wait for the bread to toast one side – this will take 1-2 minutes dependent upon the variety of bread – open the cover and turn the toaster over and repeat the process to toast the other side.

Serve piping hot with butter and marmalade. A great start to the day!

## Quick White Sauce

This is a coating sauce and can be used in a pasta bake, on its own or flavoured to accompany vegetables. For a pouring sauce reduce the quantities of butter and flour to 1½ oz retaining the same amount of milk.

Makes (1 pint)

2 oz butter  
2 oz plain flour  
¾ pint milk  
Salt and white pepper

Place all the ingredients into a saucepan.

AGA hotplate cooking: Place on the simmering plate and use a silicone whisk to whisk continuously until the sauce has come to the boil and thickened. Cook for 2 minutes, still whisking, check the seasoning and use as required – for example over broad beans, steamed baby beetroot, Jerusalem artichokes.

### Variations

#### Cheese sauce

Whisk in 1 tsp mustard and 2 oz well-flavoured cheese.

#### Parsley sauce

Whisk in 3 tbsp chopped parsley, serve at once with cooked ham or fish.

#### Béchamel sauce

Before making the sauce infuse the milk to flavor it with a quartered, peeled onion and a bay leaf, discard these and continue as above.

## Steaming Vegetables

Steaming of root vegetables can take place either on the hotplates using a steamer over an AGA saucepan, alternatively if you have the slow cook oven, (or any oven at Slumber), switched on then you can oven steam the root vegetables. Oven steaming means saucepans of root vegetables can be started on the hotplates, using a small amount of water, brought to the boil for 3-5 minutes, the water drained and the saucepan lid replaced. Put on the floor grid in the simmering oven for 20 -30 minutes until tender. 6-8 saucepans can be accommodated in the slow cook oven, leaving the hotplates free for 6 more!

Green vegetables benefit from quick boiling on the boiling plate to keep their vibrant colour, or you can steam them over boiling water.

## Boiling a kettle

When the boiling plate is switched on then it's time for tea! The AGA kettles are especially designed for maximum performance on your cast iron hotplates, the kettle will boil quickly on the hot boiling plate - if you have just turned on the boiling plate obviously it will take longer to boil! Always use fresh water, just enough in the kettle for your requirements and it's a good habit to always leave the kettle empty to minimise the build up of limescale.

Place the kettle onto the boiling plate, giving it a slight twist as you do so to ensure a perfect contact. Also check the hotplates are clear of any burnt on spills or crumbs - just brush over the cast iron with the wire brush, supplied with your new AGA Total Control. Pointing the spout towards the lid lining will help keep it clean, as the steam can loosen splashes. Give the lining a quick wipe over after removing the kettle.







**For further advice or information contact  
your local AGA Specialist**

With AGA's policy of continuous product improvement, the Company reserves the right to change specifications and make modifications to the appliance described and illustrated at any time



US Office:

AGA MARVEL  
1260 E Van Deinse St.  
Greenville, MI 48838

[www.agamarvel.com](http://www.agamarvel.com)