

Use, Care, and Installation Guide

CACHE

CCA-E30ASX
CCA-E36ASX
CCA-E48ASX

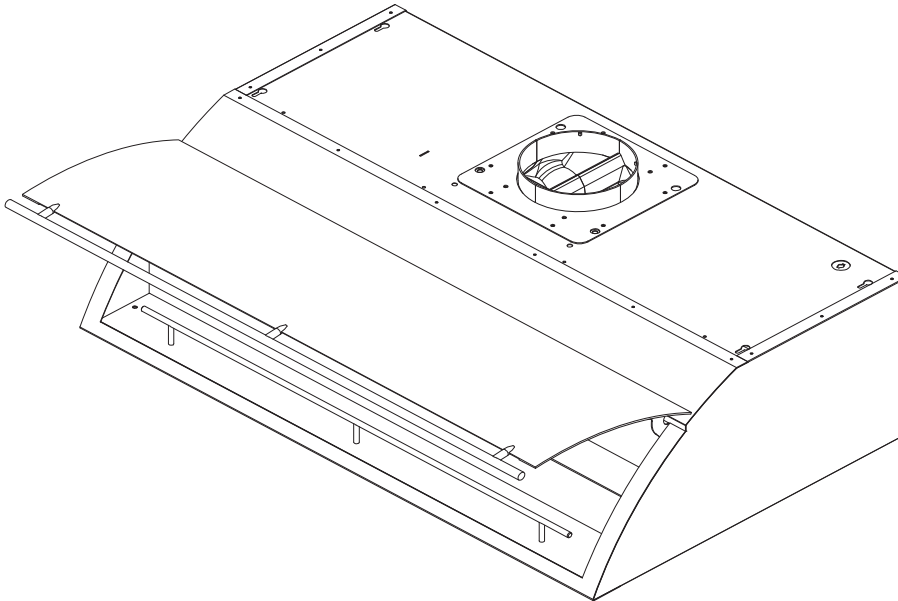

Model number: _____
Serial Number: _____
Date of Purchase: _____
Sales Dealer: _____

NOV12.0301 © Zephyr Corporation

READ AND SAVE THESE INSTRUCTIONS

SAFETY NOTICE 2-3

LIST OF MATERIALS 4

INSTALLATION

 Ducting Calculation Sheet 5

 Mounting Height & Clearance 6

 Ducting Options 7

 Hood Specifications 8

 Preparing the Electrical Wires 9

 Internal Blower (Vertical Ducting) 10-11

 Internal Blower (Horizontal Ducting) 12-13

 External Blower Preparation 14

 Mounting the Range Hood 15

FEATURES & CONTROLS

 Touch Controls 16

 Features 17

MAINTENANCE

 Cleaning and Installing Filters 18

 Lights 19

TROUBLESHOOTING 20

Important Safety Notice

WARNING

TO REDUCE THE RISK OF FIRE OR ELECTRIC SHOCK, DO NOT USE THIS FAN WITH ANY SOLID-STATE CONTROL DEVICE.

WARNING

TO REDUCE THE RISK OF FIRE ELECTRIC SHOCK, OR INJURY TO PERSONS, OBSERVE THE FOLLOWING:

- a. Use this unit only in the manner intended by the manufacturer, if you have questions, contact the manufacturer.
- b. Before servicing or cleaning unit, switch power off at service panel and lock panel to prevent power from being switched on accidentally. When the service disconnecting means cannot be locked, securely fasten a prominent warning device, such as a tag, to the service panel.

CAUTION

For general ventilating use only. Do not use to exhaust hazardous or explosive materials and vapors. Take care when using cleaning agents or detergents. Suitable for use in household cooking area.

WARNING

TO REDUCE THE RISK OF RANGE TOP GREASE FIRE:

- a. Never leave surface units unattended at high settings. Boilovers cause smoking and greasy spillovers that may ignite. Heat oils slowly on low or medium settings.
- b. Always turn hood ON when cooking at high heat or when flaming food
- c. Clean ventilating fans frequently. Grease should not be allowed to accumulate on fan or filter.
- d. Use proper pan size. Always use cookware appropriate for the size of the surface element.
- e. Keep fan, filters and grease laden surfaces clean.
- f. Use high setting on hood only when necessary.
- g. Don't leave hood unattended when cooking.
- h. Always use cookware and utensils appropriate for the type of and amount of food being prepared.

WARNING

TO REDUCE THE RISK OF INJURY TO PERSONS IN THE EVENT OF A RANGE TOP FIRE, OBSERVE THE FOLLOWING:

- a. SMOTHER FLAMES with a close-fitting lid, cookie sheet, or metal tray, then turn off the burner. BE CAREFUL TO PREVENT BURNS. If the flames do not go out immediately, EVACUATE AND CALL THE FIRE DEPARTMENT.
- b. NEVER PICK UP A FLAMING PAN – You may be burned.
- c. DO NOT USE WATER, including wet dishcloths or towels – a violent steam explosion will result.
- d. Use an extinguisher ONLY if:
 - 1. You know you have a Class ABC extinguisher, and you already know how to operate it.
 - 2. The fire is small and contained in the area where it started.
 - 3. The fire department is being called.
 - 4. You can fight the fire with your back to an exit

WARNING

TO REDUCE THE RISK OF FIRE, ELECTRIC SHOCK OR INJURY TO PERSONS, OBSERVE THE FOLLOWING:

- a. Installation work and electrical wiring must be done by qualified person (s) in accordance with all applicable codes and standards. Including fire-rated construction.
- b. Sufficient air is needed for power combustion and exhausting of gases through the flue (chimney) of fuel burning equipment to prevent back-drafting. Follow the heating equipment manufacturer's guideline and safety standards such as those published by the National Fire Protection Association (NFPA) and the American Society for Heating, Refrigeration and Air Conditioning Engineers (ASHRAE) and the local code authorities.
- c. When cutting or drilling into wall or ceiling, do not damage electrical wiring and other hidden utilities.
- d. Ducted fans must always vent to the outdoors.
- e. If this unit is to be installed over a tub or shower, it must be marked as appropriate for the application and be connected to a GFCL (Ground Fault Interrupter protected branch circuit).
- g. NEVER place a switch where it can be reached from a tub or shower.
- h. Make sure the power is off before installing, wiring or maintenancing.

CAUTION

To reduce the risk of fire and electric shock, install this range hood only with external blower models CBE-1000, rated maximum 6.2 amps, 120V AC 60Hz or internal blowers manufactured by Zephyr Ventilation, models CBI-600A.

WARNING

TO REDUCE THE RISK OF FIRE, USE ONLY METAL DUCTWORK.

CAUTION

To reduce risk of fire and to properly exhaust air outside - Do not vent exhaust air into spaces within walls, ceilings, attics, crawl spaces or garages.

WARNING

TO REDUCE THE RISK OF SHOCK, THIS FAN MUST BE INSTALLED WITH AN ISOLATING WALL CONTROL/ SWITCH.

OPERATION

Always leave safety grills and filters in place. Without these components, operating blowers could catch onto hair, fingers and loose clothing.

*NOTE: Please check www.zephyronline.com or call us for revisions before doing any custom work.

ELECTRICAL REQUIREMENTS

Important:

Observe all governing codes and ordinances.

It is the customer's responsibility:

- To contact a qualified electrical installer.
- To assure that the electrical installation is adequate and in conformance with National Electrical Code, ANSI/NFPA 70 latest edition* or CSA standards C22.1-94, Canadian Electrical Code, Part 1 and C22.2 No.0-M91 - latest edition** and all local codes and ordinances.

If codes permit and a separate ground wire is used, it is recommended that a qualified electrician determine that the ground path is adequate.

Do not ground to a gas pipe.

Check with a qualified electrician if you are not sure the range hood is properly grounded.

Do not have a fuse in the neutral or ground circuit.

*National Fire Protection Association Batterymarch Park, Quincy, Massachusetts 02269

** CSA International 8501 East Pleasant Valley Road, Cleveland, Ohio 44131-5575

This appliance requires a 120V 60Hz electrical supply and connected to an individual properly grounded branch circuit protected by a 15 or 20 ampere circuit breaker or time delay fuse. Wiring must be 2 wire with ground. Please also refer to Electrical Diagram on product.

A cable locking connector (not supplied) might also be required by local codes. Check with local requirements, purchase and install appropriate connector if necessary.

List of Materials

MODEL: CCA-E30ASX, CCA-E36ASX, CCA-E48ASX

- 1 - Hood
- 2 - Baffle filters (3) for 48" model
- 2 - Halogen light bulbs (4) for 48" model
- 1 - 6" round top mounting plate
- 1 - Solid top mounting plate
- 1 - Rectangular starting collar
- 1 - Round to rectangular adapter
- 2 - Blower brackets
- 1 - 8" round top mounting plate
- 1 - External blower wiring harness
- 1 - Hardware packet



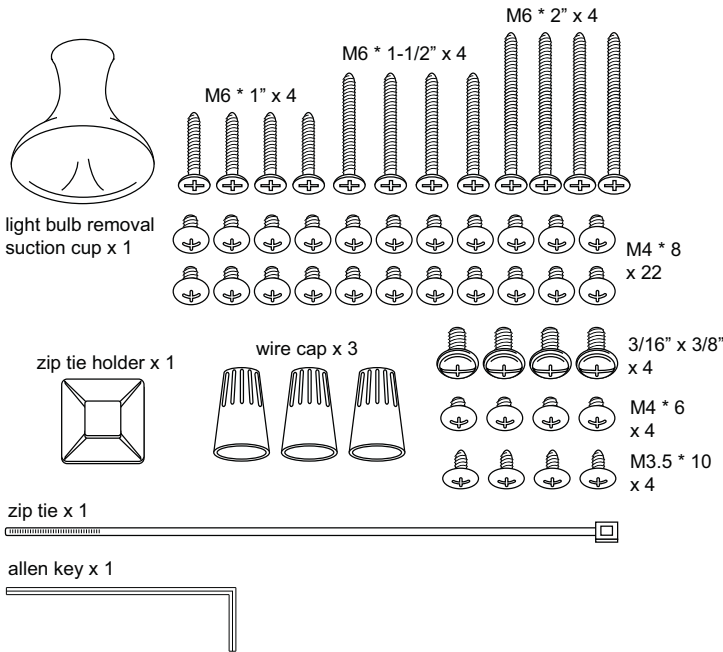



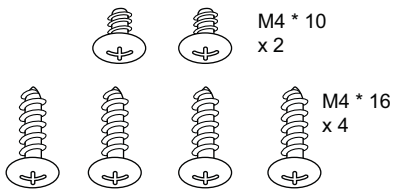

Cache Hardware Packet Contents

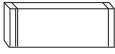

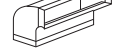

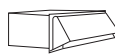





CBI-600A Hardware

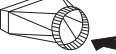

Installation – Ducting Calculation Sheet

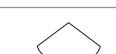
Duct pieces		Equivalent number length x used =	Total
	3-1/4" x 10" Rect., straight	1 Ft. x () =	Ft.
	7" Round, straight	1 Ft. x () =	Ft.
	8" Round, straight	1 Ft. x () =	Ft.
	3-1/4" x 10" Rect. 90° elbow	15 Ft. x () =	Ft.
	3-1/4" x 10" Rect. 45° elbow	9 Ft. x () =	Ft.
	3-1/4" x 10" Rect. 90° flat elbow	24 Ft. x () =	Ft.
	3-1/4" x 10" Rect. wall cap with damper	30 Ft. x () =	Ft.
	3-1/4" x 10" Rect. to 6" round transition	5 Ft. x () =	Ft.
	3-1/4" x 10" Rect. to 6" round transition 90° elbow	15 Ft. x () =	Ft.
	6" Round, 90° elbow	15 Ft. x () =	Ft.
	6" Round, 45° elbow	9 Ft. x () =	Ft.
Subtotal column 1 =			Ft.

Duct pieces		Equivalent number length x used =	Total
	6" - 8" Round wall cap with damper	30 Ft. x () =	Ft.
	6" - 8" Round, roof cap	30 Ft. x () =	Ft.
	6" round to 3-1/4" x 10" rect. transition	1 Ft. x () =	Ft.
	6" round to 3-1/4" x 10" rect. transition 90° elbow	16 Ft. x () =	Ft.
	7" or 8" Round, 90° elbow	15 Ft. x () =	Ft.
	7" or 8" Round, 45° elbow	9 Ft. x () =	Ft.
	7" or 8" Round wall cap with damper	30 Ft. x () =	Ft.
	7" or 8" Round, roof cap	30 Ft. x () =	Ft.
	7" round to 3 1/4" x 10" rect. transition	8 Ft. x () =	Ft.
	7" round to 3-1/4" x 10" rect. transition 90° elbow	15 Ft. x () =	Ft.
Subtotal column 2 =			Ft.
Subtotal column 1 =			Ft.
Total ductwork =			Ft.

Maximum Duct Length: For satisfactory air movement, the total duct length of a 3 1/4" x 10" rectangular 6", 7" or 8" diameter round duct should not exceed 100 equivalent feet.

Installation – Mounting Height & Clearance

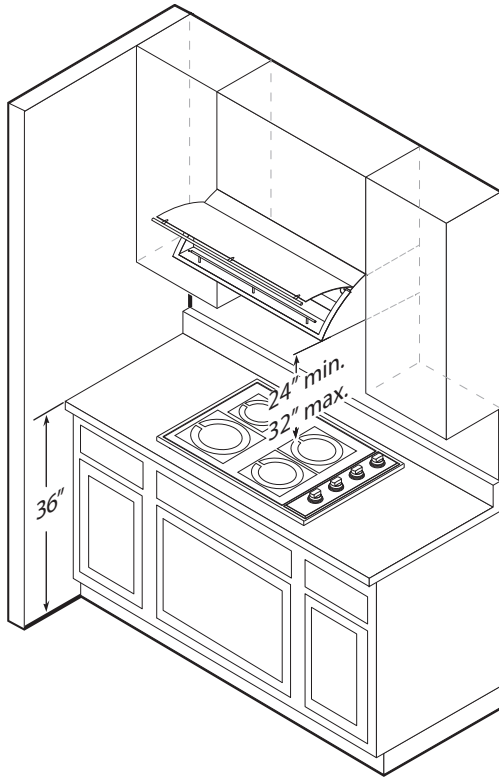

Minimum mount height between range top and hood bottom should be no less than 24”.

Maximum mount height should be no higher than 32”.

It is important to install the hood at the proper mounting height. Hoods mounted too low could result in heat damage and fire hazard; while hoods mounted too high will be hard to reach and will lose its performance and efficiency.

If available, also refer to range manufacturer’s height clearance requirements and recommended hood mounting height above range.

Vertical Ducting:

6” round minimum (internal blower)
10” to 8” round minimum (external blower)

Horizontal Ducting:

3-1/4”x10” minimum (internal blower)
No horizontal option available for external blower

DUCTING

A minimum of 6” round or 3-1/4” x 10” rectangular duct work must be used to maintain maximum air flow efficiency with the 600 cfm internal blower. A minimum of 10” to 8” round duct work must be used with the 1000 cfm external blower.

Always use rigid type metal ducts only. Flexible ducts could restrict air flow by up to 50%.

Use calculation (on page 5) to compute total available duct run when using elbows, transitions and caps.

ALWAYS, when possible, reduce the number or transitions and turns. If long duct run is required, increase duct size from 6” to 7 or 8”. If a reducer is used, install a long reducer instead of a pancake reducer. Reduce duct size as far away from opening as possible.

If turns or transitions are required; install as far away from opening and as far apart, between 2, as possible.

DAMAGE-SHIPMENT / INSTALLATION:

- Please fully inspect unit for damage before installation.
- If the unit is damaged in shipment, return the unit to the store in which it was bought for repair or replacement.
- If the unit is damaged by the customer, repair or replacement is the responsibility of the customer.
- If the unit is damaged by the installer (if other than the customer), repair or replacement must be made by arrangement between customer and installer.

WARNING FIRE HAZARD

NEVER exhaust air or terminate duct work into spaces between walls, crawl spaces, ceiling, attics or garages. All exhaust must be ducted to the outside.

Use metal ductwork only.

Fasten all connections with sheet metal screws and tape all joints with certified Silver Tape or Duct Tape.

Some Ducting Options

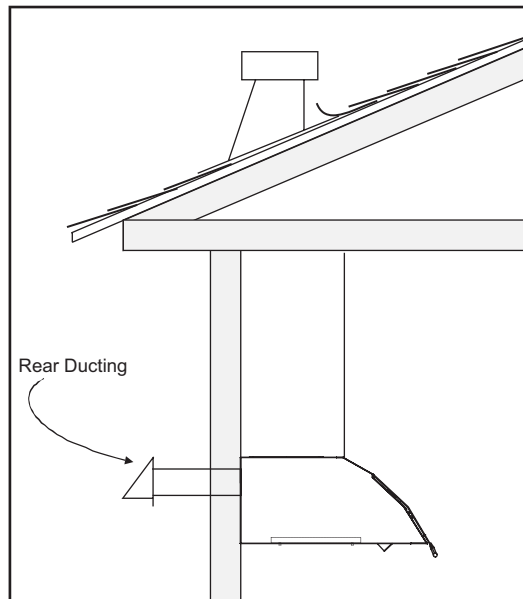
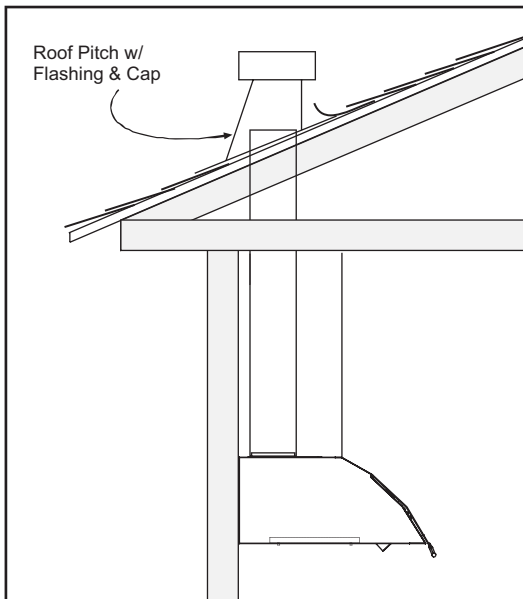
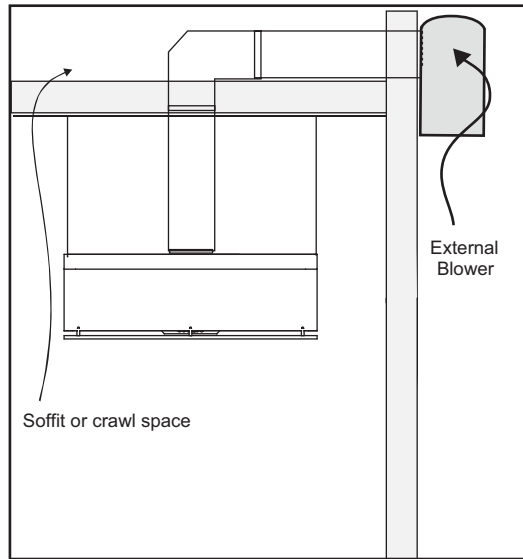
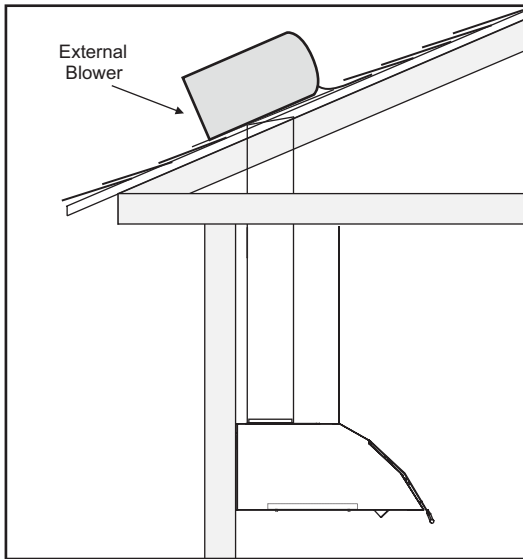

Installation – Hood Specifications

Front View

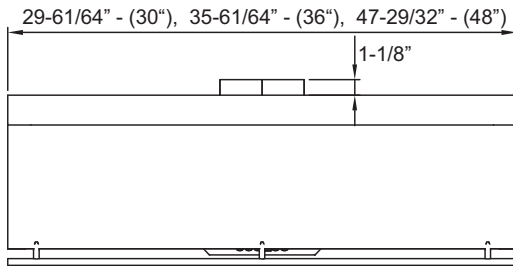

Back View

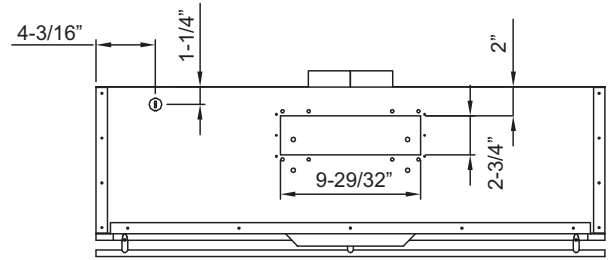

Top View

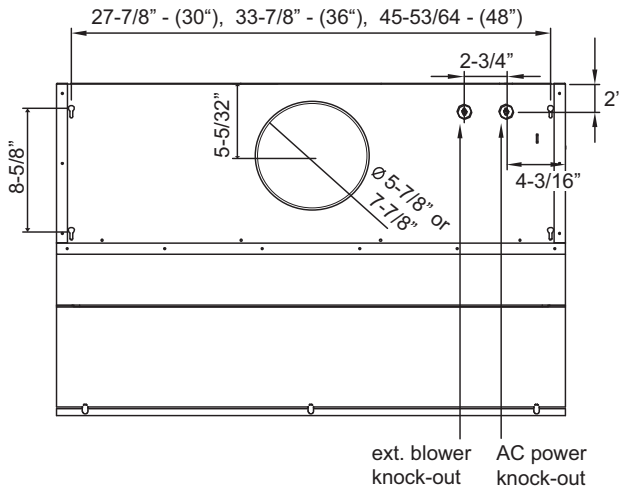

Side View

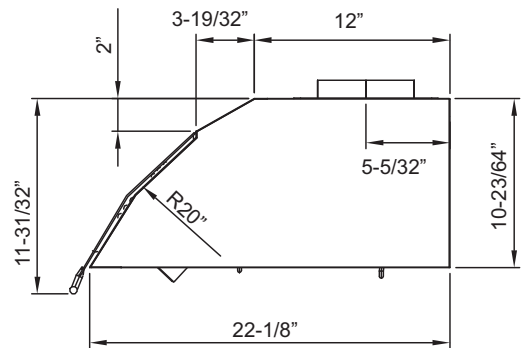

**ELECTRICAL
WARNING**

All Electrical work must be performed by qualified electrician or person with similar technical know how and background.

For personal safety, remove house fuse or open circuit breaker before beginning installation. Do not use extension cord or adapter plug with this appliance.

Follow national electrical codes or prevailing local codes and ordinances.

Electrical Supply:

This appliance requires a 120V 60Hz electrical supply, and connected to an individual, properly grounded branch circuit, protected by a 15 or 20 ampere circuit breaker or time delay fuse. Wiring must be 2 wire w/ ground. Please also refer Electrical Diagram labeled on product.

Cable Lock:

A cable locking connector (not supplied) might also be required by local codes. Check with local requirements and codes, purchase and install appropriate connector if necessary.

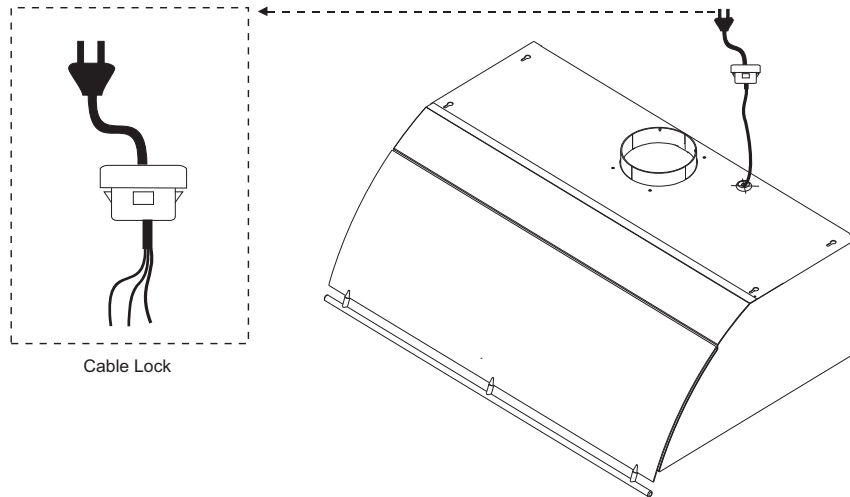

Installation – Internal Blower (Vertical Ducting)

INTERNAL BLOWER PREPARATION – VERTICAL DUCTING

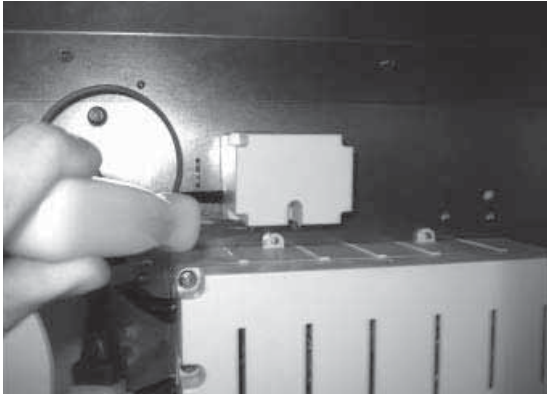

1. Attach capacitor box to inside of hood using two M4*10 screws included with internal blower.

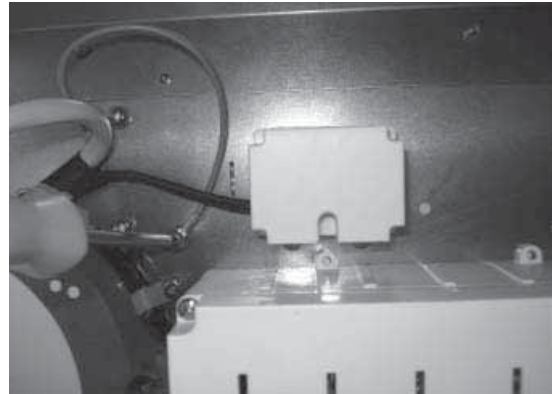

2. Attach green ground wire to ground screw on hood.

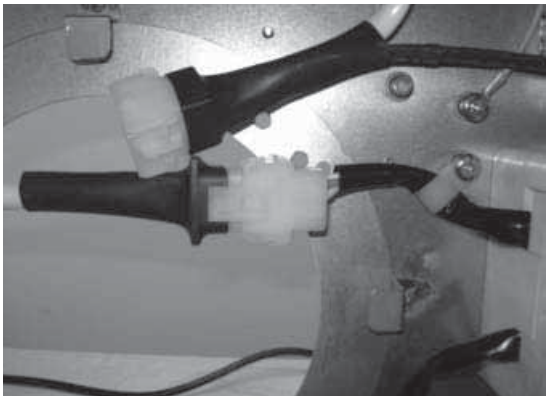

3. Connect 6 pin male connector from capacitor box to 6 pin female connector on control board box.

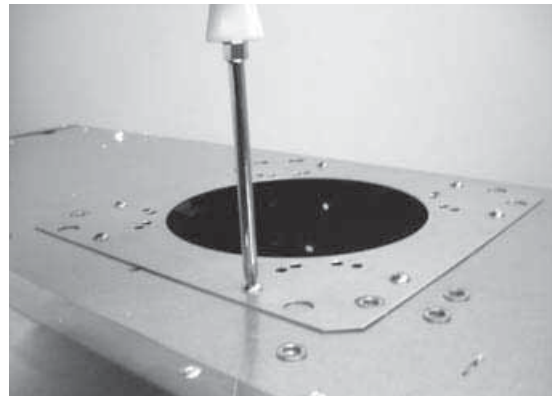

4. Place 6" round mounting plate on top of hood and secure using eight M4*8 screws.

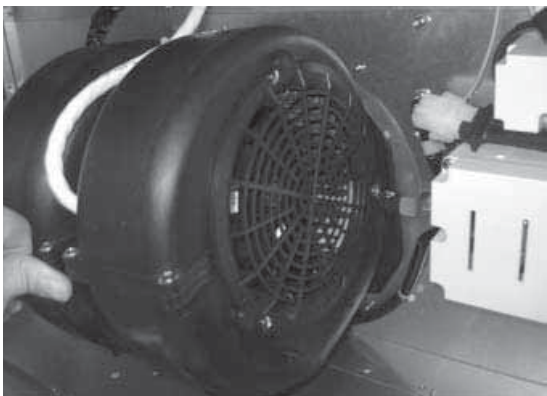

5. Install internal blower into hood.

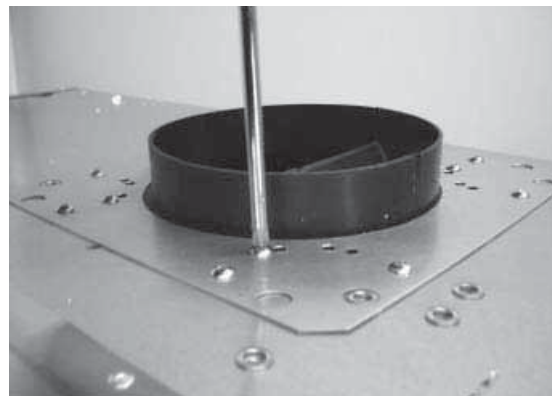

6. Secure internal blower to hood using four M4*16 screws included with internal blower.

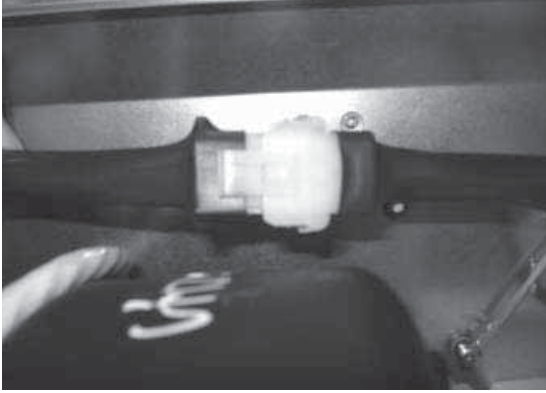

7. Connect 9 pin male connector from blower to 9 pin female connector on capacitor box.

Installation – Internal Blower (Horizontal Ducting)

INTERNAL BLOWER PREPARATION – HORIZONTAL DUCTING

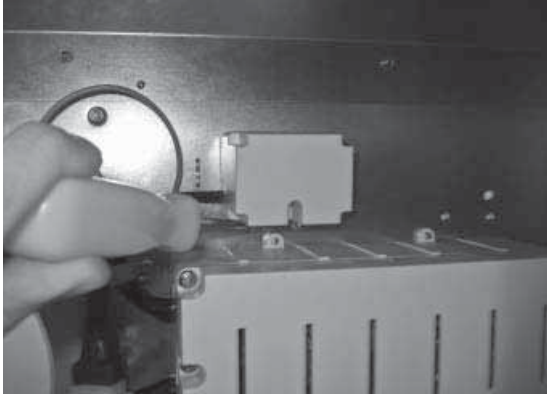

1. Attach capacitor box to inside of hood using two M4*10 screws included with internal blower.

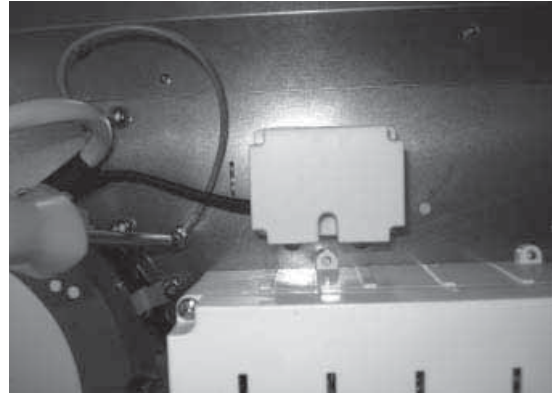

2. Attach green ground wire to ground screw on hood.

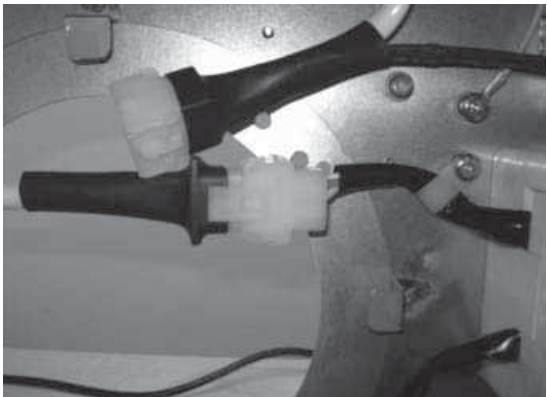

3. Connect 6 pin male connector from capacitor box to 6 pin female connector on control board box.



4. Place solid mounting plate on top of hood and secure using eight M4*8 screws.

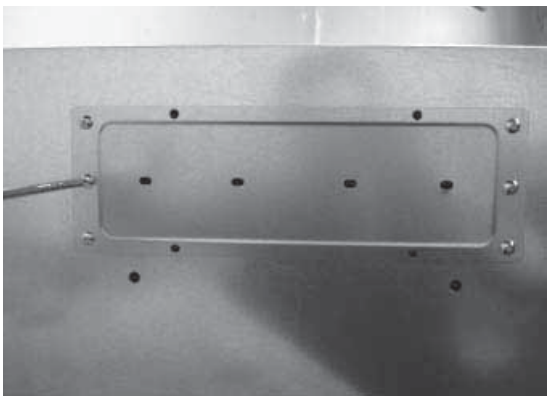

5. Remove rectangular cap from back of hood. Place six M4*8 screws aside for later use.

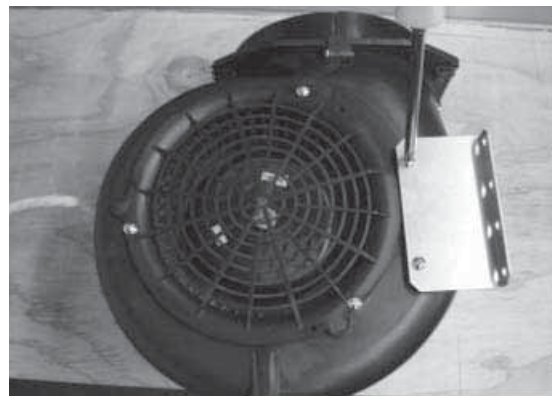

6. Attach blower brackets to blower as shown above using two M3.5*10 screws for each bracket. There are two brackets total, one for each side of the blower. NOTE: Drilled flange of both blower brackets faces away from the blower casing.

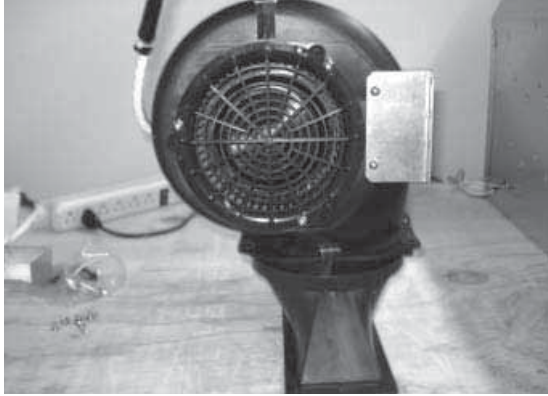

7. Place blower over round to rectangular adapter as shown above.

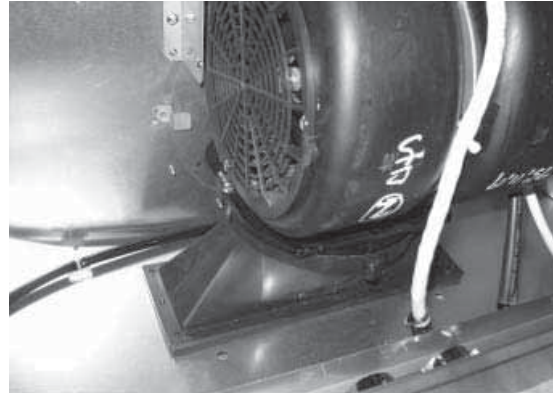

8. Install blower with round to rectangular adapter into hood.

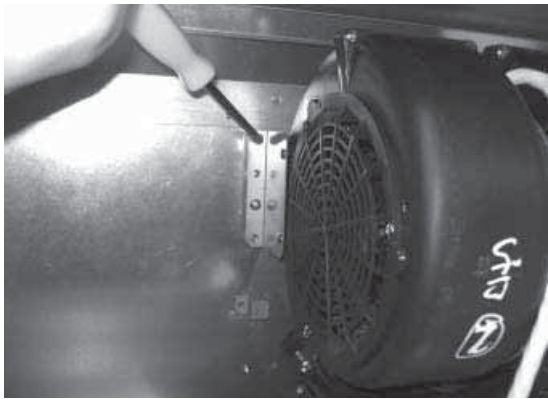

9. Mount blower brackets to hood using two 3/16" * 3/8" screws for each bracket. Screws are included with internal blower.

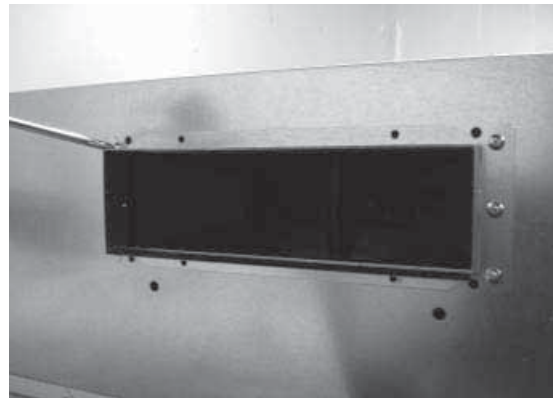

10. Install rectangular starting collar to back of hood using six M4*8 screws recently removed from rectangular cap (three screws on each side).

Install four additional M4*8 screws in the top and bottom middle of rectangular starting collar. Check and verify inner adapter is firmly secured.

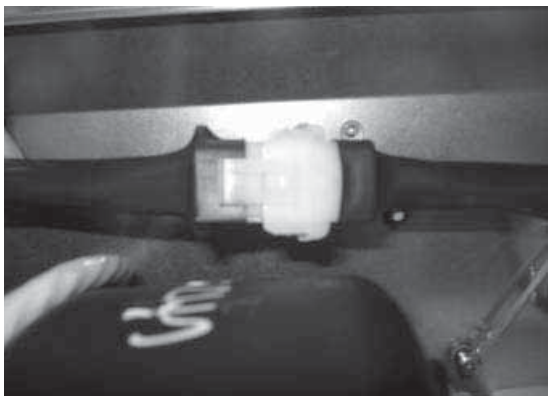

11. Connect 9 pin male connector from blower to 9 pin female connector on control board box.

Installation – Internal Blower (Horizontal Ducting)

EXTERNAL BLOWER PREPARATION

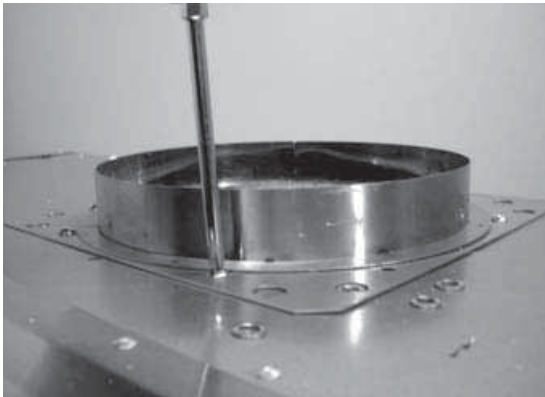

1. Place 8" round mounting plate on top of hood and secure using eight M4*8 screws.

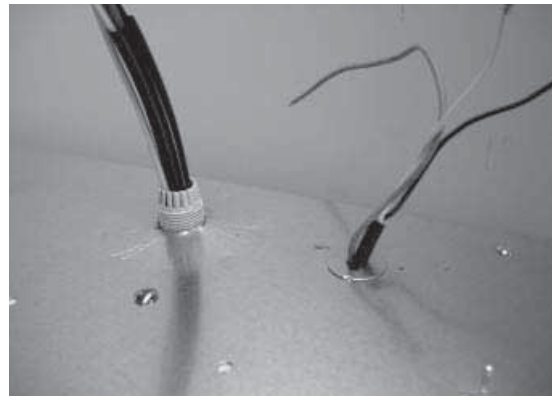

2. Install threaded cable lock and external blower wiring through the knockout next to the electrical wiring knockout.



3. Place cap over threaded cable lock and secure by turning cap clockwise. **NOTE:** Due to the size of the cap, it may be easier to install it after the hood has been mounted.



4. Connect 6 pin male connector from external blower wiring to 6 pin female connector on control board box. Attach green ground wire from external wiring to ground screw on hood.

NOTE: For instructions on mounting the external blower please refer to the CBE-1000 external blower manual included in the external blower packaging or on our website. www.zephyronline.com

Hood is designed for installation under a kitchen cabinet

1. Select preferred duct location (internal blower - vertical or horizontal, external blower - vertical only).
2. Begin installation by removing the baffle filters.
3. Reinforce cabinet with 1" x 2" wood strips if additional strengthening is required. Must be placed inside frameless cabinets.
4. Temporarily position the range hood in the desired mounting location. Measure and mark the mounting holes, duct and electrical locations with a pencil.
NOTE: If using an internal blower a 6" round duct opening is necessary. If using an external blower an 8" round opening is necessary.
5. Drill/cut out the required openings for duct and electrical access; make sure the duct opening is large enough to apply duct tape.
NOTE: If installing an external blower, cut out a minimum 1-1/2" opening for the external blower wires to pass through. Refer to page 8 for specifications.
6. Fasten hood onto cabinet with screws provided.
7. Install electrical.
8. Install duct work and seal with duct tape.
9. Reinstall baffle filters.
10. Power up hood and check for leaks around duct tape.

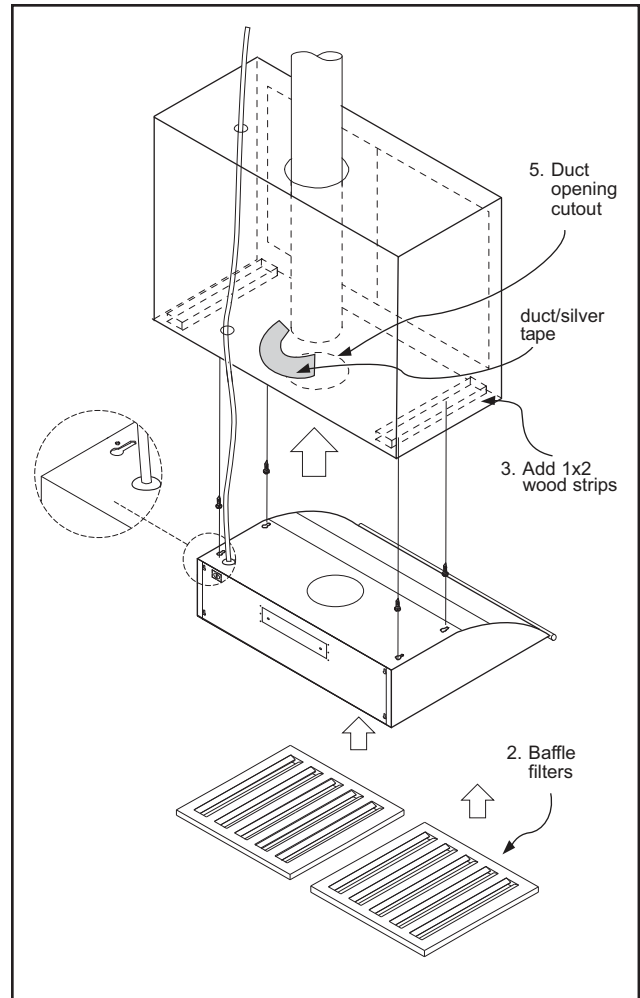

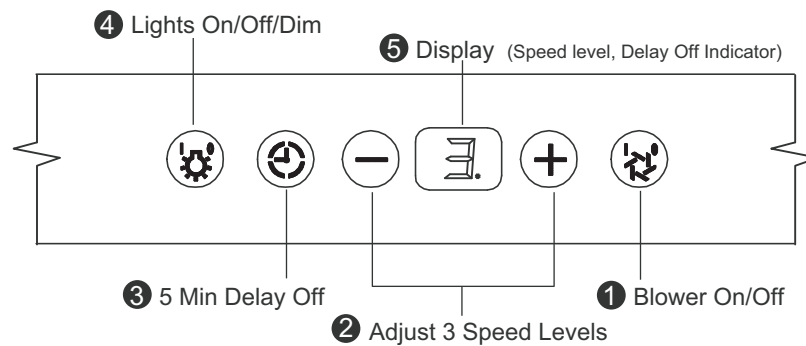

Installation – Mounting the Range Hood





1 Blower On/Off

By pressing , the blower is switched On and Off. When switched on, the blower starts up on the same speed it was turned off at. When switched off the entire hood powers off, including the lights.

2 Speed Selection

The 3 speed levels are selected by pressing  to decrease and  to increase speed level. The display indicates level selected. Pressing  when the hood is off will also turn it on.

3 Delay Off

This is used for programmed shut down of blower and lights 5 minutes after the function is activated. Press  once, a dot displays in the lower right hand side of display  indicating the function is on. The hood will change to speed 1 and shut down after 5 minutes.

4 Lights On/Off/ Dim

Switch lights On and Off by pressing  once. To dim lights, press  again.

Baffle Filter Clean Reminder

After every 30 hours of use the display will start flashing an  reminding you to clean the baffle filters from residue and possible clogs.

Clean Air Feature

Clean Air is a feature that turns the blower on every 4 hours for 10 minutes to remove stagnant air in the kitchen. This feature is disabled by default and must be enabled by the user.

Baffle Filter Clean Reminder

Whether your hood is installed as an exhaust or purifying unit, a set of baffle filters are fitted by the factory. These baffle filters are intended to filter out residue from cooking. They need not be replaced on a regular basis but are required to be kept clean. The filter clean reminder function in the microprocessor will automatically indicate by a flashing  when the baffle filters need to be cleaned after every 30 hours of use. Filters can be cleaned by hand with non-abrasive soap or in a dishwasher. Heavily soiled filters should also be soaked in grease cutting detergent prior to cleaning.

Baffle Filter Clean Indicator



When  flashes on display, the baffle filters installed are required to be cleaned. This will occur after every 30 hours of use.

Clean Filters

display < F > flashes



Re-setting Function



Reset the filter clean reminder timer when filters are cleaned and re-installed (with hood off). Press and hold  for approximately 5 seconds, the display will appear; hold for approximately 5 seconds until  on display disappears . The filter clean reminder function is now reset and a new 30 hours elapse cycle is initiated.

To Reset



hold 5 sec. display from < F > to < >



Clean Air Feature

Clean Air is a feature that turns the fan on every 4 hours for 10 minutes to remove stagnant air in the kitchen. This feature is disabled by default and must be enabled by the user. When the clean air function is enabled, the blower will turn on speed 1, the display will flash between  and  until the 10 minute cycle has elapsed and the blower shuts down.

To enable Clean Air Feature



With hood off, press and hold  for approximately 5 seconds until the display shows  then .

To Enable

hold 5 sec. display from < - > to < A >



To disable Clean Air Feature

With hood off, press and hold  for approximately 5 seconds until the display shows  then .

To Disable

hold 5 sec. display from < A > to < - >



SURFACE MAINTENANCE:

Clean periodically with hot soapy water and clean cotton cloth. Do not use corrosive or abrasive detergent, or steel wool/scoring pads which will scratch and damage surface.

For heavier soil use liquid degreaser.

After cleaning, you may use non-abrasive stainless steel polish/ cleaners, to polish and buff out the stainless luster and grain. Always scrub lightly using a micro fiber or clean cotton cloth and with the stainless steel grain.

Stainless Steel Baffle Filters

The stainless steel baffle filters fitted by the factory are intended to trap residue and grease from cooking. Although the filters never need replacement, they are required to be cleaned every 30 - 60 days or more often depending on cooking habits.

Filters may be placed in dishwasher at low heat or soaked in hot soapy water.

Installing Baffle Filters

1. Insert filter in metal groove on bottom of hood. Push filter towards back of hood using handles.
2. Pivot front of filter upward until it is flush with the hood.
3. Lock filter in place by pulling away from hood.

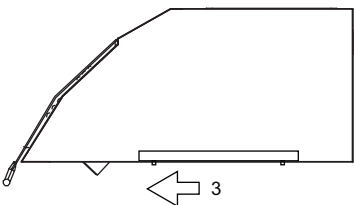
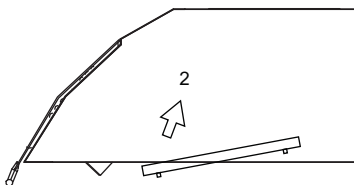
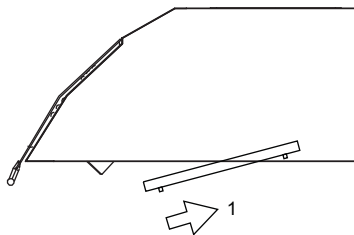

Removing Baffle Filters

1. Pull filter toward back of range hood using handles.
2. Pivot front of filter upward.
3. Remove downwards to the rear.

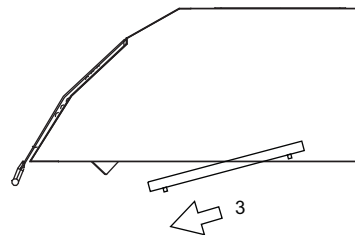
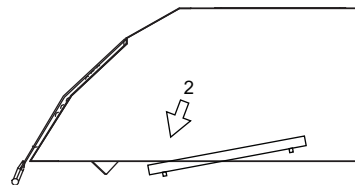
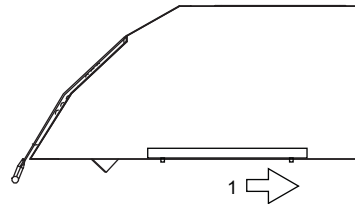

REPLACING LIGHT BULBS

CAUTION: Light bulb becomes extremely hot when turned on.

DO NOT touch bulb until switched off and cooled. Touching hot bulbs could cause serious burns.

Make sure all power is turned off and bulbs are not hot.

Remove by turning bulb counter clockwise.

Note: Bulb does not unscrew; it turns 60 degrees, stops and falls out.

If bulbs are difficult to turn due to prolonged use, firmly attach the provided glass suction cup and turn. You may also use a rubber/latex glove to grip the bulb with the palm of your hand and turn.

Replacement bulbs are available on our website, part number Z0B0020. (GU10 120V 50W.)

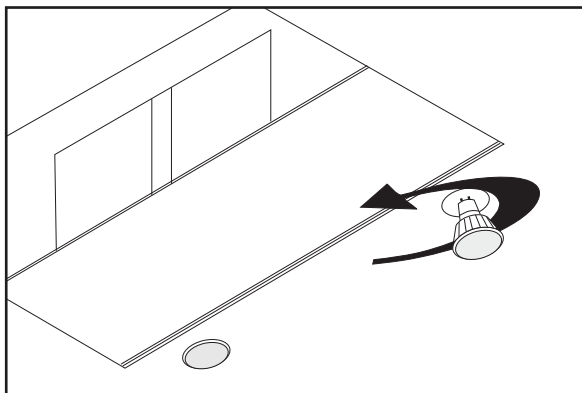

Troubleshooting

TROUBLESHOOTING PROCEDURES FOR CACHE

Issue	Cause	What to do
After installation, the unit doesn't work.	1. The power source is not turned ON.	1. Make sure the circuit breaker and the unit's power is ON.
	2. The power line and the cable locking connector is not connecting properly.	2. Check the power connection with the unit is connected properly.
	3. The switch board and control board wirings are disconnected.	3. Make sure the wirings between the switch board and control board are connected properly.
	4. The switch board or control board is defective.	4. Change the switch board or control board.
Light works, but blower is not turning.	1. Wire harness from external or internal blower might be disconnected.	1. Make sure the wires are connected to the control board box
	2. Blower molex plug pin is not making contact.	2. Disconnect the blower molex plug, check pins inside plug to see if pin is pushed inside the plug too far. Reseat pin if needed.
	3. The blower is defective, possibly seized.	3. Change the blower.
	4. The thermally protected system detects if the blower is too hot to operate and shuts the blower down.	4. The blower will function properly after the thermally protected system cool down.
	5. Damaged capacitor.	5. Change the capacitor.
The unit is vibrating.	1. The blower is not secure in place.	1. Tighten the blower in place.
	2. Damaged blower wheel/makes noise.	2. Change the blower.
	3. The hood is not secured in place.	3. Check the installation of the hood.
The unit is whistling.	1. A filter is not in the correct position.	1. Adjust the filters until the whistling stops.
	2. The duct pipe connections are not sealed or connected properly.	2. Check the duct pipe connections to be sure all connections are sealed properly.
The blower is working, but the lights are not.	1. The light socket plug is disconnected.	1. Connect the light socket plug.
	2. Defective halogen bulb.	2. Change the halogen bulb.
	3. The light bulb is loose.	3. Tighten the light bulb and make sure it's secure.
The hood is not venting out properly.	1. The hood might be hanging to high from the cook top.	1. Adjust the distance between the cook top and the bottom of the hood within 24" and 32" range.
	2. The wind from the opened windows or opened doors in the surrounding area are affecting the ventilation of the hood.	2. Close all the windows and doors to eliminate the outside wind flow.
	3. Blocking in the duct opening or ductwork.	3. Remove all the blocking from the duct work or duct opening.
	4. There are too many turns within the ducting.	4. Limit number of turns and/or increase duct size.
	5. Using the wrong size of ducting.	5. Change the ducting to at least 6" or higher for the internal blower and 8" or higher for the external blower.
Filter is vibrating.	1. Baffle filter is loose.	1. Remove filter and reinstall it or change the baffle filter
After hood has been installed for a period of time, it stopped working.	1. Control board needs to be reset.	1. Turn circuit breaker which controls the hood off for at least 15 minutes. Turn it back on and this should fix the problem.
	2. Defective control board.	2. Replace control board.

ZEPHYR

Limited Warranty

STAPLE YOUR RECEIPT HERE
Proof of the original purchase
date is needed to obtain
service under warranty

TO OBTAIN SERVICE UNDER WARRANTY OR FOR ANY SERVICE RELATED QUESTIONS, please call:
1-888-880-8368

Zephyr Corporation (referred to herein as “we” or “us”) warrants to the original consumer purchaser (referred to herein as “you” or “your”) of Zephyr products (the “Products”) that such Products will be free from defects in materials or workmanship as follows:

Two Year Limited Warranty for Parts: For two years from the date of your original purchase of the Products, we will provide, free of charge, Products or parts to replace those that failed due to manufacturing defects. We may choose, in our sole discretion, to repair or replace parts before we elect to replace the Products.

One Year Limited Warranty for Labor: For one year from the date of your original purchase of the Products, we will provide, free of charge, the labor cost associated with repairing the Products or parts to replace those that failed due to manufacturing defects. After the first year from the date of your original purchase, you are responsible for all labor costs associated with this warranty.

Warranty Exclusions: This warranty covers only repair or replacement, at our option, of defective Products or parts and does not cover any other costs related to the Products including but not limited to: (a) normal maintenance and service required for the Products and consumable parts such as light bulbs, metal and carbon filters and fuses; (b) any Products or parts which have been subject to freight damage, misuse, negligence, accident, faulty installation or installation contrary to recommended installation instructions, improper maintenance or repair (other than by us); (c) commercial use of the Products or use otherwise inconsistent with its intended purpose; (d) natural wear of the finish of the Products or wear caused by improper maintenance, use of corrosive and abrasive cleaning products, pads, and oven cleaner products; (e) chips, dents or cracks caused by abuse or misuse of the Products; (f) service trips to your home to teach you how to use the Products; or (g) damage to the Products caused by accident, fire, floods or act of God. If you are outside our service area, additional charges may apply for shipping costs for warranty repair at our designated service locations and for the travel cost to have a service technician come to your home to repair, remove or reinstall the Products. After the first year from the date of your original purchase, you are also responsible for all labor costs associated with this warranty.

Limitations of Warranty. OUR OBLIGATION TO REPAIR OR REPLACE, AT OUR OPTION, SHALL BE YOUR SOLE AND EXCLUSIVE REMEDY UNDER THIS WARRANTY. WE SHALL NOT BE LIABLE FOR INCIDENTAL, CONSEQUENTIAL OR SPECIAL DAMAGES ARISING OUT OF OR IN CONNECTION WITH THE USE OR PERFORMANCE OF THE PRODUCTS. THE EXPRESS WARRANTIES IN THE PRECEDING SECTION ARE EXCLUSIVE AND IN LIEU OF ALL OTHER EXPRESS WARRANTIES. WE HEREBY DISCLAIM AND EXCLUDE ALL OTHER EXPRESS WARRANTIES FOR THE PRODUCTS, AND DISCLAIM AND EXCLUDE ALL WARRANTIES IMPLIED BY LAW, INCLUDING THOSE OF MERCHANTABILITY AND FITNESS FOR A PARTICULAR PURPOSE. Some states or provinces do not allow limitations on the duration of an implied warranty or the exclusion or limitation of incidental or consequential damages, so the above limitations or exclusions may not apply to you. To the extent that applicable law prohibits the exclusion of implied warranties, the duration of any applicable implied warranty is limited to the same two-year period described above. Any oral or written description of the Products is for the sole purpose of identifying the Products and shall not be construed as an express warranty. Prior to using, implementing or permitting use of the Products, you shall determine the suitability of the Products for the intended use, and you shall assume all risk and liability whatsoever in connection with such determination. We reserve the right to use functionally equivalent refurbished or reconditioned parts or Products as warranty replacements or as part of warranty service. This warranty is not transferable from the original purchaser and applies in the United States and Canada.

To Obtain Service Under Limited Warranty: To qualify for warranty service, you must: (a) notify us at the address or telephone number stated below within 60 days of the discovery of the defect; (b) give the model number and part identification number and serial number; and (c) describe the nature of any defect in the Product or part. At the time of the request for warranty service, you must present evidence of your proof of purchase and proof of the original purchase date. If we determine that the warranty exclusions listed above apply or if you fail to provide the necessary documentation to obtain service, you will be responsible for all shipping, travel, labor and other costs related to the services.

Please check our website for any revisions, www.zephyronline.com.

Zephyr Corporation Service Department, 2277 Harbor Bay Parkway, Alameda, CA 94502 1-888-880-8368