

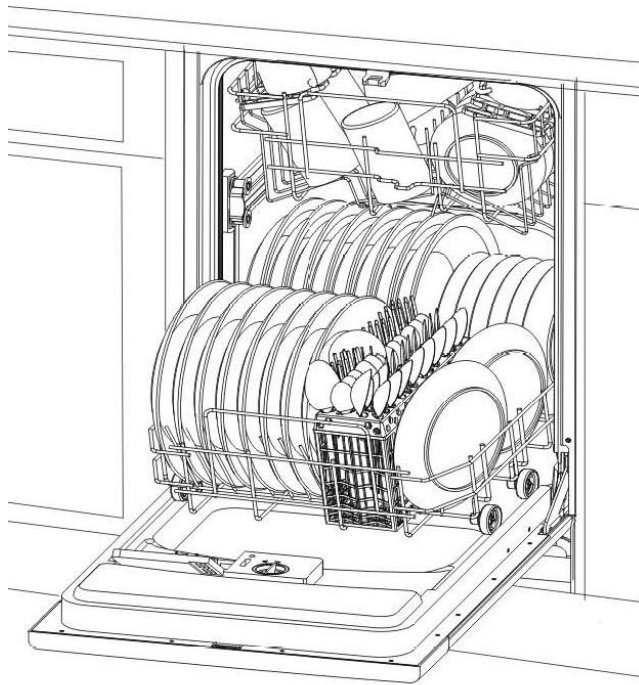

**DISHWASHER / LAVAPLATOS  
INSTRUCTION MANUAL / MANUAL DE INSTRUCCIONES**

Model Numbers / Números de Modelos: DWE1812W / DWE1813B /  
DWE1814SS



**BEFORE USE, PLEASE READ AND FOLLOW ALL SAFETY RULES AND OPERATING INSTRUCTIONS.**

La sección en español empieza en la página 18.

Avanti has a policy of continuous improvement on its products and reserves the right to change materials and specifications without notice.

---

**Avanti Products, A Division of The Mackle Co., Inc.  
P.O. Box 520604 - Miami, Florida 33152  
[www.avantiproducts.com](http://www.avantiproducts.com)**

---



## TABLE OF CONTENTS

Help Us Help You	5
Parts and Features	6
Important Safety Instructions	7
Electrical Connection	7
Water Heater Safety	8
Before Using Your Dishwasher	8
Control Panel	9
Wash Cycle Descriptions	9
Overflow Protection	10
Using the Detergent Dispenser	10
Using the Rinse Aid Dispenser	10 – 11
How to Efficiently Load Your Dishwasher	11 – 12
Starting, Modifying and Canceling the Wash Cycle	12
Filtering System	12
Caring and Maintenance	13
Cleaning the Spray Arms	13
Cleaning the Filters	13
Cleaning the Door	13
How to Keep your Dishwasher in Shape	14
Problems with your Dishwasher?	14
Troubleshooting Guide	14 – 15
Service for your Dishwasher	16
Wiring Diagram	16
Your Avanti Products Warranty	17
Instrucciones en Español	18 - 26
Registration Information / Registration Card	Back Cover



---

## HELP US HELP YOU...

### Read this guide carefully.

It is intended to help you operate and maintain your new dishwasher properly.

Keep it handy to answer your questions. If you don't understand something or you need more assistance, please call:

**Avanti Customer Service  
800-220-5570**

Keep proof of original purchase date (such as your sales slip) with this guide to establish the warranty period.

### Write down the model and serial numbers.

You'll find them on a plate located on the rear wall of the dishwasher.

Please write these numbers here:

\_\_\_\_\_  
Date of Purchase

\_\_\_\_\_  
Model Number

\_\_\_\_\_  
Serial Number

Use these numbers in any correspondence or service calls concerning your dishwasher.

If you received a damaged dishwasher, immediately contact the dealer (or builder) that sold you the dishwasher.

Save time and money. Before you call for service, check the Troubleshooting Guide. It lists causes of minor operating problems that you can correct yourself.

---

## IF YOU NEED SERVICE

We're proud of our service and want you to be pleased. If for some reason you are not happy with the service you receive, here are some steps to follow for further help.

FIRST, contact the people who serviced your dishwasher. Explain why you are not pleased. In most cases, this will solve the problem.

NEXT, if you are still not pleased, write all the details, including your telephone number, and send it to:

**Customer Service  
Avanti Products  
10880 NW 30<sup>th</sup> Street  
Miami, FL 33172**

## PARTS AND FEATURES

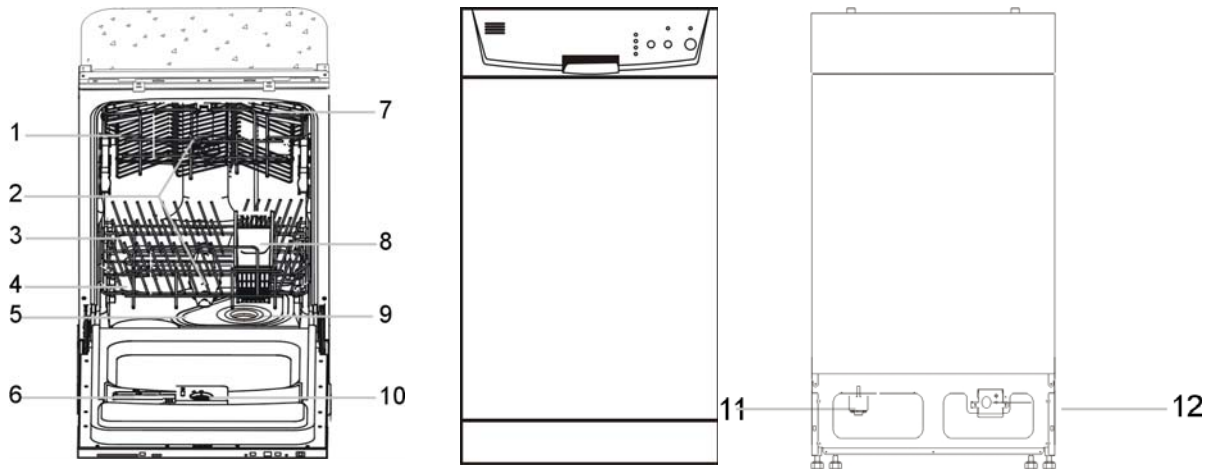

<b>1</b>	<b>Upper Rack</b>
<b>2</b>	<b>Spray Arms</b>
<b>3</b>	<b>Lower Rack</b>
<b>4</b>	<b>Stainless Steel Interior</b>
<b>5</b>	<b>Main Filter Assembly</b>
<b>6</b>	<b>Detergent Dispenser</b>
<b>7</b>	<b>Cup Shelf</b>
<b>8</b>	<b>Silverware Basket</b>
<b>9</b>	<b>Coarse Filter</b>
<b>10</b>	<b>Rinse Aid Dispenser</b>
<b>11</b>	<b>Inlet Valve</b>
<b>12</b>	<b>Junction Box</b>

## Important Safety Instructions

<b>⚠WARNING⚠</b>	To reduce the risk of fire, electrical shock, or injury when using your dishwasher, follow these basic precautions:
<ul style="list-style-type: none"><li>• Read all instructions before using the dishwasher.</li><li>• <b>DANGER or WARNING:</b> Risk of child entrapment.</li><li>• Child entrapment and suffocation are not problems of the past. Junked or abandoned dishwashers are still dangerous. . . even if they will “just sit in the garage a few days.”</li><li>• <b>Before you throw away your old appliance:</b> Take off the doors. Leave the shelves in place so that children may not easily climb inside.</li><li>• Never allow children to operate, play with, or crawl inside the dishwasher.</li><li>• Never clean dishwasher parts with flammable fluids. The fumes can create a fire hazard or explosion.</li><li>• Do not store or use gasoline or any other flammable vapors and liquids in the vicinity of this or any other dishwasher. The fumes can create a fire hazard or explosion.</li><li>• Plug the dishwasher into an exclusive properly installed-grounded wall outlet. Do not under any circumstances cut or remove the third (ground) prong from the power cord. Any questions concerning power and or grounding should be directed toward a certified electrician or an authorized Avanti Products service center</li></ul> <p style="text-align: center;">-Save these instructions-</p>	

## Electrical Connection

<b>⚠Warning⚠</b>
Improper use of the grounded plug can result in the risk of electrical shock. If the power cord is damaged, have it replaced by an authorized Avanti Products service center.

- This dishwasher should be properly grounded for your safety. The power cord of this dishwasher is equipped with a three-prong plug which mates with standard three prong wall outlets to minimize the possibility of electrical shock.
- Do not under any circumstances cut or remove the third ground prong from the power cord supplied.
- Never use an extension cord to connect power to the unit.
- Never use a two-prong grounding adapter.
- Where a two-prong wall receptacle is encountered, contact a qualified electrician to have it replaced with a 3-prong receptacle in accordance with applicable electrical codes.
- This dishwasher requires a standard 110/120 volts A.C.~/60hz electrical outlet with three-prong ground.
- The cord should be secured behind the dishwasher and not left exposed or dangling to prevent accidental injury.
- Connect to a grounded metal, permanent wiring system: or run an equipment grounding terminal or lead of the appliance.
- Improper connection of the equipment grounding conductor can result in a risk of electric shock. Check with a qualified electrician or service representative if you are in doubt whether the appliance is properly grounded.
- Do not attempt to repair or replace any part of your dishwasher unless it is specifically recommended in this manual. All other servicing should be referred to a qualified technician.
- To minimize the possibility of electric shock, disconnect this appliance from the power supply before attempting any maintenance. **Note:** *Turning the dishwasher off does not disconnect the appliance*

from the power supply. We recommend having a qualified technician service your appliance.

### **Water Heater Safety**

Under certain conditions hydrogen may be produced in a water heater that has not been used for two weeks or more. Hydrogen gas is explosive.

If the hot water has not been use for two weeks or more, prevent the possibility of damage or injury by turning on all hot water faucets and allow them to run for several minutes. Do this before using any electrical appliance which is connected to the hot water system. This simple procedure will allow any built-up hydrogen gas to escape. Since the gas is flammable, do not smoke or use an open flame or appliance during this process.

***Use this appliance only for its intended purpose as described in this Owner's Manual.***

### **WARNING READ FOR PROPER USE**

- Do not abuse, sit on, or stand on the door or dish rack of the dishwasher.
- Do not touch the heating element during or immediately after use.
- Do not wash plastic items unless they are marked dishwasher safe or the equivalent. For plastic items not so marked, check the manufacturer recommendations.
- Use only detergent and rinse additives designed for an automatic dishwasher. Using detergent that is not specifically designed for dishwashers will cause the dishwasher to fill with suds.
- Keep children away from detergent and rinse aid, keep children away from the open door of the dishwasher, there could still be some detergent left inside.
- The door should not be left in the open position since this could present a tripping hazard.
- During installation, the power supply must not be excessively bent or flattened.
- To reduce the risk of injury, do not allow children to play in or on a dishwasher.
- Do not operate your dishwasher unless all enclosure panels are properly in place. Open the door very carefully if the dishwasher is operating, there is a risk of water squirting out.
- Do not place any heavy objects or stand on the door when it is open. The appliance could tip forward.
- When loading items to be washed:
  - 1) Locate sharp items so that they are not likely to damage the door seal;
  - 2) Load sharp knives with the handles up to reduce the risk of cut-type injuries.
- When using your dishwasher, you should prevent plastic items form contacting with heating element.
- If the supply cord is damaged, it must be replaced by the manufacturer or its service agent or similarly qualified person in order to avoid a hazard.
- Please dispose of packing materials properly.
- Use the dishwasher only for its intended function.
- Remove the door when removing an old dishwasher from service or discarding it.
- Do not tamper with controls.
- Do not touch the heating element during or immediately after use.

### **Before Using Your Dishwasher**

- Remove the exterior and interior packing.
- Check to be sure you have all of the following parts:
  - 2 Wash Racks (1 Upper / 1 Lower)
  - 1 Silverware Basket
  - 1 Measuring Spoon
  - 1 Instruction Manual
  - 1 Measuring Cup
  - 1 Installation Manual
- Clean the interior surface with lukewarm water using a soft cloth.



## CONTROL PANEL

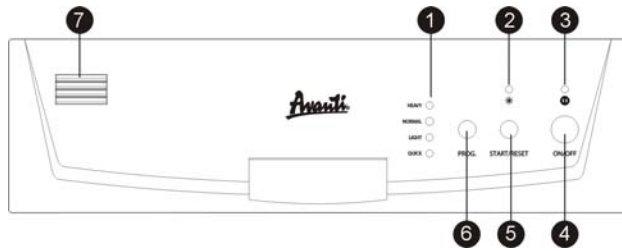

1	Program Indicator Lights
2	Rinse Aid Low Indicator Light
3	Power Indicator Light
4	Power ON / OFF Button
5	Start / Reset Button
6	Program Selector Button
7	Air Vent

**POWER ON / OFF BUTTON:** Turns the unit ON / OFF but does not remove the unit from electrical supply.

**START / RESET BUTTON:**

Press the button to start or pause the selected wash program.

**PRE-PROGRAMMED WASH CYCLE SELECTOR:**

Press the button to select the appropriate wash cycle to accommodate your needs.

See the detailed description of each option / cycle below:

Once the program is selected relevant indicator light on the right will flash intermittently

**PRE-PROGRAMMED WASH CYCLES:**

Program	Load Type	Cycle Description	Run Time (Minutes)	Rinse Aid Used
Heavy	For all soiled loads, such as pots, pans and dishes that have been sitting with dried food on them.	Pre-Wash Pre-Wash Wash Rinse Rinse Dry	125	NO
Normal	For normally soiled loads, such as pots, plates, glasses and lightly soiled pans.	Pre-Wash Wash Rinse Rinse Dry	95	YES
Light	For lightly soiled loads, such as pots, plates, glasses and lightly soiled pans.	Pre-Wash Wash Rinse Rinse Dry	85	NO
Quick	A shorter wash cycle for lightly soiled items that do not require drying	Pre-Wash Wash Rinse Dry	65	NO

## OVERFLOW PROTECTIONS

Our Avanti dishwasher has an overflow protection device which could automatically shut off the inlet valve and start the drain pump if the water overflows. If this occurs, turn off the main water supply before calling a servicer. If there is water in the base pan because of an overflow or small leak, the water should be removed before restarting the dishwasher.

## DETERGENT DISPENSER

The dispenser must be refilled before the start of each wash cycle according to the instructions provided in the “Wash Cycle Table”. Our dishwashers use less detergent than conventional dishwashers. Generally, only one tablespoon of detergent is needed for a normal wash load. Also, more heavily soiled items need more detergent. Always add the detergent just before starting dishwasher, otherwise it could get damp and will not dissolve properly.

1. Main Wash Detergent
2. Prewash Detergent Compartment
3. Rinse-Aid Compartment
4. Rinse Aid Level Indicator

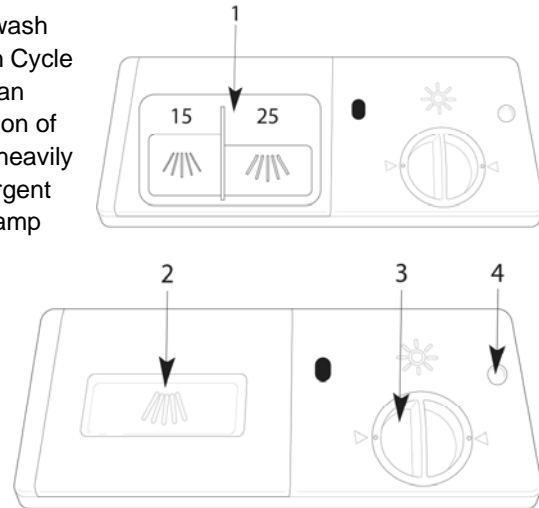

## Amount of Detergent to Use

If the water isn't too hard, you may also prevent the formation of deposits by adding detergent. The amount of detergent needed can vary due to differences in water hardness. To determine the water hardness in your area, contact your local water utility or area water softening company. The harder the water, the more detergent you may need. Remember, you should adjust the amount of detergent you use little by little until you find the correct amount.

## Removing Hard Water Spots From Dishes

To remove hard water spots, try the following:

- Run dishes through a normal wash program.
- Remove all metal dishware, such as cutlery, pans, etc., from the dishwasher.
- Do not add detergent.
- Pour two cups of vinegar into a bowl and set the bowl face up on the lower rack of the dishwasher.
- Run the dishes through a normal wash program.

*If this doesn't work, try the same process with ¼ cup of citric acid crystals instead of vinegar.*

## Proper Use Of Detergent

Use only detergent specifically made for use in dishwasher. Keep your detergent fresh and dry. Don't put powder detergent into the dispenser until you're ready to wash dishes.

## Rinse Aid Dispenser

The rinse aid is released during the final rinse to prevent water from forming droplets on your dishes that can leave spots and streaks. It also improves drying by allowing water to “sheet” off the dishes.

Our dishwashers are designed to use liquid rinse aids. The rinse aid dispenser is located inside the door next to the detergent dispenser. To fill the dispenser, open the cap and pour the rinse aid into the dispenser until the level indicator turns completely black. The dispenser holds about 100 ml of liquid rinse aid.

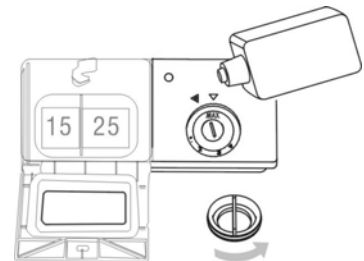

Be careful not to overfill the dispenser, because this could cause over sudsing. Wipe away any spills with a damp cloth. Don't forget to replace the cap before you close the dishwasher door. If you have soft water, you may not need rinse aid for it may cause a white film to develop on your dishes.

### Adjusting Rinse Aid Dispenser

A measured amount of rinse aid is released during the final rinse. As with detergent, the amount of rinse aid needed for your dishes depends on the hardness of the water in your area. Too much rinse aid can result in lather or foaming and cause cloudiness or streaks on your dishes. If the water in you area is very soft, you may not need rinse aid. If you do, you can dilute the rinse aid with an equal amount of water.



The rinse aid dispenser has 4 settings. Always start with the dispenser set on "1". If spots and poor drying are problems, increase the amount of rinse aid dispensed by removing the dispenser lid and rotating the dial to "2". IF the dishes still are not drying properly or are spotted, adjust the dial to the next higher number until your dishes are spot-free. We suggest you to set on "3".

### When To Refill The Rinse Aid Dispenser

If there is no rinse aid warning light on the control panel, you can judge the amount of rinse aid by the following means: The black dot on the rinse aid dispenser indicates the amount of rinse aid in the dispenser. As the rinse aid diminishes, the size of the black dot decreases. You should never let the rinse aid get below ¼ full.

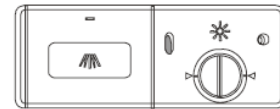

- Full
- 3/4 Full
- 1/2 Full
- 1/4 full (Refill)
- Empty

### How to Use the Upper Rack

The upper rack is designed to hold more delicate and lighter dishware such as glasses, coffee and tea cup and saucers, as well as plates, small bowls and shallow pans ( as long as they are not too dirty). Position the dishes and cookware so that they do not get moved by the spray of waters. The upper rack can be adjusted for height by putting wheels of different height into the rails.

1. Cups
2. Small Serving Bowl
3. Large Serving Bowl
4. Glasses
5. Saucers
6. Dish

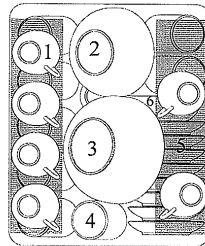

### How To Use The Lower Rack

We recommend that you place large items which are most difficult to clean into the lower rack: pots, pans, lids, serving dishes and bowls, as shown in the figure. It is preferable to place serving dishes and lids on the side of the racks in order to avoid blocking the rotation of the top spray arm.

Pots, serving bowls, etc, must always be placed top down. Deep pots should be slanted to allow water to flow out.

The bottom rack feature folds down tine rows so that larger or more pots and pans can be loaded.

1. Oval Platter
2. Dinner Plates
3. Soup Plates
4. Dessert Dishes
5. Silverware Basket

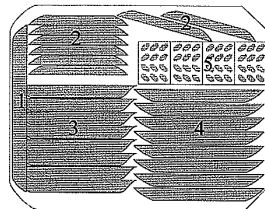

### **Silverware Basket**

Silverware should be placed in the silverware basket with handles at the bottom: if the rack has side baskets, the spoon should be loaded individually into the appropriate slots, especially long utensils should be placed in the horizontal position at the front of the upper rack.

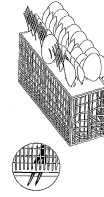

### **Starting A Wash Cycle**

- Make sure that the plug for the appliance is inserted into the wall socket.
- Make sure the water supply is turned on to full pressure.
- Load the dishwasher.
- Pour in the detergent.
- Close the door completely.
- Press the ON/OFF button.
- Select the appropriate wash cycle suitable for your needs the dishwasher will begin the selected wash cycle
- During the wash cycle the START/RESET indicator light will flash intermittently.

### **Canceling Or Modifying A Wash Cycle Setting**

Premise: A cycle that is underway can only be modified if it has only been running for a short time. Otherwise, the detergent may have already been released, and the appliance may have already drained the wash water. If this is the case, the detergent dispenser must be refilled. press the START/RESET button to hold for more than 3 seconds to cancel the running program. Then you can select appropriate programs.

### **At The End Of The Wash Cycle**

When the cycle has finished; turn off the appliance using the ON/OFF button, shut off the water supply and open the door of the dishwasher. Wait a few minutes before unloading the dishwasher to avoid handling the dishes and utensils while they are still hot and more susceptible to breakage. They will also dry better.

### **Forgot To Add A Dish?**

A forgotten dish can be added any time before the detergent cup opens.

- Press the START/RESET button
- Pull the door handle.
- Do not open the door until the water spray action stops. Steam may rise out of the dishwasher.
- Add forgotten dishes.
- Push the door to close it. When the door is closed right a click will be heard.
- Press the START/RESET button again to continue accordingly.

### **Filtering System**

For your convenience, we have placed the drain pump and filtering system within easy reach inside the tub. There are three components of the filtering system: the main filter, the coarse filter and the fine filter.

#### **1. Main Filter**

Food and soil particles trapped by this filter are pulverized by a special jet on the lower spray arm and washed down the drain.

#### **2. Coarse Filter**

Larger items, such as pieces of bone or glass, that could clog the drain are trapped in the coarse filter. To remove an item caught in this filter, gently squeeze the tabs on top of this filter and lift out.

#### **3. Fine Filter**

This filter holds soil and food residue in the sump area and prevents it from being re-deposited on the dishes during a cycle.

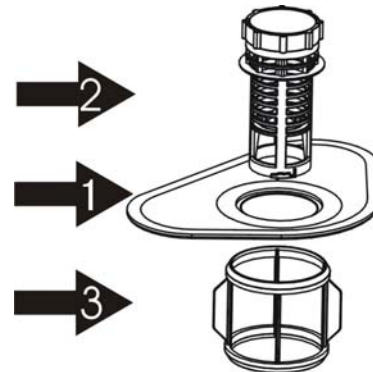

## Caring And Maintenance

To clean the control panel use a lightly dampened cloth then dry thoroughly. To clean the exterior use a good appliance polish wax.

Never use sharp objects, scouring pads or harsh cleaners on any part of the dishwasher.

### Protect against freezing

If your dishwasher is left in an unheated place during the winter, ask a service technician to:

1. Cut off electrical power to the dishwasher. Remove fuses or trip circuit breaker.
2. Turn off the water supply and disconnect the water inlet pipe from the water valve.
3. Drain water from the inlet pipe and water valve. (Use a pan to catch the water.)
4. Reconnect the water inlet pipe to the water valve.
5. Remove the plastic sump cover in the tub the bottom and use a sponge to soak up water in rubber boot.

### Cleaning The Spray Arms

It is necessary to clean the spray arms regularly or hard water chemicals will clog the spray arm jets and bearings. To remove the spray arm, screw off the nut to take out the washer on top of the spray arm and remove the arm. Wash the arms in soapy and warm water and use a soft brush to clean the jets. Replace them after rinsing them thoroughly.

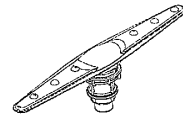

### Cleaning The Filters

#### Filter assembly

For best performance and results, the filter assembly must be cleaned. The filter efficiently removes food particles from the wash water, allowing it to be re-circulated during the cycle. For this reason, it is a good idea to remove the larger food particles trapped in the filter after each wash cycle by rinsing the semicircular filter and cup under running water. To remove the filter assembly, pull on the cup handle in the upward direction. The entire filter assembly should be cleaned at least once a month.

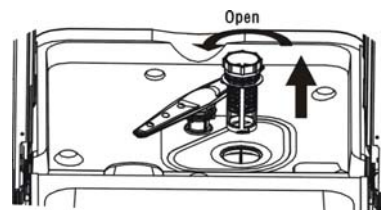

To clean the coarse filter and the fine filter, use a cleaning brush. Then, reassemble the filter parts as shown in the figures and reinsert the entire assembly in the dishwasher, positioning it in its seat and pressing downward.

The dishwasher must never be used without the filters. Improper replacement of the filter may reduce the performance level of the appliance and damage dishes and utensils.

**WARNING** – Never run the dishwasher without the filters in place.

### Cleaning The Door

To clean the edge around the door, you should use only a soft warm, damp rag. To prevent penetration of water into the door lock and electrical components, do not use a spray cleaner of any kind.

Also, never use abrasive cleaners or scouring pads on the outer surfaces because they will scratch the finish. Some paper towels can also scratch or leave marks on the surface.

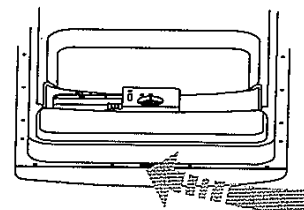

**WARNING - Never use a spray cleaner to clean the door panel for it could damage the door lock and electrical components. It is not allowed to use the abrasive agent or some paper towel because of the risk of scratching or leaving spots on the stainless steel surface.**

## How To Keep You Dishwasher In Shape

### **After every wash**

After every wash, turn off the water supply to the appliance and leave the door slightly ajar so that moisture and odors are not trapped inside.

### **No solvents or abrasive cleaning products**

To clean the exterior and rubber parts of the dishwasher, do not use solvents or abrasive cleaning products. Rather, use only a cloth and warm soapy water. To remove spots or stains from the surface of the interior, use a cloth dampened with water and a little white vinegar, or a cleaning product made specifically for dishwashers.

### **When you go on Holiday**

When you go on holiday, it is recommended that you run a wash cycle with the dishwasher empty and then remove the plug from the AC socket, turn off the water supply and leave the door of the appliance slightly ajar. This will help the seals last longer and prevent odors from forming within the appliance.

### **Seals**

One of the factors that cause odors to form in the dishwasher is food that remains trapped in the seals. Periodic cleaning with a damp sponge will prevent this from occurring.

## PROBLEMS WITH YOUR DISHWASHER?

You can solve many common dishwasher problems easily, saving you the cost of a possible service call. Try the suggestions below to see if you can solve the problem before calling the servicer.

## TROUBLESHOOTING GUIDE

PROBLEM	POSSIBLE CAUSE	WHAT TO DO
Dishwasher does not operate.	The circuit breaker tripped or blown fuse. Power supply is not turned on.  Water pressure is low.	Replace fuse or reset circuit breaker. Remove any other appliances sharing the same circuit with the dishwasher Make sure the dishwasher is turned on and the door is closed securely. Make sure the power cord is properly connected. Check that the water supply is connected properly and the water is turned on.
Drain pump doesn't stop	Overflow	The system is designed to detect an overflow. When it doesn't it shuts off the circulation pump and turns on the drain pump.
Noise	Some audible sounds are normal.  Utensils are not secured in the baskets or something small has dropped into the basket.  Motor hums.	Sound from soft food shredding action and detergent cup opening. Ensure everything is secured in the dishwasher.  Dishwasher has not been used regularly. If you do not use it often, remember to set it to fill and pump out every week, which will help keep the seal moist.
Suds in the tub	Improper detergent.  Spilled rinse agent.	Use only the special dishwasher detergent to avoid suds. If this occurs, open the dishwasher and let suds evaporate. Add 1 gallon of cold water to the tub. Close and latch the dishwasher, then drain out the water by slowly turning the dial until a drain period is reached. Repeat if necessary. Always wipe-up rinse agent spills immediately.

Stained tub interior	Detergent with colorant was used.	Make sure that the detergent is the one without colorant.
Dishes are not dried	Rinse agent dispenser is empty.	Make sure the rinse agent dispenser is filled.
Dishes and flatware not clean.	Improper program. Improper rack loading.	Select a stronger program. Make sure that the action for the detergent dispenser and spray arms are not blocked by large dishware.
Cloudiness on glassware.	Combination of soft water and too much detergent.	Use less detergent if you have soft water and select a shorter cycle to wash the glassware to get them clean.
Yellow or brown film on inside surfaces.	Tea or coffee stains.  Iron deposits in water can cause an overall film.	Using a solution of ½ cup bleach and 3 cups warm water to remove the stains by hand. <b>Warning</b> You have to wait for 20 minutes after a cycle to let the heating elements cool down before cleaning interior: otherwise, burns will happen. You have to call a water softener company for a special filter.
White film on inside surface.	Hard water minerals	To clean the interior, use a damp sponge with dishwasher detergent and wear rubber gloves. Never use any other cleaner than dishwasher detergent for the risk of foaming or suds.
Detergent left in dispenser cups.	Dishes block detergent cups.	Re-load the dishes properly.
Steam	Normal phenomenon	There is some steam coming through the vent by the door latch during drying and water draining.
Black or gray marks on dishes.	Aluminum utensils have rubbed against dishes.	Use a mild abrasive cleaner to eliminate those marks.
Water standing in the bottom of the tub.	This is normal.	A small amount of clean water around the outlet on the tub bottom at the back of the tub keeps the water seal lubricated.
Water doesn't pump out of the tub.	Drain is clogged.	Make sure the kitchen sink is draining well. If the dishwasher drains into a disposer, run it clear.
Dishwasher leaks.	Overfill dispenser or rinse aid spills.  Dishwasher isn't level.	Be careful not to overfill the rinse aid dispenser. Spilled rinse aid could cause oversudsing and lead to overflowing. Wipe away any spills with a damp cloth. Make sure the dishwasher is level.
LIGHT and QUICK program lights flicker intermittently	Water has not reached the required temperature (HOT)	Malfunction of the temperature sensor and or the heating element
NORMAL and LIGHT program lights flicker intermittently	Failure of the temperature sensor	Temperature sensor has failed. Contact an authorized service center
NORMAL and QUICK program lights flicker intermittently	Failure of the temperature sensor	Temperature sensor has failed. Contact an authorized service center

## SERVICE FOR YOUR DISHWASHER

We are proud of our customer service organization and the network of professional service technicians that provide service on your Avanti dishwashers. With the purchase of your Avanti dishwasher, you can have the confidence that if you ever need additional information or assistance, the Avanti Products Customer Service team will be here for you. Just call us toll-free.

### AVANTI PRODUCTS CUSTOMER SERVICES

Product Information 800-323-5029	Whatever your questions are about our products, help is available.
Part Orders 800-220-5570	You may order parts and accessories that will be delivered directly to your home, by personal check, money order, Master Card, or Visa.
In-Home Repair Service 800-220-5570	An Avanti Products authorized service center will provide expert repair service, scheduled at a time that is convenient for you. Our trained servicers know your dishwasher inside and out.

### Wiring Diagram

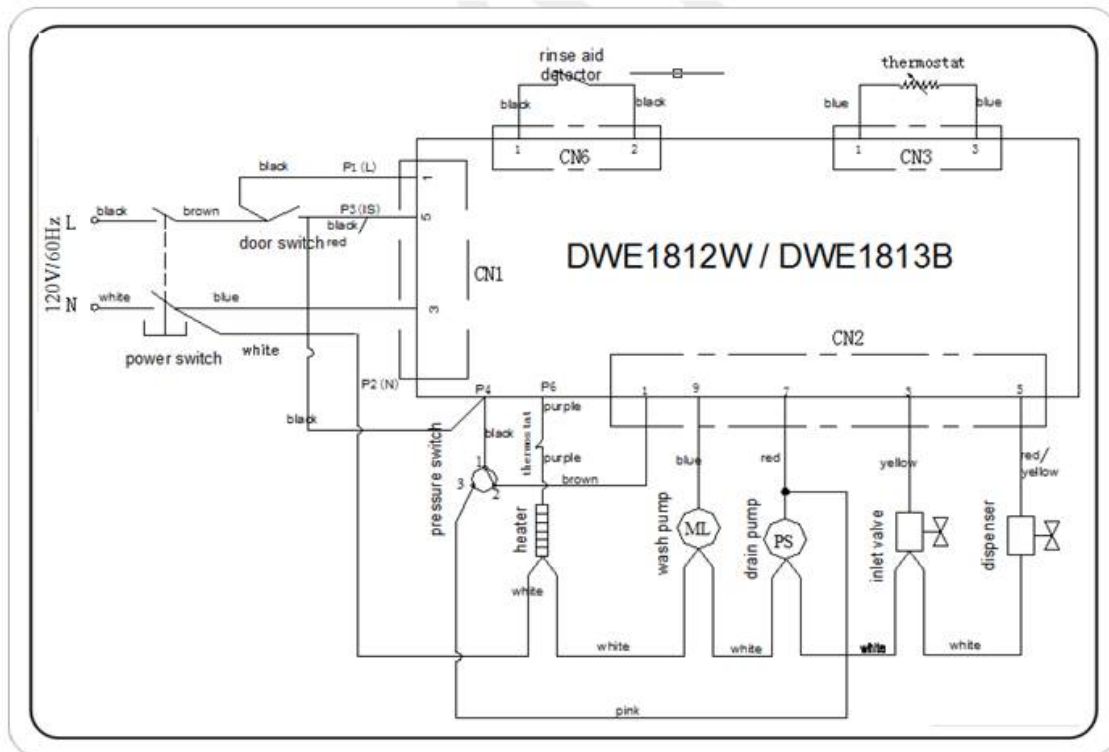



<b>YOUR AVANTI PRODUCTS WARRANTY</b>	Staple your sales receipt here. Proof of original purchase date is needed to obtain service under warranty.
<p><b><u>WHAT IS COVERED – LIMITED ONE-YEAR WARRANTY</u></b>  Avanti Products warrants that the product is free from defects in materials and/or workmanship for a period of twelve (12) months from the date of purchase by the original owner. The foregoing timeline begins to run upon the date of purchase, and shall not be stalled, tolled, extended, or suspended for any reason whatsoever unless described in detail in the warranty document. For one year from the date of purchase by the original owner, Avanti products will, at its option, repair or replace any part of the product which proves to be defective in material or workmanship under normal use. Avanti Products will provide you with a reasonably similar product that is either new or factory refurbished. During this period Avanti Products will provide all parts and labor necessary to correct such defects free of charge, so long as the product has been installed and operated in accordance with the written instructions in this manual. In rental or commercial use, the warranty period is 90 days. All Avanti appliances of 3.5 cubic feet capacity or less must be brought/sent to the appliance service center for repair.</p>	
<p><b><u>LIMITED FIVE YEAR WARRANTY ON PLASTIC TUB</u></b>  After one year and until five years from the date of purchase, Avanti Products will furnish a replacement plastic tub, for one which is defective in material or workmanship. All labor and transportation charges are the responsibility of the consumer.</p>	
<p><b><u>LIMITED SEVEN YEAR WARRANTY ON STAINLESS STEEL TUB</u></b>  After one year and until seven years from the date of purchase, Avanti Products will furnish a replacement plastic tub, for one which is defective in material or workmanship. All labor and transportation charges are the responsibility of the consumer.</p>	
<p><b><u>WARRANTY EXCLUSIONS / WHAT IS NOT COVERED:</u></b>  The warranty coverage described herein excludes all defects or damage that are not the direct fault of Avanti Products, including without limitation, one or more of the following:</p>	
<ul style="list-style-type: none"> <li>● A failure to comply with any applicable state, local, city, or county electrical, plumbing and/or building codes, regulations, or laws, including failure to install the product in strict conformity with local fire and building codes and regulations.</li> <li>● Any external, elemental and/or environmental forces and factors, including without limitation, rain, wind, sand, floods, fires, mud slides, freezing temperatures, excessive moisture or extended exposure to humidity, lightning, power surges, structural failures surrounding the appliance, and acts of God.</li> </ul>	
<ul style="list-style-type: none"> <li>● Content losses of food or other content due to spoilage.</li> <li>● Incidental or consequential damages</li> <li>● Parts and labor costs for the following will not be considered as warranty: <ul style="list-style-type: none"> <li>● Evaporator doors, door springs, and/or frames.</li> <li>● Inner door panels, door shelves, door rails, and/or door supports.</li> <li>● Chest freezer lid liners.</li> <li>● Vegetable crispers.</li> <li>● Light bulbs and/or plastic housing.</li> <li>● Plastic cabinet liners.</li> <li>● Punctured evaporator that voids the warranty on the complete sealed system.</li> </ul> </li> </ul>	<ul style="list-style-type: none"> <li>● Shipping and handling costs associated with the replacement of the unit.</li> <li>● Repairs performed by unauthorized servicers.</li> <li>● Service calls that are related to external problems, such as abuse, misuse, inadequate electrical power, accidents, fire, floods, or any other acts of God.</li> <li>● Failure of the product if it is used for other than its intended purpose.</li> <li>● The warranty does not apply outside the Continental USA.</li> <li>● Surcharges including but not limited to, any after hour, weekend, or holiday service calls, tolls, ferry trip charges, or mileage expense for service calls to remote areas.</li> </ul>
<p>In no event shall Avanti Products have any liability or responsibility whatsoever for damage to surrounding property, including cabinetry, floors, ceilings, and other structures and/or objects around the product. Also excluded from this warranty are scratches, nicks, minor dents, and other cosmetic damages on external surfaces and exposed parts; Products on which the serial numbers have been altered, defaced or removed; service visits for customer education, or visits where there is nothing wrong with the product; correction of installation problems (you are solely responsible for any structure and setting for the product, including all electrical, plumbing and/or other connecting facilities, for proper foundation/flooring, and for any alterations including without limitation cabinetry, walls, floors, shelving etc., as well as the resetting of breakers or fuses.</p>	
<p><b><u>OUT OF WARRANTY PRODUCT</u></b>  Avanti Products is under no obligation, at law or otherwise, to provide you with any concessions, including repairs, pro-rates, or product replacement, once this warranty has expired.</p>	

## INSTRUCCIONES EN ESPAÑOL

<b>PRECAUCION</b>	Para reducir el riesgo de incendio, descarga eléctrica, o daño cuando use su electrodoméstico, siga las siguientes precauciones.
<ul style="list-style-type: none"><li>• Lea todas las instrucciones antes de usar su electrodoméstico.</li><li>• Peligro o Precaución: Existe el riesgo que los niños queden atrapados.</li><li>• Niños atrapados o sofocamiento no son un problema del pasado. Los electrodomésticos son peligrosos aún si solo los deja en el garaje por un par de días.</li><li>• Antes de desechar su equipo usado: quítele la puerta. Deje las canastas en su lugar para evitar que los niños se queden atrapados.</li><li>• No permita que los niños manejen, jueguen o entren dentro del electrodoméstico.</li><li>• No limpie su electrodoméstico con líquidos inflamables. Los gases pueden ocasionar fuego o una explosión.</li><li>• No guarde ni use gasolina u otros líquidos inflamables cerca de este o de cualquier otro electrodoméstico. Los vapores pueden ocasionar fuego o explosión.</li></ul> <p>- <u>Guarde estas instrucciones.</u>-</p>	

### INFORMACIONES IMPORTANTES DE SEGURIDAD LEA TODAS LAS INSTRUCCIONES ANTES DE USAR EL EQUIPO

#### ADVERTENCIA

Cuando use el lavaplatos siga las instrucciones básicas indicadas a continuación

#### ADVERTENCIA. EL HIDROGENO ES UN GAS EXPLOSIVO

Bajo ciertas condiciones, el gas de hidrógeno se puede producir en un sistema de agua caliente que no ha sido usado por más de dos semanas. **EL HIDROGENO ES UN GAS EXPLOSIVO.**

Si el sistema de agua caliente no va a ser usado por un período de tiempo, cierre todas las llaves de agua caliente y deje correr el agua fría por varios minutos antes de usar el lavaplatos. Esto liberará cualquier residuo de gas hidrógeno acumulado. Debido a lo inflamable de este gas, no fume o haga fuego alrededor.

### **INSTRUCCIONES DE ALAMBRADO**

#### **Tipos de Cable Alambrado**

Este equipo debe estar alambrado a tierra. En el evento en que ocurra alguna rotura o mal funcionamiento, el alambrado a tierra reducirá el riesgo de descarga eléctrica proveyendo un camino de menor resistencia para la corriente eléctrica. Este equipo viene con un cable con enchufe a tierra. El cable debe estar conectado a un enchufe apropiado, el cual deberá cumplir todas las ordenanzas y códigos locales.

#### ADVERTENCIA

La conexión inapropiada del cable a tierra incrementará el riesgo de descargas eléctricas. Verifique con un electricista o personal de servicio calificados la conexión apropiada del equipo. Si necesita realizar alguna modificación en el enchufe a tierra, le recomendamos contratar los servicios de un electricista.

#### USO APROPIADO

- No maltrate, se siente o se pare en la puerta o la bandeja del lavaplatos.
- No toque el calentador durante o justamente después de usar el lavaplatos.
- No lave artículos de plástico, a menos que estos indiquen que son aptos para lavaplatos, para los artículos que no lleven indicación, lea las recomendaciones del fabricante.
- Use sólo detergentes y aditivos de enjuague diseñados para lavaplatos automáticos. No use jabón, detergente para ropa o detergente de lavado a mano en su equipo.
- Mantenga el detergente y los aditivos de enjuague fuera del alcance de los niños. Mantenga a los niños lejos del lavaplatos cuando la puerta esté abierta, ya que podrían quedar residuos de detergente en el interior.
- La puerta no debe quedar abierta, ya que podría causar tropiezos y caídas.
- Durante la instalación, el sistema de suministro eléctrico no debe estar doblado o aplanado.
- Para reducir el riesgo de accidentes, no permita a los niños jugar en o con el lavaplatos.
- No utilice su lavaplatos a menos que todos los paneles interiores estén en su lugar. Abra cuidadosamente el lavaplatos si este está operando, existe el riesgo de una fuga de agua.
- No coloque objetos pesados sobre la puerta abierta. El equipo podría inclinarse hacia adelante.

#### **Cuando esté cargando los artículos a limpiar:**

- Coloque los artículos afilados de manera que no dañen el sello de la puerta.
- Coloque los filos de los cuchillos hacia abajo para reducir el riesgo de cortes.
- Si el cordón del enchufe está dañado, deberá ser reemplazado por el fabricante, su agente de servicios o una persona calificada.
- Deshágase de los materiales de empaque apropiadamente.
- Use el lavaplatos sólo para las funciones para las que fue diseñado.
- Quite la puerta del compartimiento de lavado cuando cambie o deseche un lavaplatos.
- No juegue con los controles.

LEA Y SIGA CUIDADOSAMENTE ESTA INFORMACION DE SEGURIDAD  
GUARDE ESTAS INSTRUCCIONES

## CARACTERISTICAS

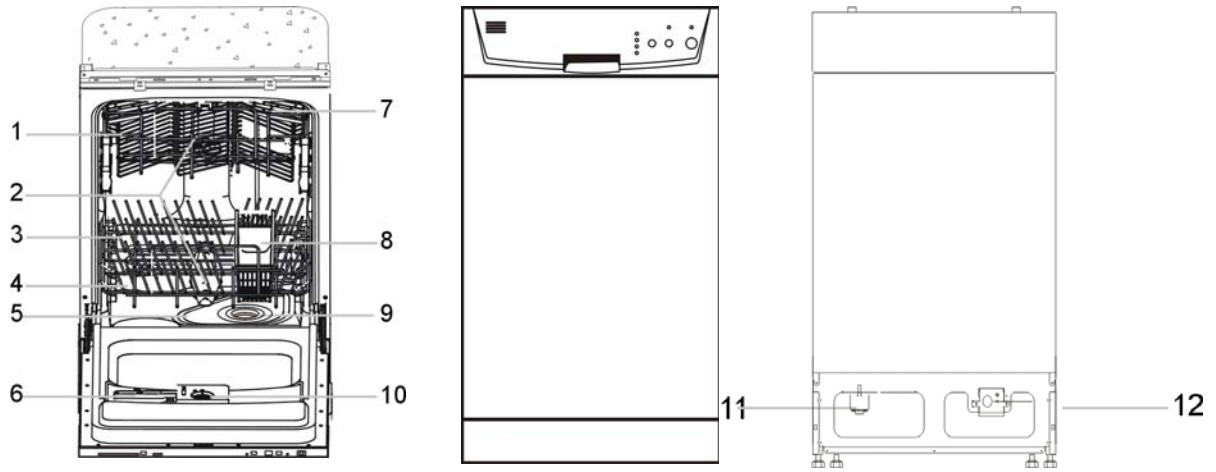

1	Parrilla superior	7	Parrilla para tazas
2	Brazos distribuidores	8	Canasta para cubiertos
3	Parrilla inferior	9	Filtro grueso
4	Interior de acero inoxidable	10	Dispensador de aditivo de enjuague
5	Ensamble de filtro	11	Válvula para la entrada de agua
6	Dispensador de detergente	12	Caja eléctrica

## CONTROL PANEL

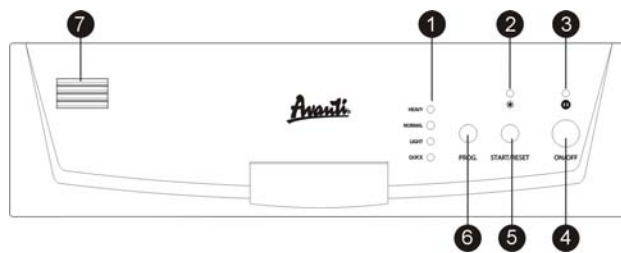

1	Luz indicadora para cada ciclo
2	Luz indicadora para llenar el aditivo de enjuague
3	Luz indicadora de encendido
4	Botón para encender o apagar la unidad
5	Botón para comenzar el ciclo
6	Botón para seleccionar un ciclo
7	Ventilación

**La luz indicadora de ciclo parpadeará intermitentemente para indicar el ciclo seleccionado.**

**TABLA DE CICLO DE LAVADO**

Programa	Ciclo	Información de Selección de Ciclo	Descripción de ciclo	Tiempo de Operación (Minutos)	Aditiv Enjuag
Heavy (Intensivo)	Lavado	Para cargas de mucha suciedad, Como ollas, sartenes, cacerolas y platos con comida seca, por un Mayor tiempo	Pre-enjuague	125	<b>NO</b>
	Normal		Lavado Enjuague Enjuague Secado		
Normal	Lavado	Para cargas de suciedad normal Como ollas, platos, vasos y sartenes ligeramente sucios. Ciclo diario estándar	Pre-enjuague	95	<b>SI</b>
	Normal		Lavado Enjuague Enjuague Secado		
Light (Economico)	Lavado	Para cargas de suciedad ligera como platos, vasos, ensaladeras y sartenes ligeramente sucios.	Lavado	85	<b>NO</b>
	Ligero		Enjuague Enjuague		
Rápido	Cristales	Pequeño lavado para cargas de suciedad ligera que no necesitan	Pre-enjuague	65	<b>NO</b>
	Vidrio		Lavado Enjuague Secado		

**Protección contra el sobre flujo de agua**

Este lavaplatos cuenta con un sistema de protección contra el sobre flujo de agua, el mismo cierra la válvula de entrada de agua y activa la bomba de drenaje cuando el nivel del agua sube demasiado. Si esto ocurre, cierre la llave principal de entrada de agua antes de llamar al personal de servicio. Si hay agua en la bandeja de la base debido al sobre flujo o existe algún tipo de goteo, el agua deberá retirarse antes de reiniciar el funcionamiento del lavaplatos.

### Dispensador de Detergente

El dispensador debe rellenarse antes de comenzar cada ciclo de lavado de acuerdo a las instrucciones detalladas en la tabla de lavado. Este lavaplatos usa menor cantidad de detergente y aditivos de enjuague que los lavaplatos convencionales. Generalmente, sólo se necesitará una cucharada de detergente para una carga en el programa de lavado normal. Los artículos más sucios necesitarán mayor cantidad de detergente. Siempre añada el detergente justo antes de iniciar el lavaplatos, de otra manera podría humedecerse y no disolverse apropiadamente.

### Cantidad de detergente a usar

SI EL AGUA NO ES MUY DURA, USTED PODRA PREVENIR LA FORMACION DE DEPOSITOS AÑADIENDO DETERGENTE.

La cantidad de detergente que necesite variará dependiendo de la dureza del agua. Para determinar la dureza del agua en su localidad, comuníquese con la compañía proveedora de agua. Mientras más dura sea el agua, mayor será la cantidad de detergente a utilizar. Recuerde, usted debe encontrar la cantidad de detergente que debe usar añadiendo pequeñas cantidades hasta encontrar la medida exacta.

- 1: Depósito principal de detergente
- 2: Depósito de detergente de pre-lavado
- 3: Depósito de aditivos de enjuague
- 4: Indicador de nivel de aditivos de enjuague

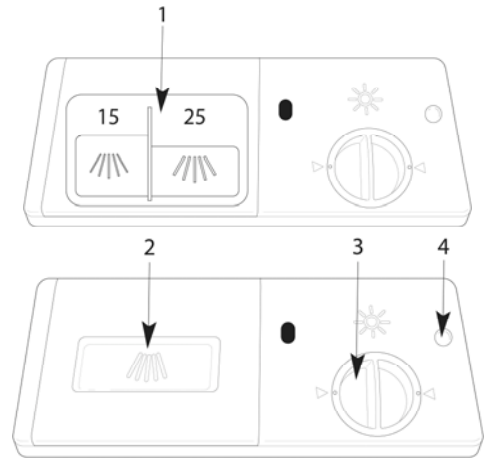

Quitando manchas de agua dura de los platos

Para quitar las manchas producidas por el agua dura, siga estos consejos:

Ponga los platos en el programa de lavado normal.

Quite todo objeto metálico, como cubiertos, sartenes, etc.) del lavaplatos.

No añada detergente.

Eche dos tazas de vinagre en una ensaladera, colóquela en la rejilla inferior del lavaplatos. Inicie el programa de lavado normal.

Si esto no funciona, realice el mismo proceso usando ¼ de taza de cristales de ácido cítrico en lugar del vinagre.

### Uso adecuado del detergente

Solamente use detergente para lavaplatos.

Conserve el detergente en un lugar fresco y seco.

No vierta el detergente en polvo hasta el momento mismo de lavar los platos.

### ADVERTENCIA!

El detergente para lavaplatos es corrosivo. Tenga el cuidado de mantenerlo lejos del alcance de los niños.

### DEPOSITO DE ADITIVOS DE ENJUAGUE

Para abrir el depósito, de vuelta a la tapa hacia la flecha izquierda ("open") y tire de ella.

Vierta el aditivo de enjuague en el depósito, tenga cuidado de no sobrepasar el tope.

Coloque la tapa alineándola con la flecha izquierda ("open") y dándole vuelta hacia la flecha derecha ("close").

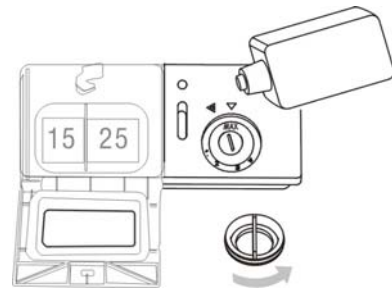

Los aditivos de enjuague se liberarán durante el enjuague final para prevenir que el agua forme gotas en sus platos las que podrían dejar manchas y rayas. También mejoran el secado permitiendo que el agua se escurra más fácilmente de los platos.

Este lavaplatos está diseñado para usar aditivos de enjuague líquidos. El depósito está situado dentro de la puerta, junto al depósito de detergente

Para llenar el depósito, abra la tapa y eche el aditivo de enjuague hasta que el indicador de nivel se

torne completamente negro. El depósito tiene capacidad para 100 ml.  
 Debe tener cuidado de no llenar el depósito por encima del nivel permitido, esto podría causar excesos de espuma. Limpie con un paño húmedo cualquier derrame o salpicadura. No se olvide de colocar la tapa en su lugar antes de cerrar la puerta del lavaplatos.  
 Si su localidad tiene agua blanda, no deberá usar el aditivo de enjuague ya que éste podría dejar una capa blanca sobre sus platos.

#### Como usar la parrilla superior

Le recomendamos que coloque los artículos pequeños y los más fáciles de limpiar, en la parrilla superior: vasos, copas, tapas, platos de servicio y ensaladeras, como se muestra en la figura.  
 Es preferible que coloque los platos de servicio y las tapas en los lados de la parrilla para que no interrumpan la rotación del brazo distribuidor.

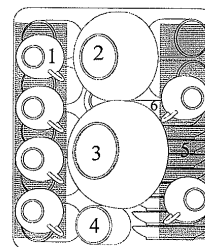

#### Como usar la parrilla inferior

Le recomendamos que coloque los artículos grandes y los más difíciles de limpiar, en la parrilla inferior: ollas, sartenes, tapas, platos de servicio y ensaladeras, como se muestra en la figura.  
 Es preferible que coloque los platos de servicio y las tapas en los lados de la parrilla para que no interrumpan la rotación del brazo distribuidor.

Las ollas, ensaladeras, etc., se deben poner boca abajo.

Las ollas hondas deben estar colocadas de manera que permitan el flujo adecuado del agua.

La parrilla inferior se puede acomodar para que cualquier tipo de ollas y sartenes puedan ser incluidas.

1	2	2
	3	4

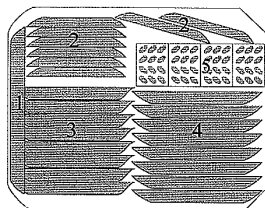

1	Bandejas Ovais
2	Platos de comida
3	Platos de sopa
4	Platos de postre
5	Canasta para cubiertos

#### Canasta para cubiertos

Los cubiertos se deben colocar en las áreas designadas en la canasta de cubiertos con los mangos hacia abajo: Si la rejilla tiene canastas laterales, las cucharas deberán insertarse individualmente en las ranuras apropiadas, los utensilios especialmente largos, deben colocarse en posición horizontal al frente de la rejilla superior.

1	4	5	2
1	4	5	
1	4	5	2
1	4	5	2
1	4	5	
4	4	5	2
7	4	5	2
8	3	5	
1	3	3	2
1	3	3	2
1	3	3	
6	3	6	2

- Tenedores
- Cucharas de sopa
- Cucharas de postre
- Cucharitas de te
- Cuchillos
- Cucharas de servicio
- Cucharón de salsa
- Tenedores de servicio

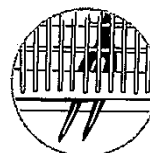
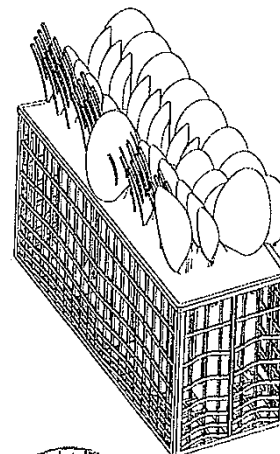

### COMO EMPEZAR UN CICLO DE LAVADO:

Asegurase que la unidad está conectada al tomacorriente y a la entrada de agua.  
Llena la unidad apropiadamente.  
Agrega el detergente  
Cierra la puerta  
Oprima el botón de encendido  
Selecciona el ciclo de lavado apropiado para su uso  
Oprima el botón para empezar el ciclo (la luz indicadora parpadeará).

### COMO CANCELAR O MODIFICAR UN CICLO DE LAVADO:

Para cancelar un ciclo después que haya empezado oprima el botón (START / RESET) para aproximadamente 3 segundos.  
Oprima el botón (PROG) para seleccionar el ciclo nuevo  
Oprima el botón (START / RESET)  
El ciclo empezará a funcionar.

### LIMPIANDO LOS BRAZOS DISTRIBUIDORES

Es necesario limpiar los brazos distribuidores regularmente, los químicos del agua dura pueden tupid el brazo distribuidor y el eje. Para sacar el brazo distribuidor, desenrosque la tuerca para sacar el limpiador de la parte superior del brazo distribuidor. Limpie los brazos con agua tibia y jabonosa, use una pequeña brocha para limpiar los distribuidores. Reinstálelos después de haberlos secado.

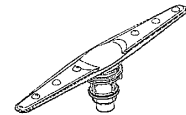

### LIMPIANDO LOS FILTROS

Es necesario sacar y limpiar el filtro periódicamente removiendo las partículas de comida en el agua de lavado permitiendo que recircule durante el ciclo.

Ensamble del filtro.

Para mejores resultados, limpie el filtro.

El filtro remueve partículas de comida del agua de lavado, permitiendo que recircule durante el ciclo. Por esta razón, es una buena idea quitar las grandes partículas de comida atrapadas en el filtro después de cada ciclo de lavado enjuagando el filtro semicircular y la taza.

Para sacar el sistema del filtro, hale la manija de la taza hacia arriba. El sistema entero del filtro deberá ser limpiado al menos una vez al mes.

Para limpiar el filtro grueso y el fino use un cepillo limpiador, luego ensamble nuevamente las partes del filtro como se muestra en las figuras de la izquierda y reinserte el ensamblaje completo en el lavaplatos, ubicándolo en su sitio y presionando hacia abajo.

El lavaplatos no debe usarse sin el filtro. El reemplazo inapropiado del filtro reducirá los niveles de funcionamiento del equipo así como también dañando platos y utensilios.

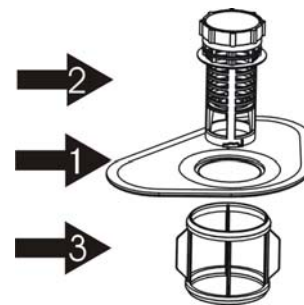

**ADVERTENCIA: Nunca use el lavaplatos sin filtro.**



## **LIMPIANDO LA PUERTA**

Para limpiar el borde alrededor de la puerta use un trapo húmedo, suave y tibio. Para prevenir el ingreso de agua al seguro de la puerta y a componentes eléctricos, no use limpiadores en aerosol de ninguna clase. Tampoco use limpiadores con abrasivos o paños desgrasadores ya que podrían arañar la superficie. Algunos papeles toalla podrían también arañar o dejar marcas en la superficie.

## **ADVERTENCIA**

Tampoco use agentes abrasivos o papel toalla áspero debido al riesgo de arañar el equipo o dejar manchas en las superficies de acero inoxidable.

### **Limpiando la Bomba de Drenaje**

Ocasionalmente algo caerá dentro del filtro y la bomba de drenaje. Si esto ocurre, la bomba de drenaje empleada en este equipo, está diseñada para revertir el sistema de drenaje automáticamente, de manera que devolverá el artículo en el desagüe. Si por algún motivo usted tuviera que retirar manualmente un artículo de la bomba de drenaje, antes de quitar los filtros, usted deberá apagar y desconectar el equipo de la corriente luego quitar el pequeño inserto negro del sumidero. En caso de haber residuos de agua, estos deberán ser secados antes de proseguir. Saque el artículo que causa la obstrucción, este debe encontrarse en el sumidero. Recuerde colocar el inserto negro antes de re-instalar los filtros.

## **MANTENIMIENTO**

### **Después de cada lavado**

Cierre la llave del ingreso de agua y deje la puerta ligeramente entreabierta, de esta manera la humedad y los malos olores no quedarán atrapados en el interior.

### **No use productos de limpieza solventes o abrasivos**

Para limpiar las superficies exteriores y las partes de goma no use productos de limpieza solventes o abrasivos. En lugar de estos productos use un paño limpio y agua tibia jabonosa. Para quitar manchas u óxido de la superficie interior del equipo use un paño humedecido con agua y un poco de vinagre o un producto de limpieza diseñado específicamente para lavaplatos.

### **Cuando se vaya de vacaciones**

Se recomienda que realice un ciclo de lavado con el lavaplatos vacío, desenchufe el equipo, cierre la llave de entrada de agua y deje la puerta del lavaplatos ligeramente entreabierta. Esto alargará la vida de los sellos del equipo y prevendrá la formación de malos olores en el interior del mismo.

### **Sellos**

Uno de los factores que causa el mal olor en el lavaplatos es la comida que queda atrapada en los sellos. Periódicamente límpielos con una esponja húmeda, lo cual prevendrá la formación de los mismos.

ANTES DE LLAMAR AL SERVICIO TECNICO

Problema	Posibles Causas	Que hacer? Selección de Ciclo
Hay una capa blanca en los platos	Combinación de agua blanda y mucho detergente	Use menos detergente si tiene agua blanda y seleccione un ciclo de lavado más corto para lavar la cristalería.
Hay una capa amarilla o marrón en las superficies internas Hay una capa blanca en las superficies internas	Manchas de te o café Los depósitos de hierro en el agua pueden causar una capa en todo el equipo  Minerales de agua dura	Use una mezcla de 1/2 taza de blanqueador y 3 tazas de agua tibia para quitar manualmente las manchas.  Llamar a la compañía de agua y pedir un filtro especial. Para limpiar el interior, use una esponja húmeda con detergente para lavaplatos y use guantes de goma. Nunca use otra clase de limpiador que no sea el diseñado específicamente para lavaplatos. Reacomode los platos apropiadamente.
Hay detergente en las tazas dispensadoras	Los platos bloquean las tazas de detergente	Siempre habrá algo de vapor que se escape por entre la puerta durante el desagüe y el secado.
Vapor	Normal	Use un limpiador abrasivo suave para eliminar esas marcas.
Manchas negras y grises en los platos	Artículos de aluminio junto a los platos	Un poco de agua limpia cerca del ingreso de agua en el fondo de la tina mantendrá el sello de agua lubricado.
Hay agua en el fondo de la tina	Normal	Asegúrese que el lavadero de la cocina esté drenando bien. Si su equipo drena en un regulador, debe limpiarlo o destupirlo.
El agua en la tina no drena	El desagüe está tupidado	Asegúrese de no sobrecargar el depósito de aditivos para el enjuague. El derrame de este fluido puede causar exceso de espuma y derrames. Limpie cualquier salpicadura o exceso con un paño húmedo. Asegúrese de nivelar correctamente el lavaplatos.
El lavaplatos gotea El lavaplatos hace ruido	Depósitos sobrecargados o el aditivo de enjuague se está derramando  El lavaplatos está desnivelado	

## Registration Information

Thank you for purchasing this fine Avanti product. Please fill out this card and return it within 100 days of purchase and receive these important benefits:

- **Protect your product:**  
We will keep the model number and date of purchase of your new Avanti product on file to help you refer to this information in the event of an insurance claim such as fire or theft.
- **Promote better products:**  
We value your input. Your responses will help us develop products designed to best meet your future needs.

------(detach here)-----

### Avanti Registration Card

Name	Model #	Serial #
Address	Date Purchased	Store/Dealer Name
City                      State                      Zip	Occupation	
Area Code              Phone Number	<b><u>As Your Primary Residence, Do You:</u></b> <i>f</i> Own <i>f</i> Rent	
<b><u>Did You Purchase An Additional Warranty:</u></b> <i>f</i> Extended <i>f</i> None	<b><u>Your Age:</u></b> <i>f</i> under 18 <i>f</i> 18-25 <i>f</i> 26-30 <i>f</i> 31-35 <i>f</i> 36-50 <i>f</i> over 50	
<b><u>Reason For Choosing This Avanti Product:</u></b> Please indicate the most important factors that influenced your decision to purchase this product. <i>f</i> Price <i>f</i> Product Features <i>f</i> Avanti Reputation <i>f</i> Product Quality <i>f</i> Salesperson Recommendation <i>f</i> Friend/Relative Recommendation <i>f</i> Warranty <i>f</i> Other _____	<b><u>Marital Status:</u></b> <i>f</i> Married <i>f</i> Single <b><u>Is This Product Used In The:</u></b> <i>f</i> Home <i>f</i> Business <b><u>How Did You Learn About This Product:</u></b> <i>f</i> Advertising <i>f</i> In Store Demo <i>f</i> Personal Demo <i>f</i> Other _____	
	Comments _____ _____ _____	

