

AIR CONDITIONER
REMOTE CONTROLLER ILLUSTRATION

CR002-RG05D4
202055090978

Thank you very much for purchasing our air conditioner.
Please read this owner's manual carefully before using
your air conditioner.

CONTENTS

Handling the remote controller	2
Remote controller Specifications.....	3
Function buttons	4
Indicators on LCD	7
How to use the buttons	
Initial setting the clock	8
Auto operation.....	9
Cooling/Heating/Fan operation.....	9
Dehumidifying operation	10
Adjusting air flow direction.....	10
Timer operation.....	11
Sleep operation	15

Handling the remote controller

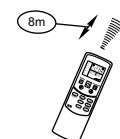
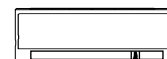

Location of the remote controller.

- Use the remote controller within a distance of 8 meters from the appliance, pointing it towards the receiver. Reception is confirmed by a beep.
- Keep the remote controller where its signals can reach the receiver of the unit. When you select the timer operation, the remote controller automatically transmits a signal to the indoor unit at the specified time. If you keep the remote controller in a position that hinders proper signal transmission, a time lag of up to 15 minutes may occur.

▲ CAUTIONS

- The air conditioner will not operate if curtains, doors or other materials block the signals from the remote controller to the indoor unit.
- Prevent any liquid from falling into the remote controller. Do not expose the remote controller to direct sunlight or heat.
- If the infrared signal receiver on the indoor unit is exposed to direct sunlight, the air conditioner may not function properly. Use curtains to prevent the sunlight from falling on the receiver.
- If other electrical appliances react to the remote controller, either move these appliances or consult your local dealer.

Replacing batteries

The remote controller is powered by two dry batteries(R03/LR03X2) housed in the rear part and protected by a cover.

- (1) Remove the cover by pressing and sliding off.
- (2) Remove the old batteries and insert the new batteries,placing the(+) and (-) ends correctly.
- (3) Reattach the cover by sliding it back into position.

NOTE: When the batteries are removed, the remote controller erases all programming. After inserting new batteries, the remote controller must be reprogrammed.

▲ CAUTIONS

- Do not mix old and new batteries or batteries of different types.
- Do not leave the batteries in the remote controller if they are not going to be used for 2 or 3 months.
- Do not dispose batteries as unsorted municipal waste. Collection of such waste separately for special treatment is necessary.

Remote Controller Specifications

Model	RG05D4/BGE, RG05D4/BGCE
Rated Voltage	3.0V(Dry batteries R03/LR03×2)
Lowest Voltage of CPU Emitting Signal	2.4V
Signal Receiving Range	8m (when using 3.0 voltage, it gets 11m)
Environment	-5°C~60°C

Performance Feature

1. Operating Mode: AUTO, COOL, DRY, HEAT(Cooling only model without), and FAN.
2. Timer Setting Function in 24 hours.
3. Indoor Setting Temperature Range : 17°C~30°C.
4. Full function of LCD (Liquid Crystal Display).

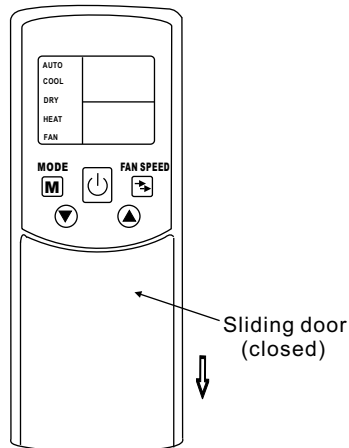

3

Function buttons

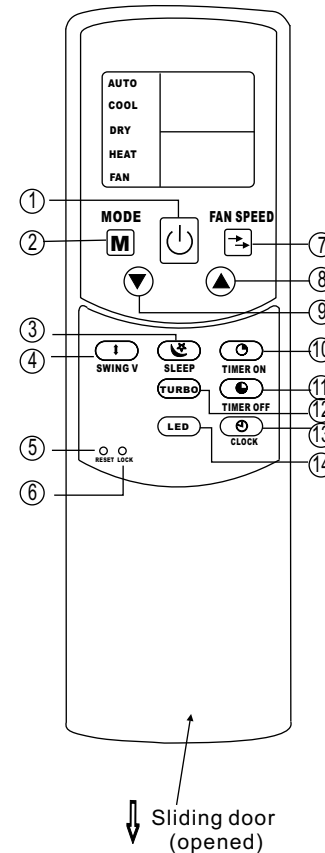

- 1 **ON/OFF Button**
Operation starts when this button is pressed and stops when this button is pressed again.
- 2 **MODE Button**
Each time the button is pressed, the operation mode is selected in a sequence of following:
→AUTO → COOL → DRY → HEAT → FAN

NOTE: Heat mode is for Cooling & Heating models only.

- 3 **SLEEP Button**
Active/Disable sleep function. It can maintain the most comfortable temperature and save energy. This function is available on COOL, HEAT or AUTO mode only .
NOTE: While the unit is running under SLEEP mode, it would be cancelled if MODE, FAN SPEED or ON/OFF button is pressed.

- 4 **SWING V Button**
Used to stop or start horizontal louver movement and set the desired up/down air flow direction. Push once, the louver changes 6 degree in angle. Keep pushing more than 2 seconds, the louver will swing up and down automatically.

- 5 **RESET Button**
Once the recessed RESET button is pressed, all of the current settings will be cancelled and the controller will return to the initial settings.

- 6 **LOCK Button**
Press this recessed button to lock all current settings, and the remote controller will not accept any operation except that of the LOCK. Use the LOCK mode when you want to prevent settings from being changed accidentally. Press the LOCK button again to cancel the LOCK function. A lock symbol will appear on the remote controller display when the lock function is activated.

4

Function buttons(continued)

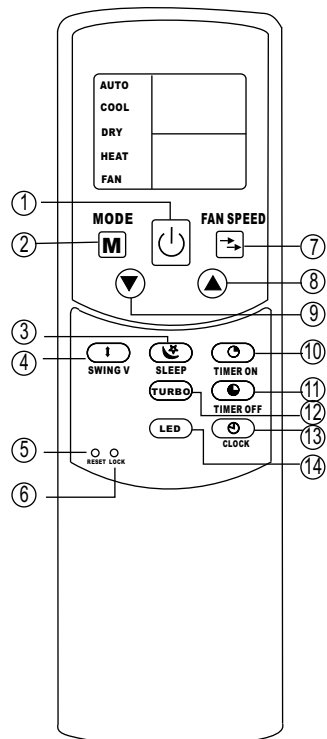

- 7 FAN SPEED Button**
Used to select the fan speed in four steps:
→ AUTO → LOW → MED → HIGH →
- 8 UP Button**
Push this button to increase setting temperature or to increase Hour during Timer setting.
- 9 DOWN Button**
Push this button to decrease setting temperature or to decrease Hour during Timer setting.
- 10 TIMER ON Button**
Press this button to activate the Auto-on time setting. Each press will increase the time setting in 30 minutes increments, up to 10 hours, then at 1 hour increments up to 24 hours. To cancel the Auto-on time setting, just press the button until the time setting is 0.0.
- 11 TIMER OFF Button**
Press this button to activate the Auto-off time setting. Each press will increase the time setting in 30 minutes increments, up to 10 hours, then at 1 hour increments up to 24 hours. To cancel the Auto-off time setting, just press the button until the time setting is 0.0.
- 12 TURBO**
Active/Disable Turbo function. Turbo function enables the unit to reach the preset temperature in the shortest time. When press this button on cooling mode, the unit will blow strong cooling air with super high fan speed. When press this button on heating mode(applicable to the unit adopts PTC only), the PTC will be energized and bring fast heating operation.

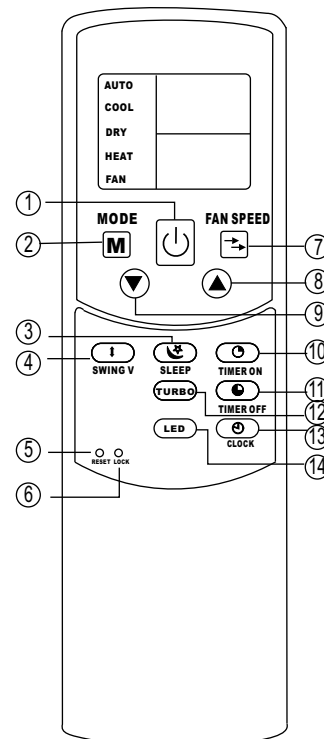

- 13 CLOCK Button**
Used to set the remote clock.
- 14 LED Button**
Disable/Active indoor screen Display. When pushing more than 2 seconds, the room temperature is displayed. Pushing more than 2 seconds again or waiting for 15 seconds, the previous display will revert back in the screen display.
- NOTE:**
- Buttons design might be slightly different from the actual one depending on individual models.
 - All the functions described above are accomplished by the indoor unit, if the indoor unit has no this feature, there is no corresponding operation happened when press the relative button on the remote controller.

Indicators on LCD

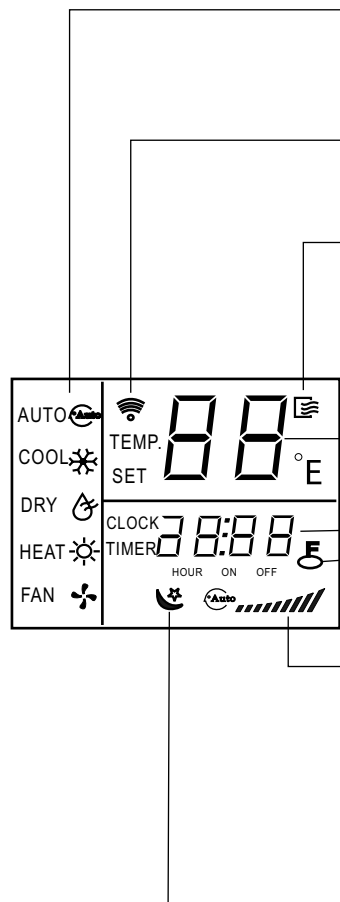

Mode display

Displays the current operation mode. Including AUTO (Auto), COOL (❄️), DRY (☁️), HEAT (🔥) (Not applicable to cooling only models), FAN (🌀) and back to AUTO (Auto).

Transmission Indicator

This transmission indicator lights when remote controller transmits signals to the indoor unit.

ON/OFF display

Displayed by pressing the ON/OFF button. Press the ON/OFF button again to remove.

Temp. display

Displays the temperature setting (17°C~30°C). When you set the operating mode to FAN, no temperature setting is displayed.

Time display

Indicate Timer on/off time (0:00~23:50 hours) or clock time. The clock time is indicated only when no AUTO-ON/OFF timer is set. When AUTO-TIMER feature is operating, it displays the AUTO-ON/OFF time. To check the current time, press the CLOCK button, and the time will display.

Fan speed display

Displays the selected fan speed, AUTO (Auto) and three fan speed levels "////" (LOW) "//////" (MED) "////////" (HIGH) can be indicated. The fan speed is auto controlled under AUTO or DRY mode.

Lock Display

Displayed when LOCK mode is activated.

Sleep Display

Displayed under sleeping operation. Press the SLEEP button again to remove.

Note:

All displays on the remote controller are shown for illustration purposes only.

How to use the buttons

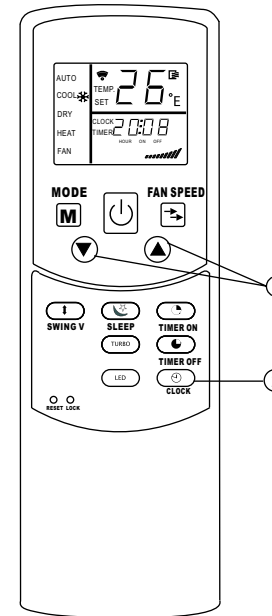

Before you start operating the air conditioner, set the clock of the remote controller using the procedures given in this section. The clock panel on the remote controller will display the time regardless of whether the air conditioner is in use or not.

Initial Setting the Clock

After batteries are inserted in the remote controller, the clock panel will display "12:00" and begin to flash.

1. UP/DOWN button

Press these buttons to set time.

- ▲ Forward.
- ▼ Backward.

Each time you press the button, the time moves forward or backward by one minute depending on which side you press. The time alters as quickly as you push the button.

Keep pressing the button without releasing, the time moves forward or backward by 10 minutes depending on which side you press.

2. CLOCK button

When the right time is achieved, press the CLOCK button or release the ▲ or ▼ and wait for 5 seconds, the clock time stops flashing and the clock starts operating.

3. Readjusting the Clock

Press the CLOCK button on the remote controller, the time of the clock display will start to flash. To set the new time, follow 1 and 2 of "Initial Setting of the Clock".

Note: The time of the CLOCK must be set before the AUTO-TIMER feature will operate.

* Clock accuracy is within 15 seconds per day.

CAUTION

Static electricity or other factors (Voltage transients) can cause the remote controller clock to initialize. If your remote controller is initialized (the time of "12:00" flashing), readjust the clock before starting the unit.

Auto operation

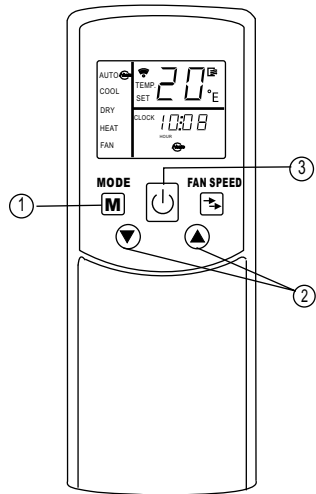

Ensure the unit is plugged in and power is available. The OPERATION indicator on the display panel of the indoor unit starts flashing.

1. Press the **MODE** button to select Auto.
2. Press the **UP/DOWN** button to set the desired temperature. The temperature can be set within a range of 17°C~ 30°C in 1°C increments.
3. Press the **ON/OFF** button to start the air conditioner.

NOTE

1. In the Auto mode, the air conditioner can logically choose the mode of Cooling, Fan, and Heating by sensing the difference between the actual ambient room temperature and the setting temperature on the remote controller.
2. In the Auto mode, you can not switch the fan speed. It has already been automatically controlled.
3. If the Auto mode is not comfortable for you, the desired mode can be selected manually.

Cooling /Heating/Fan operation

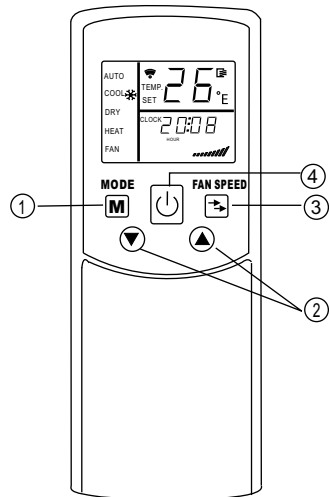

Ensure the unit is plugged in and power is available.

1. Press the **MODE** button to select COOL, HEAT, (cooling & heating models only) or FAN mode.
2. Press the **UP/DOWN** buttons to set the desired temperature. The temperature can be set within a range of 17°C~ 30°C in 1°C increments.
3. Press the **FAN SPEED** button to select the fan speed in four steps- Auto, Low, Med, or High.
4. Press the **ON/OFF** button to start the air conditioner.

NOTE

In the FAN mode, the setting temperature is not displayed in the remote controller and you are not able to control the room temperature either. In this case, only step 1, 3 and 4 may be performed.

Dehumidifying operation

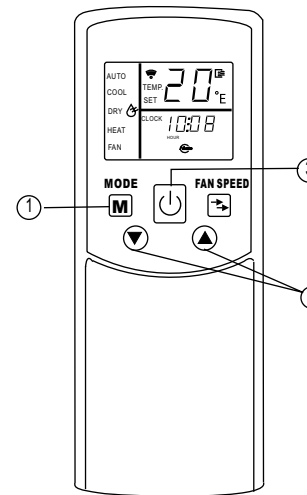

Ensure the unit is plugged in and power is available. The OPERATION indicator on the display panel of the indoor unit starts flashing.

1. Press the **MODE** button to select DRY mode.
2. Press the **UP/DOWN** buttons to set the desired temperature. The temperature can be set within a range of 17°C~ 30°C in 1°C increments.
3. Press the **ON/OFF** button to start the air conditioner.

NOTE

In the Dehumidifying mode, you can not switch the fan speed. It has already been automatically controlled.

Adjusting air flow direction

Use the SWING V button to adjust the desired airflow direction.

- When push the SWING V button, the horizontal louver changes 6 degree in angle for each push. Keep pushing more than 2 seconds, the louver will swing automatically and give UP and DOWN air flow.

NOTE: When the horizontal louver swing or move to a position which would affect the cooling or heating effect of the air conditioner, it would automatically change the swing/moving direction.

Timer operation

press the TIMER ON button can set the auto-on time of the unit. And press the TIMER OFF button can set the auto-off time of the unit.

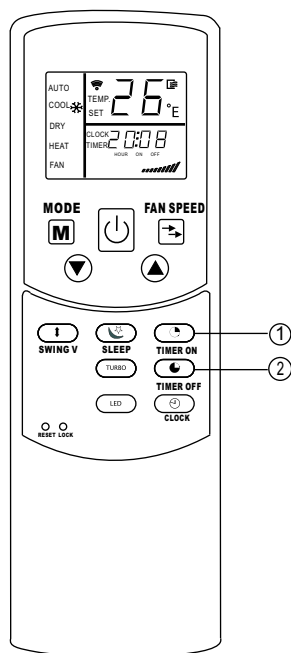

To set the Auto-on time.

1. Press the TIMER ON button. The remote controller shows TIMER ON, the last Auto-on setting time and the signal "HOUR" will be shown on the LCD display area. Now it is ready to reset the Auto-on time to START the operation.
2. Push the TIMER ON button again to set desired Auto-on time. Each time you press the button, the time increases in 30 minutes increments, up to 10 hours, then at 1 hour increments up to 24 hours.
3. After setting the TIMER ON, there will be a one-half second delay before the remote controller transmits the signal to the air conditioner. Then, after approximately another 2 seconds, the signal "HOUR" will disappear and the set temperature will re-appear on the LCD display window.

To set the Auto-off time.

1. Press the TIMER OFF button. The remote controller shows TIMER OFF, the last Auto-off setting time and the signal "HOUR" will be shown on the LCD display area. Now it is ready to reset the Auto-off time to START the operation.
2. Push the TIMER OFF button again to set desired Auto-off time. Each time you press the button, the time increases in 30 minutes increments, up to 10 hours, then at 1 hour increments up to 24 hours.
3. After setting the TIMER OFF, there will be a one-half second delay before the remote controller transmits the signal to the air conditioner. Then, after approximately another 2 seconds, the signal "HOUR" will disappear and the set temperature will re-appear on the LCD display window.

IMPORTANT

- The effective operation time set by the remote controller for the timer function is limited to the following settings: 0.5, 1.0, 1.5, 2.0, 2.5, 3.0, 3.5, 4.0, 4.5, 5.0, 5.5, 6.0, 6.5, 7.0, 7.5, 8.0, 8.5, 9.0, 9.5, 10, 11, 12, 13, 14, 15, 16, 17, 18, 19, 20, 21, 22, 23 and 24.

Example of Timer setting

TIMER ON (Auto-on Operation)

The TIMER ON feature is useful when you want the unit to turn on automatically before say when you return home. The air conditioner will automatically start operating at the set time.

Example:

To start the air conditioner in 6 hours.

1. Press the TIMER ON button, the last setting of starting operation time and the signal "HOUR" will show on the display area.
2. Press the TIMER ON button to display "6:0" on the TIMER ON display of the remote controller.
3. Wait for 0.5 second and the TIMER ON indicator stops flashing and this function is activated. The digital display area will show the temperature again.

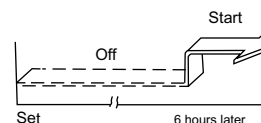

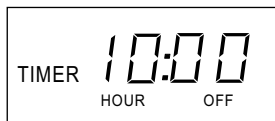

TIMER OFF

(Auto-off Operation)

The TIMER OFF feature is useful when you want the unit to turn off automatically after you go to bed. The air conditioner will stop automatically at the set time.

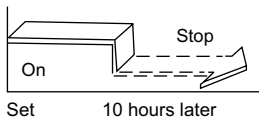

Example:

To stop the air conditioner in 10 hours.

1. Press the TIMER OFF button, the last setting of stopping operation time and the signal "HOUR" will show on the display area.
2. Press the TIMER OFF button to display "10:00" on the TIMER OFF display of the remote controller.
3. Wait for 0.5 second and the TIMER OFF indicator stops flashing and this function is activated. The digital display area will show the temperature again.

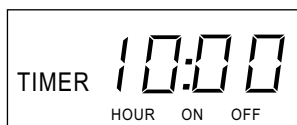

COMBINED TIMER

(Setting both ON and OFF timers simultaneously)

TIMER OFF → TIMER ON

(On → Stop → Start operation)

This feature is useful when you want to stop the air conditioner after you go to bed, and start it again in the morning when you wake up or when you return home.

Example:

To stop the air conditioner 2 hours after setting and start it again 10 hours after setting.

1. Press the TIMER OFF button.
2. Press the TIMER OFF button again to display 2:00 HOUR on the TIMER OFF display.
3. Press the TIMER ON button.
4. Press the TIMER ON button again to display 10:00 HOUR on the TIMER ON display .
5. Wait for the remote control to display the setting temperature.

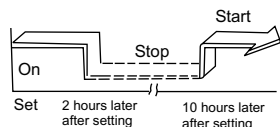

TIMER ON → TIMER OFF

(Off → Start → Stop operation)

This feature is useful when you want to start the air conditioner before you wake up and stop it after you leave the house.

Example:

To start the air conditioner 2 hours after setting, and stop it 5 hours after setting.

1. Press the TIMER ON button.
2. Press the TIMER ON button again to display 2:00 HOUR on the TIMER ON display.
3. Press the TIMER OFF button.
4. Press the TIMER OFF button again to display 5:00 HOUR on the TIMER OFF display .
5. Wait for the remote control to display the setting temperature.

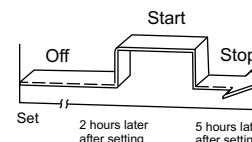

CAUTION

- The timer setting(TIMER ON or TIMER OFF) that in sequence occurs directly after the set time will be activated first.

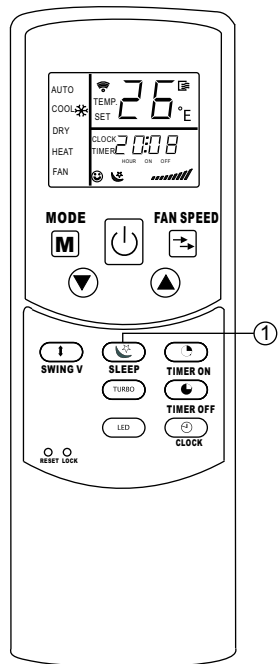

SLEEP operation

When you press the SLEEP button, the energy-saving function will be activated. This symbol

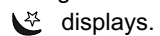

displays.

This function enables the unit to automatically increase (cooling) or decrease (heating) 1°C per hour for the first two hours, then hold steady for the next 5 hours, after that the unit will stop operation. It can maintain the most comfortable temperature and save energy.

NOTE: The SLEEP function is only available under Cooling, Heating and AUTO operations.