

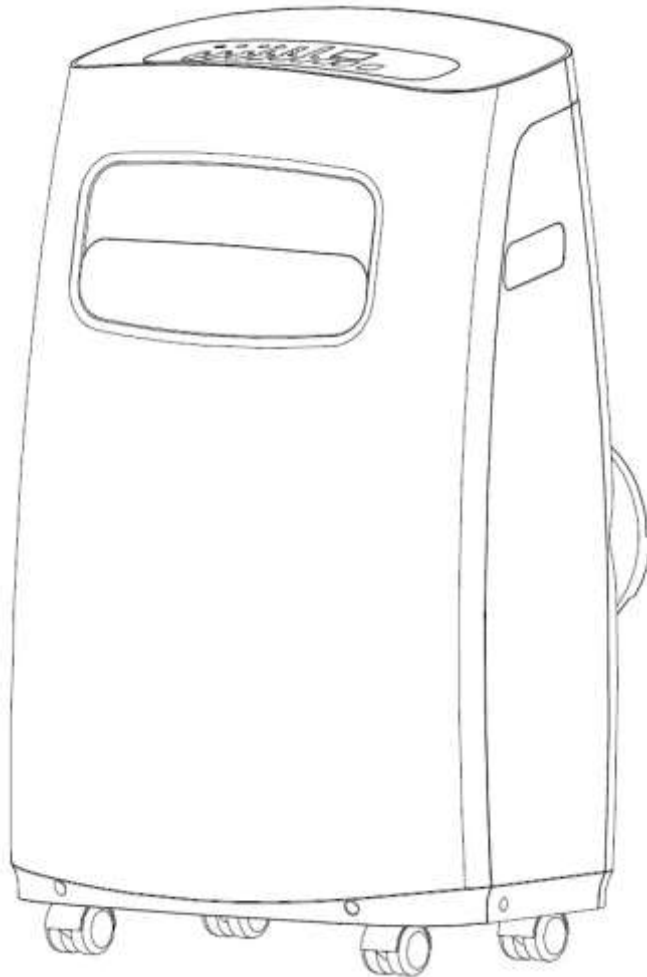

Portable Air Conditioner



PAC802W / PAC1202W

Owner's Manual

*For more information on other great EdgeStar and Koldfront products on the web, go to <http://www.edgestar.com>
To use the EdgeStar self-diagnostic tool, go to <https://support.edgestar.com>*

Important Safety Information

Improper handling can cause serious damage to the appliance and / or to the user.
Please read the following safety information.



Electrical Safety

- This unit is designed for indoor use only.
- Do not use the unit in extremely humid or wet environments.
- Do not wet the housing or control panel.
- Do not pull the unit by the cord.
- Always turn the unit off and unplug it from the socket when cleaning.
- Unplug the unit if it is not going to be used for a long period of time.
- Do not operate the unit with a damaged plug or loose socket.
- Use only the correct power supply with appropriate amperage.
- If the power cord is damaged, it must be replaced by the manufacturer, a service agent, or a qualified technician.
- Do not remove any part of the casing unless instructed to do so by an authorized technician.



General Safety

- This portable air conditioner is not intended to be used by children.
- Children should be supervised to ensure that they do not play with this product.
- Do not allow children to play with the controls or drop any objects into the air outlets or vents.
- Do not place objects or let any person sit on top of the unit.
- Only use in the upright position on a flat, level surface and provide at least 20 inches of clearance from any walls or objects.
- Route the power cord carefully to avoid a tripping hazard.
- This unit is intended for domestic use only. Do not use the portable air conditioner for industrial or commercial use. Any other use may invalidate the warranty.

Operation of Safety Plug



Note: Electrical products should not be disposed of with household waste. Please contact your local recycling center for more information about how to recycle electronic waste.



Your portable air conditioner is supplied with a Leakage-Current Detection and Interruption (LCDI) safety plug. This device provides protection to reduce the risk of fire due to arcing faults in the power supply cord. Before using your portable air conditioner, follow the instructions below to ensure that the LCDI plug is working properly:

1. Plug the power cord into a grounded outlet.
2. Press the TEST button on the LCDI plug. This should trip the plug and cut the power to the air conditioner. If the plug does not trip and you are able to turn on the unit, please contact EdgeStar support.

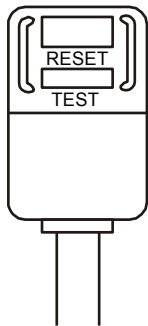

DO NOT USE YOUR PORTABLE AIR CONDITIONER IF THE TEST FAILS.

Press the RESET button to start using your air conditioner.

DO NOT use the TEST and RESET buttons as an ON / OFF switch.

Table of Contents

IMPORTANT SAFETY INFORMATION	I
OPERATION OF SAFETY PLUG	II
INTRODUCTION	1
PARTS IDENTIFICATION	2
FRONT VIEW.....	2
BACK VIEW.....	2
WINDOW KIT INSTALLATION INSTRUCTIONS	3
PREPARATIONS FOR INSTALLING THE WINDOW KIT.....	3
<i>Window Kit Parts list</i>	3
INSTALLATION PREPARATION.....	4
<i>Location</i>	4
<i>Window Slider Kit Preparation</i>	4
INSTALLATION IN A DOUBLE HUNG SASH WINDOW.....	5
INSTALLATION IN A SLIDING SASH WINDOW.....	6
CONNECTING THE EXHAUST HOSE.....	8
NOTES ABOUT THE EXHAUST HOSE	10
DRAINING THE UNIT	11
CONTINUOUS DRAIN.....	11
MANUAL DRAIN.....	11
CONTROL PANEL OVERVIEW	12
USING THE CONTROL PANEL	13
LED DISPLAY.....	13
MODE INDICATOR LIGHTS.....	13
<i>Cooling Operation</i>	13
<i>Dry Operation (Dehumidify)</i>	13
<i>Auto Operation</i>	13
<i>Fan Operation</i>	13
POWER BUTTON.....	13
SWING.....	13
TIMER.....	14
SLEEP.....	14
INCREASE / DECREASE.....	14
FAN INDICATOR LIGHTS.....	14
REMOTE CONTROL	15
REMOTE CONTROL BATTERIES.....	17
ERROR CODES	17
ERROR CODES ON LED DISPLAY.....	17
PROTECTION CODES ON LED DISPLAY.....	17
MAINTENANCE	17
CLEANING THE UNIT.....	17
CLEANING THE PRE-FILTER.....	18
PREPARATION FOR STORAGE.....	18
ENERGY SAVING GUIDE	18
TROUBLESHOOTING	19
SPECIFICATIONS	21
EDGE STAR LIMITED WARRANTY	22

Introduction

Thank you for purchasing this Koldfront by EdgeStar portable air conditioner. We hope that this purchase will be the beginning of a lasting and rewarding relationship between you and EdgeStar. We will provide the customer support and exemplary products necessary to nurture that relationship.

This manual contains important information regarding the proper installation, use, and maintenance of your portable air conditioner. Following this manual will ensure that your product will work at its peak performance, efficiency, and safety.

Please save the original product packaging in case you need to safely transport your portable air conditioner.

For Your Records:

Please write down the model number and serial number below for future reference. Both numbers are located on the ratings label on the back of your unit and are needed to obtain warranty service. You may also want to staple your receipt to this manual as it is the proof of your purchase, and is also needed for service under your warranty.

Model Number: _____

Serial Number: _____

Date of Purchase: _____

For a more efficient experience, please do the following before contacting customer service:

- If you received a damaged product, immediately contact the dealer that sold you the product.
- Read and follow this instruction manual carefully to help you install, use and maintain your portable air conditioner.
- Read the troubleshooting section of this manual as it will help you diagnose and solve common issues.
- Visit us on the web at <http://www.edgestar.com> for product guides, additional troubleshooting resources, and up-to-date information. You can also find an interactive self-diagnostic tool at <https://support.edgestar.com>. If you need service, our friendly customer service representatives are available via email at service@edgestar.com or by telephone at **1 (866) 319-5473**.

Parts Identification

Front View

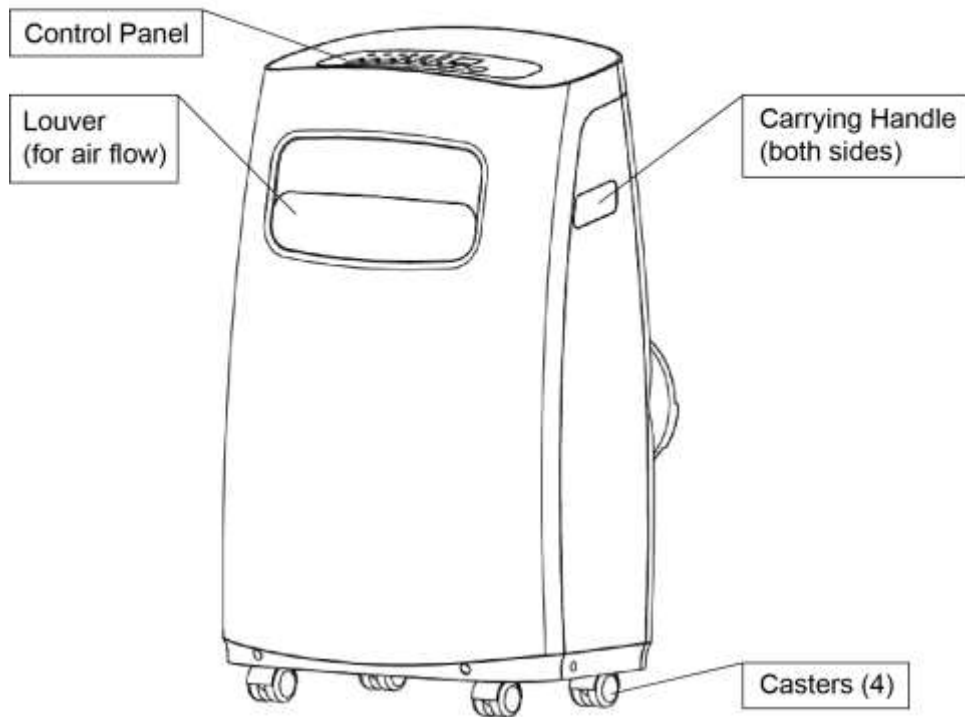

Back View

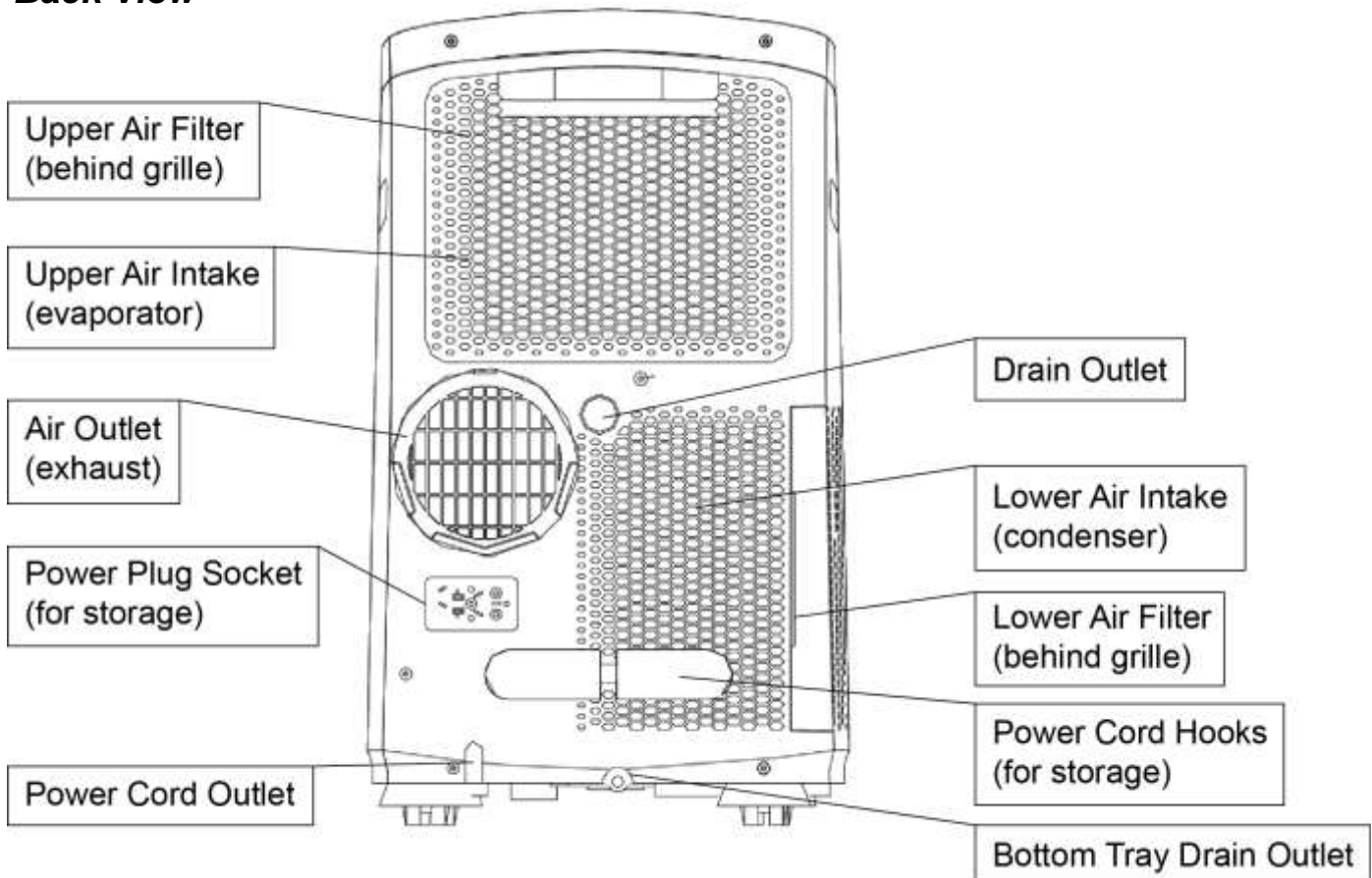







Window Kit Installation Instructions

Preparations for Installing the Window Kit

You must vent your portable air conditioner when running it in cooling mode. Your unit includes a window exhaust kit that can be used to vent the unit out of a window.

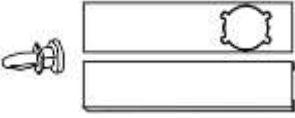
Before you begin, make sure that you have all the parts necessary for installation and that a suitable location is picked.

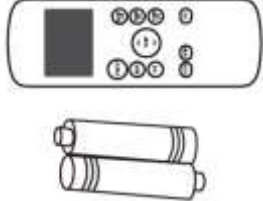
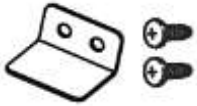
Window Kit Parts list:

 <p>Exhaust Hose</p>	 <p>Hose Adaptor A</p>	 <p>Window Kit Adapter B</p>
 <p>Adjustable Window Slider Kit (with bolt)</p>	 <p>Foam Seal – (Adhesive) - two (2) short pieces - two (2) long pieces</p>	 <p>Foam Seal (Non-Adhesive) - one (1) long piece</p>
 <p>Remote Control with Batteries</p>	 <p>Security Bracket with two (2) screws</p>	 <p>Drain Hose</p>

If you have multiple windows, choose one that is near an electrical outlet that will be able to provide sufficient power to your unit. See the power requirements listed on the product label printed on the side, or on the back of your portable air conditioner.



Note: You may need to contact your electrician if your room's circuit is not able to power your unit.

Your window kit can be installed on a horizontal or vertical sliding window as shown in the following images and instructions. Follow the instructions for your desired window kit installation.

Installation Preparation

Before you begin, make sure you have all the parts necessary for installation and that you have selected a suitable location.

Location

When choosing a location, please keep in mind:

- The air conditioner should be placed on a firm, level location in order to minimize noise and vibration. Your appliance has casters to aid in placement. Use caution when rolling on carpet and do not attempt to roll the unit over any objects as this may result in the unit tipping over.
- Never place any obstacles near the air inlet or outlet of the unit.
- Allow at least 20" of space from the wall for efficient performance.

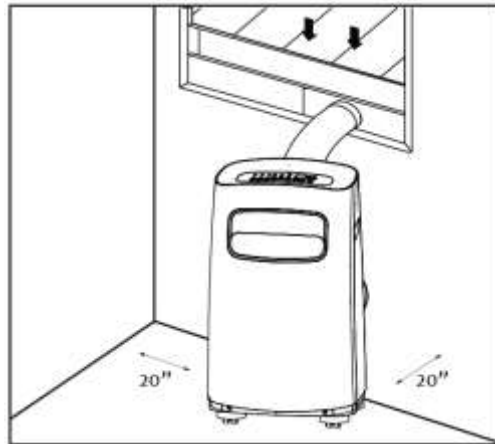

Window Slider Kit Preparation:

- Your window slider kit has been designed to fit most standard vertical and horizontal window applications
- If the window opening is less than the minimum length of the window slider kit, you may trim the slider panel B. (Trim the side farthest from exhaust port).
- Slide Panel A inside panel B and adjust to the correct width. To secure the panels together, press the Window Slider Kit 'Bolt' into the appropriate slot on the edge of Panel A.

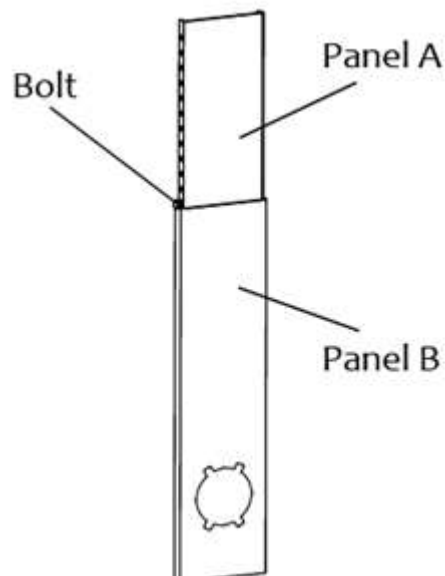

Installation in a Double Hung Sash Window

Step 1

Cut the foam seal to the proper length and attach it to the window sill, and window frame as shown in the image to the left. Your window kit includes four (4) adhesive backed foam strips for this step, two that are short and two that are longer.

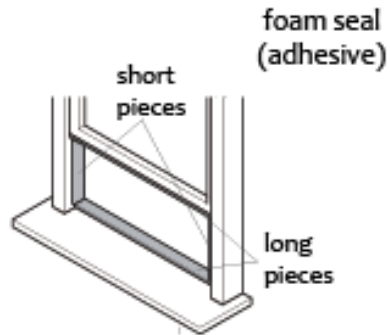

Note: If desired, you may choose to attach the adhesive foam seal to the window slider kit instead of the window sill and frame.

Step 2

Attach the window slider kit to the window sill. Adjust the length of the window slider kit according to the width of the window. Use the window slider “bolt” to secure the slider to the correct width. Open the window sash and place the window slider kit on the window sill then close the window sash securely against the window slider kit.

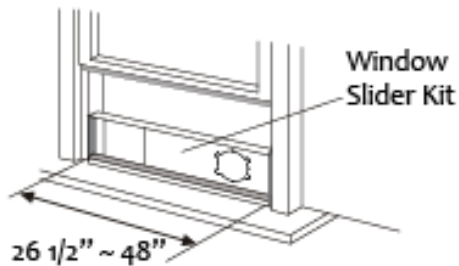

Note: If needed, you may trim the adjustable window kit if the width of the window is less than 26.5".

Step 3

Cut the foam seal to an appropriate length and seal the open gap between the top window sash and the outer window sash.

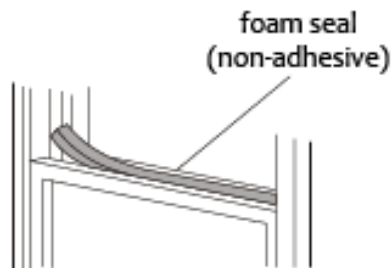

Step 4

If desired, secure the security bracket to the window frame. When installed properly, the bracket will prevent the window sash from being opened.

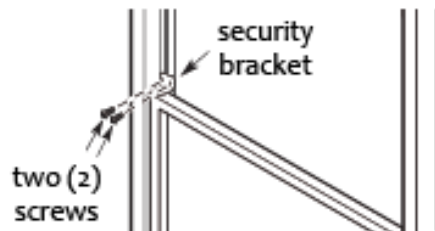

Installation in a Sliding Sash Window

Step 1

Cut the foam seal to the proper length and attach it to the window sill and the window frame as shown in the image below. Your window kit includes four (4) adhesive backed foam strips for this step: two that are short and two that are longer.

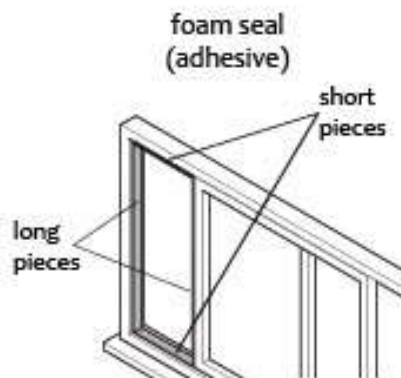

Note: If desired, you may choose to attach the adhesive foam seal to the window slider kit instead of the window sill and frame.

Step 2

Attach the window slider kit to the window sill. Adjust the length of the window slider kit according to the width of the window. Use the window slider “bolt” to secure the slider to the correct width. Open the window sash and place the window slider kit on the window sill then close the window sash securely against window slider kit.

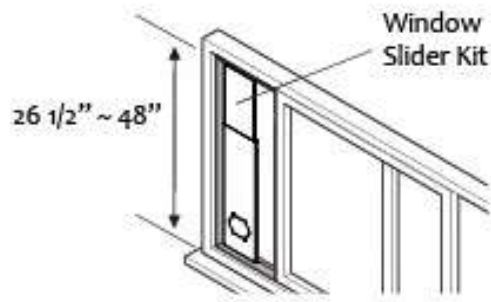

Note: If needed, you may trim the adjustable window kit if the width of the window is less than 26.5".

Step 3

Cut the foam seal to an appropriate length and seal the open gap between the top window sash and outer window sash.

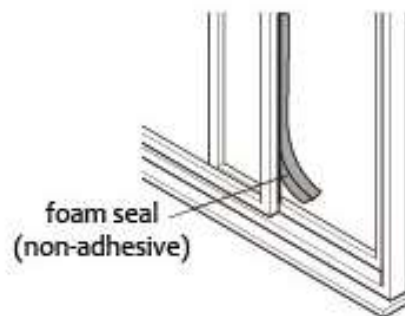

Step 4

If desired, secure the security bracket to the window frame. When installed properly, the bracket will prevent the window sash from being opened.

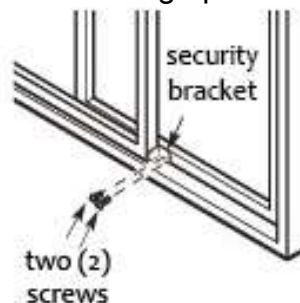

Connecting the Exhaust Hose

Step 1

Connect the Adapters to the Exhaust Hose

To connect the Window Exhaust Adapter (a) to the Exhaust Hose (b), simply extend the open end of the flexible exhaust hose so that you can thread the adapter into place. Rotate the adapter until tightened securely. Repeat this process for Hose Adapter (c) and tighten securely.

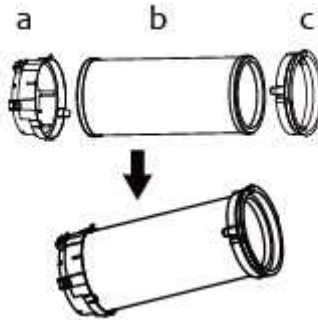

Step 2

Place the Unit in the Installation Location

Roll the unit towards the location where the window kit has been installed. Please ensure that the unit is at least 20 inches from the wall to ensure proper ventilation.



Step 3

Connect the Exhaust Hose to the unit

Align the hooks on the Hose Adapter (c) to the Exhaust Air Outlet on the back of the unit. Slide the hose downward and into place.



Step 4

Connect the Exhaust Hose to the Window Kit

Push the Window Exhaust Adapter which has been attached to the Exhaust Hose through the window kit hole and rotate until it is secure.

After you have installed the exhaust hose and window kit, you can plug in your portable air conditioner and power it on.

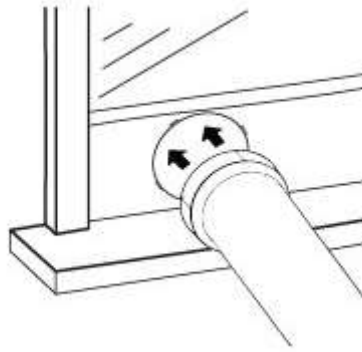

Notes About the Exhaust Hose

Your portable air conditioner is designed to exhaust condensed water that is collected from the air. This water, in either gaseous or droplet form, will be expelled out of the exhaust port of the unit. Please take this into account when deciding how to vent it.

1. The exhaust hose supplied with the portable air conditioner can be extended up to approximately 48 inches; however for maximum efficiency, use the shortest length possible.
2. Try to prevent any kinks or bends in the exhaust hose. Kinks or bends may trap exhaust air which can radiate heat into the room or potentially cause the portable air conditioner to overheat and shut itself off.
3. The exhaust hose supplied with the portable air conditioner has been specifically designed for this air conditioner. Do not lengthen the hose by adding additional hoses or attachments. Do not replace it with any other hose.

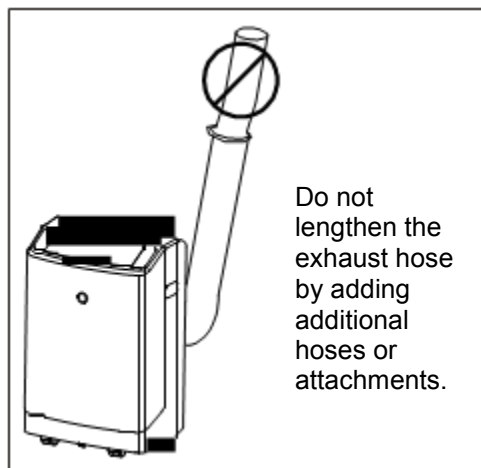

Warning: Longer hoses are not recommended.

The exhaust hose must be installed or removed in accordance with the usage modes:

A: You must install the exhaust hose if the unit is in Cooling Mode.

B: In Dehumidify Mode and Fan Mode, the unit can operate with or without the exhaust hose attached. If you choose to operate the unit without the exhaust hose in these modes the air conditioner will be more portable. However, because the exhaust hose removes hot air and moisture from the room, more cooling will occur in Dehumidify Mode if the exhaust hose is attached.



Note: The exhaust hose may be adjusted according to your installation requirements. However, it is recommended to keep the exhaust hose length at its shortest allowable length for the best airflow efficiency.

Draining the Unit

When the portable air conditioner is in cooling mode, or dehumidify mode, it will remove moisture from the air. The condensed water from the air will be collected in an internal reservoir and will be evaporated and exhausted out of the exhaust hose. However, in very humid conditions, the internal reservoir may fill completely. This causes the air conditioner to turn off to avoid overflowing the internal reservoir, the fan will continue to operate.

Continuous Drain

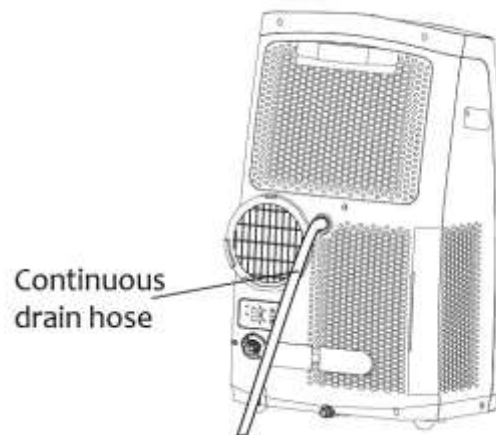

During dehumidifying mode, remove the upper drain plug from the back of the unit. Attach the drain hose to the continuous drain outlet and route the end of the drain hose to a suitable drainage port.

Manual Drain

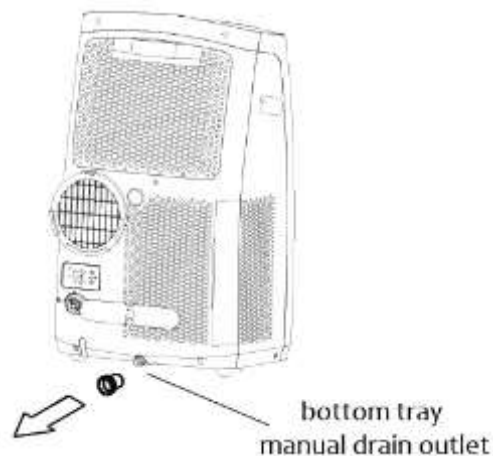

During cooling mode, once the water level of the bottom tray reaches capacity the unit will beep several times and the digital display on the control panel will read "P1" to indicate the water must be manually drained. Carefully move the unit to a drain location then remove the bottom drain plug and connect the drain hose to the drain outlet. The portable air conditioner will now drain through the drain hose. Please note that this unit has no drain pump; all water will drain with gravity only, i.e., only "downhill."

Once the unit is fully drained reinstall the bottom drain plug and restart the machine until the "P1" symbol disappears.

Control Panel Overview

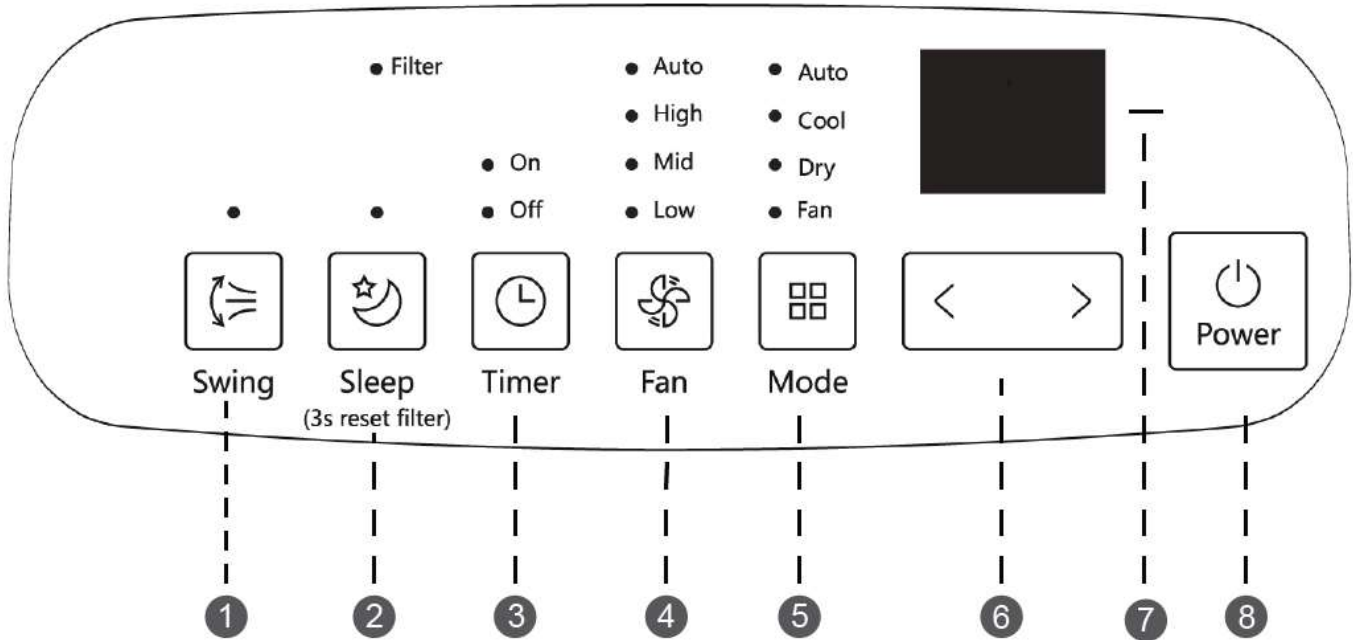

1	Swing	This button is used to initiate the Auto swing feature. During operation, you may press the SWING button to stop and hold the louver at the desired angle.
2	Sleep	Select this button to initiate the SLEEP / ECO operation. <u>Note:</u> After 250 hours of operation, the Filter indicator light will illuminate. This feature is a reminder to clean the Air Filter for more efficient operation. Press this button for 3 seconds to reset the reminder.
3	Timer	This button is used to initiate the AUTO ON start time and AUTO OFF stop time program, in conjunction with the < and > buttons. The Timer On/Off indicator will illuminate when the timer function is active.
4	Fan Selector	Press this button to select the fan speed from the following setting choices: LOW, MID, HIGH, and AUTO. The fan speed indicator will illuminate the fan speed that has been selected.
5	Mode Selector	This button selects the appropriate operating mode.
6	Increase / Decrease	Use these buttons to adjust temperature settings or the TIMER setting.
7	LED Display	When in DRY and FAN modes, this display shows the room temperature. In other modes, the display shows the set temperature in °C or °F. It will also display any error codes or alerts.
8	Power	This button powers the unit on and off.

Using the Control Panel

LED Display

In cooling mode and auto-timer setting the display will show the set temperature in either °C or °F. In dehumidify or fan mode the display will show the current temperature of the room. The LED display will also display error codes and protection codes. Refer to the Error Code section in this manual for additional information.

Mode Indicator Lights

Select the desired mode setting. Each time you press the “mode” button on the control panel a mode is selected in a sequence: AUTO – COOL – DRY – FAN. The mode indicator light illuminates under the different mode settings.

 Auto

 Cool

 Dry

 Fan

Cooling Operation

Press the MODE button until the COOL indicator light comes on. Press the < and > arrows to select your desired room temperature. Press the FAN button to choose the fan speed.

Dry Operation (Dehumidify)

Press the MODE button until the DRY indicator light comes on. Under this mode you cannot select a fan speed or adjust the temperature.

Auto Operation

Press the MODE button until the AUTO indicator light comes on. When the air conditioner is set in AUTO mode it will automatically select cooling or fan depending on what temperature you have selected and the current ambient temperature. Under this mode you cannot select the fan speed.

Fan Operation

Press the MODE button until the FAN indicator light comes on. Press the FAN button to choose the fan speed. The temperature cannot be adjusted.

Power Button

Use the Power button to turn the portable air conditioner on and off. By default, when you first use the power button, the unit will begin to operate in cooling mode. The unit will remember the last used mode and settings if you shut it down and then restart.

Auto-Restart: If power to the unit is interrupted, the air conditioner will restart itself in its last used mode and settings once power is restored. The compressor will restart after 3 minutes.

Swing

When the Power is ON, the louvers open fully.

Press the SWING button on the panel or remote control to initiate the Auto swing feature. The louver will swing up and down automatically.

Note: Please do not adjust the louver manually.

Timer

When the unit is on, press the timer button to initiate the Auto-off stop program, the TIMER OFF indicator light will illuminate. Press the < or > button to select the desired time. Press the TIMER button again within five seconds, the Auto-on start program is initiated and the TIMER ON indicator light will illuminate. Press the < or > button to select the desired Auto-on start time.

When the unit is off, press the TIMER button to initiate the Auto-on start program, press it again within five seconds and the Auto-off stop program will initiate.

Press or hold the < or > button to change the Auto time by 0.5 hour increments, up to 10 hours, then at 1 hour increments up to 24 hours. The control will count down the time remaining until the unit starts. The system will automatically revert back to display the previous temperature setting if no button is pressed within five seconds.

Sleep

Select to initiate the SLEEP / ECO operation. The selected temperature will increase (cooling) by 1°C / 1°F 30 minutes. The temperature will then increase (cooling) by another 1° C / 1° F after an additional 30 minutes. This new temperature will be maintained for 7 hours before it returns to the originally selected temperature. This ends the Sleep / Eco mode and the unit will continue to operate as originally programmed.

Note: This feature is unavailable under FAN or DRY mode.

Increase / Decrease

These buttons are used to increase or decrease the temperature settings (1° C / 2° F increments) in a range of 17° C (62° F) to 30° C (88° F) or the TIMER setting in a range of 1-24 hrs.

The control panel is capable of displaying the temperature in Fahrenheit or Celsius. To convert from one to the other, press and hold the UP and DOWN buttons at the same time for 3 seconds.

Fan Indicator Lights

Press to select the fan speed in four settings- LOW, MED, HIGH, and AUTO. The fan speed indicator light illuminates according to the fan setting that is selected.

Remote Control

The included universal remote control can be used to operate the functions of your portable air conditioner. To operate the remote control, select the desired settings and press the ON / OFF button to start or stop the operation. See below diagrams and chart for additional operation details.

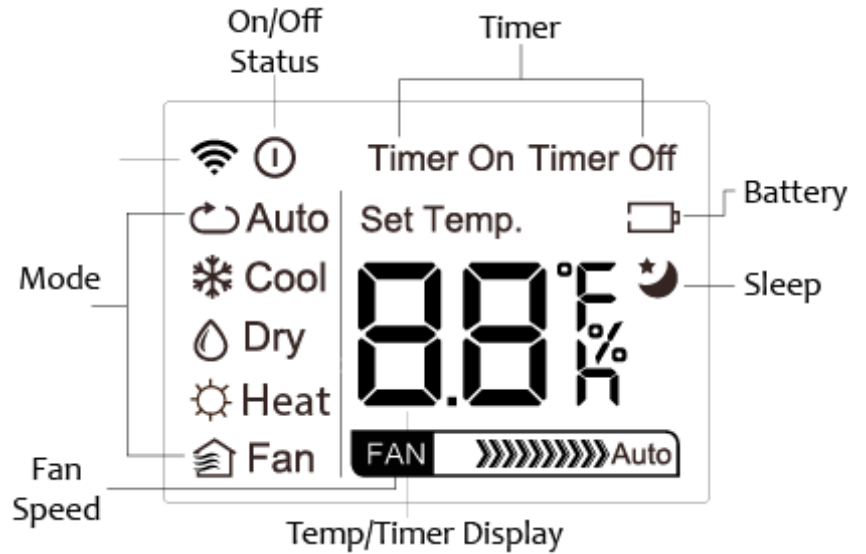
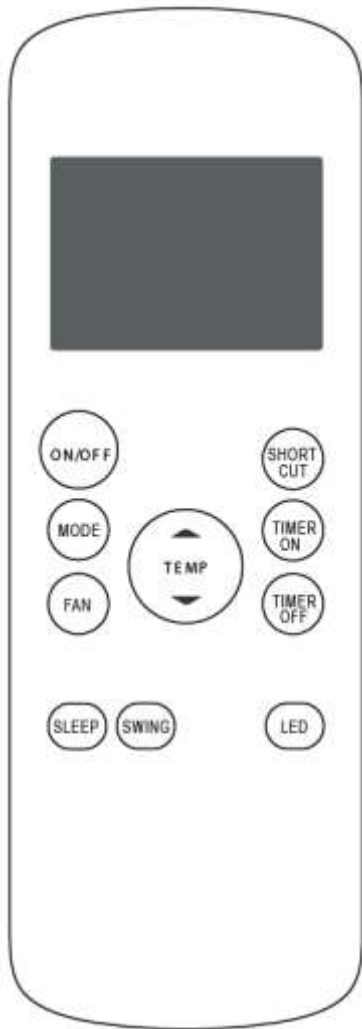

Button	Function
On / Off	Press the ON / OFF button to start or stop the unit after the desired settings have been selected.
Mode	Press the MODE button until you reach your desired operation mode. The remote cycles through the following modes: Auto, Cool, Dry, Heat*, and Fan. *Some editions of the remote may include a heat mode option even though the air conditioner itself does not have a heat function. If this is the case, you will still be able to use the remote to control functions such as auto swing, power on/off, and LED on/off while in heat mode, but you will need to cycle into a different mode in order to adjust air flow and temperature settings.
Fan	Press the MODE button and select FAN mode. Then press the FAN button to select the fan speed: AUTO, LOW, MED, or HIGH.
Sleep	The SLEEP function is used to decrease energy use while you sleep and don't need the same temperature settings as when you are awake. <i>This function can only be activated via remote control and is not available in FAN or DRY mode.</i>
Swing	This button is used to stop or start louver movement and set the desired left/right air flow direction. The louver changes 6 degrees in angle for each button press. If the swing button is held down for more than two (2) seconds, the louver auto swing feature is activated.
LED Display	See the above diagram for LED display details. The display shows the set temperature in °C or °F and the timer settings. While on DRY and FAN modes, the LED display will show the room temperature. The display shows Error codes and Protection codes as well.
Short Cut	This button is used to restore the current settings or resume the previous settings. When this button is pressed, the unit will automatically revert back to the previous settings including operating mode, setting temperature, fan speed level, and sleep feature (if activated). If the Short Cut button is pressed for more than two (2) seconds, the unit will revert to the current settings.
Timer On	Press the TIMER ON button to set the time period for when the unit will automatically turn on. <i>For example, if you set TIMER ON for two hours, the unit will turn on after two hours. Continue to press the TIMER ON button until the desired time setting is reached.</i>
Timer Off	Press the TIMER OFF button to set the time period for when the unit will automatically turn off. <i>For example, if you set TIMER OFF for 2 hours, the unit will turn off after 2 hours. Continue to press the TIMER OFF button until the desired time setting is reached.</i>
LED	This button turns the unit's LED display on or off.
Up / Down	Use the Up and Down arrows to increase or decrease the settings that you are adjusting.

Remote Control Batteries

Your air conditioning unit comes with two AAA batteries. Install the batteries in the remote control before use. To install or replace:

1. Slide the back cover from the remote control downward, exposing the battery compartment.
2. Insert the batteries and be sure to match up the (+) and (-) ends of the batteries with the symbols inside the battery compartment.
3. Slide the battery cover back into place.

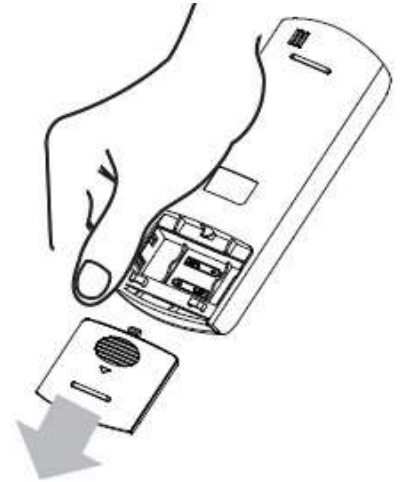

Error Codes

Error Codes on LED Display

- E1 – Room temperature sensor error.
- E2 – Evaporator temperature sensor error.
- E3 – Condenser temperature sensor error.
- E4 – Display panel communication error.

For all error codes, unplug the unit and plug it back in. If the error repeats call for service.

Protection Codes on LED Display

- P1 – Water reservoir full. Connect the drain hose and drain the collected water away. If the error repeats call for service.

Maintenance

Clean the air conditioner and filters regularly to maximize performance and efficiency, and to prolong the unit's life. Be sure to always unplug the air conditioner from the power outlet before cleaning.

Cleaning the Unit

Use a soft dry cloth to wipe the body of the air conditioner clean. If necessary, use lukewarm water to dampen a cloth to clean the unit.

Use a soft bristle brush to clean between the vents.

Carefully use a vacuum cleaner to clean the condenser coils.

Never use abrasive chemicals, volatile substances, gasoline, detergents, chemically treated cloths, or other cleaning solvents that may damage the cabinet exterior.



Warning: Never spray water directly on the unit.

Cleaning the Pre-filter

To clean the pre-filter, follow the steps below:

1. Power off the unit and remove the pre-filter.
2. Use a vacuum cleaner or tap the pre-filter lightly to remove loose dust and dirt, then rinse thoroughly under lukewarm running water (below 104°F). You may use a mild soap and water solution if needed. Allow the pre-filter to air dry in a cool and shaded place. Dry thoroughly before reinstalling.

Clean the pre-filter periodically. If the unit is used in a dusty environment you may need to clean it on a weekly basis.



Warning: Never operate the unit without the pre-filter.

Preparation for Storage

If you are not going to be using the unit for an extended period of time, follow the instructions below before storing your unit:

1. Drain all the water from the unit's reservoir. Operate the unit in fan mode for a few hours to thoroughly dry any moisture left on the coils inside the unit.
2. Power off the unit. Then clean or change the filters.
3. Unplug and carefully wind the power cord.
4. Remove the exhaust hose and duct connectors and keep them in a safe place.

Energy Saving Guide

Read and follow the guide below to get the best performance and efficiency from your portable air conditioner:

- Do not cover the air outlet (exhaust) while in use.
- Do not place the unit in front of curtains or drapes- to ensure they do not obstruct the air intake.
- Minimize the length of the exhaust hose.
- Make sure the exhaust hose is as straight as possible and avoid kinks or bends.
- Keep curtains, blinds, or drapes closed during the sunniest part of the day.
- Use the timer to operate the unit before it is needed. For example, set the timer to turn the unit on in cooling mode for 3 or more hours to cool the room before you arrive. You may want to operate the unit all day if you live in a warmer climate.
- Minimize the heat sources (direct sunlight, computers, servers, people, etc.) in the room.
- Close all windows and doors.
- Use the unit in a contained room. For example, operate the unit in a room with four walls and a ceiling, instead of a partitioned studio, or warehouse.
- Make sure the unit is on a level surface.
- Minimize the amount of humidity in the room. For example, run the unit as a dehumidifier.
- To prolong the compressor's life, please wait at least 3 minutes before turning the unit back on after shutting it off.
- Inspect and clean the pre-filters regularly.
- Perform routine maintenance.

Troubleshooting

Follow the troubleshooting guide below to resolve common issues.

Issue	Possible Cause	Solution
The unit does not turn on when pressing the ON / OFF button.	This is a P1 Error Code.	The bottom tray reservoir is full. Turn off the unit, drain the water from the bottom tray, and restart the unit.
	In COOL mode: the room temperature is lower than the set temperature.	Set a different temperature.
My air conditioner is not functioning at all.	The unit is not receiving power.	Make sure the unit is plugged in to a grounded outlet.
	The LCDI power cord is tripped.	Press the Reset button on the LCDI cord.
	There is insufficient power.	Move the unit to another outlet. Check your circuit breaker. (Refer to the rating label on the back of the unit to determine the Amperage draw).
	The water reservoir is full.	Drain the unit and restart it.
	The control panel is disconnected.	If no indicator lights turn on, contact customer service.
My remote control does not work and the indicator light on the remote does not turn on.	The batteries are not installed.	Install new batteries.
	The batteries are bad.	Replace the batteries.
	The batteries are installed incorrectly.	Reinstall the batteries correctly.
	The remote control is defective.	Contact customer service.
My air conditioner is making a loud noise.	The unit is not level.	Make sure the unit is on a level surface.
	A foreign object has jammed the fan.	Remove the object from the fan.
	The floor below the unit is uneven.	Move the unit to a level surface.
My air conditioner is making a continuous metallic knocking or pinging sound.	The unit may have been shipped on its side.	Shut off the unit. Let the unit sit on a level surface for at least 24 hours and restart it.
	The compressor is damaged.	Contact customer service.
My air conditioner is leaking.	The drain plug is removed.	Attach the drain plug.
	The base pan is cracked.	Contact customer service.
My air conditioner runs for a little while and then it trips the power cord or the circuit breaker.	The air conditioner may be plugged into an outlet that cannot supply the correct amount of current.	Contact an electrician if the unit works in a different room or circuit.
The control panel lights blink randomly.	The unit may have a faulty control panel.	Contact customer service.

Issue	Possible Cause	Solution
No air comes out of the left side of the air vent.	The unit is designed to blow air from the right side.	This is normal operation.
My air conditioner is not cooling at all.	The unit is not operating in cooling mode.	Set the unit to be in cooling mode, and lower the set temperature (pg. 12).
	The compressor is not on.	The compressor may take up to 3 minutes to turn on, or longer if it is too warm.
	The ambient temperature is too high.	Lower the room temperature to be below 90° F.
	The filter may be dusty or blocked.	Clean the filters (pg. 16).
	The exhaust port is blocked.	Remove any obstructions in the exhaust hose and port.
My air conditioner blows cold air, but does not lower the room temperature.	The unit has not been vented.	The unit must be vented (pg. 3).
	The area of the room is too large.	Minimize the size of the area to be cooled, i.e. adding a drop ceiling. Use more than one unit to cool the area, or use a larger unit.
	There are open windows and doors.	Close any open doors or windows.
	There are too many heat sources.	Remove or shut off additional heat sources such as radio equipment, servers, etc.
	The room / garage may be inadequately insulated.	Properly insulate the room to be cooled, i.e. using fiberglass.
	The ambient temperature is too high.	The unit may not work if the room temperature is above 90° F.
	Direct sunlight is heating the room.	Close the curtains or pull down the blinds to minimize the amount of direct sunlight entering the room.
	The filter may be dusty or blocked.	Clean the filter and replace it if needed.
	The condenser coils are dirty.	Carefully vacuum the coils clean.
	The air intake or exhaust ports are obstructed.	Remove anything blocking the ports.
The unit makes a gurgling sound.	This sound is caused by the flow of refrigerant inside the unit.	This is normal operation.

For service, visit www.edgestar.com



Tip: Run the unit before it is needed. For example, run the unit in the morning before the area gets hot, and continue to run the unit all day long in order to maintain a low temperature.



Note: If the ambient temperature is above 90° F the unit may not blow cold air.

Specifications

Description of product	Portable Air Conditioner	Portable Air Conditioner
Model	PAC802W	PAC1202W
Voltage / Frequency	AC 115 V ~ 60 Hz	AC 115 V ~ 60 Hz
Input Power	900 W	1350 W
Current	8.0 A	12.0 A
Color	White	White
Coolant	R410A	R410A
Timer	24 Hour	24 Hour
Dimensions W x H x D	18.75" x 34.5" x 15.75"	18.75" x 34.5" x 15.75"
Weight	57.2 lbs.	62.7 lbs.

EdgeStar Limited Warranty

One (1) Year Parts & Ninety (90) Days Labor

This product is warranted by EdgeStar to be free from defective workmanship and materials, subject to any conditions set forth as follows:

WHAT IS COVERED:

LABOR: For a period of NINETY (90) DAYS from the date of original purchase, labor will be performed free of charge at an authorized EdgeStar repair facility. At its option, EdgeStar will repair the product with new or remanufactured parts, or exchange the defective product with a new, refurbished, or remanufactured product. If a product is replaced, it will carry the remaining warranty of the original product. After the ninety (90) day period, EdgeStar will no longer be responsible for labor charges incurred. All defective products and parts covered by this warranty will be repaired or replaced on a mail-in basis to an EdgeStar authorized repair facility.

PARTS: For a period of ONE (1) YEAR from the date of original purchase, EdgeStar will supply new, rebuilt, or refurbished parts free of charge. EdgeStar may request a defective part be returned in exchange for the replacement part. All replacement parts or products will be new, remanufactured, or refurbished. All products and parts replaced by EdgeStar under warranty service become the property of EdgeStar.

This warranty applies to the original purchaser only, and only covers defects in workmanship experienced during operation of the product under normal service, maintenance, and usage conditions. This warranty applies to the purchase and use of this product in residential settings within the contiguous United States of America.

WHAT IS NOT COVERED:

The following limitations apply to the coverage of this warranty. This warranty does not cover:

- Labor charges for installation, setup or training to use the product.
- Shipping damage, and any damage caused by improper packaging for shipment to an authorized service center, and any damaged caused by improper voltage or any other misuse, including abnormal service, handling, or usage.
- Cosmetic damage such as scratches and dents.
- Normal wear and tear on parts or replacement of parts designed to be replaced, e.g. filters, cartridges, batteries.
- Service trips to deliver, pick-up, or repair, install the product, or to instruct in proper usage of the product.
- Damages or operating problems resulting from misuse, abuse, operation outside environmental specifications, uses contrary to instructions provided in the owner's manual, accidents, acts of God, vermin, fire, flood, improper installation, unauthorized service, maintenance negligence, unauthorized installation or modification, or rental or commercial use.
- Labor, service transportation, and shipping charges incurred 91 days or more after the date of original purchase.
- The use of EdgeStar products in commercial or rental settings.
- Optional accessories, attachments, and appearance items.
- Products that have been modified to perform outside of specifications without the prior written permission of EdgeStar.
- Products lost in shipment, or theft.
- Products sold AS IS or from an unauthorized reseller.
- Products that have had their serial numbers removed or defaced. Products with serial numbers that have been invalidated.
- Damage to personal property from use of product.
- Replacement of repair of household fuses, circuit breakers, wiring, or plumbing.

OBTAINING WARRANTY SERVICE:

If you believe your product is defective, contact EdgeStar Customer Support for troubleshooting assistance and warranty service at www.edgestar.com or 1-866-319-5473. Before contacting EdgeStar, have your serial number and proof of purchase available. Once an EdgeStar authorized representative has confirmed that your product is defective and eligible for warranty service, the product must be returned to an EdgeStar repair facility. The purchaser is solely responsible for prepaying all shipping related costs to and from the repair facility. EdgeStar is not responsible for damage resulting from shipper mishandling or improper packaging. Do not return a defective product to the place of purchase. Products received without a return authorization number will be refused.

THIS WARRANTY IS IN LIEU OF ANY OTHER WARRANTY, EXPRESSED OR IMPLIED, INCLUDING WITHOUT LIMITATION, ANY WARRANTY OF MERCHANTABILITY OR FITNESS FOR A PARTICULAR PURPOSE. TO THE EXTENT ANY IMPLIED WARRANTY IS REQUIRED BY LAW, IT IS LIMITED IN DURATION TO THE EXPRESS WARRANTY PERIOD ABOVE. NEITHER THE MANUFACTURER NOR ITS DISTRIBUTORS SHALL BE LIABLE FOR ANY INCIDENTAL, CONSEQUENTIAL, INDIRECT, SPECIAL, OR PUNITIVE DAMAGES OF ANY NATURE, INCLUDING WITHOUT LIMITATION, LOST REVENUES OR PROFITS, OR ANY OTHER DAMAGE WHETHER BASED IN CONTRACT, TORT, OR OTHERWISE. IN NO EVENT AND UNDER NO CIRCUMSTANCE OF ANY TYPE OR KIND SHALL THE SELLER, MANUFACTURER AND/OR DISTRIBUTOR BE LIABLE FOR ANY REASON, UNDER ANY THEORY, FOR MORE THAN THE BASIC COST OF THE PRODUCT TO THE PURCHASER OR END USER. SOME STATES DO NOT ALLOW THE EXCLUSION OF INCIDENTAL OR CONSEQUENTIAL DAMAGES, SO THE ABOVE EXCLUSION MAY NOT APPLY TO YOU. THIS WARRANTY GIVES YOU SPECIFIC LEGAL RIGHTS. YOU MAY HAVE OTHER RIGHTS THAT VARY FROM STATE TO STATE.