

1. IMPORTANT SAFETY INSTRUCTIONS	4
2. INSTALLATION	5
2.1 Oven Use	5
3. GUIDE TO OVEN CONTROLS	8
3.1 Front panel	8
3.2 Description of controls	8
4. ELECTRONIC ANALOG CLOCK	9
5. USING THE OVEN	11
5.1 General advice	11
5.2 Turning on the oven	11
5.3 Inside light	11
5.4 Cooling fan	11
5.5 Using the rotisserie rod	12
6. AVAILABLE ACCESSORIES	13
7. COOKING HINTS	14
7.1 Traditional cooking	14
7.2 Hot-air cooking	14
7.3 Broiler	15
7.4 Broiler with hot air	15
7.5 Defrosting	15
8. CLEANING AND MAINTENANCE OF THE OVEN	16
8.1 Cleaning stainless steel	16
8.2 Oven door glass	16
9. EXTRAORDINARY MAINTENANCE	17
9.1 Replacing the oven light	17
9.2 Removing the oven door	18



NOTE: THIS APPLIANCE MUST BE INSTALLED SOLELY AND EXCLUSIVELY BY A QUALIFIED TECHNICIAN. ANY TECHNICAL PROCEDURES MUST BE CARRIED OUT BY AN AUTHORIZED TECHNICIAN.



INSTRUCTIONS FOR THE USER: *these instructions contain user advice, a description of the controls and the correct procedures for cleaning and maintenance of the appliance.*

1. IMPORTANT SAFETY INSTRUCTIONS



READ AND SAVE THESE INSTRUCTIONS – Your safety and the safety of others are very important. We have provided many important safety messages throughout this manual and on the appliance. Read all instructions before using the appliance and always obey all safety messages.



RECOGNIZE SAFETY INFORMATION

This is a safety alert symbol. This symbol alerts you to potential hazards that can kill or hurt you and others.

UNDERSTAND SIGNAL WORDS

A signal word – DANGER, WARNING, or CAUTION – is used with the safety alert symbol. DANGER identifies the most serious hazards. It means you can be killed or seriously injured if you do not immediately follow the instructions. WARNING means you can be killed or seriously injured if you do not follow the instructions. CAUTION indicates a potentially hazardous situation which, if not avoided, may result in minor or moderate injury.



WARNING

- This appliance is intended for home use only.
- Only use the appliance for its intended purpose. The manufacturer can not be held responsible for damages caused by improper use of this oven.
- This appliance complies with current safety requirements. Improper use of the appliance can lead to personal injury and material damage.
- Read all the instructions before installing or using the oven for the first time.
- Keep these operating instructions in a safe place and pass them on to any future user.

2. INSTALLATION

- Before installation, make sure that the voltage and frequency listed on the ID plate correspond with the household electrical supply. This data must be the same to prevent injury or damage to the appliance. **Consult a qualified electrician if in doubt.**
- **Be sure your appliance is properly installed and grounded by a qualified technician.**
- To guarantee the electrical safety of this appliance, the appliance must always be continuously connected to an effective grounding system. This basic safety requirement must be met. If there is any doubt, have your household electrical system checked by a qualified electrician.
- The manufacturer is not responsible for damage caused by the lack or inadequacy of an effective grounding system or the failure to meet the requirements of national and local electrical codes.
- The oven should not be operated until it has been properly installed within the cabinetry.
- Installation, maintenance and repair work should be performed by an authorized service technician.
Work by unqualified persons can be dangerous and may void the warranty.
- Before installation or service, disconnect the power supply to the work area by “tripping” the circuit breaker, or shutting off the main power.

2.1 Oven Use



WARNING



BURN HAZARD

This oven can produce high temperatures that can cause burns. To reduce the risk of fire, electrical shock, personal injury, or damage when using the oven, follow the basic precautions, including the following:

- **Prevent children from touching the appliance when in use.**
- **Use heat-resistant pot holders** when placing items in the oven, shifting them, or removing them from the oven. The upper heating element and oven racks can become very hot and cause burns.
- To prevent burns, always place the oven racks at the desired height while the oven is cool.
- **Always open the door carefully.** Allow hot air or steam to exit before food is placed in the oven or removed.
- To prevent burns, allow the heating element to cool before cleaning by hand.
- Only clean the parts listed in this manual.

CAUTION: heating elements may be hot even if not glowing. During and after use, do not allow clothing or other flammable materials to enter into contact with the heating elements or interior surfaces of the oven until they have had sufficient time to cool. External parts of the oven such as the oven door glass, vent openings and the control panel may also become hot.

Important Safety Instruction

- **Do not obstruct oven vents.**
- Do not let metal objects (aluminum, foil, metal pans) come into contact with the heating elements.
- Do not slide cookware across the bottom of the oven. This could scratch and damage the surface.
- Do not lean, sit or place heavy items on the open oven door. The door can support a maximum weight of **75 lbs. (34 kg)**.
- Do not heat unopened food containers in the oven. Pressure could build up and the container could burst.
- Never add water to a hot oven tray or pan or pour water directly on food in a hot oven. The steam that is formed could cause serious burns or scalds. Any sudden change in temperature can damage the oven's enamel.
- **This oven must only be used for cooking.** Do not use this appliance as a dryer, kiln, dehumidifier, etc. Fumes or vapors given off by glues, plastics or other non-food items could ignite and cause material damage to property or personal injury.
- Cover all cooked food that is left in the oven to be kept warm. This will prevent moisture from condensing on the inside of the oven. Long-term or excessive condensation could damage the oven.
- **Never use aluminum foil to line the oven bottom.** Do not place pots, pans or baking sheets directly on the oven bottom when using the upper and lower heating elements, the upper and lower heating elements + convection fan or the convection heating element. This could crack the enamel of the oven bottom.
- **Never store flammable liquids or materials in, above or under an oven or near cooking surfaces.**
- **Do not use a steam cleaner to clean the oven.** Steam could penetrate electrical components and cause a short circuit.
- Children should not be left alone or unattended in an area where the oven is in use. Never allow children to sit or stand on any part of the oven.

CAUTION: Item of interest to children should not be stored in cabinets above the oven. Children climbing on the oven to reach these items could be seriously injured.

Important Safety Instruction

EN

- Do not leave the oven unattended when cooking with oils or fats as there is an increased risk of fire if overheated.
- Do not use water on grease fires!
- Put the fire out with a properly rated dry chemical or foam-type fire extinguisher.
- Be careful of loose fitting or hanging garments while operating the oven.
- **Do not use the oven as a room heater.**
- Make sure that the power cords of small appliances do not come into contact with or get caught in the oven door.
- **Use only dry, heat resistant potholders.** Moist or damp potholders used on hot surfaces may result in steam burns. Do not let potholders come into contact with hot oil. Do not substitute towels or other bulky cloth in place of potholders.

SAVE THESE INSTRUCTIONS



NOTE: The California Safe Drinking Water and Toxic Enforcement Act requires the Governor of California to publish a list of substances known to the State of California to cause cancer, birth defects, or other reproductive harm, and requires businesses to give warning of potential exposure to such substances.

WARNING: This product contains a chemical known by the State of California to cause cancer, birth defects, or other reproductive harm.

This appliance can cause low-level exposure to some of the substances listed, including benzene, formaldehyde, carbon monoxide, toluene, and soot.



3. GUIDE TO OVEN CONTROLS

3.1 Front panel

All the commands and controls for the oven are positioned on the front panel.

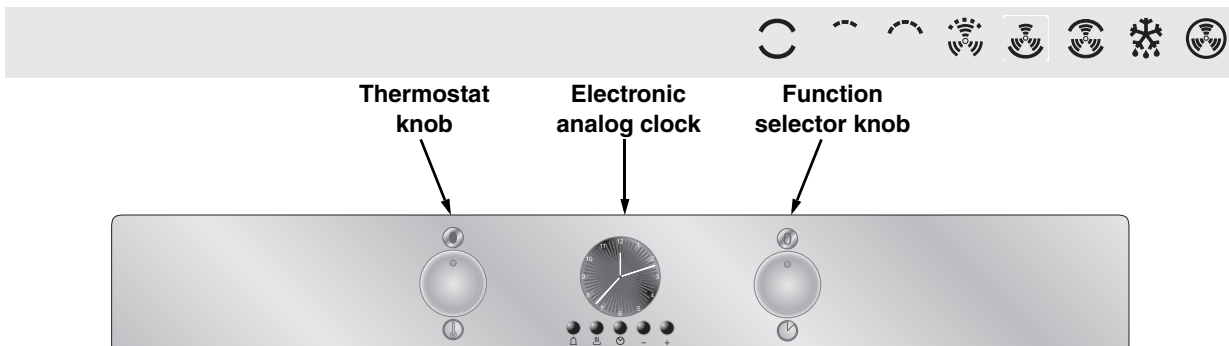

3.2 Description of controls

FUNCTION SELECTOR KNOB

Selects the desired cooking functions. The symbols are shown below. By turning the knob, the various function symbols light up simultaneously with the timer and internal oven lights.

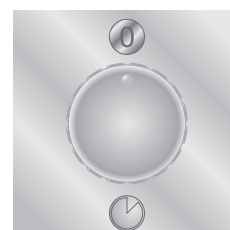

- | | | | |
|--|--------------------------------------|--|---|
| | NO FUNCTION SET | | LOWER HEATING ELEMENT + CONVECTION FAN |
| | UPPER AND LOWER HEATING ELEMENTS | | UPPER AND LOWER HEATING ELEMENTS + CONVECTION FAN |
| | SMALL BROIL ELEMENT | | DEFROSTING |
| | LARGE BROIL ELEMENT | | CONVECTION HEATING ELEMENT + CONVECTION FAN |
| | LARGE BROIL ELEMENT + CONVECTION FAN | | |

THERMOSTAT KNOB

The cooking temperature is set by turning the knob clockwise to the desired temperature, between 120°F and 500°F. The thermostat light comes on to indicate that the oven is warming up.

When this light goes out it means that the desired heating temperature has been reached.

The light will come on periodically during use to indicate that the thermostat is keeping the oven set at a constant temperature.

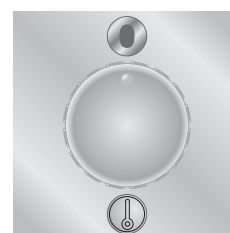





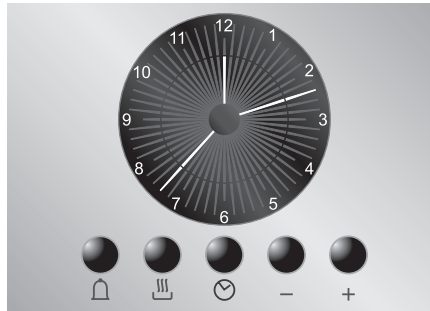

4. ELECTRONIC ANALOG CLOCK





LIST OF BUTTON FUNCTIONS



-  TIMER BUTTON
-  END OF COOKING BUTTON
-  CLOCK ADJUSTMENT AND RESET
-  VALUE DECREASE BUTTON
-  VALUE INCREASE BUTTON

4.0.1 Setting the time

When the oven is used for the first time, or after an interruption in the electrical power supply, the display flashes at regular intervals.

Press  for 1 to 2 seconds to stop the display from flashing and to start the procedure for setting the correct time. Press the value modification buttons  or  to increase or decrease the setting by one minute.

Press one of the two value modification buttons until the current time appears. 6 to 7 seconds after the last button is pressed, the clock will start at the set time.





When the oven is in standby mode, to modify the time simply press the  button for about 2 seconds and adjust the time using the  and  buttons. A few seconds after the last button is pressed, the clock will restart normal operation.



At the end of each programmed operation 8 beeps will sound 3 to 4 times at intervals of about 1 and a half minutes. The beeps can be hushed at any time by pushing any button.

4.0.2 Timer

The timer does not stop cooking; it simply activates the buzzer.



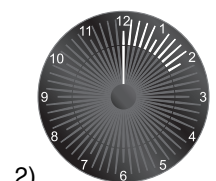
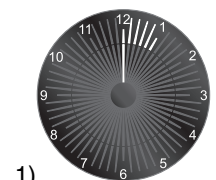



- Press  and the clock dial display will light up as shown in figure 1;
- Within 6 to 7 seconds, press the  or  buttons to set the timer. Each time a button is pressed, 1 outer mark on the clock dial, representing 1 minute of cooking time, will light up or go out. (Figure 2 shows a cooking time of 10 minutes).
- The countdown will start 6 to 7 seconds after the last button is pressed; when the programmed time has elapsed, the buzzer will sound.
- During the countdown, the current time can be viewed by pressing the  button once; press it again to return to the timer display.
- At the end of the countdown, the oven must be turned off manually by turning both the oven thermostat knob and function selector knob to 0.
- The maximum cooking time that can be set is 60 minutes.







4.0.3 Programming timed cooking

Cooking time: the 2nd button  can be used to set the cooking time. Before it can be set, the thermostat knob must be turned to the desired cooking temperature and the function selector knob must be turned to any setting. To set the cooking time, proceed as follows:

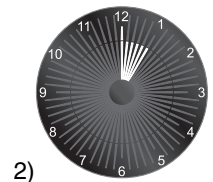
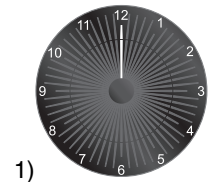





- Press the  button for 1 to 2 seconds; the pointer will go to 12 (Fig. 1).
- The cooking time can be set using the  and  buttons: each time the  button is pressed, 1 minute is added to the cooking time (figure 2 shows a cooking time of 1 hour).
- Once the desired cooking time is reached, cooking will start about 6 seconds after the  or  buttons were pressed.
- Once cooking has started the display will show the current time, represented by the constantly illuminated marks on the dial, and the minutes left to the end of the cooking time, represented by the flashing marks (each flashing mark means 12 minutes of cooking time left).



- At the end of the cooking time, the timer will switch the oven heating elements off, the buzzer will start to beep and the numbers on the clock dial will flash.
- The cooking time can also be reset by resetting the program selected: pressing the central  button for 2 seconds will delete the set cooking time and the oven will have to be turned off manually.

Warning: it is not possible to set a cooking time of more than 6 hours.



Starting cooking: besides setting a cooking time, the cooking start time can also be set (with a maximum delay of 12 hours in relation to the current time). To set the cooking start/end time, proceed as follows:

- Set the cooking time as described in the previous point.
- Within 6 to 7 seconds after the last time you press the  or  buttons, press the  button again to set the cooking start time. The current time will appear on the display with the inside segments illuminated to show the end of cooking time. Use the  and  buttons to set the cooking start time.
- 6 to 7 seconds after the last button is pressed the display will show the current time and the cooking start and end times, which will be represented by the illuminated inner marks. The clock dial display marks will be constantly illuminated as long as the current time is not the same as the cooking start time; as soon as the current time reaches the set starting time, all the inside segments will start to flash, indicating that the oven has started cooking.
- At the end of the cooking time, the timer will switch the oven heating elements off, the buzzer will start to beep and the numbers on the clock dial will flash.
- To reset the entire program, press and hold the central  button for 2 seconds: if cooking has already started, the oven will have to be turned off manually.
- Here we can see a programming example: the current time is 19:06 and cooking is programmed to start at 20:00 and end at 21:00 hours.
- At 20:00 hours the inner marks between 8 and 9 will start to flash, while the hour hand will remain still.



Warning: for the oven to start cooking after the programming procedures just described, the thermostat and function selector knob must be correctly set at the desired temperature and function.

4.0.4 "DEMO" Function

Models with analogue/digital programmer feature a "DEMO" function which deactivates the heating elements while leaving the other functions unchanged. To activate it, simply press the , , and  keys and keep them held down for 3-4 seconds. A confirmation buzzer will inform the user that the function is active. When the "DEMO" function is active, the number 6 on the clock flashes at regular intervals. To deactivate it, simply repeat the same procedure.



5. USING THE OVEN

5.1 General advice



NOTE: When using the oven for the first time, heat it to the maximum temperature (500°F) for sufficient time to burn away any oily residues from the manufacturing process. The heating elements and the fan are deactivated when the oven door is opened.

If you have to attend to the food in the oven, leave the door open for the shortest time possible, so that the internal temperature doesn't drop.

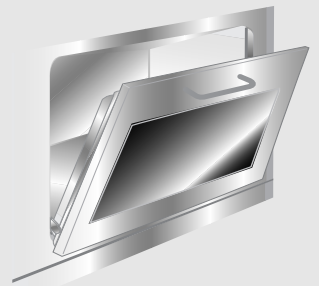

5.2 Turning on the oven

- Select the desired function with the function selector knob (as indicated in the paragraph "3.2 Description of controls);
- Select manual cooking (or a cooking time) (as indicated in the paragraph "4. Electronic Analog Clock);
- select the temperature with the thermostat knob.

5.3 Inside light

Turn on the inside oven light by turning the function selector knob to any position or by opening the door with the oven turned off.

5.4 Cooling fan

The oven is equipped with a cooling system which automatically comes on when the oven is turned on. Fans produce a steady flow of air from above the door which may continue for a brief period of time even after the oven has been turned off.

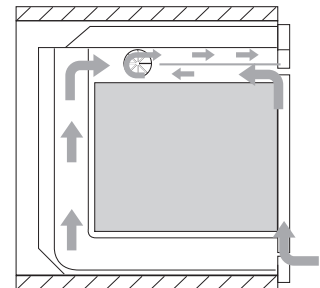



5.5 Using the rotisserie rod

Prepare the rotisserie rod with the food, tightening the (A) meat fork set screws. Slide the rods of the rotisserie support assembly (B) into the slots in the drip tray (F). Remove the grip (D) and mount the rotisserie rod so the bushing (E) fits in the groove in the support assembly (B) on the right. Completely insert the drip tray into the oven until the tip of the support assembly rod (B) on the left side is inserted into its place (C) in the rotisserie motor drive on the back wall of the oven. Add a little water to the drip tray to prevent smoke from forming.

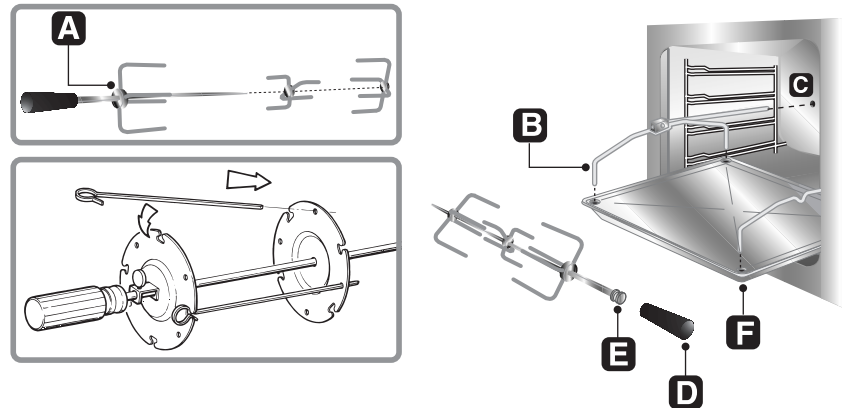

The rotisserie motor operates only in the Broil cooking mode .



6. AVAILABLE ACCESSORIES

The oven features 4 support positions for pans and racks of different heights.



Oven rack: for cooking food on pans, small cakes, roasts or food requiring light broiling.

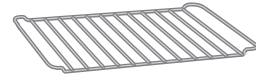

Pan rack: goes on top of the pan for cooking foods that might drip.

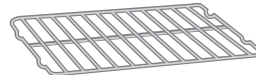

Oven pan: useful for catching oil from foods on the rack above.

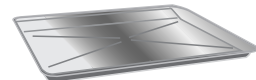

Pastry pan: for baking cakes, pizza and desserts.

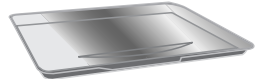

Roof liner: remove it to make cleaning inside the oven easier.

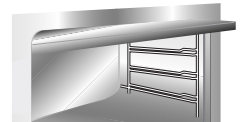

Roasting spit: useful for cooking chicken, sausages and anything else requiring uniform cooking over the entire surface.



Rotisserie frame: fits in the slots of the oven pan before using the rotisserie rod.

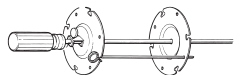

Chromium-plated grip: useful for removing hot racks and pans.

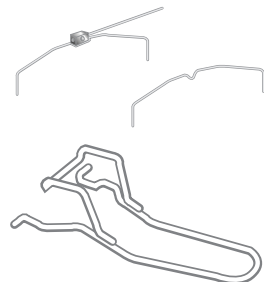

NOTE: Ask your authorized dealer for original accessories.



7. COOKING HINTS



WARNING

BURN HAZARD



Keep the oven door closed during cooking.



NOTE: During cooking, do not cover the bottom of the oven with aluminum or tin foil and do not place pans or oven trays on it as this may damage the enamel coating. If you wish to use greaseproof paper, position it so that it will not interfere with the hot air circulation inside the oven.

In fan-assisted mode, the oven should be preheated at 90-100°F above the cooking temperature. This considerably shortens cooking time and reduces power consumption, as well as giving better cooking results.

7.1 Traditional cooking



FUNCTION SELECTOR



THERMOSTAT SELECTOR FROM 120° TO 500°F



This traditional cooking system, with the heat circulating bottom to top, is ideal for cooking foods on one rack only. Preheat the oven to the desired temperature and put the food in the oven only after the thermostat light has gone out.

Deep-frozen meat can be put directly into the oven without defrosting. The only precaution is to select lower temperatures, around 155°F, and cooking times about 1/4 longer than fresh meat cooking times. Very fatty meats may be put in when the oven is still cold.

7.2 Hot-air cooking



FUNCTION SELECTOR



THERMOSTAT SELECTOR FROM 120° TO 500°F



This system is suitable for cooking different foods on more than one rack (fish, meat etc.) without mixing tastes and smells.

Oven hot air convection ensures uniform heating. No preheating is required.



NOTE: Different foods may be cooked together as long as the cooking temperature of the different foods is the same.



Instructions for the User

EN

7.3 Broiler

FUNCTION SELECTOR		
THERMOSTAT SELECTOR AT MAXIMUM AND DOOR CLOSED		



This permits rapid browning of foods. For longer cooking times and broiling on wide surfaces it is better to insert the rack on a lower runner, depending on the size of the pieces of food to be broiled.

7.4 Broiler with hot air

FUNCTION SELECTOR		
THERMOSTAT SELECTOR AT MAXIMUM AND DOOR CLOSED		



This permits a uniform distribution of heat and greater heat penetration. Food will be lightly browned on the outside and remain tender inside.
Maximum cooking time is 60 minutes.



NOTE: Keep the oven door closed during cooking. Heating time must not exceed 60 minutes.

7.5 Defrosting

FUNCTION SELECTOR		
THERMOSTAT SELECTOR IN POSITION 0		



Food can be rapidly defrosted by the circulation of air at room temperature.



NOTE: The advantage of defrosting at room temperature is that it does not alter the taste and appearance of the food.



8. CLEANING AND MAINTENANCE OF THE OVEN

8.1 Cleaning stainless steel



WARNING



BURN HAZARD

- The oven can produce high temperatures that can cause burns.
- To prevent burns, allow the heating elements to cool before cleaning.
- Only clean the parts listed in this manual.



NOTE: To keep the oven in good condition, you should clean it at regular intervals (after it has cooled). Take out all removable parts.

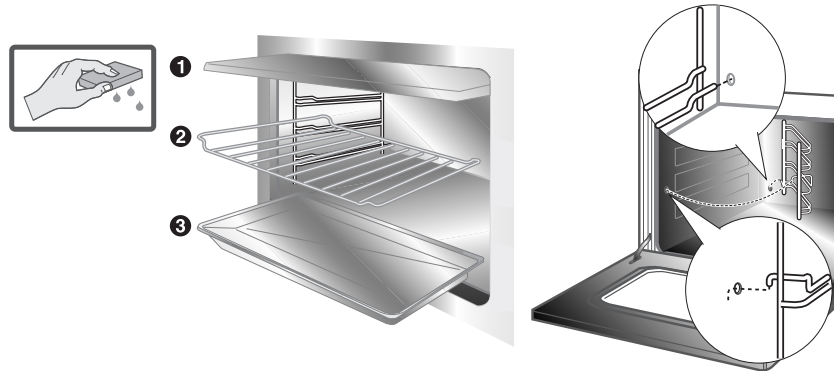

8.1.1 Routine oven cleaning

To clean and preserve the stainless steel surfaces, always use only specific products that do not contain abrasives or chlorine-based acids. How to use: pour the product on a damp cloth and wipe the surface, rinse thoroughly and dry with a soft cloth or deerskin.

8.1.2 Food stains or residues

Do not use metallic scouring pads or sharp scrapers: they will damage the surface.

Use normal, non-abrasive products for cleaning stainless steel together with non-scratching sponges and, if necessary, wooden or plastic scrapers.

For particularly tough stains or burned-on-residue, use special oven cleaners. Rinse thoroughly and dry with a soft cloth or deerskin.



8.2 Oven door glass

The oven door glass should always be kept clean. Use absorbent kitchen paper towels to clean. In case of tough spots, clean with a damp sponge using a regular detergent.



9. EXTRAORDINARY MAINTENANCE

The oven may require extraordinary maintenance or replacement of parts subject to wear such as seals, bulbs, and so on. The following instructions describe how to carry out these minor maintenance operations.



WARNING

ELECTRICAL SHOCK HAZARD

Before any maintenance operation, disconnect the power supply of the appliance.

9.1 Replacing the oven light

Remove upper oven protection **A** and ring **B** as well as the glass cover **C**, unscrewing it anticlockwise. Replace light bulb **D**. Reassemble ring **B**, cover **C** and upper protection **A**.

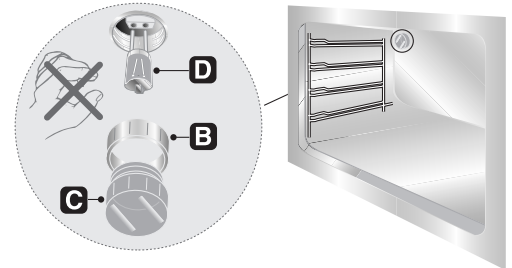
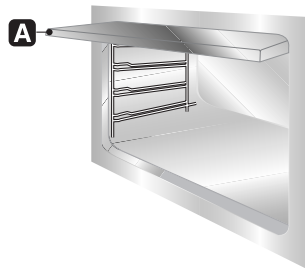

CAUTION: The standard bulbs are halogen: do not touch them directly with your fingers. Use insulation to protect your hand. Use only bulbs that are available at authorized service centers.



NOTE: Use only oven-rated appliance bulbs (T 540°F - 300°C)



9.2 Removing the oven door

9.2.1 With type 1 moveable levers

With the door completely open, lift the levers **A** until they touch hinges **B**, then grip the two sides of the door with both hands close to the hinges. Raise the door to an angle of about 45° and remove it. If the hinges don't lock, repeat the operation, raising the levers and keeping the door slightly raised. To remount the door, fit the hinges **B** into their grooves, then lower the door into place, making sure that it remains in the grooves **C**, then lower the levers **A**.

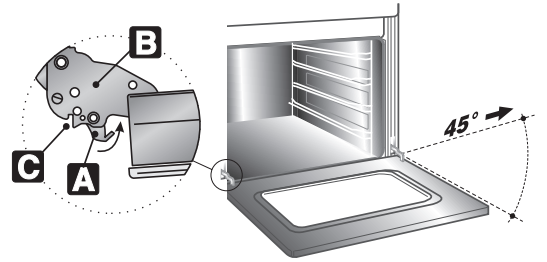

9.2.2 Removing doors with pins

Open the door completely and insert the pins (supplied) into the slots from the inside. Close the door to an angle of about 45° and lift it to remove it. To remount the door, fit the hinges into their grooves, then lower the door into place and extract the pins. In case you lose the pins, two screwdrivers can also be used.

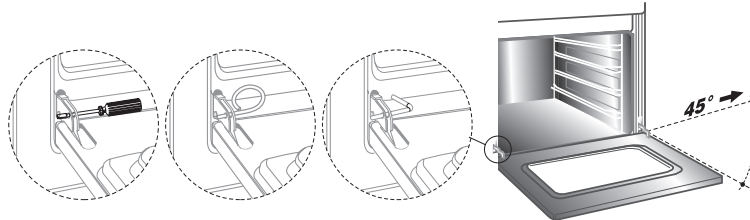

9.2.3 Oven door seal

In order to thoroughly clean the oven, the seal may be removed. Before removing the seal, take off the door as described above. Once the door has been removed, lift the tabs at the corners as shown in the figure. After cleaning, refit the seal starting with the longer, horizontal side and insert the tabs into the appropriate slots at the top.

