

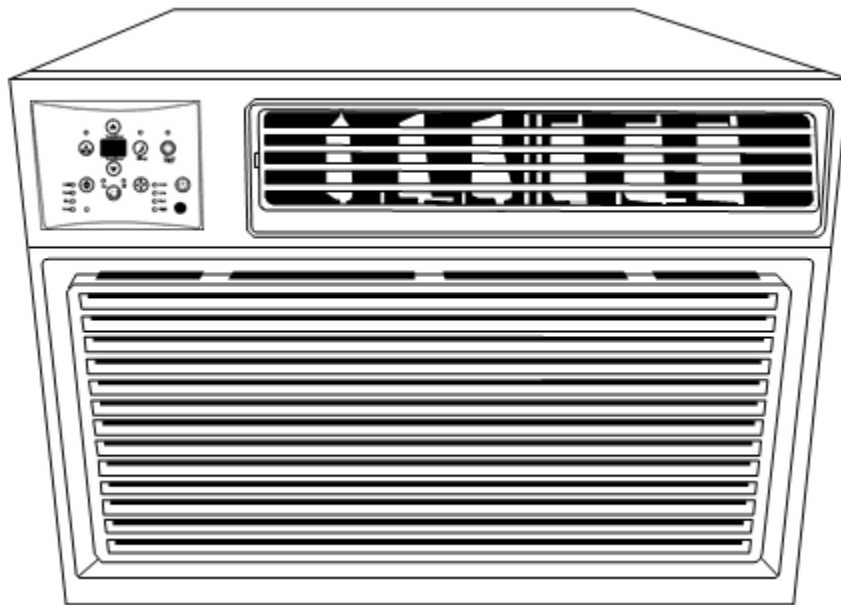

# Wall Air Conditioner and Heater



# WTC8000W

## Owner's Manual

For more information on other great EdgeStar products on the web, go to <http://www.edgestar.com>

# Important Safety Information

Improper handling can cause serious damage to the appliance and/or to the user. Please read the following safety information.



**Warning:** The water produced by the wall AC is not potable or suitable for drinking.

**Do not** drink the water drained from the unit as it contains contaminants and could make you sick.



## Electrical Safety

- Make sure your hands are dry and not wet before operating the unit.
- Do not wet the front housing or control panel.
- Do not directly spray water on this Air Conditioner.
- Do not pull the unit by the cord.
- Always turn the unit off and unplug it from the socket when cleaning.
- Unplug the unit if it is not going to be used for a long period of time.
- Do not operate the unit with a damaged or loose plug and / or socket.
- Use only the correct power supply with appropriate amperage.
- If the power cord is damaged, it must be replaced by the manufacturer, a service agent, or qualified technician.
- Do not turn the unit off or on by inserting or pulling the power plug.
- Do not modify the power cord length or share the outlet with another appliance.
- Do not use this unit with an extension cord and/or adapter plug.
- Do not use this unit near flammable gases/combustibles or close proximity to heating appliances.
- During operation do not remove any part of the outside casing.



## General Safety

- Do not let people or pets sit or set an object directly in front of air flow.
- If a strange sound, smell, or smoke comes from the unit, turn it off and review the troubleshooting page of this manual.
- Stop operation and unplug unit in the event of a severe storm.
- To ensure proper air flow and intake, make sure the air vents are not obstructed.
- See instructions for cleaning air filters and how often cleaning should occur.
- Do not use strong detergents when cleaning.
- Children should be supervised when operating this unit.
- Do not allow children to play with the controls or drop any objects into the air outlets or vents.
- Do not place objects or let any person sit on top of the unit.
- Route the power cord carefully to avoid a tripping hazard.
- This unit is intended for domestic home use only. Do not use the wall air conditioner for commercial or industrial use. Any other use may invalidate the warranty.
- Use caution when unpacking and installing the unit as there may be some sharp edges.

## Operation of Safety Plug

Your air conditioner is supplied with a Leakage-Current Detection and Interruption (LCDI) safety plug. This device provides protection to reduce the risk of fire due to arcing faults in the power supply cord. Before using your air conditioner, follow the instructions below to ensure that the LCDI plug is working properly:

1. Plug the power cord to a grounded outlet.
2. Press the TEST button on the LCDI plug. This should trip the plug and cut the power to the air conditioner. If the plug does not trip and you are able to turn on the unit, please contact EdgeStar support.

**DO NOT USE YOUR AIR CONDITIONER IF THE TEST FAILS.**

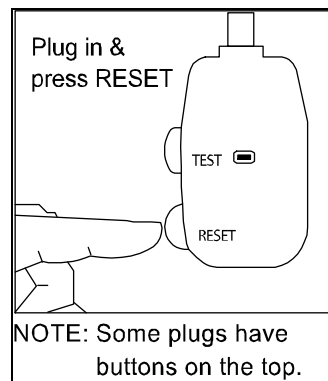

3. Press the RESET button to start using your air conditioner.

### NOTES:

- **Always make sure the “Reset” button is pushed in for proper operation.**
- **The power supply cord with LCDI plug must be replaced if it fails to reset.**
- **Do not use the TEST and RESET buttons as an ON/OFF switch.**

Electrical products should not be disposed of with household waste. Please contact your local recycling center for more information on how to recycle electronic waste.



# Table of Contents

<b>INTRODUCTION .....</b>	<b>1</b>
<b>PARTS IDENTIFICATION .....</b>	<b>2</b>
SIDE VIEW .....	2
FRONT VIEW .....	2
<b>PREPARATIONS FOR INSTALLATION .....</b>	<b>3</b>
<b>WALL SLEEVE PREPARATIONS.....</b>	<b>4</b>
ASSEMBLING THE KOLDFRONT SLEEVE.....	4
<b>INSTALLATION INSTRUCTIONS .....</b>	<b>5</b>
INSTALLING CABINET INTO WALL.....	5
INSTALLING THE GRILLE.....	5
DIRECT UNIT MOUNTING .....	6
COMPLETING INSTALLATION.....	6
<b>CONTROL PANEL OPERATIONS .....</b>	<b>7</b>
TO TURN UNIT ON:.....	7
TO CHANGE TEMPERATURE:.....	7
TO ADJUST FAN SPEEDS:.....	7
TO SELECT OPERATING MODE: .....	7
<i>To operate on Auto Feature: .....</i>	<i>7</i>
<i>To operate on Fan Only: .....</i>	<i>8</i>
<i>To operate on Dry mode: .....</i>	<i>8</i>
TO USE ENERGY SAVER FEATURE:.....	8
TO USE THE SLEEP FEATURE: .....	8
TO USE TIMER (AUTO START/STOP) FEATURE: .....	8
TO CHECK FILTER FEATURE: .....	9
DIGITAL DISPLAY:.....	9
<i>Error Codes .....</i>	<i>9</i>
ADDITIONAL TIPS: .....	10
<b>REMOTE OPERATIONS.....</b>	<b>11</b>
<b>MAINTENANCE .....</b>	<b>12</b>
AIR FILTER CLEANING .....	12
CABINET CLEANING.....	12
<b>NORMAL SOUNDS.....</b>	<b>13</b>
<b>ENERGY SAVING GUIDE.....</b>	<b>13</b>
<b>TROUBLESHOOTING .....</b>	<b>14</b>
<b>SPECIFICATIONS.....</b>	<b>16</b>
<b>EDGE STAR LIMITED WARRANTY .....</b>	<b>17</b>

## Introduction

Thank you for purchasing this Koldfront *by EdgeStar* air conditioner. We are glad you chose us. We believe that your purchase of this product opens a relationship between you and EdgeStar. We will provide the customer support needed to nurture that relationship.

This manual contains important information regarding the proper installation, use and maintenance of your air conditioner. Following this manual will ensure that your product will work at its peak performance and efficiency.

Please save the original product packaging in case you need to safely transport your air conditioner.

### For Your Records:

Please write down the model number and serial number below for future reference. Both numbers are located on the ratings label on the back of your unit and are needed to obtain warranty service. You may also want to staple your receipt to this manual as it is the proof of your purchase, and is also needed for service under your warranty.

Model Number: \_\_\_\_\_

Serial Number: \_\_\_\_\_

Date of Purchase: \_\_\_\_\_

To better serve you, please do the following before contacting customer service:

- If you received a damaged product, immediately contact the dealer that sold you the product.
- Read and follow this instruction manual carefully to help you install, use and maintain your air conditioner.
- Read the troubleshooting section of this manual as it will help you diagnose and solve common issues.
- Visit us on the web at <http://www.edgestar.com> for product guides, additional troubleshooting resources and up-to-date information. If you need service, our friendly customer service representatives are available via email at [service@edgestar.com](mailto:service@edgestar.com) or by telephone at **1 (866) 319-5473**.

## Parts Identification

### Side View

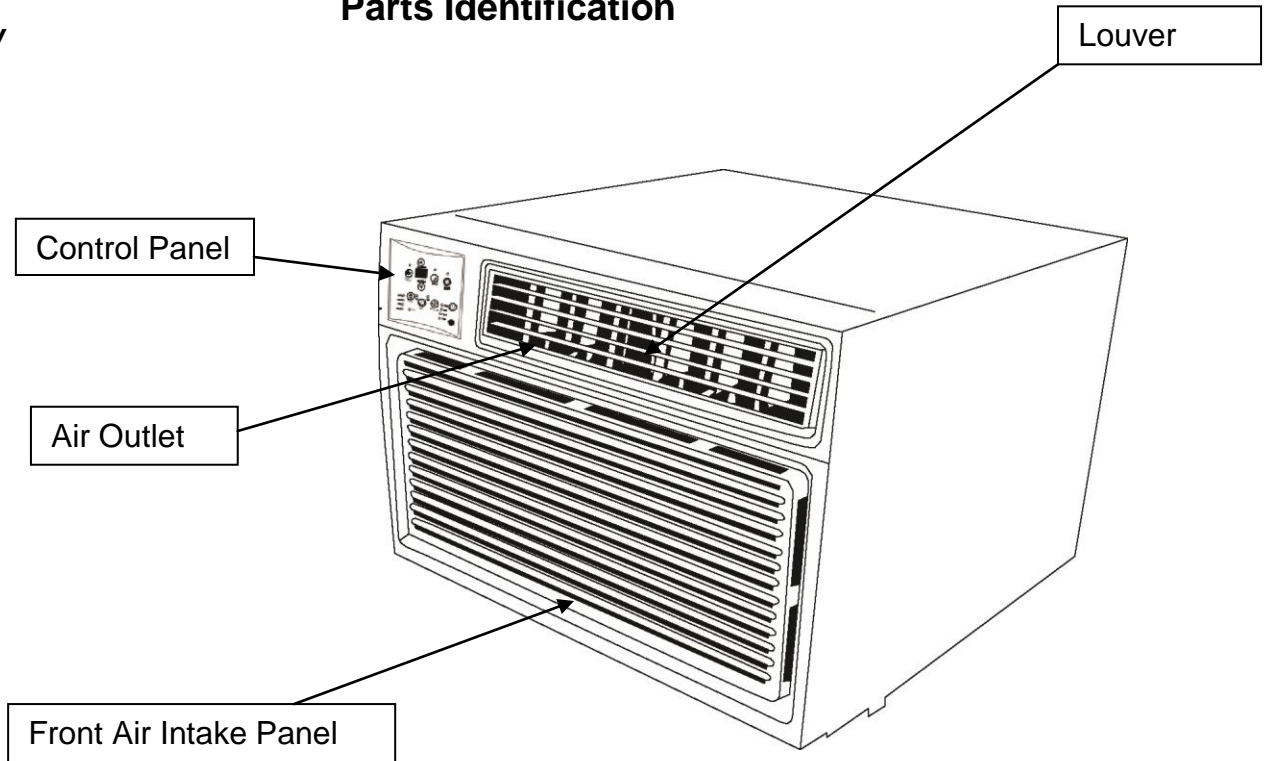

### Front View

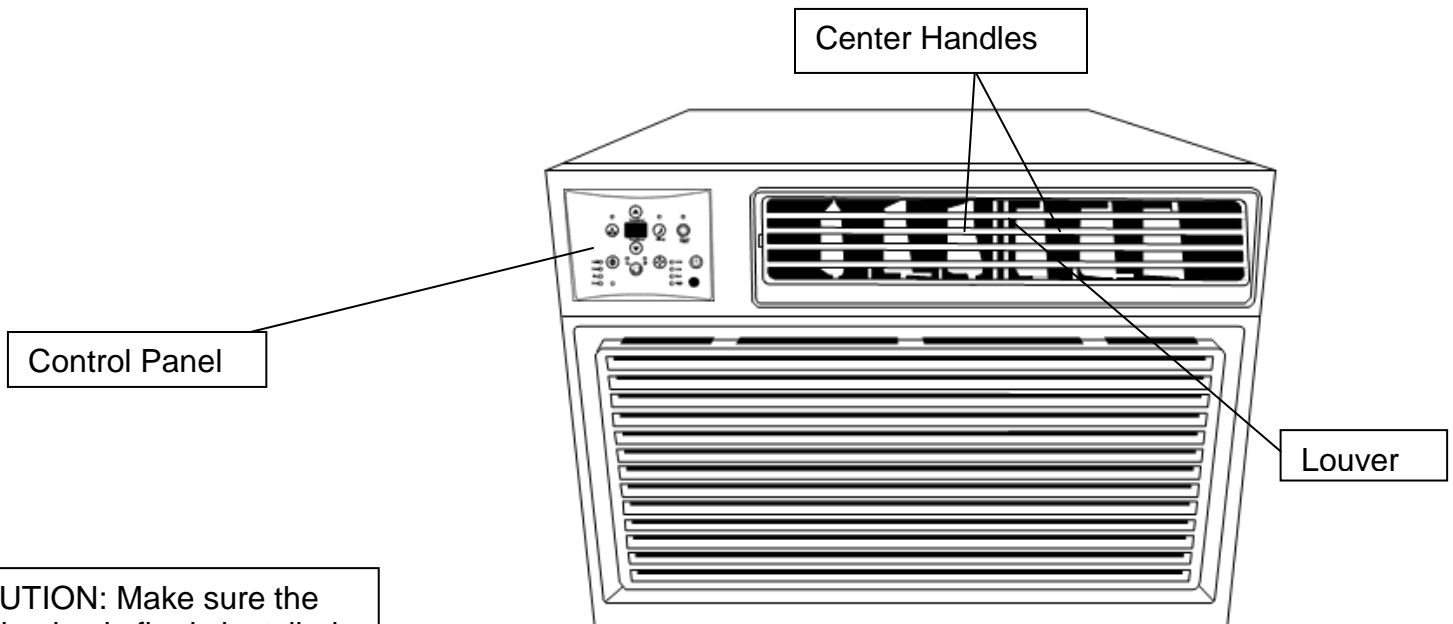

**CAUTION:** Make sure the drain plug is firmly installed before using the unit to prevent leaking.

## Preparations for Installation

**Tools Needed:**

Flat Screwdriver  
Phillips Screwdriver  
Tape Measure  
Level  
Drill

NOTE: To avoid risk of injury and/or product/property damage, please take the following precautions:

- Two or more people are needed to properly handle and install.
- Use proper lifting and carrying techniques.
- Wearing protective gloves will help to avoid injury from sharp edges.

Before you begin, make sure you have all the parts necessary for installation.

Name	Spec.	Qty
Tapered Spacer Blocks	17" Long	2
Centering/Support Blocks	4 1/2" x 3 1/2" x 1 1/2"	4
Plastic Divider	1/8" x 4 1/2" x 14 1/2"	2
Stuffer Seal	1" x 1 1/2" x 84"	1
Seal	1" x 1 1/2" x 25"	3
Seal	1" x 1 1/2" x 14"	2
Seal	1" x 3/8" x 25"	3
Seal	1" x 3/8" x 14"	2
Seal	1" x 3/4" x 14"	2
Trim frame (side legs)		2
Trim Frame (top & bottom legs)		2
Ground Wire (green)		1
Toothed Washer for grounding screw		2
Grounding Screw		1
Grille (plastic)		1
Grille Aluminum		1
Nuts (plastic)		4
Screw Washer		4
Screw		4

NOTE: You may need to contact your electrician if your room's circuit is not able to power your unit.

## Wall Sleeve Preparations

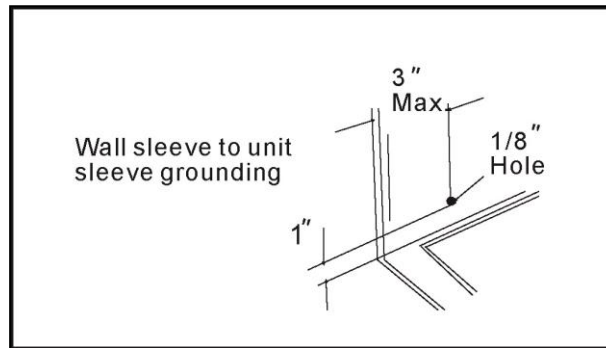

### *Assembling the Koldfront Sleeve*

1. Using the grounding screw and toothed washer, drill a 1/8" clearance hole (for the grounding screw) in a clear area about 3 inches back from the front edge of the sleeve through the left side.
2. Pull the loose end of the ground wire (green) out of the front of the sleeve.
3. Temporarily bend it down and around the lower edge of the sleeve.
4. This ground wire will later be attached to the frame of the Air Conditioner once it is installed.

**CAUTION:** When installation is complete, the replacement unit **MUST** have a rearward slope as shown in the image to the left.

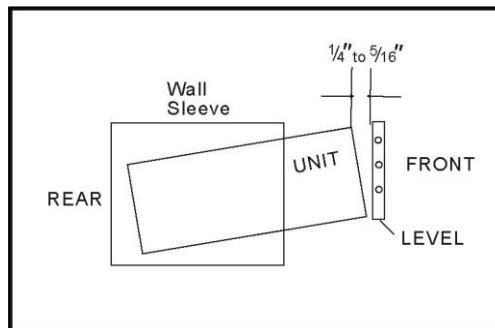



## Installation Instructions

### *Installing the Cabinet into the Wall*

Follow the steps listed below to install the cabinet into the wall

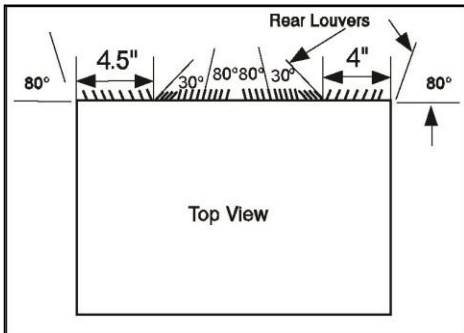

1. Remove existing rear grille as shown on Page 4 of this manual and replace with provided louvered rear panel.
2. Attach (1) 1" x  $\frac{3}{8}$ " x 25" long seal in the center at the top of the sleeve. Remove the backing paper and press into position.
3. Attach (2) 1" x  $\frac{3}{8}$ " x 14" seals to the left and right sides of the sleeve.
4. Attach (2) 1" x  $\frac{3}{4}$ " x 14" long seals vertically 4  $\frac{1}{2}$ " from the left side of the sleeve. Attach the other 1" x  $\frac{3}{4}$ " x 14" long seal 4" from the right side of the sleeve.
5. Center unit and gently slide unit into sleeve.
6. Before sliding all-the-way back, remove 2nd screw from front on left side of unit.
7. Remove the plastic washer from the screw.
8. Screw and attach the other end of the ground wire to the unit as shown in picture. Make sure that the toothed washer is against the cabinet.
9. Slide the unit completely to the rear to ensure a good seal, making sure the ground wire does not become tangled.

### *Installing the Grille*

**NOTE:** You may need to drill holes in flange of existing sleeve to match new rear grille.

This unit's increased performance characteristics result from having two rear air intakes. It is very important that these installation instructions are followed so your unit can operate at maximum efficiency. If this is an existing sleeve, and there is an existing rear grille, it needs to be replaced by one that has been shipped with the unit in the accessory kit.

**NOTE:** For increased efficiency, utilize the provided louvered rear panel.

1. Remove the existing grille.
2. Place the grille included with the new air conditioner towards the rear of the sleeve.
3. Mark through the hole positions.
4. Drill through the sleeve's flanges with a  $\frac{1}{8}$ " drill bit.
5. Attach the new grille with self-threading screws and washers.
6. It is VERY IMPORTANT that the grille is placed exactly as shown below.
7. Most decorative exterior grilles may be left in place as long as the proper interior air direction grille is installed.

## Direct Unit Mounting

The previous directions are the preferable way to mount the new rear grill. The unit's performance is slightly better and the possibility of draughts is reduced. As a last resort, direct mounting of the grille to the unit can be considered.

NOTE: The grille must be installed prior to inserting the unit into the sleeve.

1. Attach the (2) seal pieces (1" x  $\frac{3}{8}$ " x 14") as shown below.
2. Position the grille over the rear of the unit, making sure that:
  - a. The double set of screw holes are at the bottom.
  - b. The fins of the grill are pointed away from the unit.
3. Align the top of the grille with the top of the unit. The overhang on each side is equal.
4. If the unit has not been pre-drilled (some models), carefully drill four  $\frac{1}{8}$ " holes through the grille and into the side flange of the unit approximately 1  $\frac{1}{2}$ " to 2" from the top and bottom as the images below. (Be careful not to drill into the copper heat exchanger coils.)
5. Install (4) #8 self-tapping screws to affix the grille to the unit.
6. Insert the unit into the sleeve.

## Completing Installation



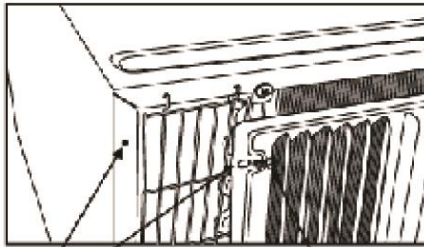
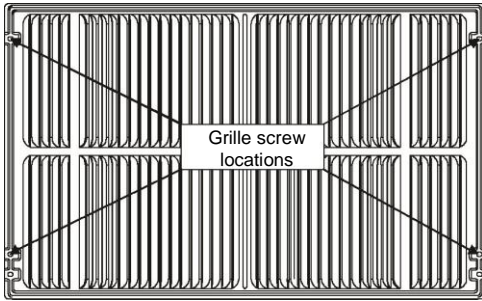
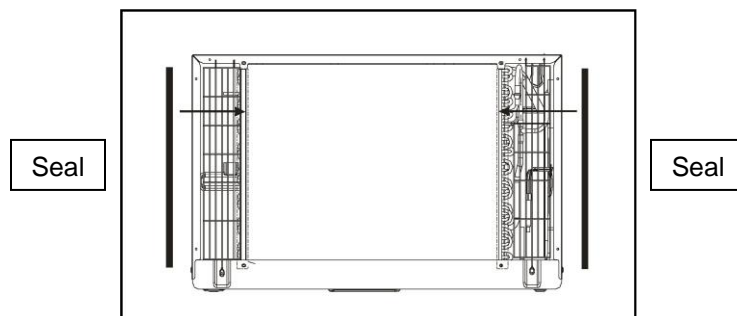





1. Install the 1" x 1  $\frac{1}{2}$ " x 84" long stuffer-seal between the wall-sleeve and the unit. A flat-bladed screwdriver or putty knife is recommended.
2. Assemble the trim frame by inserting top and bottom pieces into side pieces and snapping into place.
3. Pull cord through trim frame then slide over unit until flush with wall.



1/8" Hole, Grille,  
and Flange

#8 Screw

## Control Panel Operations

	On/Off
	Energy Saver
	Timer
	Mode
	Check Filter
	Fan Speed
	Sleep
	Temp/Timer Up
	Temp/Timer Down

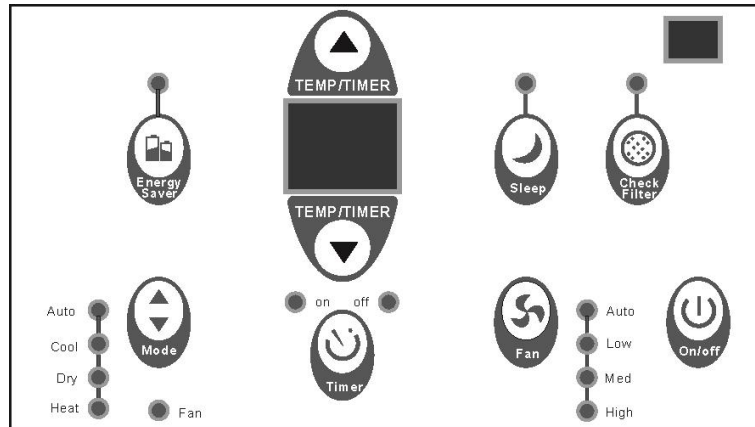



Using the Control Panel

### **To Turn Unit on:**

Press  On/Off Button. NOTE- The Energy Saver feature will automatically turn on in “Cool”, “Dry”, and “Auto” mode.

### **To Change Temperature:**

Press or hold either Up  or Down  button until desired temperature is seen on the digital display. This temperature will be automatically maintained anywhere between 62 °F (17°C) and 86°F (30°C). If you want the display to read the actual room temperature, see “To Operate on Fan only” section.

### **To Adjust Fan Speeds:**

To select the speed of the fan press Fan Speed  in four steps- Auto, Low, Medium, or High. Each time the button is pressed the fan speed mode is shifted. NOTE- During "Dry mode" the fan speed is controlled at Low automatically.

### **To Select Operating Mode:**

To choose operating mode press Mode . Each time you press the button a mode is selected in a sequence that goes from Auto, Cool, Dry, Heat to Fan. The indicator light beside will be illuminated and remain on once the mode is selected.

### **To operate on Auto Feature:**

- When you set the unit to “Auto” mode it will automatically select cooling, heating, or fan only operation depending on the temperature selected and the current room temperature.
- Once the temperature you selected is achieved the unit will automatically maintain the room temperature.

- In this mode the fan speed cannot be adjusted. It will start automatically at a speed according to the actual room temperature.

### **To operate on Fan Only:**

- Use this function only when cooling is not desired, such as for room circulation or to exhaust air (remember to open the vent). You can choose any speed you prefer.
- During this function the display will show the actual room temperature as in the cooling mode.
- In Fan only mode, the temperature is not adjusted.

### **To operate on Dry mode:**

- In this mode, the air conditioner will operate as a dehumidifier. Because the conditioned space is a closed or sealed area some degree of cooling will continue.



### **To Use Energy Saver Feature:**



To start the Energy saver, press . This feature is available on “Cool”, “Dry”, and “Auto”. The fan will continue to run for 3 minutes after the compressor shuts off. The fan then cycles on for 2 minutes at 10 minute intervals until the room temperature is above the set temperature at which the compressor turns back on and cooling starts.

### **To Use the Sleep Feature:**

At the time of sleep press the sleep button . In this mode the selected temperature will increase (cooling) or decrease (heating) by 2°F (2°C) 30 minutes after the mode is selected. The temperature will then increase (cooling) or decrease (heating) by another 2°F (2°C) after an additional 30 minutes. This new temperature will be maintained for 6 hours before it returns to the originally selected temperature. This ends the Sleep mode and the unit will continue to operate as originally programmed. The Sleep Mode program can be cancelled at any time during operation by again pressing the Sleep button.

### **To Use Timer (Auto Start/Stop) Feature:**

- When the unit is on or off, press the Timer button  the “Timer On” indicator light illuminates. It indicates the Auto Start program is initiated.
- To switch to off press the Timer button  again and the “Timer Off” indicator light illuminates. It indicates the Auto Stop program is initiated.

- Press or hold the Up  or Down  to change the Auto Time by ½ hour increments up to 10 hours or 1 hour increments up to 24 hours. The control will count down the time remaining until start.
- The selected time will register in 5 seconds and the system will automatically revert back to display the previous temperature setting or room temperature when the unit is on. (NOTE-when the unit is off there is no display)

### ***To Check Filter Feature:***

This feature is a reminder to clean the Air Filter for more efficient operation. The LED light will illuminate after 250 hours of operation.  To reset after cleaning the filter press the Check Filter button and the light will go off.

### ***Digital Display:***

Displays the set temperature in “C” or “F” and the Auto-Timer settings. While on Fan only mode it shows the room temperature.

### **Error Codes**

#### AS- Room temperature sensor error

- ✓ Unplug the unit and plug back in.
- ✓ If error repeats call for service.
- ✓ NOTE- In Fan only mode it will display “LO” or “HI”.

#### ● - Evaporator temperature sensor error

- ✓ Unplug the unit and plug back in.
- ✓ If error repeats, call for service.

#### HS-Electric Heating sensor error

- ✓ Unplug the unit and plug back in.
- ✓ If error repeats, call for service.

### Air Directional Louvers:

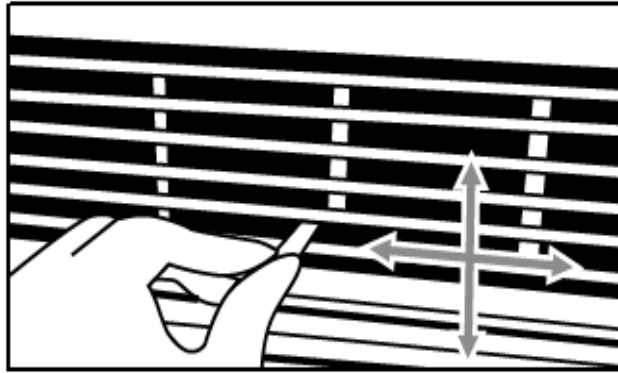

The 4-way air directional louvers allow you to direct the air flow Up, Down, Left, and Right throughout the room as needed. To adjust the air directional louvers side to side use the center handles as you move side to side.

### ***Additional Tips:***

The “Cool” mode has an automatic 3 minute timed delay start if the unit is turned off and on quickly. This prevents overheating of the compressor and possible circuit breaker tripping. The fan will continue to run during this time.

The control is capable of displaying the temperature in degrees Fahrenheit or degrees Celsius. To convert from one to the other, press and hold the Up and Down Temp/Timer buttons at the same time for 3 seconds

## Remote Operations

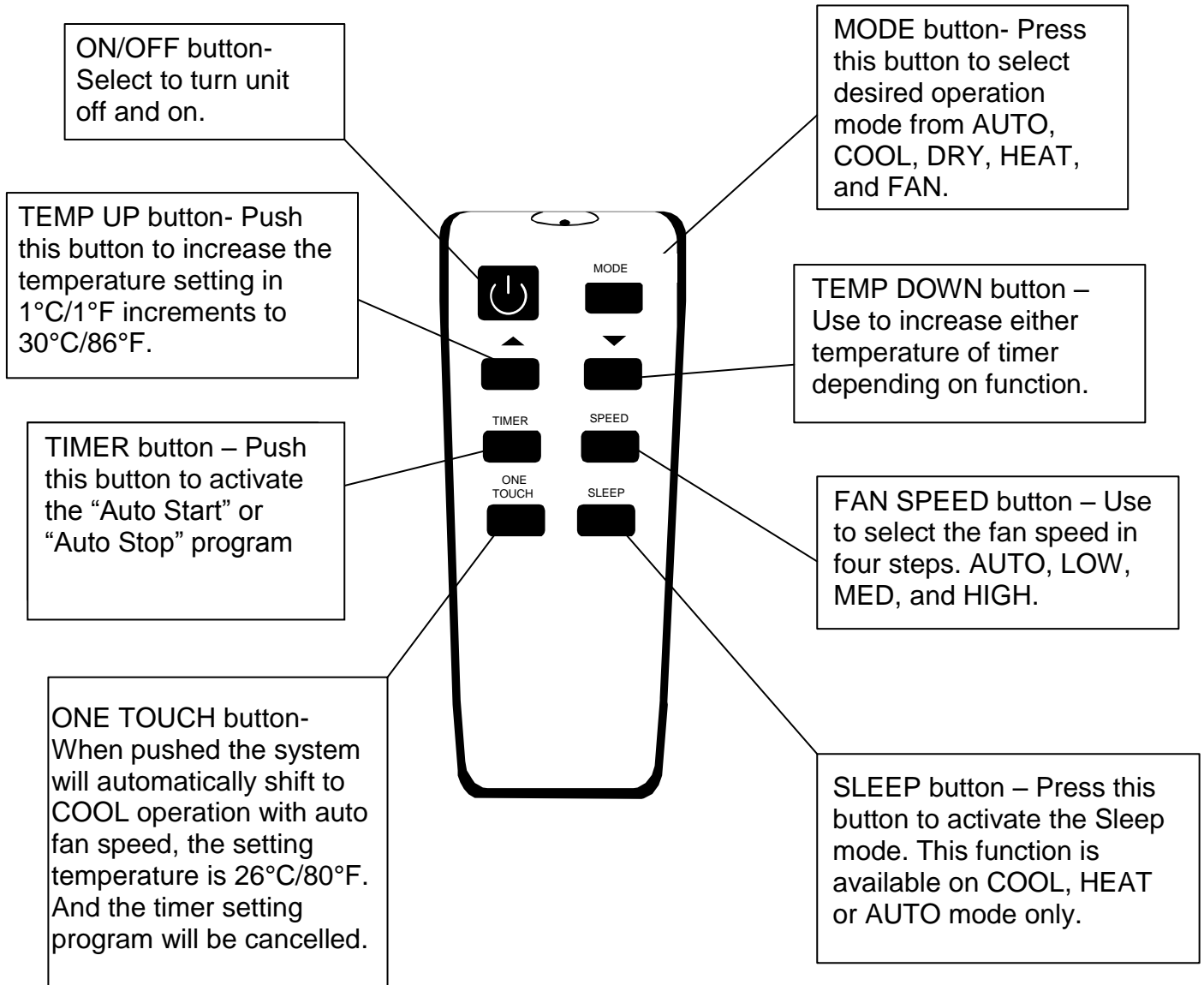

## Maintenance

Clean the air conditioner and filters regularly to maximize performance and efficiency, and prolong the unit's life. Be sure to always unplug the air conditioner from the power outlet before cleaning.

### *Air Filter Cleaning*

The air filter should be checked at least once a month to see if cleaning is necessary. Trapped particles in the filter can build up and could cause an accumulation of frost on the cooling coils.

**NOTE:** Winter Storage- If you plan to store the air conditioner during the winter, remove it carefully from the wall according to the installation instructions. Make sure to clean the unit thoroughly and cover it with plastic or return it to the original carton.

1. Push the vent handle to the "vent closed" position.
2. Open the front panel.
3. Grasp the filter, pull up and out.
4. Wash the filter using liquid dishwashing detergent and warm water. Rinse filter thoroughly.
5. Gently shake excess water from the filter. Be sure the filter is thoroughly dry before replacing.
6. You also have the option of cleaning filter with vacuum.

**Warning:** Never use hot water over 40C (104F) to clean the air filter. Never attempt to operate the unit without the air filter.

### *Cabinet Cleaning*

- Be sure to unplug the air conditioner to prevent shock or fire hazard. The cabinet and front may be dusted with an oil-free cloth or washed with a cloth dampened in a solution of warm water and mild dishwashing detergent. Rinse thoroughly and wipe dry.
- Never use harsh cleaners, wax, or polish on the cabinet front.
- Be sure to wring excess water from the cloth before wiping around the controls. Excess water in or around the controls may cause damage to the air conditioner.



## Normal Sounds

- High Pitched Chatter- High efficiency compressors may have a high pitched chatter during the cooling cycle.
- Sound of Rushing Air- At the front of the unit, you may hear the sound of rushing air being moved by the fan.
- Gurgle/Hiss- Gurgling or Hissing noise may be heard due to refrigerant passing through evaporator during normal operation.
- Vibration- Unit may vibrate and make noise because of poor wall construction or incorrect installation.
- Pinging or Switching- Droplets of water hitting condenser during normal operation may cause these sounds.

## Energy Saving Guide

Read and follow the guide below to get the best performance and efficiency from your air conditioner:

- Do not cover the air outlet (exhaust) while in use.
- Use the timer to operate the unit before it is needed. For example, set the timer to turn on the unit in cooling mode for 3 or more hours to cool the room before you arrive. You may want to operate the unit all day if you live in a warmer climate.
- Minimize the heat sources (direct sunlight, computers, servers, people, etc.) in the room.
- Close all windows and doors.
- Use the unit in a contained room. For example, a room with four windows and a ceiling, instead of a partitioned studio, or warehouse.
- Make sure the unit is secure with no gaps where air can escape.
- Minimize the amount of humidity in the room. For example, run the unit as a dehumidifier.
- To prolong the compressor's life, please wait at least 3 minutes before turning the unit back on after shutting it off.
- Inspect and keep the air filters clean by cleaning regularly.
- Perform routine maintenance.

## Troubleshooting

Follow the troubleshooting guide below to resolve common issues.

Issue	Possible Cause	Solution
My air conditioner is not functioning at all	Wall plug disconnected	Make sure the unit is plugged in.
	LCDI power cord is tripped	Press the Reset button on the LCDI cord.
	House fuse blown or circuit breaker tripped.	Replace fuse with time delay type or reset circuit breaker.
	Control panel is off	Turn control panel ON and set to desired setting.
	Insufficient power	Move the unit to another outlet. Check your circuit breaker. (Refer to the rating label on the back of the unit to determine the Amperage draw).
Air from unit does not feel cold enough	Room temperature below 17°C (62°F)	Cooling may not occur until room temperature rises above 17°C (62°F).
	Temperature sensing element touching cold coil, located behind air filter	Straighten tube away from coil.
	Compressor shut-off by changing modes	Wait approximately 3 minutes and listen for compressor to restart when set in the COOL mode.
Air conditioner is cooling but room is too warm, ice is forming on cooling coil behind decorative front.	Outdoor temperature below 18°C (64°F)	To defrost the coil, set FAN ONLY mode.
	Air filter may be dirty	Clean Filter. Refer to maintenance section. To defrost set to FAN ONLY mode.
	Thermostat set too cold for night-time cooling.	To defrost the coil, set to FAN ONLY mode. Then, set temperature to higher setting.
Air conditioner is cooling but room is too warm, NO ice is forming on cooling coil behind decorative front.	Dirty air filter, air restricted	Clean air filter. Refer to maintenance section.
	Temperature is set too High	Set temperature to lower setting.
	Air directional louvers positioned improperly	Position louvers for better air distribution.
	Front of unit is blocked by drapes, blinds, furniture, etc., restricts air distribution	Clear blockage in front of unit.

<b>Issue</b>	<b>Possible Cause</b>	<b>Solution</b>
Air conditioner is cooling but room is too warm, NO ice is forming on cooling coil behind decorative front	Open doors, windows, etc.	Open = cold air escapes. Close doors, windows, etc.
	Unit recently turned on in hot room	Allow additional time to remove "stored heat" from windows, ceiling, floor and furniture.
Air conditioner turns on and off rapidly	Dirty air filter, air restricted	Clean air filter.
	Outside temperature extremely hot	Set FAN speed to a higher setting to bring air past cooling coils more frequently.
	Outside temperature extremely hot  Air movement sound, this is normal	Set FAN speed to a higher setting to bring air past cooling coils more frequently. If too loud, set to a slower FAN setting.
	Wall vibration, poor installation	Refer to installation instructions or check with installer.
Water dripping INSIDE when unit is cooling	Improper installation	Tilt air conditioner slightly to the outside to allow water drainage.
Water dripping OUTSIDE when unit is cooling	Unit removing large quantity of moisture from humid room	This is normal during excessively humid days.
Remote not sensing	Remote control not located within range	Place remote control with 20 feet and 180 degrees radius of the front of the unit.
	Remote control signal obstructed	Remove obstruction.
Room too cold	Set temperature too low	Increase set temperature.

## Specifications

Description of product	Wall Air Conditioner and Heater
Model	WTC8000W
Voltage/Frequency	115 V / 60 HZ
Input Power (cooling / heating)	890W / 1320W
Current (cooling / heating)	8.0A / 12.0A
Color	White
Coolant	R410A /13.4
Timer	24 Hour
Dimensions W x D x H	24.2" x 20.3" x 14.5"
Weight	62.7Lbs.

# EdgeStar Limited Warranty

## One (1) Year Parts & Ninety (90) Days Labor

This product is warranted by EdgeStar to be free from defective workmanship and materials, subject to any conditions set forth as follows:

### WHAT IS COVERED:

**LABOR:** For a period of NINETY (90) DAYS from the date of original purchase, labor will be performed free of charge at an authorized EdgeStar repair facility. At its option, EdgeStar will repair the product with new or remanufactured parts, or exchange the defective product with a new, refurbished, or remanufactured product. If a product is replaced, it will carry the remaining warranty of the original product. After the ninety (90) day period, EdgeStar will no longer be responsible for labor charges incurred. All defective products and parts covered by this warranty will be repaired or replaced on a mail-in basis to an EdgeStar authorized repair facility.

**PARTS:** For a period of ONE (1) YEAR from the date of original purchase, EdgeStar will supply new, rebuilt, or refurbished parts free of charge. EdgeStar may request a defective part be returned in exchange for the replacement part. All replacement parts or products will be new, remanufactured, or refurbished. All products and parts replaced by EdgeStar under warranty service become the property of EdgeStar.

This warranty applies to the original purchaser only, and only covers defects in workmanship experienced during operation of the product under normal service, maintenance, and usage conditions. This warranty applies to the purchase and use of this product in residential settings within the United States of America.

### WHAT IS NOT COVERED:

The following limitations apply to the coverage of this warranty. This warranty does not cover:

- Labor charges for installation, setup or training to use the product.
- Shipping damage, and any damage caused by improper packaging for shipment to an authorized service center, and any damaged caused by improper voltage or any other misuse, including abnormal service, handling, or usage.
- Cosmetic damage such as scratches and dents.
- Normal wear and tear on parts or replacement of parts designed to be replaced, e.g. filters, cartridges, batteries.
- Service trips to deliver, pick-up, or repair, install the product, or to instruct in proper usage of the product.
- Damages or operating problems resulting from misuse, abuse, operation outside environmental specifications, uses contrary to instructions provided in the owner's manual, accidents, acts of God, vermin, fire, flood, improper installation, unauthorized service, maintenance negligence, unauthorized installation or modification, or commercial use.
- Labor charges incurred 91 days or more after the date of original purchase.
- The use of EdgeStar products in commercial settings.
- Optional accessories, attachments, and appearance items.
- Products that have been modified to perform outside of specifications without the prior written permission of EdgeStar.
- Products lost in shipment, or theft.
- Products sold AS IS or from an unauthorized reseller.
- Products that have had their serial numbers removed or defaced. Products with serial numbers that have been invalidated.

### OBTAINING WARRANTY SERVICE:

If you believe your product is defective, contact EdgeStar Customer Support for troubleshooting assistance and warranty service at 1-866-319-5473. Please have your serial number and proof of purchase available. Once an EdgeStar authorized representative has confirmed that your product is defective and eligible for warranty service, the product must be returned to an EdgeStar repair facility. The purchaser is solely responsible for prepaying all shipping related costs to and from the repair facility. EdgeStar is not responsible for damage resulting from shipper mishandling or improper packaging. Do not return a defective product to the place of purchase. Products received without a return authorization number will be refused.

THIS WARRANTY IS IN LIEU OF ANY OTHER WARRANTY, EXPRESSED OR IMPLIED, INCLUDING WITHOUT LIMITATION, ANY WARRANTY OF MERCHANTABILITY OR FITNESS FOR A PARTICULAR PURPOSE. TO THE EXTENT ANY IMPLIED WARRANTY IS REQUIRED BY LAW, IT IS LIMITED IN DURATION TO THE EXPRESS WARRANTY PERIOD ABOVE. NEITHER THE MANUFACTURER NOR ITS DISTRIBUTORS SHALL BE LIABLE FOR ANY INCIDENTAL, CONSEQUENTIAL, INDIRECT, SPECIAL, OR PUNITIVE DAMAGES OF ANY NATURE, INCLUDING WITHOUT LIMITATION, LOST REVENUES OR PROFITS, OR ANY OTHER DAMAGE WHETHER BASED IN CONTRACT, TORT, OR OTHERWISE. SOME STATES DO NOT ALLOW THE EXCLUSION OF INCIDENTAL OR CONSEQUENTIAL DAMAGES, SO THE ABOVE EXCLUSION MAY NOT APPLY TO YOU. THIS WARRANTY GIVES YOU SPECIFIC LEGAL RIGHTS. YOU MAY HAVE OTHER RIGHTS THAT VARY FROM STATE TO STATE.

# **Koldfront<sup>®</sup>**

By

EdgeStar Products  
500 N. Capital of TX Hwy, Bldg 5  
Austin, TX 78746-3448

Toll Free: 1-866-319-5473  
Web: <http://www.edgestar.com>  
E-mail: [service@edgestar.com](mailto:service@edgestar.com)

Register your product, download owner's manuals, access additional troubleshooting resources, and obtain more information on other great EdgeStar & Koldfront products on the web at: <http://www.edgestar.com>

Product contents and specifications may change without notice.

Copyright © 2014 Living Direct, Inc.