

2019 COLLECTIONS

MA / U
Studios



**UPDATE
2019**

INDEX

Pag. II	LIVING
Pag. XVIII	KITCHEN
Pag. XXVI	BATHROOM
Pag. XLVIII	WARDROBE

LIVING

The R.I.G. Modules shelving system is able to transform into any number of solutions suitable for the living room, study, entrance hall and dining room: television stands, side tables for lighting, low tables next to sofas, credenzas and low height bookcases.

R.I.G. MODULES



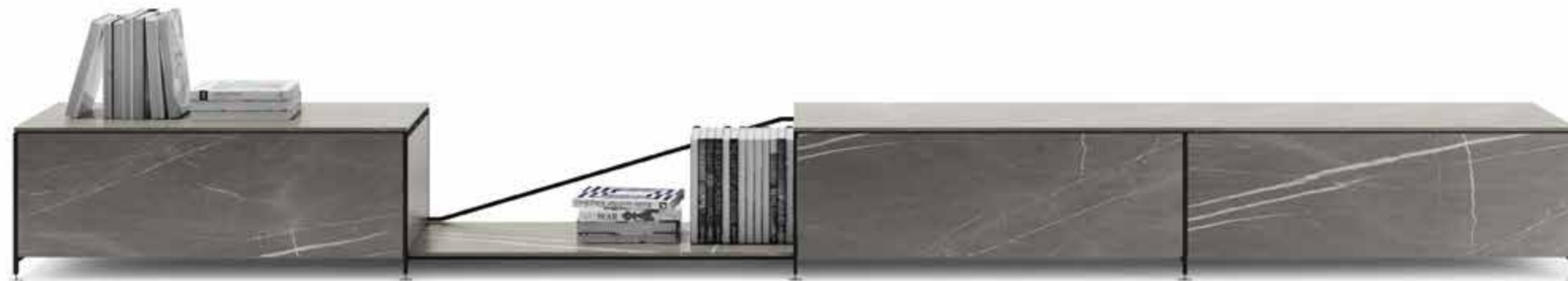

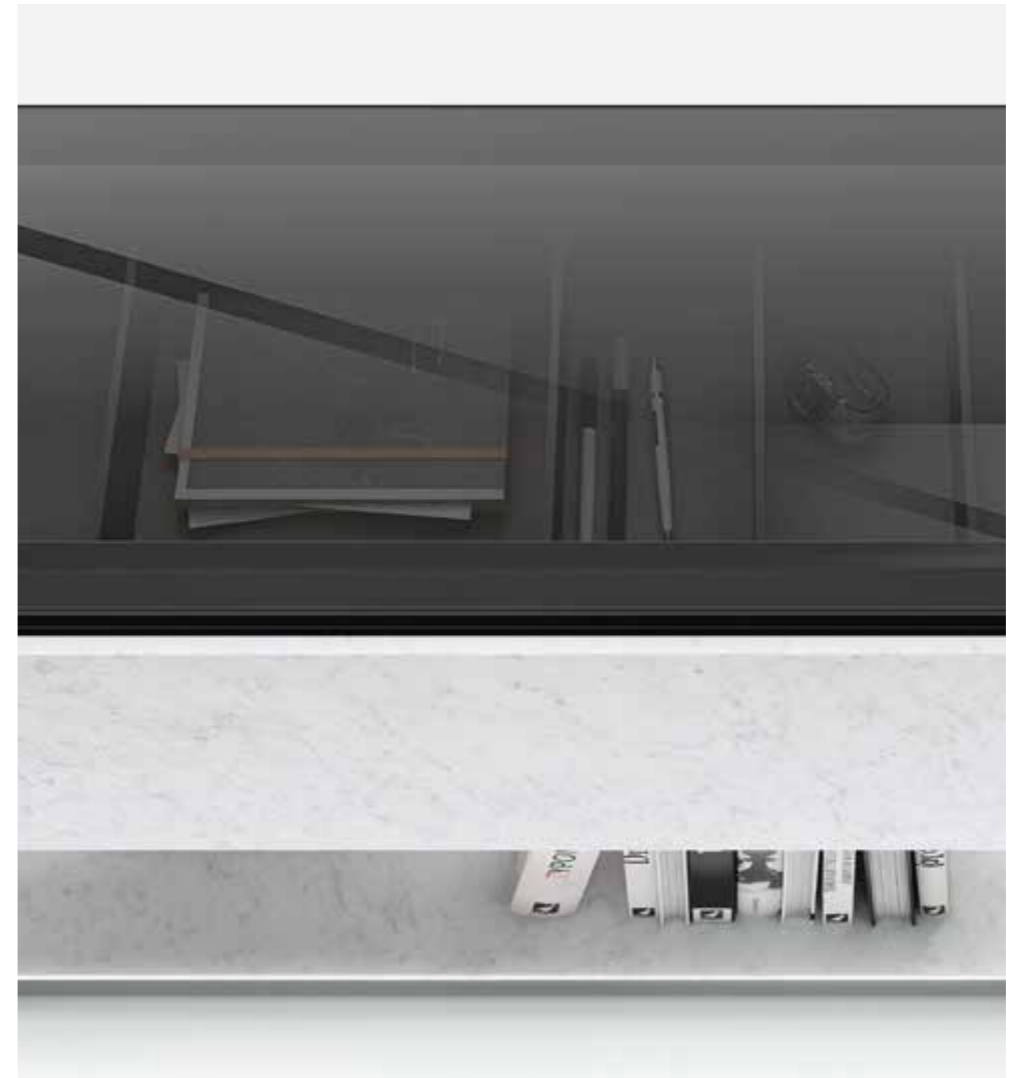





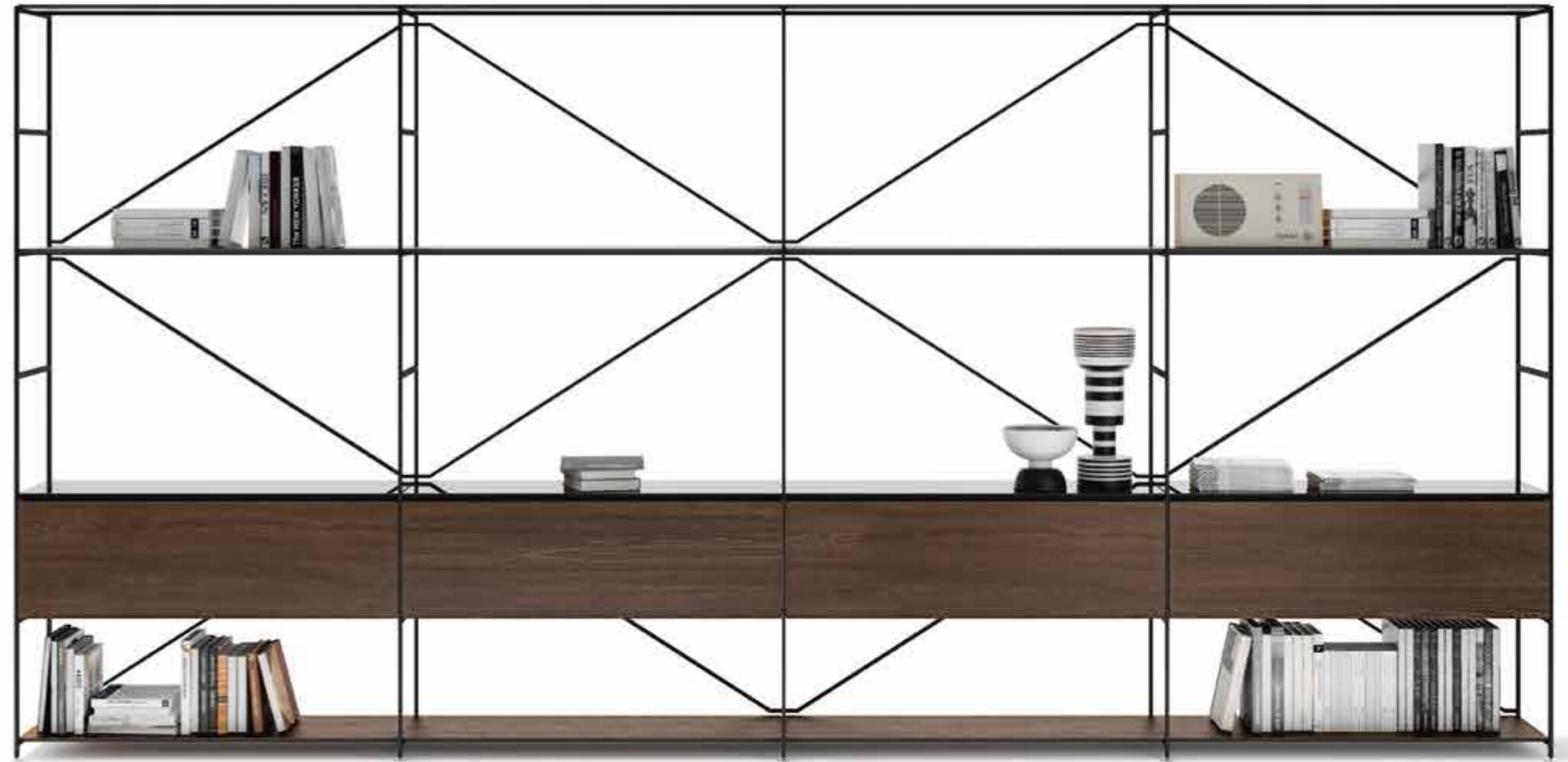





R.I.G. BENCH

KITCHEN

A shelving unit with customized accessories for the kitchen to offer an open storage system for provisions, glassware, cookware and kitchen utensils.

R.I.G. MODULES KITCHEN







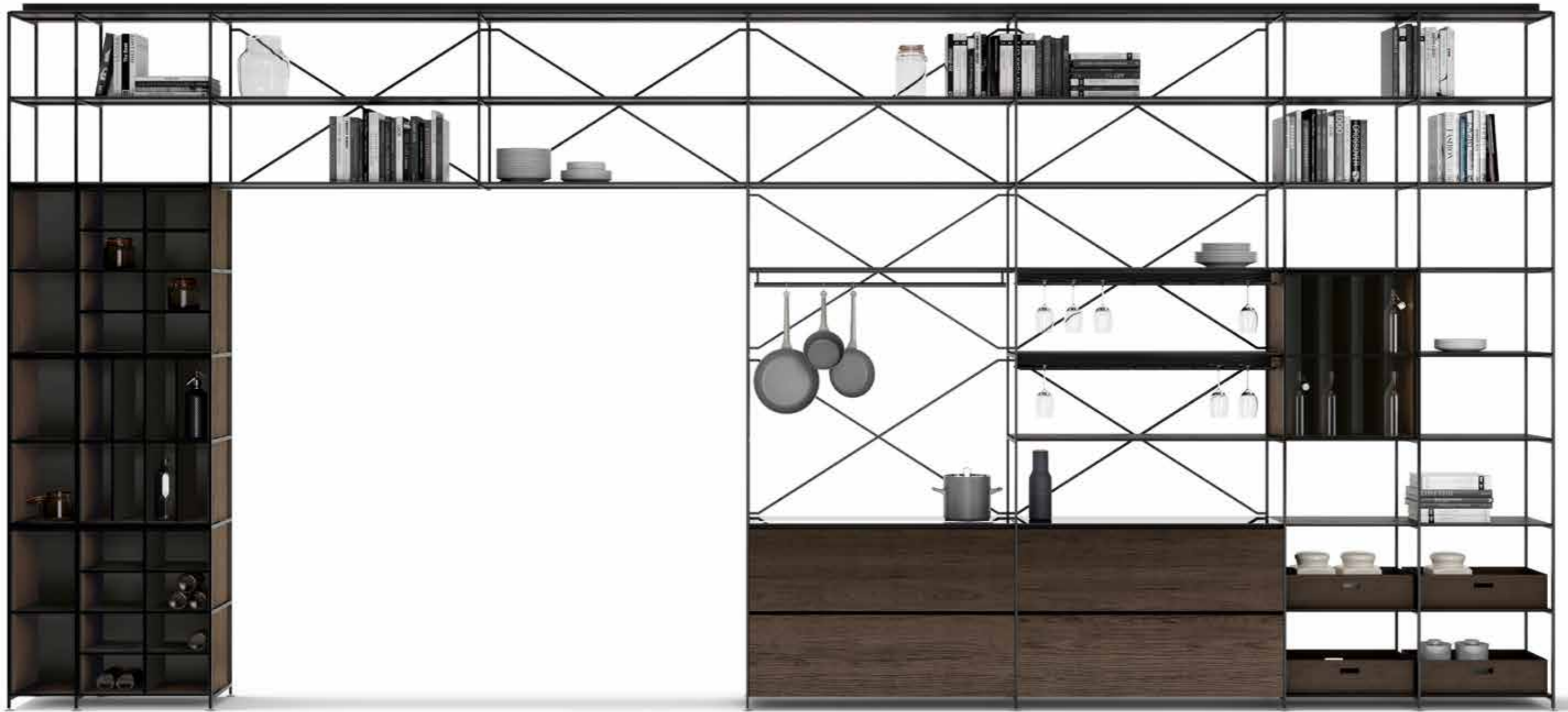

BATHROOM

The R.I.G. Modules system is able to create original solutions for sophisticated bathrooms. The solid construction of each module and the clean geometric lines of the setup are advantageous when working with natural stone and metal or with freestanding or wall-mounted units. The system is completed with two types of mirrors: self-supporting or wall-mounted.

R.I.G. MODULES BATHROOM



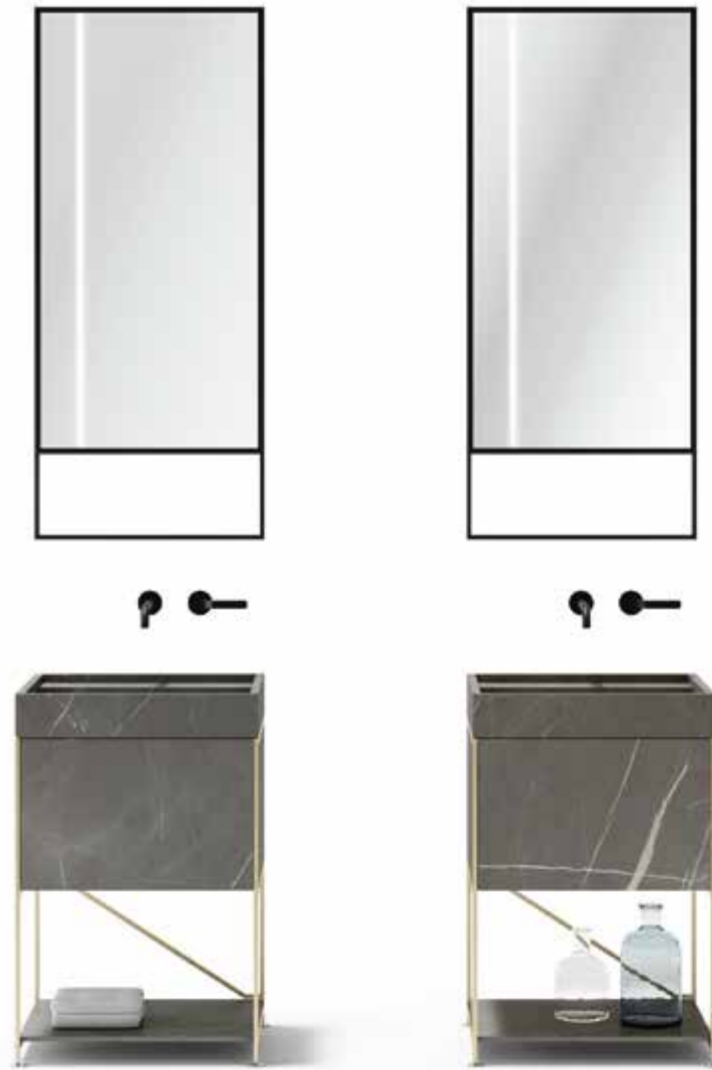

R.I.G. MODULES BATHROOM

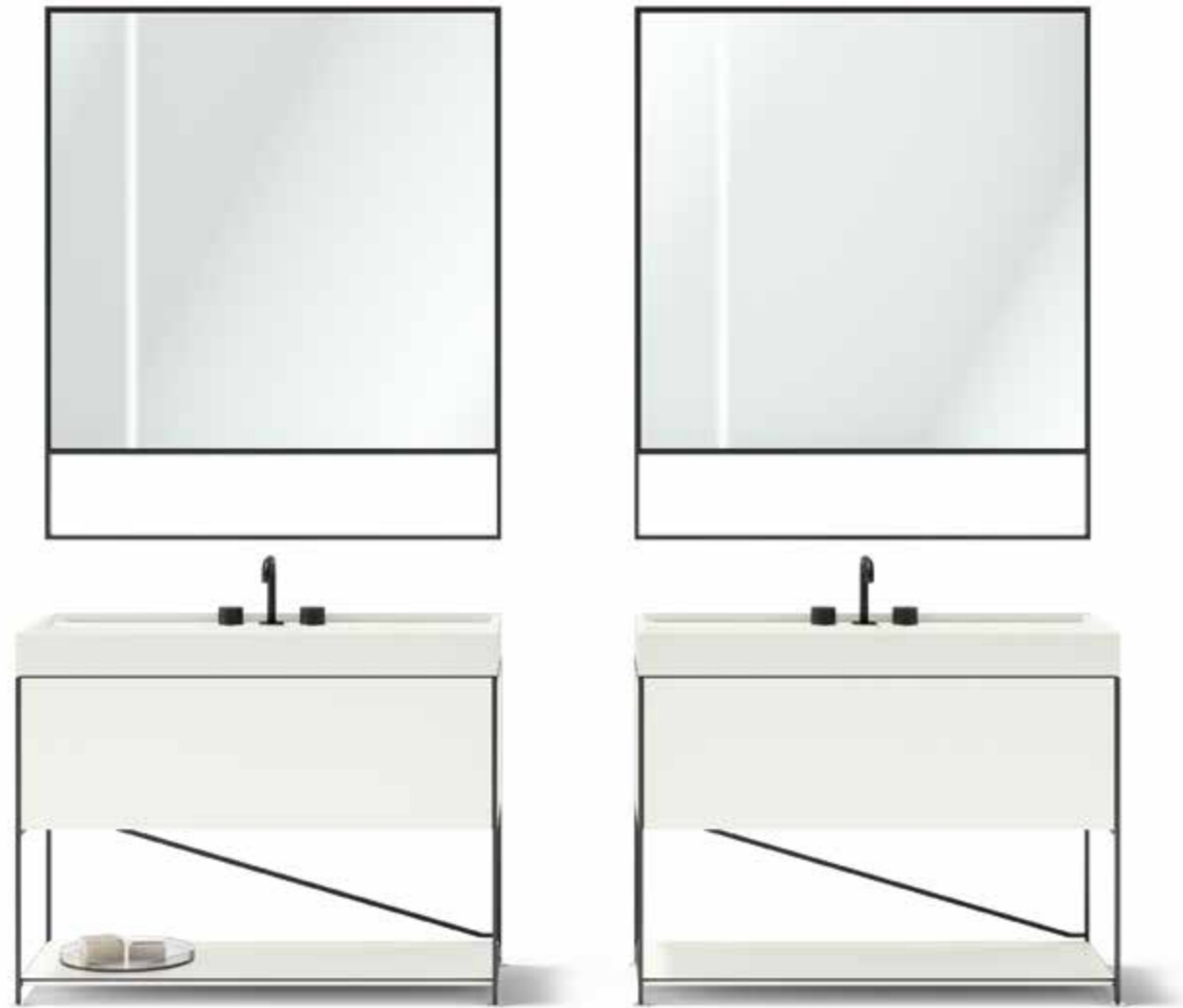



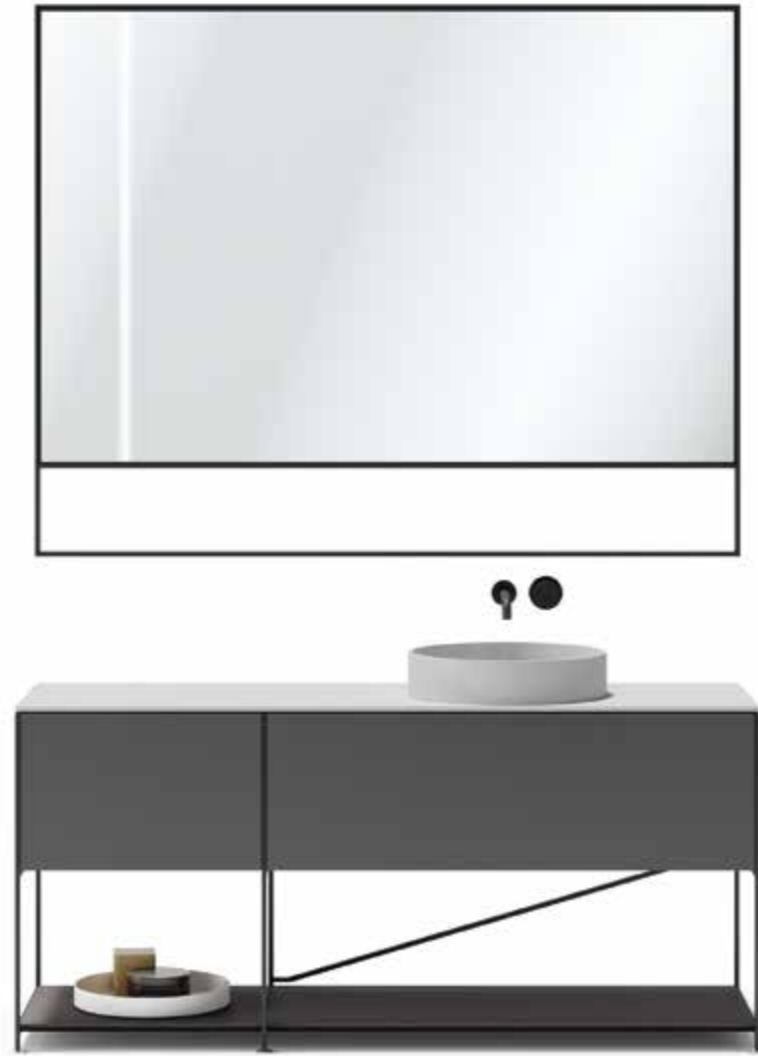













WARDROBE

The R.I.G. Modules lends itself to wardrobe solutions to create a simple and efficient way to store clothing in an open and uncomplicated setup complete with drawers, mirrors, hangers and essential elements common to traditional walk-in closets.

R.I.G. MODULES WARDROBE

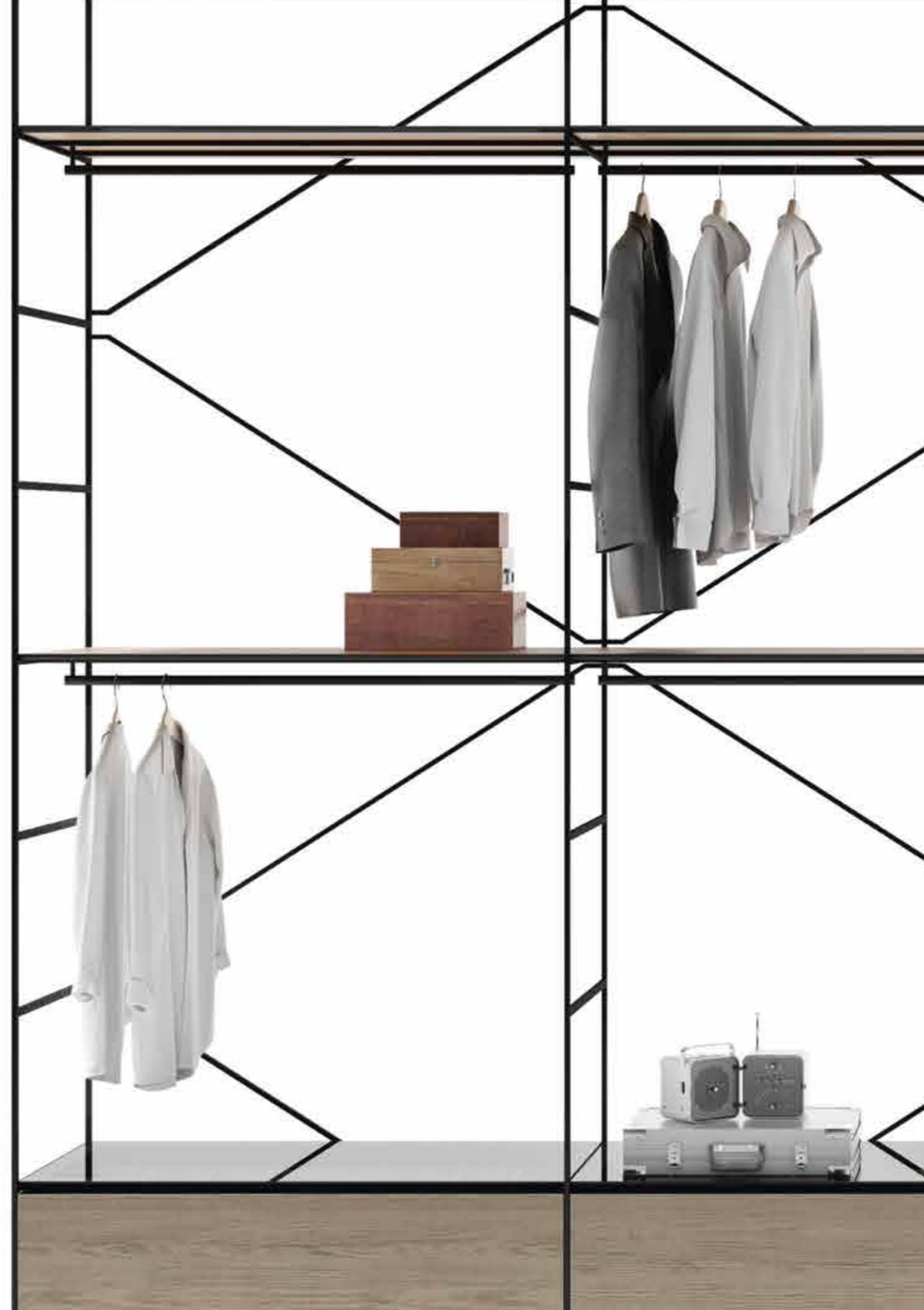





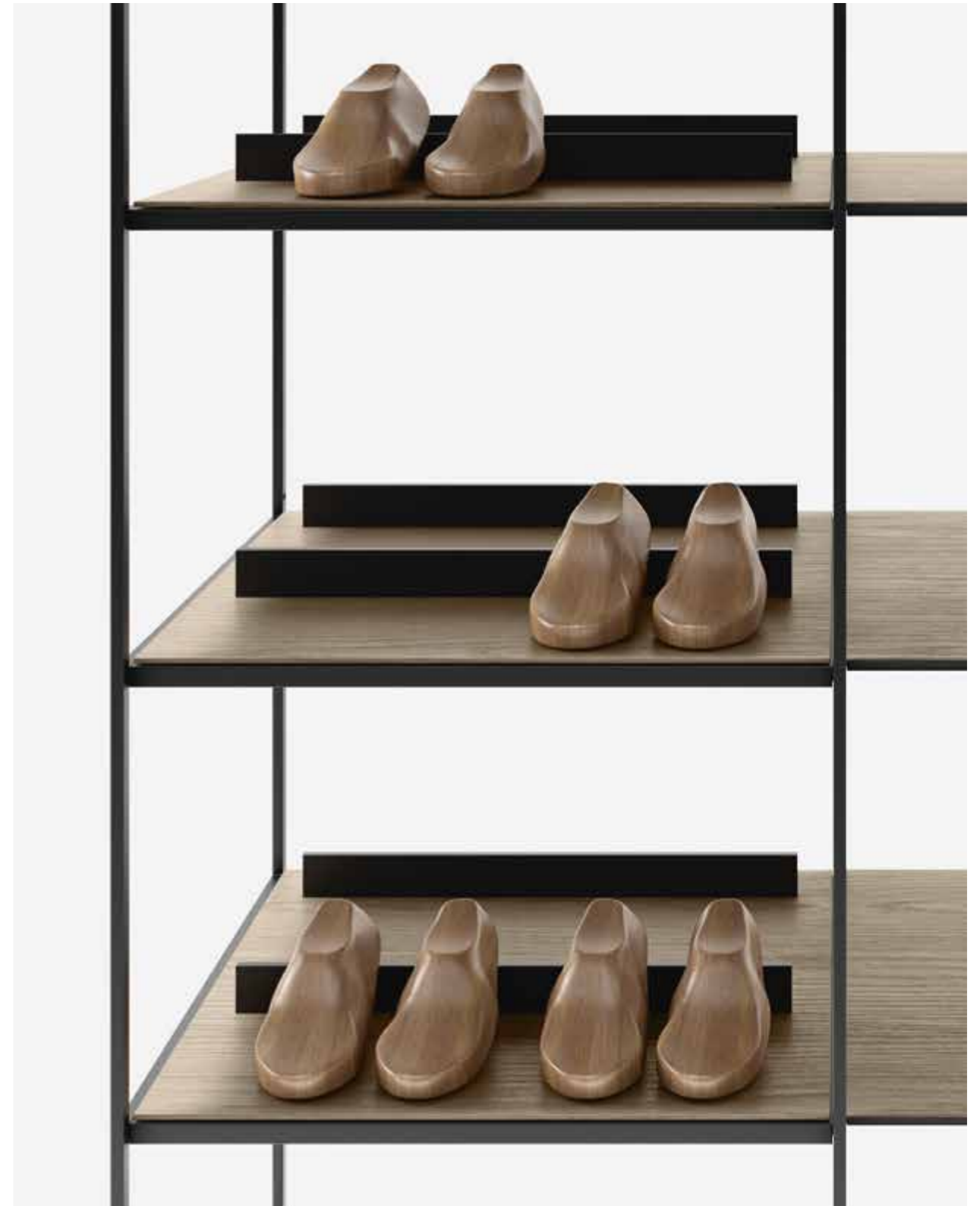

R.I.G. MODULES WARDROBE







INDEX

Pag. 4	R.I.G. MODULES
Pag. 36	R.I.G. BENCH
Pag. 44	T.T.A. TABLE
Pag. 54	N.E.T. TABLE
Pag. 64	C.O.P. STORAGE SYSTEM
Pag. 75	TECHNICAL INFORMATION

Founded in 2012 in Copenhagen by the designer Mikal Harrsen and under consultancy of architect Adam Hall, MA/U Studio can be summed up in a few simple principles: clean lines, functionality and constant research without compromise on quality. Over the years, these objectives gave birth to the production of multifunctional furniture that reinterprets Scandinavian tradition in a contemporary way, being attentive to the expectations of global markets and focusing on space flexibility. A cultural trend increasingly crossing boundaries between professional and domestic interiors and favouring furniture pieces able to change and adapt to different spaces.

**R.I.G.
MODULES**

**RUDIMENTARY
INTERIOR
GEOMETRY**

DESIGN BY MIKAL HARRSEN

“by using well known construction techniques, we wanted to create a design with an absolute generic appearance, which would allow the structure and the materials to perform as the ultimate leading character”





R.I.G. MODULES





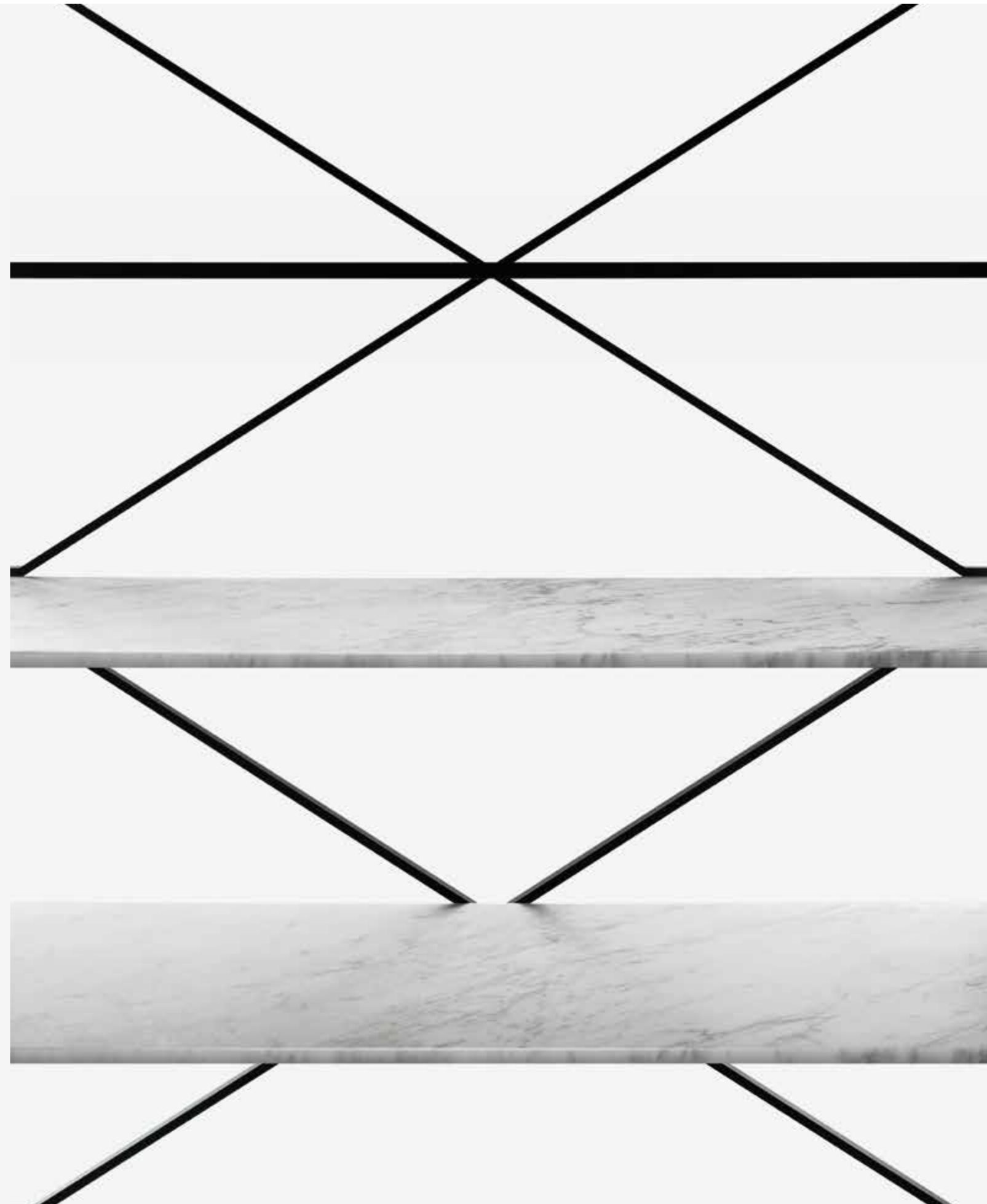



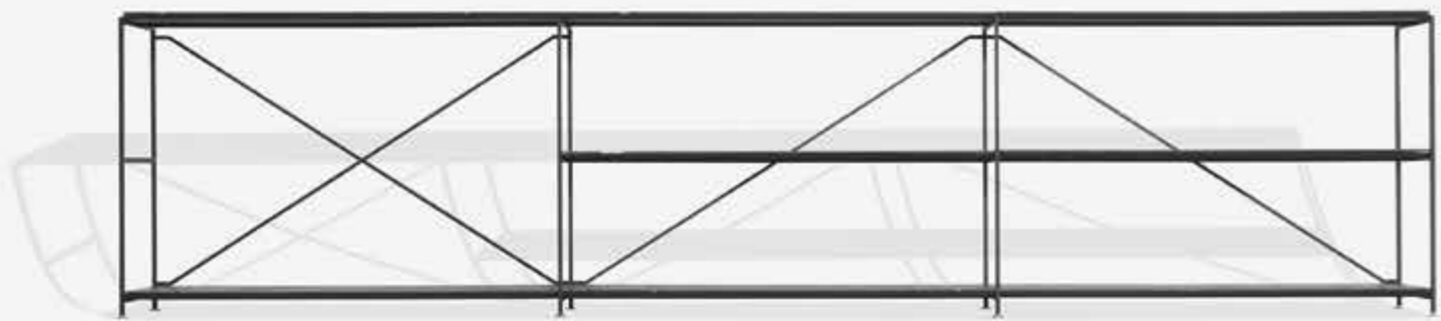

R.I.G. MODULES

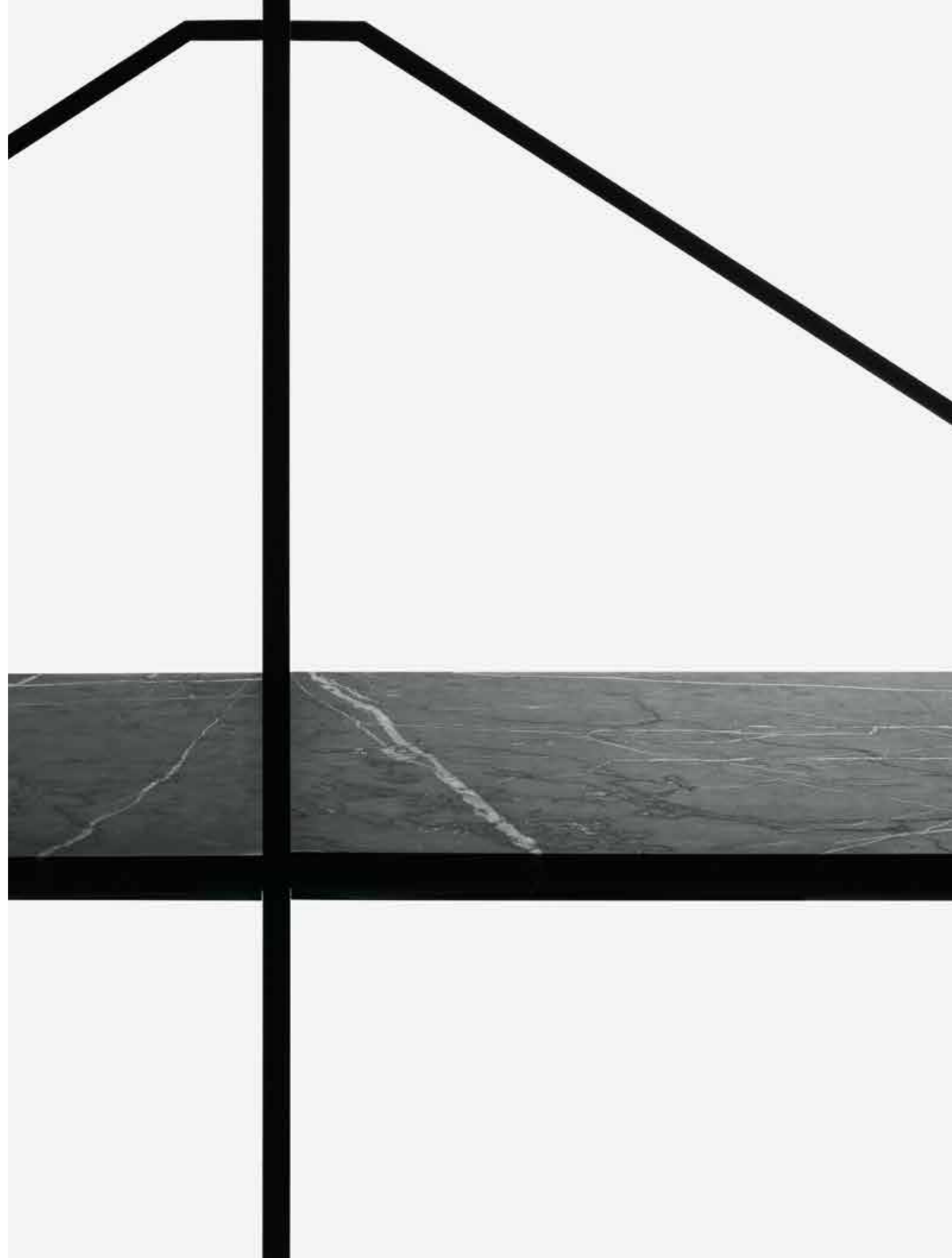



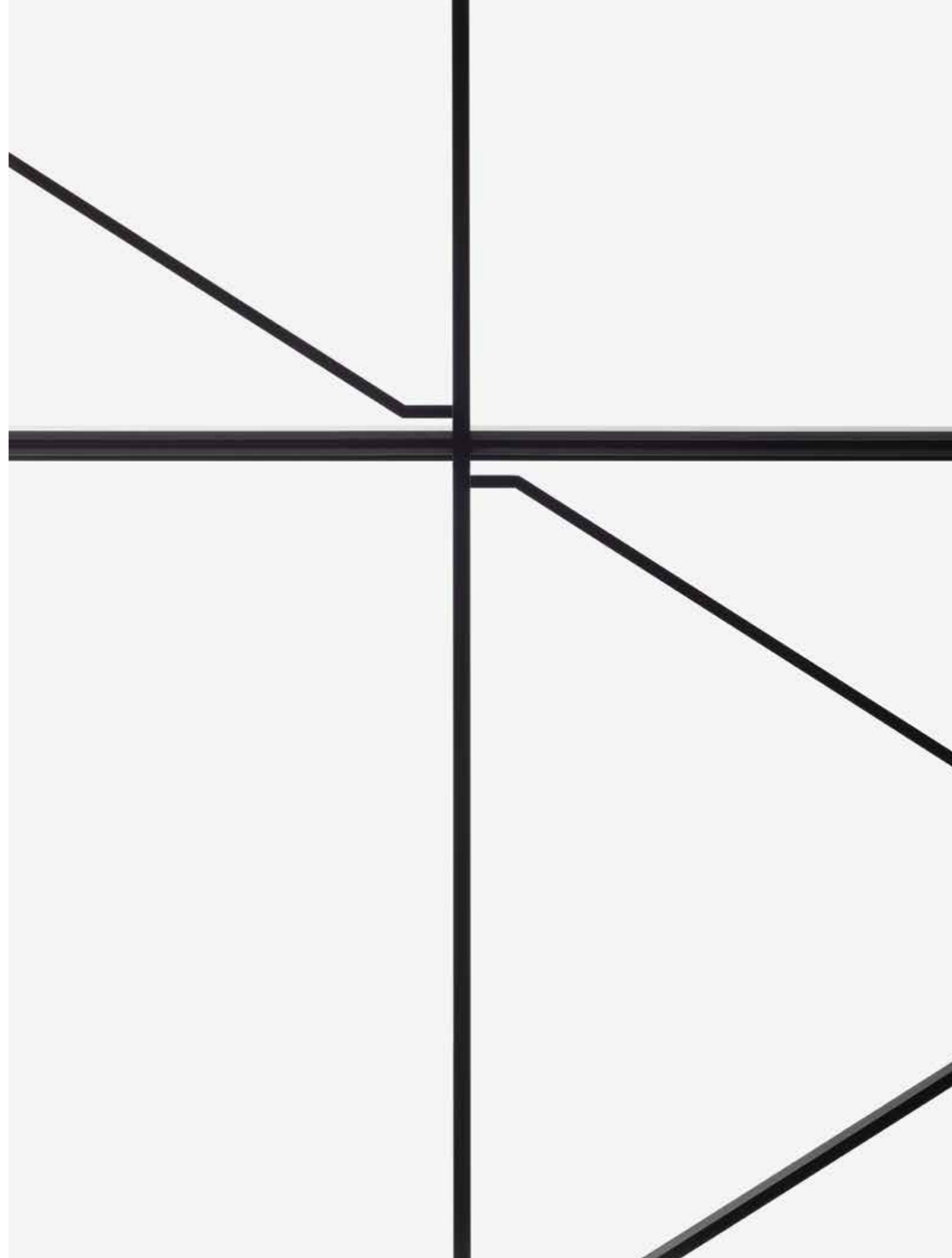

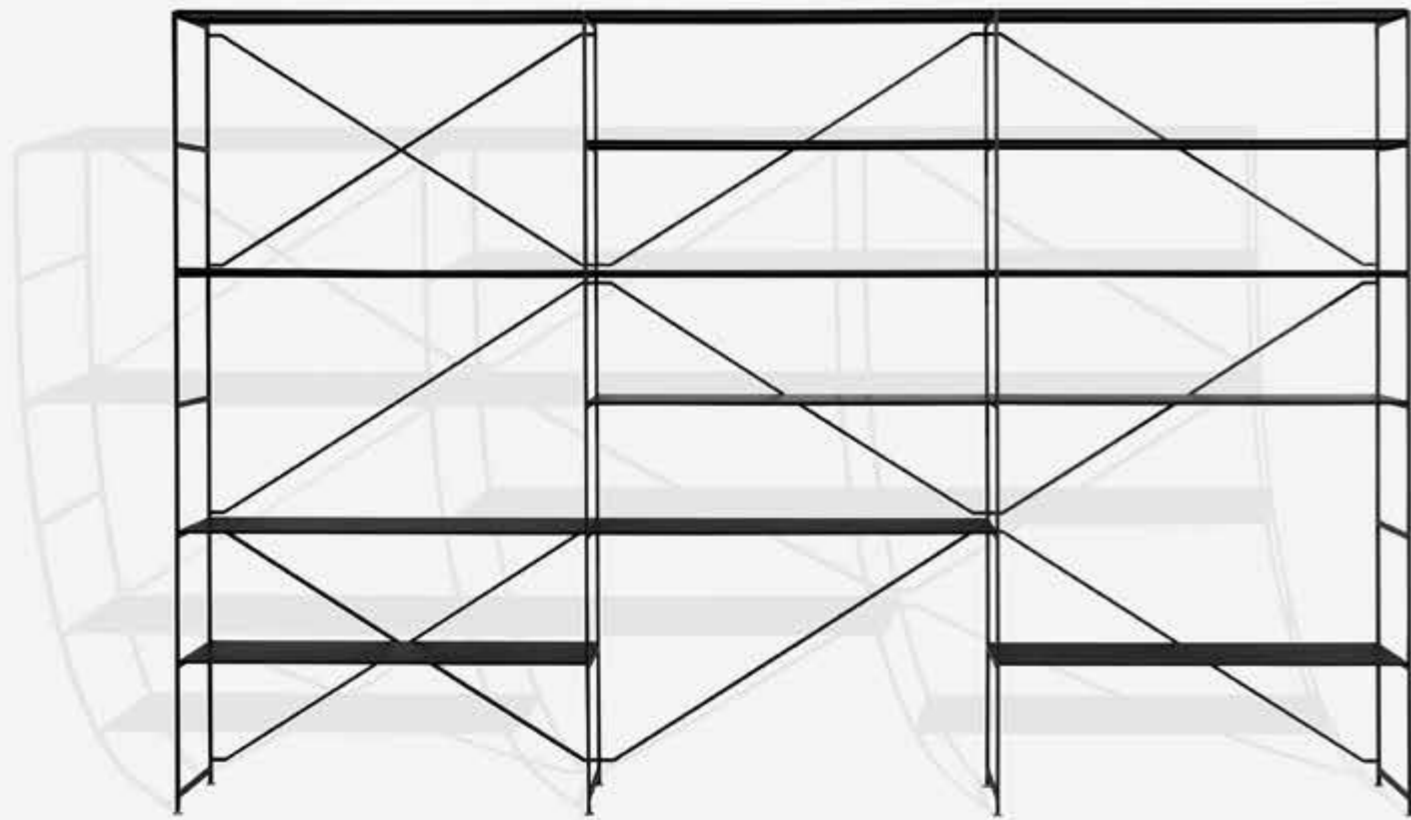



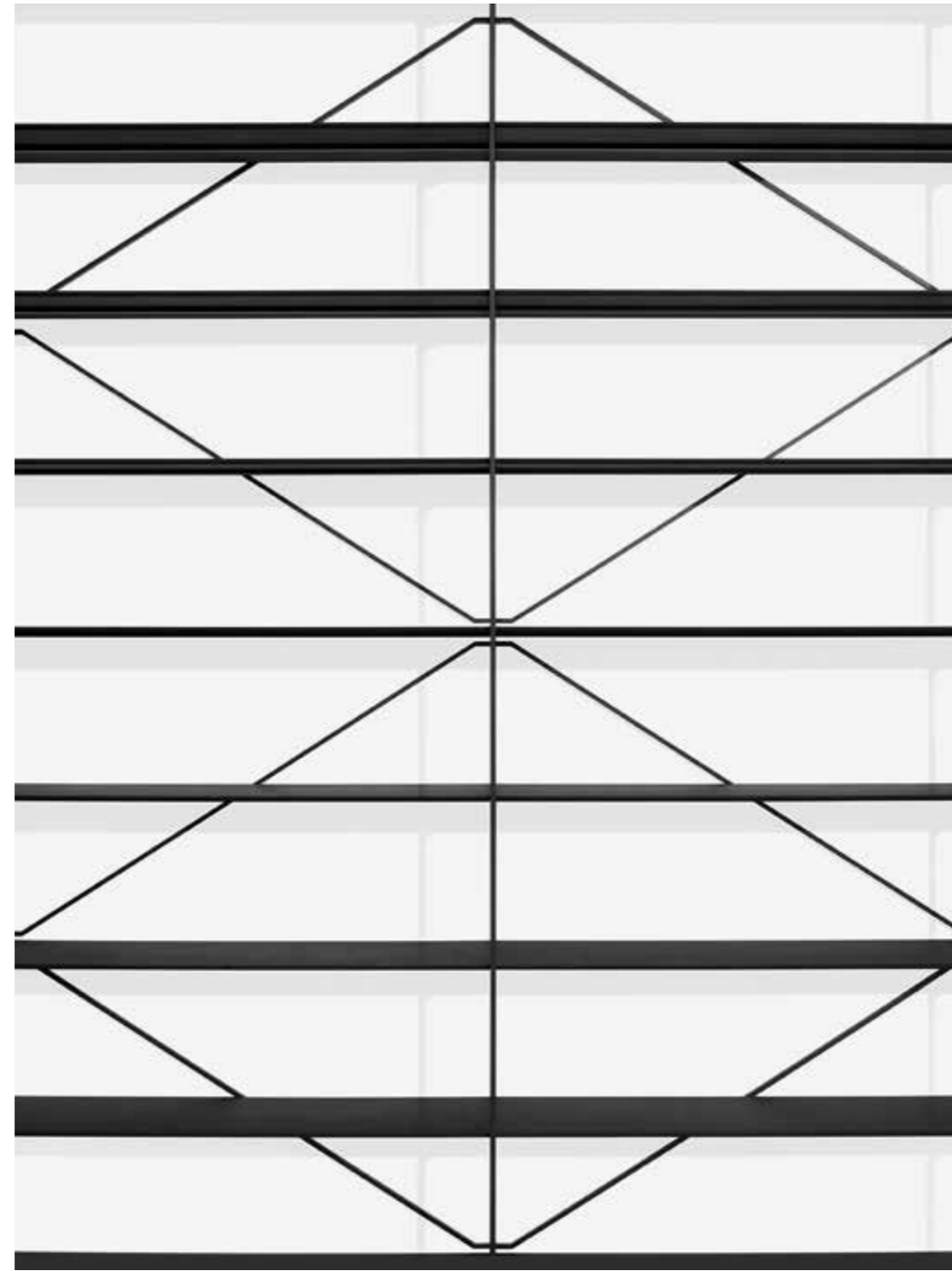

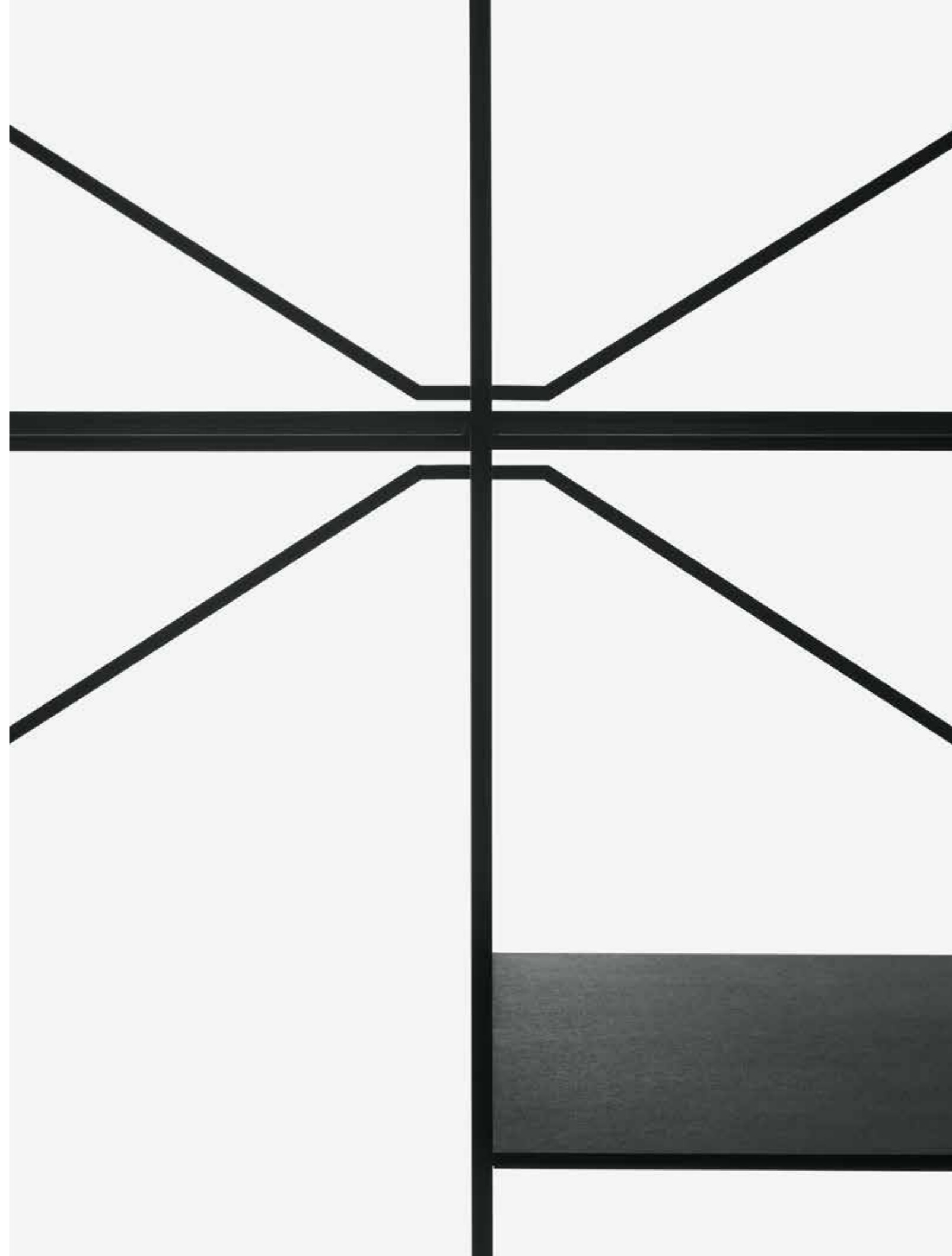

**R.I.G.
BENCH**

**RUDIMENTARY
INTERIOR
GEOMETRY**

DESIGN BY MIKAL HARRSEN & ADAM HALL







R.I.G. BENCH



**T.T.A.
TABLE**

**TRIBUTE
TO ALBERS**

DESIGN BY MIKAL HARRSEN



“inspired by the optical experimental works of Josef Albers, we set out to create a simple geometrical structure for a table frame”

T.T.A. TABLE

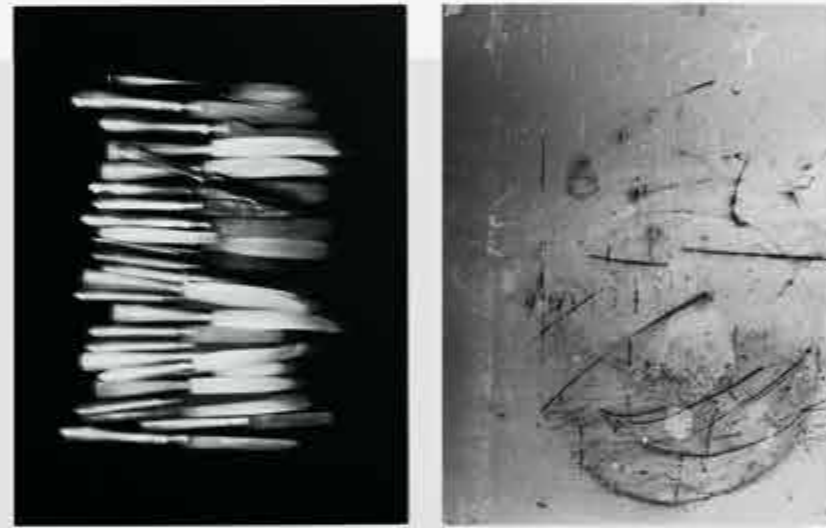

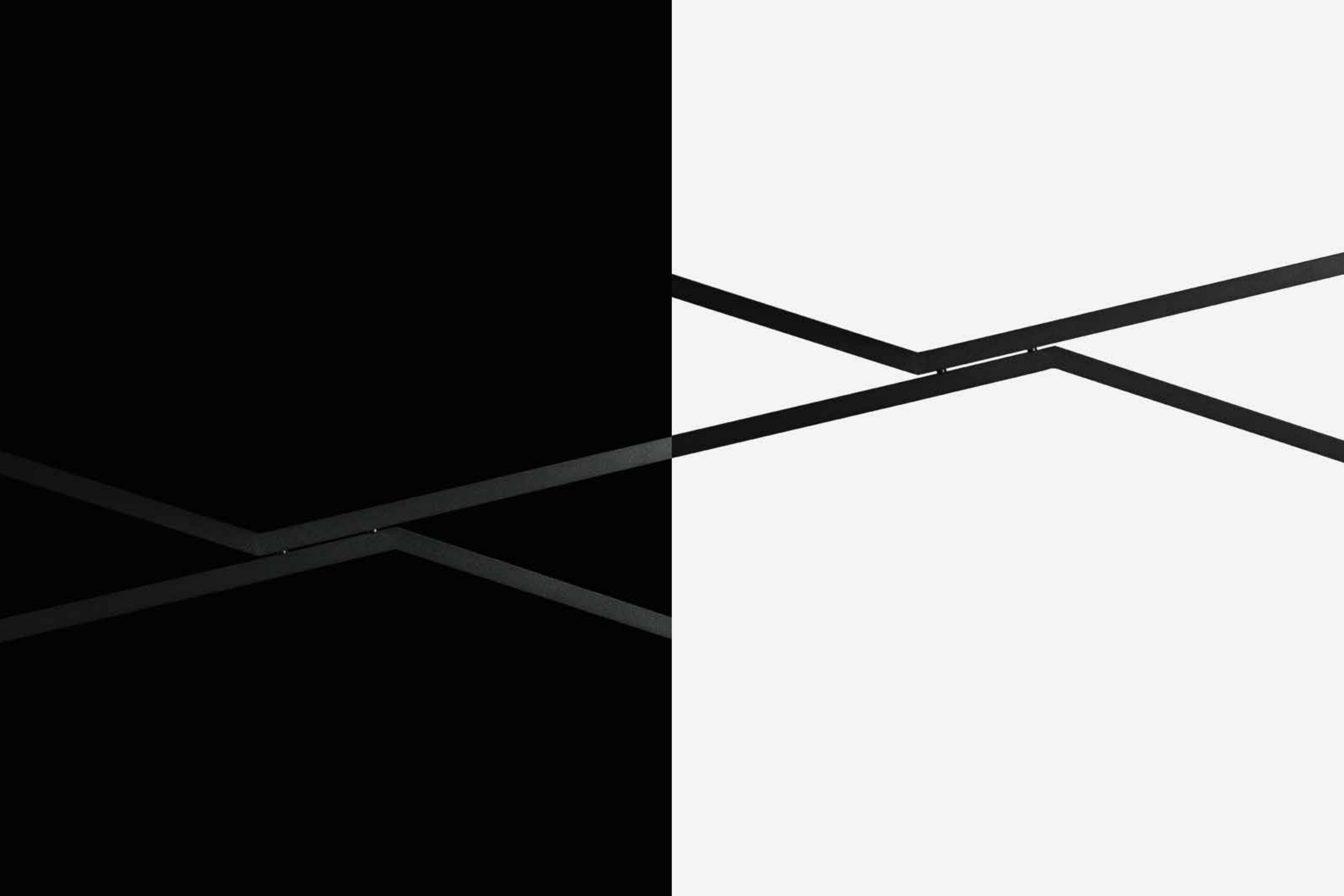

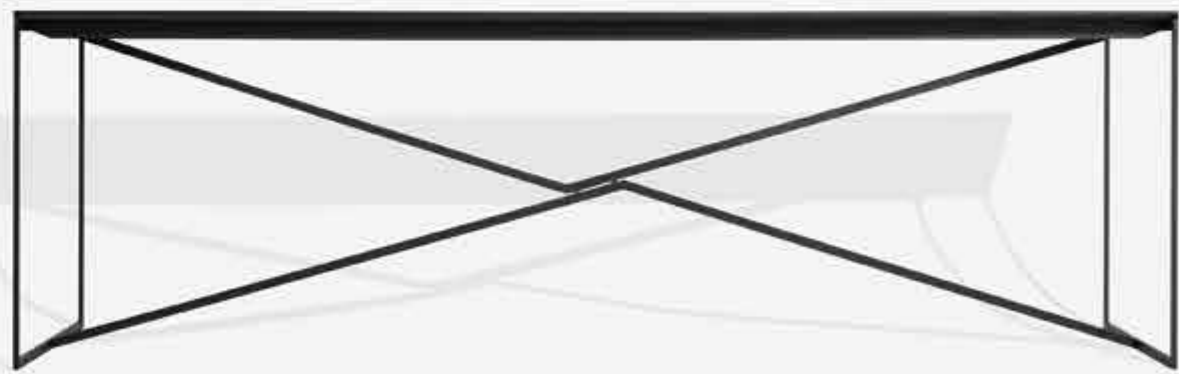

T.T.A. TABLE



**N.E.T.
TABLE**

**NEVER
ENDING
TABLE**

DESIGN BY SØREN ULRIK PETERSEN



“the name derives from our ability to produce tables in important length. Not to mention the never ending dinners, stories, meetings and social gatherings that will create the patina of these pieces”



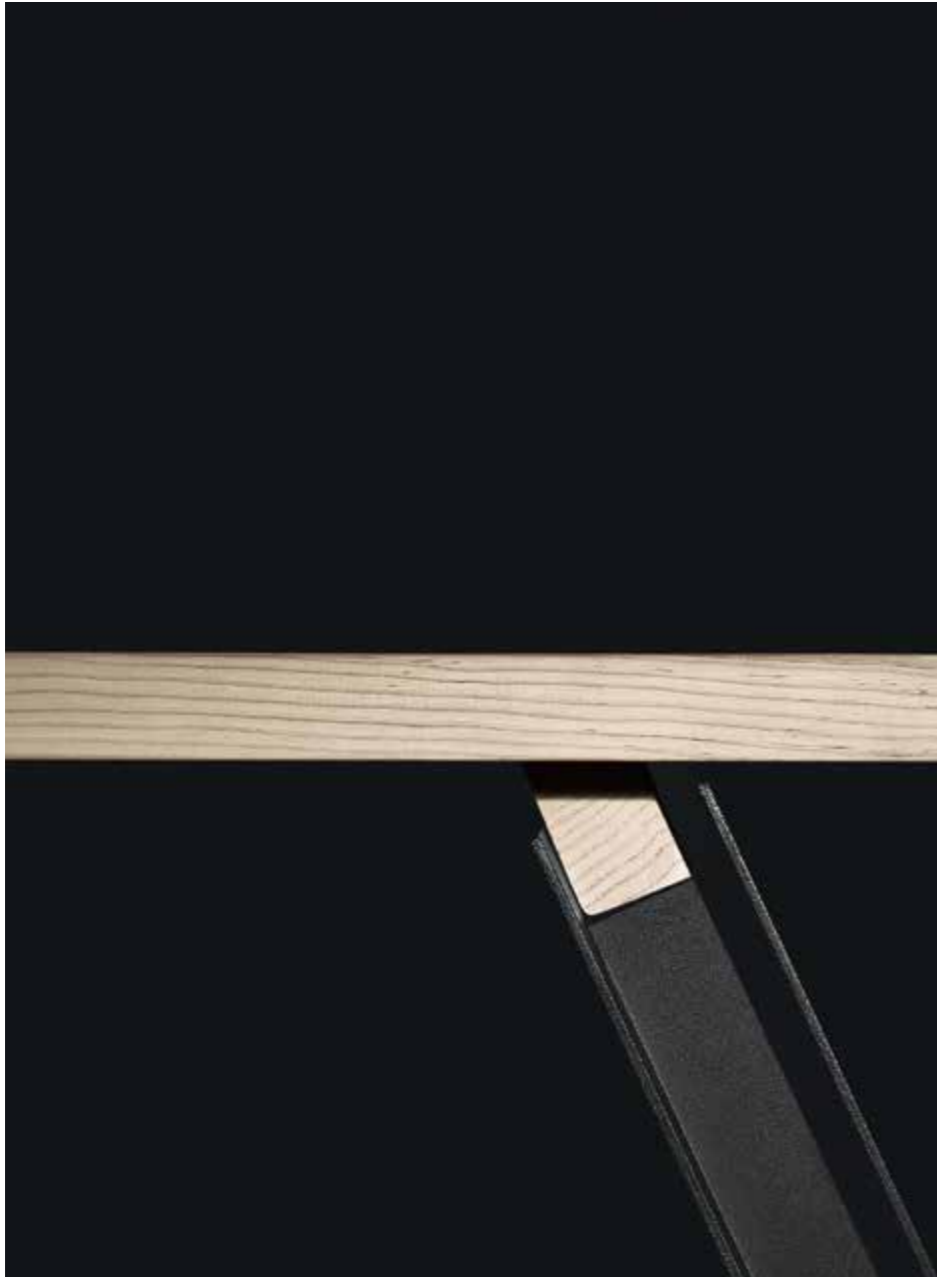

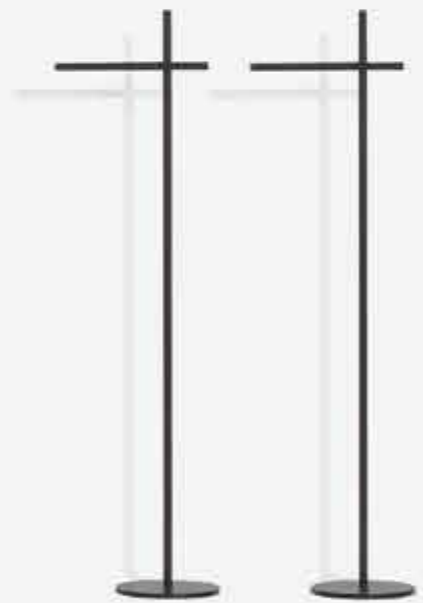

**C.O.P.
STORAGE SYSTEM**

**CREATIVE
OFFICE
PROJECT**

DESIGN BY MIKAL HARRSEN



“with the ‘Creative Office Project’ MA/U Studio has set out to provide new standards for furnishing offices and creative workspaces. The C.O.P. system offers an unmatched flexible storage solution with its concealed rail mounting system”





G.O.P. STORAGE SYSTEM

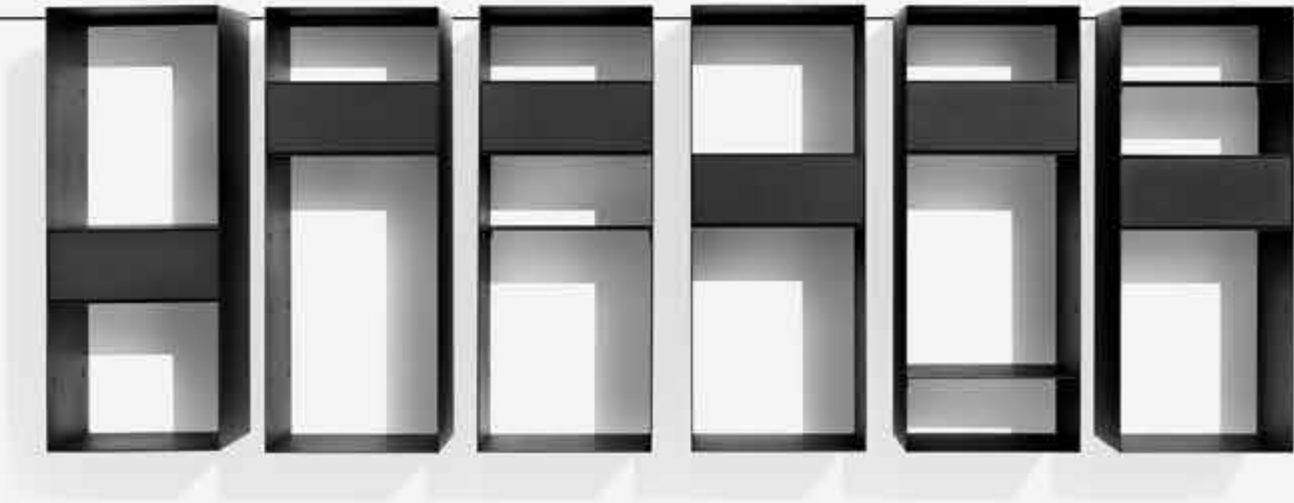

INDEX DE PADOVA COLLECTION

DONZELLETTA M. De Lucchi, 2017 / chair	Pag. 58 59
INCISA V. Magistretti Centro Design Binfaré, 1992 / chair	Pag. 12 13
LC03 M. Van Severen F. Schwaerzler, 2003 / armchair	Pag. 30 31
LLO4 M. Van Severen, 2004 / armchair	Pag. 8 9
MARGHERITA P. Lissoni, 2017 / armchair	Pag. 24 25, 68 69
MOSAÏQUE P. Lissoni, 2017 / pouf	Pag. 18 19
NOTA E. Ossino, 2017 / lamp	Pag. 18 19, 30 31, 58 59, 68 69
SAIL Nendo, 2017 / small table	Pag. 24 25
SEN K. Oshiro, 2016 / small table	Pag. 24 25, 40 41
SILVER V. Magistretti, 1989 / chair	Pag. 12 13, 15
SLEEPING CAR V. Magistretti, 2004 / bed	Pag. 40 41, 70
SO N. Fukasawa, 2017 / chair	Pag. 48 49, 62 63
SQUARE TRADITIONAL, 2017 / sofa	Pag. 24 25
TWIG K. Takeuchi, 2017 / lamps	Pag. 8 9, 62 63

UPDATE 2019

R.I.G. MODULES 402

DESIGN BY MIKAL HARRSEN

INSERT COMPOSITIONS

Pag. IV V
4 modules
L 110

Dimension:
445 x 50 x 41,2 cm

Materials:
Structure - matt black
Cabinets - greystone marble
Top - greystone marble
Shelves - greystone marble



Pag. VIII
2 modules
L 110

Dimension:
223 x 38,4 x 146,4 cm

Materials:
Structure - matt black
Cabinets - Ecowood Xilo 2.0
planked grey (18.23)
Shelves and desk - Ecowood Xilo 2.0
planked grey (18.23)

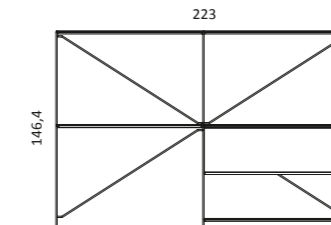

Pag. IV V
5 modules
L 110

Dimension:
556 x 50 x 41,2 cm

Materials:
Structure - matt black
Cabinets - greystone marble
Top - glass
Shelves - greystone marble

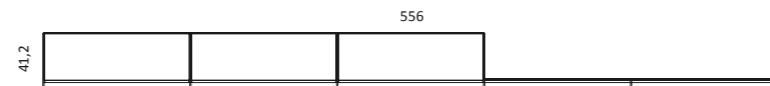

Pag. X XI
3 modules
L 110

Dimension:
334 x 38,4 x 217,2 cm

Materials:
Structure - brass
Shelves - transparent extralight glass

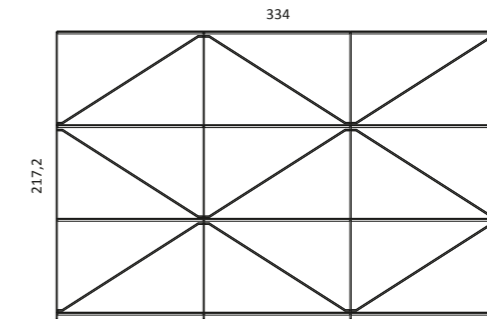

R.I.G. MODULES

DESIGN BY MIKAL HARRSEN

Pag. III
2 modules
L 110

Dimension:
223 x 38,4 x 146,4 cm

Materials:
Structure - matt black
Cabinets - white Carrara marble
Top - glass
Shelves - white Carrara marble

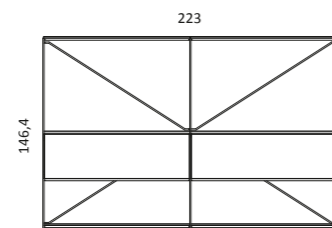

Pag. XII XIII
4 modules
L 110

Dimension:
445 x 38,4 x 217,2 cm

Materials:
Structure - matt black
Cabinets - smoked oak
Shelves - smoked oak

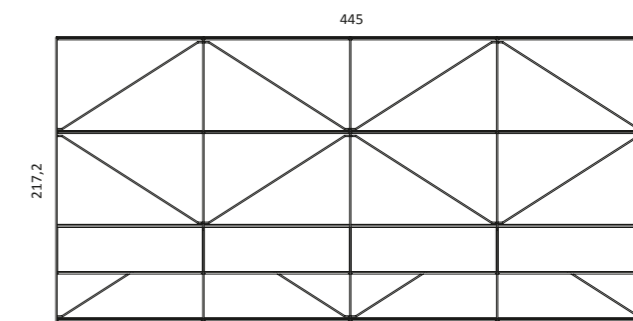

UPDATE 2019

INSERT COMPOSITIONS

Pag. XIV XV
5 modules
L 110

Dimension:
556 x 38,4 x 288 cm
Materials:
Structure - brass
Shelves - transparent extralight glass

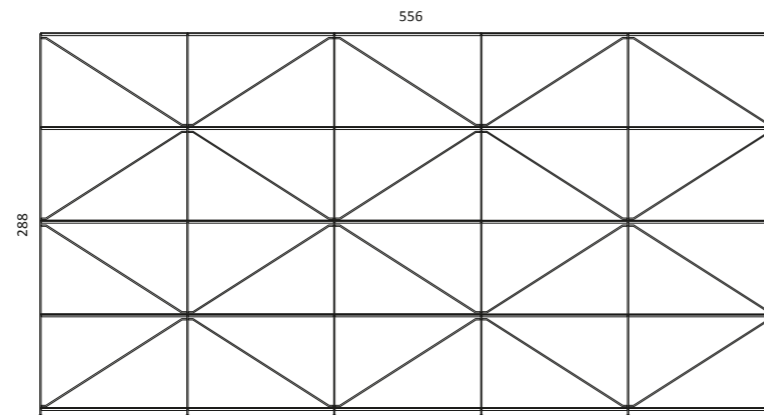

R.I.G. BENCH

DESIGN BY MIKAL HARRSEN & ADAM HALL

Pag. XVII
L 160

Dimension:
160 x 38 x 45,4 cm
Materials:
Frame - matt black
Top - smoked oak

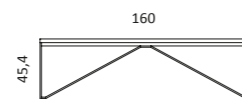

Pag. XVII
L 200

Dimension:
200 x 38 x 45,4 cm
Materials:
Frame - matt black
Top - smoked oak



Tray - leather
Dimension: \varnothing 38 cm

R.I.G. MODULES KITCHEN

DESIGN BY MIKAL HARRSEN

Pag. XXI
2 modules
L 110

Dimension:
278,5 x 38,4 x 217,2 cm
Materials:
Structure - matt black
Cabinets - CDF black
+ Ecowood Xilo 2.0
planked grey (18.23)
Shelves - Ecowood Xilo 2.0
planked grey (18.23)
Accessories - CDF black
+ Ecowood Xilo 2.0
planked grey (18.23)

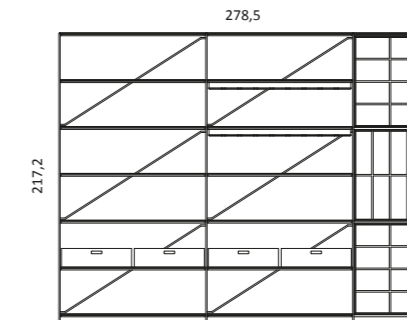

Pag. XXII XXIII
4 modules
L 110

Dimension:
556 x 38,4 x 217,2 cm
Materials:
Structure - matt black
Cabinets - CDF black
+ Ecowood Xilo 2.0
planked grey (18.23)
Top - glass
Shelves - Ecowood Xilo 2.0
planked grey (18.23)
Accessories - CDF black
+ Ecowood Xilo 2.0
planked grey (18.23)

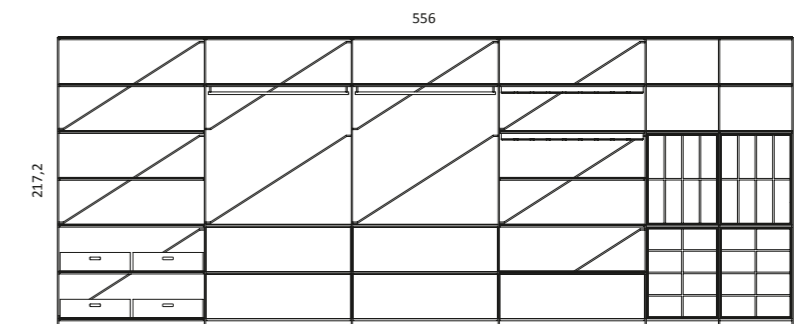

Pag. XXIV XXV
4 modules
L 110

Dimension:
642 x 38,4 x 288 cm
Materials:
Structure - matt black
Cabinets - CDF black
+ Ecowood Xilo 2.0
planked grey (18.23)
Top - glass
Shelves - Ecowood Xilo 2.0
planked grey (18.23)

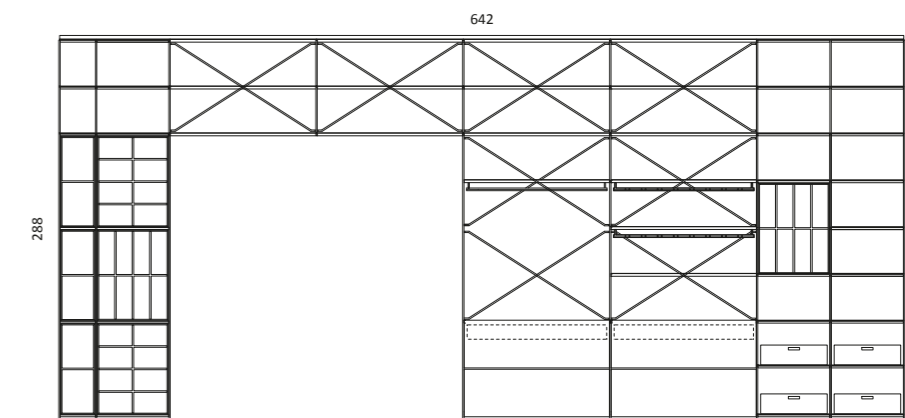

UPDATE 2019

R.I.G. MODULES BATHROOM

DESIGN BY MIKAL HARRSEN

INSERT COMPOSITIONS

Pag. XXIX
1 module
L 55

Dimension:
56,5 x 50 x 86,4 cm

Materials:
Structure - brass
Cabinets - greystone marble
Shelves - greystone marble
Washbasin - greystone marble
+ Garden PVD faucet
Boffi collection

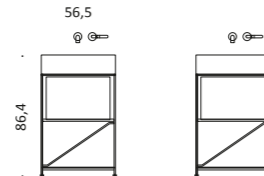

Pag. XXXIV
1 module
L 55

Dimension:
167,5 x 50 x 87,6 cm

Materials:
Structure - matt black
Cabinets - Silcolak ardesia
Shelves - Silcolak ardesia
Top - grey Corian®
Washbasin - grey Corian®
+ Eclipse PVD faucet
Boffi collection

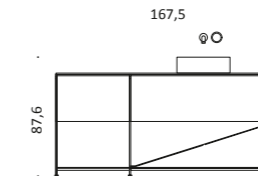

Pag. XXX
1 module
L 110

Dimension:
112 x 50 x 86,4 cm

Materials:
Structure - matt black
Cabinets - Silcolak siberia
Shelves - Silcolak siberia
Washbasin - white Corian®
+ Eclipse PVD faucet
Boffi collection

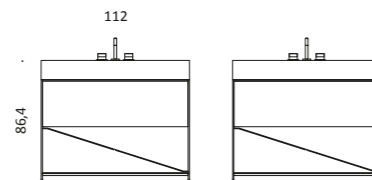

Pag. XXVII
2 modules
L 110

Dimension:
223 x 50 x 86,4 cm

Materials:
Structure - matt black
Cabinet - gris du Marais marble
Shelves - gris du Marais marble
Washbasin - gris du Marais marble
+ Garden PVD faucet
Boffi collection

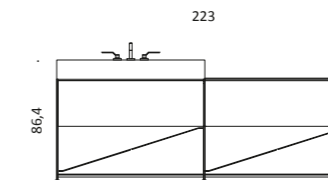

Pag. XXXII
1 module
L 55

Dimension:
167,5 x 50 x 87,6 cm

Materials:
Structure - matt black
Cabinets - smoked oak
Shelves - smoked oak
Top - Lava
Washbasin - Lava
+ Garden PVD faucet
Boffi collection

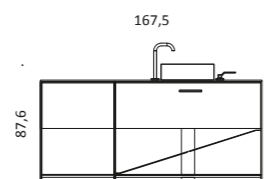

Pag. XXXVII
2 modules
L 110

Dimension:
278,5 x 50 x 87,6 cm

Materials:
Structure - matt black
Cabinets - white Carrara marble
Shelves - white Carrara marble
Top - Cristalplant®
Washbasin - white Carrara marble
+ Eclipse PVD faucet
Boffi collection

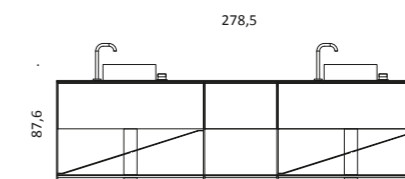

UPDATE 2019

INSERT COMPOSITIONS

Pag. XXXVIII
2 modules
L 110

1 module
L 55

Dimension:
278,5 x 50 x 87,6 cm

Materials:
Structure - matt black
Cabinets - Silcolak siberia
Shelves - Silcolak siberia
Top - grey Corian®
Washbasin - grey Corian®
+ Eclipse PVD faucet
Boffi collection

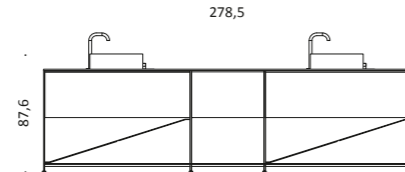

Pag. XLII
3 modules
L 110

Dimension:
334 x 50 x 87,6 cm

Materials:
Structure - matt black
Cabinets - white Carrara marble
Shelves - white Carrara marble
Top - white Carrara marble
Washbasin - white Carrara marble
+ Eclipse PVD faucet
Boffi collection

Glass tray - leather + brass dividers
Dimension: 60 x 28 cm

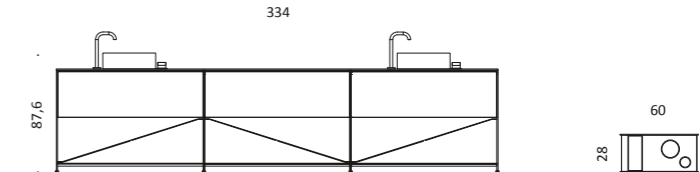

Pag. XXXIX
2 modules
L 110

1 module
L 55

Dimension:
278,5 x 50 x 86,4 cm

Materials:
Structure - matt black
Cabinets - white Carrara marble
Shelves - white Carrara marble
Top - white Corian®
Washbasin - white Carrara marble
+ Eclipse PVD faucet
Boffi collection

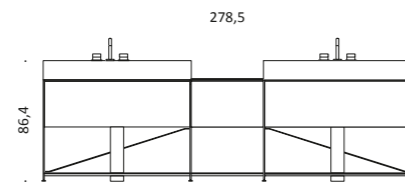

Pag. XLIV
XLV
3 modules
L 110

Dimension:
334 x 50 x 86,4 cm

Materials:
Structure - matt black
Cabinets - smoked oak
Shelves - smoked oak
Top - Pietra d'Avola
Washbasin - Pietra d'Avola
+ Garden PVD faucet
Boffi collection

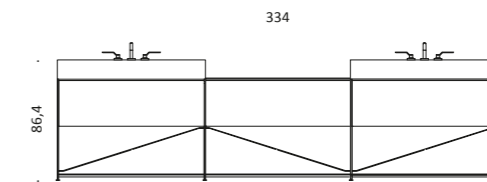

Pag. XLI
2 modules
L 110

1 module
L 55

Dimension:
278,5 x 60 x 86,4 cm

Materials:
Structure - matt black
Cabinet - white Carrara marble
Shelves - white Carrara marble
Top - white Carrara marble
Washbasin - white Carrara marble
+ Eclipse PVD faucet
Boffi collection

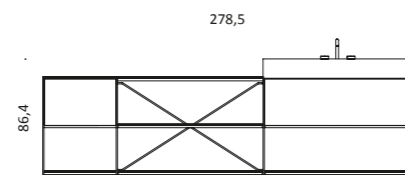

R.I.G. MIRROR

DESIGN BY MIKAL HARRSEN

Pag. XLII
XLV

R.I.G. Wall Mirror
Dimension:
140 x 4 x 140 cm

Materials:
Structure - matt black + mirror
matt black + mirror with LED lightbar

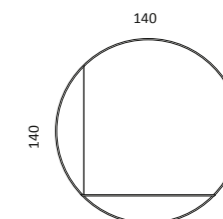
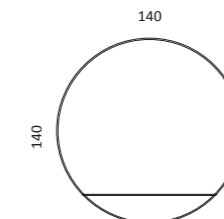

UPDATE 2019

INSERT COMPOSITIONS

Pag. XXIX

R.I.G. Wall Mirror
Dimension:
56,5 x 4 x 131 cm
Materials:
Structure - matt black
+ mirror with LED lightbar

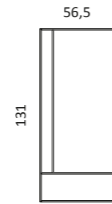

Pag. XXXVII

R.I.G. Wall Mirror
Dimension:
65 x 4 x 217,2 cm
Materials:
Structure - matt black
+ mirror with LED lightbar

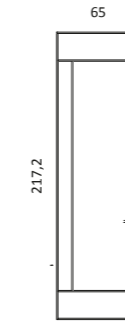

Pag. XXX

R.I.G. Wall Mirror
Dimension:
112 x 4 x 131 cm
Materials:
Structure - matt black
+ mirror with LED lightbar

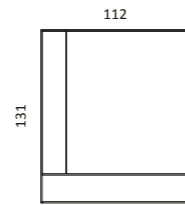

Pag. XXXIX

R.I.G. Wall Mirror
Dimension:
112 x 4 x 217,2 cm
Materials:
Structure - matt black
+ mirror with LED lightbar

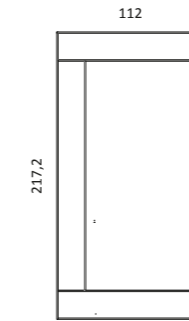

Pag. XXXIV

R.I.G. Wall Mirror
Dimension:
167,5 x 4 x 131 cm
Materials:
Structure - matt black
+ mirror with LED lightbar

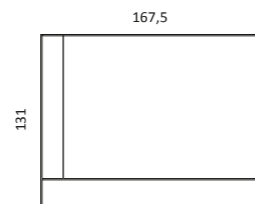

Pag. XXXII

R.I.G. Freestanding Mirror
Dimension:
115,6 x 98,2 x 182 cm
Materials:
Structure - matt black + mirror

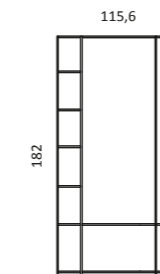

UPDATE 2019

R.I.G. MODULES WARDROBE

DESIGN BY MIKAL HARRSEN

INSERT COMPOSITIONS

Pag. L
2 modules
L 110

Dimension:
223 x 60 x 289 cm

Materials:
Structure - matt black
Shelves - CDF black + smoked oak
+ transparent extralight glass

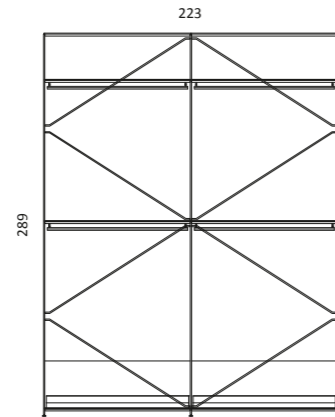

Pag. LI
5 modules
L 110

Dimension:
223 x 60 x 289 cm

Materials:
Structure - matt black
Shelves - CDF black + smoked oak

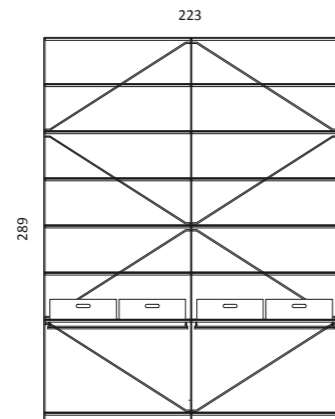

Pag. LII
2 modules
L 110

1 module
L 55

Dimension:
287,5 x 60 x 289 cm

Materials:
Structure - matt black
Shelves - Ecowood Xilo 2.0
planked sand (18.22)
Top - glass
Cabinets - Ecowood Xilo 2.0
planked sand (18.22)

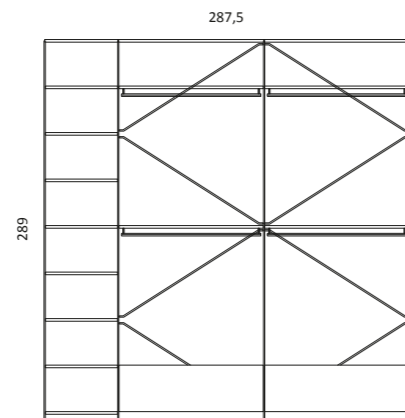

Pag. LVI
LVII
4 modules
L 110

Dimension:
445 x 60 x 289 cm

Materials:
Structure - matt black
Shelves - Ecowood Xilo 2.0
planked sand (18.22)
Cabinets - Ecowood Xilo 2.0
planked sand (18.22)
Back panel - mirror frame

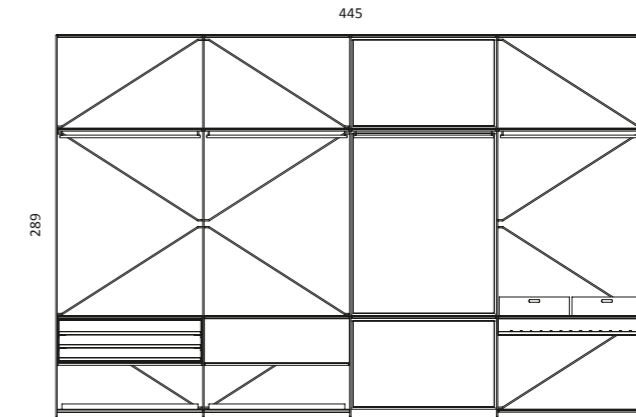

Pag. LVIII
LIX
4 modules
L 110

Dimension:
445 x 38 x 289 cm

Materials:
Structure - brass
Shelves - CDF black
+ transparent extralight glass

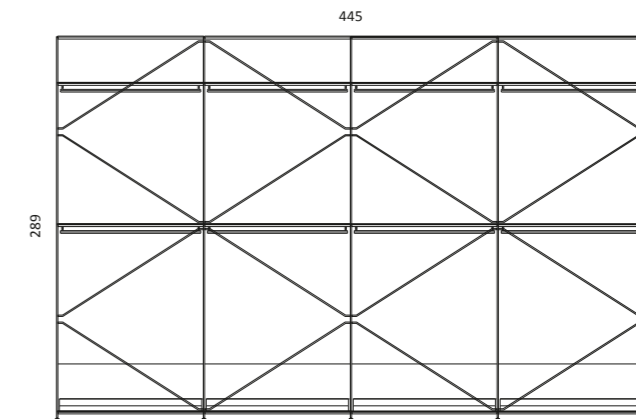

R.I.G. MODULES

DESIGN BY MIKAL HARRSEN

CATALOGUE COMPOSITIONS

Pag. 16
1 module
L 110
Dimension: 112 x 38,4 x 218,8 cm
Materials:
Structure - matt black
Shelves - white Carrara marble

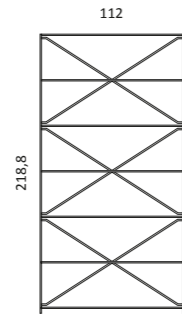

Pag. 20
3 modules
L 110
Dimension: 334 x 38,4 x 77,2 cm
Materials:
Structure - matt black
Shelves - greystone marble

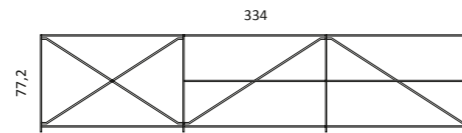

Pag. 28
3 modules
L 110
Dimension: 334 x 38,4 x 218,8 cm
Materials:
Structure - matt black
Shelves - CDF black

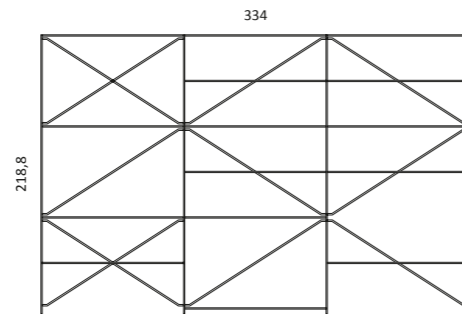

Pag. 8 9
4 modules
L 110
Dimension: 445 x 38,4 x 218,8 cm
Materials:
Structure - matt black
Shelves - CDF black

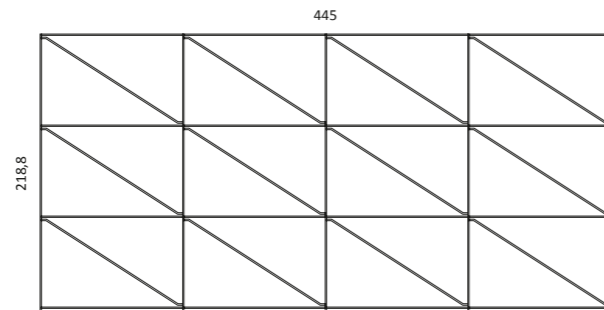

Pag. 18 19
5 modules
L 110
Dimension: 556 x 38,4 x 77,2 cm
Materials:
Structure - matt black
Shelves - greystone marble

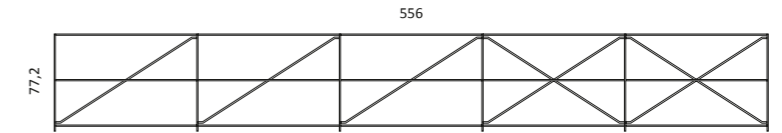

Pag. 24 25
5 modules
L 110
Dimension: 556 x 38,4 x 218,8 cm
Materials:
Structure - matt black
Shelves - white Carrara marble

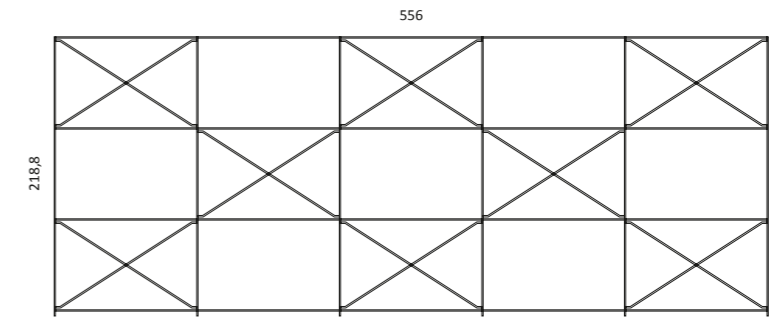

Pag. 30 31
5 modules
L 110
Dimension: 556 x 38,4 x 289 cm
Materials:
Structure - matt black
Shelves - CDF black

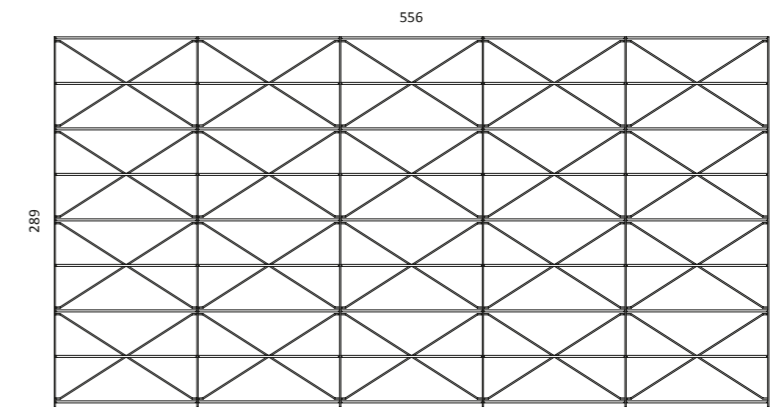

Pag. 12 13
6 modules
L 110
Dimension: 667 x 38,4 x 218,8 cm
Materials:
Structure - white
Shelves - white MDF

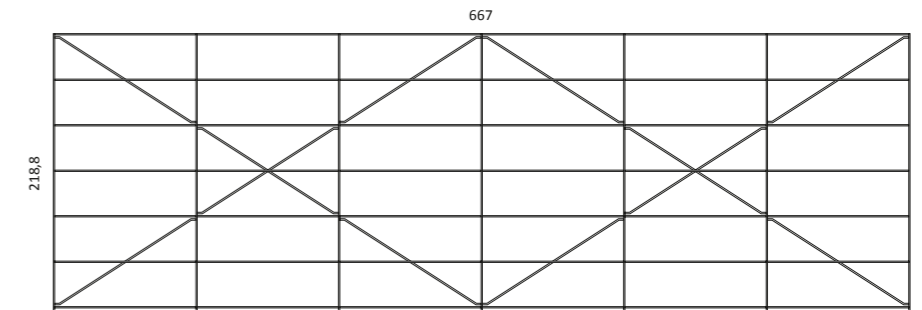

R.I.G. MODULES OTHER COMPOSITIONS

1 module
L 110
Dimension:
112 x 38,4 x 76,6 cm
Materials:
Structure - white
Shelves - white MDF

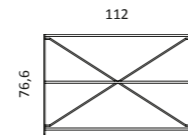
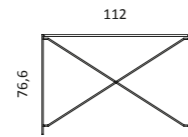

1 module
L 110
Dimension:
112 x 38,4 x 76,6 cm
Materials:
Structure - white
Shelves - white MDF

1 module
L 110
Dimension:
112 x 38,4 x 76,6 cm
Materials:
Structure - matt black
Shelves - CDF black

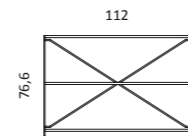
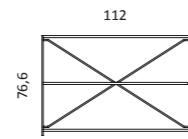

1 module
L 110
Dimension:
112 x 38,4 x 76,6 cm
Materials:
Structure - matt black
Shelves - glass



R.I.G. MODULES OTHER COMPOSITIONS

2 modules
L 110
Dimension:
223 x 38,4 x 76,6 cm
Materials:
Structure - white
Shelves - white MDF

2 modules
L 110
Dimension:
223 x 38,4 x 76,6 cm
Materials:
Structure - white
Shelves - white MDF

2 modules
L 110
Dimension:
223 x 38,4 x 76,6 cm
Materials:
Structure - white
Shelves - CDF natural oak

2 modules
L 110
Dimension:
223 x 38,4 x 76,6 cm
Materials:
Structure - matt black
Shelves - CDF natural oak

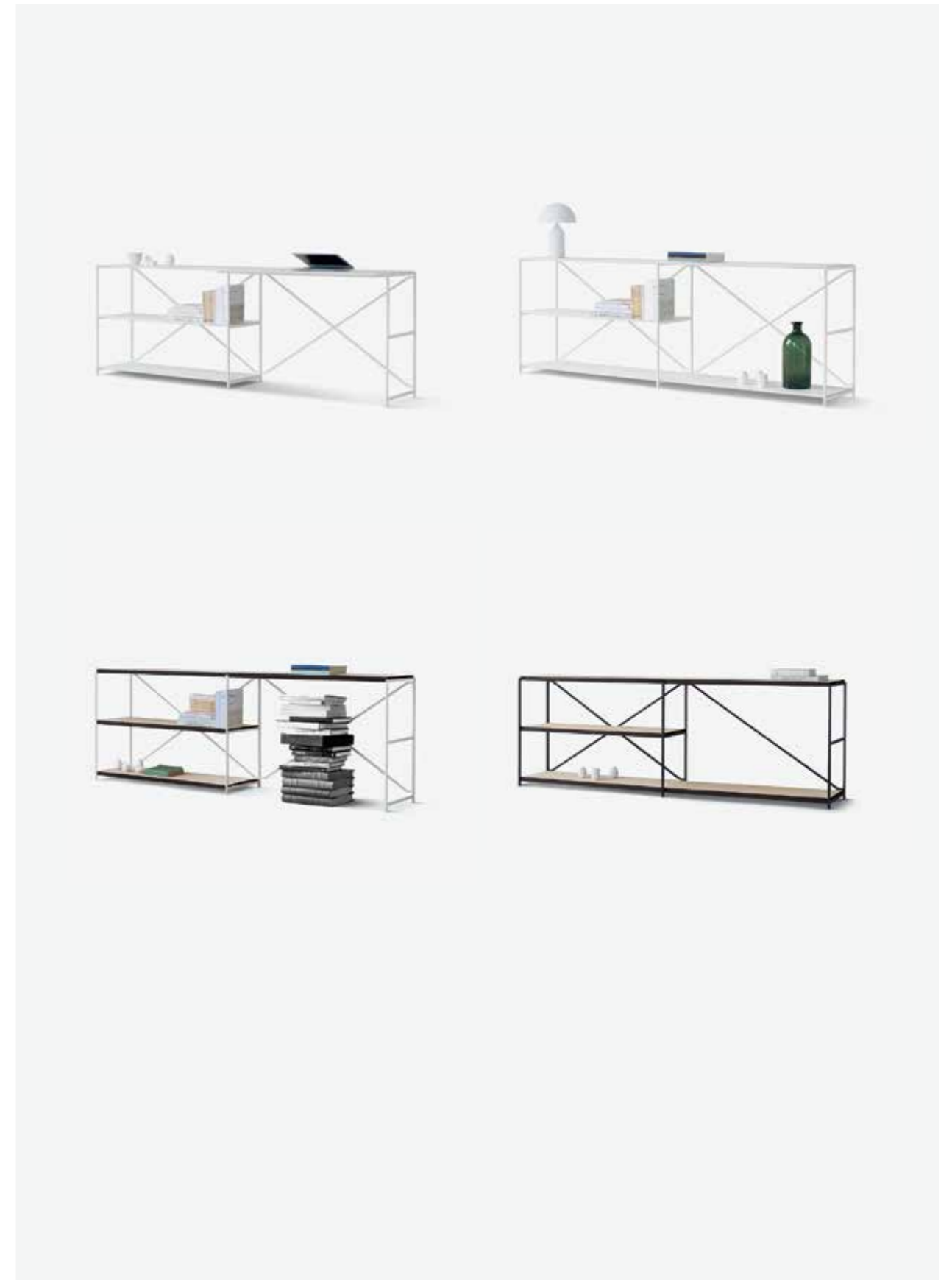
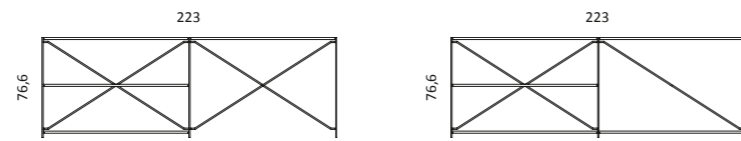
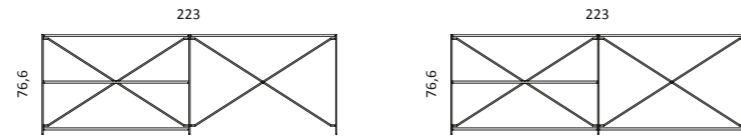

R.I.G. MODULES OTHER COMPOSITIONS

1 module
L 110
Dimension:
112 x 38,4 x 218,2 cm
Materials:
Structure - white
Shelves - white MDF

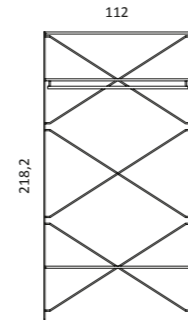
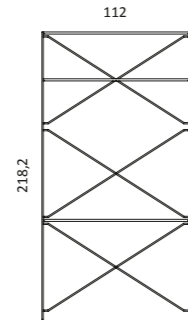

1 module
L 110
Dimension:
112 x 38,4 x 218,2 cm
Materials:
Structure - white
Shelves - white MDF

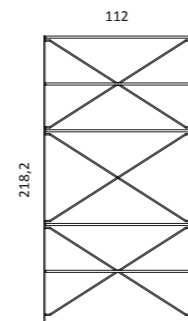
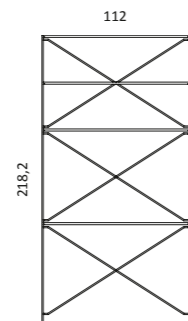

1 module
L 110
Dimension:
112 x 38,4 x 218,2 cm
Materials:
Structure - white
Shelves - CDF natural oak

1 module
L 110
Dimension:
112 x 38,4 x 218,2 cm
Materials:
Structure - white
Shelves - white MDF

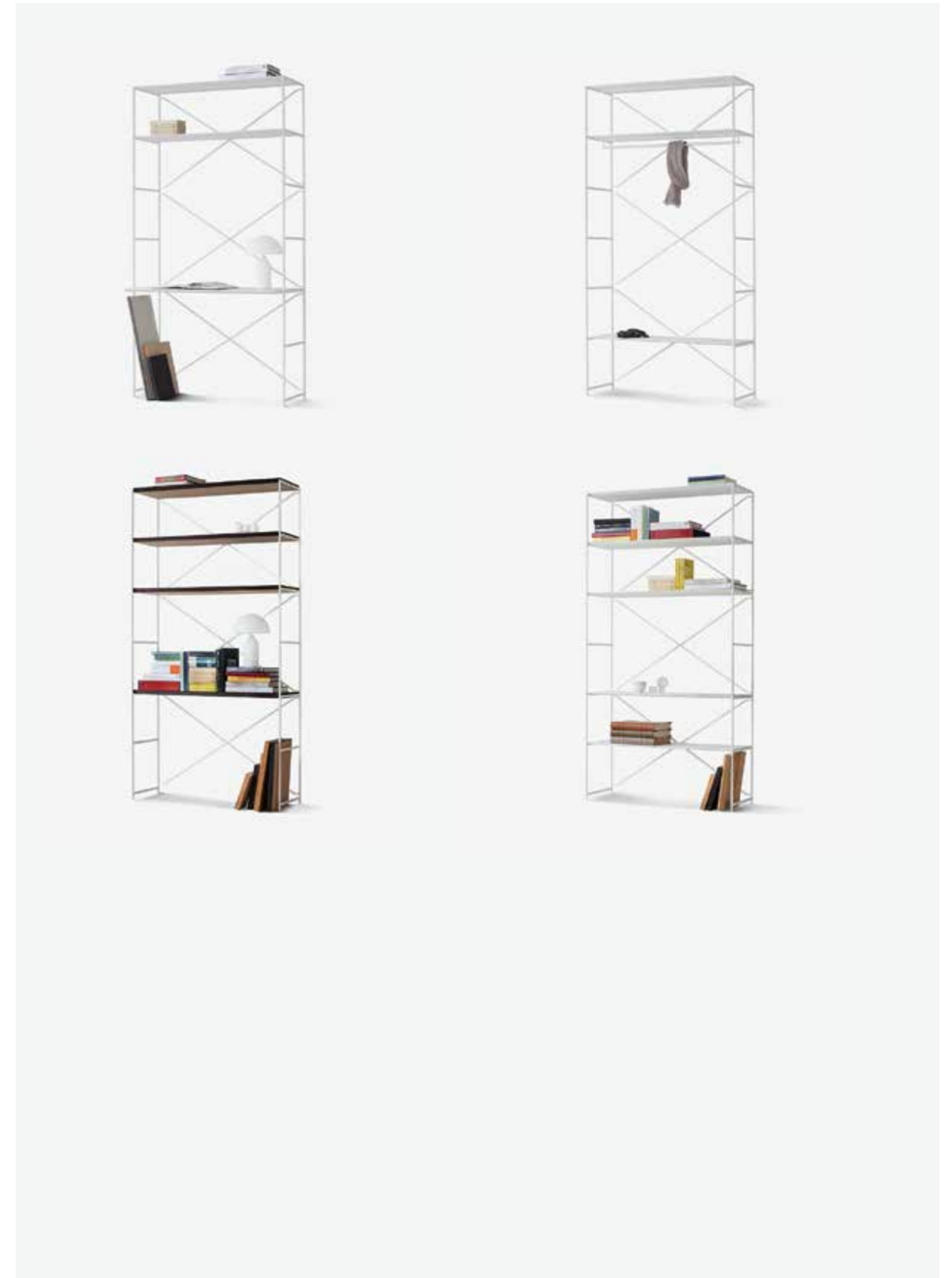

R.I.G. MODULES OTHER COMPOSITIONS

1 module
L 110

Dimension:
112 x 38,4 x 218,2 cm
Materials:
Structure - matt black
Shelves - CDF black

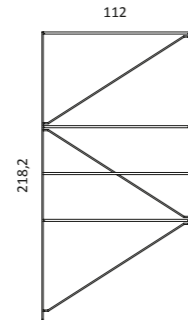

2 modules
L 110

Dimension:
223 x 38,4 x 218,2 cm
Materials:
Structure - matt black
Shelves - CDF black

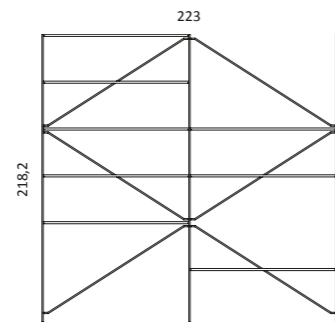

3 modules
L 110

Dimension:
334 x 38,4 x 218,2 cm
Materials:
Structure - matt black
Shelves - CDF black + glass

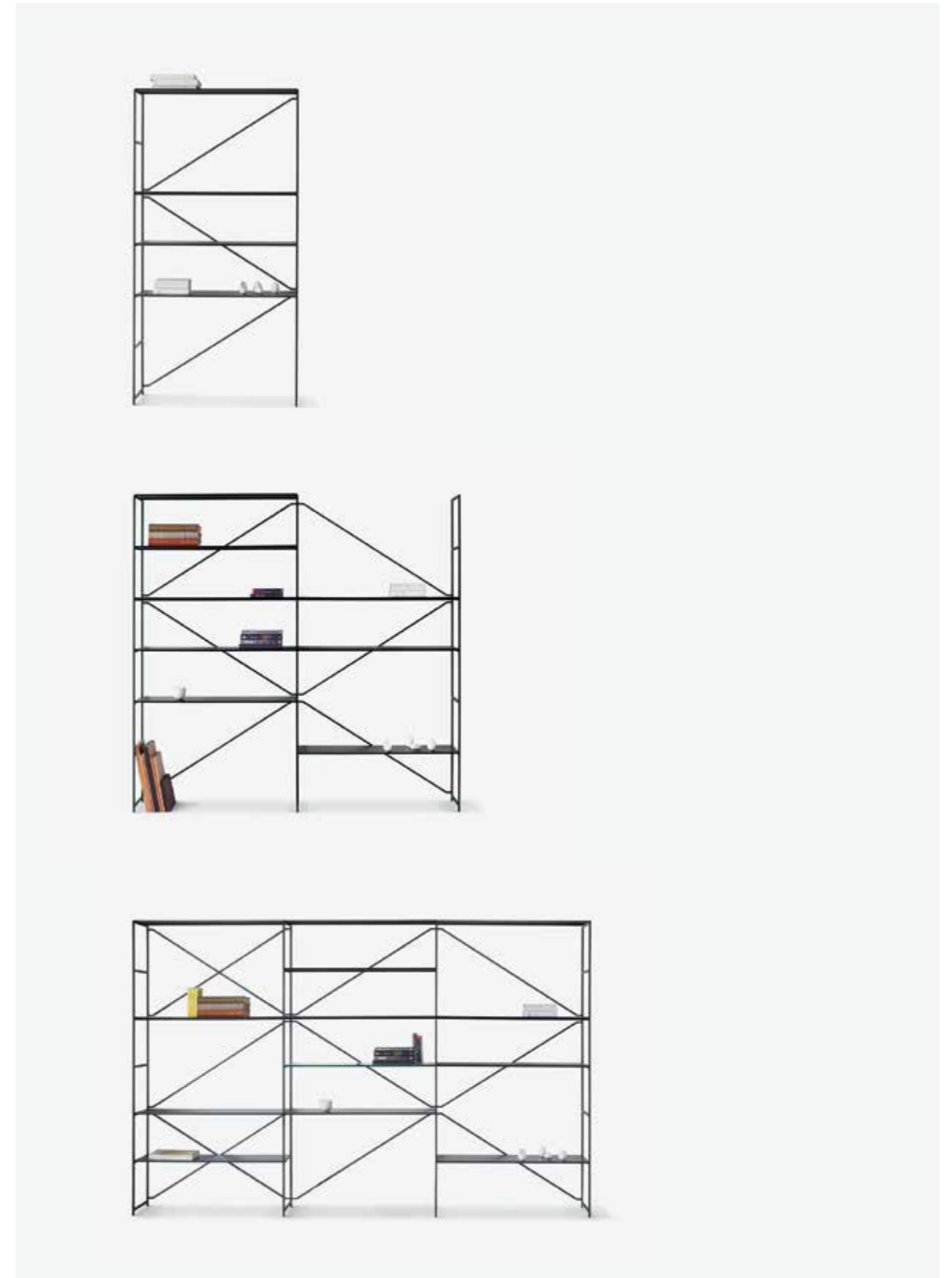
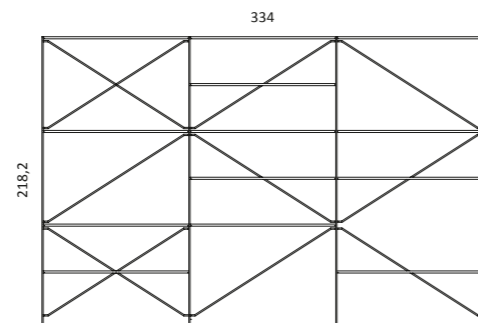

R.I.G. MODULES OTHER COMPOSITIONS

2 modules
L 110

Dimension:
223 x 38,4 x 218,2 cm
Materials:
Structure - white
Shelves - white MDF

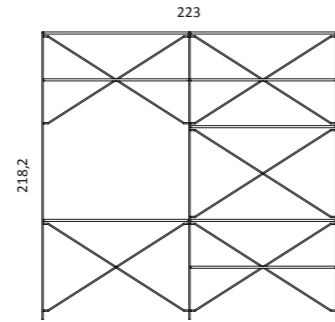

2 modules
L 110

Dimension:
223 x 38,4 x 218,2 cm
Materials:
Structure - white
Shelves - white MDF

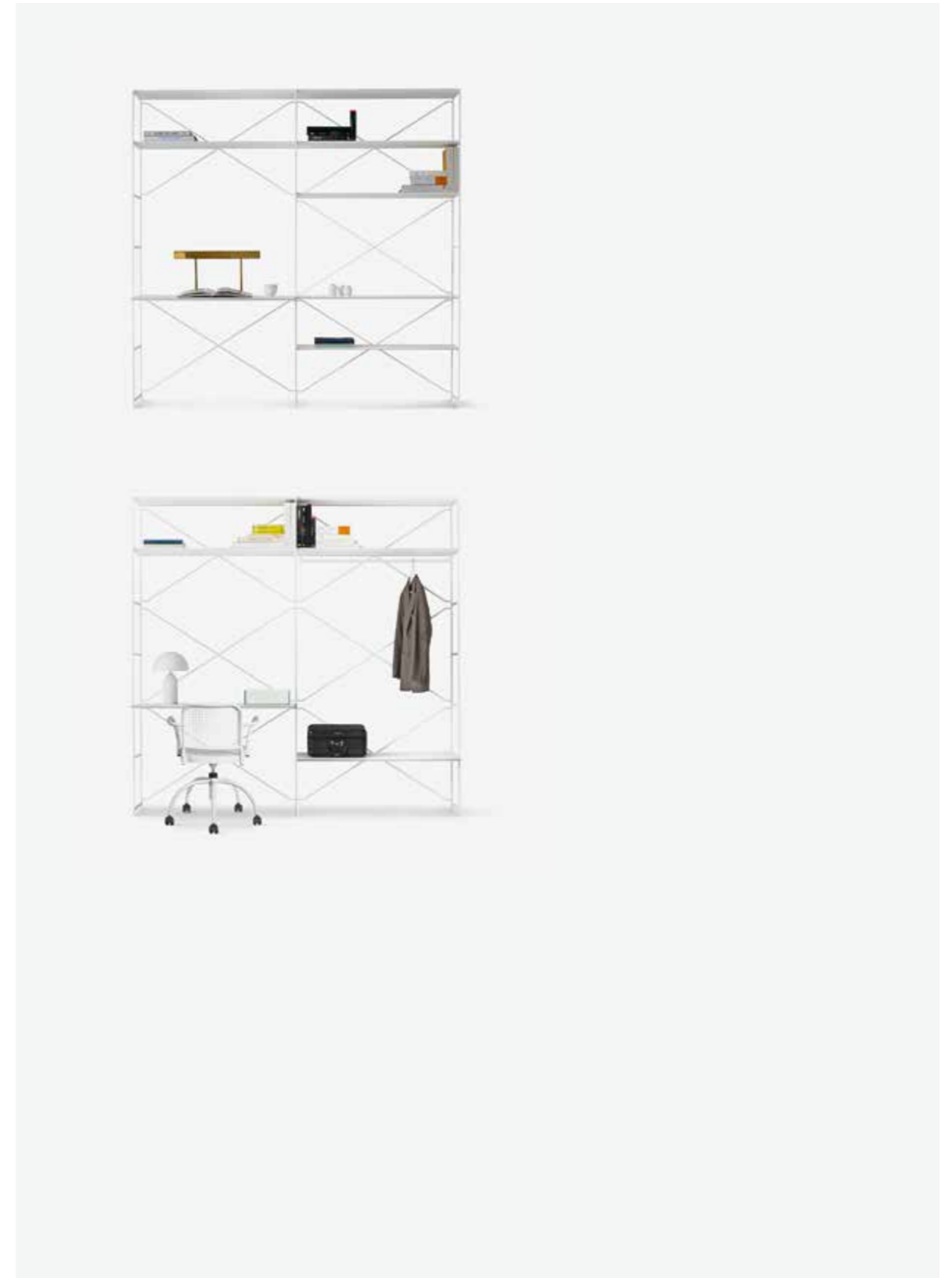
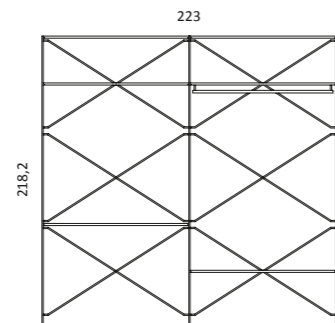

R.I.G. BENCH

DESIGN BY MIKAL HARRSEN & ADAM HALL

Image on the right
Dimension: 200 x 38 x 45,4 cm
Materials:
Frame - matt black
Top - smoked oak

Pag. 38
L 200
All dimensions:
160 x 38 x 45,4 cm
200 x 38 x 45,4 cm

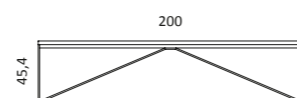
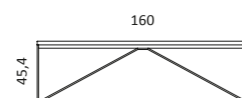

R.I.G. TABLE

DESIGN BY MIKAL HARRSEN

Image on the right
Dimension: 200 x 80 x 71,5 cm
Materials:
Frame - matt black
Top - CDF black

All dimensions:
140 x 80 x 71,5 cm
160 x 80 x 71,5 cm
180 x 80 x 71,5 cm
200 x 80 x 71,5 cm

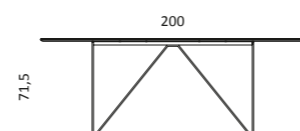
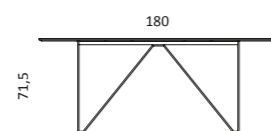
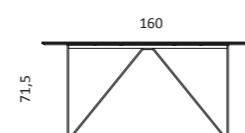
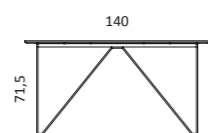

T.T.A. TABLE

DESIGN BY MIKAL HARRSEN

Pag. 48 49
L 340
Dimension:
180 x 90 x 72 cm
240 x 90 x 72 cm
280 x 90 x 72 cm
340 x 90 x 72 cm
Materials:
Frame - matt black
Top - CDF black

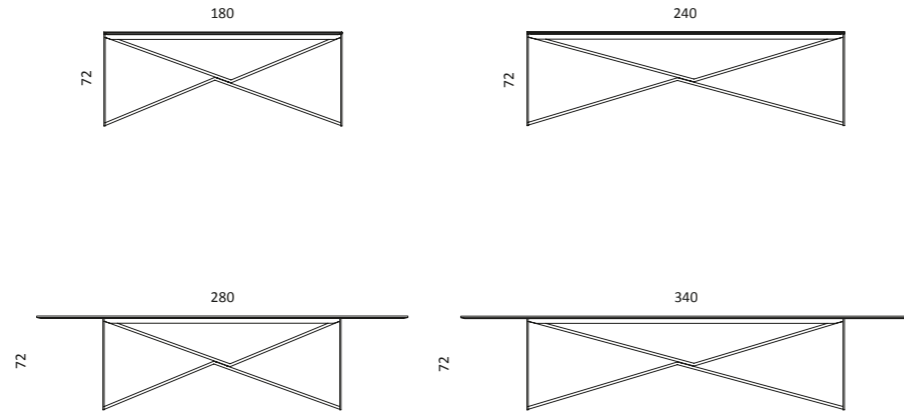

C.O.P. STORAGE SYSTEM

DESIGN BY MIKAL HARRSEN

Pag. 68 69
Dimension:
26 x 32 x 66,6 cm
Materials:
black coated steel sheet

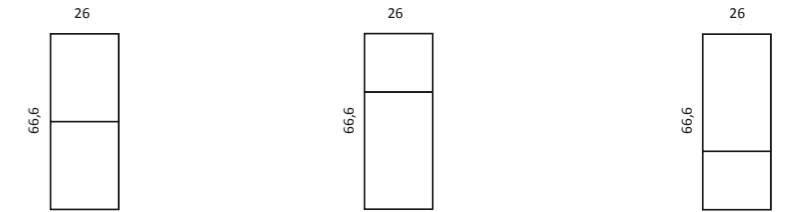

N.E.T. TABLE

DESIGN BY SØREN ULRIK PETERSEN

Pag. 58 59
400 cm
Dimension:
400 x 90 x 74 cm
600 x 90 x 74 cm
Materials:
Trestle - matt black
Top - bleached douglas wood

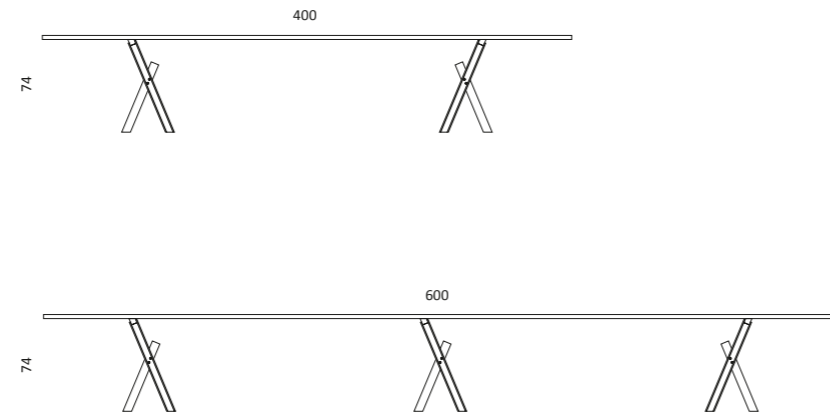

CREDITS

Graphic project / Graph.X

Photo / Tommaso Sartori

Styling / Elisa Ossino Studio

Rendering / Virtual Design

Retouching, Pre Press / A. DePedrini

Printed in Italy

by Grafiche Mariano 2019

THANKS TO

Altai

Arte nel pozzo

Bitossi

Bloc Studios

C&C

Casa Filosofia

Flos

Guido De Zan

Mani

Romina Gris

Young Ran Lee

SPECIAL AGREEMENT

Salvatori

MA/U STUDIO

via Santa Cecilia, 7

20122 Milano, Italy

T. +39 02 27439769

contact@maustudio.net

www.maustudio.net

