

# OWNER'S MANUAL



## Gourmet Series Marine Gas Grill Model A10-1225



For questions regarding performance, assembly, operation, parts, or returns, contact the experts at MAGMA by calling TOLL FREE IN U.S.A. AND CANADA **1-800-86-MAGMA**

7:00 a.m. - 5:00 p.m. Pacific Time Monday thru Friday or e-mail us at [mail@MagmaProducts.com](mailto:mail@MagmaProducts.com)



Read all instructions before operating. Save manual for future reference.

## IMPORTANT SAFETY WARNINGS

### READ ALL INSTRUCTIONS BEFORE OPERATING.

- USE OUTDOORS ONLY.
- DO NOT USE THIS APPLIANCE INSIDE THE BOAT OR ANY ENCLOSED SPACE.
- GRILLS RADIATE HEAT. CLEARANCE FROM COMBUSTIBLES, 24" SIDES AND BACK. NEVER USE UNDER AWNINGS, PATIO COVERS, ETC.
- USE PROPANE GAS ONLY. FUEL STORAGE SHOULD BE IN COMPLIANCE WITH THE AMERICAN BOAT AND YACHT COUNCIL (ABYC) STANDARDS A-1 (9), MARINE LIQUIFIED PETROLEUM GAS (LPG) SYSTEMS.
- FOR NATURAL GAS APPLICATION CONTACT MAGMA.
- ALWAYS LIGHT GRILL WITH LID OPEN.
- NEVER LEAVE HOT GRILL UNATTENDED.
- USE HOT PAD WHEN HANDLING.
- ALWAYS TURN GRILL OFF AFTER USE.

Each Magma® Gas Grill is individually fire tested before it leaves the factory. For this reason, the burner on your grill may be slightly discolored.

## INSTALLATION INSTRUCTIONS

### CONTROL VALVE REGULATOR

- Uses standard 1-lb. disposable propane canisters (DOT-39 NRC).
- Prior to installing valve, become familiar with the valve function and graphics on valve knob. Never force the knob. Always turn or push gently.
- Turn control valve to "lock"  and install gas canister being careful not to cross the threads. Check for leaks prior to use.
- Position valve with gas bottle as shown **(A)**. Gently insert valve stem into valve chamber while rotating until valve stem key aligns with valve chamber lock detent allowing valve to fully insert. Rotate gas canister down and away so knob faces you **(B)** or straight up **(C)** depending on application.

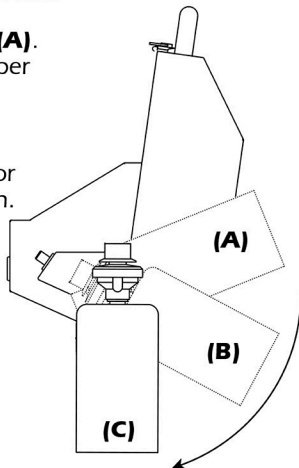

## MOUNT HARDWARE

Fasteners are supplied for both Single Mount and Dual Mount grill mounting options. See Magma Catalog or Website for best mount selection.

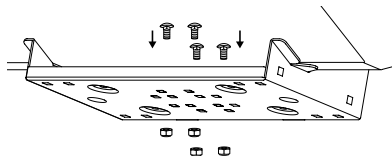

### Single mount through-bolt applications

4 Carriage bolts & lock nuts.

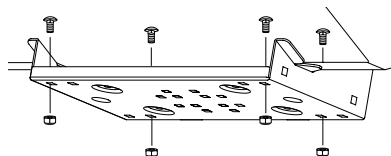

### Dual mount applications

4 Carriage bolts & lock nuts. Only 4 bolts required for grill mounting. Place bolts (2 per side) diagonally from each other as shown.

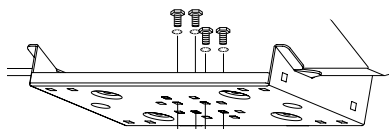

### Single mount non-through-bolt applications, including Style 1 "Levelock"

4 Hex head bolts & lock washers.



Carriage bolt & lock nut

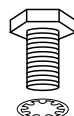

Hex head bolt & lock washer

## ON-BOARD FUEL SYSTEMS APPLICATION

- For on-board LPG (Propane) Systems, use Magma Type 3-High Output-Low Pressure LPG Control Valve and Magma Low Pressure LPG Hose Kit.
- For on-board CNG (Natural Gas) Systems, use Magma Type 4-High Output-Low Pressure Natural Gas Control Valve.

See Magma website for replacement part numbers and valve applications.  
[www.MagmaProducts.com](http://www.MagmaProducts.com)

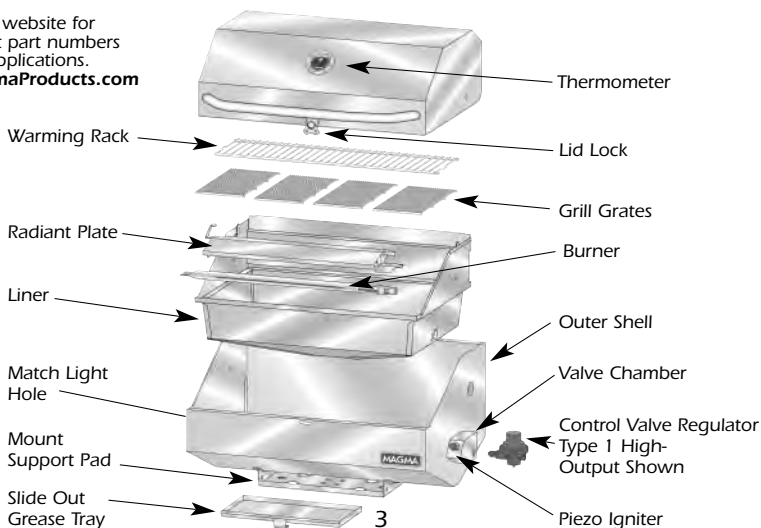

# OPERATING PROCEDURES

**OPERATE ONLY ON "LOW" WHEN LID IS CLOSED.  
ALWAYS OPERATE WITH GREASE TRAY IN PLACE.**

**WARNING:** Do not overheat grill. Magma Grills do not require pre-heating. Stainless Steel loses anti-corrosive characteristics when subjected to extreme heat. Most grilling is done on low temperature with the lid closed. If medium or high heat is required, grill with lid open.

## LIGHTING INSTRUCTIONS

- Open lid during lighting.
- Depress knob and rotate counter-clockwise to the "HIGH" flame  position.
- Push Piezo Igniter.
- Visually confirm ignition through match light hole.
- Turn knob to adjust flame.
- If grill does not light, repeat process.

## MATCH LIGHTING INSTRUCTIONS

- Open lid during lighting.
- Depress knob and rotate counter-clockwise to the "HIGH" flame  position.
- Hold match or gas flame long lighter up to the match light hole.
- Visually confirm ignition through match light hole.

## TO REDUCE FLARE-UP

- Empty and clean grease tray prior to each use.
- Trim excess fats from meat.
- Use non-oil based marinades.
- Reduce heat.
- Use water spray directly on flare-ups.

**NOTE:** Before lighting, lid lock must be positioned not to engage. Open lid and turn lock to locked position, or bring lock latch up to handle in open position and flip lock actuator back onto handle.

## PRACTICAL HINTS:

Before lighting your grill, be sure that ...

- Grill is secure and properly mounted.
- Internal components and grease tray are clean and correctly positioned.
- You have plenty of gas in the canister.
- Gas canister is attached properly and there are no gas leaks.
- Lid lock has been set not to engage.
- You have a water spray bottle handy to cool a hot grill or stop any flare-ups.

## STOWING TIPS

- Always disconnect the fuel canister from the valve prior to stowing.
- Stow the valve in a clean, dry area to protect from corrosion to valve.
- Always store propane in a sealed propane storage locker that allows leakage to vent overboard or use **Magma A10-210 Propane Storage Tote**.  
Never stow below decks



## ELECTRODE SPARK ADJUSTMENT

CAUTION: Spark can cause small shock. Do not leave fingers on or near electrode wire while engaging igniter.

- Electrode wire should be approximately 1/8" from gas exit hole in burner. Carefully adjust wire if required.

## DISASSEMBLY & RE-ASSEMBLY

- Lift radiant plate up & out of left slot (see B) and remove by sliding it out of right slot (see C).
- Remove burner screw (see B) and remove burner. Check burner for grease residue or spider webs that may obstruct gas flow. CAUTION: WHEN REPLACING BURNER, CUT SLOT IN BURNER MUST FACE DOWN.
- To remove liner from outer shell you must disconnect the electrode wire (see D). First remove the two screws on valve chamber (see D) and remove the cover plate. Gently pull wire off connector (see D). It is not necessary to remove electrode from liner.
- Remove Lid and liner by removing hinge screws and lock nuts with 3/16" hex key wrench (supplied) and 1/2" wrench or pliers. CAUTION: LOCK NUTS MUST BE INSTALLED WITH LOCKING INDENT MARKS SHOWING (see E). IMPROPER INSTALLATION WILL DAMAGE THE HINGE SCREW AND LOCK NUT.
- Lift liner out of outer shell by lifting up on liner lip on back side of liner (see F). When replacing liner, be sure top lip of liner installs over top edge of outer shell (start with corners of lip and work in).
- Inspect burner, remove any obstructions.
- Clean as indicated in Maintenance (page 6).
- To re-assemble, reverse the procedure.

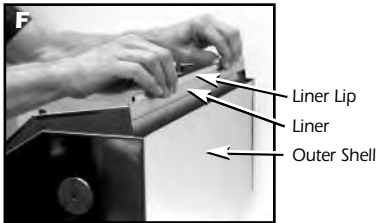
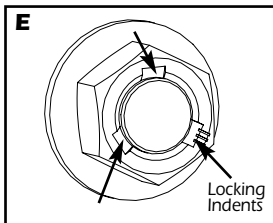
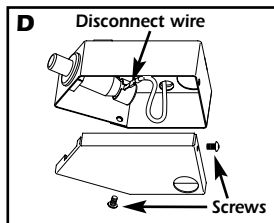
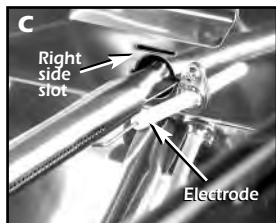
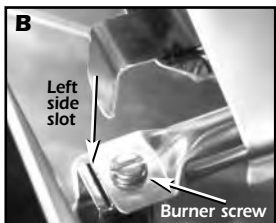

## MAINTENANCE

Stainless Steel, contrary to popular belief, can rust. Most commonly, deposits on the surface of the product will trap moisture. It is this moisture that robs the stainless steel of oxygen. Oxygen is the element that reacts with the stainless steel to form a protective layer of chrome oxide. Robbed of oxygen this reaction does not take place and “crevice corrosion”, or “surface rusting”, occurs. To minimize this effect, thoroughly clean your grill with soap and water, rinse with fresh water and dry. Avoid using products designed to clean stainless steel as most leave a residue that may discolor when the grill is heated.

Additionally, stainless steel that is exposed to high heat will change in color and texture over time. This “bluing” and later “browning” of the internal components is not a failure of the stainless steel and will not affect the product operation. However, prolonged exposure to extreme high heat will cause the chromium and nickel to “burn out” of the stainless steel. At this point the stainless steel will become more susceptible to corrosion and will start to deteriorate. We recommend that you replace these internal components if they become seriously deteriorated.

We recommend thorough cleaning of all internal parts after each outing. It is important to disassemble the interior components and remove any food residue. A soft “Scotchbrite” pad or similar product may be used in this process. For heavier burned-on stains we recommend “Easy-Off Oven & Grill Cleaner” followed by thorough washing with soap and water, rinse with fresh water and dry. AVOID CONTACT OF OVEN CLEANER WITH CONTROL VALVE, IGNITER ELECTRODE & WIRE, AND BOAT SURFACES. CAUTION: DO NOT USE ANY TYPE OF ABRASIVE PAD ON THE EXTERIOR MIRROR FINISH AS IT WILL SCRATCH THE SURFACE. USE ONLY A SOFT COTTON CLOTH. We recommend covering the grill between uses. Grill covers are available at Magma retailers or directly from Magma. See our website, [www.MagmaProducts.com](http://www.MagmaProducts.com).

**Grill Grates** - Clean with brass wire brush while grill is warm. Use Oven & Grill cleaner for burnt-on residue. Wash with soapy water and dry prior to storage.

**Ceramic Electrode** - Located just beside the burner, it should be kept clean of grease and debris. Be careful not to damage the ceramic insulation or the wire. See page 5 for electrode spark adjustment.

**Control Valve** - All valves are set and tested at our factory. Do not attempt to adjust or disassemble the valve in any way. Call Magma if you suspect it is not adjusted properly. Clean valve with a cloth and remove any debris obstructing the orifice.

**Repair/Replacement Parts** - All replacement parts are readily available at your Magma Retailers or directly from Magma. For a complete list of replacement parts visit our website [www.MagmaProducts.com](http://www.MagmaProducts.com).

## USING GRILL WITH ON-BOARD LPG (PROPANE) SYSTEMS

- Magma On-Board LPG (Propane) Valves & Hose Kits allow Magma Grills to be installed within a boats existing on-board, pre-regulated low pressure LPG (Propane) system.

- Use only **Magma Type 3 Low Pressure LPG (Propane) Valves**. See our **Valve Application Guide** at [www.MagmaProducts.com](http://www.MagmaProducts.com) for correct valve.

- In North America use **Magma A10-225 LPG 10' Gas Grill Connection Kit** in conjunction with **Type 3 Valve**. Outside North America check your local dealer for proper hose and fittings.

- A primary shutoff valve (**supplied with Gas Grill Connection Kit**) must be used with this control valve at point of connection into your system. This allows shut off of gas supply to hose leading to grill.

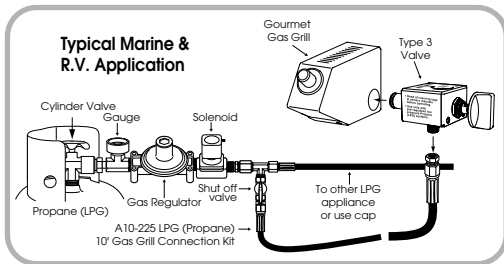
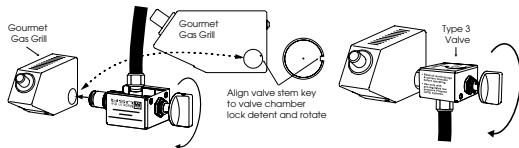

### IMPORTANT!!

- **DO NOT CONNECT A HIGH-PRESSURE SUPPLY HOSE FROM A NON-REGULATED TANK DIRECTLY TO GRILL.**

Magma's grills are designed for use with small disposable propane canisters or with pre-regulated low-pressure propane and optional low-pressure valves. Running high-pressure propane fuel supply lines on a boat is in violation of American Boat & Yacht Council (ABYC) guidelines and is not considered a safe application. Additionally, impurities found in larger refillable propane tanks may clog the small orifices in the high-pressure control valve/regulator causing it to lose performance capabilities and eventually fail. Regulating these tanks to 1/2 PSI and using this pre-regulated propane with the correct low-pressure valve will ensure safe, efficient performance of the grill.

## TROUBLE SHOOTING GUIDE

<b>Problem</b>	<b>Possible Cause</b>	<b>Possible Solution</b>
<b>Burner will not light with igniter</b>	<p>Igniter electrode covered with grease or residue</p> <p>Igniter/electrode too far from burner</p> <p>Igniter/electrode wire loose or disconnected</p> <p>Wire is shorted causing spark from wire before electrode</p> <p>No spark being generated</p>	<p>Clean igniter electrode</p> <p>Adjust electrode until proper spark appears (see page 5)</p> <p>Reconnect wire between igniter &amp; electrode (see page 5)</p> <p>Call Magma</p> <p>Call Magma</p>
<b>Burner will not light even with match</b>	<p>No gas flow</p> <p>Obstructed gas flow/debris or spider webs in burner tube</p>	<p>Check fuel level, refill cylinder or replace canister</p> <p>Clean valve orifice and burner, check all lines (see page 6)</p>
<b>Flare-up</b>	<p>Excessive cooking temperature</p> <p>Grease and/or residue build-up</p> <p>Excessive fat in meats</p> <p>Excessive oils in marinades</p>	<p>Operate only on low when lid is closed</p> <p>Reduce flame level</p> <p>Leave lid open</p> <p>Use water spray to cool</p> <p>Clean components</p> <p>Trim fat from cuts of meat before grilling</p> <p>Use non-oil based marinades</p>
<b>Yellow sooty flame</b>	<p>Obstructed gas flow/debris or spider webs in burner tube</p>	<p>Check and clean valve orifice and burner (see page 6)</p>
<b>Blow-out</b>	<p>Flame too low</p> <p>Wind directly on burner</p> <p>Obstructed gas flow</p>	<p>Increase flame</p> <p>Block wind when opening lid</p> <p>Clean burner or valve orifice (see page 6)</p>



## Contents

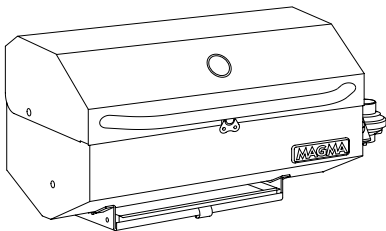
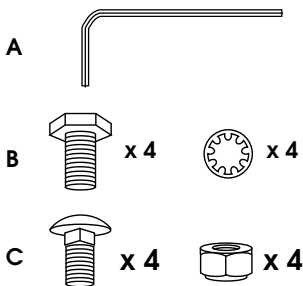

- A)** (1) 3/16" Hex key wrench for lid removal.
- B)** Pack of (4) 1/4"-20 x 5/8" hex head screws and internal lock washers for "Levelock" single mount application.
- C)** Pack of (4) 1/4"-20 x 5/8" carriage bolts and lock nuts for dual mount and single mount applications and table legs.

## LIMITED WARRANTY

Magma Products, Inc. guarantees this gas grill to be free from defects in materials or workmanship to the original consumer. This guarantee is for the periods herein specified when used under normal and reasonable conditions, one (1) year from the date of original purchase. This warranty does not include the cost of property damage or any inconvenience due to the failure of the product. Nor does it cover damage due to misuse, abuse, accident, or damage resulting from transportation of the product. Nor does it include damage resulting from the commercial use of this product. If the product fails to operate due to a defect in materials or workmanship during the warranty period, the defective part will be repaired or replaced at Magma's option. If you wish to obtain performance under this limited warranty, you should contact Magma's Customer Service Department via telephone at 562-627-0500 or 800-86-MAGMA, or via e-mail at mail@MagmaProducts.com, or via U.S. Postal Service mail at "Magma Products, Inc., attention Customer Service, 3940 Pixie Ave. Lakewood, CA 90712." The defective part, along with proof of purchase, must be returned postage prepaid to Magma Products, Inc. We suggest that you keep your purchase receipt as we may require reasonable proof of purchase.

In the state of California only, if refinishing or replacement of the product is not commercially practicable, the retailer selling the product, or Magma Products, Inc., will refund the purchase price paid for the product, less the amount directly attributable to use by the original consumer prior to the discovery of the nonconformity. In addition, in the state of California only, you may take the product to the retail establishment from which it was purchased or to any retail establishment selling this product in order to obtain performance under this warranty.

All implied warranties, including the implied warranties of merchantability and fitness for a particular purpose, are limited in duration to the express warranty periods specified herein for the parts described herein.

Some states do not allow limitations on how long an implied warranty lasts, so the above limitation may not apply to you. Neither Magma dealers, nor the retail establishment selling this product has any authority to make any warranties or to promise remedies in addition to or inconsistent with those stated above. Magma's maximum liability shall not exceed the purchase price of the product paid by the original consumer. Some states do not allow the exclusion or limitation of incidental or consequential damages, so the above limitation or exclusions may not apply to you. The warranty gives you specific legal rights and you may also have other rights which vary from state to state.

MAGMA and the Magma logo are registered trademarks of Magma Products, Inc.  
Monterey is a trademark of Magma Products, Inc.  
Patent pending.

CALIFORNIA PROPOSITION 65 – WARNING – The burning of gas cooking fuel generates some by-products, which are on the list of substances, which are known by the State of California to cause cancer or reproductive harm. California law requires businesses to warn customers of potential exposure to such substances. To minimize exposure to these substances, always operate this unit according to the use and care manual, ensuring you provide good ventilation when cooking with gas.



**Magma Products, Inc.**

3940 Pixie Avenue, Lakewood, CA 90712 ■ USA  
Phone (562) 627-0500 ■ e-mail: mail@MagmaProducts.com  
www.MagmaProducts.com

## ADDENDUM FOR GOURMET SERIES GAS GRILL MODELS

**A10-918AU-1, A10-918AU-2, A10-918AU-3**

**A10-1218AU-1, A10-1218AU-2, A10-1218AU-3**

**A10-1225AU-1, A10-1225AU-2 & A10-1225AU-3**

**SOLD IN AUSTRALIA**

**CAUTION:** Accessible parts may be very hot. Keep young children away. • CARBON MONOXIDE HAZARD-THIS APPLIANCE CAN PRODUCE CARBON MONOXIDE (no odour). Do not use in enclosed areas, (for example: car, tent, caravan, mobile home) may cause death. This appliance shall only be used in an above ground, open air situation with natural ventilation, without stagnant areas, where gas leakage & products of combustion are rapidly dispersed by wind & natural convection. • Use appliance only in horizontal position. • This appliance must only be serviced by an authorized person. • Do not use this appliance if it has damaged or worn seals. • Do not move this appliance during operation.

**FUEL CONTAINERS:** Change gas containers in well-ventilated areas, preferably outside, away from people & sources of ignition; such as naked flames, pilot flames, electric heaters/equipment. Do not use appliance if it is leaking, damaged, or not working properly. Check that burners are extinguished before removing gas container. To check if gas cylinder is empty, remove regulator/valve and shake listening for liquid in cylinder; if no liquid sounds are heard, cylinder is empty. **Natural Gas Applications Not Available In Australia**

**GAS LEAKS: NEVER CHECK FOR GAS LEAKS WITH A FLAME!** Check for gas leaks by applying a soapy solution to connections. If bubbles appear, turn off appliance and repair leaks as necessary.

### HOW TO ISOLATE GAS SUPPLY IN THE EVENT OF A LEAK (smell of gas):

**Cartridges:** If there is a leak on your appliance (smell of gas) and you cannot stop the gas flow, remove the appliance to a well ventilated location away from any ignition source.

**Cylinders:** If there is a leak on your appliance (smell of gas), immediately attempt to turn off cylinder valve. Turn off appliance control valve. Remove appliance to a well-ventilated location away from any ignition source.

### STORAGE: NEVER LEAVE GAS CYLINDERS CONNECTED WHEN NOT IN USE!

**Cylinders:** When you have finished using this appliance, turn gas cylinder off; wait for the flame to go out and turn the appliance control valve off. Remove appliance control valve from appliance and store control valve in a dry, non-corrosive environment. • Store fuel containers outdoors, in a well ventilated area, out of reach of children, never below decks on boats. (Any indoor storage shall comply with Section 2 Minor storage and usage of **AS/NZS 1596**).

**HOSES:** Use only AGA approved regulator and hose supplied by your distributor. (RECA #719 AGA 3735 Regulator) Connections must be spanner tight per AGA requirements. Make sure gas hose is in good condition and avoid twisting or kinking.

### PACKING MATERIALS: BEFORE INSTALLATION OR USE!

- Remove Cardboard End Protectors. The Valve Assembly and Fasteners are located in the End Protector that is labeled. Remove these items and save them for later use.
- Remove the plastic bag covering the grill.
- Open the Lid; If you model is equipped with a warming rack, cut the plastic static strap that is holding the warming rack in place.
- Remove the foam sheets protecting the grill grates.

MODEL	ORIFICE	Mj/hr
A10-918AU-1	.79 mm	11.3
A10-918AU-2	.82 mm	11.3
A10-918AU-3	.88 mm	11.3
A10-1218AU-1	.84 mm	13.2
A10-1218AU-2	.88 mm	13.2
A10-1218AU-3	.96 mm	13.2
A10-1225AU-1	1.04 mm	19.0
A10-1225AU-2	1.10 mm	16.5
A10-1225AU-3	1.06 mm	19.0

• This appliance shall only be used with propane cylinders certified to standard AS2030.  
• It may be hazardous to attempt to fit other types of gas containers.

**For Models A10-918AU-1, A10-1218AU-1 & A10-1225AU-1**  
**Type 1 Valve**

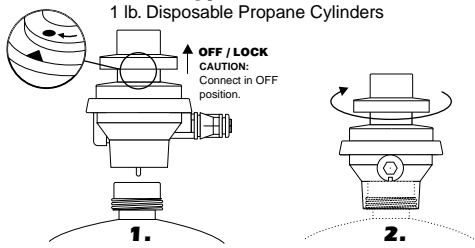

**For Models A10-918AU-2, A10-1218AU-2 & A10-1225AU-2**  
**Type 2 Valve**

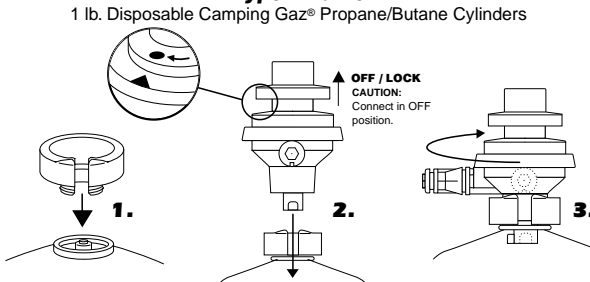

**Connecting Type 1 & Type 2 Valves to Gourmet Series Grills**



**For Models A10-918AU-3, A10-1218AU-3 & A10-1225AU-3**  
**Type 3 Valves**

Connecting Low Pressure Pre-Regulated Propane (LPG) to Gourmet Series Grills

