

# WATERTIGHT WIRING DEVICES

INDUSTRY'S FIRST  DEVICES



# WATERTIGHT WIRING DEVICES APPLICATION GUIDE

## WATER TREATMENT

Devices are made to withstand the most abusive environments



## FOOD AND BEVERAGE PROCESSING

Rated to withstand harsh, wet environments common to food and beverage facilities



## AGRICULTURE

Mud, standing water and abuse are no match for these rugged engineered devices



## OUTDOOR ENTERTAINMENT

Power is delivered consistently when the show must go on



## FACTORY

Ideal for delivering power to all types of industrial machinery and equipment



## CERTIFICATIONS



Known as The Most Trusted Name in Food Safety™, NSF International has been helping businesses in the agriculture, processing, food equipment, restaurant and retail industries to navigate the food safety and regulatory environment for nearly 70 years.

© 2014 NSF International. All rights reserved.



UL is a global independent safety science company with more than a century of expertise innovating safety solutions and is dedicated to promoting safe living and working environments.

© UL and the UL logo are trademarks of UL LLC © 2014 All Rights Reserved.



Products found with this mark means CSA International found that representative samples of this product met CSA's published Standards for Safety intended for the Canadian market.

© UL and CSA logo are trademarks of UL LLC © 2014 All Rights Reserved.



Superior water ingress protection uniquely designed for the most extreme wash down procedures, withstanding hot and high pressure water, in addition to excessively dusty environments.



# PRODUCT FEATURES

## PLUGS AND CONNECTORS

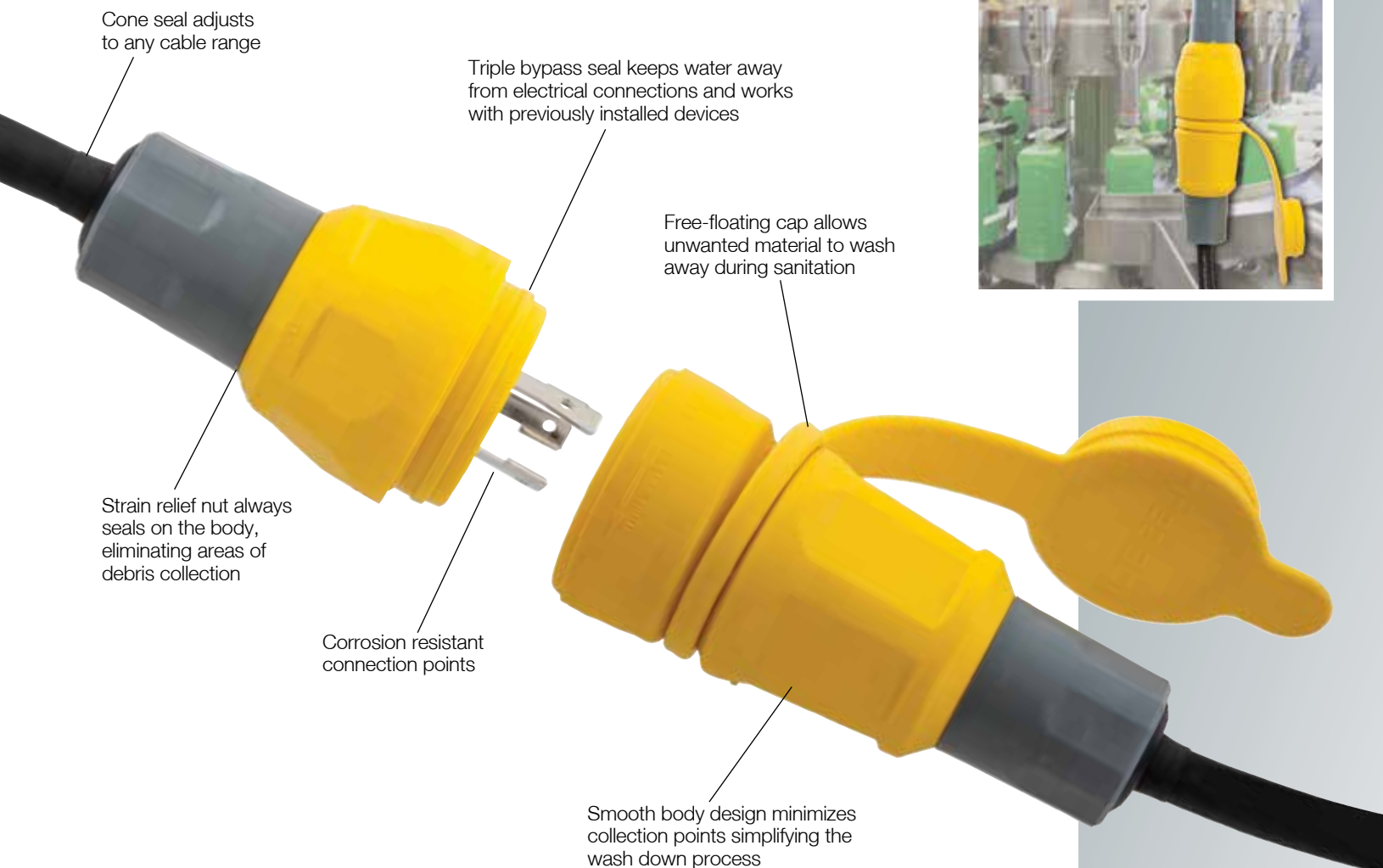
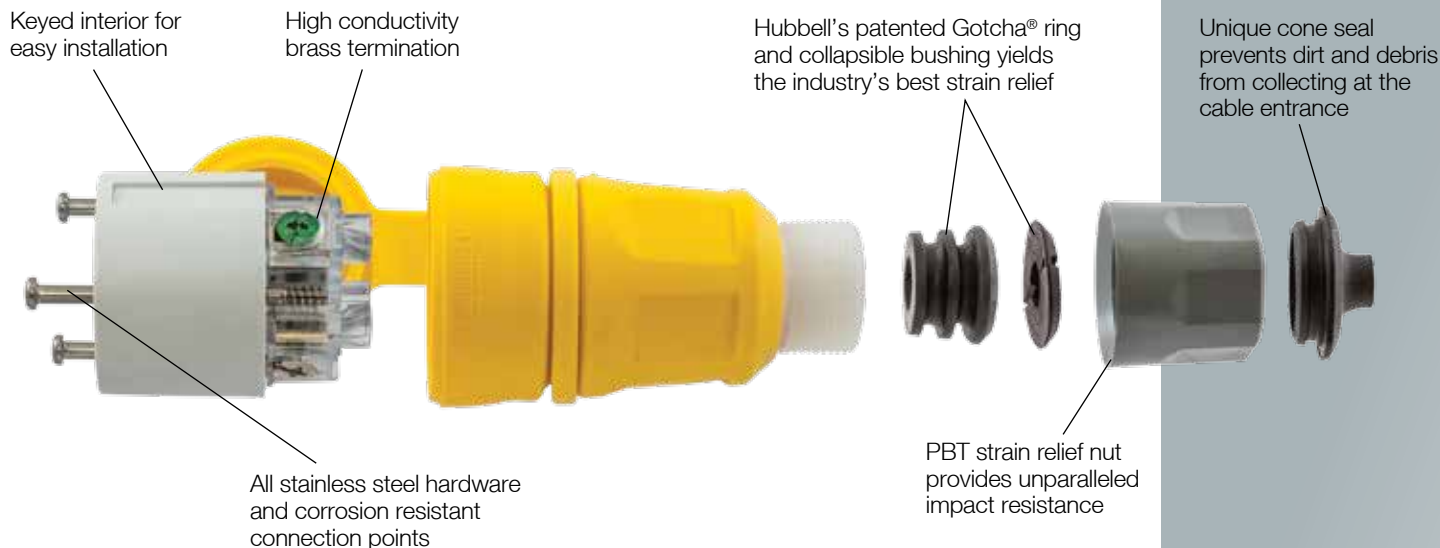

# WATERTIGHT WIRING DEVICES

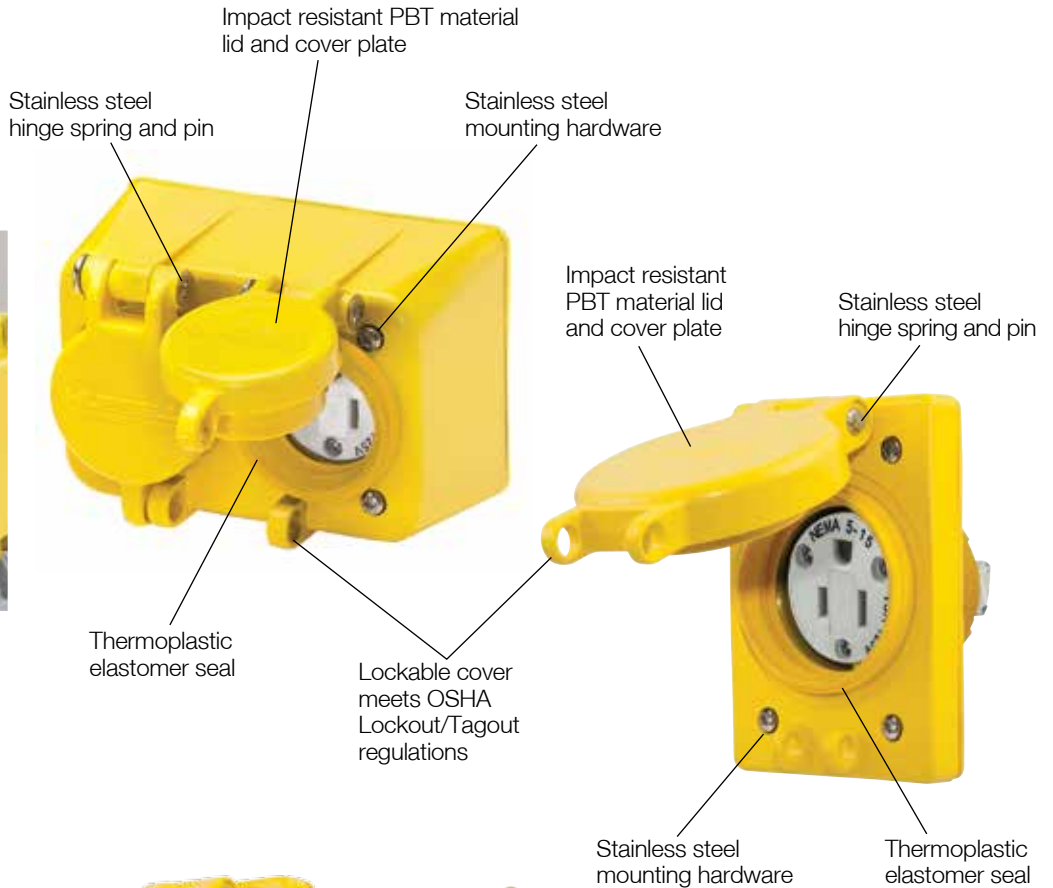

UL Type 4, 4X

IP65, 66, 67, 69k\*



HBL60W47



HBL6500





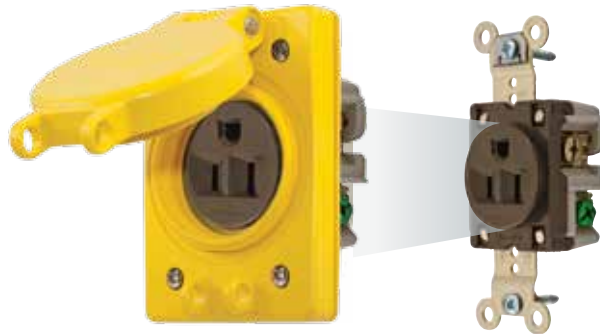







HBL60W47D



**Also Available:**  
Watertight Lift Covers, for use with standard receptacles.

## Ordering Information

### Straight Blade Devices

	Rating	Plug/ Connector	Poles/ Wires	Color	Plug	Connector	Receptacle with Lift Cover	Duplex Receptacle
15 Amp	NEMA 5-15 15A 125V	 	2P/3W	Yellow Black	<b>HBL14W47A</b> <b>HBL14W47BK</b>	<b>HBL15W47A</b> <b>HBL15W47BK</b>	<b>HBL60W47</b> —	<b>HBL60W47D</b> —
	NEMA 6-15 15A 250V	 	2P/3W	Yellow	<b>HBL14W49</b>	<b>HBL15W49</b>	<b>HBL60W49</b>	<b>HBL60W49D</b>
	15A 125V 10A 600V Non-NEMA	 	2P/3W	Yellow	<b>HBL14W07</b>	<b>HBL15W07</b>	—	—
20 Amp	NEMA 5-20 20A 125V	 	2P/3W	Yellow	<b>HBL14W33A</b>	<b>HBL15W33A</b>	<b>HBL60W33</b>	<b>HBL60W33D</b>
	NEMA 6-20 20A 250V	 	2P/3W	Yellow	<b>HBL14W48</b>	<b>HBL15W48</b>	<b>HBL60W48</b>	<b>HBL60W48D</b>

\*Single and duplex receptacles while in use, not with cover closed



# Twist-Lock® Devices

	Rating	Plug/ Connector	Poles/ Wires	Color	Plug	Connector	Receptacle with Lift Cover	Duplex Receptacle
15 Amp	NEMA L5-15 15A 125V		2P/3W	Yellow Black	<b>HBL24W47A</b> <b>HBL24W47BK</b>	<b>HBL25W47A</b> <b>HBL25W47BK</b>	<b>HBL65W47</b> —	<b>HBL65W47D</b> —
	NEMA L6-15 15A 250V		2P/3W	Yellow	<b>HBL24W49</b>	<b>HBL25W49</b>	<b>HBL65W49</b>	<b>HBL65W49D</b>
	NEMA L7-15 15A 277V AC		2P/3W	Yellow	<b>HBL24W34</b>	<b>HBL25W34</b>	<b>HBL65W34</b>	<b>HBL65W34D</b>
20 Amp	NEMA L5-20 20A 125V		2P/3W	Yellow Black	<b>HBL26W47</b> <b>HBL26W47BK</b>	<b>HBL27W47</b> <b>HBL27W47BK</b>	<b>HBL67W47</b> —	— —
	NEMA L6-20 20A 250V		2P/3W	Yellow	<b>HBL26W48</b>	<b>HBL27W48</b>	<b>HBL67W48</b>	—
	NEMA L7-20 20A 277V AC		2P/3W	Yellow	<b>HBL26W49</b>	<b>HBL27W49</b>	<b>HBL67W49</b>	—
	NEMA L14-20 20A 125/250V AC		3P/4W	Yellow	<b>HBL26W74</b>	<b>HBL27W74</b>	<b>HBL67W74</b>	—
	NEMA L15-20 20A 3Ø 250V AC		3P/4W	Yellow Black	<b>HBL26W75</b> <b>HBL26W75BK</b>	<b>HBL27W75</b> <b>HBL27W75BK</b>	<b>HBL67W75</b> —	— —
	NEMA L16-20 20A 3Ø 480V AC		3P/4W	Yellow Black	<b>HBL26W76</b> <b>HBL26W76BK</b>	<b>HBL27W76</b> <b>HBL27W76BK</b>	<b>HBL67W76</b> —	— —
	NEMA L21-20 20A 3ØY 120/208V AC		4P/5W	Yellow Black	<b>HBL26W81</b> <b>HBL26W81BK</b>	<b>HBL27W81</b> <b>HBL27W81BK</b>	<b>HBL67W81</b> —	— —
	NEMA L22-20 20A 3ØY 277/480V AC		4P/5W	Yellow	<b>HBL26W82</b>	<b>HBL27W82</b>	<b>HBL67W82</b>	—
	NEMA L23-20 20A 3ØY 347/600V		4P/5W	Yellow	<b>HBL26W83</b>	<b>HBL27W83</b>	<b>HBL67W83</b>	—
	20A 125/250V Non-NEMA		3P/3W	Yellow	<b>HBL26W08</b>	<b>HBL27W08</b>	<b>HBL67W08</b>	—
20A 3ØY 120/208V AC Non-NEMA		4P/4W	Yellow	<b>HBL26W09</b>	<b>HBL27W09</b>	<b>HBL67W09</b>	—	
30 Amp	NEMA L5-30 30A 125V		2P/3W	Yellow Black	<b>HBL28W47</b> <b>HBL28W47BK</b>	<b>HBL29W47</b> <b>HBL29W47BK</b>	<b>HBL69W47</b> —	— —
	NEMA L6-30 30A 250V		2P/3W	Yellow	<b>HBL28W48</b>	<b>HBL29W48</b>	<b>HBL69W48</b>	—
	NEMA L7-30 30A 277V AC		2P/3W	Yellow	<b>HBL28W49</b>	<b>HBL29W49</b>	<b>HBL69W49</b>	—
	NEMA L14-30 30A 125/250V AC		3P/4W	Yellow	<b>HBL28W74</b>	<b>HBL29W74</b>	<b>HBL69W74</b>	—
	NEMA L15-30 30A 3Ø 250V AC		3P/4W	Yellow	<b>HBL28W75</b>	<b>HBL29W75</b>	<b>HBL69W75</b>	—
	NEMA L16-30 30A 3Ø 480V AC		3P/4W	Yellow Black	<b>HBL28W76</b> <b>HBL28W76BK</b>	<b>HBL29W76</b> <b>HBL29W76BK</b>	<b>HBL69W76</b> —	— —
	NEMA L17-30 30A 3Ø 600V AC		3P/4W	Yellow	<b>HBL28W77</b>	<b>HBL29W77</b>	<b>HBL69W77</b>	—
	NEMA L18-30 30A 3ØY 120/208V AC		4P/4W	Yellow	<b>HBL28W78</b>	<b>HBL29W78</b>	—	—
	NEMA L21-30 30A 3ØY 120/208V AC		4P/5W	Yellow Black	<b>HBL28W81</b> <b>HBL28W81BK</b>	<b>HBL29W81</b> <b>HBL29W81BK</b>	<b>HBL69W81</b> —	— —
	NEMA L22-30 30A 3ØY 277/480V AC		4P/5W	Yellow	<b>HBL28W82</b>	<b>HBL29W82</b>	<b>HBL69W82</b>	—
	NEMA L23-30 30A 3ØY 347/600V AC		4P/5W	Yellow	<b>HBL28W83</b>	<b>HBL29W83</b>	<b>HBL69W83</b>	—
	30A 125/250V Non-NEMA		3P/3W	Yellow	<b>HBL28W08</b>	<b>HBL29W08</b>	<b>HBL69W08</b>	—
	30A 3ØY 120/208V AC Non-NEMA		4P/4W	Yellow	<b>HBL28W09</b>	<b>HBL29W09</b>	—	—



NSF UL SA  
UL Type 4, 4X, 6P  
**IP65, 66, 67, 69k\***  
SUITABILITY



# ACCESSORIES



HBL6500



HBL28W75IN



HBL29W75IN



HBLWTCS2



HBLWTB1



HBL50W50



UL Type 4X

IP65, 66, 67

SUITABILITY

## Ordering Information

### UL Type 4X Watertight Lift Covers

Lift Cover Assembly	Description	Receptacle with Lift Cover
	For use with 15A or 20A straight blade receptacles and 15A Twist-Lock® receptacles; receptacle not included.	<b>HBL6500</b>
For use with 20A Twist-Lock® receptacles; receptacle not included.	<b>HBL6700</b>	
Note: When mating with <b>HBL26W09</b> , 20A Non-NEMA plug, use HBL6800 cover.		
For use with 30A Twist-Lock® receptacles; receptacle not included.	<b>HBL6800</b>	

### Interiors

Device	125V		3Ø 250V AC		3Ø 480V AC	
	Plug	Receptacle	Plug	Receptacle	Plug	Receptacle
30A 15A Straight Blade Locking	<b>HBL14W47IN</b> <b>HBL24W47IN</b>	<b>HBL15W47IN</b> —	— —	— —	— —	— —
30A 20A Locking	—	<b>HBL27W47IN</b>	<b>HBL26W75IN</b>	—	<b>HBL26W76IN</b>	<b>HBL27W76IN</b>
30A Locking	—	—	<b>HBL28W75IN</b>	<b>HBL29W75IN</b>	<b>HBL28W76IN</b>	<b>HBL29W76IN</b>

### Bushings, Cone Seals and Closure Caps

Device	Bushings	Cone Seals	Closure Caps	
			Yellow	Black
30A 15A Straight Blade Locking	<b>HBLWTB1</b> <b>HBLWTB1</b>	<b>HBLWTCS1</b> <b>HBLWTCS1</b>	<b>HBL50W50</b> <b>HBL50W50</b>	<b>HBL50W50BK</b> <b>HBL50W50BK</b>
30A 20A Straight Blade Locking	<b>HBLWTB1</b> <b>HBLWTB2</b>	<b>HBLWTCS1</b> <b>HBLWTCS2</b>	<b>HBL50W50</b> <b>HBL50W52</b>	<b>HBL50W50BK</b> <b>HBL50W52BK</b>
30A Locking	<b>HBLWTB3</b>	<b>HBLWTCS3</b>	<b>HBL50W54</b>	<b>HBL50W54BK</b>



# FD BOXES AND ANGLED ADAPTERS

Introducing a fully UL Listed surface mount box engineered with features that allow easy, code compliant installation of all types of devices from 15A to 50A, including metallic ground bonding bracket, threaded conduit hubs and external mounting supports. Together with an industry first 55 degree angle adapter, the combination of devices is the only code compliant 45 cu.in. solution for 50A 4 wire installations. The angle adapter can also be installed separately for panel applications.

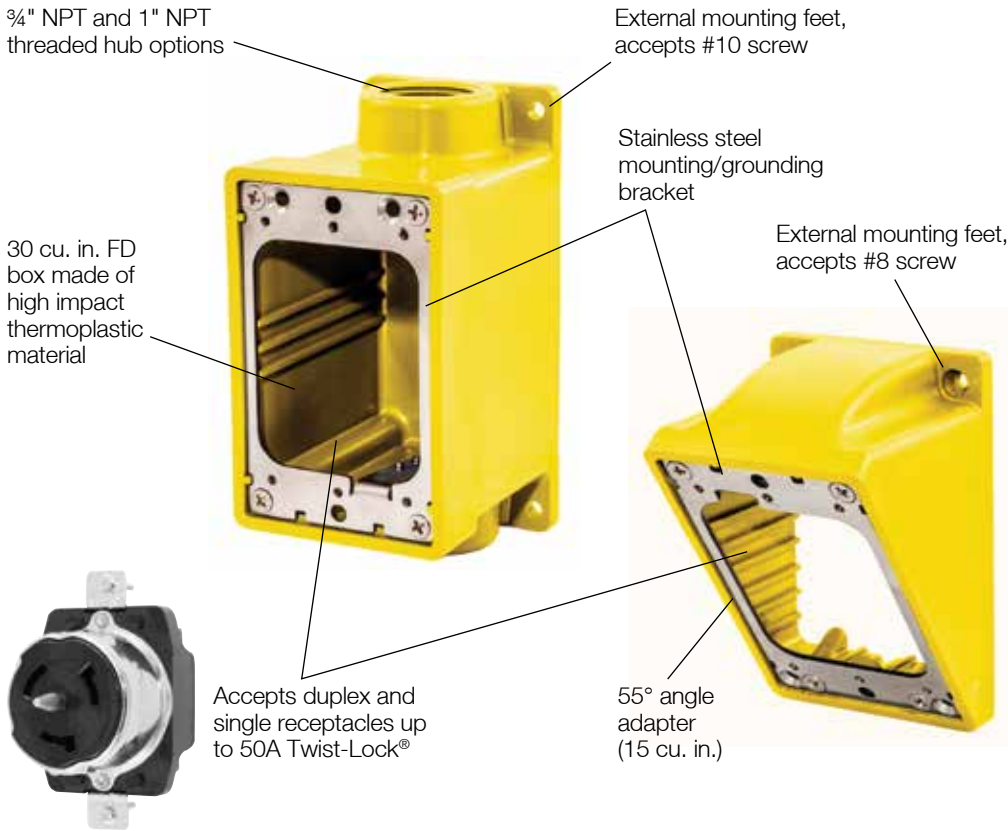

## Ordering Information

### FD Boxes and Angled Adapters

	Description	Catalog Number
Boxes	(2) 3/4" NPT Hubs, FD Box, Yellow	<b>HBL60CM83A</b>
	(2) 3/4" NPT Hubs, FD Box, White	<b>HBL60CM83WA</b>
	(2) 3/4" NPT Hubs, FD Box, Gray	<b>HBL6083</b>
	(2) 1" NPT Hubs, FD Box, Yellow	<b>HBL60CM84A</b>
	(2) 1" NPT Hubs, FD Box, White	<b>HBL60CM84WA</b>
	(2) 1" NPT Hubs, FD Box, Gray	<b>HBL6084</b>
Adapters*	55° Angle Adapter, Yellow	<b>HBL60CM55*</b>
	55° Angle Adapter, White	<b>HBL60CM55W*</b>
	55° Angle Adapter, Gray	<b>HBL6055*</b>
Kits	(2) 3/4" NPT Hubs, Box/Adapter Kit, Yellow	<b>HBL60CM83AK</b>
	(2) 3/4" NPT Hubs, Box/Adapter Kit, White	<b>HBL60CM83WAK</b>
	(2) 3/4" NPT Hubs, Box/Adapter Kit, Gray	<b>HBL6083AK</b>
	(2) 1" NPT Hubs, Box/Adapter Kit, Yellow	<b>HBL60CM84AK</b>
	(2) 1" NPT Hubs, Box/Adapter Kit, White	<b>HBL60CM84WAK</b>
	(2) 1" NPT Hubs, Box/Adapter Kit, Gray	<b>HBL6084AK</b>
Covers	Blank Cover Plate, Yellow	<b>HBL60CM88</b>
	Blank Cover Plate, White	<b>HBL60CM88W</b>
	Blank Cover Plate, Gray	<b>HBLP14FS</b>



\*When used with single or duplex receptacles



Note: \*Adapters are not UL listed, nor UL Type 4X. For UL Type 4X rating, use receptacles in a FD box.

# PORTABLE OUTLET BOXES

Wiring room large enough to accommodate the broadest range of device requirements in one size box

Cord entry options include pre-defined range or "Build your own option"

Fully thermoplastic elastomer housing exceeds UL crush requirements and is highly impact resistant, available in black or yellow

Brass inserts for maximum strength

Extended wall protects lift covers from impact damage

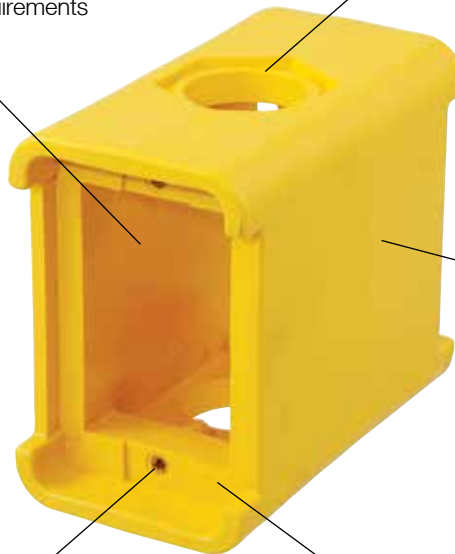

Box Suitable for Wet and Damp Locations

**IP44**  
SUITABILITY



## Ordering Information

### Pre-Assembled Portable Outlet Boxes (with Cord Connector Installed)

	Description	Cord Range Inches (mm)	Catalog Number
Boxes	Portable Outlet Box, Deep, Yellow	.38"-.50" (9.7-12.7)	<b>HBL3099</b>
	Portable Outlet Box, Deep, Feed Thru, Yellow	.38"-.50" (9.7-12.7)	<b>HBL3090F</b>
	Portable Outlet Box, Deep, Yellow with (2) duplex plates	.38"-.50" (9.7-12.7)	<b>HBL3000</b>

### Configurable Portable Outlet Boxes

	Empty Box Options	Catalog Number	Cord Range Inches (mm)	Cord Connector Options		Deluxe Cord Connectors	
				Gray Nylon	Black Nylon		
Boxes	Outlet Box, Yellow	<b>HBL3080</b>	.38"-.50" (9.5-12.7)	<b>SHC1039CR</b>	—	—	
	Outlet Box, Black	<b>HBL3080BK</b>	.50"-.63" (12.7-15.9)	<b>SHC1040CR</b>	<b>SHC2040CR</b>	<b>CG810NM</b>	
	Feed Thru Box, Yellow	<b>HBL3080F</b>	.63"-.75" (15.9-19.0)	<b>SHC1041CR</b>	<b>SHC2041CR</b>	<b>074011341</b>	
	Feed Thru Box, Black	<b>HBL3080FBK</b>	.75"-.88" (19.0-22.2)	<b>SHC1042CR</b>	<b>SHC2042CR</b>	<b>074011342</b>	
				.88"-1.00" (22.2-25.4)	<b>SHC1043CR</b>	<b>SHC2043CR</b>	<b>074011343</b>
				.59"-1.00" (15.0-25.4)	<b>SEC100GA</b>	<b>SEC100BA</b>	—

Note: Includes Locknut.





# COVER PLATES FOR PORTABLE OUTLET BOXES AND PANELS

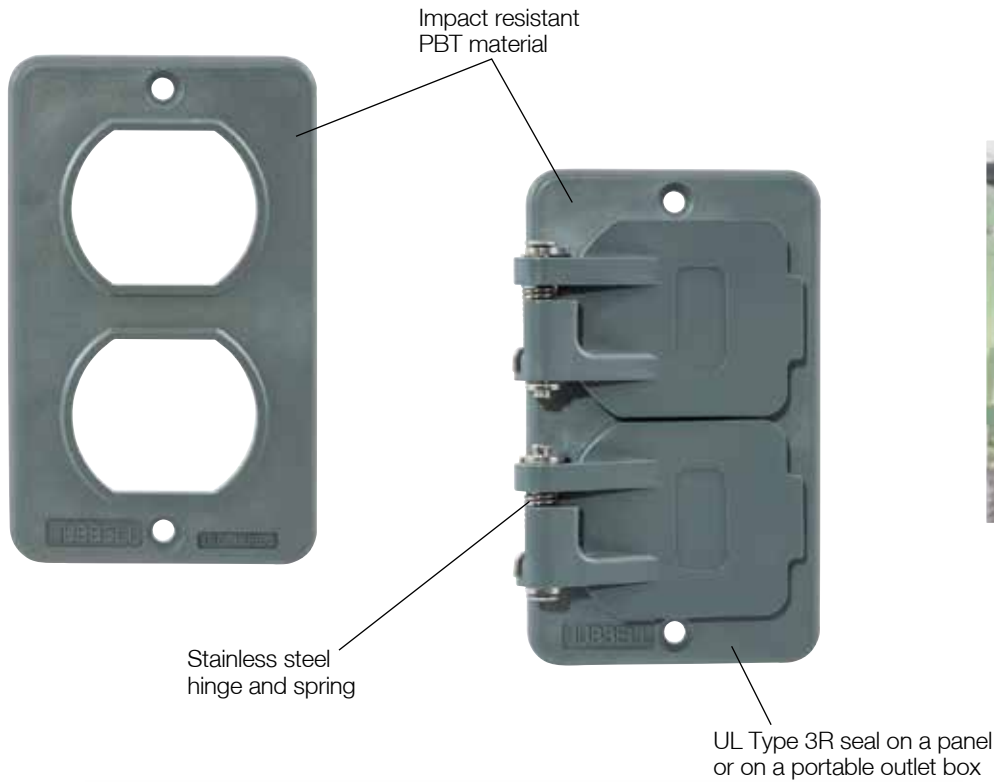

**UL** **SF**  
**UL Type 3R**  
**IP44**  
SUITABILITY



**UL Type 1**



Ordering Information

## Cover Plates for Portable Outlet Boxes and Panels

	Description	UL Type 3R	UL Type 1
Cover Plates	Outlet box cover, duplex receptacle	<b>HBL3056</b>	<b>HBL3051</b>
	Outlet box cover, 1.39" diameter receptacle	<b>HBL3057</b>	<b>HBL3052</b>
	Outlet box cover, 1.572" diameter receptacle	<b>HBL3058</b>	<b>HBL3055</b>
	Outlet box cover; GFCI	<b>HBL3061</b>	<b>HBL3060</b>
	Outlet box coverplate, blank	<b>HBL3054</b>	—

# SPECIFICATIONS

## Materials

### Plug/Connector

Part	Materials
Blade/Contact Carrier	Nylon, white
Terminal Retainer	Polycarbonate, clear
Housing	Thermoplastic elastomer
Housing Insert	Nylon, white
Strain Relief Nut	PBT thermoplastic, gray
Blades/Contacts	Brass, nickel plated
Terminal Screws	Brass
Terminal Screw Size	#8-32 15A/20A Straight Blade and 15A Twist-Lock; #10-32 20A and 30A Twist-Lock
Assembly Screws	Stainless Steel
Bushings	Thermoplastic elastomer, black
Gotcha Ring	Nylon
Cone Seal	Thermoplastic elastomer, black
Closure Cap	Thermoplastic elastomer

### Receptacle Assembly

Part	Materials
Base, Flip Lid, and Backplate	PBT
Seal Collar	Thermoplastic elastomer
Mounting Screws	Stainless Steel
Spring and Hinge Pin	Stainless Steel

### Portable Outlet Box and Accessories

Part	Materials
Box Enclosure	Thermoplastic elastomer
Strain Relief Nut	PBT
Grommet	Thermoplastic elastomer
Gotcha Ring	Nylon
Locknut	Steel, zinc plate
Threaded Inserts	Brass
Receptacle Screw	Stainless steel
Cover Plate	PBT
Cover Plate Seal	Neoprene
Cover Plate Spring	Stainless steel
Hinge Pin	Stainless steel
Hinge Bracket	Zinc plated steel
Rivets	Zinc plated steel

## Performance

### Electrical

Dielectric Voltage	
Connectors:	2000V AC if rated 300V or less; 3000V AC if rated above 300V
Plugs:	2500V AC if rated 300V or less; 3500V AC if rated above 300V
Max Working Voltage	As marked
Current Interrupting	Rated for current interruption per UL498
Temperature Rise	30°C max per UL498 at rated current

### Mechanical

Cord and terminal accommodations:

#### Plugs and Connectors

15 and 20A Straight Blade and 15A Locking	16/3 SJ to 10/3 SJ, 18/3 S to 12/3 S, (Ø.325" to Ø625") (Ø8.3mm to Ø15.9 mm)
20A Locking Except HBL26W09 & HBL27W09	Min. Cord: 16/3 SJ, 18/3 S, 18/4 SJ, 18/4 S, 18/5 S, (Ø.325") (Ø8.3 mm) Max. Cord: 10/3 S, 10/4 S, 10/5 S (.875") (22.2 mm)
30A Locking Including HBL26W09 & HBL27W09	Min Cords: 12/3 SJ, 16/3 S, 14/4 SJ, 18/4 S, 18/5 S, (Ø.375") (Ø9.5 mm) Max Cord: 8/3 S, 8/4 S, 10/5 S (1.125") (28.6 mm)

Receptacles – use solid or stranded building wire or flexible cord only as outlined below:

All Straight Blade	18 AWG to 10 AWG
15A Locking	18 AWG to 10 AWG
20A and 30A Locking	18 AWG to 8 AWG

#### Portable Outlet Boxes

Cord Range	.38" to .68" (HBL3099, HBL3090F, HBL3000) .38" to 1.00" with user-specified cord connector
Wiring Volume	19.0 in <sup>3</sup>

### Environmental

Moisture Resistance	UL Listed to 3R, 3RX, 4, 4X, 6, 6P, 12 (Plugs and connectors); 3R, 3RX, 4, 4X (Receptacles); Wet and Damp Locations (Portable outlet boxes); Covers (POB) UL Type 3R and Wet Locations cover closed
Flammability	UL94V0 (boxes, covers, and plates); UL94V2 (Plugs, connectors, and interiors); UL94HB (Caps, bushings, and cone seals)
Operating Temperatures	-40°C (without impact) to +60°C continuous
UV Resistance	All exposed materials are UV stabilized

## Specifications

Listings (Plug/Connector and Flip Lid Assembly)

Listed to UL498  
 Certified to CSA C22.2 No. 42  
 Meets NEMA WD-1, WD-6, and ANSI standards  
 IP66 Suitability  
 NSF Certified (Plugs, Connectors and Receptacles)

### FD Box/Adapter

Part	Materials
Box Enclosure	PBT
Ground Bracket	316 Stainless Steel
Ground Screw	Brass
Angle Adapter	PBT

### Environmental

Box	UL Type 4X (with UL Type 4X receptacle assembly) UL Type 3R (with weatherproof cover plate)
-----	--



# DIMENSIONS

## Plugs and Connectors Inches (mm)

		15A & 20A Straight Blade	15A Non-NEMA Straight Blade	15A Twist-Lock®	20A Twist-Lock®	30A Twist-Lock®
Plugs	<b>A</b>	1.85 (47.07)	1.63 (41.40)	1.85 (47.07)	2.51 (63.70)	2.77 (70.41)
	<b>B</b>	3.16 (80.27)	2.68 (68.00)	3.21 (81.46)	3.96 (100.69)	3.94 (99.98)
Connectors	<b>C</b>	1.85 (47.07)	1.80 (46.00)	1.85 (47.07)	2.51 (63.70)	2.77 (70.41)
	<b>D</b>	4.42 (112.14)	4.00 (102.00)	4.62 (117.22)	5.69 (144.55)	5.67 (144.00)

Note: For HBL26W09 and HBL27W09 use 30A Twist-Lock® dimensions.

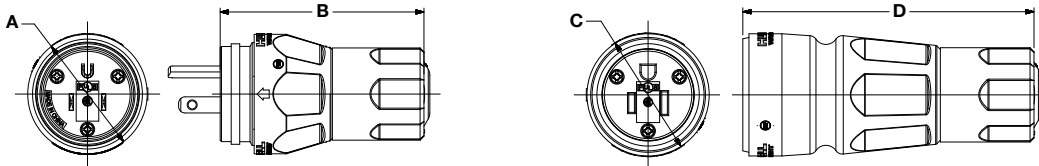

## Receptacles with Lift Covers Inches (mm)

	15A & 20A Straight Blade	15A Twist-Lock®	20A Twist-Lock®	20A Non-NEMA	30A Twist-Lock®	30A Non-NEMA
<b>A</b>	4.56" (115.9)	4.56" (115.9)	4.56" (115.9)	4.56" (115.9)	4.56" (115.9)	4.56" (115.9)
<b>B</b>	3.10" (78.7)	3.10" (78.7)	3.10" (78.7)	3.10" (78.7)	3.10" (78.7)	3.10" (78.7)
<b>C</b>	1.20" (30.6)	1.20" (30.6)	1.20" (30.6)	1.20" (30.6)	1.20" (30.6)	1.20" (30.6)
<b>D</b>	3.25" (82.6)	3.25" (82.6)	3.25" (82.6)	3.25" (82.6)	3.25" (82.6)	3.25" (82.6)
<b>E</b>	1.88" (47.6)	1.88" (47.6)	1.88" (47.6)	1.88" (47.6)	1.88" (47.6)	1.88" (47.6)
<b>F</b>	1.26" (32.0)	1.46" (37.1)	1.72" (43.7)	2.26" (57.4)	1.72" (43.7)	1.97" (50.0)
<b>G</b>	1.63" (41.4)	1.63" (41.4)	2.25" (57.2)	2.25" (57.2)	2.25" (57.2)	2.25" (57.2)
<b>H</b>	5.00" (127.0)	5.00" (127.0)	5.00" (127.0)	5.00" (127.0)	5.00" (127.0)	5.00" (127.0)

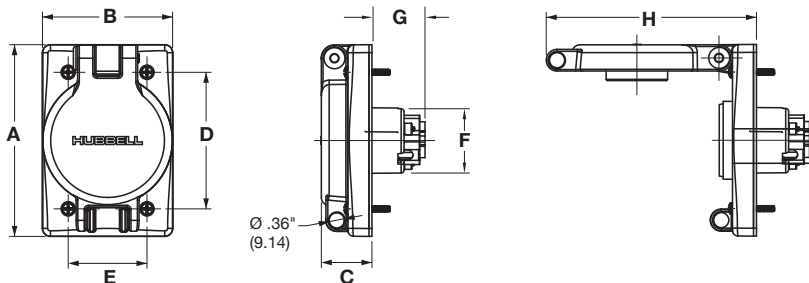

## Portable Outlet Boxes Inches (mm)

	Pre-Assembled	Configurable
<b>A</b>	4.30" (109.2)	4.30" (109.2)
<b>B</b>	5.00" (127.0)	5.00" (127.0)
<b>C</b>	2.77" (70.4)	2.77" (70.4)
<b>D</b>	3.28" (83.3)	3.28" (83.3)
<b>E</b>	5.79" (147.0)	—
<b>F</b>	7.28" (184.9)	—

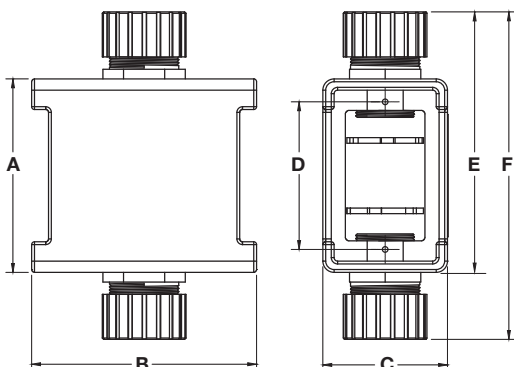

## Cover Plates Inches (mm)

<b>A</b>	3.78" (96.0)
<b>B</b>	2.28" (57.9)
<b>C</b>	0.27" (6.9)
<b>D</b>	3.28" (83.3)
<b>E</b>	1.87" (47.5)
<b>F</b>	3.25" (82.6)

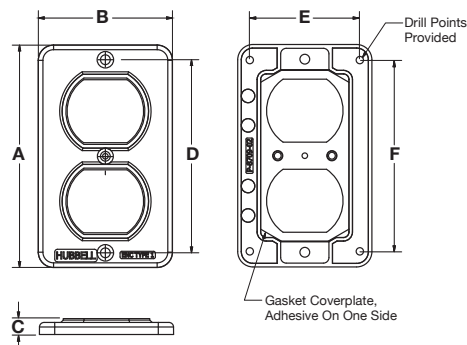

Style shown is representative of all openings.



### Full Line Catalog

The new Hubbell Wiring Device-Kellems catalog showcases our enhanced product offering to provide a breadth of solutions for the industrial, commercial and residential markets.



### Hubbell Safety Brochure

Hubbell has always been focused on safety. That's why Hubbell products are designed and developed to first provide maximum safety against injury and the potential dangers of electricity.

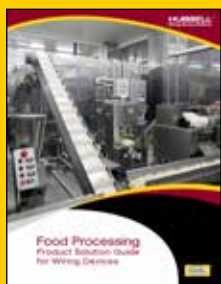

### Hubbell Food Processing Brochure

Hubbell's food processing guide identifies Wiring Device-Kellems product solutions for areas where water, corrosiveness, harsh temperature and personal protection are required. Food processing is a demanding environment and Hubbell has the right products to keep production moving safely.

## Twist-Lock® App

When you're on the go... Use the New Twist-Lock® App from Hubbell®.



**Download it today!**



# WATERTIGHT WIRING DEVICES



**HUBBELL®**  
Wiring Device-Kellems

[www.hubbell-wiring.com](http://www.hubbell-wiring.com)

