



WOOD
COLLECTION



EVOOQUE



 **Tagina**
ITALY'S BEST SURFACES

EVOQUE

EVOQUE si ispira a un rovere italiano, un legno sobrio ed elegante, lasciato “al naturale” per evocare negli ambienti sensazioni di calore, comfort e relax. Una collezione che sposa stile e tecnologia, fondamentale per ottenere un effetto superficiale vellutato al tatto ma al contempo contraddistinto dal basso grado di riflessione della luce tipico del legno naturale.

La sensazione di realismo si amplifica nelle grafiche, grazie all'utilizzo dell'alta definizione per ricreare venature e nodi con estrema precisione di dettaglio. 5 le tonalità cromatiche disponibili, sia in versione da interno sia da esterno, anche nel grande formato 26,5x180 cm.

Inspired by an Italian oak, a sober and elegant wood, EVOQUE has been left 'natural' to provide rooms with a feeling of warmth, comfort, and relaxation. The collection combines style with technology, through the essential engineering required to produce a surface that is soft to the touch and offers the low level of reflection that is typical of natural wood.

The realism is amplified by the patterns, through the high definition graphics use to create graining and knots with the utmost attention to detail. The line offers five colour shades, which are available in both indoor and outdoor versions, as well as in a large version measuring 26.5x180 cm.

EVOQUE est inspiré du chêne italien, un bois sobre et élégant, laissé « au naturel » pour évoquer des sensations de chaleur, de confort et de détente dans les espaces. Une collection qui allie style et technologie, fondamentale pour obtenir un effet de surface velouté au toucher mais qui se distingue en même temps par le faible degré de réflexion de la lumière, typique du bois naturel.

La sensation de réalisme est amplifiée dans les graphismes, grâce à l'utilisation de la haute définition pour recréer les veines et les nœuds avec des détails extrêmement précis. 5 tons disponibles, dans les versions pour l'intérieur et l'extérieur, également en grand format 26,5x180 cm.

EVOQUE ist von einer italienischen Eiche inspiriert, einem schlichten und eleganten Holz, das “natürlich” ist und ein Gefühl von Wärme, Komfort und Entspannung in den Zimmern hervorruft. Eine Kollektion, die Stil und Technologie vereint, die zur Erzielung eines samtigen Oberflächeneffektes bei der Berührung unerlässlich ist und sich gleichzeitig durch den für Naturholz typischen geringen Grad der Lichtreflexion auszeichnet.

Das Gefühl der Echtheit des Holzes wird in der Grafik durch die Verwendung der hohen Auflösung verstärkt, um Aderungen und Astknoten mit äußerster Detailgenauigkeit nachzubilden. Erhältlich sind auch im Großformat von 26,5 x 180 cm 5 Farbtöne, sowohl bei der Version für den Innen- als auch bei der für den Außenbereich.

100% Made in Italy



DOUSSIE 26,5x180 Nat. Ret.

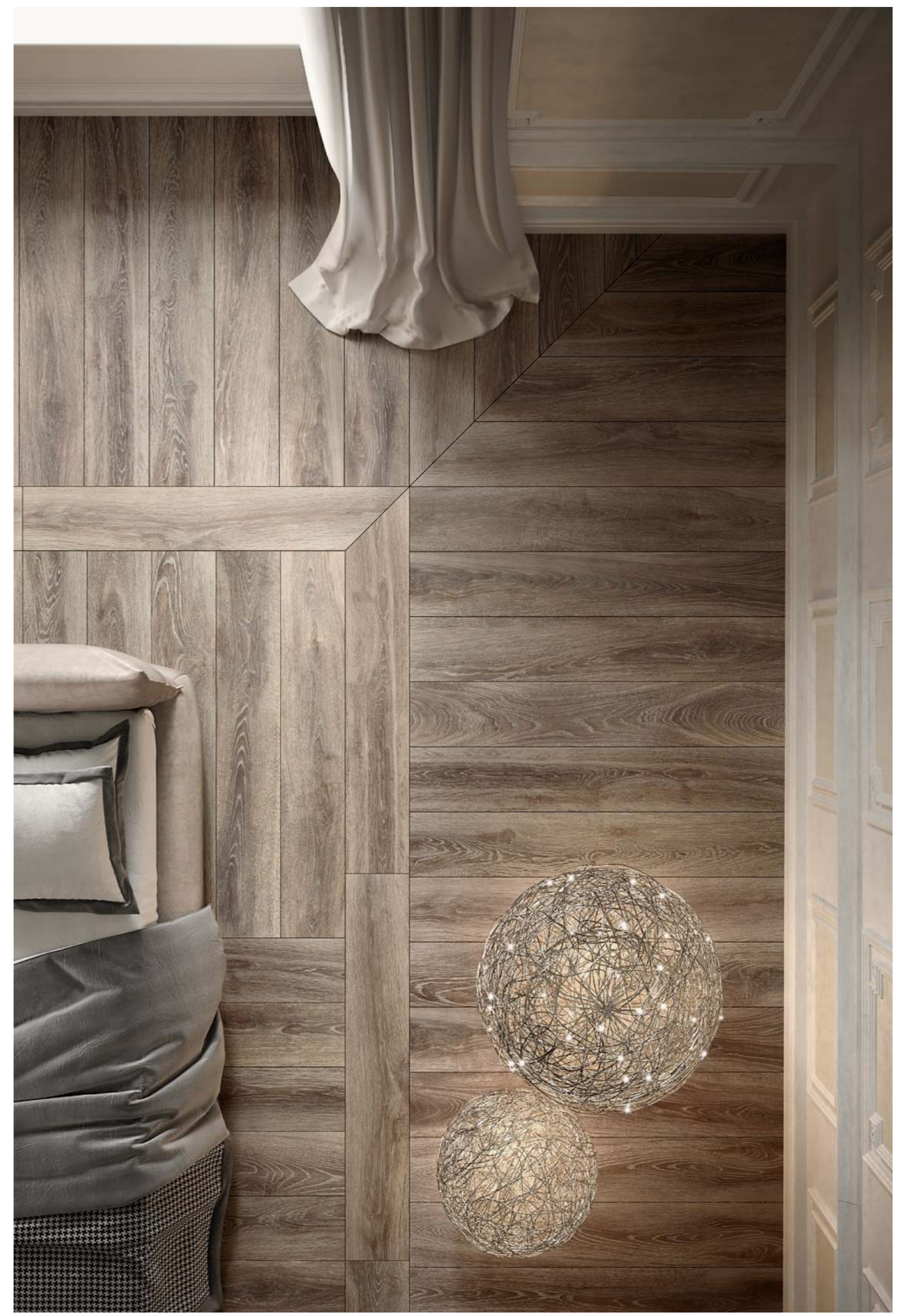

BAHIA 20x120 Nat. Ret.









DOUGLAS 40x120 20 mm Nat. Ret. R11

Special pieces for swimming pool:
DOUGLAS Griglia + Ang. 20x60 20 mm Nat. Ret. R11
DOUGLAS Gradone Grip Bordo Piscina + Ang. 40x120 20 mm Nat. Ret. R11

FORMATI
 Sizes / Formats / Formate

10 mm . 26,5x180 - 10 1/2"x71" / 60x120 - 24"x48" / 20x120 - 8"x48"
10 mm R11 . 20x120 - 8"x48"
20 mm R11 . 40x120 - 16"x48"

COLORI
 Colours / Couleurs / Farben



KORINA ROVERE DOUSSIE DOUGLAS BAHIA

CONTINUITÀ PROGETTUALE INDOOR-OUTDOOR
 Design continuity indoors and out / Continuité conceptuelle à l'intérieur et à l'extérieur / Entwurfskontinuität im innen-und Aussenbereich



INDOOR



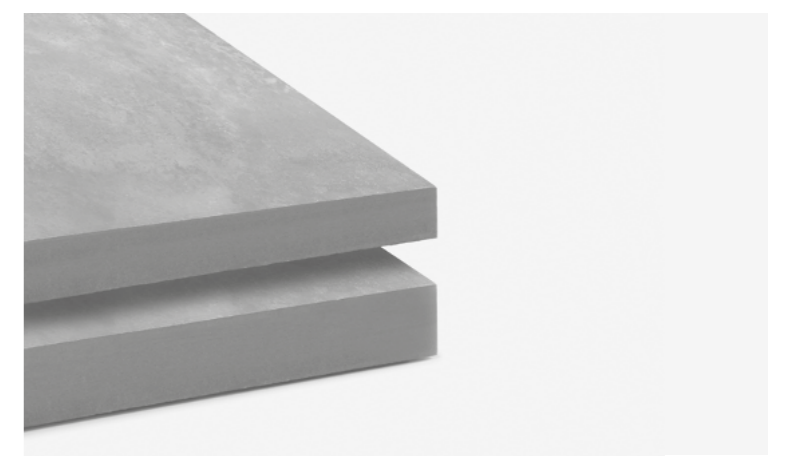

Soluzioni contemporanee per l'interior design
 Contemporary solutions for interior design.
 Solutions contemporaines pour le design intérieur.
 Zeitgemäße Lösungen für das Interior Design.



OUTDOOR

Versatilità e prestazioni per la progettazione in esterna
 Versatility and performance for outdoor design.
 Polyvalence et performance pour l'aménagement extérieur.
 Vielseitigkeit und Leistungen für Outdoor-Design.

SISTEMI DI POSA
 Laying systems / Systemes de pose / Verlegearten

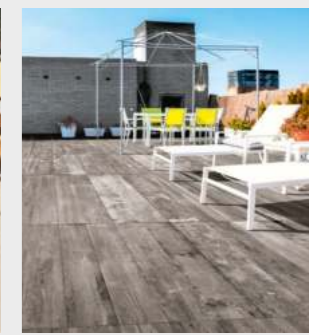
<p>Posa su erba Laying on grass Pose sur l'herbe Verlegung auf Wiese</p> 	<p>Posa su sabbia Laying on sand Pose sur sable Verlegung auf Sand</p> 	<p>Posa sopraelevata Raised laying Pose surélevée Verlegung auf Stelzlager</p> 	<p>Posa su ghiaia Laying on gravel Pose sur gravier Verlegung auf Kies</p> 	<p>Posa tradizionale Standard laying Pose traditionnelle Herkömmliche Verlegung</p> 
--------------------------------------------------------------------------------------------------------------------------------------------------------------------------------------------------------------------------------------	------------------------------------------------------------------------------------------------------------------------------------------------------------------------------------------------------------------------------------	--------------------------------------------------------------------------------------------------------------------------------------------------------------------------------------------------------------------------------------------	----------------------------------------------------------------------------------------------------------------------------------------------------------------------------------------------------------------------------------------	-------------------------------------------------------------------------------------------------------------------------------------------------------------------------------------------------------------------------------------------------

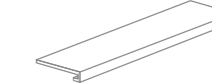
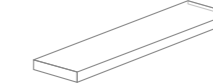
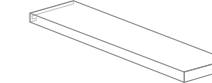
Spessore . Thickness . Epaisseur . Stärke - 10 mm**Gres porcellanato colorato in massa.** Full-body coloured porcelain stoneware. Grès cérame coloré dans la masse. In der Masse gefärbtes Feinsteinzeug.**INDOOR**TABELLA RIEPILOGATIVA
Summary table
Tableau récapitulatif
Zusammenfassenden Tabelle**26,5x180**
10 1/2"x71"**60x120**
24"x48"**20x120**
8"x48"**Battiscopa**
6,3x120
2 1/2"x48"**Coprispigo triangolare**
1,4x120
1/2"x48"**Ang. Coprispigo triang.**
1,4x1,4
1/2"x 1/2"**Gradino a C**
33x120x3,2h
13"x48"x1 1/4"h**Ang. Gradino a C - SX**
33x120x3,2h
13"x48"x1 1/4"h**Ang. Gradino a C - DX**
33x120x3,2h
13"x48"x1 1/4"h

SPESSORE - THICKNESS - EPAISSEUR - STÄRKE		10 mm	10 mm	10 mm	10 mm	10 mm	10 mm	10 mm	10 mm	10 mm
	KORINA <input type="checkbox"/> Nat. Ret.	105060	105070	105106	105151	105170	105175	105180	105181	105182
	ROVERE <input type="checkbox"/> Nat. Ret.	105064	105083	105119	105159	105171	105176	105183	105184	105185
	DOUSSIE <input type="checkbox"/> Nat. Ret.	105066	105082	105118	105157	105172	105177	105186	105187	105188
	DOUGLAS <input type="checkbox"/> Nat. Ret.	105062	105074	105110	105153	105173	105178	105189	105190	105191
	BAHIA <input type="checkbox"/> Nat. Ret.	105067	105078	105114	105155	105174	105179	105192	105193	105194
	Pallet	Pallet	Pallet	Pallet	Pallet	Pallet	Pallet	Pallet	Pallet	Pallet
	198X97	80X120	80X120	80X120	80X120	80X120	80X120	80X120	80X120	80X120
N°										
m²										
Kg										
m² x	3	2	6	9	6	2	1	1		
m² x	1,43	1,44	1,44							
Kg x	31,3	31,5	31,5	13	2	23	11,5	11,5		
m² x	42	30	24							
m² x	60,06	43,2	34,56							
** Kg x	1360	970	775							
h x	71	74	56							
Imballo (tara) - Packaging (tare)	(40)	(20)	(20)	(20)	(20)	(20)	(20)	(20)	(20)	(20)

I pesi riportati in tabella sono indicativi e potrebbero essere soggetti a leggere variazioni.
The weights stated in the chart may undergo slight changes for production reasons.
Les poids indiqués dans le tableau peuvent subir de légères variations pour des raisons de production.
Die in der Tabelle angegebenen Gewichte können aus Produktionsgründen geringfügigen Abweichungen unterliegen.

Non si garantisce l'abbinabilità tra fondi di spessori diversi e tra fondo e pezzo speciale.
It is not guaranteed that background tiles with different thicknesses can be used together, nor is it guaranteed for background tiles and trims.
Nous ne garantissons pas la possibilité de combiner des carrelages de sol de différentes épaisseurs et un carrelage de sol avec une pièce spéciale.
Die Kombinierbarkeit von Fliesen unterschiedlicher Stärke sowie zwischen Fliese und Formteil kann nicht garantiert werden.

* A disposizione solo su richiesta. Tempi di consegna 30 gg.
Available upon request only. Delivery terms: 30 days.
Disponibile seulement sur requête. Délais de livraison: 30 jours.
Verfügbar auf Anfrage. Lieferzeit: 30 Tage.

** Il peso è comprensivo dell'imballo.
The total weight includes the packaging.
Le poids comprend aussi l'emballage.
Das Gesamtgewicht enthält auch die Verpackung.

*** Vendita a scatola completa.
Full box sale.
Vente à la boîte complète.
Volle Kartons.

Naturale e rettificato.
Natural and rectified.
Natur et rectifié.
Natur Oberfläche und kalibriert.

Spessore . Thickness . Epaisseur . Stärke - 10 mm R11 / 20 mm R11**Gres porcellanato colorato in massa.** Full-body coloured porcelain stoneware. Grès cérame coloré dans la masse. In der Masse gefärbtes Feinsteinzeug.**OUTDOOR**TABELLA RIEPILOGATIVA
Summary table
Tableau récapitulatif
Zusammenfassenden Tabelle**20x120**
8"x48"**40x120**
16"x48"* Elemento a L monolitico Δ
15x30x4h
6"x12"x1 1/2"h

SPESSORE - THICKNESS - EPAISSEUR - STÄRKE		10 mm	20 mm	9,5 mm
	<input type="checkbox"/> Nat. Ret.	105123	105096	
	<input checked="" type="checkbox"/> Nat. Nat.			105160
	<input type="checkbox"/> Nat. Ret.	105127	105103	
	<input checked="" type="checkbox"/> Nat. Nat.			105161
	<input type="checkbox"/> Nat. Ret.	105129	105102	
	<input checked="" type="checkbox"/> Nat. Nat.			105162
	<input type="checkbox"/> Nat. Ret.	105125	105098	
	<input checked="" type="checkbox"/> Nat. Nat.			105163
	<input type="checkbox"/> Nat. Ret.	105131	105100	
	<input checked="" type="checkbox"/> Nat. Nat.			105164
		Pallet	Pallet	Pallet
		80x120	80x120	80x120
N°				
m ²				
Kg				
x		6	2	6
m ² x		1,44	0,96	
Kg x		31,5	41,5	7,5
x		24	24	
m ² x		34,56	23,04	
** Kg x		775	1015	
h x		56	68	
Imballo (tara) - Packaging (tare)		(20)	(20)	(20)

I pesi riportati in tabella sono indicativi e potrebbero essere soggetti a leggere variazioni.
The weights stated in the chart may undergo slight changes for production reasons.
Les poids indiqués dans le tableau peuvent subir de légères variations pour des raisons de production.
Die in der Tabelle angegebenen Gewichte können aus Produktionsgründen geringfügigen Abweichungen unterliegen.

* A disposizione solo su richiesta. Tempi di consegna 30 gg.
Available upon request only. Delivery terms: 30 days.
Disponible seulement sur requête. Délais de livraison: 30 jours.
Verfügbar auf Anfrage. Lieferzeit: 30 Tage.

Non si garantisce l'abbinabilità tra fondi di spessori diversi e tra fondo e pezzo speciale.
It is not guaranteed that background tiles with different thicknesses can be used together, nor is it guaranteed for background tiles and trims.
Nous ne garantissons pas la possibilité de combiner des carrelages de sol de différentes épaisseurs et un carrelage de sol avec une pièce spéciale.
Die Kombinierbarkeit von Fliesen unterschiedlicher Stärke sowie zwischen Fliese und Formteil kann nicht garantiert werden.

** Il peso è comprensivo dell'imballo.
The total weight includes the packaging.
Le poids comprend aussi l'emballage.
Das Gesamtgewicht enthält auch die Verpackung.

Naturale e rettificato.
Natural and rectified.
Naturel et rectifié.
Natur Oberfläche und kalibriert.

Naturale e naturale.
Natural and natural.
Naturel et naturel.
Natur natur.

Δ Monolitico
Monolithic step
Monolitico
Monolitische Stufenplatte

Spessore . Thickness . Epaisseur . Stärke - 20 mm R11**Gres porcellanato colorato in massa.** Full-body coloured porcelain stoneware. Grès cérame coloré dans la masse. In der Masse gefärbtes Feinsteinzeug.**Pezzi speciali per esterno**

Special pieces for outdoor - Pièces spéciales pour extérieur - Formteile für Aussenbereich

* Gradone □ Nat. Ret. 40x120 16"x48"	* Ang. Gradone - SX □ Nat. Ret. 40x120 16"x48"	* Ang. Gradone - DX □ Nat. Ret. 40x120 16"x48"
SPESORE - THICKNESS - EPAISSEUR - STÄRKE	20 mm	20 mm

* Gradone grip □ Nat. Ret. 40x120 16"x48"	* Ang. Gradone grip - SX □ Nat. Ret. 40x120 16"x48"	* Ang. Gradone grip - DX □ Nat. Ret. 40x120 16"x48"
SPESORE - THICKNESS - EPAISSEUR - STÄRKE	20 mm	20 mm

* Elemento a L □ Nat. Ret. 33x120x4h 13"x48"x1 1/2h"	* Elemento a L SX □ Nat. Ret. 33x120x4h 13"x48"x1 1/2h"	* Elemento a L DX □ Nat. Ret. 33x120x4h 13"x48"x1 1/2h"
SPESORE - THICKNESS - EPAISSEUR - STÄRKE	20 mm	20 mm

*** piedino regolabile 25-30	*** piedino regolabile 30-37	*** piedino regolabile 37-50	*** piedino regolabile 50-75	*** piedino regolabile 75-125	*** piedino regolabile 125-225	*** prolunga piedini h 100 mm	chiave di regolazione
600101	600102	600103	600104	600105	600106	600107	600108
	20	20	20	20	20	20	1

* A disposizione solo su richiesta. Tempi di consegna 30 gg.
Available upon request only. Delivery terms: 30 days.
Disponible seulement sur requête. Délais de livraison: 30 jours.
Verfügbar auf Anfrage. Lieferzeit: 30 Tage.

*** Vendita a scatola completa.
Full box sale.
Vente à la boîte complète.
Volle Kartons.

□ Naturale e rettificato.
Natural and rectified.
Naturel et rectifié.
Natur Oberfläche und kalibriert.

▮ Costa retta.
Straight edge.
Bord droit.
Gerade Kante.

⤵ Costa toro.
Bullnose edge.
Bord boudin.
Abgerundete Kante.

Per le condizioni generali di vendita e le caratteristiche tecniche consultare www.tagina.it.
General terms and Sales conditions and Technical features are available on our website www.tagina.it.
Les Conditions général de vente et les Caractéristiques techniques sont disponibles sur le site web www.tagina.it.
Allgemeine Verkaufsbedingungen und technische Eigenschaften sind auf unsere Website verfügbar: www.tagina.it

Pezzi speciali per piscina

Special pieces for swimming pool - Pièces spéciales pour piscine - Formteile für Schwimmbad

* Gradone bordo piscina □ Nat. Ret. 40x120 16"x48"	* Ang. Gradone bordo piscina - SX □ Nat. Ret. 40x120 16"x48"	* Ang. Gradone bordo piscina - DX □ Nat. Ret. 40x120 16"x48"
SPESORE - THICKNESS - EPAISSEUR - STÄRKE	20 mm	20 mm

* Gradone grip bordo piscina □ Nat. Ret. 40x120 16"x48"	* Ang. Gradone grip bordo piscina - SX □ Nat. Ret. 40x120 16"x48"	* Ang. Gradone grip bordo piscina - DX □ Nat. Ret. 40x120 16"x48"
SPESORE - THICKNESS - EPAISSEUR - STÄRKE	20 mm	20 mm

* Gradone svasato bordo piscina □ Nat. Ret. 40x120 16"x48"	* Ang. Gradone svasato bordo piscina - SX □ Nat. Ret. 40x120 16"x48"	* Ang. Gradone svasato bordo piscina - DX □ Nat. Ret. 40x120 16"x48"
SPESORE - THICKNESS - EPAISSEUR - STÄRKE	20 mm	20 mm

* Griglia □ Nat. Ret. 20x60 8"x24"	* Griglia SX □ Nat. Ret. 20x60 8"x24"	* Griglia DX □ Nat. Ret. 20x60 8"x24"
SPESORE - THICKNESS - EPAISSEUR - STÄRKE	20 mm	20 mm

Per maggiori informazioni su imballi e codici articolo potete consultare il nostro BOOK (anche da sito internet, nell'area "download").
For more information on packaging and item codes, please refer to our BOOK (also available for download on our website, in the "download" area).
Pour plus d'informations sur les emballages et les codes articles, vous pouvez consulter notre BOOK (également depuis le site, dans la zone "téléchargement").
Weitere Informationen zu Verpackungen und Artikelcodes finden Sie in unserem BOOK (auch auf der Website, im Bereich "Download").

Tagina S.p.a. si riserva di modificare, senza alcun preavviso, il packaging dei prodotti, le grafiche, i colori e i decori riportati nelle immagini che sono pertanto da ritenersi indicative.
Tagina S.p.A. reserves the right to change the product packaging, the patterns, colours and decorations shown in the pictures without any prior notice. These aspects, therefore should be considered for illustrative purposes only.
Tagina S.p.A. se réserve le droit de modifier, sans préavis, l'emballage des produits, les graphismes, les couleurs et les décors représentés dans les images, fournies à titre indicatif.
Die Tagina S.p.A. behält sich vor, die Verpackung der Produkte, die in den Abbildungen gezeigten Grafiken, Farben und Dekors sowie ohne vorherige Ankündigung zu ändern.

PEZZI SPECIALI PER ESTERNO

Special pieces for outdoor
Pièces spéciales pour extérieur
Formteile für Aussenbereich

Elemento a L



Gradone grip

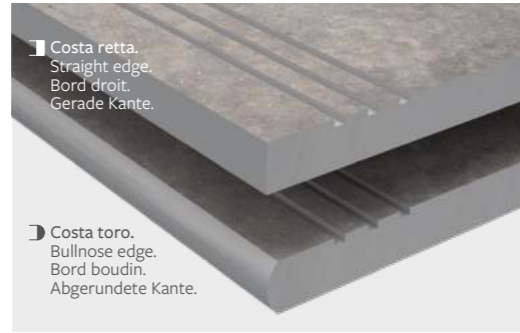

Gradone

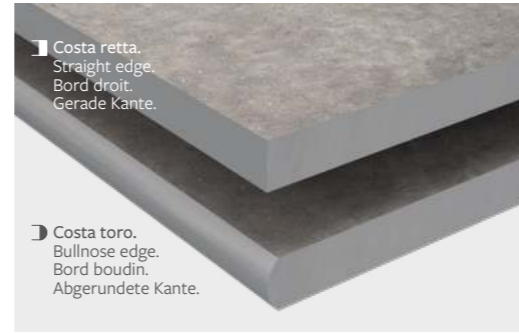

PEZZI SPECIALI PER PISCINA

Special pieces for swimming pool
Pièces spéciales pour piscine
Formteile für Schwimmbad

Gradone svasato bordo piscina



Gradone grip bordo piscina

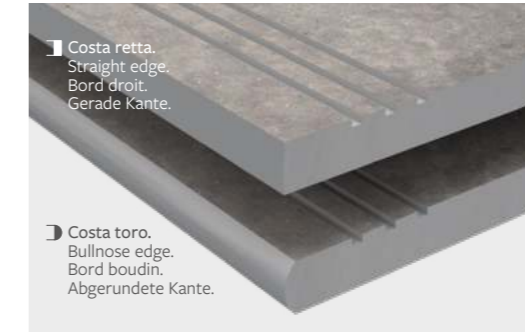

Gradone bordo piscina

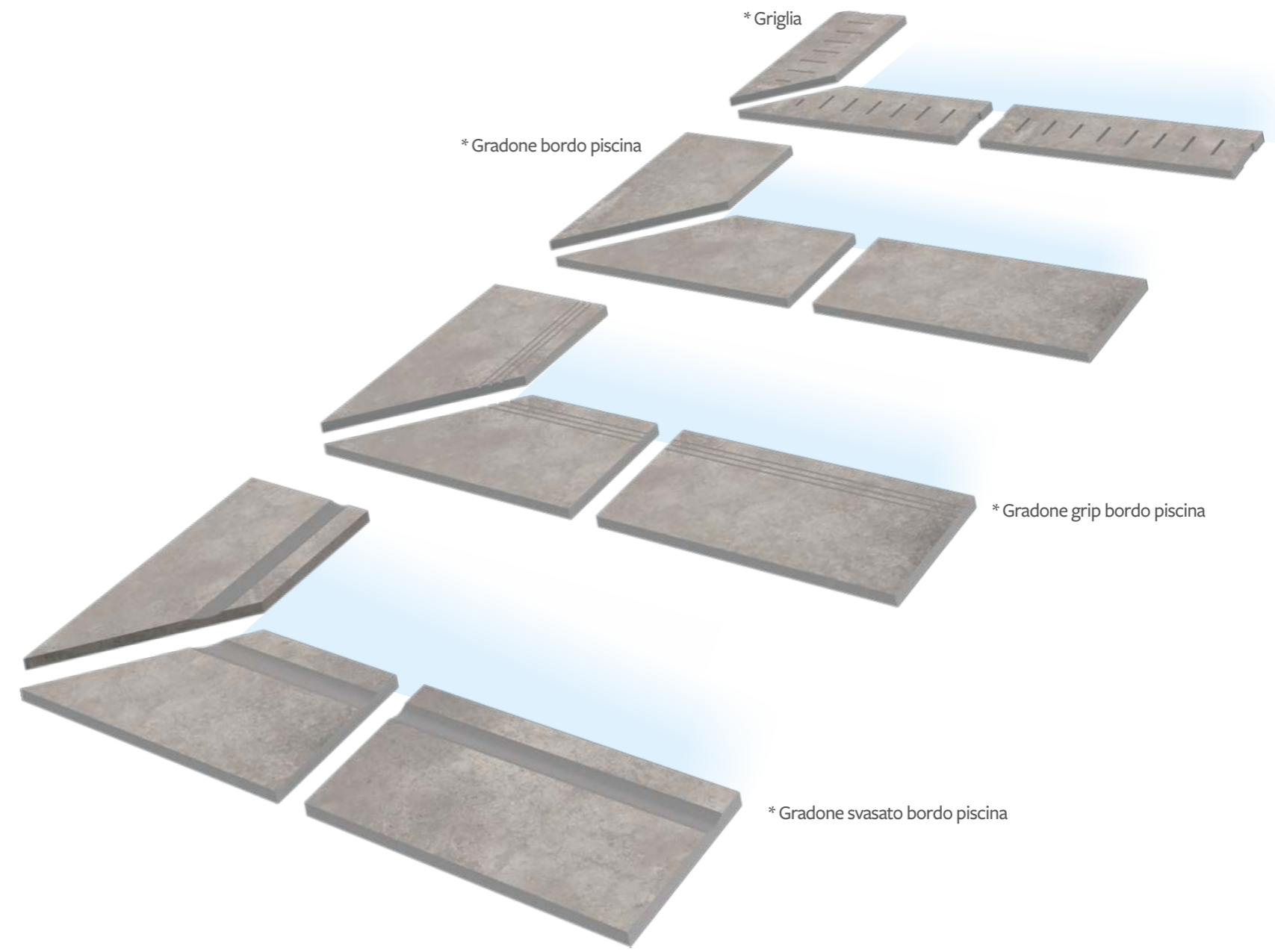
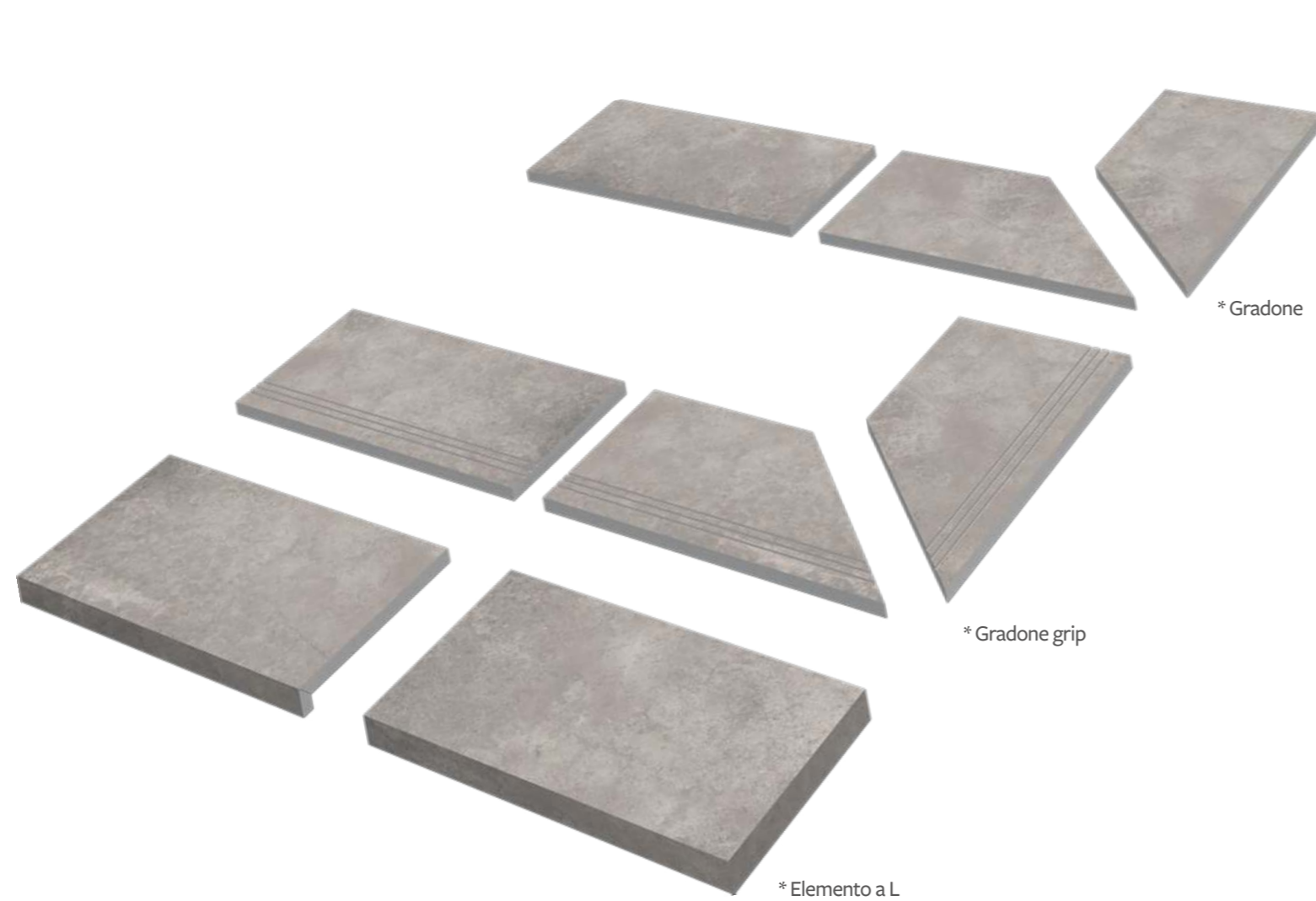
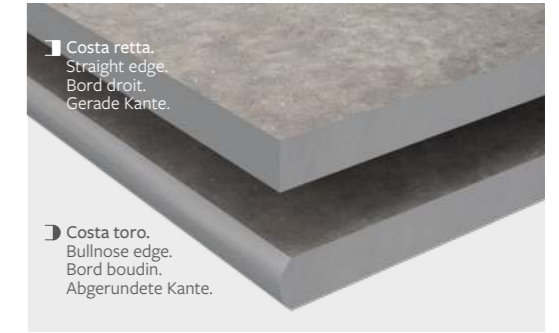

* I tempi di consegna di tutti i pezzi speciali mostrati in queste pagine sono di 30 giorni dalla data dell'ordine.
Delivery time for all the special pieces shown on these pages are generally 30 days from order date.
La livraison de toutes les pièces spéciales présentées dans les pages du catalogue sont disponible 30 jours à compter de la date de commande.
Der Liefertermin fuer die Spezialteile, die in dieser Seite aufgefuehrt sind, belaeuft sich auf 30 Tage nach Auftragseingang.



Tagina S.p.A.
Via Emilia Ponente, 925
48014 Castel Bolognese (RA) - Italy
Tel. +39 0545 197 7303

tagina.it -  **DAFIN** GROUP

