

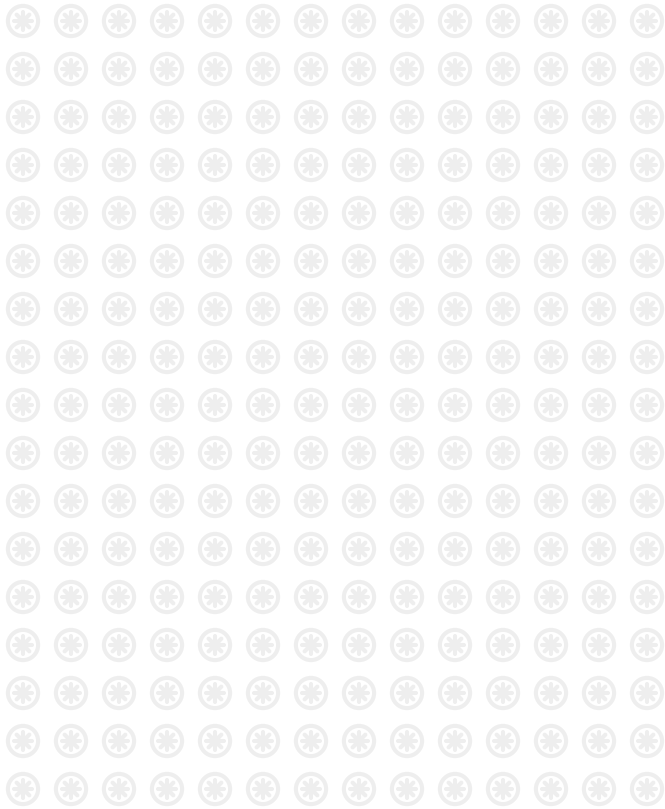

CONCRETE & DESIGN
COLLECTION



METAL



**Tagina**
ITALY'S BEST SURFACES

METAL

Una collezione segnata dal tempo dove corrosione ed ossidazione entrano in scena donando alle lastre metalliche una personalità sempre varia ed originale. **METAL** si declina nei colori Pearl, Iron, Corten, Oxide, Titanium, in tre spessori, nei formati 120x280, 120x120, 60x120 cm. Grazie anche alla finitura R11 per outdoor **METAL** crea continuità cromatica con ambienti indoor.

A collection marked by time where corrosion and oxidation take the stage, giving the metal sheets an always varied and original personality. **METAL** is available in the colours Pearl, Iron, Corten, Oxide, Titanium, in three thicknesses and in the sizes 120x280, 120x120, 60x120 cm. Thanks also to the outdoor R11 finish, **METAL** creates chromatic continuity with indoor environments.

Une collection marquée par le temps, où la corrosion et l'oxydation occupent une place centrale, conférant aux dalles métalliques une personnalité originale et changeante. **METAL** se décline dans les couleurs Pearl, Iron, Corten, Oxide et Titanium, en trois épaisseurs et dans les dimensions 120x280, 120x120 et 60x120 cm. Grâce également à la finition R11 pour l'extérieur, **METAL** crée une continuité chromatique avec les environnements intérieurs.

Eine von der Zeit geprägte Kollektion, in der Korrosion und Oxidation zum tragenden Element werden und den Metallplatten eine vielfältige und originelle Persönlichkeit verleihen. **METAL** ist in den Farben Pearl, Iron, Corten, Oxide, Titanium, in drei Stärken und in den Formaten 120x280, 120x120, 60x120 cm erhältlich. Auch dank der R11-Oberfläche für den Außenbereich schafft **METAL** eine farbliche Kontinuität mit Innenräumen.

100% Made in Italy

INDOOR
PAVIMENTO . FLOOR: IRON 120x120 Nat. Ret.
BANCONE . COUNTER: Collection MARQUINA NERO 120x280 Lucidato Ret.

OUTDOOR
PAVIMENTO . FLOOR: IRON 60x120 20 mm Nat. Ret. R11







SCALA . STAIRS: TITANIUM 120x120 Nat. Ret.
Coprispigo triangolare TITANIUM 0,8x120 Nat. Ret.
PAVIMENTO . FLOOR: TITANIUM 120x120 Nat. Ret.



SCALA . STAIRS: TITANIUM 60x120 Nat. Ret.
Coprispigo triangolare TITANIUM 1,4x120 Nat. Ret.
PAVIMENTO E RIVESTIMENTO . FLOOR AND WALL: CORTEN 60x120 Nat. Ret.







MUSEUM



IRON 60x120 20 mm Nat. Ret. R11

Special pieces for swimming pool:

IRON GRIGLIA + ANG. 20x60 20 mm Nat. Ret. R11

IRON GRADONE GRIP BORDO PISCINA + ANG. 30x120 20 mm Nat. Ret. R11





METAL

Ogni collezione Tagina rivela la massima cura e una sensibilità artistica raffinata capace di riprodurre la più intima essenza estetica della materia.

Colori e trame ricercate si sommano a caratteristiche tecniche di massima qualità grazie alle tecnologie produttive più avanzate.

Una superficie Tagina è garanzia di eccellenza e prestigio in ogni genere di spazio legato a emozioni inalterabili nel tempo.

Every Tagina collection shows the utmost attention to detail and a sophisticated artistic sensitivity that reproduces the most intimate aesthetic essence of the material. Refined colours and textures combine with the highest-quality technical characteristics thanks to the most advanced manufacturing technologies.

A Tagina surface is a guarantee of excellence and prestige in any kind of environment connected to emotions impervious to time.

Chaque collection Tagina révèle un soin maximal et une sensibilité artistique raffinée capable de reproduire l'essence esthétique la plus intime de la matière.

Couleurs et motifs recherchés s'ajoutent à des caractéristiques techniques d'une qualité maximale grâce aux technologies de production les plus avancées.

Une surface Tagina est une garantie d'excellence et de prestige dans tous les types d'espace lié à des émotions inaltérables dans le temps.

Jede Tagina-Kollektion zeugt von größter Sorgfalt und einem raffinierten künstlerischen Gespür, das die intimste ästhetische Essenz des Materials wiederzugeben vermag. Raffinierte Farben und Texturen ergänzen sich durch modernste Produktionstechnologien mit hochwertigen technischen Eigenschaften.

Eine Oberfläche von Tagina ist eine Garantie für Exzellenz und Wertigkeit in jeder Art von Raum, verbunden mit dauerhaften Emotionen.



PEARL



IRON



CORTEN



OXIDE

TITANIUM

FORMATI
 Sizes / Formats / Formate

6,5 mm . 120x280 - 48"x110" / 120x120 - 48"x48"
10 mm . 60x120 - 24"x48"
20 mm R11. 60x120 - 24"x48"

GRANDI VARIETÀ DI GRAFICHE

Wide variety of graphics / Grande variété des graphismes / Große Vielfalt der Graphiken



Ambienti unici e originali grazie ad una grande varietà di grafiche.
 The greatly varying patterns featured result in unique and original interiors.
 Des espaces uniques et originaux grâce à une grande variété de graphismes.
 Einzigartige und originelle Räume dank einer großen Vielfalt von Grafiken.

Il numero delle grafiche può variare rispetto a quanto riportato e può essere differente tra i vari formati e/o colori.
 The number of the patterns may differ from that shown herewith and may also vary depending on the selected size and/or colour.
 Le nombre de graphismes peut varier par rapport à ce qui est reporté et il peut varier suivant les différents formats et/ou couleurs.
 Die Anzahl der Grafiken kann von den Angaben abweichen und zwischen den verschiedenen Formaten und/oder Farben unterschiedlich sein.

COLORI

Colours / Couleurs / Farben



PEARL



IRON



CORTEN



OXIDE



TITANIUM

Spessore . Thickness . Epaisseur . Stärke - 6,5 mm

Lastre in gres porcellanato pressate a secco. Dry-pressed porcelain stoneware slabs. Dalles en grès cérame pressées à sec. Trocken gepresste Platten aus Feinsteinzeug.

Spessore . Thickness . Epaisseur . Stärke - 10 mm - 20 mm R11

Gres porcellanato colorato in massa. Full-body coloured porcelain stoneware. Grès cérame coloré dans la masse. In der Masse gefärbtes Feinsteinzeug.

INDOOR - OUTDOOR

TABELLA RIEPILOGATIVA
Summary table
Tableau récapitulatif
Zusammenfassende Tabelle

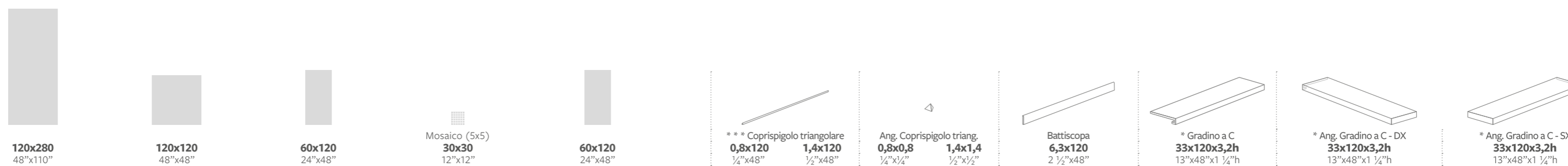

Spessore - Thickness - Epaisseur - Stärke		6,5 mm	6,5 mm	10 mm	10 mm	20 mm R11	6,5 mm	10 mm	6,5 mm	10 mm	10 mm	10 mm	10 mm	10 mm	10 mm	
	PEARL <input type="checkbox"/> Nat. Ret.	124040	124070	124090	124250	-	124400	124410	124420	124430	124200	124300	124310	124320	124320	
	IRON <input type="checkbox"/> Nat. Ret.	124042	124072	124091	124251	124097	124401	124411	124421	124431	124201	124301	124311	124321	124321	
	CORTEN <input type="checkbox"/> Nat. Ret.	124043	124073	124092	124252	124098	124402	124412	124422	124432	124202	124302	124312	124322	124322	
	OXIDE <input type="checkbox"/> Nat. Ret.	124041	124071	124093	124253	124099	124403	124413	124423	124433	124203	124303	124313	124323	124323	
	TITANIUM <input type="checkbox"/> Nat. Ret.	124044	124074	124094	124254	124100	124404	124414	124424	124434	124204	124304	124314	124324	124324	
MQ x pezzo - Sqm x pcs		3,36														
Kg x pezzo - Kg x pcs		53														
		Cassa Crate 292x145x34h		Pallet speciale Special pallet 122x143		Pallet 80x120		Pallet 80x120		Pallet 80x120		Pallet 80x120		Pallet 80x120		Pallet 80x120
N°		18														
m²		60,48														
** Kg		1150														
			2	2	11	1	6	6			9	2	1	1		
m² x			2,88	1,44	0,99	0,72										
Kg x			45,5	33,2	20	33,2	1,2	2			11	23	11,5	11,5		
			24	30	30	30										
m² x			69,12	43,2	21,6	21,6										
** Kg x			1145	1016	1016	1016										
h x			65	74	74	74										
Imballo (tara) - Packaging (tare)		(90)	(53)	(20)	(20)	(20)					(20)	(20)	(20)	(20)	(20)	(20)
		Cavalletto A-Frame														
N°		44														
m²		147,84														
** Kg		2344														
Imballo (tara) - Packaging (tare)		(205)														

I pesi riportati in tabella sono indicativi e potrebbero essere soggetti a leggere variazioni.
The weights stated in the chart may undergo slight changes for production reasons.
Les poids indiqués dans le tableau peuvent subir de légères variations pour des raisons de production.
Die in der Tabelle angegebenen Gewichte können aus Produktionsgründen geringfügigen Abweichungen unterliegen.

Non si garantisce l'abbinabilità tra fondi di spessori diversi e tra fondo e pezzo speciale.
It is not guaranteed that background tiles with different thicknesses can be used together, nor is it guaranteed for background tiles and trims.
Nous ne garantissons pas la possibilité de combiner des carrelages de sol de différentes épaisseurs et un carrelage de sol avec une pièce spéciale.
Die Kombinierbarkeit von Fliesen unterschiedlicher Stärke sowie zwischen Fliese und Formteil kann nicht garantiert werden.

Le misure delle casse, dei cavalletti e dei pallet speciali sono indicativi e possono cambiare tra una fornitura e l'altra anche nel medesimo articolo.
The sizes of our crates, A-frames and special pallets are approximate and may vary from one supply to the next, even in the case of the same item being supplied.
Les mesures des caisses, des chevalets, des palettes spéciales sont indicatives et ils peuvent changer d'une fourniture à l'autre aussi dans le même article.
Die Maße der Kästen, Böcke und Spezialpaletten dienen lediglich als Richtmaße und können sich auch im selben Artikel von einer Lieferung zur anderen ändern.

* A disposizione solo su richiesta. Tempi di consegna 30 gg.
Available upon request only. Delivery terms: 30 days.
Disponibile seulement sur requête. Délais de livraison: 30 jours.
Verfügbar auf Anfrage. Lieferzeit: 30 Tage.

** Il peso è comprensivo dell'imballo.
The total weight includes the packaging.
Le poids comprend aussi l'emballage.
Das Gesamtgewicht enthält auch die Verpackung.

*** Vendita a scatola completa.
Full box sale.
Vente à la boîte complète.
Volle Kartons.

Naturale e rettificato.
Natural and rectified.
Naturel et rectifié.
Natur Oberfläche und kalibriert.

Spessore . Thickness . Epaisseur . Stärke - 20 mm R11

Gres porcellanato colorato in massa. Full-body coloured porcelain stoneware. Grès cérame coloré dans la masse. In der Masse gefärbtes Feinsteinzeug.

Pezzi speciali per esterno



Special pieces for outdoor - Pièces spéciales pour extérieur - Formteile für Aussenbereich

Disponibili nei colori Iron, Corten , Oxide e Titanium

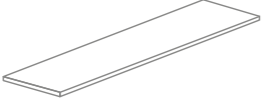
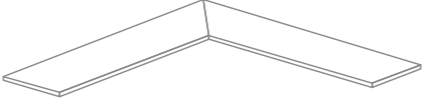
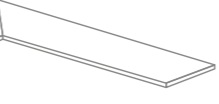
Available in Iron, Corten, Oxide and Titanium colours - Disponible dans les couleurs Iron, Corten, Oxide et Titanium - Verfügbar in den Farben Iron, Corten, Oxide und Titanium

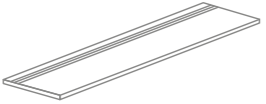
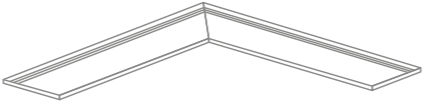
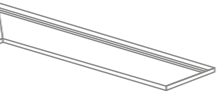
		
* Gradone □ Nat. Ret. 30x120 12"x48"	* Ang. Gradone - SX □ Nat. Ret. 30x120 12"x48"	* Ang. Gradone - DX □ Nat. Ret. 30x120 12"x48"
20 mm	20 mm	20 mm

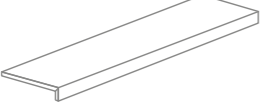
		
* Gradone grip □ Nat. Ret. 30x120 12"x48"	* Ang. Gradone grip - SX □ Nat. Ret. 30x120 12"x48"	* Ang. Gradone grip - DX □ Nat. Ret. 30x120 12"x48"
20 mm	20 mm	20 mm

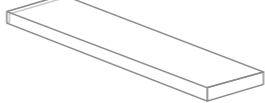
		
* Elemento a L □ Nat. Ret. 33x120x4h 13"x48"x1 1/2"h	* Elemento a L SX □ Nat. Ret. 33x120x4h 13"x48"x1 1/2"h	* Elemento a L DX □ Nat. Ret. 33x120x4h 13"x48"x1 1/2"h
20 mm	20 mm	20 mm

							
*** piedino regolabile 25-30	*** piedino regolabile 30-37	*** piedino regolabile 37-50	*** piedino regolabile 50-75	*** piedino regolabile 75-125	*** piedino regolabile 125-225	*** prolunga piedini h 100 mm	chiave di regolazione
600101	600102	600103	600104	600105	600106	600107	600108
	20	20	20	20	20	20	1

* A disposizione solo su richiesta. Tempi di consegna 30 gg.
Available upon request only. Delivery terms: 30 days.
Disponible seulement sur requête. Délais de livraison: 30 jours.
Verfügbar auf Anfrage. Lieferzeit: 30 Tage.

*** Vendita a scatola completa.
Full box sale.
Vente à la boîte complète.
Volle Kartons.

□ Naturale e rettificato.
Natural and rectified.
Naturel et rectifié.
Natur Oberfläche und kalibriert.

▮ Costa retta.
Straight edge.
Bord droit.
Gerade Kante.

▮ Costa toro.
Bullnose edge.
Bord boudin.
Abgerundete Kante.

Pezzi speciali per piscina



Special pieces for swimming pool - Pièces spéciales pour piscine - Formteile für Schwimmbad

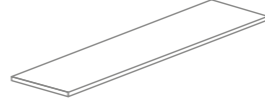
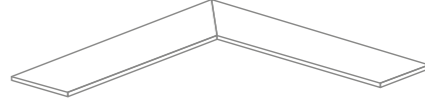
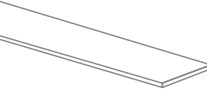

Disponibili nei colori Iron, Corten , Oxide e Titanium

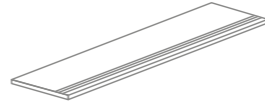
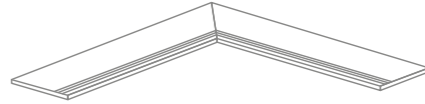
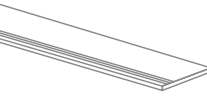
Available in Iron, Corten, Oxide and Titanium colours - Disponible dans les couleurs Iron, Corten, Oxide et Titanium - Verfügbar in den Farben Iron, Corten, Oxide und Titanium

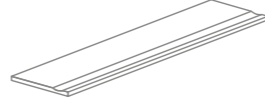
		
* Gradone bordo piscina □ Nat. Ret. 30x120 12"x48"	* Ang. Gradone bordo piscina - SX □ Nat. Ret. 30x120 12"x48"	* Ang. Gradone bordo piscina - DX □ Nat. Ret. 30x120 12"x48"
20 mm	20 mm	20 mm

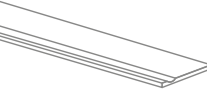
		
* Gradone grip bordo piscina □ Nat. Ret. 30x120 12"x48"	* Ang. Gradone grip bordo piscina - SX □ Nat. Ret. 30x120 12"x48"	* Ang. Gradone grip bordo piscina - DX □ Nat. Ret. 30x120 12"x48"
20 mm	20 mm	20 mm

		
* Gradone svasato bordo piscina □ Nat. Ret. 30x120 12"x48"	* Ang. Gradone svasato bordo piscina - SX □ Nat. Ret. 30x120 12"x48"	* Ang. Gradone svasato bordo piscina - DX □ Nat. Ret. 30x120 12"x48"
20 mm	20 mm	20 mm

		
* Griglia □ Nat. Ret. 20x60 8"x24"	* Griglia SX □ Nat. Ret. 20x60 8"x24"	* Griglia DX □ Nat. Ret. 20x60 8"x24"
20 mm	20 mm	20 mm

Per maggiori informazioni su imballi e codici articolo potete consultare il nostro BOOK (anche da sito internet, nell'area "download").
For more information on packaging and item codes, please refer to our BOOK (also available for download on our website, in the "download" area).
Pour plus d'informations sur les emballages et les codes articles, vous pouvez consulter notre BOOK (également depuis le site, dans la zone "téléchargement").
Weitere Informationen zu Verpackungen und Artikelcodes finden Sie in unserem BOOK (auch auf der Website, im Bereich "Download").

PEZZI SPECIALI PER ESTERNO

Special pieces for outdoor
Pièces spéciales pour extérieur
Formteile für Aussenbereich

Elemento a L



Gradone grip

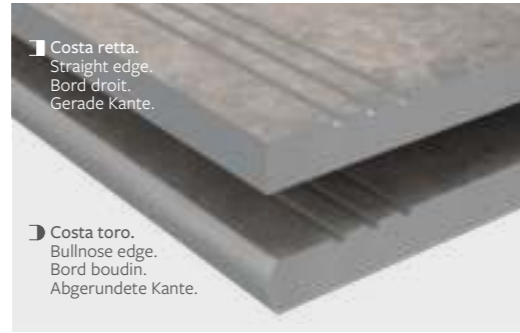

Gradone

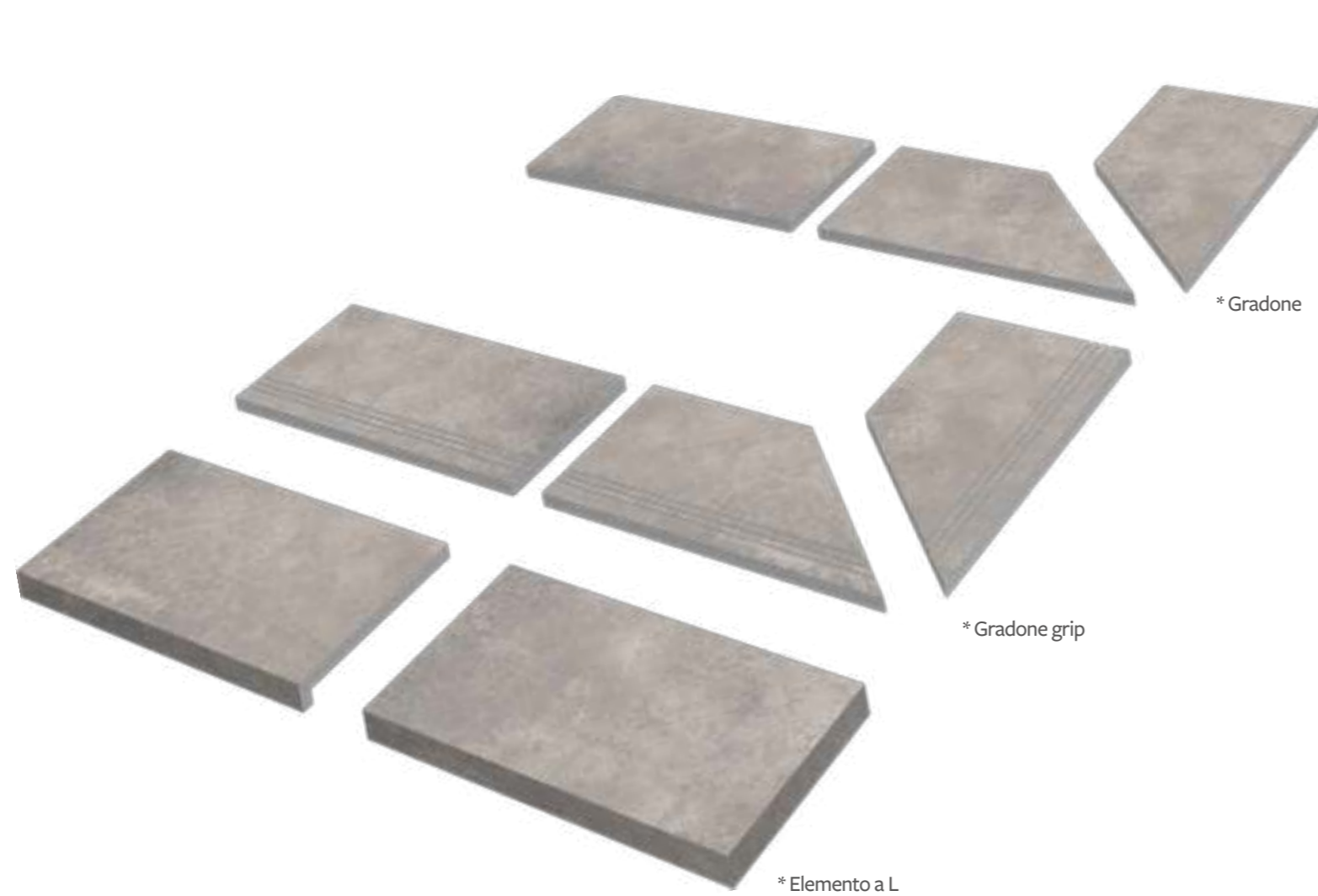

PEZZI SPECIALI PER PISCINA

Special pieces for swimming pool
Pièces spéciales pour piscine
Formteile für Schwimmbad

Gradone svasato bordo piscina



Gradone grip bordo piscina

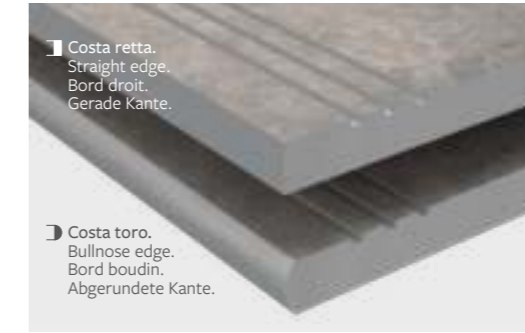

Gradone bordo piscina

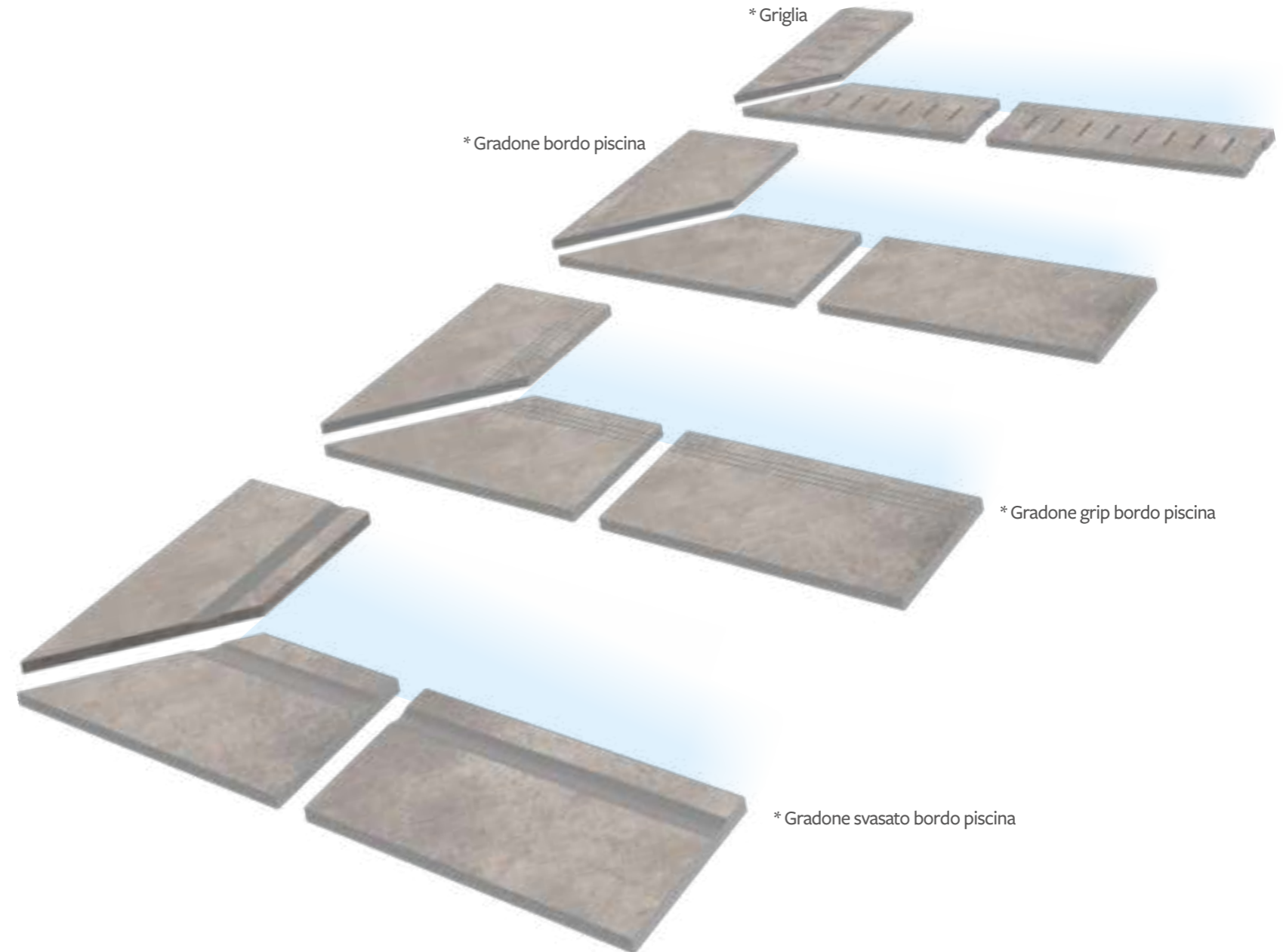

Per le condizioni generali di vendita e le caratteristiche tecniche consultare www.tagina.it
General terms and Sales conditions and Technical features are available on our website www.tagina.it
Les Conditions général de vente et les Caractéristiques techniques sont disponibles sur le site web www.tagina.it
Allgemeine Verkaufsbedingungen und technische Eigenschaften sind auf unsere Website verfügbar: www.tagina.it

* I tempi di consegna di tutti i pezzi speciali mostrati in queste pagine sono di 30 giorni dalla data dell'ordine.
Delivery time for all the special pieces shown on these pages are generally 30 days from order date.
La livraison de toutes les pièces spéciales présentés dans les pages du catalogue sont disponible 30 jours à compter de la date de commande.
Der Liefertermin fuer die Spezialteile, die in dieser Seite aufgeführt sind, beläuft sich auf 30 Tage nach Auftragseingang.

Tagina S.p.A. si riserva di modificare, senza alcun preavviso, il packaging dei prodotti, le grafiche, i colori e i decori riportati nelle immagini che sono pertanto da ritenersi indicative.
Tagina S.p.A. reserves the right to change the product packaging, the patterns, colours and decorations shown in the pictures without any prior notice. These aspects, therefore should be considered for illustrative purposes only.
Tagina S.p.A. se réserve le droit de modifier, sans préavis, l'emballage des produits, les graphismes, les couleurs et les décors représentés dans les images, fournies à titre indicatif.
Die Tagina S.p.A. behält sich vor, die Verpackung der Produkte, die in den Abbildungen gezeigten Grafiken, Farben und Dekors sowie ohne vorherige Ankündigung zu ändern.

Pezzi speciali: massima cura in ogni dettaglio

Special pieces: the utmost care in every detail.
Pièces spéciales : le soin maximal dans le moindre détail.
Formteile: maximale Sorgfalt in jedem Detail.



Il fascino tradizionale del gradino a "C"

The traditional appeal of the "C" step.
Le charme traditionnel de l'étape « C ».
Der traditionelle Charme der „C“-Stufe.

Tagina pone attenzione a tutte le componenti architettoniche degli spazi da abitare. Ai gradini sono dedicati pezzi speciali appositamente progettati per ottenere il massimo risultato estetico. La gamma comprende un elemento "gradino a C" al quale si possono affiancare gli elementi che completano gli angoli sinistro e destro.

Tagina takes great care over all the architectural elements of the living spaces. Special pieces are used for the stairs, specially designed to obtain the maximum aesthetic result. The range includes a "C-step" element which can be combined with the elements that complete the left and right corners.

Tagina prête attention à toutes les composantes architecturales des espaces de vie. Les étapes sont dédiées à des pièces spéciales spécialement conçues pour obtenir un résultat esthétique maximal. La gamme comprend un élément « marche en C » auquel vous pouvez assortir les autres éléments qui complètent les angles gauche et droit.

Tagina achtet auf alle architektonischen Komponenten der Wohnräume. Den Stufen sind Spezialteile gewidmet, um ein optimales ästhetisches Ergebnis zu erzielen. Das Sortiment umfasst ein „C-Stufen-Element“, das durch Elemente zur Vervollständigung der linken und rechten Ecke ergänzt werden kann.

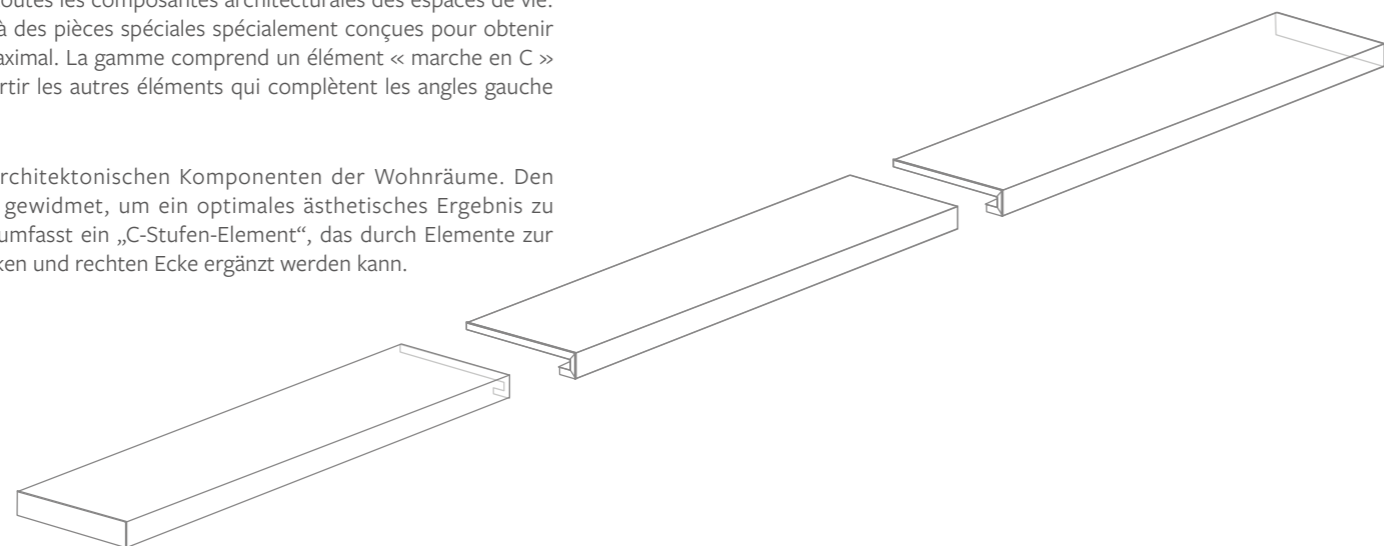

Il "coprispigolo triangolare"

The "triangular edge cover".
Le « cache-arête triangulaire ».
„Dreieckiger Kantenschutz“.

La gamma Tagina include gli elementi "Coprispigolo triangolare" e l'"Angolo Coprispigolo triangolare". Essi consentono di risolvere con eleganza e semplicità problematiche legate alla congiunzione delle lastre in presenza di spigoli e angoli. È possibile adottare questa soluzione sia a rivestimento che a pavimento ad esempio per realizzare gradini o per comporre volumi geometrici.

The range of Tagina includes the "Triangular edge cover and triangular corner edge cover" elements. They allow problems encountered to be solved elegantly and simply when joining slabs where there are edges and corners. It is possible to adopt this solution both for cladding and flooring, e.g. to create steps or compose geometric volumes.

La gamme Tagina comprend les éléments « Cache-arête triangulaire et Angle Cache-arête Triangulaire ». Ils permettent de résoudre avec élégance et simplicité les problèmes liés à l'assemblage des dalles en présence de bords et de coins. Il est possible d'adopter cette solution aussi bien pour le revêtement que pour le dallage, par exemple pour créer des marches ou composer des volumes géométriques.

Das Sortiment Tagina umfasst das Element „Dreieckiger Kantenschutz und Dreieckige Eckabdeckung“. Beide Elemente ermöglichen, mit Eleganz und Einfachheit alle Probleme zu lösen, die mit dem Zusammenfügen der Platten bei Vorhandensein von Kanten und Ecken zusammenhängen. Diese Lösung kann sowohl für Verkleidungen als auch für Böden verwendet werden, beispielsweise um Stufen oder geometrische Volumen zu schaffen.



Suggerimenti per abbinare colori e stili Tagina

Tips for Matching Colours and Tagina Styles.

Conseils pour faire correspondre les couleurs et les styles Tagina.

Tipps für die Kombination von Tagina-Farben und -Stilen.



PAVIMENTO . FLOOR: IRON 120x120 Nat. Ret.
BANCONI . COUNTER: Collection MARQUINA NERO 120x280 Lucidato Ret.

MARBLE & ONYX

METAL PATAGONIA

PEARL

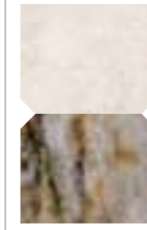

CAFFÈ

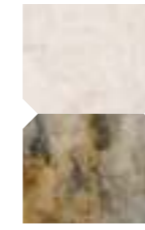

ZAFFIRO

IRON

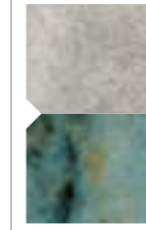

TURCHESE

CORTEN

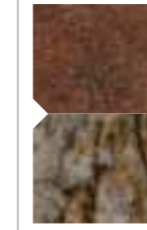

CAFFÈ



TURCHESE

OXIDE



CASHMERE



BIANCO

TITANIUM

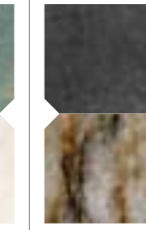

CAFFÈ



CASHMERE

CONCRETE & DESIGN

METAL CONCRETA

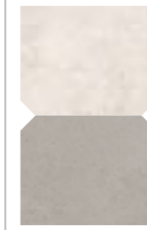

GRIGIO CHIARO



TERRA



TERRA



GRIGIO SCURO



GRIGIO CHIARO



GRIGIO SCURO



TERRA



GRIGIO SCURO



TERRA



GRIGIO SCURO

METAL APOGEO



ANTHRACITE



BLACK



BLACK



WHITE

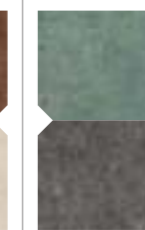

BLACK



WHITE



GREY



WHITE

METAL FULL COLOURS

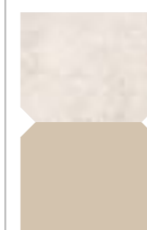

DESERT



SHADOW



SHADOW



MIDNIGHT



SHADOW



MIDNIGHT



CLOUD



SHADOW



DESERT



MOON

STONE & CLASSIC

METAL MEDITERRANEA



DOR



BYBLOS



DOR



MENFI



BYBLOS



ERICE



MENFI

DECORS

METAL FOREST

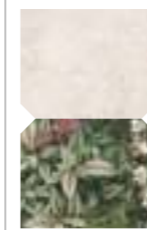

FOREST

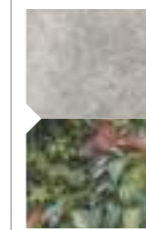

FOREST

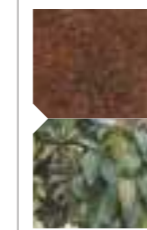

FOREST



FOREST

METAL GARDENS

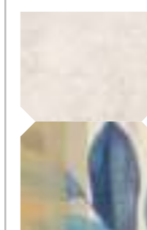

GIALLO



VIOLA



ROSA

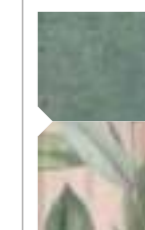

ROSA



ROSA

Colore consigliato per la Fuga
Recommended joint colour.
Couleur d'échappement recommandée.
Empfohlene Farbe für die Fuge.

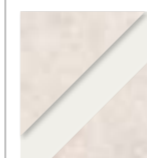

RAL 9016
NCS 0510-R



RAL 7047
NCS S 2000-N



RAL 8019
NCS 8005-Y80R

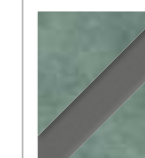

RAL 7005
NCS 5502-B



RAL 7022
NCS 8005-G20Y



Tagina S.p.A.
Via Emilia Ponente, 925
48014 Castel Bolognese (RA) - Italy
Tel. +39 0545 197 7303

tagina.it -  DAFIN GROUP

