

# HPC FIRE INSPIRED DEALER CATALOG

OUTDOOR • INDOOR • OUTDOOR DINING

2022-2023



FIRE INSPIRED

Inspired by Safety  
Innovated for your Lifestyle



C US



# GREETINGS AND WELCOME

Welcome to our newest edition of the HPC Outdoor Product Dealer Catalog. Team HPC Fire Inspired truly appreciates your business. We are so grateful for the trust you have placed in us. Our goal is to make your experience as easy and seamless as possible. We believe that customer service is not just a department, but rather it is the heart and soul of the entire company. Every team member plays an active role servicing and breathing life into the orders. HPC creates innovative and safe designs suited for our customers' lifestyles. Our designs are built to last; leaving a mark on the industry as a leader for interweaving quality, safety and technology in every appliance.

HPC stands by our designs ensuring that they will last the test of time.

We are excited to highlight the following new programs to support our mutually beneficial growth aspirations:

1. Over 400 CSA certified appliances guaranteed for top performance
2. Lifetime Warranty on burners
3. CAD details/3D models
4. Dealer Portal
5. New HPC One App- Page 8
6. SST Torpedo Burner yielding the biggest CSA Certified flame on the Market- Page 8
8. HPC Hybrid Forno de Pizza Oven-Page 6

On behalf of all the team at HPC, I would like to thank you all for your continued support. Cheers to a successful and prosperous year of making memorable moments!



All the Best!

Sean Steimle, Chief Executive Officer

## CONTACT



FIRE INSPIRED®

**2225 Lyons Road**  
**Miamisburg, OH 45342**  
**Phone: 877.433.7001**  
**Fax: 877.433.0704**

Email: [orders@hpcfire.com](mailto:orders@hpcfire.com)

**[www.hpcfire.com](http://www.hpcfire.com)**

Printed March 2022

## COVER PHOTO

Courtesy of Site Group

## WHAT DOES MAP MEAN?

Throughout this Dealer Catalog, you will see the acronym MAP. This stands for Minimum Advertised Price, and it's a policy that HPC Fire Inspired™ applies to nearly all our products. Quite simply, this MAP Policy prevents any trade partner from advertising our products at prices below those specified by HPC Fire Inspired™.

**MAP**  
**APPLIES**

## TERMS AND CONDITIONS

### Revision and Modifications of the Agreement

HPC Fire Inspired™ may by its sole discretion, modify or revise the terms of use and policies at any time as it may deem necessary. By agreeing to the terms of use herein you are bound by any such modifications or changes. It should be noted that nothing specified on these terms of use shall be used to confer any third-party rights and benefits.

### Intellectual Property Rights

It is assumed that by using HPC Fire Inspired™ you agree that all content such as photos, text, graphics are copyrights with the copyrights being owned exclusively by HPC Fire Inspired™. You are however allowed to print hard copies of the content for the sole purpose of placing an order.

**For the updated Terms and Conditions please go to [hpcfire.com/terms-and-conditions](http://hpcfire.com/terms-and-conditions)**



## WARRANTY POLICY

Components	Application	
	Residential	Commercial
<b>Outdoor Fire Components</b>		
Fire Pit Stainless Steel Burners	Lifetime	Lifetime
Outdoor Fireplace Burner & Pan	Lifetime	Lifetime
Electronic Components and Gas Valves	3 years	1 year
Pilot Assembly	2 years	1 year
Stainless Steel Components	5 year	1 year
Cold Rolled Steel Components	1 year	6 months
Flex Lines	5 years	1 year
Regulators	3 years	1 year
Outdoor Logs	3 years	3 years
Unfinished Fire Pit Enclosure	5 years	5 years
Copper Bowl Series (Normal Weathering Expected)	1 year	1 year
Aluminum Fire Pit Covers	3 years	3 years
Vinyl Fire Pit Covers	3 years	3 years
Aluminum Bowl	1 year	1 year
Sport Pit	1 year	1 year
<b>Evolution360™ &amp; H2Onfire Series</b>		
Polyethylene Basin and Liner	3 years	3 year
Water Pump	2 years	1 year
Float and Sensor	2 years	1 year
Hose and Fittings	2 years	2 years
Electronics and LEDs	2 years	1 year

Inspired by safety. Innovated for your lifestyle.

## INTRO

- 2 Greetings
- 3 Table of Contents
- 4 Dealer Incentive Program
- 5 Engineered to Order
- 6 **Forno de Pizza**
- 8 HPC Fire One App

## FIRE PIT INSERTS

- 9 HPC University
- 11 **Fire Pit Matrix**
- 12 Round Fire Pit Bowl
- 14 Round Flat Fire Pit Pan
- 16 Square Fire Pit Bowl
- 18 Square Flat Fire Pit Pan
- 20 Rectangle H-Burner
- 22 Linear Trough Insert
- 24 Linear Interlink Inserts

## FIREPLACE BURNERS

- 26 Dual Step
- 27 Linear

## RTF PACKAGES

- 28 Round
- 29 Octagon
- 29 Square
- 30 Rectangle Interlink
- 30 Rectangle Trough
- 31 Rectangle H-Fire
- 32 Small Tank Units

## TK TORCH, COPPER, SPORT PIT, FIRE & WATER

- 33 TK Torch
- 34 Mesa
- 35 Sedona
- 35 Tempe
- 36 Sierra
- 36 Phoenix H-Burner
- 37 Phoenix Trough
- 38 Sport Pit
- 39 Aluminum Spun Bowls
- 40 Evolution 360
- 41 H2Onfire

## ACCESSORIES

- 42 Concrete Fire Logs
- 43 Lava and Ceramic Rock
- 44 Fire Glass
- 45 Wind Guards
- 46 Fire Pit Covers
- 47 Covers/Doors/Vents
- 48 Deck Install/Paver Block
- 49 Hardscape Block Kit

## COMPONENTS

- 50 Burner Kits-(FPS)
- 52 Pro Flex Lines
- 52 Flex Lines
- 53 Fire Pit Pans
- 53 Regulators
- 53 Grill Regulators and Hose
- 53 Push Button-(FPK)
- 54 Decorative Key Valves
- 55 Flame Control Systems
- 55 EI Accessories
- 56 Burners-(FRS)
- 58 Log Lighters
- 59 Replacement Components

## POINT OF PURCHASE INDOOR

- 62 Literature
- 62 Display Stands

**ACCESSORIES CHART IS ON PAGES 60 AND 61 OF THIS BOOK**

- 63 Full Indoor Catalog

# DEALER INCENTIVE PROGRAM

## LOCKED-IN INCENTIVE PRICING STRUCTURE FOR AN ENTIRE YEAR:

When your yearly sales orders meet one of our incentive levels your price structure is locked in for a full calendar year. For more information go to [hpcfire.com/dealer](http://hpcfire.com/dealer).

## ONLINE ORDER FULFILLMENT:

HPC offers a searchable online ordering site through the HPC Dealer Portal Store.[hpcfire.com](http://hpcfire.com).

## NEW PRODUCT DEVELOPMENT INPUT:

All dealers are encouraged to provide input on new product development.



## HOW WE BEAT MOTHER NATURE

There's no two ways about it, outdoor gas fire pits face a double-barrel assault from wind and rain. HPC designs its products making sure our fire pits function effectively and safely in the field. For example:

- The Penta Burner sheds rain water in several ways. Each of the five lobes have "weep holes" that drain water. Also, the hub in the center of the burner is sealed to prevent water leaking into the burner.
- HPC's Electronic Ignition models all include a "drip leg" that diverts any water away from the electronics.
- In the face of wind, HPC's Electronic Ignition and Push Button/Flame Sensing models all are equipped with a thermocouple sensor that will shut off the gas supply if the flame is extinguished. In addition, HPC's metal "blow-out-box" acts as an added layer of protection shielding the pilot flame from the elements.

- HPC installs "spider guards" on all CSA-Certified fire pit inserts. The mesh guard deters spiders from nesting in the unit keeping your appliance free from any obstruction.
- HPC offers standard as well as custom covers protecting your design while not in use.



## HPC'S VISION STATEMENT

To provide safe, innovative outdoor living solutions that create memorable moments.

# ENGINEERED TO ORDER WITH CSA CERTIFICATION

**HPC HAS WORKED CLOSELY WITH CSA. AS A RESULT, HPC NOW OFFERS CSA-CERTIFIED ENGINEERED TO ORDER DESIGNS.**

## ENGINEERED BURNER DESIGNS:

Outlining a few details with HPC's Engineer Lead Designer, Ben Wentzel is the first step to creating your unique design:

- *Location of installation*
- *The application*
- *Enclosure type*
- *Ventilation/drainage*
- *Type of gas the unit will be hooked to*
- *Style of Pan - Flat, Bowl etc.*
- *Standard Burner - Penta, linear etc.*
- *Custom Burner - H, E-Burner, Tree etc.*
- *Pan dimensions*
  - *Round - ID and OD*
  - *Rectangle - ID and OD*
  - *Radius - ID and OD plus template*
  - *Other - ID and OD*

Hammering out these essential details will assist our experts in creating the fire design of your dreams. Safety and innovation inform each and every fire design. In turn, this approach allows HPC to offer over 400 CSA Certified appliances, which is more than any other manufacturer in the industry.

For Engineered To Order designs to be CSA certified, they must not exceed a certain range of BTUs:

- Match lit- 65,000 BTUs**
- FPPK -250,000 BTUs**
- EI-400,000 BTUs**

Anything above 400,000 BTUs will not be CSA certified as it is considered to be a high pressure unit. HPC can still build these custom designs and will conduct internal testing to ensure the unit will be safe and reliable.

You can find many of HPC's signature Engineered to order designs in commercial settings. Among many professional and collegiate facilities, HPC has created special designs for Comerica Park as well as the Philadelphia Phillies stadium which enhances the experience for all sports fans.

## MOST POPULAR DESIGNS:

Per Ben Wentzel, "our most popular customized designs are HPC's long linear burners, radius, L shape or right angle, as well as U shape. These burners are used in different applications such as highlighting the edge of a pool, or enhancing an outdoor bar or kitchen. HPC is able to customize these designs by utilizing Stainless Steel tubing to create the curvatures and angles. In addition HPC has developed proper connections to ensure proper gas flow. Each burner hole is tooled versus punched out to ensure a quiet, unobstructed flame. With HPC you can achieve a custom design that lights every time.



# FORNO DE PIZZA

## OUTDOOR DINING NEVER TASTED SO GOOD

HPC's Forno de Pizza hybrid oven was founded on the belief that some of our best experiences in life are spent with our friends and family. Cooking together with fire brings a powerful connection to the foods you're sharing. The Forno de Pizza oven honors timeless styling cues

from ancient Greece while marrying it with modern conveniences. Designed to cook more than just pizza, it's an oven for the food enthusiast.



## ACCESSORIES



**INFRARED THERMOMETER**

FDP-INFRA-RED GUN

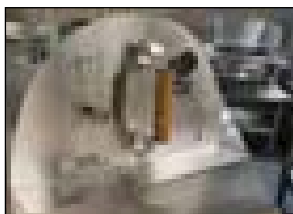

**DOOR WITH THERMOMETER**

FDP-DOOR

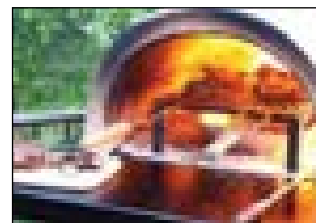

**GRILL RACK**

FDP-GRILL RACK

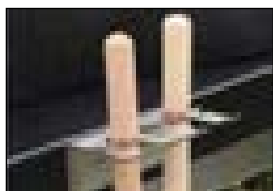

**UTENSIL HOLDER**

FDP-HOLDER

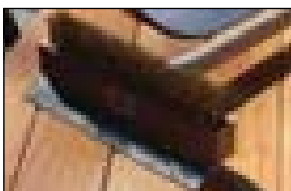

**BRUSH**

FDP-BRUSH



**PAN PEEL**

FDP-ALUM PEEL

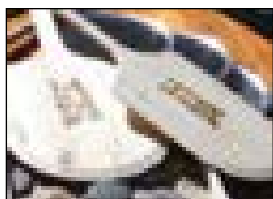

**WOODEN PADDLES**

FDP-WOOD PADDLE



**PIZZA PLATES**

FDP-PANS

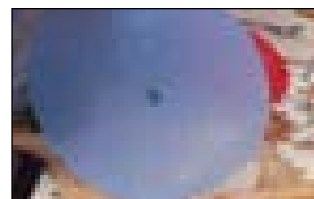

**DOUGH SHEETS**

FDP-DOUGH ROLLING SHEETS

## VINYL COVERS

FDP-COVER-VILLA

FDP-COVER-FORNO

### Forno Series (Portable)

The FORNO Series is a portable dual fuel oven that can be wheeled around easily. While it weighs around 450lbs, it can be easily taken apart and transported to various locations. The Forno de Pizza's classic design inspired the brand with its' black cart and intricate hand-crafted glass mosaic oven... This oven has an electronic ignition system that will facilitate oven starts and save on fuel when the burner is not in use. HPC offers the choice of six hues of mosaic glass to give the oven an elegant finish.



**Includes Glass Tiled Oven, Stainless Steel Hearth, Vent, Powder Coat Black Steel Cart**

### Forno Specifications

Tile Color	Gas type	Model
Ocean Blue	Natural Gas	FDP-FORNO/OB-EI-NG
Ocean Blue	Liquid Propane	FDP-FORNO/OB-EI-LP
Pool Blue	Natural Gas	FDP-FORNO/PB-EI-NG
Pool Blue	Liquid Propane	FDP-FORNO/PB-EI-LP
Simply Red	Natural Gas	FDP-FORNO/SR-EI-NG
Simply Red	Liquid Propane	FDP-FORNO/SR-EI-LP
Black Onyx	Natural Gas	FDP-FORNO/BLX-EI-NG
Black Onyx	Liquid Propane	FDP-FORNO/BLX-EI-LP
Retro	Natural Gas	FDP-FORNO/RETRO-EI-NG
Retro	Liquid Propane	FDP-FORNO/RETRO-EI-LP
Copper	Natural Gas	FDP-FORNO/COPPER-EI-NG
Copper	Liquid Propane	FDP-FORNO/COPPER-EI-LP
Custom Color	Natural Gas	FDP-FORNO/CUSTOM-EI-NG
Custom Color	Liquid Propane	FDP-FORNO/CUSTOM-EI-LP

### Villa Series (Built In)

Hearth and oven installed in a built-in application, available in LP as well as Natural Gas. Installation is completed in 3 easy steps; requires a 35" deep counter and is paired with a custom stainless steel flange. The Villa is the lightest dual fuel built in oven on the market and has an electronic ignition system that facilitates oven starts as well as it saves on fuel when the burner is not in use.

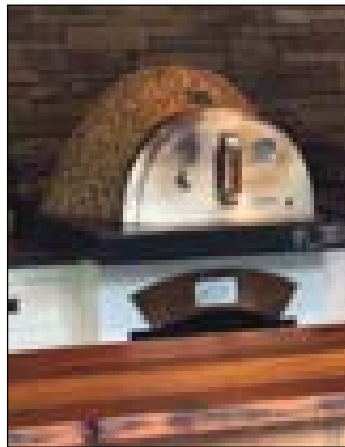

**Includes Glass Tiled Oven, Stainless Steel Hearth, Vent, Flange Mount**

### Villa Specifications

Tile Color	Gas type	Model
Ocean Blue	Natural Gas	FDP-VILLA/OB-EI-NG
Ocean Blue	Liquid Propane	FDP-VILLA/OB-EI-LP
Pool Blue	Natural Gas	FDP-VILLA/PB-EI-NG
Pool Blue	Liquid Propane	FDP-VILLA/PB-EI-LP
Simply Red	Natural Gas	FDP-VILLA/SR-EI-NG
Simply Red	Liquid Propane	FDP-VILLA/SR-EI-LP
Black Onyx	Natural Gas	FDP-VILLA/BLX-EI-NG
Black Onyx	Liquid Propane	FDP-VILLA/BLX-EI-LP
Retro	Natural Gas	FDP-VILLA/RETRO-EI-NG
Retro	Liquid Propane	FDP-VILLA/RETRO-EI-LP
Copper	Natural Gas	FDP-VILLA/COPPER-EI-NG
Copper	Liquid Propane	FDP-VILLA/COPPER-EI-LP
Custom Color	Natural Gas	FDP-VILLA/CUSTOM-EI-NG
Custom Color	Liquid Propane	FDP-VILLA/CUSTOM-EI-LP

### Di Napoli Series (Do It Yourself - DIY)

The Di Napoli E.I. Series is a built-in, enclosed, dual fuel with electronic ignition oven that can be installed in a permanent structure with the use of a chimney. Design your own outer shell and take advantage of Forno de Pizza oven's electronic ignition for easy start ups as well as continuous controlled oven operation. This oven comes assembled with the hearth, oven, enclosure, a chimney stack, and arched front making it ready for immediate installation.



**Includes Oven, Stainless Steel Hearth, Ready To Finish Enclosure**

### Di Napoli

Gas type	Model
Natural Gas	FDP-DiNapoli/RTF-EI-NG
Liquid Propane	FDP-DiNapoli/RTF-EI-LP

### Color Choices



OCEAN BLUE



POOL BLUE



BLACK ONYX



COPPER



RETRO



SIMPLY RED



# HPC'S ANNOUNCEMENTS

## SST TORPEDO™ BURNERS

The commercial-grade SST Torpedo™ burner, available in Penta, Linear and H configurations; is our newly designed nozzle which creates the biggest flame on the market. The SST Torpedo Burners yield an enhanced bonfire like aesthetic. This is a great addition to our product offerings, providing customers with an array of flame options.



**SST TORPEDO BURNER (WITH NOZZLES)**



**STANDARD BURNER (WITHOUT NOZZLES)**



**THE SST TORPEDO™ IS THE LARGEST  
CSA CERTIFIED FLAME ON THE MARKET.**

## HPC FIRE ONE APP

**ONE APP, THREE GREAT PRODUCTS!**

HPC Fire Inspired's new augmented reality app lets you select options, scan your area, and place our products in your design. Just select, scan & see the design in real time.

Download it today on your Apple, Droid, or Google phone today by searching "HPC One App". Or go to [hpcfire.com/one-app](http://hpcfire.com/one-app) today.



①

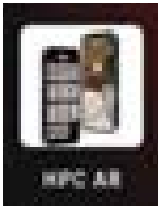

### HPC AR

The Augmented Reality app allows you to see our finished products in real-time to make sure the aesthetic and look are exactly what you desire. HPC's AR App is a big hit with contractors and designers alike and truly enhances the customer experience.

②



### HITS

The HITS app is a building instruction, tools needed, clearance given, troubleshooting beast for anyone that has an HPC Fire feature. Simply choose the product you are working with and let the app do the rest. It starts with tools and clearances needed and goes into the step-by-step instructions of how to properly install any HPC Fire appliance.

③

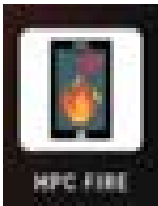

### HPC FIRE

The HPC FIRE app allows you to control the electronic ignition-High-Low models. The HPC FIRE app does a lot more than just light your fire, it allows you to change the flame height from high to low and achieve the ambiance you desire. As added safety precautions the app offers password protected parental safety controls.





## ① MATCH LIT (MLFPK SERIES)

This is our simplest certified fire pit insert- easy to operate and requires the least amount of maintenance.

### How It Works

**Start Up:** Light the long-stem lighter next to the perimeter of the burner then slowly open the key to valve. Leave key in the valve during use.

**Operation:** Flame height may be adjusted by turning the key to the valve: counterclockwise increases more flame height, clockwise lowers flame.

**Shut Down:** To turn OFF the fire pit, simply turn the key to the valve clockwise to the OFF position. Lastly, remove key.

### Features

- Fully Assembled and ready to install.
- Flex Line configuration provides versatile and simple installation.
- Valve mounting bracket included- for safe mounting of control have.



- Flame height is adjustable using key valve.
- Available in Natural Gas or Liquid Propane.
- CSA Certified in US & Canada to ANSI Z21.97-2017 / CSA 2.41-2014 requirements.
- Optional Install & Controls: Paver Block Bracket, Key Extension Kit, Long Keys and Spark Ignition Kit.

## ② PUSH BUTTON / FLAME SENSE CONTROL (FPPK SERIES)

This is our mid-range fire pit insert utilizing safety pilot flame control. Simply push the ignition button and the valve control knob to start. Flame adjustment is done with the knob. The FPPK gives our customers flame sensing technology and is battery operated, negating the need for a power

### How It Works

**Start Up:** Simultaneously press the valve control knob to start pilot gas flow while pressing the ignition button for spark. Once ignited, release the control knob (about 20 seconds). Lastly, turn the control knob counter clockwise lighting the main burner.

**Operation:** Flame height may be adjusted by turning valve control knob- counterclockwise provides more flame, clockwise lowers flame. If flame loss does occur, the system will automatically turn off all gas flow.

**Shut Down:** To turn OFF the fire pit simply turn valve control knob clockwise- slightly depress knob to reach OFF position.

### Features

- Fully Assembled and ready to install. Control components are protected within the valve box.
- Flex Line configuration provides versatile and simple installation.
- Start ignition with push button and valve control knob.
- Flame sensing- system will turn off gas if flame is lost.
- Flame height is adjustable using valve control knob.
- Battery Operated System- is perfect solution for installs with no power.
- Natural Gas or Liquid Propane.
- CSA Certified in US & Canada to ANSI Z21.97-2017 / CSA 2.41-2014 requirements.

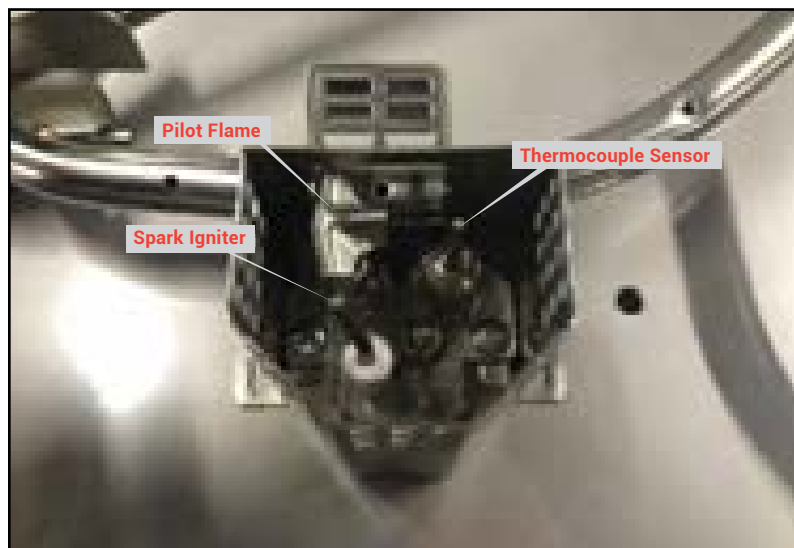

## ③ REMOTE ELECTRONIC IGNITION CONTROL (EI SERIES)

HPC's top of the line system comes fully assembled and is ready to be installed. The EI Series is available in High/Low as well as On/Off Models. Once installed, the EI Series can be operated with a wall switch or a hand held remote.

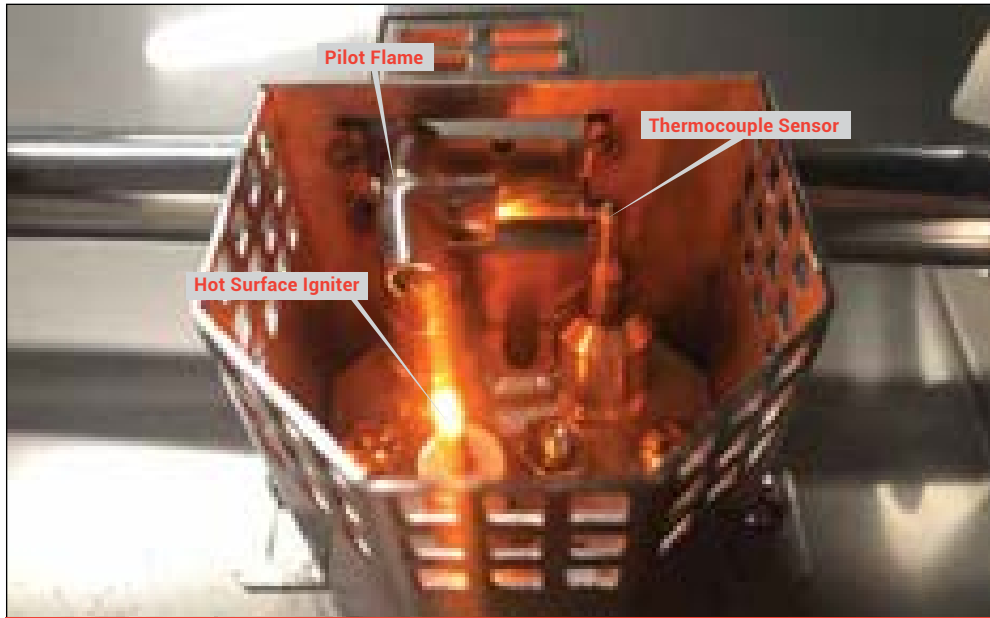

Smart device App available on Hi/Lo Models only

### How It Works

**Start Up:** This is done by use of a wall switch or remote control. When the ON command is received, the system completes initial safety checks then starts flow of pilot gas. After 5 seconds the hot surface igniter glows igniting the pilot flame. When the system confirms the pilot flame is present, the main burner will be ignited by the pilot flame.

**Operation:** While enjoying the ambiance of your fire pit, the system is at work monitoring flame status, internal temperatures / voltages and other safety parameters. If flame loss does occur, the system will turn off all gas flow, and then restart by automatically commencing the start sequence.

**On/Off Models:** Includes the convenience and safety features- optional remote control available.

**Bluetooth High / Low Flame Control Models:** This option includes a smart remote as well as a smartapp enabling 2-way communication with the fire pit. Remote allows flame height control while receiving information from fire pit to advise user of fire pit status (flashing LED).

**Shut Down:** To turn OFF the fire pit simply use wall switch, remote control or whole house system.

### Features

- Fully Assembled- ready to install. Control components are protected within valve box.
- Start via wall switch or remote control; Auto re-light if flame is lost.
- Ignition is complete using a robust and reliable Hot Surface igniter.
- On/Off models: Use with optional wall switch, Remote Control or your whole house system
- High/Low Flame Control Models: Adjust high setting to low setting- ~45% turndown (Remote Control included). Not for use with your whole house system.
- 120vac: Standard outdoor grounded power cord- simply plug into GFCI outlet.
- 24vac Option: Typically used with lower voltage requirements.
- Natural Gas or Liquid Propane.
- Internal temperature monitoring with overheat auto shutoff.
- CSA Certified in US & Canada to ANSI Z21.97-2017 / CSA 2.41-2014 requirements. (This new EI system already meets upcoming 2020 ANSI requirements).
- **Optional Controls: On/Off Remote, Timers, Power Supplies and an Emergency Shutoff. (Pg. 59)**

On/Off Model- Remote (Optional) |

High / Low Model- Remote (Standard)



Thermocouple Lead crimped by design for ease of install.

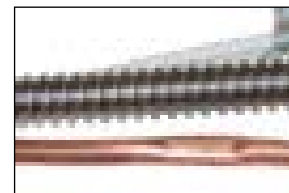

## ELECTRONIC IGNITION FIRE PITS (EI)

		Round		Square		Rectangle H	Linear	
STYLES								
		<b>Bowl</b>	<b>Flat</b>	<b>Bowl</b>	<b>Flat</b>	<b>Bowl</b>	<b>Trough</b>	<b>Interlink</b>
SIZES		13"	14"	18"	18"	24" x 12"	24"	25" x 8"
		19"	18"	24"	24"	30" x 12"	36"	37" x 8"
		25"	24"	30"	30"	36" x 14"	48"	49" x 8"
		31"	30"	36"	36"	42" x 14"	60"	61" x 8"
		37"	36"	42"	42"	54" x 16"	72"	73" x 8"
		43"	42"			66" x 16"	96"	97" x 8"
			54"			78" x 16"		121" x 8"
					90" x 16"			

All Models Available in Natural Gas or Propane	All Models Available in 120VAC or 24VAC	All Models Available with remote	Remote or App HI/LO or ON/OFF	<b>ON/OFF ONLY</b> (Remote optional)
--	---	----------------------------------	-------------------------------	---

## PUSH BUTTON/FLAME SENSE FIRE PITS (FPPK)

		Round		Square		Rectangle H	Linear	
STYLES								
		<b>Bowl</b>	<b>Flat</b>	<b>Bowl</b>	<b>Flat</b>	<b>Bowl</b>	<b>Trough</b>	<b>Interlink</b>
SIZES		13"	14"	18"	18"	24" x 12"	24"	25" x 8"
		19"	18"	24"	24"	30" x 12"	36"	37" x 8"
		25"	24"	30"	30"	36" x 14"	48"	49" x 8"
		31"	30"	36"	36"	42" x 14"	60"	61" x 8"
		37"	36"			54" x 16"	72"	73" x 8"
						96"	97" x 8"	

All Models Available in Natural Gas or Propane	Battery	Manual Flame Control
--	---------	----------------------

## MATCH LIT FIRE PITS (MLFPK)

		Round		Square		Rectangle H	Linear	
STYLES								
		<b>Bowl</b>	<b>Flat</b>	<b>Bowl</b>	<b>Flat</b>	<b>Bowl</b>	<b>Trough</b>	<b>Interlink</b>
SIZES		13"	8"	18"	18"	24" x 12"	24"	25" x 8"
		19"	14"	24"	24"	30" x 12"	36"	37" x 8"
		25"	18"	30"	30"	36" x 14"	48"	49" x 8"
		31"	24"					
		30"						

All Models Available in Natural Gas or Propane	Optional Manual Spark Ignition Kit	Manual Flame Control
--	------------------------------------	----------------------

# ROUND INSERT MODELS

## ROUND BOWL INSERTS

### EI Series



**24VAC MODELS  
REQUIRE HPC/  
SEBCO 24vac, 100W  
Power Supply for  
inserts ONLY pg. 55**

#### Benefits of Round Bowl Inserts:

Sidewall helps with media retention. Pan Lip makes for easy installation.

#### Features:

- Made of #304, 18 gauge Stainless Steel
- Spun design adds rigidity
- Welded gas fitting for strength
- Weep holes for drainage
- \*Lifetime Warranty on burners



\*See page 8 for details

### MLFPK Series



### FPPK Series



**SIK36 -  
MANUAL SPARK  
IGNITION for  
match lit fire pits  
pg. 48**

## ACCESSORIES



**EI Accessories (Pg. 55):**  
Timers, Power Supplies, E-Stop

**MLFPK Paver  
Bracket - Pg. 48**

**Wind Guards:  
Pg. 45**

**Covers:  
Pg. 46**

**Media:  
Pg. 43**

12 **⚠ WARNING: California PROP 65:** This product can expose you to Lead & Chromium, which is known to the State of California to cause cancer and birth defects or other reproductive harm. For more information go to [www.P65Warnings.ca.gov](http://www.P65Warnings.ca.gov).

Inspired by safety. Innovated for your lifestyle.

See Pg. 10 for EI System Features



**Electronic Ignition Models - EI Series Specifications**

Size (A")	Power	Gas type	Nozzle	Std Model - Flame ON/OFF	Nozzle	Std Model - Bluetooth (HI/LO)	Burner	Max BTU	Nozzle BTU
13"	120vac * 24vac	Natural Gas Natural Gas		13SSEI-NG/120VAC 13SSEI-NG/24VAC		13SSEI-HI/LO-NG/120VAC 13SSEI-HI/LO-NG/24VAC	12" Round	90k	
19"	120vac * 24vac	Natural Gas Natural Gas	TOR- TOR-	PENTA19EI-NG/120VAC PENTA19EI-NG/24VAC	TOR- TOR-	PENTA19EI-HI/LO-NG/120VAC PENTA19EI-HI/LO-NG/24VAC	12" Penta	65k	65k
25"	120vac * 24vac	Natural Gas Natural Gas	TOR- TOR-	PENTA25EI-NG/120VAC PENTA25EI-NG/24VAC	TOR- TOR-	PENTA25EI-HI/LO-NG/120VAC PENTA25EI-HI/LO-NG/24VAC	18" Penta	125k	125k
31"	120vac * 24vac	Natural Gas Natural Gas	TOR- TOR-	PENTA31EI-NG/120VAC PENTA31EI-NG/24VAC	TOR- TOR-	PENTA31EI-HI/LO-NG/120VAC PENTA31EI-HI/LO-NG/24VAC	24" Penta	200k	200k
37"	120vac * 24vac	Natural Gas Natural Gas	TOR- TOR-	PENTA37EI-NG/120VAC PENTA37EI-NG/24VAC	TOR- TOR-	PENTA37EI-HI/LO-NG/120VAC PENTA37EI-HI/LO-NG/24VAC	30" Penta	250k	275k
43"	120vac * 24vac	Natural Gas Natural Gas	TOR- TOR-	PENTA43EI-NG/120VAC PENTA43EI-NG/24VAC			36" Penta	400k	375k

**EI MODELS INCLUDE:** Insert: Fully Assembled. Flex Line: Gas Input and Instructions **\*IMPORTANT: 24vac Models REQUIRE HPC/ SEBCO 24vac, 100W Power Supply pg. 55**  
**SOLD SEPARATELY (EI INSERT):** On/Off Models 120VAC- Remote: 578-C: See Pg. 55.

See Pg. 9 for FPPK System Features



**Push Button/Flame Sense Models - FPPK Flex Series Specifications**

Size (A")	Gas type	Nozzle	Std Model	Nozzle	Std Remote Small Tank Model	Burner	Max BTU	Nozzle BTU
13"	Natural Gas		FPPK13-FLEX-NG		FPPK13-FLEX-LP-ST	12" Round	90k	
19"	Natural Gas	TOR-	PENTA19FPPK-FLEX-NG	TOR-	PENTA19FPPK-FLEX-LP-ST*	12" Penta	65k	65k
25"	Natural Gas	TOR-	PENTA25FPPK-FLEX-NG	TOR-	PENTA25FPPK-FLEX-LP-ST*	18" Penta	90k	125k
31"	Natural Gas	TOR-	PENTA31FPPK-FLEX-NG			24" Penta	140k	150k
37"	Natural Gas	TOR-	PENTA37FPPK-FLEX-NG			30" Penta	140k	175k

See Pg. 9 for MLFPK System Features



**Match Lit Models - MLFPK Flex Series Specifications**

Size (A")	Gas type	Nozzle	Std Model	Nozzle	Std Remote Small Tank Model	Burner	Max BTU	Nozzle BTU
13"	Natural Gas	TOR-	PENTA13 MLFPK-FLEX-NG	TOR-	PENTA13 MLFPK-FLEX-LP-ST*	12" Penta	65k	65k
19"	Natural Gas	TOR-	PENTA19 MLFPK-FLEX-NG	TOR-	PENTA19 MLFPK-FLEX-LP-ST*	12" Penta	65k	65k
25"	Natural Gas	TOR-	PENTA25 MLFPK-FLEX-NG	TOR-	PENTA25 MLFPK-FLEX-LP-ST*	18" Penta	65k	65k
31"	Natural Gas	TOR-	PENTA31 MLFPK-FLEX-NG	TOR-	PENTA31 MLFPK-FLEX-LP-ST*	18" Penta	65k	65k

**TO ORDER PROPANE MODELS "LP" Please Change out NG to LP**

**FPPK & MLFPK MODELS INCLUDE:** Insert: Fully Assembled and Instructions  
**SOLD SEPARATELY: (FPPK-MLFPK) Input Flex Line: SSC24: All models**



**\*IMPORTANT: On Small Tank Units** The BTU's are the same as the non Nozzle units

TOP SELLING SIZES

Need help? Use our fire pit selector at [hpcfire.com](http://hpcfire.com)

Match proper accessories to your fire pit model - see Pg. 60 - 61.

# ROUND INSERT MODELS

# ROUND FLAT INSERTS

## EI Series



**24VAC MODELS  
REQUIRE HPC/  
SEBCO 24vac, 100W  
Power Supply for  
inserts ONLY pg. 55**

### Benefits of Round Flat Inserts:

Economical flat design. Meant for a recess mount within an enclosure.

### Features:

- Made of #304, 18 gauge Stainless Steel
- Raised hub burner for water prevention
- Welded gas fitting for strength
- Weep holes for drainage
- \*Lifetime Warranty on burners



\*See page 8 for details



**SIK36 -  
MANUAL SPARK  
IGNITION** for  
match lit fire pits  
pg. 48



## FPPK Series



**\*IMPORTANT: On Small Tank Units** The BTU's are the same as the non Nozzle units

## ACCESSORIES



**EI Accessories (Pg. 55):**  
Timers, Power Supplies, E-Stop

**MLFPK Paver  
Bracket - Pg. 48**

**Wind Guards:**  
Pg. 45

**Media:**  
Pg. 43

See Pg. 10 for EI System Features

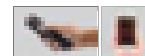

### Electronic Ignition Models - EI Series Specifications

Size	Power	Gas type	Nozzle	Std Model- Flame ON/OFF	Nozzle	Std Model - Bluetooth (HI/LO)	Burner	Max BTU	Nozzle BTU
14"	120vac * 24vac	Natural Gas Natural Gas		14FSSEI-NG/120VAC 14FSSEI-NG/24VAC		14FSSEI-HI/LO-NG/120VAC 14FSSEI-HI/LO-NG/24VAC	12" Round	90k	
18"	120vac * 24vac	Natural Gas Natural Gas	TOR- TOR-	PENTA18EI-NG/120VAC PENTA18EI-NG/24VAC	TOR- TOR-	PENTA18EI-HI/LO-NG/120VAC PENTA18EI-HI/LO-NG/24VAC	12" Penta	65k	65k
24"	120vac * 24vac	Natural Gas Natural Gas	TOR- TOR-	PENTA24EI-NG/120VAC PENTA24EI-NG/24VAC	TOR- TOR-	PENTA24EI-HI/LO-NG/120VAC PENTA24EI-HI/LO-NG/24VAC	18" Penta	125k	125k
30"	120vac * 24vac	Natural Gas Natural Gas	TOR- TOR-	PENTA30EI-NG/120VAC PENTA30EI-NG/24VAC	TOR- TOR-	PENTA30EI-HI/LO-NG/120VAC PENTA30EI-HI/LO-NG/24VAC	24" Penta	200k	200k
36"	120vac * 24vac	Natural Gas Natural Gas	TOR- TOR-	PENTA36EI-NG/120VAC PENTA36EI-NG/24VAC	TOR- TOR-	PENTA36EI-HI/LO-NG/120VAC PENTA36EI-HI/LO-NG/24VAC	30" Penta	250k	275k
42"	120vac * 24vac	Natural Gas Natural Gas	TOR- TOR-	PENTA42EI-NG/120VAC PENTA42EI-NG/24VAC			36" Penta	400k	375k
54"	120vac * 24vac	Natural Gas Natural Gas	TOR- TOR-	PENTA54EI-NG/120VAC PENTA54EI-NG/24VAC			48" Penta	400k	400k

**EI MODELS INCLUDE:** Insert: Fully Assembled. Flex Line: Gas Input and Instructions  
**SOLD SEPARATELY (EI INSERT):** On/Off Models 120VAC- Remote: 578-C: See Pg. 55.

**\*IMPORTANT: 24vac Models REQUIRE HPC/ SEBCO 24vac, 100W Power Supply pg. 55**

TOP SELLING SIZES

See Pg. 9 for FPPK System Features



### Push Button/Flame Sense Models - FPPK Flex Series Specifications

Size	Gas type	Nozzle	Std Model	Nozzle	Std Remote Small Tank Model	Burner	Max BTU	Nozzle BTU
14"	Natural Gas		FPPK14-FLEX-NG		FPPK14-FLEX-LP-ST	12" Round	90k	
18"	Natural Gas	TOR-	PENTA18FPPK-FLEX-NG	TOR-	PENTA18FPPK-FLEX-LP-ST*	12" Penta	65k	65k
24"	Natural Gas	TOR-	PENTA24FPPK-FLEX-NG	TOR-	PENTA24FPPK-FLEX-LP-ST*	18" Penta	90k	125k
30"	Natural Gas	TOR-	PENTA30FPPK-FLEX-NG			24" Penta	140k	150k
36"	Natural Gas	TOR-	PENTA36FPPK-FLEX-NG			30" Penta	140k	175k

See Pg. 9 for MLFPK System Features



### Match Lit Models - MLFPK Flex Series Specifications

Size	Gas type	Nozzle	Std Model	Nozzle	Std Remote Small Tank Model	Burner	Max BTU	Nozzle BTU
8"	Natural Gas		MLFPK8-FLEX-NG		MLFPK8-FLEX-LP-ST	6" Round	40k	
14"	Natural Gas	TOR-	PENTA14 MLFPK-FLEX-NG	TOR-	PENTA14 MLFPK-FLEX-LP-ST*	12" Penta	65k	65k
18"	Natural Gas	TOR-	PENTA18 MLFPK-FLEX-NG	TOR-	PENTA18 MLFPK-FLEX-LP-ST*	12" Penta	65k	65k
24"	Natural Gas	TOR-	PENTA24 MLFPK-FLEX-NG	TOR-	PENTA24 MLFPK-FLEX-LP-ST*	18" Penta	65k	65k
30"	Natural Gas	TOR-	PENTA30 MLFPK-FLEX-NG	TOR-	PENTA30 MLFPK-FLEX-LP-ST*	18" Penta	65k	65k

**TO ORDER PROPANE MODELS "LP" Please Change out NG to LP**

**FPPK & MLFPK MODELS INCLUDE:** Insert: Fully Assembled and Instructions  
**SOLD SEPARATELY: (FPPK-MLFPK) Input Flex Line: SSC24: All models**

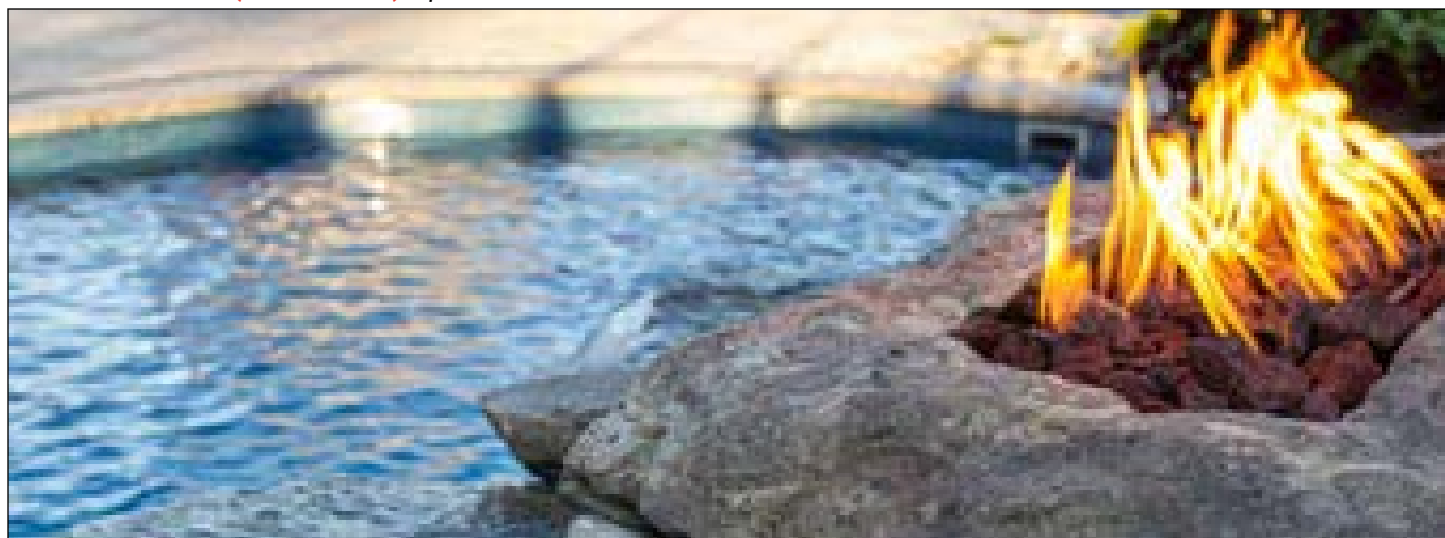

**\*IMPORTANT: On Small Tank Units** The BTU's are the same as the non Nozzle units

TOP SELLING SIZES

Need help? Use our fire pit selector at [hpcfire.com](http://hpcfire.com)

Match proper accessories to your fire pit model - see Pg. 60 - 61.

# SQUARE INSERT MODELS

## SQUARE BOWL INSERTS

### EI Series



**24VAC MODELS  
REQUIRE HPC/  
SEBCO 24vac, 100W  
Power Supply for  
inserts ONLY pg. 55**

#### Benefits of a Square Bowl Insert:

Sidewall helps with media retention. Pan Lip makes for easy installation.

#### Features:

Made of #304, 18 gauge Stainless Steel  
Raised hub burner for water prevention  
Welded gas fitting for strength  
Weep holes for drainage  
*\*Lifetime Warranty on burners*



*\*See page 8 for details*

### MLFPK Series



### FPPK Series



**SIK36 -  
MANUAL SPARK  
IGNITION** for  
match lit fire pits  
pg. 48

## ACCESSORIES



**EI Accessories (Pg. 55):**  
Timers, Power Supplies, E-Stop

**MLFPK Paver  
Bracket - Pg. 48**

**Wind Guards:  
Pg. 45**

**Media:  
Pg. 43**

16 **WARNING: California PROP 65:** This product can expose you to Lead & Chromium, which is known to the State of California to cause cancer and birth defects or other reproductive harm. For more information go to [www.P65Warnings.ca.gov](http://www.P65Warnings.ca.gov).

Inspired by safety. Innovated for your lifestyle.



See Pg. 10 for EI System Features



**Electronic Ignition Models - EI Series Specifications**

Size	Power	Gas type	Nozzle	Std Model - Flame ON/OFF	Nozzle	Std Model - Bluetooth (HI/LO)	Burner	Max BTU	Nozzle BTU
18"	120vac	Natural Gas	TOR-	18SSEI-SQBL-NG/120VAC	TOR-	18SSEI-SQBL-HI/LO-NG/120V	12" Penta	65k	65k
	* 24vac	Natural Gas	TOR-	18SSEI-SQBL-NG/24VAC	TOR-	18SSEI-SQBL-HI/LO-NG/24VAC			
24"	120vac	Natural Gas	TOR-	24SSEI-SQBL-NG/120VAC	TOR-	24SSEI-SQBL-HI/LO-NG/120V	18" Penta	125k	125k
	* 24vac	Natural Gas	TOR-	24SSEI-SQBL-NG/24VAC	TOR-	24SSEI-SQBL-HI/LO-NG/24VAC			
30"	120vac	Natural Gas	TOR-	30SSEI-SQBL-NG/120VAC	TOR-	30SSEI-SQBL-HI/LO-NG/120V	24" Penta	200k	200k
	* 24vac	Natural Gas	TOR-	30SSEI-SQBL-NG/24VAC	TOR-	30SSEI-SQBL-HI/LO-NG/24VAC			
36"	120vac	Natural Gas	TOR-	36SSEI-SQBL-NG/120VAC	TOR-	36SSEI-SQBL-HI/LO-NG/120V	30" Penta	250k	275k
	* 24vac	Natural Gas	TOR-	36SSEI-SQBL-NG/24VAC	TOR-	36SSEI-SQBL-HI/LO-NG/24VAC			
42"	120vac	Natural Gas	TOR-	42SSEI-SQBL-NG/120VAC			36" Penta	400k	375k
	* 24vac	Natural Gas	TOR-	42SSEI-SQBL-NG/24VAC					

**EI MODELS INCLUDE:** Insert: Fully Assembled. Flex Line: Gas Input and Instructions  
**SOLD SEPARATELY (EI INSERT):** On/Off Models 120VAC- Remote: 578-C: See Pg. 55.

**\*IMPORTANT: 24vac Models REQUIRE HPC/ SEBCO 24vac, 100W Power Supply pg. 55**

See Pg. 9 for FPPK System Features



**Push Button/Flame Sense Models - FPPK Flex Series Specifications**

Size	Gas type	Nozzle	Std Model	Nozzle	Std Remote Small Tank Model	Burner	Max BTU	Nozzle BTU
18"	Natural Gas	TOR-	FPPK18-SQBL-FLEX-NG	TOR-	FPPK18-SQBL-FLEX-LP-ST*	12" Penta	65k	65k
24"	Natural Gas	TOR-	FPPK24-SQBL-FLEX-NG	TOR-	FPPK24-SQBL-FLEX-LP-ST*	18" Penta	90k	125k
30"	Natural Gas	TOR-	FPPK30-SQBL-FLEX-NG			24" Penta	140k	150k
36"	Natural Gas	TOR-	FPPK36-SQBL-FLEX-NG			30" Penta	140k	175k

See Pg. 9 for MLFPK System Features



**Match Lit Models - MLFPK Flex Series Specifications**

Size	Gas type	Nozzle	Std Model	Nozzle	Std Remote Small Tank Model	Burner	Max BTU	Nozzle BTU
18"	Natural Gas	TOR-	MLFPK18SQBL-FLEX-NG	TOR-	MLFPK18SQBL-FLEX-LP-ST*	12" Penta	65k	65k
24"	Natural Gas	TOR-	MLFPK24SQBL-FLEX-NG	TOR-	MLFPK24SQBL-FLEX-LP-ST*	18" Penta	65k	65k
30"	Natural Gas	TOR-	MLFPK30SQBL-FLEX-NG	TOR-	MLFPK30SQBL-FLEX-LP-ST*	18" Penta	65k	65k

**TO ORDER PROPANE MODELS "LP" Please Change out NG to LP**

**FPPK & MLFPK MODELS INCLUDE:** Insert: Fully Assembled and Instructions  
**SOLD SEPARATELY: (FPPK-MLFPK) Input Flex Line: SSC24: All models**



**\*IMPORTANT: On Small Tank Units** The BTU's are the same as the non Nozzle units

TOP SELLING SIZES

Need help? Use our fire pit selector at [hpcfire.com](http://hpcfire.com)

Match proper accessories to your fire pit model - see Pg. 60 - 61.

# SQUARE INSERT MODELS

## SQUARE FLAT INSERTS

### EI Series



**24VAC MODELS  
REQUIRE HPC/  
SEBCO 24vac, 100W  
Power Supply for  
inserts ONLY pg. 55**

### Benefits of a Square Flat Insert:

Economical flat design. Meant for a recess mount within an enclosure.

### Features:

- Made of #304, 18 gauge Stainless Steel
- Raised hub burner for water prevention
- Welded gas fitting for strength
- Weep holes for drainage
- \*Lifetime Warranty on burners



\*See page 8 for details

### MLFPK Series



### FPPK Series



**SIK36 -  
MANUAL SPARK  
IGNITION** for  
match lit fire pits  
pg. 48

## ACCESSORIES



**EI Accessories (Pg. 55):**  
Timers, Power Supplies, E-Stop

**MLFPK Paver  
Bracket - Pg. 48**

**Wind Guards:**  
Pg. 45

**Media:**  
Pg. 43

18 **WARNING: California PROP 65:** This product can expose you to Lead & Chromium, which is known to the State of California to cause cancer and birth defects or other reproductive harm. For more information go to [www.P65Warnings.ca.gov](http://www.P65Warnings.ca.gov).

Inspired by safety. Innovated for your lifestyle.

See Pg. 10 for EI System Features



**Electronic Ignition Models - EI Series Specifications**

Size	Power	Gas type	Nozzle	Std Model - Flame ON/OFF	Nozzle	Std Model - Bluetooth (HI/LO)	Burner	Max BTU	Nozzle BTU
18"	120vac	Natural Gas	TOR-	18FSSEI-SQ-NG/120VAC	TOR-	18FSSEI-SQ-HI/LO-NG/120VAC	12" Penta	65k	65k
	* 24vac	Natural Gas	TOR-	18FSSEI-SQ-NG/24VAC	TOR-	18FSSEI-SQ-HI/LO-NG/24VAC			
24"	120vac	Natural Gas	TOR-	24FSSEI-SQ-NG/120VAC	TOR-	24FSSEI-SQ-HI/LO-NG/120VAC	18" Penta	125k	125k
	* 24vac	Natural Gas	TOR-	24FSSEI-SQ-NG/24VAC	TOR-	24FSSEI-SQ-HI/LO-NG/24VAC			
30"	120vac	Natural Gas	TOR-	30FSSEI-SQ-NG/120VAC	TOR-	30FSSEI-SQ-HI/LO-NG/120VAC	24" Penta	200k	200k
	* 24vac	Natural Gas	TOR-	30FSSEI-SQ-NG/24VAC	TOR-	30FSSEI-SQ-HI/LO-NG/24VAC			
36"	120vac	Natural Gas	TOR-	36FSSEI-SQ-NG/120VAC	TOR-	36FSSEI-SQ-HI/LO-NG/120VAC	30" Penta	250k	275k
	* 24vac	Natural Gas	TOR-	36FSSEI-SQ-NG/24VAC	TOR-	36FSSEI-SQ-HI/LO-NG/24VAC			
42"	120vac	Natural Gas	TOR-	42FSSEI-SQ-NG/120VAC			36" Penta	400k	375k
	* 24vac	Natural Gas	TOR-	42FSSEI-SQ-NG/24VAC					

**EI MODELS INCLUDE:** Insert: Fully Assembled. Flex Line: Gas Input and Instructions  
**SOLD SEPARATELY (EI INSERT):** On/Off Models 120VAC- Remote: 578-C: See Pg. 55.

**\*IMPORTANT: 24vac Models REQUIRE HPC/ SEBCO 24vac, 100W Power Supply pg. 55**

See Pg. 9 for FPPK System Features



**Push Button/Flame Sense Models - FPPK Flex Series Specifications**

Size	Gas type	Nozzle	Std Model	Nozzle	Std Remote Small Tank Model	Burner	Max BTU	Nozzle BTU
18"	Natural Gas	TOR-	FPPK18-SQ-FLEX-NG	TOR-	FPPK18-SQ-FLEX-LP-ST*	12" Penta	65k	65k
24"	Natural Gas	TOR-	FPPK24-SQ-FLEX-NG	TOR-	FPPK24-SQ-FLEX-LP-ST*	18" Penta	90k	125k
30"	Natural Gas	TOR-	FPPK30-SQ-FLEX-NG			24" Penta	140k	150k
36"	Natural Gas	TOR-	FPPK36-SQ-FLEX-NG			30" Penta	140k	175k

See Pg. 9 for MLFPK System Features



**Match Lit Models - MLFPK Flex Series Specifications**

Size	Gas type	Nozzle	Std Model	Nozzle	Std Remote Small Tank Model	Burner	Max BTU	Nozzle BTU
18"	Natural Gas	TOR-	MLFPK18SQ-FLEX-NG	TOR-	MLFPK18SQ-FLEX-LP-ST*	12" Penta	65k	65k
24"	Natural Gas	TOR-	MLFPK24SQ-FLEX-NG	TOR-	MLFPK24SQ-FLEX-LP-ST*	18" Penta	65k	65k
30"	Natural Gas	TOR-	MLFPK30SQ-FLEX-NG	TOR-	MLFPK30SQ-FLEX-LP-ST*	18" Penta	65k	65k

**TO ORDER PROPANE MODELS "LP" Please Change out NG to LP**

**FPPK & MLFPK MODELS INCLUDE:** Insert: Fully Assembled and Instructions  
**SOLD SEPARATELY: (FPPK-MLFPK) Input Flex Line: SSC24: All models**



**\*IMPORTANT: On Small Tank Units** The BTU's are the same as the non Nozzle units

TOP SELLING SIZES

Need help? Use our fire pit selector at [hpcfire.com](http://hpcfire.com)

Match proper accessories to your fire pit model - see Pg. 60 - 61.

# RECTANGLE INSERT MODELS

# H-BURNER INSERTS

## EI Series



**24VAC MODELS REQUIRE HPC/SEBCO 24vac, 100W Power Supply for inserts ONLY pg. 55**



\*See page 8 for details

### Benefits of H-Burner Inserts:

Sidewall helps with media retention. Pan Lip makes for easy installation.

### Features of H-Burner Inserts:

Made of #304, 18 gauge Stainless Steel, Raised hub H-burner for water prevention, Bolted gas fitting for strength, Weep holes for drainage

\*Lifetime Warranty on burners

## MLFPK Series



## FPPK Series

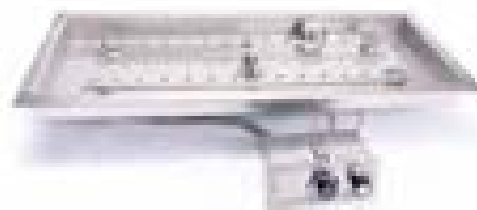

**SIK36 - MANUAL SPARK IGNITION** for match lit fire pits pg. 48

**\*IMPORTANT: On Small Tank Units** The BTU's are the same as the non Nozzle units

## ACCESSORIES

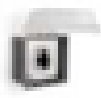

**EI Accessories (Pg. 55):**  
Timers, Power Supplies, E-Stop

**MLFPK Paver Bracket - Pg. 48**

**Wind Guards:**  
Pg. 45

**Media:**  
Pg. 43

20 **⚠ WARNING: California PROP 65:** This product can expose you to Lead & Chromium, which is known to the State of California to cause cancer and birth defects or other reproductive harm. For more information go to [www.P65Warnings.ca.gov](http://www.P65Warnings.ca.gov).

Inspired by safety. Innovated for your lifestyle.

See Pg. 10 for EI System Features



**Electronic Ignition Models - EI Series Specifications**

Size (A")	Power	Gas type	Torpedo Model - Flame ON/OFF	Torpedo Model - Bluetooth (HI/LO)	Burner	Nozzle BTU
24" X 12"	120vac	Natural Gas	TOR-24X12SSEI-H-NG/120VAC	TOR-24X12SSEI-H-HI/LO-NG/120V	18" X 6"	115k
	* 24vac	Natural Gas	TOR-24X12SSEI-H-NG/24VAC	TOR-24X12SSEI-H-HI/LO-NG/24VAC		
30" X 12"	120vac	Natural Gas	TOR-30X12SSEI-H-NG/120VAC	TOR-30X12SSEI-H-HI/LO-NG/120V	24" X 6"	150k
	* 24vac	Natural Gas	TOR-30X12SSEI-H-NG/24VAC	TOR-30X12SSEI-H-HI/LO-NG/24VAC		
36" X 14"	120vac	Natural Gas	TOR-36X14SSEI-H-NG/120VAC	TOR-36X14SSEI-H-HI/LO-NG/120V	30" X 8"	175k
	* 24vac	Natural Gas	TOR-36X14SSEI-H-NG/24VAC	TOR-36X14SSEI-H-HI/LO-NG/24VAC		
42" X 14"	120vac	Natural Gas	TOR-42X14SSEI-H-NG/120VAC	TOR-42X14SSEI-H-HI/LO-NG/120V	36" X 8"	200k
	* 24vac	Natural Gas	TOR-42X14SSEI-H-NG/24VAC	TOR-42X14SSEI-H-HI/LO-NG/24VAC		
54" X 16"	120vac	Natural Gas	TOR-54X16SSEI-H-NG/120VAC	TOR-54X16SSEI-H-HI/LO-NG/120V	48" X 10"	250k
	* 24vac	Natural Gas	TOR-54X16SSEI-H-NG/24VAC	TOR-54X16SSEI-H-HI/LO-NG/24VAC		
66" X 16"	120vac	Natural Gas	TOR-66X16SSEI-H-NG/120VAC	TOR-66X16SSEI-H-HI/LO-NG/120V	60" X 10"	300k
	* 24vac	Natural Gas	TOR-66X16SSEI-H-NG/24VAC	TOR-66X16SSEI-H-HI/LO-NG/24VAC		
78" X 16"	120vac	Natural Gas	TOR-78X16SSEI-H-NG/120VAC	TOR-78X16SSEI-H-HI/LO-NG/120V	72" X 10"	350k
	* 24vac	Natural Gas	TOR-78X16SSEI-H-NG/24VAC	TOR-78X16SSEI-H-HI/LO-NG/24VAC		
90" X 16"	120vac	Natural Gas	TOR-90X16SSEI-H-NG/120VAC		84" X 10"	400k
	* 24vac	Natural Gas	TOR-90X16SSEI-H-NG/24VAC			

**EI MODELS INCLUDE:** Insert: Fully Assembled. Flex Line: Gas Input and Instructions **\*IMPORTANT: 24vac Models REQUIRE HPC/ SEBCO 24vac, 100W Power Supply pg. 55**  
**SOLD SEPARATELY (EI INSERT):** On/Off Models 120VAC- Remote: 578-C: See Pg. 55.

**TOP SELLING SIZES**

See Pg. 9 for FPPK System Features



**Push Button/Flame Sense Models - FPPK Flex Series Specifications**

Size	Gas type	Torpedo Model	Torpedo Remote Small Tank Model	Burner	ST BTU	Nozzle BTU
24" X 12"	Natural Gas	TOR-FPPK24X12-H-FLEX-NG	TOR-FPPK24X12-H-FLEX-LP-ST*	18" X 6"	75k	115k
30" X 12"	Natural Gas	TOR-FPPK30X12-H-FLEX-NG	TOR-FPPK30X12-H-FLEX-LP-ST*	24" X 6"	90k	150k
36" X 14"	Natural Gas	TOR-FPPK36X14-H-FLEX-NG	TOR-FPPK36X14-H-FLEX-LP-ST*	30" X 8"	90k	150k
42" X 14"	Natural Gas	TOR-FPPK42X14-H-FLEX-NG		36" X 8"		200k
54" X 16"	Natural Gas	TOR-FPPK54X16-H-FLEX-NG		48" X 10"		200k

See Pg. 9 for MLFPK System Features



**Match Lit Models - MLFPK Flex Series Specifications**

Size	Gas type	Torpedo Model	Torpedo Remote Small Tank Model	Burner	ST BTU	Nozzle BTU
24" X 12"	Natural Gas	TOR-MLFPK24X12-H-FLEX-NG	TOR-MLFPK24X12-H-FLEX-LP-ST*	18" X 6"	65k	65k
30" X 12"	Natural Gas	TOR-MLFPK30X12-H-FLEX-NG	TOR-MLFPK30X12-H-FLEX-LP-ST*	24" X 6"	65k	65k
36" X 14"	Natural Gas	TOR-MLFPK36X14-H-FLEX-NG	TOR-MLFPK36X14-H-FLEX-LP-ST*	30" X 8"	65k	65k

**TO ORDER PROPANE MODELS "LP" Please Change out NG to LP**

**FPPK & MLFPK MODELS INCLUDE:** Insert: Fully Assembled and Instructions  
**SOLD SEPARATELY: (FPPK-MLFPK) Input Flex Line: SSC24: All models**



**\*IMPORTANT: On Small Tank Units** The BTU's are the same as the non Nozzle units

**TOP SELLING SIZES**

Match proper accessories to your fire pit model - see Pg. 60 - 61.

Need help? Use our fire pit selector at [hpcfire.com](http://hpcfire.com)

# LINEAR INSERT MODELS

## TROUGH INSERTS

### EI Series



**24VAC MODELS  
REQUIRE HPC/  
SEBCO 24vac, 100W  
Power Supply for  
inserts ONLY pg. 55**



*\*See page 8 for details*

#### Benefits of a Trough Insert:

*Sidewall helps with media retention. Pan Lip makes for easy installation.*

#### Features:

*Made of #304 Stainless Steel (48" and smaller- 18g, 60" and larger- 16g)*

#### Sidewalls:

*Adds rigidity, stronger than flat pans,  
Removable center section on larger models  
Raised hub T-Burner for water retention prevention  
Secure gas fittings for strength  
Weep holes for drainage  
\*Lifetime Warranty on burners*



**SIK36 -  
MANUAL SPARK  
IGNITION** for  
match lit fire pits  
pg. 48

### MLFPK Series



### FPPK Series



**\*IMPORTANT: On Small Tank Units** The BTU's are the same as the non Nozzle units

## ACCESSORIES



**EI Accessories (Pg. 55):**  
Timers, Power Supplies, E-Stop

**MLFPK Paver  
Bracket - Pg. 48**

**Wind Guards:**  
Pg. 45

**Media:**  
Pg. 43

See Pg. 10 for EI System Features

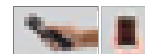

### Electronic Ignition Models - EI Series Specifications

Size	Power	Gas type	Torpedo Model - Flame ON/OFF	Torpedo Model - Bluetooth (HI/LO)	Burner	Nozzle BTU
24"	120vac * 24vac	Natural Gas Natural Gas	TOR-24SSEI-TRGH-NG/120VAC TOR-24SSEI-TRGH-NG/24VAC	TOR-24SSEI-TRGH-HI/LO-NG/120V TOR-24SSEI-TRGH-HI/LO-NG/24VAC	24"	75k
36"	120vac * 24vac	Natural Gas Natural Gas	TOR-36SSEI-TRGH-NG/120VAC TOR-36SSEI-TRGH-NG/24VAC	TOR-36SSEI-TRGH-HI/LO-NG/120V TOR-36SSEI-TRGH-HI/LO-NG/24VAC	36"	115k
48"	120vac * 24vac	Natural Gas Natural Gas	TOR-48SSEI-TRGH-NG/120VAC TOR-48SSEI-TRGH-NG/24VAC	TOR-48SSEI-TRGH-HI/LO-NG/120V TOR-48SSEI-TRGH-HI/LO-NG/24VAC	48"	150k
60"	120vac * 24vac	Natural Gas Natural Gas	TOR-60SSEI-TRGH-NG/120VAC TOR-60SSEI-TRGH-NG/24VAC	TOR-60SSEI-TRGH-HI/LO-NG/120V TOR-60SSEI-TRGH-HI/LO-NG/24VAC	60"	175k
72"	120vac * 24vac	Natural Gas Natural Gas	TOR-72SSEI-TRGH-NG/120VAC TOR-72SSEI-TRGH-NG/24VAC	TOR-72SSEI-TRGH-HI/LO-NG/120V TOR-72SSEI-TRGH-HI/LO-NG/24VAC	72"	200k
96"	120vac * 24vac	Natural Gas Natural Gas	TOR-96SSEI-TRGH-NG/120VAC TOR-96SSEI-TRGH-NG/24VAC	TOR-96SSEI-TRGH-HI/LO-NG/120V TOR-96SSEI-TRGH-HI/LO-NG/24VAC	96"	250k

**EI MODELS INCLUDE:** Insert: Fully Assembled. Flex Line: Gas Input and Instructions **\*IMPORTANT: 24vac Models REQUIRE HPC/ SEBCO 24vac, 100W Power Supply pg. 55**  
**SOLD SEPARATELY (EI INSERT):** On/Off Models 120VAC- Remote: 578-C: See Pg. 55.

See Pg. 9 for FPPK System Features



### Push Button/Flame Sense Models - FPPK Flex Series Specifications

Size	Gas type	Torpedo Model	Torpedo Remote Small Tank Model	Burner	ST BTU	Nozzle BTU
24"	Natural Gas	TOR-FPPK24-TRGH-FLEX-NG	TOR-FPPK24-TRGH-FLEX-LP-ST*	24" T-Burner	50k	75k
36"	Natural Gas	TOR-FPPK36-TRGH-FLEX-NG	TOR-FPPK36-TRGH-FLEX-LP-ST*	36" T-Burner	75k	115k
48"	Natural Gas	TOR-FPPK48-TRGH-FLEX-NG	TOR-FPPK48-TRGH-FLEX-LP-ST*	48" T-Burner	90k	150k
60"	Natural Gas	TOR-FPPK60-TRGH-FLEX-NG	TOR-FPPK60-TRGH-FLEX-LP-ST*	60" T-Burner	90k	175k
72"	Natural Gas	TOR-FPPK72-TRGH-FLEX-NG		72" T-Burner		200k
96"	Natural Gas	TOR-FPPK96-TRGH-FLEX-NG		96" T-Burner		250k

See Pg. 9 for MLFPK System Features



### Match Lit Models - MLFPK Flex Series Specifications

Size	Gas type	Torpedo Model	Torpedo Remote Small Tank Model	Burner	ST BTU	Nozzle BTU
24"	Natural Gas	TOR-MLFPK24 TRGH-FLEX-NG	TOR-MLFPK24 TRGH-FLEX-LP-ST*	24" T-Burner	50k	65k
36"	Natural Gas	TOR-MLFPK36 TRGH-FLEX-NG	TOR-MLFPK36 TRGH-FLEX-LP-ST*	36" T-Burner	65k	65k
48"	Natural Gas	TOR-MLFPK48 TRGH-FLEX-NG	TOR-MLFPK48 TRGH-FLEX-LP-ST*	48" T-Burner	65k	65k

**TO ORDER PROPANE MODELS "LP" Please Change out NG to LP**

**FPPK & MLFPK MODELS INCLUDE:** Insert: Fully Assembled and Instructions  
**SOLD SEPARATELY: (FPPK-MLFPK) Input Flex Line: SSC24: All models**



**\*IMPORTANT: On Small Tank Units** The BTU's are the same as the non Nozzle units

TOP SELLING SIZES

Need help? Use our fire pit selector at [hpcfire.com](http://hpcfire.com)

Match proper accessories to your fire pit model - see Pg. 60 - 61.

# LINEAR INSERT MODELS

## INTERLINK INSERTS

### El Series



**24VAC MODELS  
REQUIRE HPC/  
SEBCO 24vac, 100W  
Power Supply for  
inserts ONLY pg. 55**



*\*See page 8 for details*

#### Benefits of a Linear Insert:

Partial sidewall for media retention; installed in a recess mount application. Can be joined end to end to achieve a custom look.

#### Features:

Made of #304, 18 gauge Stainless Steel

#### Sidewalls:

Adds rigidity, stronger than flat pans,  
Removable center section on larger models  
Raised hub T-Burner for water retention prevention  
Secure gas fittings for strength  
Weep holes for drainage  
*\*Lifetime Warranty on burners*

### MLFPK Series



### FPPK Series



**\*IMPORTANT: On Small Tank Units** The BTU's are the same as the non Nozzle units



**SIK36 -  
MANUAL SPARK  
IGNITION** for  
match lit fire pits  
pg. 48

## ACCESSORIES



**El Accessories (Pg. 55):**  
Timers, Power Supplies, E-Stop

**MLFPK Paver  
Bracket - Pg. 48**

**Wind Guards:**  
Pg. 45

**Media:**  
Pg. 43

24 **⚠ WARNING: California PROP 65:** This product can expose you to Lead & Chromium, which is known to the State of California to cause cancer and birth defects or other reproductive harm. For more information go to [www.P65Warnings.ca.gov](http://www.P65Warnings.ca.gov).

Inspired by safety. Innovated for your lifestyle.



See Pg. 10 for EI System Features

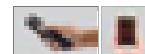

**Electronic Ignition Models - EI Series Specifications**

Size	Power	Gas type	Torpedo Model - Flame ON/OFF	Torpedo Model - Bluetooth (HI/LO)	Burner	Nozzle BTU
25" X 8"	120vac	Natural Gas	TOR-25X8SSEI-L-NG/120VAC	TOR-25X8SSEI-L-HI/LO-NG/120VAC	24"	75k
	* 24vac	Natural Gas	TOR-25X8SSEI-L-NG/24VAC	TOR-25X8SSEI-L-HI/LO-NG/24VAC		
37" X 8"	120vac	Natural Gas	TOR-37X8SSEI-L-NG/120VAC	TOR-37X8SSEI-L-HI/LO-NG/120VAC	36"	115k
	* 24vac	Natural Gas	TOR-37X8SSEI-L-NG/24VAC	TOR-37X8SSEI-L-HI/LO-NG/24VAC		
49" X 8"	120vac	Natural Gas	TOR-49X8SSEI-L-NG/120VAC	TOR-49X8SSEI-L-HI/LO-NG/120VAC	48"	150k
	* 24vac	Natural Gas	TOR-49X8SSEI-L-NG/24VAC	TOR-49X8SSEI-L-HI/LO-NG/24VAC		
61" X 8"	120vac	Natural Gas	TOR-61X8SSEI-L-NG/120VAC	TOR-61X8SSEI-L-HI/LO-NG/120VAC	60"	175k
	* 24vac	Natural Gas	TOR-61X8SSEI-L-NG/24VAC	TOR-61X8SSEI-L-HI/LO-NG/24VAC		
73" X 8"	120vac	Natural Gas	TOR-73X8SSEI-L-NG/120VAC	TOR-73X8SSEI-L-HI/LO-NG/120VAC	72"	200k
	* 24vac	Natural Gas	TOR-73X8SSEI-L-NG/24VAC	TOR-73X8SSEI-L-HI/LO-NG/24VAC		
97" X 8"	120vac	Natural Gas	TOR-97X8SSEI-L-NG/120VAC	TOR-97X8SSEI-L-HI/LO-NG/120VAC	96"	250k
	* 24vac	Natural Gas	TOR-97X8SSEI-L-NG/24VAC	TOR-97X8SSEI-L-HI/LO-NG/24VAC		
121" X 8"	120vac	Natural Gas	TOR-121X8SSEI-L-NG/120VAC	TOR-121X8SSEI-L-HI/LO-NG/120V	120"	300k
	* 24vac	Natural Gas	TOR-121X8SSEI-L-NG/24VAC	TOR-121X8SSEI-L-HI/LO-NG/24VAC		

**EI MODELS INCLUDE:** Insert: Fully Assembled. Flex Line: Gas Input and Instructions **\*IMPORTANT: 24vac Models REQUIRE HPC/ SEBCO 24vac, 100W Power Supply pg. 55**  
**SOLD SEPARATELY (EI INSERT):** On/Off Models 120VAC- Remote: 578-C: See Pg. 55.

**TOP SELLING SIZES**

See Pg. 9 for FPPK System Features

**Push Button/Flame Sense Models - FPPK Flex Series Specifications**

Size	Gas type	Torpedo Model	Torpedo Remote Small Tank Model	Burner	ST BTU	Nozzle BTU
25" X 8"	Natural Gas	TOR-FPPK25X8-L-FLEX-NG	TOR-FPPK25X8-L-FLEX-LP-ST*	24" T-Burner	50k	75k
37" X 8"	Natural Gas	TOR-FPPK37X8-L-FLEX-NG	TOR-FPPK37X8-L-FLEX-LP-ST*	36" T-Burner	75k	115k
49" X 8"	Natural Gas	TOR-FPPK49X8-L-FLEX-NG	TOR-FPPK49X8-L-FLEX-LP-ST*	48" T-Burner	90k	150k
61" X 8"	Natural Gas	TOR-FPPK61X8-L-FLEX-NG	TOR-FPPK61X8-L-FLEX-LP-ST*	60" T-Burner	90k	175k
73" X 8"	Natural Gas	TOR-FPPK73X8-L-FLEX-NG		72" T-Burner		200k
97" X 8"	Natural Gas	TOR-FPPK97X8-L-FLEX-NG		96" T-Burner		250k

See Pg. 9 for MLFPK System Features

**Match Lit Models - MLFPK Flex Series Specifications**

Size	Gas type	Torpedo Model	Torpedo Remote Small Tank Model	Burner	ST BTU	Nozzle BTU
25" X 8"	Natural Gas	TOR-MLFPK25X8-L-FLEX-NG	TOR-MLFPK25X8-L-FLEX-LP-ST*	24" T-Burner	50k	65k
37" X 8"	Natural Gas	TOR-MLFPK37X8-L-FLEX-NG	TOR-MLFPK37X8-L-FLEX-LP-ST*	36" T-Burner	65k	65k
49" X 8"	Natural Gas	TOR-MLFPK49X8-L-FLEX-NG	TOR-MLFPK49X8-L-FLEX-LP-ST*	48" T-Burner	65k	65k

**TO ORDER PROPANE MODELS "LP" Please Change out NG to LP**

**FPPK & MLFPK MODELS INCLUDE:** Insert: Fully Assembled and Instructions  
**SOLD SEPARATELY: (FPPK-MLFPK) Input Flex Line: SSC24: All models**

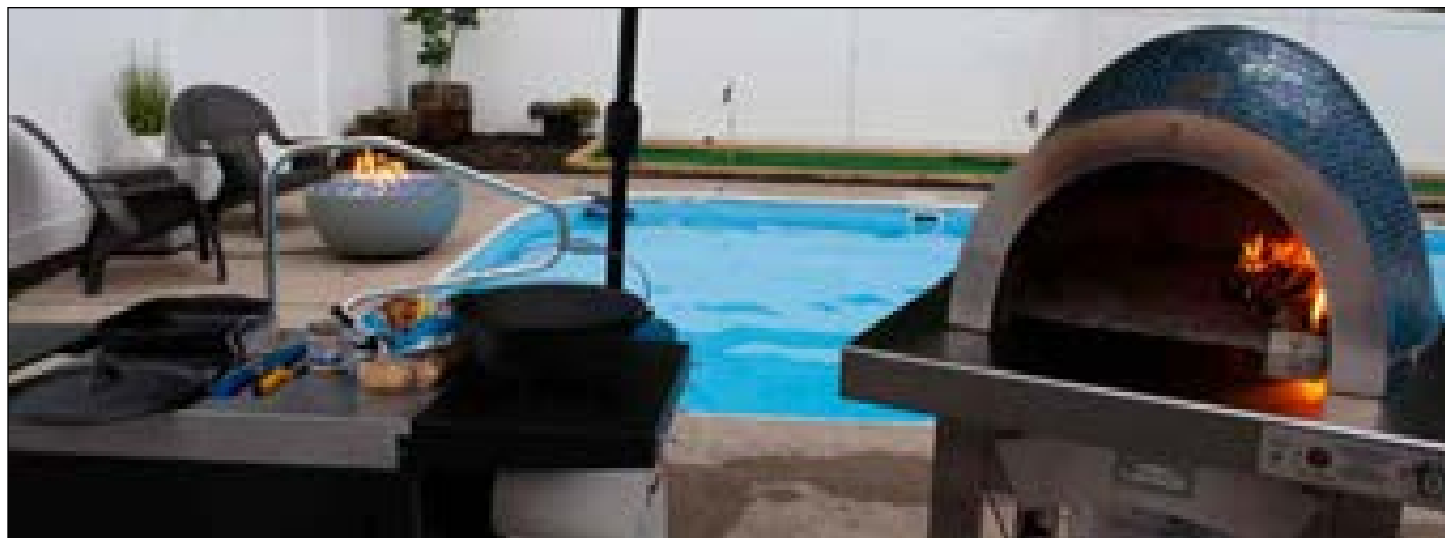

**\*IMPORTANT: On Small Tank Units** The BTU's are the same as the non Nozzle units

**TOP SELLING SIZES**

Match proper accessories to your fire pit model - see Pg. 60 - 61.

Need help? Use our fire pit selector at [hpcfire.com](http://hpcfire.com)

# OUTDOOR FIREPLACE BURNERS

## FIREPLACE SERIES ALL-IN-ONE BURNERS

HPC is broadening its horizons by adding outdoor fireplace burners. Ideally suited for retrofit or new construction applications. These Outdoor Fireplace Burners come in two distinctive styles: A Dual Step

Burner available in two sizes, 36" and 42", and a Linear Burner that comes in six sizes (up to 87" long)!

## SELLING POINTS

### Adjustable Feet

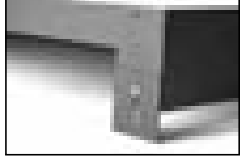

High Setting



Low Setting

### EI Pilot



### Two Designs: Dual Step & Linear

Linear Burners fit fireplaces that measure 36" up to 96"  
Bluetooth Electronic Ignition and Flame Sensing Models  
CSA Approved for Safety Assurance  
Low Profile with Multiple Media Choices  
NEMA-rated Valve for Weather Resistance  
Limited Lifetime Warranty on Burners and Pans



C US

CSA Certified

### Benefits of a Dual Step Insert:

Bluetooth Electronic Ignition and Flame Sensing Models  
CSA Certified for Safety Assurance  
Low Profile with Multiple Media Choices  
NEMA-rated Valve for Weather Resistance  
\*Lifetime Warranty on burners and pan

### PBFS Series

### EI Series

### Features:

Lifetime Warranty on Burners and Pans  
2 sizes available to fit the most popular outdoor fireplaces 36" & 42" in width  
H-Burner design with rear leg elevated  
Burner pan is rear height adjustable for flame presence flexibility  
Weep holes integrated in burner for water shedding  
Stainless Steel, Powder Coated Black

## DUAL STEP - H-BURNER - ELECTRONIC IGNITION (EI)

Size	Power	Gas type	Model - Flame ON/OFF	Model - Bluetooth (HI/LO)	Burner	Max BTU	Pan Size	Fits Fireplace Size
22"	120vac	Natural Gas	DBOF22EI-NG/120VAC	DBOF22EI-HI/LO-NG/120VAC	21"	90k	22" X 10"	36"
	24vac	Natural Gas	DBOF22EI-NG/24VAC	DBOF22EI-HI/LO-NG/24VAC	21"	90k	22" X 10"	36"
28"	120vac	Natural Gas	DBOF28EI-NG/120VAC	DBOF28EI-HI/LO-NG/120VAC	27"	110k	28" X 10"	42"
	24vac	Natural Gas	DBOF28EI-NG/24VAC	DBOF28EI-HI/LO-NG/24VAC	27"	110k	28" X 10"	42"

## DUAL STEP - H-BURNER - PUSH BUTTON / FLAME SENSING (PBFS) WITH CONTROL BOX

Size	Gas type	Model	Burner	Max BTU	Pan Size	Fits Fireplace size
27"	Natural Gas	DBOF27PBFS-NG	21"	90k	27" X 10"	36"
33"	Natural Gas	DBOF33PBFS-NG	27"	110k	33" X 10"	42"

## TO ORDER PROPANE MODELS "LP" Please Change out NG to LP

**EI Series**



**Benefits of a Linear Insert:**

- Bluetooth Electronic Ignition and Flame Sensing Models
- CSA Certified for Safety Assurance
- Linear Burners fit fireplaces that measure 36" up to 96"
- Low Profile with Multiple Media Choices
- NEMA-rated Valve for Weather Resistance
- \*Lifetime Warranty on burners and pan



CSA Certified

**PBFS Series**

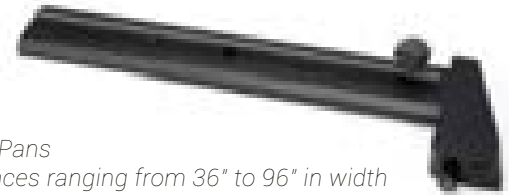

**Features:**

- Lifetime Warranty on Burners and Pans
- 6 sizes available for outdoor fireplaces ranging from 36" to 96" in width
- Low Profile burner design
- Weep holes integrated in burner for water shedding
- Stainless Steel, Powder Coated Black

**LINEAR - ELECTRONIC IGNITION (EI)**

Size	Power	Gas type	Model - Flame ON/OFF	Model - Bluetooth (HI/LO)	Burner	Max BTU	Pan Size	Fits Fireplace Size
22"	120vac	Natural Gas	LBOF22EI-NG/120VAC	LBOF22EI-HI/LO-NG/120VAC	21"	50k	22" X 6"	36"
	24vac	Natural Gas	LBOF22EI-NG/24VAC	LBOF22EI-HI/LO-NG/24VAC	21"	50k	22" X 6"	36"
28"	120vac	Natural Gas	LBOF28EI-NG/120VAC	LBOF28EI-HI/LO-NG/120VAC	27"	75k	28" X 6"	42"
	24vac	Natural Gas	LBOF28EI-NG/24VAC	LBOF28EI-HI/LO-NG/24VAC	27"	75k	28" X 6"	42"
46"	120vac	Natural Gas	LBOF46EI-NG/120VAC	LBOF46EI-HI/LO-NG/120VAC	45"	100k	46" X 6"	60"
	24vac	Natural Gas	LBOF46EI-NG/24VAC	LBOF46EI-HI/LO-NG/24VAC	45"	100k	46" X 6"	60"
58"	120vac	Natural Gas	LBOF58EI-NG/120VAC	LBOF58EI-HI/LO-NG/120VAC	57"	110k	58" X 6"	72"
	24vac	Natural Gas	LBOF58EI-NG/24VAC	LBOF58EI-HI/LO-NG/24VAC	57"	110k	58" X 6"	72"
70"	120vac	Natural Gas	LBOF70EI-NG/120VAC	LBOF70EI-HI/LO-NG/120VAC	69"	120k	70" X 6"	84"
	24vac	Natural Gas	LBOF70EI-NG/24VAC	LBOF70EI-HI/LO-NG/24VAC	69"	120k	70" X 6"	84"
82"	120vac	Natural Gas	LBOF82EI-NG/120VAC	LBOF82EI-HI/LO-NG/120VAC	81"	130k	82" X 6"	96"
	24vac	Natural Gas	LBOF82EI-NG/24VAC	LBOF82EI-HI/LO-NG/24VAC	81"	130k	82" X 6"	96"

**LINEAR - PUSH BUTTON / FLAME SENSING (PBFS) WITH CONTROL BOX**

Size	Gas type	Model	Burner	Max BTU	Pan Size	Fits Fireplace size
27"	Natural Gas	LBOF27PBFS-NG	21"	50k	27" X 10"	36"
33"	Natural Gas	LBOF33PBFS-NG	27"	75k	33" X 10"	42"
51"	Natural Gas	LBOF51PBFS-NG	45"	100k	51" X 10"	60"
63"	Natural Gas	LBOF63PBFS-NG	57"	110k	63" X 10"	72"
75"	Natural Gas	LBOF75PBFS-NG	69"	120k	75" X 10"	84"
87"	Natural Gas	LBOF87PBFS-NG	81"	130k	87" X 10"	96"



**TOP SELLING SIZES**

Need help? Use our fire pit selector at [hpcfire.com](http://hpcfire.com)

# READY TO FINISH COMPLETE KITS

## COMPLETE FIRE PIT PACKAGES

These units are unfinished, allowing customers to select from materials such as: stone, veneer, or stucco to match the surroundings. RTF units are available in round, octagon, square, and linear shapes. Housings take the guess work out of enclosure construction. The RTF are 18" tall and are constructed from sturdy 22 gauge galvanized steel material, have a welded frame, and a 1/2" hardie board shell weighing 150 lbs.

**Enclosures ship from our North Carolina warehouse on a pallet; Fire Pits ship from Ohio warehouse.**

HPC offers complete fire pit packages that include unfinished enclosures fitted with a certified remote electronic ignition (EI), push button/flame sensing (FPPK) or match lit (MLFPK) fire pit insert.

**Now, certain models are available sized to fit a small LP tank inside, with a door included. See page 32.**



## ROUND ENCLOSURE - PENTA BURNER - SPECIFICATIONS



**EI Models Include:** Enclosure, Fully Assembled Insert, Input Flex Line and Instructions

**FPPK Models Include:** Enclosure, Fully Assembled Insert, Mounting Sleeve and Instructions

**MLFPK Models Include:** Enclosure, Fully Assembled Insert and Instructions

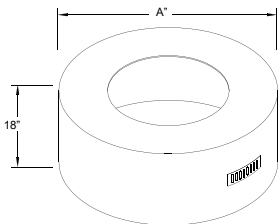
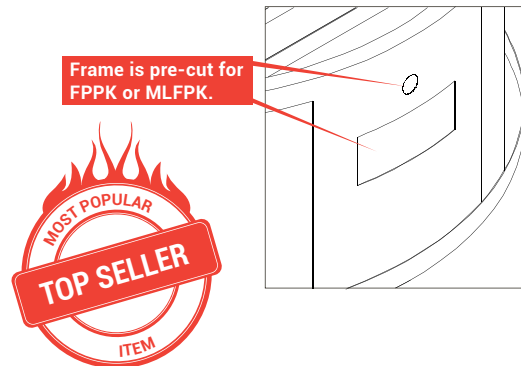

**Size:** 45" diameter, 18" tall  
**Insert:** 25" Bowl Pan, 18" Penta  
**Cladding SQ FT:**  
 Side: 18.5 - Top: 8.1 - Total: 26.6  
 Includes 10% Buffer

**Size:** 54" diameter, 18" tall  
**Insert:** 25" Bowl Pan, 18" Penta  
**Cladding SQ FT:**  
 Side: 21.1 - Top: 13.5 - Total: 34.6  
 Includes 10% Buffer

Ignition	Size (A")	Power	Gas type	Nozzle	Std Model	Max BTU	Nozzle BTU
Electronic Ignition	45"	120VAC	Natural Gas	TOR	U45R/25SSCEK-NG/120VAC	125k	140k
		24VAC	Natural Gas	TOR	U45R/25SSCEK-NG/24VAC		
	54"	120VAC	Natural Gas	TOR	U54R/25SSCEK-NG/120VAC	125k	140k
		24VAC	Natural Gas	TOR	U54R/25SSCEK-NG/24VAC		
Push Button-	45"		Natural Gas	TOR	U45R/FPPK25CEK-NG	90k	140k
			Natural Gas	TOR	U54R/FPPK25CEK-NG	90k	140k
Match Lit	45"		Natural Gas	TOR	U45R/MLFPK25CEK-NG	65k	65k
			Natural Gas	TOR	U54R/MLFPK25CEK-NG	65k	65k

**TO ORDER PROPANE MODELS "LP" Please Change out NG to LP**

28 **WARNING: California PROP 65:** This product can expose you to Lead & Chromium, which is known to the State of California to cause cancer and birth defects or other reproductive harm. For more information go to [www.P65Warnings.ca.gov](http://www.P65Warnings.ca.gov).

Inspired by safety. Innovated for your lifestyle.

**OCTAGON ENCLOSURE- PENTA BURNER - SPECIFICATIONS**



**EI Models Include:** Enclosure, Fully Assembled Insert, Input Flex Line and Instructions

**FPPK Models Include:** Enclosure, Fully Assembled Insert, Mounting Sleeve and Instructions

**MLFPK Models Include:** Enclosure, Fully Assembled Insert and Instructions

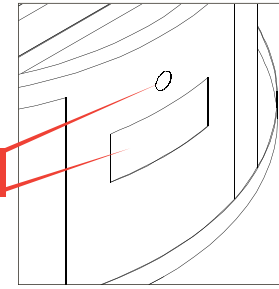

Frame is pre-cut for FPPK or MLFPK.

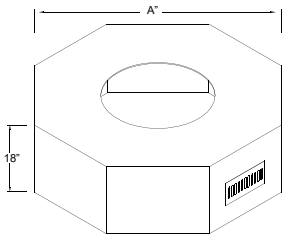

**Size:** 45" diameter, 18" tall  
**Insert:** 25" Bowl Pan, 18" Penta  
**Cladding SQ FT:**  
 Sides: 21 - Top: 9.3 - Total: 30.3  
 Includes 10% Buffer

Ignition	Size (A")	Power	Gas type	Nozzle	Std Model	Max BTU	Nozzle BTU
Electronic Ignition	45"	120VAC	Natural Gas	TOR	U45O/25SSCEK-NG/120VAC	125k	140k
		24VAC	Natural Gas	TOR	U45O/25SSCEK-NG/24VAC		
Push Button-	45"	120VAC	Natural Gas	TOR	U54O/25SSCEK-NG/120VAC	125k	140k
			Natural Gas	TOR	U54O/25SSCEK-NG/24VAC		
Match Lit	45"	24VAC	Natural Gas	TOR	U45O/FPPK25CEK-NG	90k	140k
			Natural Gas	TOR	U54O/FPPK25CEK-NG		
	54"	24VAC	Natural Gas	TOR	U45O/MLFPK25CEK-NG	65k	65k
			Natural Gas	TOR	U54O/MLFPK25CEK-NG		

**Size:** 54" diameter, 18" tall  
**Insert:** 25" Bowl Pan, 18" Penta  
**Cladding SQ FT:**  
 Sides: 24.6 - Top: 14.4 - Total: 39  
 Includes 10% Buffer

**SQUARE ENCLOSURE - PENTA BURNER - SPECIFICATIONS**



**EI Models Include:** Enclosure, Fully Assembled Insert, Input Flex Line and Instructions

**FPPK Models Include:** Enclosure, Fully Assembled Insert, Mounting Sleeve and Instructions

**MLFPK Models Include:** Enclosure, Fully Assembled Insert and Instructions

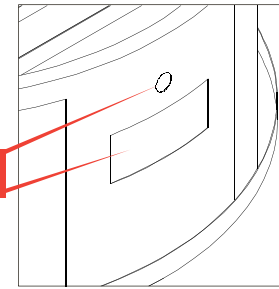

Frame is pre-cut for FPPK or MLFPK.

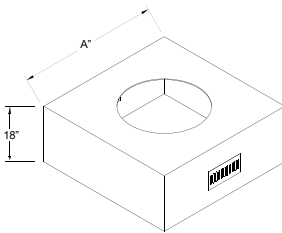

**Size:** 45" X 45", 18" tall  
**Insert:** 25" Bowl Pan, 18" Penta  
**Cladding SQ FT:**  
 Sides: 11.5 - Top: 22.5 - Total: 34  
 Includes 10% Buffer

Ignition	Size (A")	Power	Gas type	Nozzle	Std Model	Max BTU	Nozzle BTU
Electronic Ignition	45"	120VAC	Natural Gas	TOR	U45S/25SSCEK-NG/120VAC	125k	140k
		24VAC	Natural Gas	TOR	U45S/25SSCEK-NG/24VAC		
Push Button	45"		Natural Gas	TOR	U45S/FPPK25CEK-NG	90k	140k
Match Lit	45"		Natural Gas	TOR	U45S/MLFPK25CEK-NG	65k	65k



# READY TO FINISH COMPLETE KITS

## RECTANGLE ENCLOSURE - INTERLINK BURNER - SPECIFICATIONS



**EI Models Include:** Enclosure, Fully Assembled Insert, Input Flex Line and Instructions

**FPPK Models Include:** Enclosure, Fully Assembled Insert, Mounting Sleeve and Instructions

**MLFPK Models Include:** Enclosure, Fully Assembled Insert and Instructions

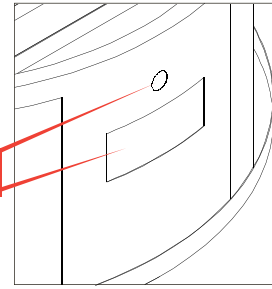

FRAME IS PRE-CUT FOR FPPK OR MLFPK.

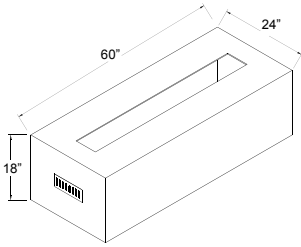

Ignition	Insert	Power	Gas type	Torpedo Model	Nozzle BTU
Electronic Ignition (EI)	37" X 8"	120VAC	Natural Gas	TOR-U60X24/37X8CEK-NG/120VAC	115k
		24VAC	Natural Gas	TOR-U60X24/37X8CEK-NG/24VAC	
	49" X 8"	120VAC	Natural Gas	TOR-U60X24/49X8CEK-NG/120VAC	150k
		24VAC	Natural Gas	TOR-U60X24/49X8CEK-NG/24VAC	
Push Button- (FPPK)	37" X 8"		Natural Gas	TOR-U60X24/37X8FPPKCEK-NG	115k
			Natural Gas	TOR-U60X24/49X8FPPKCEK-NG	150k
Match Lit (MLFPK)	37" X 8"		Natural Gas	TOR-U60X24/37X8MLFPKCEK-NG	65k
			Natural Gas	TOR-U60X24/49X8MLFPKCEK-NG	65k

**Size:** 60" X 24", 18" tall  
**Insert:** 37" X 8" Interlink

**Cladding SQ FT:**

Side: 22.5 - Top: 8.6 - Total: 31.3  
Includes 10% Buffer

**Size:** 60" X 24", 18" tall  
**Insert:** 49" X 8" Interlink

**Cladding SQ FT:**

Side: 22.5 - Top: 8 - Total: 30.5  
Includes 10% Buffer

## RECTANGLE ENCLOSURE - TROUGH BURNER - SPECIFICATIONS



**EI Models Include:** Enclosure, Fully Assembled Insert, Input Flex Line and Instructions

**FPPK Models Include:** Enclosure, Fully Assembled Insert, Mounting Sleeve and Instructions

**MLFPK Models Include:** Enclosure, Fully Assembled Insert and Instructions

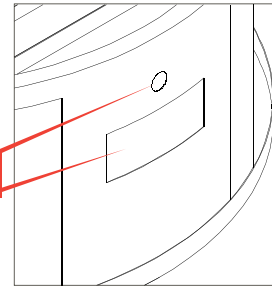

Frame is pre-cut for FPPK or MLFPK.

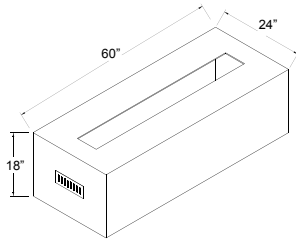

Ignition	Insert	Power	Gas type	Torpedo Model	Nozzle BTU
Electronic Ignition (EI)	36"	120VAC	Natural Gas	TOR-U60X24/36CEK-NG/120VAC	115k
		24VAC	Natural Gas	TOR-U60X24/36CEK-NG/24VAC	
	48"	120VAC	Natural Gas	TOR-U60X24/48CEK-NG/120VAC	150k
		24VAC	Natural Gas	TOR-U60X24/48CEK-NG/24VAC	
Push Button- (FPPK)	36"		Natural Gas	TOR-U60X24/36FPPKCEK-NG	115k
			Natural Gas	TOR-U60X24/48FPPKCEK-NG	150k
Match Lit (MLFPK)	36"		Natural Gas	TOR-U60X24/36MLFPKCEK-NG	65k
			Natural Gas	TOR-U60X24/48MLFPKCEK-NG	65k

**Size:** 60" X 24", 18" tall  
**Insert:** 36" Trough

**Cladding SQ FT:**

Side: 22.5 - Top: 9.2 - Total: 31.7  
Includes 10% Buffer

**Size:** 60" X 24", 18" tall  
**Insert:** " Trough

**Cladding SQ FT:**

Side: 22.5 - Top: 8.7 - Total: 31.2  
Includes 10% Buffer

## TO ORDER PROPANE MODELS "LP" Please Change out NG to LP

**RECTANGLE ENCLOSURE - H-BURNER - SPECIFICATIONS**



**EI Models Include:** Enclosure, Fully Assembled Insert, Input Flex Line and Instructions

**FPPK Models Include:** Enclosure, Fully Assembled Insert, Mounting Sleeve and Instructions

**MLFPK Models Include:** Enclosure, Fully Assembled Insert and Instructions

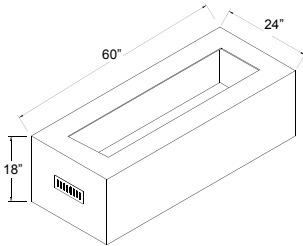
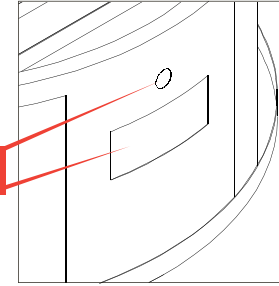

**Size:** 60" X 24", 18" tall  
**Insert:** 30" X 12" H-Burner  
**Cladding SQ FT:**  
 Side: 22.5 - Top: 8.1 - Total: 30.6  
 Includes 10% Buffer

Ignition	Insert	Power	Gas type	Torpedo Model	Nozzle BTU
<b>Electronic Ignition (EI)</b>	<b>30"X12"</b>	120VAC 24VAC	Natural Gas Natural Gas	TOR-U60X24/30X12CEK-NG/120VAC TOR-U60X24/30X12CEK-NG/24VAC	150k
	<b>36"X12"</b>	120VAC 24VAC	Natural Gas Natural Gas	TOR-U60X24/36X14CEK-NG/120VAC TOR-U60X24/36X14CEK-NG/24VAC	175k
<b>Push Button- (FPPK)</b>	<b>30"X12"</b>		Natural Gas	TOR-U60X24/30X12FPPKCEK-NG	150k
	<b>36"X12"</b>		Natural Gas	TOR-U60X24/36X14FPPKCEK-NG	150k
<b>Match Lit (MLFPK)</b>	<b>30"X12"</b>		Natural Gas	TOR-U60X24/30X12MLFPKCEK-NG	65k
	<b>36"X12"</b>		Natural Gas	TOR-U60X24/36X14MLFPKCEK-NG	65k

**Size:** 60" X 24", 18" tall  
**Insert:** 36" X 14" H-Burner  
**Cladding SQ FT:**  
 Side: 22.5 - Top: 7 - Total: 29.5  
 Includes 10% Buffer



**Changes to The EI System**

Reduced height from 14" to 7.5 for easier installation, and allows for more shallow mounts.  
 Universal Gas orifice utilized in the new units allowing for quick NG to LP switch  
 All On/Off units will now include trimmer valve



Old EI box

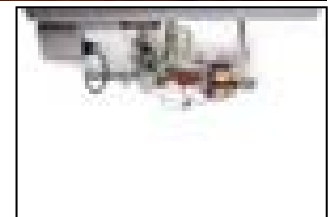

New EI box

# READY TO FINISH SMALL TANK SERIES



CSA Certified

## SQUARE ENCLOSURE - SMALL TANK - PENTA BURNER - SPECIFICATIONS

**Size:** 54" x 54" diameter, 23.5" tall  
**Insert:** 25" Bowl Pan, 18" Penta

**Cladding SQ FT:**  
Side: 35.5 - Top: 9.5 - Total: 45  
*Includes 10% Buffer*

Ignition	Size (A")	Gas type	Nozzle	Std Model	Max BTU	Nozzle BTU
Push Button - Flame Sense (FPPK)	54"	Liquid Propane	TOR	UST54S/FPPK25CEK-LP	90k	90k
Match Lit (MLFPK)	54"	Liquid Propane	TOR	UST54S/MLFPK25CEK-LP	65k	65k

## ROUND ENCLOSURE - SMALL TANK - PENTA BURNER - SPECIFICATIONS

**Size:** 60" diameter, 23.5" tall  
**Insert:** 25" Bowl Pan, 18" Penta

**Cladding SQ FT:**  
Side: 30.5 - Top: 17.5 - Total: 48  
*Includes 10% Buffer*

Ignition	Size (A")	Gas type	Nozzle	Std Model	Max BTU	Nozzle BTU
Push Button - Flame Sense (FPPK)	60"	Liquid Propane	TOR	UST60R/FPPK25CEK-LP	90k	90k
Match Lit (MLFPK)	60"	Liquid Propane	TOR	UST60R/MLFPK25CEK-LP	65k	65k

## RECTANGLE ENCLOSURE - SMALL TANK - TROUGH BURNER - SPECIFICATIONS

**Size:** 70" x 24" diameter, 23.5" tall  
**Insert:** 36" Trough

**Cladding SQ FT:**  
Side: 30.5 - Top: 11 - Total: 41.5  
*Includes 10% Buffer*

**Size:** 80" x 24" diameter, 23.5" tall  
**Insert:** 48" Trough

**Cladding SQ FT:**  
Side: 34 - Top: 12.5 - Total: 46.5  
*Includes 10% Buffer*

Ignition	Size (A")	Gas type	Torpedo Model	Nozzle BTU
Push Button - Flame Sense (FPPK)	70x24"	Liquid Propane	TOR-UST70X24/36FPPKCEK-LP	90k
Match Lit (MLFPK)	70x24"	Liquid Propane	TOR-UST70X24/36MLFPKCEK-LP	65k
Push Button - Flame Sense (FPPK)	80x24"	Liquid Propane	TOR-UST80X24/48FPPKCEK-LP	90k
Match Lit (MLFPK)	80x24"	Liquid Propane	TOR-UST80X24/48MLFPKCEK-LP	65k

## RECTANGLE ENCLOSURE - SMALL TANK - H-BURNER - SPECIFICATIONS

**Size:** 70" x 24" diameter, 23.5" tall  
**Insert:** 36" x 14" H-Burner

**Cladding SQ FT:**  
Side: 30.5 - Top: 11 - Total: 41.5  
*Includes 10% Buffer*

Ignition	Size (A")	Gas type	Torpedo Model	Nozzle BTU
Push Button - Flame Sense (FPPK)	70x24"	Liquid Propane	TOR-UST70X24/36X14FPPKCEK-LP	90k
Match Lit (MLFPK)	70x24"	Liquid Propane	TOR-UST70X24/36X14MLFPKCEK-LP	65k

## RECTANGLE ENCLOSURE - SMALL TANK - INTERLINK BURNER - SPECIFICATIONS

**Size:** 80" x 24" diameter, 23.5" tall  
**Insert:** 49" x 8" Interlink

**Cladding SQ FT:**  
Side: 34 - Top: 11.5 - Total: 45.5  
*Includes 10% Buffer*

Ignition	Size (A")	Gas type	Torpedo Model	Nozzle BTU
Push Button - Flame Sense (FPPK)	80x24"	Liquid Propane	TOR-UST80X24/49X8FPPKCEK-LP	90k
Match Lit (MLFPK)	80x24"	Liquid Propane	TOR-UST80X24/49X8MLFPKCEK-LP	65k

32 **WARNING: California PROP 65:** This product can expose you to Lead & Chromium, which is known to the State of California to cause cancer and birth defects or other reproductive harm. For more information go to [www.P65Warnings.ca.gov](http://www.P65Warnings.ca.gov).

Inspired by safety. Innovated for your lifestyle.



# TK TORCH

## BACKYARD FIRE EFFECTS THAT WILL WOW ANYONE

HPC TK torch brings resort style living to your own back yard. No more picking up fuel or messing with oils or gels. These torches are state of the art, very robust, reliable, and built to last.

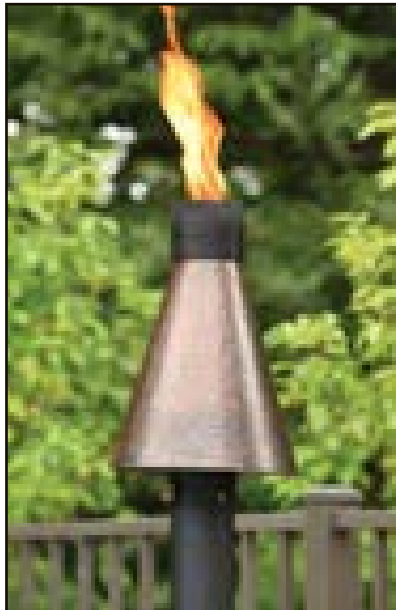

### ACCESSORIES

**FPC-TK TORCH**  
Pg. 47

**940-POSTMOUNT**

**940-POST**

**580**  
Pg. 52

**Features:**  
 Burner assembly made of rugged #304 stainless steel for durability.  
 Outdoor powder coated post.  
 Built for Natural Gas or LP.  
 3-year warranty on hardware; 1-year warranty on gas controls.  
 Kano tops available in 2 styles: Hammered Copper or Black Finish  
 Available Head Only assembly for column mounting.

### Specifications - Match Lit (MLFPK)

Color	Style	Gas type	Models	Max BTU
Black	Complete with 96" Post	Natural Gas	TK40MAN-B-NG	25k
	Tiki Top Only	Natural Gas	TKHEAD40MAN-B-NG	25k
Copper	Complete with 96" Post	Natural Gas	TK40MAN-C-NG	25k
	Tiki Top Only	Natural Gas	TKHEAD40MAN-C-NG	25k

**TO ORDER PROPANE MODELS "LP" Please Change out NG to LP**

Size: 84" Tall (with 12" underground)  
 Burner: TK

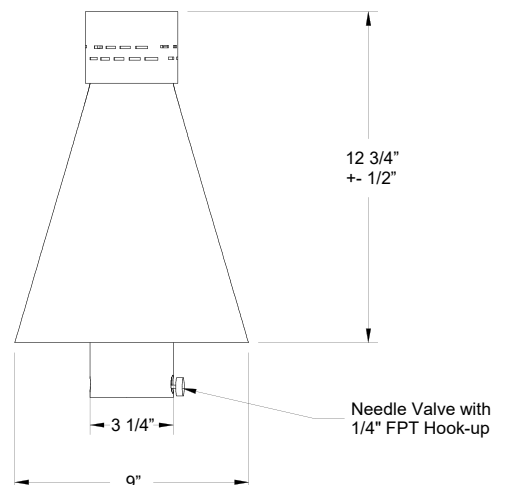

# COPPER BOWL SERIES

The HPC Copper Bowl Series is available in the Fire Bowl or the Pool Side Fire & Water Bowl models. Both versions are fitted with a CSA Certified match lit (MLFPK) or remote electronic ignition (EI) fire pit insert; and has option to connect with Liquid Propane or Natural Gas. Choose your style, as the Copper Series is available in a hammered or smooth finish. The Pool Side Fire &

Water Bowls utilize 1" FIP fitting for pool pump connection. **SHIPPING: Both bowl and fire pit insert ship from our Ohio warehouse - crated on pallet.** Fire-and-water models now available in 12V for pool side applications.



## MESA



Mesa Fire Bowl



Mesa Fire & Water Bowl

### MESA MODELS - REAL HAMMERED COPPER

This round hammered bowl has an oil-rubbed finish. Includes Access Door.

**Size:** 32" diameter, 15" tall, 15" base  
**Burner:** 12" Penta **Pan:** 18" Flat

**12vac Models** require HPC/SEBCO 12vac, 100W Power Supply for copper ONLY **pg. 55**

### SPECIFICATIONS

Ignition	Bowl Type	Power	Gas type	Nozzle	Std Models	Max BTU	Nozzle BTU
Electronic Ignition	Fire	120vac	Natural Gas	TOR	MESA32-EI-NG/120VAC	50k	50k
	Fire	24vac	Natural Gas	TOR	MESA32-EI-NG/24VAC	50k	50k
	Fire Water	12vac	Natural Gas	TOR	MESA32W-EI-NG/12VAC	50k	50k
Match Lit	Fire		Natural Gas	TOR	MESA32-MLFPK-NG	50k	50k
	Fire Water		Natural Gas	TOR	MESA32W-MLFPK-NG	50k	50k

# SEDONA



Sedona Fire Bowl

Sedona Fire & Water Bowl

## SEDONA MODELS - REAL HAMMERED COPPER

This square hammered bowl has an oil rubbed finish. Includes Access Door.

**Size:** 40" x 40", 16" tall, 20" x 20" base  
**Burner:** 18" Penta **Pan:** 25" Bowl

**12vac Models** require HPC/SEBCO 12vac, 100W Power Supply for copper ONLY **pg. 55**

### SPECIFICATIONS

Ignition	Bowl Type	Power	Gas type	Nozzle	Std Models	Max BTU	Nozzle BTU
Electronic Ignition	Fire	120vac	Natural Gas	TOR	SEDO40-EI-NG/120VAC	100k	100k
	Fire	24vac	Natural Gas	TOR	SEDO40-EI-NG/24VAC	100k	100k
	Fire Water	12vac	Natural Gas	TOR	SEDO40W-EI-NG/12VAC	100k	100k
Match Lit	Fire		Natural Gas	TOR	SEDO40-MLFPK-NG	65k	65k
	Fire Water		Natural Gas	TOR	SEDO40W-MLFPK-NG	65k	65k

# TEMPE



Tempe Fire Bowl

Tempe Fire & Water Bowl

## TEMPE MODELS - REAL HAMMERED COPPER

This round hammered bowl has an oil rubbed finish. Controls sit below bowl.

**Size:** 31" diameter, 10.5" tall, 10" base  
**Burner:** 12" Penta **Pan:** 19" Bowl

*Tempe - Controls below bowl*

**12vac Models** require HPC/SEBCO 12vac, 100W Power Supply for copper ONLY **pg. 55**

### SPECIFICATIONS

Ignition	Bowl Type	Power	Gas type	Nozzle	Std Models	Max BTU	Nozzle BTU
Electronic Ignition	Fire	120vac	Natural Gas	TOR	TEMP31-EI-NG/120VAC	50k	50k
	Fire	24vac	Natural Gas	TOR	TEMP31-EI-NG/24VAC	50k	50k
	Fire Water	12vac	Natural Gas	TOR	TEMP31W-EI-NG/12VAC	50k	50k
Match Lit	Fire		Natural Gas	TOR	TEMP31-MLFPK-NG	50k	50k
	Fire Water		Natural Gas	TOR	TEMP31W-MLFPK-NG	50k	50k



**TO ORDER PROPANE MODELS "LP" Please Change out NG to LP**

Need help? Use our fire pit selector at [hpcfire.com](http://hpcfire.com)

# COPPER BOWL SERIES

The HPC Phoenix Copper Bowl is available in Fire Bowl models only. All three versions are fitted with a CSA Certified match lit (MLFPK), push button flame sensing (FPPK) or remote electronic ignition (EI) fire pit insert and are available with either Liquid

Propane or Natural Gas. These come in an oil rubbed or hand hammered finish that is a beautiful work of art.

**SHIPPING: Both bowl and fire pit insert ship from Ohio warehouse - crate on pallet.**

## SIERRA



Sierra Fire Bowl

Sierra Fire & Water Bowl

### SIERRA MODELS - SMOOTH COPPER FINISH

This square smooth bowl has an oil-rubbed finish. Includes Access Door.

**Size:** 36" x 36", 16" tall, 18" x 18" base  
**Burner:** 12" Penta **Pan:** 19" Bowl

**12vac Models** require HPC/SEBCO 12vac, 100W Power Supply for copper ONLY **pg. 55**

### SPECIFICATIONS

Ignition	Bowl Type	Power	Gas type	Nozzle	Std Models	Max BTU	Nozzle BTU
Electronic Ignition	Fire	120vac	Natural Gas	TOR	SIER36-EI-NG/120VAC	50k	50k
	Fire	24vac	Natural Gas	TOR	SIER36-EI-NG/24VAC	50k	50k
	Fire Water	12vac	Natural Gas	TOR	SIER36W-EI-NG/12VAC	50k	50k
Match Lit	Fire		Natural Gas	TOR	SIER36-MLFPK-NG	50k	50k
	Fire Water		Natural Gas	TOR	SIER36W-MLFPK-NG	50k	50k

# PHOENIX H-BURNER



Phoenix H-Burner

**Size:** 47" Length, 25" Width, 18" tall, 13" base

**Burner:** 30" H-Burner **Pan:** 36" x 14"

### PHOENIX H-BURNER SPECIFICATIONS

Ignition	Bowl Type	Power	Gas type	Torpedo Models	Nozzle BTU
Electronic Ignition	Fire	120vac	Natural Gas	TOR-PHOEN47X25/H-EI-NG/120VAC	100k
Push Button Flame	Fire		Natural Gas	TOR-PHOEN47X25/HBURN-FPPK-NG	90k
Match Lit	Fire		Natural Gas	TOR-PHOEN47X25/HBURN-MLFPK-NG	65k

# PHOENIX TROUGH



Phoenix Trough

All Phoenix models come Ventilated



**Size:** 47" Length, 25" Width, 18" tall, 13" base  
**Burner:** 36" Linear Burner Trough  
**Pan:** 36" Trough

## PHOENIX TROUGH SPECIFICATIONS

Ignition	Bowl Type	Power	Gas type	Std Models	Nozzle BTU
Electronic Ignition	Fire	120vac	Natural Gas	TOR-PHOEN47X25/TRGH-EI-NG/120V	75k
Push Button Flame	Fire		Natural Gas	TOR-PHOEN47X25/TRGH-FPPK-NG	75k
Match Lit	Fire		Natural Gas	TOR-PHOEN47X25/TRGH-MLFPK-NG	65k



**TO ORDER PROPANE MODELS "LP" Please Change out NG to LP**

 Need help? Use our fire pit selector at [hpcfire.com](http://hpcfire.com)

# SPORT PIT

The HPC Sport Pit Series is a camper's, tailgater's, and backyard hanger's dream. Sealed with a lid that spins on with the twist of a wrist, which keeps the glass media in place. Offered with a handle

for easy transport; HPC's Sport Pit is a perfect fire pit for anyone on the go. There is a quick LP Tank hookup that allows for easy setup and teardown.



*CSA Certified*



## SPORT PIT - EASY TO TRANSPORT FIRE PIT

This Portable Fire Pit has the ability for the lid to spin on for easy transportation.

- Burntime with a 20lb tank is 13 hours
- Tip-over switch insures safety
- Thermocouple for flame recognition
- Built-in Regulator with 13-foot hose

**Size:** 20", 13" tall  
**Burner:** 10" Round

## MATCH LIT UNITS

Type	Gas type	Models (EI)	Max BTU
Large	Liquid Propane	SPORTPIT20-BLK	37k

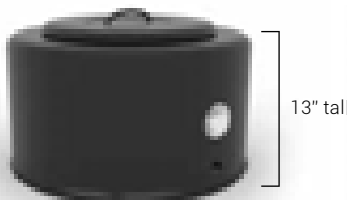

Sport Pit Mini  
Coming Soon

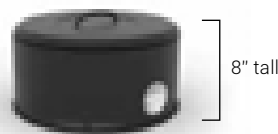

HPC's Aluminum Spun Bowls are designed to be a turn key appliance. Offering a light weight design with a powder coated finish giving the appearance of concrete or walnut.



# ALUMINUM SPUN BOWLS

## ALUMINUM SPUN BOWLS

*CSA Certified*

### Design

- Spun 5052 aluminum
- Unique ventilation designed to cool internal components and to cool outside shell of bowl
- Lightweight design for easier handling when installing
- Choice of 2 powder coat colors; Walnut and Concrete

### Ignition Systems

- Electronic Ignition
- Match lit

**Size:** 35", 14.5" tall



## MATCH LIT UNITS

Finish	Gas	Nozzel	Standard Burner Model	Max BTU
Concrete	Natural Gas	TOR	STONE30MLFPK-NG	65k
Walnut	Natural Gas	TOR	WALNUT30MLFPK-NG	65k

## ELECTRONIC IGNITION UNITS

Finish	Power	Gas	Nozzel	Std Model - Flame ON/OFF	Nozzel	Std Model - Bluetooth (HI/LO)	Max BTU
Concrete	120vac	Natural Gas	TOR	STONE30EI-NG/120VAC	TOR	STONE30EI-HI/LO-NG/120VAC	125k
	24vac	Natural Gas	TOR	STONE30EI-NG/24VAC	TOR	STONE30EI-HI/LO-NG/24VAC	125k
Walnut	120vac	Natural Gas	TOR	WALNUT30EI-NG/120VAC	TOR	WALNUT30EI-HI/LO-NG/120VAC	125k
	24vac	Natural Gas	TOR	WALNUT30EI-NG/24VAC	TOR	WALNUT30EI-HI/LO-NG/24VAC	125k

**TO ORDER PROPANE MODELS "LP" Please Change out NG to LP**

Need help? Use our fire pit selector at [hpcfire.com](http://hpcfire.com)

# WATER FEATURE INSERTS

## EVOLUTION 360



Offers year round enjoyment! While the water feature needs to be winterized, the fire and lighting feature can be enjoyed all year long.

### HAMMERED COPPER FIRE BOWL

Hammered Copper - 4 Scupper



360 Feature being finished with paver stone  
Includes Basin, 26" Copper Water Bowl, and Electronic Ignition Fire Pit (13SSEI).

Hammered Copper - 360



Winner of two Vesta Awards for Product Innovation and Design



Four Scupper Feature



360 Feature

### SPECIFICATIONS - ELECTRONIC IGNITION (EI)

Bowl Type	Power	Gas type	Models (EI)	Max BTU
4 Scupper	120vac	Natural Gas	WB52R-TEMP4-EI-NG	90k
		Liquid Propane	WB52R-TEMP4-EI-LP	
360	120vac	Natural Gas	WB52R-TEMP360-EI-NG	90k
		Liquid Propane	WB52R-TEMP360-EI-LP	

Size: 52" diameter, 14"-18" tall  
Burner: 12" Round

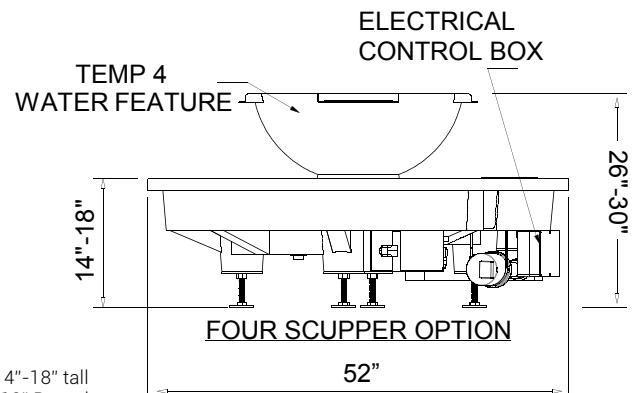





## H2Onfire

Electronic Ignition fire feature intergrated with water, turn-key appliance operating at a gas pressure less than 1/4 psi, allowing for residential installations. It is also the first "fire on water" system to be certified in North America to the Z21.97 standard by the CSA Group - passing the stringent wind, rain, and combustion test.

The fire ring is totally submerged underwater using our patent pending burner design and back flow prevention to protect the controls. HPC's H2OnFire produces a very appealing flame utilizing only 65,000 Btu. This is NOT a match lit system- it is remote controlled with auto relight. Our ignition and flame sensing network is located in the center tower monitoring flame conditions at all times. **Ships in crate on pallet.**

### CONCRETE FIRE ON WATER AND HAMMERED COPPER 360

Black Concrete Bowl - 4 Scupper

Burnt Sienna Concrete Bowl - 4 Scupper



Hammered Copper Fire on Water - 360

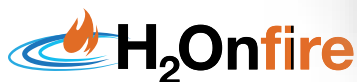

Fully Assembled. Includes Basin, Water Bowl, and Fire on Water Control System



Winner of Vesta Awards Finalist



578-G4  
Optional Remote Available

### SPECIFICATIONS - ELECTRONIC IGNITION (EI)

Color	Bowl Type	Power	Gas type	Models	Max BTU
Concrete Burnt Sienna	4 Scupper	120vac	Natural Gas Liquid Propane	FOW52R-MONACO4BS-EI-NG FOW52R-MONACO4BS-EI-LP	65k
Concrete Black	4 Scupper	120vac	Natural Gas Liquid Propane	FOW52R-MONACO4BL-EI-NG FOW52R-MONACO4BL-EI-LP	65k
Copper - Hammered	360	120vac	Natural Gas Liquid Propane	FOW52R-CYPRUS360-EI-NG FOW52R-CYPRUS360-EI-LP	65k

**TO ORDER PROPANE MODELS "LP" Please Change out NG to LP**

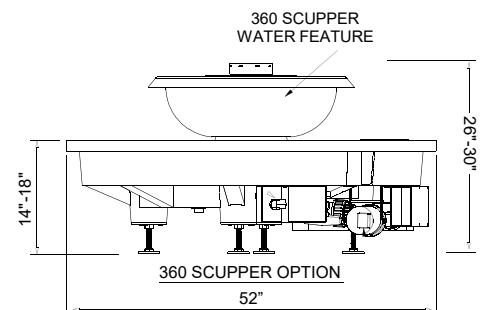

Size: 52" diameter, 14"-18" tall  
Burner: Underwater

## FIRE LOGS

### CONCRETE OUTDOOR LOGS

Second only to the flame itself, nothing says outdoor fire pit like a beautiful set of fire logs. HPC is introducing a new line of fire logs this year. This new line-up features logs that are intricately detailed and

extremely durable. To give our logs a true realistic appearance, they are actually cast from real pieces of wood. Nearly impossible to tell from the real thing! Three distinctive styles, in 9-piece or 16-piece sets.



### ARIZONA WEATHERED OAK

A classic look. The Arizona Weathered Oak fire log set features deeply contoured bark, all intricately hand-painted. Beautiful from every angle.

### SPECIFICATIONS

Style	Model	Piece	Size
Arizona	FPL18/24AW09	9	12"-18"
Weathered Oak	FPL30/36AW016	16	14"-18"



### ASPEN BIRCH

Logs with a contemporary flair, these Aspen Birch fire logs fit very well with rectangular and linear fire pits.

### SPECIFICATIONS

Style	Model	Piece	Size
Aspen	FPL18/24AB9	9	11"-18"
Birch	FPL30/36AB16	16	13"-18"



### WESTERN DRIFTWOOD

A new design, the Western Driftwood fire log set really looks like its pieces were picked up off the beach. Beautiful whether the fire is burning or not.

### SPECIFICATIONS

Style	Model	Piece	Size
Western	FPL18/24WD9	9	10"-18"
Driftwood	FPL30/36WD16	16	10"-21"

# LAVA & CERAMIC ROCK

## LAVA ROCK



Lava Rock is proven to increase combustion efficiency while maintaining a classy look for any fire pit. The size of each piece of rock varies from 1" to 2". Lava rock is sold in 1/2 cubic foot increments. Serves as an excellent base for our specially designed outdoor logs.

Model	Size
657	1"-2" Size

## ROLLED LAVA STONE



Unique finish lava stone rolled smooth. Available in 1/2 cubic foot bags.

Color	Model	Size
Black	857S	1"-2" Size
	857M	2.5"-4.5" Size

## CERAMIC RIVER ROCK SERIES

Looking for something other than lava rock or glass? HPC's River Rock Series are made from lightweight ceramic fiber and are gel casted. The durable design allows the river rock to withstand outdoor elements. Each set comes with an 84 piece assortment of large and small stones (large pieces are 4 1/2", small pieces are 2 1/2"). One set is 1/2 cubic foot (15 lbs). Available in two styles – black or multi color (light and dark brown, gray, and black)



Model	Color	Size
FPR84MC	Multicolor	2.5" - 4.5" Size
FPR84BL	Black	2.5" - 4.5" Size

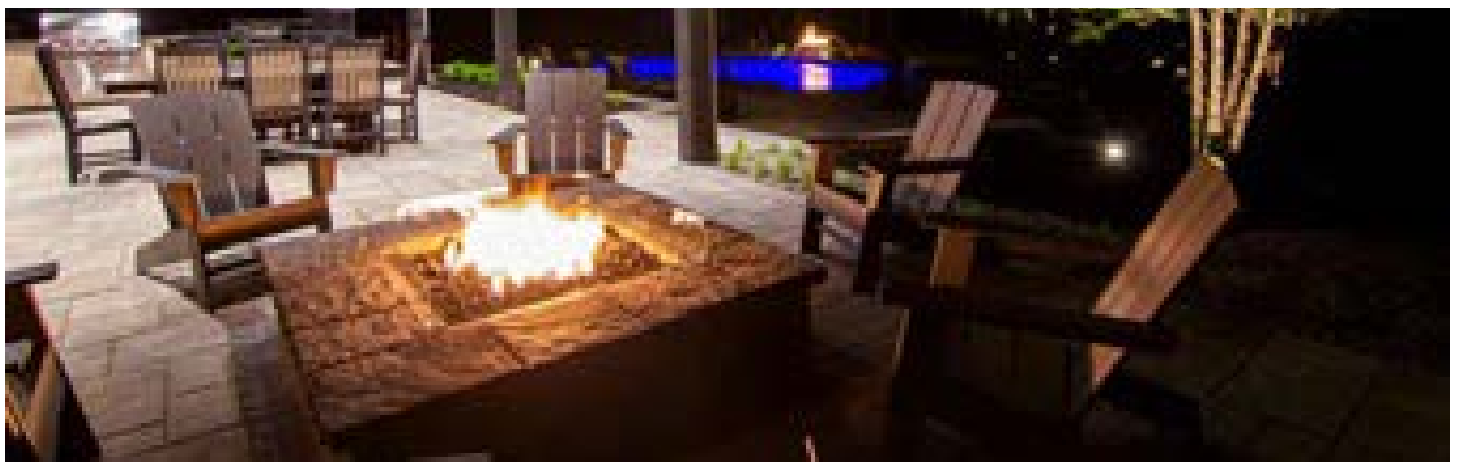

# FIRE GLASS



**NEED HELP? CHECK OUT OUR GLASS CALCULATOR AT [HPCFIRE.COM](http://HPCFIRE.COM)!**

*HPC has 10 colors to choose from - The glass shown- is 1/4"  
Sold in 10 lb increments (Priced per 10lbs)*

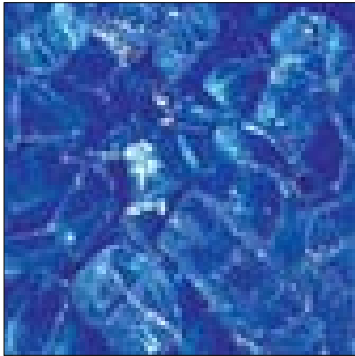

FPGLCOBALTBLUE

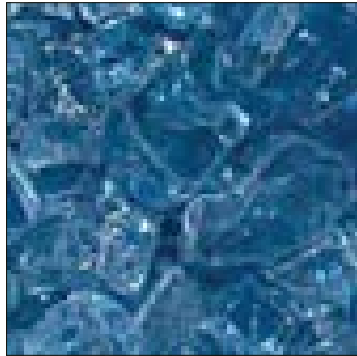

FPGLPACIFICBLUE

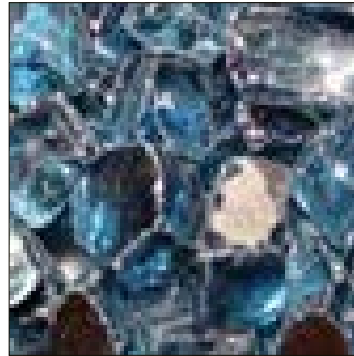

FPGLPACBLUEREFL



FPGLBLACK

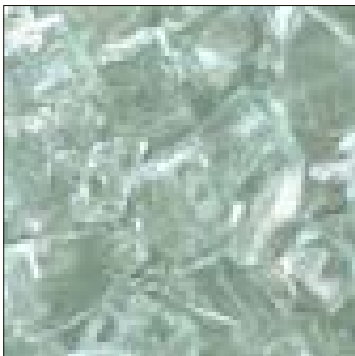

FPGLCLEAR



FPGLSTARFIRE



FPGLGRAYREFLEC

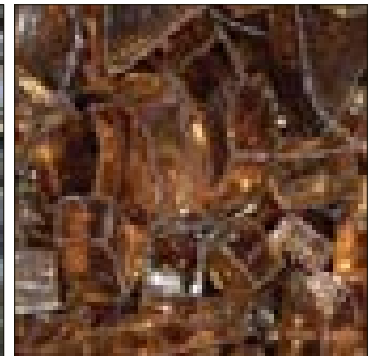

FPGLCOPPER



FPGLBLACKREFL



FPGLBRONZE

# GLASS WIND GUARDS

HPC provides a high quality glass wind guards specially designed to complement as well as provide additional safety for HPC fire pit inserts: round, square, rectangle and linear. Made from durable tempered glass

to ensure a long lasting, heat resistant product. Wind guards reduce flame disturbance and prevent loose items from getting too close to the flames.

**Features:**

**Tempered Glass** - Heavy duty 3/16" clear glass that is tempered to improve durability and allows it to withstand high temperatures. Depending on wind guard size- 4 or 6 sections complete the desired shape.

**Brackets**- Polished aluminum brackets and plastic support feet provided.

## Specifications

Shape	Size	Model	Height
Round	23"	WG23-RD	6"
	30"	WG30-RD	6"
	38"	WG38-RD (6 Pieces)	6"
	48"	WG48-RD (6 Pieces)	6"
Square	25x25"	WG25-SQ	6"
	31x31"	WG31-SQ	6"
	37x37"	WG37-SQ	6"
	43x43"	WG43-SQ	6"
	49x49"	WG49-SQ	6"
Rectangle	31x19"	WG31X19-RECT	6"
	37x19"	WG37X19-RECT	6"
	43x21"	WG43X21-RECT	6"
	49x21"	WG49X21-RECT	6"
	61x23"	WG61X23-RECT	6"
Linear	31X15"	WG31X15-L	6"
	43X15"	WG43X15-L	6"
	55X15"	WG55X15-L	6"
	67X15"	WG67X15-L	6"



Round Wind Guard



Square Wind Guard



Rectangle Wind Guard



Linear Wind Guard

## WIND GUARD REPLACEMENT CLIPS

Replacement clips for HPC Wind Guards (one clip per pack). Please note if needing a bottom clip, will need rubber foot, also found below.

Model	Description
WG-CC-RD	Replacement chrome clip for round wind guards
WG-CC-SQ/RECT	Replacement Chrome Corner Clip For Square & Rectangle Wind Guards

## WIND GUARD REPLACEMENT RUBBER FEET

Replacement rubber feet for HPC Wind Guards (one foot per pack).

Model	Description
WG-RUBBER FOOT-RD	Replacement rubber foot for round wind guards
WG-RUBBER FOOT-SQ/RECT	Replacement rubber foot for square & rectangle wind guards



## WIND GUARD EXTENSION KIT AND PARTS

The WG-EXT/STR KIT allows you to combine rectangle, linear and square HPC wind guards.

Model	Description
WG-EXT/STR KIT	Complete Kit - 4 Extension chrome straight clips and 4 extension glass supports with rubber foot
WG-SC	Replacement extension chrome straight clip for square & linear wind guards-used for extending lengths on glass panels
WG-EGS	Replacement extension glass support with rubber foot



WG-EXT/STR KIT installed

# ACCESSORIES

## FIRE PIT COVERS

### ROUND ALUMINUM COVERS - TALL

These lightweight aluminum hard covers are powder coated in UV, high-heat resistant textured black or glossy copper finish. They are available in two sizes - 32" (15lbs) and 44" (20lbs).

Color	Size	Models	Height	Weight
Copper Vein	32"	FPHC-32C	10"	15 lbs
	44"	FPHC-44C	14"	20 lbs
Black	32"	FPHC-32BL	10"	15 lbs
	44"	FPHC-44BL	14"	20 lbs



### ROUND ALUMINUM COVERS - SHORT



Color	Size	Models	Height	Weight
Copper Vein	24"	FPHC-24C	1"	6 lbs
	36"	FPHC-36C		13 lbs
	48"	FPHC-48C		23.5 lbs
Black	24"	FPHC-24BL	1"	6 lbs
	36"	FPHC-36BL		13 lbs
	48"	FPHC-48BL		23.5 lbs

### COPPER COVERS FOR COPPER BOWLS

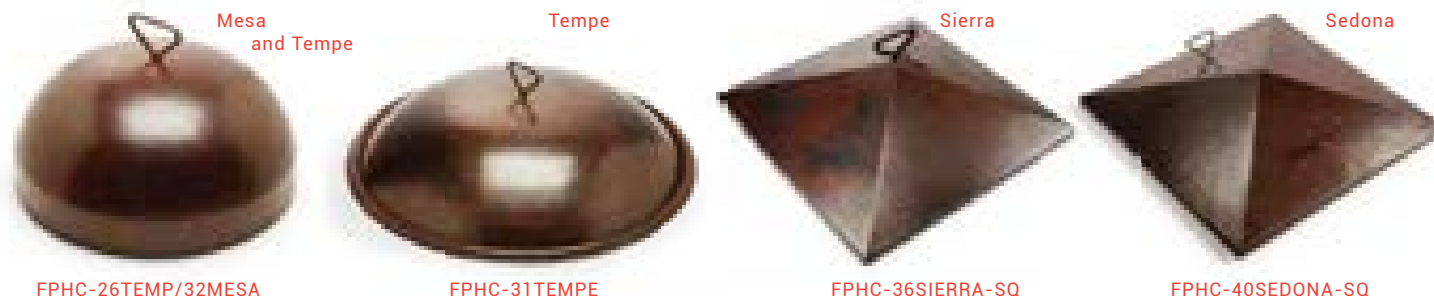

Shape	Finish	Models	Size	Height	Weight
Round	Hammered	FPHC-26TEMP/32MESA	19"	8.5"	7.5 lbs
	Hammered	FPHC-31TEMPE	32"	5.75"	15 lbs
Square	Smooth	FPHC-36SIERRA-SQ	26"X26"	7"	13 lbs
	Hammered	FPHC-40SEDONA-SQ	30"X30"	7"	13.5 lbs

### STAINLESS STEEL COVERS

These stainless steel covers are constructed of #304, 20 gauge material. Great for covering fire pits without outdoor logs. Linear trough covers are designed specifically for our trough series, be it match lit, manual

ignition, or remote electronic ignition models. These are lightweight and have handles for ease of use.

#### LINEAR

Stainless	Size	Model	Height	Handle	Weight
Brushed	28" x 9.5"	TPHC-24SS	1"	1	11 lbs
	40" x 9.5"	TPHC-36SS	1"	1	13 lbs
	52" x 9.5"	TPHC-48SS	1"	2	15 lbs
	64" x 9.5"	TPHC-60SS	1"	2	18lbs



#### RECTANGLE

Stainless	Size	Model	Height	Handle	Weight
Brushed	28" x 16"	HPHC-24X12SS	1"	1	16 lbs
	34" x 16"	HPHC-30X12SS	1"	1	18 lbs
	40" x 18"	HPHC-36X14SS	1"	1	20 lbs
	46" x 18"	HPHC-42X14SS	1"	2	22 lbs
	52" x 20"	HPHC-48X16SS	1"	2	24 lbs
	58" x 20"	HPHC-54X16SS	1"	2	28 lbs



# VINYL COVERS

Made of durable vinyl, they protect fire pits and enclosures from debris and elements. The round covers have elastic and the rectangle covers

have a pull string at the bottom for ease of use. **NOTE: Skirt Length 10"**

## ROUND COVERS

Max Size	Models	Fits Enclosures
35"	FPC-35	23" ~ 35"
45"	FPC-45	30" ~ 45"
53"	FPC-53	35" ~ 53"
64"	FPC-64	43" ~ 64"
76"	FPC-76	60" ~ 76"

## GREY ROUND COVERS

Max Size	Models	Fits Enclosures
53" x 53"	FPC-53-GR	35" ~ 53"



## SQUARE COVERS

Max Size	Models	Fits Enclosures
48" x 48"	FPC-48SQ	36" ~ 48"
60" x 60"	FPC-60SQ	45" ~ 60"

## GREY SQUARE COVERS

Max Size	Models	Fits Enclosures
60" x 60"	FPC-60SQ-GR	45" ~ 60"



## RECTANGLE COVERS

Max Size	Models	Fits Enclosures
48" x 30"	FPC-44X30	34x20" ~ 44x30"
62" x 30"	FPC-62X30	52x20" ~ 62x30"
78" x 40"	FPC-78X40	68x30" ~ 78x40"
90" x 40"	FPC-90X40	80x30" ~ 90x40"
94" x 30"	FPC-94X30	84x20" ~ 94x30"
102" x 40"	FPC-102X40	92x30" ~ 102x40"
114" x 40"	FPC-114X40	104x30" ~ 114x40"
130" x 30"	FPC-130X30	120x20" ~ 130x30"

## GREY SQUARE COVERS

Max Size	Models	Fits Enclosures
78" x 40"	FPC-78X40-GR	45" ~ 60"



## EVOLUTION 360 AND H2ONFIRE COVERS

Model	Style
FPC-84WB	Basin
FPC-35	Bowl



## TK TORCH COVER - (FPC-TK TORCH)

TK Torch Cover w/Elastic Hem  
(3.5" Top Dia x 9.5" Bottom Dia. x 14" Height)



## STAINLESS STEEL ACCESS DOORS

Stainless steel access doors are available for all FPPK and MLFPK Hard pipe Models.

Model	Style
AD-RM6X6SS	6x6 Recess Mount
AD-RM8X8SS	8x8 Recess Mount
AD-SM8X8SS	8x8 Surface Mount

Recess Mount



Surface Mount

## ENCLOSURE VENTS

Stainless Steel vents for enclosures.

Material	Style	Size	Model
Stainless	Flat	9"x4"	EV-8X4SS
	Flat	12"x6"	EV-12X6SS
	Louvered	14"x4.5"	EV-14X4.5SS

Flat

Louvered



# ACCESSORIES

## DECK INSTALLATION KIT (EI, FPPK & MLFPK)

This kit is needed when installing a gas fire pit on a wood or composite deck. It provides flame and excess heat protection around input flex line connection(s). The basalt insulation is for inside the fire pit enclosure or bowl and should be placed over a layer of paver blocks (1" min. thickness). Incoming gas stub must protrude through the deck, paver

blocks and insulation for fire pit flex line connection. Kit includes basalt insulation and instructions- basalt insulation measures 39.3" x 39.3" (1 sq. meter)- larger fire pits will require more pieces. The insulation is easily cut with utility knife.

**FPI-DECK20SQ** - For fire bowls- includes basalt insulation- 19.6" x 19.6"

**FPI-DECK39SQ** - For fire pits- includes basalt insulation- 39.3" x 39.3" (1 sq. meter).

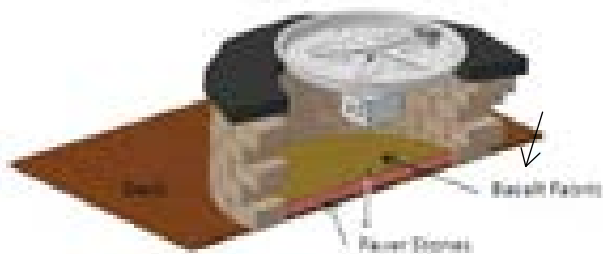

## MATCH LIT MODELS (MLFPK) PAVER BLOCK BRACKET



\*Valve/Flange  
Key not included

### KVMB-PB

Designed for the Dante Valve, this bracket allows flexibility and installation ease of the MLFPK decorative key valve. The face plate is adjustable from 8" to 12" width accommodating most pavers. The valve is securely mounted to bracket using decorative flange. (8-12"W x 3.875H x 5"D)

**IMPORTANT:** For use only with DANTE Valve #327-CH (Pg. 54)

## REPLACEMENT REMOTE SMALL TANK KIT - LP (FPPK & MLFPK)

### STLPK

This kit is for use with CSA certified FPPK and MLFPK fire pit models less than 90k Btu- see fire pit insert section for approved models. The kits includes a 90-degree regulator with 48" hose, 24" Flex Line, small tank L-Bracket and fittings for FPPK or MLFPK connection.

For use with CSA Certified FPPK & MLFPK fire pit inserts only



## MATCH LIT SPARK IGNITER KIT

### SIK36

Can't find matches or a lighter for a match-lit fire pit? No problem! HPC now offers a "Match-Lit Plus" Spark Igniter Kit, which is easily installed and makes any match-lit fire pit much more convenient to light. Included in the kit is the spark ignitor itself, plus the battery-activated push-button mounting plate (battery included).





## HARDSCAPE BLOCK KIT

Available when installing a fire pit in ready-made hardscape blocks. The kit includes all the things you'll need to complete the installation.

### Kit Includes

- Fire Pit Insert
- Flex Form Collars (1 or 2 Boxes) (44x6.2")
- Vents - 2 (9x4")
- SSC24 Flex Line (24")
- Lava Rock



Burner Style	Pan Size	Gas type	Nozzle	Std Model	Insert Details
FPPK Round Flat	14"	Natural Gas		BLOCK-FPPK14-FLEX-NG	Round Flat
FPPK Round Flat	18"	Natural Gas	TOR-	BLOCK-PENTA18FPPK-FLEX-NG	Round Flat
FPPK Round Flat	24"	Natural Gas	TOR-	BLOCK-PENTA24FPPK-FLEX-NG	Round Flat
FPPK Round Flat	30"	Natural Gas	TOR-	BLOCK-PENTA30FPPK-FLEX-NG	Round Flat
FPPK Round Flat	36"	Natural Gas	TOR-	BLOCK-PENTA36FPPK-FLEX-NG	Round Flat
MLFPPK Round Flat	8"	Natural Gas		BLOCK-MLFPPK8-FLEX-NG	Round Flat
MLFPPK Round Flat	14"	Natural Gas	TOR-	BLOCK-PENTA14 MLFPPK-FLEX-NG	Round Flat
MLFPPK Round Flat	18"	Natural Gas	TOR-	BLOCK-PENTA18 MLFPPK-FLEX-NG	Round Flat
MLFPPK Round Flat	24"	Natural Gas	TOR-	BLOCK-PENTA24 MLFPPK-FLEX-NG	Round Flat
MLFPPK Round Flat	30"	Natural Gas	TOR-	BLOCK-PENTA30 MLFPPK-FLEX-NG	Round Flat
FPPK Round Square	18"	Natural Gas	TOR-	BLOCK-FPPK18-SQ-FLEX-NG	Square Flat
FPPK Round Square	24"	Natural Gas	TOR-	BLOCK-FPPK24-SQ-FLEX-NG	Square Flat
FPPK Round Square	30"	Natural Gas	TOR-	BLOCK-FPPK30-SQ-FLEX-NG	Square Flat
FPPK Round Square	36"	Natural Gas	TOR-	BLOCK-FPPK36-SQ-FLEX-NG	Square Flat
MLFPPK Round Square	18"	Natural Gas	TOR-	BLOCK-MLFPPK18SQ-FLEX-NG	Square Flat
MLFPPK Round Square	24"	Natural Gas	TOR-	BLOCK-MLFPPK24SQ-FLEX-NG	Square Flat
MLFPPK Round Square	30"	Natural Gas	TOR-	BLOCK-MLFPPK30SQ-FLEX-NG	Square Flat
FPPK H-Burner	24x12"	Natural Gas		TOR-BLOCK-FPPK24X12-H-FLEX-NG	H-Burner
FPPK H-Burner	30x12"	Natural Gas		TOR-BLOCK-FPPK30X12-H-FLEX-NG	H-Burner
FPPK H-Burner	36x14"	Natural Gas		TOR-BLOCK-FPPK36X14-H-FLEX-NG	H-Burner
FPPK H-Burner	42x14"	Natural Gas		TOR-BLOCK-FPPK42X14-H-FLEX-NG	H-Burner
FPPK H-Burner	54x16"	Natural Gas		TOR-BLOCK-FPPK54X16-H-FLEX-NG	H-Burner
MLFPPK H-Burner	24x12"	Natural Gas		TOR-BLOCK-MLFPPK24X12-H-FLEX-NG	H-Burner
MLFPPK H-Burner	30x12"	Natural Gas		TOR-BLOCK-MLFPPK30X12-H-FLEX-NG	H-Burner
MLFPPK H-Burner	36x14"	Natural Gas		TOR-BLOCK-MLFPPK36X14-H-FLEX-NG	H-Burner
FPPK Interlink	25x8"	Natural Gas		TOR-BLOCK-FPPK25X8-L-FLEX-NG	Interlink
FPPK Interlink	37x8"	Natural Gas		TOR-BLOCK-FPPK37X8-L-FLEX-NG	Interlink
FPPK Interlink	49x8"	Natural Gas		TOR-BLOCK-FPPK49X8-L-FLEX-NG	Interlink
FPPK Interlink	61x8"	Natural Gas		TOR-BLOCK-FPPK61X8-L-FLEX-NG	Interlink
FPPK Interlink	73x8"	Natural Gas		TOR-BLOCK-FPPK73X8-L-FLEX-NG	Interlink
FPPK Interlink	97x8"	Natural Gas		TOR-BLOCK-FPPK97X8-L-FLEX-NG	Interlink
MLFPPK Interlink	25x8"	Natural Gas		TOR-BLOCK-MLFPPK25X8-L-FLEX-NG	Interlink
MLFPPK Interlink	37x8"	Natural Gas		TOR-BLOCK-MLFPPK37X8-L-FLEX-NG	Interlink
MLFPPK Interlink	49x8"	Natural Gas		TOR-BLOCK-MLFPPK49X8-L-FLEX-NG	Interlink

## FLEX FORM INSTALL COLLARS

The flex form install collar merges the gap between the fire pit structure and the insert pan for easy installation. This flexible install collar allows for an easy 3 step installation saving you time with our one size fits all product. The collar can be formed to fit any shaped fire pit and offers an auto centering feature with a curved lip..

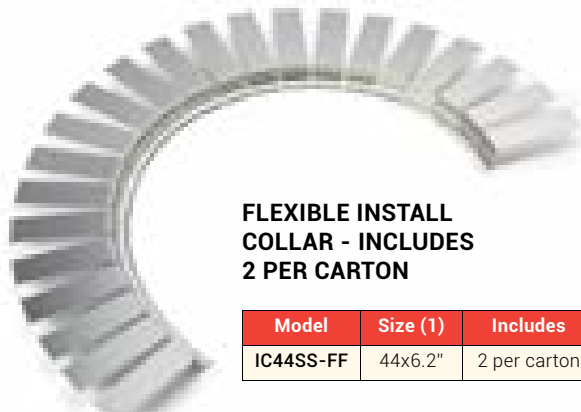

**FLEXIBLE INSTALL COLLAR - INCLUDES 2 PER CARTON**

Model	Size (1)	Includes
IC44SS-FF	44x6.2"	2 per carton

### Step 1



Place the collar

### Step 2



Install the collar

### Step 3



Install the insert

# FIRE PIT COMPONENTS

UNASSEMBLED -  
NON-CERTIFIED

## FIRE PIT KIT (FPS SERIES)

Includes everything needed to put together a match lit fire pit: Includes burner, a valve with polished chrome flange, flex line and fittings.

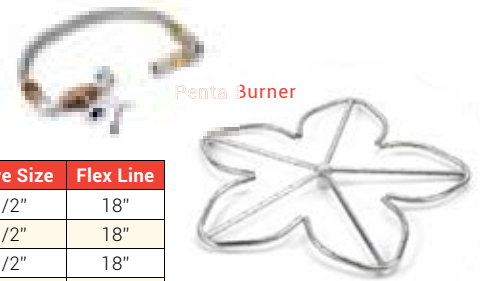

Penta Burner

### PENTA BURNER KITS- STAINLESS STEEL (#304)

Size	Gas Type	Nozzle	Model	Hub Size	Btu	Nozzle BTU	Valve Size	Flex Line
12"	Natural Gas	TOR	FPS/PENTA12 KIT	1/2"	65k	100k	1/2"	18"
18"	Natural Gas	TOR	FPS/PENTA18 KIT	1/2"	125k	175k	1/2"	18"
24"	Natural Gas	TOR	FPS/PENTA24 KIT	1/2"	200k	250k	1/2"	18"
30"	Natural Gas	TOR	FPS/PENTA30 KIT	3/4"	250k	300k	3/4"	24"
36"	Natural Gas	TOR	FPS/PENTA36 KIT	3/4"	300k	350k	3/4"	24"
48"	Natural Gas	TOR	FPS/PENTA48 KIT	3/4"	300k	350k	3/4"	24"

#### Features:

Burner Ports - 9 and 3 o'clock  
Raised Hub Design  
Patented Technology

### ROUND BURNER KITS- STAINLESS STEEL (#304)

Size	Gas Type	Model	Hub Size	Btu	Valve Size	Flex Line
6"	Natural Gas	FPS6 KIT	1/2"	60k	1/2"	18"
12"	Natural Gas	FPS12 KIT	1/2"	90k	1/2"	18"
18"	Natural Gas	FPS18 KIT	1/2"	150k	1/2"	18"
24"	Natural Gas	FPS24 KIT	1/2"	150k	1/2"	18"
24" (HC)	Natural Gas	FPS24HC KIT	3/4"	300k	3/4"	18"
30"	Natural Gas	FPS30 KIT	1/2"	300k	1/2"	24"
30" (HC)	Natural Gas	FPS30HC KIT	3/4"	300k	3/4"	24"
36"	Natural Gas	FPS36HC KIT	3/4"	300k	3/4"	24"
48"	Natural Gas	FPS48HC KIT	3/4"	300k	3/4"	24"

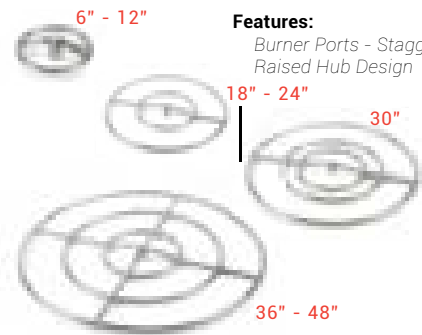

#### Features:

Burner Ports - Staggered  
Raised Hub Design

### SQUARE BURNER KITS- STAINLESS STEEL (#304)

Size	Gas Type	Model	Hub Size	Btu	Valve Size	Flex Line
12"	Natural Gas	FPSSQ12 KIT	1/2"	90k	1/2"	18"
18"	Natural Gas	FPSSQ18 KIT	1/2"	150k	1/2"	18"
24"	Natural Gas	FPSSQ24 KIT	1/2"	150k	1/2"	18"
36"	Natural Gas	FPSSQ36HC KIT	3/4"	300k	3/4"	24"
48"	Natural Gas	FPSSQ48HC KIT	3/4"	300k	3/4"	24"

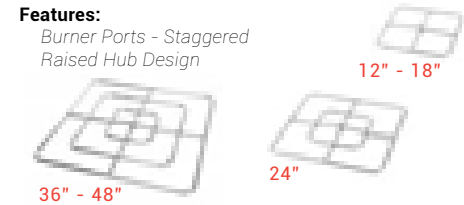

#### Features:

Burner Ports - Staggered  
Raised Hub Design

### RECTANGLE BURNER KITS- STAINLESS STEEL (#304)

Size	Gas Type	Model	Hub Size	Btu	Valve Size	Flex Line
12"x 6"	Natural Gas	FPSR12X6 KIT	1/2"	90k	1/2"	18"
18"x 9"	Natural Gas	FPSR18X9 KIT	1/2"	150k	1/2"	18"
24"x 12"	Natural Gas	FPSR24X12 KIT	1/2"	150k	1/2"	18"
36"x 18"	Natural Gas	FPSR36X18 KIT	1/2"	200k	1/2"	18"
48"x 24"	Natural Gas	FPSR48X24HC KIT	3/4"	300k	3/4"	24"



### LINEAR BURNER KITS- TROUGH PAN & T-BURNER STAINLESS STEEL (#304)

Size (A")	Gas Type	Nozzle	Model	Hub Size	Btu	Nozzle BTU	Valve Size	Flex Line
24"	Natural Gas	TOR	FPS/TRGH24 KIT	1/2"	50k	100k	1/2"	18"
36"	Natural Gas	TOR	FPS/TRGH36 KIT	1/2"	75k	125k	1/2"	18"
48"	Natural Gas	TOR	FPS/TRGH48 KIT	1/2"	100k	150k	1/2"	18"
60"	Natural Gas	TOR	FPS/TRGH60 KIT	1/2"	125k	175k	1/2"	18"
72"	Natural Gas	TOR	FPS/TRGH72 KIT	1/2"	150k	200k	1/2"	18"
96"	Natural Gas	TOR	FPS/TRGH96 KIT	1/2"	200k	300k	1/2"	18"



### LINEAR BURNER KITS- INTERLINK PAN & T-BURNER, STAINLESS STEEL (#304)

Size (A")	Gas Type	Nozzle	Model	Hub Size	Btu	Nozzle BTU	Valve Size	Flex Line
25"X 8"	Natural Gas	TOR	FPS/LINEAR25X8 KIT	1/2"	50k	100k	1/2"	18"
37"X 8"	Natural Gas	TOR	FPS/LINEAR37X8 KIT	1/2"	75k	125k	1/2"	18"
49"X 8"	Natural Gas	TOR	FPS/LINEAR49X8 KIT	1/2"	100k	150k	1/2"	18"
61"X 8"	Natural Gas	TOR	FPS/LINEAR61X8 KIT	1/2"	125k	175k	1/2"	18"
73"X 8"	Natural Gas	TOR	FPS/LINEAR73X8 KIT	1/2"	150k	200k	1/2"	18"
97"X 8"	Natural Gas	TOR	FPS/LINEAR97X8 KIT	1/2"	200k	300k	1/2"	18"
121"X 8"	Natural Gas	TOR	FPS/LINEAR121X8 KIT	1/2"	250k	300k	1/2"	18"

#### Features:

Sidewalls add strength and hold media  
Burner Ports - Staggered  
Removable center section on some models  
Raised Hub Design



**FIRE PIT KIT (FPS SERIES)**

Includes everything needed to put together a match lit fire pit: Includes burner, a valve with polished chrome flange, flex line and fittings.

**H-BURNER KITS- STAINLESS STEEL (#304)**

Size	Gas Type	Nozzle	Model	Hub Size	Btu	Nozzle BTU	Valve Size	Flex Line
18"x 6"	Natural Gas	TOR	FPS/HBSB18 KIT	1/2"	60k	125k	1/2"	18"
24"x 6"	Natural Gas	TOR	FPS/HBSB24 KIT	1/2"	90k	150k	1/2"	18"
30"x 8"	Natural Gas	TOR	FPS/HBSB30 KIT	1/2"	90k	200k	1/2"	18"
36"x 8"	Natural Gas	TOR	FPS/HBSB36 KIT	1/2"	150k	250k	1/2"	18"
48"x 10"	Natural Gas	TOR	FPS/HBSB48 KIT	1/2"	150k	300k	1/2"	18"
60"x 10"	Natural Gas	TOR	FPS/HBSB60 KIT	1/2"	250k	300k	1/2"	18"
72"x 10"	Natural Gas	TOR	FPS/HBSB72 KIT	1/2"	300k	300k	1/2"	18"
84"x 10"	Natural Gas	TOR	FPS/HBSB84 KIT	1/2"	300k	300k	1/2"	18"

**Features:**

Burner Ports - Point Inward  
Raised Hub Design



### NATURAL GAS/PROPANE BBQ AND APPLIANCE OUTLET (581)

Designed for Indoor/Outdoor Application  
 Heavy Duty 20 Gauge Stainless Steel Outlet Cover  
 CSA-AGA/CGA Approved to -40 Degrees F  
 60k Btu Natural Gas, 90k Btu Propane Gas  
 5 PSIG maximum operation pressure  
 Lockable safety feature denies connect/disconnect while gas is flowing.  
 Manual gas valve with appliance connection.

Models	Description
580	144"x3/8" with quick disconnect assembly
580-1	144x3/8" with Male Quick Disconnect Only
580-V	Female Quick Disconnect Fitting
581	Appliance Outlet

### NATURAL GAS/LP QUICK DISCONNECT HOSE ASSEMBLY (580)

144" x 3/8" I.D.  
 Gray PVC Galvanized Steel Hose  
 CSA-AGA/CGA approved to -40 Degrees F  
 Quick Disconnect Nipple and Socket dust cap  
 Attached Hose and Quick Disconnect Installation Instructions

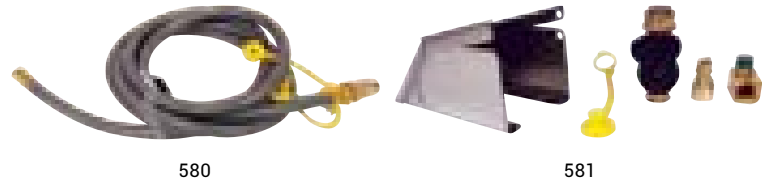

## FLEX LINE

### STANDARD CAPACITY FLEX LINE

All standard capacity flex lines are 1/2" OD and 3/8" ID with 1/2" female pipe threads on one end and 3/8" male pipe threads on the other.

Model	Length	Max BTU/HR (NG)	Max BTU/HR (LP)	Flare Size	Fittings Included (Two)
SSC6	6"	110,000	177,000	1/2"	3/8" MIP, 1/2" FIP
SSC12	12"	102,000	163,200	1/2"	3/8" MIP, 1/2" FIP
SSC18	18"	93,000	148,960	1/2"	3/8" MIP, 1/2" FIP
SSC24	24"	85,000	136,000	1/2"	3/8" MIP, 1/2" FIP
SSC30	30"	77,000	123,360	1/2"	3/8" MIP, 1/2" FIP
SSC36	36"	71,000	113,760	1/2"	3/8" MIP, 1/2" FIP
SSC48	48"	60,500	96,800	1/2"	3/8" MIP, 1/2" FIP



### HIGH CAPACITY FLEX LINE

All high capacity flex lines are 5/8" OD and 1/2" ID with 1/2" female pipe threads on one end and 1/2" male pipe threads on the other.

Model	Length	Max BTU/HR (NG)	Max BTU/HR (LP)	Flare Size	Fittings Included (Two)
SSC-HC12	12"	180,000	288,000	3/4"	1/2" MIP, 1/2" FIP
SSC-HC18	18"	164,000	262,700	3/4"	1/2" MIP, 1/2" FIP
SSC-HC24	24"	150,000	240,000	3/4"	1/2" MIP, 1/2" FIP
SSC-HC30	30"	136,000	217,600	3/4"	1/2" MIP, 1/2" FIP



### ULTRA HIGH CAPACITY FLEX LINE

All high capacity flex lines are 1" OD and 3/4" ID with 3/4" female pipe threads on one end and 1" male pipe threads on the other.

Model	Length	Max BTU/HR (NG)	Max BTU/HR (LP)	Flare Size	Fittings Included (Two)
SSC-HHC24	24"	291,000	465,400	1"	3/4" MIP, 3/4" FIP
SSC-HHC36	36"	256,000	409,400	1"	3/4" MIP, 3/4" FIP

### TRANQUIL WHISTLE-FREE FLEX LINE

HPC has been a long time supplier of reliable, maintenance-free flex lines. We offer our Tranquil Flex Line Series to eliminate the nuisance whistling found on those tough installs. Sizes available in standard capacity are 12", 18", 24", and 30" lengths. These are stainless steel with 3/8" ID and are in stock and ready for shipment.

Model	Length	Max BTU/HR (NG)	Max BTU/HR (LP)	Flare Size	Fittings Included (Two)
SSC-W12	12"	102,000	163,200	1/2"	3/8" MIP, 1/2" FIP
SSC-W18	18"	93,000	148,960	1/2"	3/8" MIP, 1/2" FIP
SSC-W24	24"	85,000	136,000	1/2"	3/8" MIP, 1/2" FIP
SSC-W30	30"	77,000	123,360	1/2"	3/8" MIP, 1/2" FIP

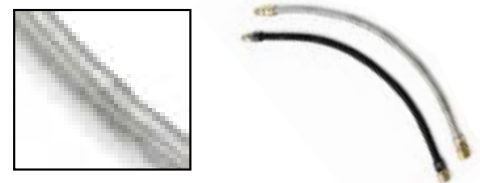

### TRANQUIL WHISTLE-FREE, STANDARD CAPACITY (BLACK)

Model	Length	Max BTU/HR (NG)	Max BTU/HR (LP)	Flare Size	Fittings Included (Two)
SSCB-W18	18"	93,000	148,960	1/2"	3/8" MIP, 1/2" FIP
SSCB-W24	24"	85,000	136,000	1/2"	3/8" MIP, 1/2" FIP
SSCB-W30	30"	77,000	123,360	1/2"	3/8" MIP, 1/2" FIP

\* Natural Gas maximum Btu/hr: Straight Length Capacity; 0.64 SG, 1,000 Btu per Cu. Ft. at .5 water column pressure drop

\*\* Liquid Propane Maximum Btu/hr: Straight Length Capacity; 1.55 SG, 2,500 Btu per Cu. Ft. at .5 water column pressure drop

## FIRE PIT PANS May require use of FRSB-11 Burner Brackets - Sold Separately - All Gas Inlets are Welded Nipple

### ROUND BOWL STYLE- STAINLESS STEEL (#304)

Size	Model	Gauge	Inlet	FRSB-11
13"	570-13	18g	1/2"	3
19"	570-19	18g	1/2"	3
25"	570-25	18g	1/2"	3
31"	570-31	18g	1/2"	3
31"	570-31HC	18g	3/4"	3
37"	570-37HC	18g	3/4"	3
43"	570-43HC	18g	3/4"	3



### ROUND FLAT STYLE- STAINLESS STEEL (#304)

Size	Model	Gauge	Inlet	FRSB-11
7.75"	571-8	18g	1/2"	3
13.75"	571-14	18g	1/2"	3
17.75"	571-18	18g	1/2"	3
23.75"	571-24	18g	1/2"	3
29.75"	571-30	18g	1/2"	3
35.75"	571-36	18g	1/2"	3
35.75"	571-36HC	18g	3/4"	3
41.75"	571-42HC	18g	3/4"	3
53.75"	571-54HC	18g	3/4"	3

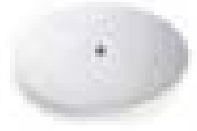

### SQUARE FLAT STYLE- STAINLESS STEEL (#304)

Size	Model	Gauge	Inlet	FRSB-11
18"	571-18SQ	18g	1/2"	3
24"	571-24SQ	18g	1/2"	3
30"	571-30SQ	18g	1/2"	3
36"	571-36HCSQ	18g	3/4"	3
42"	571-42HCSQ	18g	3/4"	3



### SQUARE BOWL STYLE- STAINLESS STEEL (#304)

Size	Model	Gauge	Inlet	FRSB-11
18"	570-18SQ	18g	1/2"	3
24"	570-24SQ	18g	1/2"	3
30"	570-30SQ	18g	1/2"	3
36"	570-36HCSQ	18g	3/4"	3
42"	570-42HCSQ	18g	3/4"	3

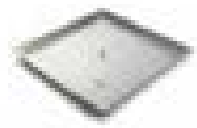

#### LINEAR INTERLINK STYLE

Sold with T-Burner - See Pg. 56



#### LINEAR TROUGH STYLE

Sold with T-Burner - See Pg. 57



#### RECTANGLE BOWL STYLE

Sold with H-Burner - See Pg. 57

#### FRSB-11 BRACKET

This unique bracket is universal to all HPC burners making them more rigid than competitive models.



## REGULATORS



#### 770-150

150k Btu pressure regulator  
Natural Gas : 5 psi input  
Liquid Propane: 2 psi input  
1/2"x1/2", 4"-12" water column



#### 770-13A15

MAXITROL Vent protector with a 1/8" inlet made for 770-150



#### 770-300

300k Btu pressure regulator  
Natural Gas : 5 psi input  
Liquid Propane: 2 psi input  
1"x1", 4"-12" water column



#### 770-13A15-5

MAXITROL Vent protector with a 3/8" inlet made for 770-300



#### 658

100k Btu LP pressure regulator  
3/8" x 3/8", 4"-12" water column

## GRILL REPAIR REGULATOR & HOSE - LP



#### 658/90-18

18" Rubber Hose  
90 degree Regulator  
100k Btu, 3/8 Fitting

#### 658/90-36

36" Rubber Hose  
90 degree Regulator  
100k Btu, 3/8 Fitting



#### 658SS/90-36

36" Braided SS Hose  
90 degree Regulator  
100k Btu, 3/8 Fitting

## PUSH BUTTON IGNITION KITS

This hard pipe unassembled kit include stainless steel pan and burner, push button ignition switch and igniter, chrome decorative key valve, fittings and flex line. **Natural Gas Only** (Not certified).

### ROUND BOWL INSERTS / NON CERTIFIED

Size	Gas type	Nozzle	Model	Burner	Max BTU	Nozzle BTU
19"	Natural Gas	TOR	PENTA19FPK-NG	12" Penta	90k	90k
25"	Natural Gas	TOR	PENTA25FPK-NG	18" Penta	150k	140k
31"	Natural Gas	TOR	PENTA31FPK-NG	24" Penta	150k	185k



### ROUND FLAT INSERTS

Size	Gas type	Nozzle	Model	Burner	Max BTU	Nozzle BTU
18"	Natural Gas	TOR	PENTA18FPK-NG	12" Penta	90k	90k
24"	Natural Gas	TOR	PENTA24FPK-NG	18" Penta	150k	140k
30"	Natural Gas	TOR	PENTA30FPK-NG	24" Penta	150k	185k

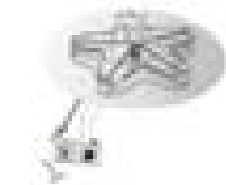

### SQUARE FLAT INSERTS

Size	Gas type	Nozzle	Model	Burner	Max BTU	Nozzle BTU
18"	Natural Gas	TOR	PENTA18FPK-SQ-NG	12" Penta	90k	90k
24"	Natural Gas	TOR	PENTA24FPK-SQ-NG	18" Penta	150k	140k
30"	Natural Gas	TOR	PENTA30FPK-SQ-NG	24" Penta	150k	185k



## FLAME CONTROL SYSTEMS

### DECORATIVE KEY VALVES

DANTE VALVE

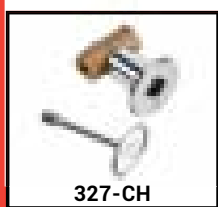

327-CH

**Key Valve Part Numbers:** Key Valves are numbered as either Angled or Straight, and based off of color. For example, MAFB is described as Manual Angled Flat Black. MSFB would be Manual Straight Flat Black.

#### STANDARD CAPACITY VALVES (1/2")

1/4 Turn angle or straight manual ball valve with flange and key. 1/2" inlet and outlet. For floor or wall mounting.

Recommended for gas shut off of 150k Btu or less

#### HIGH CAPACITY VALVES (3/4")

1/4 Turn angle or straight manual ball valve with flange and key. 3/4" inlet and outlet. For floor or wall mounting.

Recommended for gas shut off of 400k Btu or less

#### CHROME FLANGE/ KEY

Valve	Inlet / Outlet	Models
Angle	1/2"	MACB
	3/4"	MACB-HC
Straight	1/2"	MSCB
	3/4"	MSCB-HC



#### BRASS FLANGE/ KEY

Valve	Inlet / Outlet	Models
Angle	1/2"	MABB
	3/4"	MABB-HC
Straight	1/2"	MSBB
	3/4"	MSBB-HC



#### FLAT BLACK FLANGE/ KEY

Valve	Inlet / Outlet	Models
Angle	1/2"	MAFB
	3/4"	MAFB-HC
Straight	1/2"	MSFB
	3/4"	MSFB-HC



#### PEWTER FLANGE/ KEY

Valve	Inlet / Outlet	Models
Angle	1/2"	MAPW
	3/4"	MAPW-HC
Straight	1/2"	MSPW
	3/4"	MSPW-HC

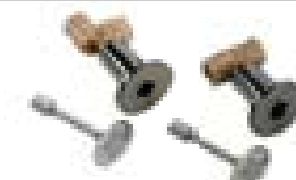

#### ANTIQU BRASS FLANGE/ KEY

Valve	Inlet / Outlet	Models
Angle	1/2"	MAAB
	3/4"	MAAB-HC
Straight	1/2"	MSAB
	3/4"	MSAB-HC



#### ANTIQU COPPER FLANGE/ KEY

Valve	Inlet / Outlet	Models
Angle	1/2"	MAAC
	3/4"	MAAC-HC
Straight	1/2"	MSAC
	3/4"	MSAC-HC

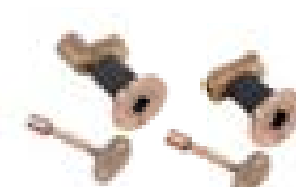

#### FLANGE AND KEY ONLY



#### KEYS



#### FLANGE ONLY

304 L Polished Chrome Flange  
306 L Polished Brass Flange

### MANUAL SPARK, FLAME SENSING (FPPK) CONTROL SYSTEMS

This system utilizes a standing pilot with thermocouple. Has flame sensing technology to safely manage the flame and gas flow. Offers manual flame height adjustment, manual switch spark igniter (battery operated), and a safety pilot valve mounted in a stainless steel box.



Size: 7.5"x6.5"x2.6"

Max BTU	Gas Type	Models
140k	Natural Gas Liquid Propane	FPPK-NG FPPK-LP

PILOT ASSEMBLY AND BLOWOUT BOX

See chart for recommended burner size.

*Includes:* Assembled stainless steel control box, 36" pilot assembly with spark igniter, and blowout box, flex line, hard pipe, and fittings.

#### Recommended FPPK Burner Size

Burner Type	Size w/ FPPK-HC	Size w/ FPPK-MC
Penta Series	18" ~ 30"	12" ~ 24"
Round Burner	18" ~ 30"	12" ~ 18"
H-Burner Series	30"X8" ~ 48"X10"	24"X6" ~ 30"X8"
Square Burner	18" ~ 24"	12" ~ 18"
T-Burner	50" ~ 72"	36" ~ 48"

**NOTE:** Burner too small could result in unsafe LP back pressure. Burner too large could result in small, undesirable flame height.

### COMMERCIAL AUTOMATIC SHUTOFF TIMERS - 120VAC

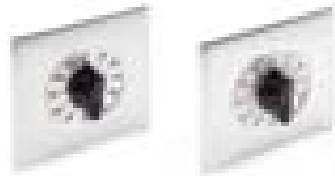

**694** 2 Hour Timer  
**695** 12 Hour Timer

Stainless Steel Rotary Timer (SPDT, 20A) 1/2" deep. Double gang box recommended. For use with NEMA 3R box for mounting.

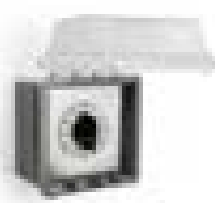

**694 NEMA** 2 Hour Timer  
**695 NEMA** 12 Hour Timer

NEMA 3R Box with 694 or 695 timer. Includes timer mounted into the NEMA 3R box for your convenience.



**696** 2, 4, 8 and 12 Hour Timer  
Four preset switch for indoors. Can be set at 2, 4, 8, and 12 hours (SPDT, 20A). Fits single Gangbox

Available Now!!!



**GT-ESTOP-2.5** 2.5 Hour Timer  
A combination of an "Emergency Stop" control switch, plus a Gas-turn-off timer that is adjustable up to 2-1/2 hours.  
NG - 290,000 BTU/hr Max Capacity  
LP - 430,000 BTU/hr Max Capacity

### POWER SUPPLIES - FOR 24VAC & 12VAC MODELS

Input Primary - 120VAC, 60/50Hz, 1A max  
Output Secondary - 24VAC & 12VAC, 60/50Hz, 4A



24VAC Model	Style	For use with
311-PS1	1 Output	24 VAC Inserts
311-PS3	3 Outputs	24 VAC Inserts
311-PS5	5 Outputs	24 VAC Inserts

12VAC Model	Style	For use with
313-PS1	1 Output	12 VAC Copper
313-PS3	3 Outputs	12 VAC Copper
313-PS5	5 Outputs	12 VAC Copper

### COMMERCIAL EMERGENCY STOP - 120VAC, 24VAC OR 12VAC

Perfect for commercial applications of Evolution 360 or EI systems. Push button with keyed reset allows supervisor confirmation. Safely turns off up to 3 circuits plus one fail safe function.



For replacement Keys use product number:  
**E-STOP-KEY**

**311-ESTOP-3**  
Size: 2.8" x 2.8" x 4", Rated for 600VA, 10A  
Rated IP65 - Protection against dust and low pressure water from all directions.

### 120 VAC OUTDOOR ON/OFF REMOTE CONTROL



**578-C**  
Used with EI Fire Pit Systems. 120 VAC models only. CARLON in-line power control with 3 prong in/out.



# FIRE PIT COMPONENTS

UNASSEMBLED -  
NON-CERTIFIED

The LP Kit includes the burner, properly sized air mixer, and fittings.  
The NG Kit includes the burner.

## PENTA BURNERS- STAINLESS STEEL (#304)

Size	Gas Type	Nozzle	Model	Inlet	Btu	Nozzle BTU
12"	Natural Gas	TOR	PENTA12 KIT	1/2"	65k	100k
18"	Natural Gas	TOR	PENTA18 KIT	1/2"	125k	175k
24"	Natural Gas	TOR	PENTA24 KIT	1/2"	200k	250k
30"	Natural Gas	TOR	PENTA30 KIT	3/4"	250k	300k
36"	Natural Gas	TOR	PENTA36 KIT	3/4"	300k	350k
48"	Natural Gas	TOR	PENTA48 KIT	3/4"	300k	350k

5% DISCOUNT		
Nozzle	Model	Bulk Qty.
TOR	PENTA12	10
TOR	PENTA18	10
TOR	PENTA24	10
TOR	PENTA30	5
TOR	PENTA36	5
TOR	PENTA48	5

**BULK CARTON**

**INCLUDES BURNERS ONLY**

**Features:**  
Burner Ports-9 and 3 o'clock  
Raised Hub Design  
Patented Technology



Penta Burner

See Pg. 11 for Penta Burner Features

## ROUND BURNER- STAINLESS STEEL (#304)

Size	Gas Type	Model	Inlet	Btu
6"	Natural Gas	FRS-6 KIT	1/2"	60k
12"	Natural Gas	FRS-12 KIT	1/2"	90k
18"	Natural Gas	FRS-18 KIT	1/2"	150k
24"	Natural Gas	FRS-24 KIT	1/2"	150k
24" (HC)	Natural Gas	FRS-24HC KIT	3/4"	300k
30"	Natural Gas	FRS-30 KIT	1/2"	300k
30" (HC)	Natural Gas	FRS-30HC KIT	3/4"	300k
36"	Natural Gas	FRS-36HC KIT	3/4"	300k
48"	Natural Gas	FRS-48HC KIT	3/4"	300k

5% DISCOUNT		
Model	Bulk Qty.	
FRS6	10	
FRS12	10	
FRS18	10	
FRS24	10	
FRS24HC	10	
FRS30	5	
FRS30HC	5	
FRS36HC	5	
FRS48HC	5	

**BULK CARTON**

**INCLUDES BURNERS ONLY**

**Features:**  
Burner Ports - Staggered  
Raised Hub Design

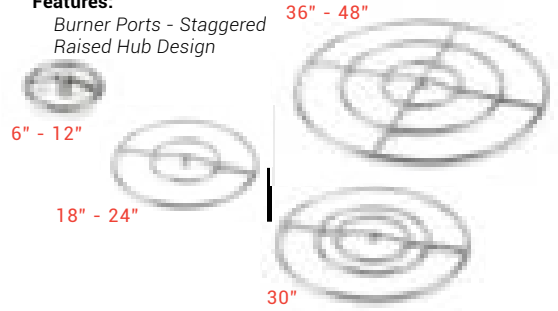

## SQUARE BURNERS- STAINLESS STEEL (#304)

Size	Gas Type	Model	Inlet	Btu
12"	Natural Gas	FRSSQ-12 KIT	1/2"	90k
18"	Natural Gas	FRSSQ-18 KIT	1/2"	150k
24"	Natural Gas	FRSSQ-24 KIT	1/2"	150k
36"	Natural Gas	FRSSQ-36HC KIT	3/4"	300k
48"	Natural Gas	FRSSQ-48HC KIT	3/4"	300k

5% DISCOUNT		
Model	Bulk Qty.	
FRSSQ12	10	
FRSSQ18	10	
FRSSQ24	10	
FRSSQ36HC	5	
FRSSQ48HC	5	

**BULK CARTON**

**INCLUDES BURNERS ONLY**

**Features:**  
Burner Ports - Staggered  
Raised Hub Design

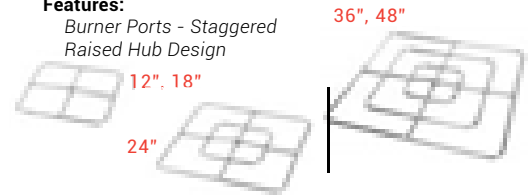

## RECTANGLE BURNERS- STAINLESS STEEL (#304)

Size	Gas Type	Model	Inlet	Btu
12"x 6"	Natural Gas	FRSR-12X6 KIT	1/2"	90k
18"x 9"	Natural Gas	FRSR-18X9 KIT	1/2"	150k
24"x 12"	Natural Gas	FRSR-24X12 KIT	1/2"	150k
36"x 18"	Natural Gas	FRSR-36X18 KIT	1/2"	200k
48"x 24"	Natural Gas	FRSR-48X24HC KIT	3/4"	300k

5% DISCOUNT		
Model	Bulk Qty.	
FRSR12X6	10	
FRSR18X9	10	
FRSR24X12	10	
FRSR36X18	5	
FRSR48X24HC	5	

**BULK CARTON**

**INCLUDES BURNERS ONLY**

12" x 6" ~ 36" x 18"

**Features:**  
Burner Ports - Staggered  
Raised Hub Design

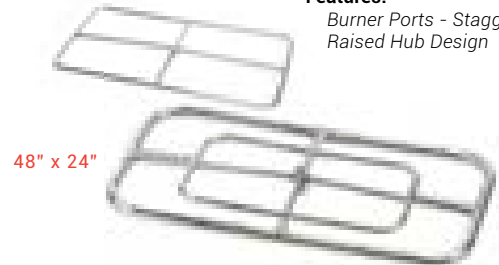

## LINEAR BURNERS- INTERLINK PAN & T-BURNER, STAINLESS STEEL (#304)

Size (A")	Gas Type	Nozzle	Model	Inlet	Btu	Nozzle BTU
25"X 8"	Natural Gas	TOR	IL25X8SS	1/2"	50k	100k
37"X 8"	Natural Gas	TOR	IL37X8SS	1/2"	75k	125k
49"X 8"	Natural Gas	TOR	IL49X8SS	1/2"	100k	150k
61"X 8"	Natural Gas	TOR	IL61X8SS	1/2"	125k	175k
73"X 8"	Natural Gas	TOR	IL73X8SS	1/2"	150k	200k
97"X 8"	Natural Gas	TOR	IL97X8SS	1/2"	200k	250k
121"X 8"	Natural Gas	TOR	IL121X8SS	1/2"	250k	300k

**Features:**  
Sidewalls add strength and hold media  
Burner Ports - Staggered  
Removable center section on some models  
Raised Hub Design

**Includes:**  
Pan, Burner and Brackets

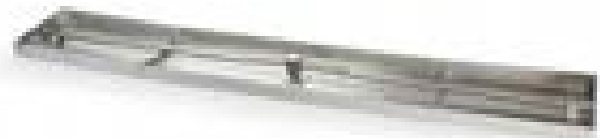



### LINEAR BURNERS- TROUGH PAN & T-BURNER STAINLESS STEEL (#304)

Size (A")	Gas Type	Nozzle	Model	Inlet	Btu	Nozzle BTU
24"	Natural Gas	TOR	24SS TRGH	1/2"	50k	100k
36"	Natural Gas	TOR	36SS TRGH	1/2"	75k	125k
48"	Natural Gas	TOR	48SS TRGH	1/2"	100k	150k
60"	Natural Gas	TOR	60SS TRGH	1/2"	125k	175k
72"	Natural Gas	TOR	72SS TRGH	1/2"	150k	200k
96"	Natural Gas	TOR	96SS TRGH	1/2"	200k	250k

**Includes:**  
Pan, Burner and Brackets



**Features:**  
Sidewalls add Rigidity  
Burner Ports - Staggered

### RECTANGLE BURNERS- STAINLESS STEEL (#304)

Size (A")	Gas Type	Nozzle	Model	Inlet	Btu	Nozzle BTU
24" x 12"	Natural Gas	TOR	24X12SS-H	1/2"	60k	125k
30" x 12"	Natural Gas	TOR	30X12SS-H	1/2"	90k	150k
36" x 14"	Natural Gas	TOR	36X14SS-H	1/2"	90k	175k
42" x 14"	Natural Gas	TOR	42X14SS-H	1/2"	150k	200k
54" x 16"	Natural Gas	TOR	54X16SS-H	1/2"	150k	250k
66" x 16"	Natural Gas	TOR	66X16SS-H	1/2"	250k	300k
78" x 16"	Natural Gas	TOR	78X16SS-H	1/2"	300k	300k
90" x 16"	Natural Gas	TOR	90X16SS-H	1/2"	300k	300k

**Features:**  
Burner Ports - Staggered  
Raised Hub Design  
Sidewalls add Structure and Hold Media

**Includes:**  
Pan, Burner and Brackets

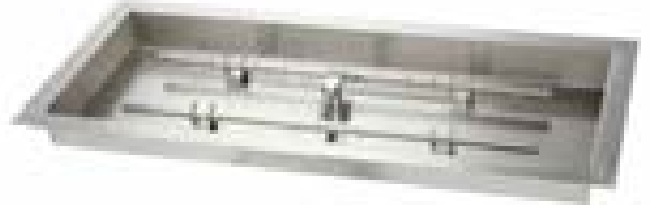

### LINEAR T-BURNERS- RAISED, STAINLESS STEEL (#304)

Size	Gas Type	Nozzle	Model	Inlet	Btu	Nozzle BTU
24"	Natural Gas	TOR	LTBSS24	1/2"	50k	100k
36"	Natural Gas	TOR	LTBSS36	1/2"	75k	125k
48"	Natural Gas	TOR	LTBSS48	1/2"	100k	150k
60"	Natural Gas	TOR	LTBSS60	1/2"	125k	175k
72"	Natural Gas	TOR	LTBSS72	1/2"	150k	200k
96"	Natural Gas	TOR	LTBSS96	1/2"	200k	250k
120"	Natural Gas	TOR	LTBSS120	1/2"	250k	300k

5% DISCOUNT			
	Nozzle	Model	Bulk Qty.
BULK CARTON	TOR	LTBSS24	10
	TOR	LTBSS36	10
	TOR	LTBSS48	10
	TOR	LTBSS60	10
	TOR	LTBSS72	10
	TOR	LTBSS96	5
	TOR	LTBSS120	5
INCLUDES BURNERS ONLY			

**Features:**  
Burner Ports - Staggered  
Raised Hub Design



### FIRE PIT H-BURNERS- STAINLESS STEEL (#304)

Size	Gas Type	Nozzle	Model	Inlet	Btu	Nozzle BTU
18"x 6"	Natural Gas	TOR	HBSB18 KIT	1/2"	60k	125k
24"x 6"	Natural Gas	TOR	HBSB24 KIT	1/2"	90k	150k
30"x 8"	Natural Gas	TOR	HBSB30 KIT	1/2"	90k	175k
36"x 8"	Natural Gas	TOR	HBSB36 KIT	1/2"	150k	200k
48"x 10"	Natural Gas	TOR	HBSB48 KIT	1/2"	150k	250k
60"x 10"	Natural Gas	TOR	HBSB60 KIT	1/2"	250k	300k
72"x 10"	Natural Gas	TOR	HBSB72 KIT	1/2"	300k	300k
84"x 10"	Natural Gas	TOR	HBSB84 KIT	1/2"	300k	300k

5% DISCOUNT			
	Nozzle	Model	Bulk Qty.
BULK CARTON	TOR	HBSB18	10
	TOR	HBSB24	10
	TOR	HBSB30	10
	TOR	HBSB36	10
	TOR	HBSB48	10
	TOR	HBSB60	10
	TOR	HBSB72	10
	TOR	HBSB84	10
INCLUDES BURNERS ONLY			

**Features:**  
Burner Ports - Point Inward  
Raised Hub Design



# FIRE PIT COMPONENTS



Photo - HPC Fire Inspired™

## LOG LIGHTER BURNER- STAINLESS STEEL

Includes - stainless steel burner tube, LP air mixer NG orifice, connector end cap coupler and elbow, connected together in sections.

Custom Lengths Available

Model #	Size in inches	Gas
SS17N	17"	NG
SS17P	17"	LP



## MISCELLANEOUS PARTS

### SPARK IGNITER COMPONENTS



690-AA

Mounts easily with 2 screws. Use with external switch.  
AA batteries easy to replace.  
Sealed battery compartment.  
Dual ignition outlets  
(Replaces #690)



691AA-HPC

Screw-in cap holds unit in place.  
Uses 1 AA battery. Sealed battery chamber. Easy Battery Replacement



130

Snap-in Type  
One spark per button push.



131

Electrode to use with the 130 Spark Igniter pictured to the left

### FPK PUSH BUTTON SPARK IGNITION KIT

Includes Spark Generator, Ignition, Mounting Plate and AA Battery

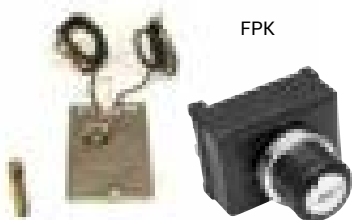

FPK

### FPLP SERIES SMALL LP TANK CONVERSION KIT

Includes Regulator, Air Mixer, 12' Hose with quick disconnect, shut off valve, and fittings.

Minimum Burner Size: 12"

Minimum T-Burner Size: 48"

IMPORTANT: If using glass media, glass application to burner must be minimal to avoid backpressure. Read instructions carefully.

Not for use with HPC **Certified** Inserts



FPLP40 - 40k Btu  
FPLP90 - 90k Btu

## REPLACEMENT COMPONENTS

### EI SERIES REPLACEMENT COMPONENTS

Item	Model
<b>On/Off &amp; High/Low Models</b>	
Hot Surface Igniter	312-IGNITER
Thermocouple- 36"	311-T/C
Electronic Module	312-EIMOD
Transformer	576-75VA
Fuse (5A)	See Note*

Item	Model
<b>On / Off Models Only</b>	
Gas Valve	210-EI415

\*Commonly found fast acting 5A Fuse

Item	Model
<b>High / Low Models Only</b>	
Remote- Handheld	312-REMOTE
Remote- Transceiver	312-W/T
Antenna	312-ANTENNA
Antenna Bracket	312-AB
Antenna Extension Cable - 60"	AEK-60HI/LO
Gas Valve- 2 Stage	312-2STAGE415

### EI SERIES REPLACEMENT PILOT ASSEMBLIES - ON/OFF & HI/LO MODELS

Gas	Btu Rating (Main)	Model	Length
NG	50K ~ 275k	HSIP-36SS	36"
NG	300k Btu	HSIP-36SS-300NG	36"
NG	400k	HSIP-36SS-400NG	36"
LP	50K ~ 225k Btu	HSIP-36SS-50 / 225LP	36"
LP	250k ~ 400k Btu	HSIP-36SS-250 / 400LP	36"

## REPLACEMENT COMPONENTS

### HWI SERIES REPLACEMENT COMPONENTS

PLEASE NOTE: FOR MVK-HWI Control box we require the box be returned for repair. Please call use for support!



120-HWI  
Burner Mount Clamp



311-T/C  
36" Thermocouple



311-T/C 72  
72" Thermocouple



311-T/C EXT  
36" Extension



598HWI  
Blowout Box



HWI-913  
Igniter Repair Kit

### HWI SERIES REPLACEMENT PILOT ASSEMBLIES



Gas	Btu Rating (Main)	Model	Length
NG	50K ~ 275k	HWIP-36SS	36"
NG	300k Btu	HWIP-36SS-300NG	36"
NG	400k	HWIP-36SS-400NG	36"

Gas	Btu Rating (Main)	Model	Length
LP	50K ~ 225k Btu	HWIP-36SS-50 / 225LP	36"
LP	250k ~ 400k Btu	HWIP-36SS-250 / 400LP	36"

### FPPK SERIES REPLACEMENT COMPONENTS



108-C  
Safety Pilot Valve  
(90k), FPPK-NG



109-C  
Safety Pilot Valve (90k),  
Rear Inlet Valve, 2010  
FPPK Model



110  
Safety Pilot Valve  
(90k), Side Inlet, used  
in FPPK-MC Box



691AA-HPC  
Igniter Switch



FPPK-P36 NG  
FPPK-P36 LP  
36" Pilot Tube, T/C



598HWI  
Blowout Box



111  
Black Knob



902  
Valve Face Plate  
Nut (For 108-C  
Valve)



100-HC  
High Capacity Valve  
(140k) used in  
FPPK-HC Box



693  
Igniter

### FPK SERIES REPLACEMENT COMPONENTS



131  
Spark Electrode

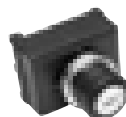

691AA-HPC  
Igniter Switch

### OTHER ELECTRONIC IGNITION COMPONENTS



576-40VA  
24VAC Transformer - 40VA



576-100VA  
24VAC Transformer - 100VA



210-EI  
Honeywell 150k Valve



210-EIHC  
Honeywell 270k Valve



210-EI415  
Honeywell 415K Valve



210-EI MOD  
Honeywell IPI Module

# FIRE PIT ACCESSORIES CHART

THIS CHART WILL HELP YOU DETERMINE WHAT SIZE AND HOW MUCH OF AN ACCESSORY IS NEEDED

	OPTIONAL COMPONENTS				MEDIA		
	Vinyl Covers**	Outdoor Logs***	Wind Guards****	Install Collar IC44SS-FF	Lava Rock or Rolled Lava	Decorative Glass	River Rock
Size	(Pg. 48)	(Pg. 43)	(Pg. 46)	2 per box (Pg. 51)	(Pg. 44)	(Pg. 45)	(Pg. 44)

## ROUND BOWL INSERTS (PG. 14)

					1 Bag ~ 1/2 cu. ft.	(Lbs)	(Box)
13"	FPC-35	FPL18xx	WG23-RD	1 Box	1 Bag	20	1
19"	FPC-45	FPL18xx	WG30-RD	1 Box	2 Bags	40	1
25"	FPC-45	FPL18xx	WG30-RD	1 Box	2 Bags	60	2
31"	FPC-53	FPL18xx	WG38-RD	1 Box	2 Bags	90	3
37"	FPC-53	FPL30xx	WG48-RD	2 Boxes	4 Bags	120	4
43"	FPC-64	FPL30xx	WG48-RD	2 Boxes	4 Bags	160	5

## ROUND FLAT INSERTS (PG. 16)

14"	FPC-35	FPL18xx	WG23-RD	1 Box	1 Bag	30	1
18"	FPC-45	FPL18xx	WG23-RD	1 Box	2 Bags	30	1
24"	FPC-45	FPL18xx	WG30-RD	1 Box	2 Bags	50	2
30"	FPC-53	FPL18xx	WG38-RD	2 Boxes	2 Bags	80	3
36"	FPC-53	FPL30xx	WG38-RD	2 Boxes	4 Bags	110	4
42"	FPC-64	FPL30xx	WG48-RD	2 Boxes	4 Bags	150	5
54"	FPC-76	FPL30xx	N/A	3 Boxes	6 Bags	250	8

## SQUARE BOWL INSERTS (PG. 18)

18"	FPC-48SQ	FPL18xx	WG25-SQ	1 Box	2 Bags	40	1
24"	FPC-48SQ	FPL18xx	WG31-SQ	2 Boxes	2 Bags	70	2
30"	FPC-60SQ	FPL18xx	WG37-SQ	2 Boxes	2 Bags	110	3
36"	FPC-60SQ	FPL30xx	WG43-SQ	2 Boxes	6 Bags	150	4
42"	FPC-60SQ	FPL30xx	WG49-SQ	2 Boxes	6 Bags	190	4

## SQUARE FLAT INSERTS (PG. 20)

18"	FPC-48SQ	FPL18xx	WG25-SQ	1 Box	2 Bags	40	1
24"	FPC-48SQ	FPL18xx	WG31-SQ	2 Boxes	2 Bags	70	2
30"	FPC-60SQ	FPL18xx	WG37-SQ	2 Boxes	2 Bags	100	3
36"	FPC-60SQ	FPL30xx	WG43-SQ	2 Boxes	6 Bags	140	4
42"	FPC-60SQ	FPL30xx	WG49-SQ	2 Boxes	6 Bags	190	4

## RECTANGLE BOWL INSERTS (PG. 22)

24X12"	FPC-62X30	FPL18xx	WG31X19-RECT	1 Box	2 Bags	40	1
30X12"	FPC-62X30	FPL18xx	WG37X19-RECT	1 Box	2 Bags	40	2
36X14"	FPC-78X40	FPL30xx	WG43X21-RECT	2 Boxes	2 Bags	60	2
42X14"	FPC-78X40	FPL30xx	WG49X21-RECT	2 Boxes	2 Bags	70	3
54X16"	FPC-78X40	FPL30xx	WG61X23-RECT	2 Boxes	4 Bags	100	3
66X16"	FPC-90X40	FPL30xx	N/A	2 Boxes	6 Bags	120	4
78X16"	FPC-102X40	FPL30xx (2)	N/A	3 Boxes	6 Bags	140	4
90X16"	FPC-114X40	FPL30xx (2)	N/A	3 Boxes	8 Bags	160	5

## S-FIRE BURNER INSERTS (PG. 24) (LIMITED STOCK, TO BE DISCONTINUED)

36X14"	FPC-78X40	FPL18xx	WG43X21-RECT	2 Boxes	2 Bags	60	2
42X14"	FPC-78X40	FPL18xx	WG49X21-RECT	2 Boxes	2 Bags	70	3
54X16"	FPC-78X40	FPL30xx	WG61X23-RECT	2 Boxes	4 Bags	100	3
66X16"	FPC-90X40	FPL30xx	N/A	2 Boxes	6 Bags	120	4
78X16"	FPC-102X40	FPL30xx	N/A	3 Boxes	6 Bags	140	4

**THIS CHART WILL HELP YOU DETERMINE WHAT SIZE AND HOW MUCH OF AN ACCESSORY IS NEEDED**

	OPTIONAL COMPONENTS				MEDIA		
	Vinyl Covers**	Outdoor Logs***	Wind Guards****	Install Collar IC44SS-FF	Lava Rock or Rolled Lava	Decorative Glass	River Rock
Size	(Pg. 48)	(Pg. 43)	(Pg. 46)	2 per box (Pg. 51)	(Pg. 44)	(Pg. 45)	(Pg. 44)

**LINEAR TROUGH INSERTS (PG. 26)**

24"	FPC-44X30	FPL18xx	WG31X15-L	1 Box	1 Bag	20	1
36"	FPC-62X30	FPL18xx	WG43X15-L	2 Boxes	2 Bags	30	1
48"	FPC-62X30	FPL30xx	WG55X15-L	2 Boxes	2 Bags	40	1
60"	FPC-94X30	FPL30xx	WG67X15-L	2 Boxes	2 Bags	40	1
72"	FPC-94X30	FPL30xx (2)	N/A	2 Boxes	2 Bags	50	2
96"	FPC-130X30	FPL30xx (3)	N/A	2 Boxes	2 Bags	60	2

**LINEAR INTERLINK INSERTS (PG. 28)**

25X8"	FPC-44X30	FPL18xx	WG31X15-L	1 Box	1 Bag	20	1
37X8"	FPC-62X30	FPL18xx	WG43X15-L	2 Boxes	2 Bags	30	1
49X8"	FPC-62X30	FPL30xx	WG55X15-L	2 Boxes	2 Bags	40	1
61X8"	FPC-94X30	FPL30xx	WG67X15-L	2 Boxes	2 Bags	40	2
73X8"	FPC-94X30	FPL30xx (2)	N/A	2 Boxes	4 Bags	50	2
97X8"	FPC-130X30	FPL30xx (3)	N/A	2 Boxes	4 Bags	60	2
121X8"	FPC-130X30	FPL30xx (3)	N/A	3 Boxes	6 Bags	80	3

**Notes: \*\*Vinyl Covers:** Part numbers listed are commonly used sizes- other vinyl sizes and Hard Covers available (Pg. 46).  
**\*\*\*Outdoor Logs:** Part numbers listed are commonly used sizes- other sizes available (Pg. 42).  
**\*\*\*\*Wind Guards:** Part numbers listed are commonly used sizes- For extra large fire pits, multiple wind guards can be combined to accommodate the larger size - other sizes available (Pg. 45).



# POP DISPLAYS



## HPC DISPLAY STANDS

**FOR DISPLAY ONLY! NOT FOR OUTDOOR INSTALLATION**

Need to display your fire pit inserts? Our steel display stands give full access to the insert for your customer to look at every detail!

The fire pit insert displays are available as follows:

- 1) Push Button / Spark Ignition (FPPK) Display Kit- includes applicable FPPK fire pit insert, match lit insert control valve (327-CH) and the display stand.
- 2) Electronic Ignition (EI) Display Kit- includes applicable EI fire pit insert and the display stand.
- 3) Stand Only

Style	Round	Rectangle	Linear Trough	Linear- Interlink	Description
	DS25-ROUND-FPPK	DS30X12-HBURNER-FPPK	DS36-TRGH-FPPK	DS49X8-LINEAR-FPPK	Includes Push Button / Spark Ignition fire pit insert match lit valve, mounting sleeve & stand.
	DS25-ROUND-EI	DS30X12-HBURNER-EI	DS36-TRGH-EI	DS49X8-LINEAR-EI	Includes Electronic Ignition fire pit insert and display stand.
Stand Only	DS25-ROUND	DS30X12-HBURNER	DS36-TRGH	DS49X8-LINEAR	Includes stand only.



**DS25-ROUND-FPPK**

For use with 25" Round Insert



**DS30x12-HBURNER-FPPK**

For use with 30x12" H-Burner Insert



**DS36-TRGH-FPPK**

For use with 36" Trough Insert



**DS49X8-LINEAR-FPPK**

For use with 49"x8" Interlink Insert

## LITERATURE



Style	Name
LIT-BROCHURE OUTDOOR	Night Impressions
LIT- CATALOG	Outdoor/Indoor Product Catalog
LIT- WATER BROCHURE OUTDOOR	Fire Meets Water Brochure

## BANNER KITS

48"x30" Banner for storefront display

Model	Description
BANNER KIT	Coroplast (Rigid Plastic Board)
BANNER KIT-OUTDOOR	Vinyl Outdoor Banner with grommets in the corners



- 64 Safety Pilot Kits
- 73 Millivolt Kits
- 79 Electronic Ignition
- 83 Remote Control Kits
- 88 Manual Valve Kits & Log Lighters
- 89 Burners & Pans
- 90 Flex Lines
- 92 Accessories
- 93 Spark Igniters & Regulators
- 94 Fireplace Media
- 95 Fittings

# SAFETY PILOT KITS

Let us assemble the kit tailored for your business needs— you choose valve / pilot assembly, fittings, heat shield, etc. We assemble & package with your assigned part #- all in one box!

The safety pilot valve provides a safe shutdown in the event of an interruption in the gas supply or flameout. Using a standing pilot provides a convenient means of lighting the main burner. The flame height is manually controlled using the valve adjusting knob. The valve also controls the main burner. HPC offers numerous kit configurations providing installation flexibility and convenient use.

**Benefits: Flame Sensed, Manual flame height control, Simple main burner ignition.**

## SIDE INLET VALVE KITS - 70 SERIES



### **70PKN-HC - High Capacity! 142K Btu**

Safety pilot kit for natural gas applications with burner having 1/2" male threads on burner tube. Can easily mount straight out from burner pan or has fittings to allow valve to move forward and up from the floor away from the burner pan. Uses White Rodgers High Capacity 142k Btu, 250° valve. For LP applications use 70LPK-HC conversion kit (Pg. 69)

#### **Kit Includes:**

- White-Rodgers High Capacity Valve (#100-HC): Side Gas Inlet, 142k Btu, 250° Rating
- 18" Pilot Assembly with mounting bracket.
- Assorted fittings for valve / burner connection.
- Heat Shield for valve.
- 12" Flex Line for valve input.
- Black control knob with 4" stem extension.



# SIDE INLET VALVE KITS - 70 SERIES

---



## **72PKNQM - 3" Swivel Flare Connection**

"Quick Mount" swivel flare connector version for easy connection to burner. Uses Copreci 300°, 90K Btu side inlet valve. For natural gas applications with gas log sets having either 3/8" female thread, 3/8" male thread, or 1/2" male thread on end of the burner tube, 90k Btu. For LP applications use 70LPK-QM conversion kit (Page 69)

### **Kit Includes:**

- Copreci Safety Pilot Valve (#110): Side Gas Inlet, 90k Btu, 300° Rating.
- 18" Pilot Assembly with mounting bracket.
- 3" Swivel Flare Connector for easy valve / burner connection.
- Heat Shield for valve.
- Black control knob with 4" stem extension.
- Assorted fittings for various burner threads.

White  
Rodgers



## **72PKN - Hard Pipe Connection**

Hard pipe connection to burner with use of fittings. Uses Copreci 300°, 90k Btu side inlet valve. For natural gas applications with burners having 3/8" female, 3/8" male or 1/2" male thread. For LP applications use the 70LPK conversion kit (Pg. 69).

### **Kit Includes:**

- Copreci Safety Pilot Valve (#110): Side Gas Inlet, 90k Btu, 300° Rating.
- 18" Pilot Assembly with mounting bracket.
- Assorted fittings for valve / burner connection.
- Heat Shield for valve.
- Black control knob with 4" stem extension.
- Assorted fittings for various burner threads.

 **COPRECI**

## SAFETY PILOT KITS (CONTINUED)

Let us assemble the kit tailored for your business needs— you choose valve / pilot assembly, fittings, heat shield, etc. We assemble & package with your assigned part #- all in one box!



### 172UPK - Hard Pipe Connection

Combines 72PKN & 70LPK for either LP or natural gas installations.

#### Kit Includes:

- 72PKN components
- Vermiculite
- Air Mixer / Orifice
- Pilot Assembly LP Orifice.



## REAR INLET VALVE KITS - 80 SERIES



### 80PKN - Hard Pipe Connection

Hard pipe connection to burner with use of fittings. Uses Copreci 300°, 90k Btu rear inlet valve. For natural gas applications with burners having 3/8" female, 3/8" male or 1/2" male thread. For LP applications use the 70LPK conversion kit (Pg. 69).

#### Kit Includes:

- Copreci Safety Pilot Valve (#109-C): Rear Gas Inlet, 90k Btu, 300° Rating.
- 18" Pilot Assembly with mounting bracket.
- Assorted fittings for valve / burner connection.
- Heat Shield for valve.
- Black control knob with 4" stem extension.
- Assorted fittings for various burner threads.



## 80PKNQM - 3" Swivel Flare Connection

"Quick Mount" swivel flare connector system. Uses 300° rear inlet Copreci Valve. All fittings for mounting to all "standard" type burner pans. Designed to fit burners having 3/8" female, 3/8" male or 1/2" male threads on burner tube, 90k Btu. For LP applications use 70LPK-QM conversion kit (Page 69).

### Kit Includes:

- Copreci Safety Pilot Valve (#109-C): Rear Gas Inlet, 90k Btu, 300° Rating.
- 18" Pilot Assembly with mounting bracket.
- 3" Swivel Flare Connector for easy valve / burner connection.
- Heat Shield for valve.
- Black control knob with 4" stem extension.
- Assorted fittings for various burner threads.



## 81PKNQM - 1.5" Swivel Flare Connection

"Quick Mount" swivel Flare connector system. Uses Copreci 300° rear inlet valve. Uses 1½" swivel connector to give a more compact fit, and easier assembly. Designed to fit burner pans with 1/2" male threads on the end of the burner tube, 90k Btu. For LP applications use 70LPK-QM conversion kit (Page 69).

### Kit Includes:

- Copreci Safety Pilot Valve (#109-C): Rear Gas Inlet, 90k Btu, 300° Rating.
- 18" Pilot Assembly with mounting bracket.
- 1.5" Swivel Flare Connector for easy valve / burner connection.
- Heat Shield for valve.
- Black control knob with 4" stem extension.
- Assorted fittings for various burner threads.

# SAFETY PILOT KITS (CONTINUED)

Let us assemble the kit tailored for your business needs— you choose valve / pilot assembly, fittings, heat shield, etc. We assemble & package with your assigned part #- all in one box!



## 182UPK - Universal Natural Gas and Liquid Propane

Contains all components of 80PKN and 70LPK. This kit can be used for either Natural or LP installations.

### Kit Includes:

- 80PKN components (Page 66)
- Vermiculite
- Air Mixer / Orifice
- Pilot Assembly LP Orifice.



## SPK-85 - Fully Assembled!

Comes to you fully assembled. Uses Copreci 300° rear inlet valve. Designed to fit only burner pans with 1/2" male threads on the end of the burner tube. For natural gas. 90k Btu. For LP applications use 70LPK conversion kit (Page 69).

### Kit Includes:

- Copreci Safety Pilot Valve (#109-C): Rear Gas Inlet, 90k Btu, 300° Rating.
- 18" Pilot Assembly with mounting bracket.
- Assorted fittings for valve / burner connection.
- Heat Shield for valve.
- Black control knob with 4" stem extension.
- Assorted fittings for various burner threads.



## LOW PROFILE VALVE KITS - 90 SERIES

### 91PKN - Hard Pipe Connection

Ultra low profile safety pilot kit that employs a Copreci rear inlet 90k Btu, 300° valve. Fits all standard type burner pans. Designed to fit burners with 3/8" female threads, 3/8" male threads and 1/2" male threads. For LP applications use 70LPK conversion kit (Page 69).

### Kit Includes:

- Copreci Safety Pilot Valve (#108-C): Low Profile, Rear Gas Inlet, 90k Btu, 300° Rating.
- 18" Pilot Assembly with mounting bracket.
- Assorted fittings for valve / burner connection.
- Low Profile Heat Shield for valve.
- Black control knob with 4" stem extension.
- Assorted fittings for various burner threads.



# LOW PROFILE VALVE KITS - 90 SERIES



## 91PKNQM - 1.5" Swivel Flare Connection

Quick Mount System uses 300° low profile, rear inlet Copreci valve. This kit is designed to fit all standard type burner pans. Designed to fit burners with 3/8" female threads, 3/8" male threads and 1/2" male threads. 90k Btu. For LP applications use 70LPK conversion kit (Page 69).

### Kit Includes:

- Copreci Safety Pilot Valve (#108-C): Low Profile, Rear Gas Inlet, 90k Btu, 300° Rating.
- 18" Pilot Assembly with mounting bracket.
- 1.5" Swivel Flare Connector for easy valve / burner connection.
- Low Profile Heat Shield for valve.
- Black control knob with 4" stem extension.
- Assorted fittings for various burner threads.



## CFPVC - Ceramic Fiber Pilot Valve Cover

Heat shield/valve cover made of light weight ceramic fiber and hand painted. Designed for safety pilot valves.

# LP CONVERSION KITS



## 70LPK

For use with 72PKN, 80PKN, 83PKN, SPK-85. Includes: Vermiculite, Air Mixer / Orifice, 2 LP Pilot Orifices

## 70LPK-HC

For use with 70PKN-HC. Includes: Vermiculite, 1/2" Air Mixer / Orifice, 2 LP Pilot Orifices

## 70LPK-QM

For use with 72PKNQM, 80PKNQM, 81PKNQM, and 91PKNQM. Includes: Vermiculite, Air Mixer / Orifice, 2 LP Pilot Orifices

# SAFETY PILOT KITS (CONTINUED)

Let us assemble the kit tailored for your business needs— you choose valve / pilot assembly, fittings, heat shield, etc. We assemble & package with your assigned part #- all in one box!

## SAFETY PILOT REPLACEMENT VALVES



### 100-HC

250° Rated Valve  
Includes knob  
High Capacity 142k Btu



### 108-C

Lowest Profile  
300° Rated Valve  
90k Btu



### 109-C

300° Rated Valve  
Rear Inlet  
90k Btu



### 110

300° Rated Valve  
Side Inlet  
90k Btu

## PILOT ASSEMBLIES

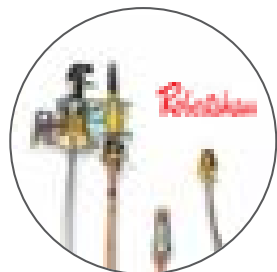

102 Pilot Assembly

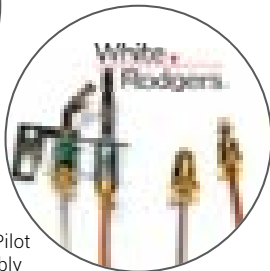

102-W Pilot Assembly

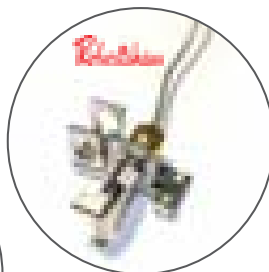

#107 Pilot Head

Model #	Gas	Description
102*	NG	18" Leads, 90° 2-way Hood
102P	LP	18" Leads, 90° 2-way Hood
102-36	NG	36" Leads, 90° 2-way Hood
102-48	NG	48" Leads, 90° 2-way Hood
102-72	NG	72" Leads, 90° 2-way Hood
102-W	NG	18" Leads; White-Rodgers, 1-way Hood
107	NG	90° Hood Bracket and tubing (no T/C)

\*Used in all Safety Pilot Kits



# THERMOCOUPLES

## 120

Pilot assembly bracket- this bracket allows for mounting the pilot assembly to the burner pan by simply sliding bracket onto edge of pan. Works for most safety pilot and millivolt pilot assemblies. Measures 1.75" x 1.75".



Model #	Length	Description
106M	18"	METRIC; DV thermocouple; quick drop.
106R	18"	Robertshaw- fits 102 & 102-P assembly
106W	18"	White-Rodgers- fits 102-W
106U	18"	Universal Thermocouple For use with Both Metric and Standard
117	36"	Robertshaw- 36" fits 102 & 102-P assembly
112	48"	Robertshaw- 48" fits 102 & 102-P assembly
116	72"	Robertshaw- 72" fits 102 & 102-P assembly
120	-	Pilot Burner Mounting Bracket



## THERMOCOUPLE THREAD ADAPTERS

These adaptors allow for valve / thermocouples of different type threads to be used -- allows for metric to be used with standard thread.



### 434

Metric M9 to standard 11/32" threads.

### 436

Metric M9 to Metric M8 threads.

## CORRUGATED PILOT TUBING

Dormont corrugated, stainless steel pilot tube. 1/4" O.D.



Model #	Length
654	18"
655	24"
649	36"
656	48"
651	60"
652	72"



## ACCESSORIES



### STEM EXTENSION - 101

4" Extension



### KNOB - 111

Pad Printed



### SAFETY PILOT HEAT SHIELDS

122 - For 70 Series Kits

140 - For 80 Series Kits

140-L - For 90 Series Kits

# SAFETY PILOT KITS (CONTINUED)

Let us assemble the kit tailored for your business needs– you choose valve / pilot assembly, fittings, heat shield, etc. We assemble & package with your assigned part #- all in one box!

## Safety Pilot Kits Reference Chart

Model	Btu	Kit		Ignition	Manual Flame Modulating	Valve			For Burner Thread Type		Pilot Type	
		Quick Mount	Fully Assembled			Match Lit	Rear Inlet	Side Inlet	Low Profile	LP Conv. Kit Option		3/8" ID/OD
70PKNHC	142k	Note 1		•	•	•	•				•	Standing
72PKN	90k			•	•	•	•				•	
72PKNQM		•			•							
172UPK					•							
80PKN	90k			•	•	•	•				•	
80PKNQM		•			•							
81PKNQM	90k	•		•	•	•	•				•	
182UPK (NG & LP)	90k			•	•	•	•				•	
83PKN					•							
91PKN	90k			•	•	•	•				•	
91PKNQM		•			•							
SPK-85	90k		•	•	•	•	•				•	

Notes: 1) Quick Mount- Indicates swivel flare connector included with kit.



# MILLIVOLT KITS

Let us assemble the kit tailored for your needs – you choose valve / pilot assembly, fittings, heat shield, etc. We assemble and package with your assigned part number - All in one box! -For use with Remote Control, Wall Switch, or Timer

The millivolt valve provides a safe shutdown, in the event of an interruption in the gas supply or flameout. Offering the convenience of wall switch or remote control in conjunction with a standing pilot provides a safe means of lighting the main burner. On some of HPC's models the features can be controlled remotely allowing customers to adjust the flame height, as well as start up and shutdown the main burner. HPC offers numerous kit configurations providing install flexibility and convenience.

**Benefits: Remote Control or Wall Switch capability, flame height control models, Manual or Thermostatic response, Flame Sensed, Simple main burner ignition.**

## About Our Kits

- Most kits may be installed on right or left side of fireplace.
- All Kits may be installed standing up or laying down.
- Our kits provide all the fittings that should be needed for almost all installations on any of the three "standard" types of gas log sets.
- One or two stainless steel flex lines in all kits.



## MVK-N, MVK-P - Flex Line Connection

Millivolt valve kit with flex line connection to main burner. Uses Dexen gas valve, 85k Btu that may be controlled with a wall switch, remote control or timer.

### Kit Includes:

- Dexen 6003 Series Valve (#200-D or #201-D for LP), 85k Btu.
- 18" Pilot Assembly with mounting bracket.
- 10" Black Stainless Steel Flex Lines (2).
- Insulated Heat Shield with On/Off switch on front.
- 225° High Limit Switch on valve.
- Assorted fittings for various burner threads.
- MVK-P for LP Gas- also includes Air Mixer / Orifice, Vermiculite and LP pilot orifice.
- OPTIONAL Remote Control: Compatible with RCK-I, RCK-K, RCK-B and RCK-D- see our Remote Controls on Pg. 84

## MILLIVOLT KITS (CONTINUED)

Let us assemble the kit tailored for your needs — you choose valve / pilot assembly, fittings, heat shield, etc. We assemble and package with your assigned part number - All in one box! -For use with Remote Control, Wall Switch, or Timer



### MVK-NQM, MVK-PQM - 3" Swivel Flare Connection

Millivolt valve kit with 3" Swivel Flare connection to main burner. Uses Dexen gas valve, 85k Btu that may be controlled with a wall switch, remote control or timer.

#### Kit Includes:

- Dexen 6003 Series Valve (#200-D or #201-D for LP), 85k Btu.
- 18" Pilot Assembly with mounting bracket.
- 3" Swivel Connector for easy valve / burner connection.
- 10" Black Stainless Steel Flex Line.
- Insulated Heat Shield with On/Off switch on front.
- 225° High Limit Switch on valve.
- Assorted fittings for various burner threads.
- MVK-PQM for LP Gas- also includes Air Mixer / Orifice, Vermiculite and LP pilot orifice.
- OPTIONAL Remote Control: Compatible with RCK-I, RCK-K, RCK-B and RCK-D- see our Remote Controls on Pg. 84



### MVK-HC - High Capacity! 230k Btu

High Capacity Millivolt valve kit (Natural Gas) with flex line connection to ½" main burner. Uses White-Rodgers gas valve, 230k Btu that may be controlled with a wall switch, remote control or timer.

#### Kit Includes:

- White-Rodgers Valve (#210), 230k Btu.
- 18" Pilot Assembly with mounting bracket.
- 18" Stainless Steel Flex Lines, ½" (2).
- Insulated Heat Shield with On/Off switch on front.
- 225° High Limit Switch on valve.
- Assorted fittings for various burner threads.
- OPTIONAL Remote Control: Compatible with RCK-I, RCK-K, RCK-B and RCK-D- see our Remote Controls on Pg. 84

### MVK-HC36 - 36" Pilot Assembly

Same as the MVK-HC kit with a 36" Pilot Assembly.

## UMVK-NP - Universal Natural Gas or Liquid Propane

Universal Millivolt valve kit with flex line connection to main burner- for Natural Gas or LP. Uses Robert Shaw gas valve, 82k Btu that may be controlled with a wall switch, remote control or timer.

### Kit Includes:

- Robert Shaw 7000Series Valve (#202), 82k Btu.
- 18" Pilot Assembly with mounting bracket.
- 10" Black Stainless Steel Flex Lines (2).
- Insulated Heat Shield with On/Off switch on front.
- 225° High Limit Switch on valve.
- Air Mixer / Orifice, Vermiculite and LP pilot orifice.
- Assorted fittings for various burner threads.
- OPTIONAL Remote Control: Compatible with RCK-I, RCK-K, RCK-B and RCK-D- see our Remote Controls on Pg. 84



## FLAME MODULATING- MMVK SERIES

### MMVK-NQM, MMVK-PQM - Flame Modulating, 3" Swivel Flare Connection

Flame modulating Millivolt valve kit with 3" Swivel Flare connection to main burner. Uses Maxitrol gas valve, 85k Btu that may be controlled with a remote control.

### Kit Includes:

- Maxitrol Gas Valve (#247), 85k Btu, 175°.
- 18" Pilot Assembly with mounting bracket.
- 3" Swivel Connector for easy valve / burner connection.
- 10" Black Stainless Steel Flex Line.
- Insulated Heat Shield with On/Off switch on front.
- 225° High Limit Switch on valve.
- Assorted fittings for various burner threads.
- MMVK-PQM for LP Gas- also includes Air Mixer / Orifice, Vermiculite and LP pilot orifice.
- OPTIONAL Remote Control: Compatible with RCK-M model only- see our Remote Controls on Pg. 85



### MMVK-NQMSI, MMVK-PQMSI - Built-in Spark Igniter

Same as the MMVK-NQM & MMVK-PQM kits plus the added convenience of push-button spark igniter built into the valve.

### MVRC255 - Complete with Remote Control

This kit combines the MMVK-NQM kit with the RCK-M remote control on Pg. 85

### MVRC255P - Complete with Remote Control

Same as the MVRC255 kit but for Liquid Propane.

# MILLIVOLT KITS (CONTINUED)

Let us assemble the kit tailored for your needs – you choose valve / pilot assembly, fittings, heat shield, etc. We assemble and package with your assigned part number - All in one box! -For use with Remote Control, Wall Switch, or Timer

## REPLACEMENT VALVES

Robertshaw



### 202

- Convertible valve, for Natural or LP
- 225° rated valve
- Front Inlet Rear Outlet

DEXEN



### 200-D, 201-D

- 200-D For Natural gas
- 201-D For LP gas
- 225° rated valve
- Front Inlet Rear Outlet
- 6003 Series

White Rodgers



### 210

- 250° rated valve
- 230k Btu
- LP conversion kit included
- .750 VDC



### PCOA071, PCOA072

- PCOA071 for LP Gas
- PCOA072 for Natural Gas
- Hi/Lo Millivolt valve

DEXEN



### 200-K

- Dexen 6003-KN Variable Millivolt Nat. Gas Valve
- Hi-Low Regulator
- Quick Drop Out Safety Magnet-
- 1.7"-3.5" W.C., 3/8" Inlet
- 3/8" Outlet
- Front Inlet Rear Outlet



DEXEN

### 200-KS, 201-KS

- Dexen 6003KS Series
- High / Low manual setting
- Front- Inlet, Rear-Outlet
- Multi-Tap with 11/32 magnet
- 200-KS for Natural Gas
- 201-KS for Liquid Propane

## MILLIVOLT VALVE CONVERSION



### 217LP, 217N, 216

- 217LP Converts 200 series Dexen and Robertshaw valves from Natural gas to LP gas
- 217N from LP gas to Natural Gas
- 216 Converts 200 series Dexen and Robertshaw valves from regulated to unregulated.



### 215, 215L

- 215 for Natural Gas
- 215L For LP Gas
- Converts S.I.T Nova 820 valve to Hi/Lo capabilities for Natural Gas



### 223

- Converts S.I.T Nova 820 valve to Manual Hi/Lo capabilities for Natural gas.

# ODS PILOT ASSEMBLIES - VENT FREE

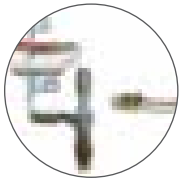

**69222**

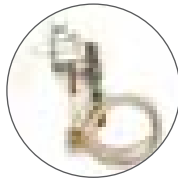

**69224**



**73020 AND 73037**

Model	Gas	Description	Thermopile
69222	NG	Manual ODS; Male Threads	No
69224	LP	Manual ODS; Male Threads	No
73020	NG	Millivolt ODS; Male Threads	Yes
73037	LP	Millivolt ODS; Male Threads	Yes

## MILLIVOLT THERMOPILES



### THERMOCOUPLE THREAD ADAPTORS

These adaptors allow for valve / thermocouple of different type threads to be used– allows for metric to be used with standard thread.

Two Types:

434: Metric M9 to Standard 11/32" threads.

436: Metric M9 to Metric M8 threads.

Model #	Description
434	Metric M9 to Standard 11/32" threads.
436	Metric M9 to Metric M8 threads.
293	High Limit Switch 175°, normally closed
211	High Limit Switch 210°, normally closed
212	On/Off Switch

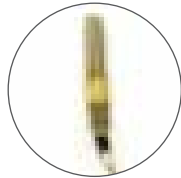

Model	Length	Description
113	18"	Robertshaw - fits MVK-N & P Series
255	36"	Robertshaw - fits MVK-N & P Series
114	48"	Robertshaw - fits MVK-N & P Series

*Robertshaw*

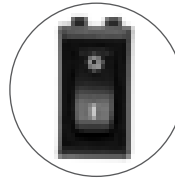

**212**

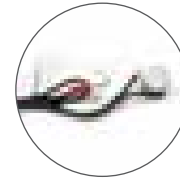

**293 & 211**

## CORRUGATED PILOT TUBE



Dormont corrugated, stainless steel pilot tube 1/4" O.D.

*Dormont*

Model	Length	Model	Length
654	18"	656	48"
655	24"	651	60"
649	36"	652	72"

## MILLIVOLT PILOT ASSEMBLIES

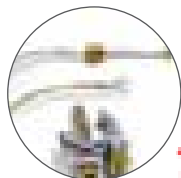

**203 & 204**

*Robertshaw*

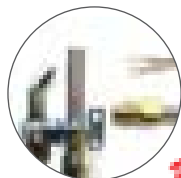

**219**

*Robertshaw*

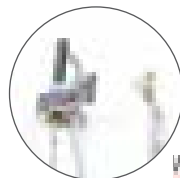

**103**

*White-Rodgers*

Model	Gas	Description
203	NG	18" Length; Robertshaw
204	LP	18" Length; Robertshaw
219N	NG	36" Length
219P	LP	36" Length
103	NG	36" Length; White-Rodgers



**120**

Pilot assembly bracket- this bracket allows for mounting the pilot assembly to the burner pan by simply sliding bracket onto the edge of the pan. Works for most safety pilot and millivolt pilot assemblies. Measures 1.75" x 1.75".

# MILLIVOLT KITS (CONTINUED)

Let us assemble the kit tailored for your needs – you choose valve / pilot assembly, fittings, heat shield, etc. We assemble and package with your assigned part number - All in one box! -For use with Remote Control, Wall Switch, or Timer

## Millivolt Valve Kits Reference Chart

Model	Btu	Quick Mount		Match		Ignition		Flame Modulating	Use with Optional Remote		Valve		For Burner Thread Type		Pilot Type		
		Mount	Lit	Manual Ignition	Electronic Ignition	Battery Receiver	120V Receiver		Nat.	LP	3/8" ID/OD	1/2" OD					
MVK-HC	230k	Note 1								RCK-I RCK-K	RCK-B, RCK-D						
MVK-N	85k																
MVK-P																	
MVK-NQM																	
MVK-PQM																	
UMVK-NP	82K																
MMVK-NQM	85k																
MMVK-PQM																	
MMVK-NQMSI																	
MMVK-PQMSI																	

**Notes:** 1) Quick Mount- Indicates swivel flare connector included with kit.

# ELECTRONIC IGNITION KITS

The Electronic Ignition system provides a safe shutdown in the event of an interruption in the gas supply or flameout. Offering the convenience of wall switch or remote control in conjunction with an interrupted pilot (IPI) provides a safe means of lighting the main burner. The electronic ignition system is energy efficient. HPC offers numerous kit configurations providing install flexibility and convenient use.

**Benefits: Remote Control or Wall Switch capability, Manual or Thermostatic response, Flame Sensed, No Standing Pilot, Simple main burner ignition.**



## **MVK-EI - 82k Btu, Battery Powered, Flex Line Connection**

Electronic Ignition valve kit with flex line connection to main burner. This kit is battery operated in the event of power outage- Optional 120Vac adaptor available. Complete electronic ignition kit uses Dexen EI gas valve, 82k Btu that may be controlled with a wall switch, remote control or timer.

### **Kit Includes:**

- Dexen Electronic Ignition Valve (#350), 82k Btu.
- Electronic Ignition Control Module (#350-M)
- 24" IPI Pilot Assembly with mounting bracket; (Optional 36", 48" & 60" Pilot Assemblies- Pg.81)
- 10" Black Stainless Steel Flex Lines (2).
- Battery Pack with two D-Cell batteries and Wiring Harness (Optional 120vac Power Adaptor- Pg.81)
- Insulated Heat Shield for Module / Battery Pack with On/Off switch on front.
- Insulated Heat Shield for gas valve.
- 175° High Limit Switch on valve.
- Assorted fittings for various burner threads.
- LP applications use the EILPK kit
- OPTIONAL Remote Control: Compatible with RCK-I Series (On/Off) or RCK-K Series (Thermostatic)- see our Remote Controls on Pg. 84

# ELECTRONIC IGNITION KITS (CONTINUED)

**Honeywell**



## MVK-EIMC-1 - 150k Btu, 24 Volts, Flex Line Connection

Electronic Ignition valve kit with flex line connection to main burner. This system operates at 24 Volts- step-down transformer and 120v power cord included. Complete electronic ignition kit uses Honeywell EI gas valve, 150k Btu that may be controlled with a wall switch, remote control or timer.

### Kit Includes:

- Honeywell Electronic Ignition Valve (#210-EI), 150k Btu.
- Electronic Ignition Control Module (#210-EI MOD)
- 36" IPI Pilot Assembly with mounting bracket. (For longer assemblies see Pg.82)
- 24" Stainless Steel Flex Lines (2).
- 24VAC Transformer & 6 ft. Power Cord
- Insulated Heat Shield for Module with On/Off switch on front.
- Insulated Heat Shield for gas valve.
- Assorted fittings for various burner threads.
- LP applications use the #577-A kit- See Pg. 82
- OPTIONAL Remote Control: Compatible with RCK-I Series (On/Off) or RCK-K Series (Thermostatic)- see our Remote Controls on Pg. 84

## MVK-EIHC-1 - 270k Btu, 24 Volts, Flex Line Connection

Same as the MVK-EIMC-1 kit with a 270k High Capacity Honeywell EI Valve (#210-EIHC).

## MVK-EIHC415-1 - 415k Btu, 24 Volts, Flex Line Connection

Same as the MVK-EIMC-1 kit with a 415k High Capacity Honeywell EI Valve (#210-EIHC415).

# Electronic Ignition Kits Reference Chart

Model	Btu	Ignition			Use with Optional Remote		Valve		For Burner Thread Type			Pilot Type
		Manual Ignition	Electronic Ignition	Flame Modulating	Battery Receiver	120V Receiver	Nat. Gas	LP Gas	3/8" ID/OD	1/2" OD	3/4" OD	
MVK-EI	82k		• Battery		RCK-I, RCK-K	RCK-B, RCK-D	•		•	•		•
MVK-EIMC-1	150K		• 120vac/ 24vac				•	Note 1		•		•
MVK-EIHC-1	270K						•		•			•
MVK-EIHC415-1	415K						•					•

1) LP Conversion Kits: MVK-EI: Use part # EILPK; MVK-EIMC-1, MVK-EIHC-1: Use part # 577-A.

2) IPI Pilot- Indicates Intermittent Pilot Ignition- pilot only on when main burner is on.



# ELECTRONIC IGNITION REPAIR PARTS

## DEXEN ELECTRONIC IGNITION - ON/OFF SYSTEM

- 350-P** 24" Pilot Assembly Flame Sensor, Igniter
- 350-P36** 36" Pilot Assembly Flame Sensor, Igniter
- 350-P48** 48" Pilot Assembly Flame Sensor, Igniter
- 350-P60** 60" Pilot Assembly Flame Sensor, Igniter
- 350-BP** Battery Pack

- 350-H** Wire Harness
- 350-M** Control Module
- 351** AC Wall Power Adapter
- 350** Dexen Repair Valve
- EILPK** Includes Air Mixer, Pilot Orifice, Vermiculite and Fittings
- 203-DEXLP** Dexen EI Pilot Orifice



### Dexen 350 EI Valve

- Battery Powered Operation
- 82k Btu valve
- 175° rated.
- 6003 3V Series

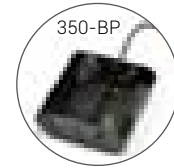
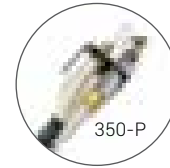

## DEXEN ELECTRONIC IGNITION - MODULATING SYSTEM



### DEXEN MODULATING VALVE

- 6V Electronic Ignition
- M6003V Modulating Gas Valve
- 352NG** - NG 1.5"-3.8" Valve
- 352LP** - LP 1.4.5"-10" Valve



### DEXEN MODULE

- For DEXEN 6V EI Modulating Gas Valve
- 352-M** - 6003V 8K Module



### DEXEN PILOT

- 24" Pilot Assembly (Modulating System Only)
- 352-P/LP** - LP
- 352-P/NG** - NG

# ELECTRONIC IGNITION REPAIR PARTS *(CONTINUED)*



## DEXEN ADAPTER

6v DC Adapter  
**352-ADAPT**

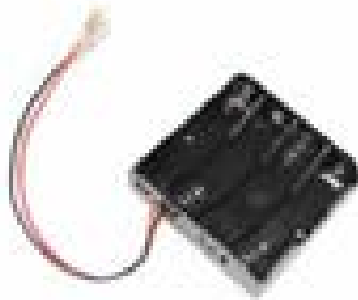

## DEXEN BATTERY PACK

6003V Battery Pack 4-AA  
**352-BP**



## DEXEN WIRE HARNESS

6003V 8K Wire Harness  
**352-H**



## DEXEN REMOTE

6003V RFC Remote Control-No Logo  
**352-REMOTE**



## HONEYWELL COMPONENTS

### HONEYWELL EI VALVES

- No standing pilot
- 24 volt system
- Non-adjustable

**210-EI** 150k Btu  
**210-EIHC** 270k Btu  
**210-EI415** 415k Btu

### 210-EI MOD

- Honeywell Electronic Ignition control module
- 90 second lock out
- 24 volt system



### 576-40VA TRANSFORMER

- 24VAC output transformer-
- 120Vac or 250Vac input voltage,
- 40VA power rating



**Honeywell**



### EI Pilot Assembly - Honeywell

Model #	Gas	Description
115PILOT-3	NG	36" EI Pilot Assembly - Honeywell EI
115PILOT-4	NG	48" EI Pilot Assembly - Honeywell EI
115PILOT-6	NG	72" EI Pilot Assembly - Honeywell EI
<b>577-A</b>	<b>LP</b>	LP Conversion Kit - Honeywell EI

# REMOTE CONTROL KITS

## PRIVATE LABEL PROGRAM - FREE!

Let us print your company name and logo on labels for hand held remotes!  
Available on RCK-B, RCK-D, RCK-I, RCK-K, and RCK-M models

# PRIVATE LABEL PROGRAM - FREE!

Let us print your company name and logo on labels for hand held remotes!  
Available on RCK-B, RCK-D, RCK-I, RCK-K, and RCK-M models



### Details:

Email us your logo at [orders@hpcfire.com](mailto:orders@hpcfire.com)  
We generate a sample for approval  
Four weeks after approval we send your labels to you!  
Free if applied to remotes by customer. \$0.75 if HPC applies to remotes.

## EXAMPLES:



- Color:
- Black
  - Fluoresc (288) C (Blue)
  - Fluoresc (371) G (Green)

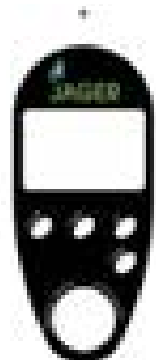

- Color:
- Fluoresc 288C
  - Fluoresc 430C
  - White



# REMOTE CONTROL KITS (CONTINUED)

PRIVATE LABEL PROGRAM - FREE!

Let us print your company name and logo on labels for hand held remotes!  
Available on RCK-B, RCK-D, RCK-I, RCK-K, and RCK-M models

## REMOTE CONTROL KITS - BATTERY POWERED

### ON/OFF REMOTES

#### RCK-I

- Manual On/Off
- Backlit LCD
- Displays Room Temperature
- Insulated Heat Shield
- 400° High temp wires
- Overheat protection switch
- Self-matching receiver to transmitter
- Child Proof Switch
- Easy Access battery drawer

#### RCK-IS

- Same as RCK-I, but without heat shield

#### RCK-IW

- Same as RCK-I, but without 9' valve wires for in-wall installation. Without heat shield



### THERMOSTATIC / TIMER CONTROL REMOTES

#### RCK-K

- Manual & Thermostat On/Off
- Celsius/Fahrenheit
- Insulated Heat Shield
- Overheat protection built into receiver
- 400° High temp wires already installed
- Easy access battery drawer
- Backlit LCD with clock & temp readout
- Child Proof
- Low Battery Indicator
- Room Temp Set Point
- Countdown Timer
- Self Matching receiver to transmitter

#### RCK-KS

- Same as RCK-K, but without heat shield.

#### RCK-KW

- Same as RCK-K, but with 9' valve wires for in wall installations. Without heat shield.

## REMOTE CONTROL KITS - 120 VOLT POWERED

### THERMOSTATIC/TIMER REMOTES

#### RCK-D

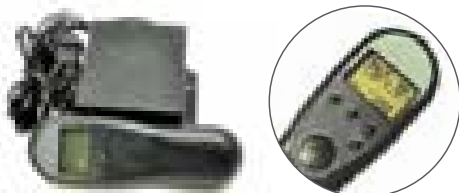

- Manual Thermostat On/Off
- Countdown Timer
- Backlit LCD
- Clock
- Child Proof
- Celsius/Fahrenheit
- Low Battery Indicator
- Insulated Head Shield
- Room Temp Set Point
- 120 VAC

### ON/OFF REMOTES

#### RCK-B

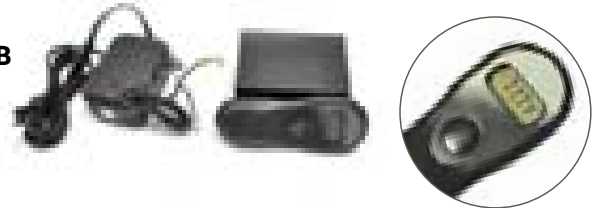

- Manual On/Off
- Child Proof
- Backlit LCD showing Room Temperature
- Insulated Heat Shield
- 120 VAC

# REMOTE CONTROL KITS - FLAME MODULATION

## USED WITH MMVK-NQM, MMVK-PQM AND MVRC255 ONLY - PAGE 16

### RCK-M

- Manual On/Off, modulating flame, remote control for use with our MMVK series kits, or kits from other manufacturers that use the Maxitrol GV34 valve.

Room Temperature is displayed on the LCD window of the transmitter. Use this as your guide to adjusting the flame up or down.

- Radio frequency signal for more control flexibility.
- Low battery indicator.
- Switch on the receiver allows flame adjustment from here if transmitter is disabled or out of reach
- Self matching receiver for easier frequency match up.
- Has insulated heat shield for receiver and 160° over heat shutdown to prevent damage to the receiver if it gets too hot.
- All required high temp (400°) wiring and batteries are included.
- Childproof lockout mode.



## ULTRASONIC REMOTE CONTROL KITS

### TRX-11

#### On/Off Ultrasonic Remote Control

For use in areas where there is heavy, high powered R/F interference or to prevent unwanted control of another fireplace/log set in another room.



### TRX-25

#### Thermostatic Ultrasonic Remote Control

For use in areas where there is heavy, high powered R/F interference or to prevent unwanted control of another fireplace/log set in another room.

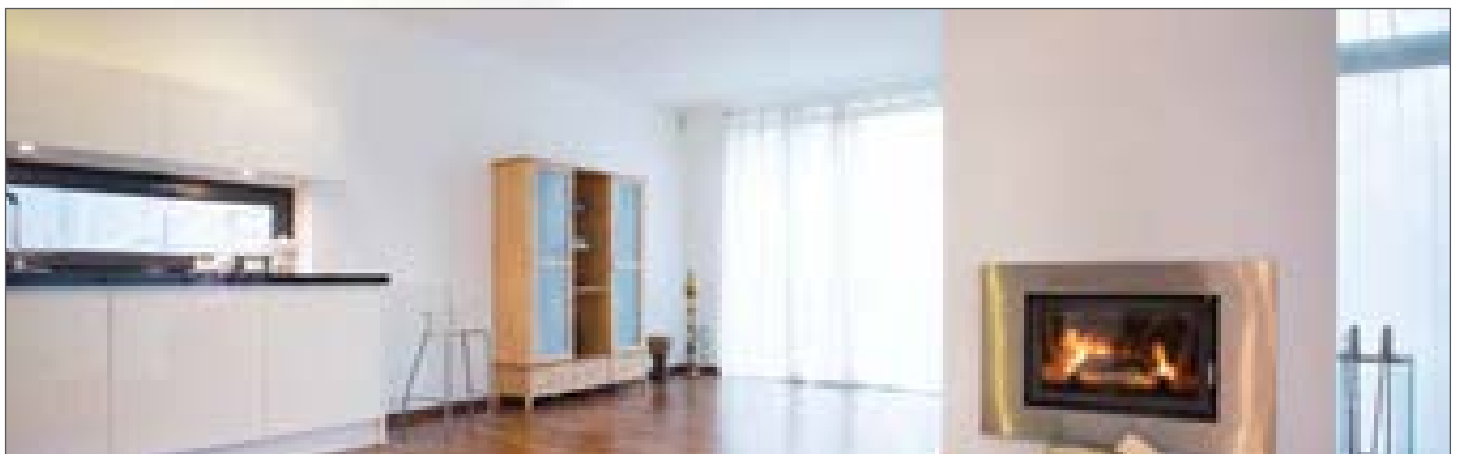

## REMOTE CONTROL KITS *(CONTINUED)*

PRIVATE LABEL PROGRAM - FREE!

Let us print your company name and logo on labels for hand held remotes!  
Available on RCK-B, RCK-D, RCK-I, RCK-K, and RCK-M models

---

## ON/OFF SWITCHES

---

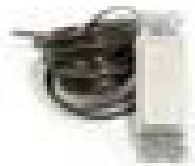

### WOOSK

White decorator Rocker on/off switch with wall plate. For use with any millivolt valve. Includes 25' of wire and connectors to fit onto any millivolt valve

---

## REPLACEMENT COMPONENTS

---



### 242

RCK-I / RCK-K Heat Shield

## MANUAL VALVE KITS

---

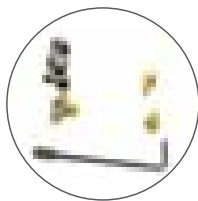

### C65

Designed to be mounted to the burner pan or the pipe stub. Fits all standard type burner pans having 1/2 or, 3/8" inlet on the end of the burner tube. Includes 7" black "L" stem. **(90K Btu NG)**

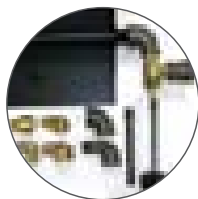

### C66U

Designed to be mounted to the burner pan or the pipe stub. Fits pans with 1/2" or 3/8" inlet. Includes two stem extensions and red printed knob. **(90K Btu NG)**

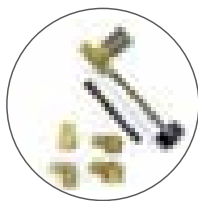

### C66

Designed to be mounted to the 1/2" pipe stub bringing gas into the fireplace. **(90K Btu NG)**

---

# DECORATIVE KEY VALVES

**Key Valve Part Numbers:** Key Valves are numbered as either Angled or Straight, and based off of color. For example, MAFB is described as Manual Angled Flat Black. MSFB would be Manual Straight Flat Black.

## STANDARD CAPACITY VALVES (1/2")

Angle or straight manual ball valve with flange and key. 1/2" inlet and outlet. For floor or wall mounting.

Recommended for gas shut off of 150k Btu or less

## HIGH CAPACITY VALVES (3/4")

Angle or straight manual ball valve with flange and key. 3/4" inlet and outlet. For floor or wall mounting.

Recommended for gas shut off of 400k Btu or less

### CHROME FLANGE/ KEY

Valve	Inlet / Outlet	Models
Angle	1/2"	MACB
	3/4"	MACB-HC
Straight	1/2"	MSCB
	3/4"	MSCB-HC

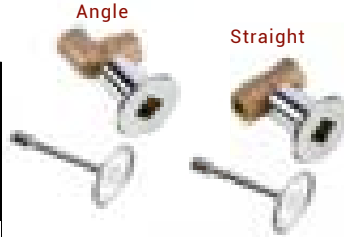

### BRASS FLANGE/ KEY

Valve	Inlet / Outlet	Models
Angle	1/2"	MABB
	3/4"	MABB-HC
Straight	1/2"	MSBB
	3/4"	MSBB-HC



### FLAT BLACK FLANGE/ KEY

Valve	Inlet / Outlet	Models
Angle	1/2"	MAFB
	3/4"	MAFB-HC
Straight	1/2"	MSFB
	3/4"	MSFB-HC



### PEWTER FLANGE/ KEY

Valve	Inlet / Outlet	Models
Angle	1/2"	MAPW
	3/4"	MAPW-HC
Straight	1/2"	MSPW
	3/4"	MSPW-HC



### ANTIQUE BRASS FLANGE/ KEY

Valve	Inlet / Outlet	Models
Angle	1/2"	MAAB
	3/4"	MAAB-HC
Straight	1/2"	MSAB
	3/4"	MSAB-HC

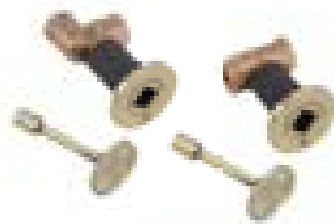

### ANTIQUE COPPER FLANGE/ KEY

Valve	Inlet / Outlet	Models
Angle	1/2"	MAAC
	3/4"	MAAC-HC
Straight	1/2"	MSAC
	3/4"	MSAC-HC

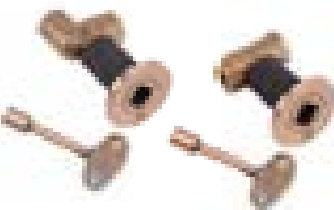

### FLANGE AND KEY ONLY

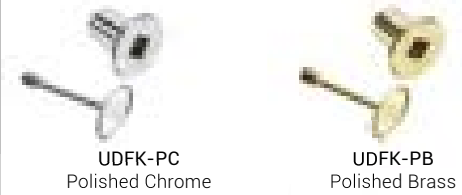
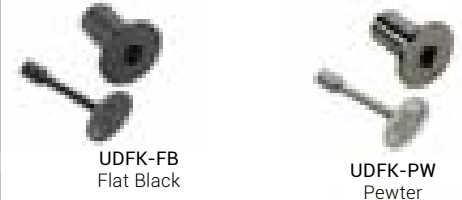
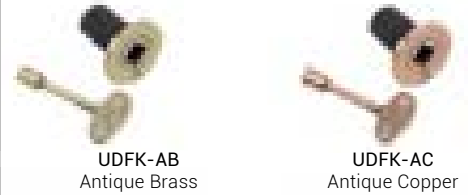

### KEYS



307-U 3"  
317-8B 8"  
317-12B 12"  
317-18B 18"  
317-24B 24"  
Polished Brass Keys



317-3UAC 3"  
317-8AC 8"  
Antique Copper Key



317-3UFB 3"  
317-8FB 8"  
Flat Black Key

### FLANGE ONLY

304 L Polished Chrome Flange  
306 L Polished Brass Flange

# MANUAL VALVE KITS (CONTINUED)

## REPLACEMENT VALVES

### 301-SL

Copreci  
Compact Design  
Side Inlet  
3/8 x 3/8 Ext.  
90K Btu NG

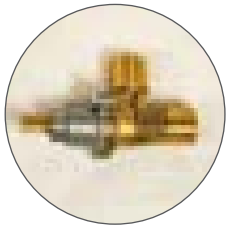

### 339

1/4 Turn Straight  
ball valve  
1/2" Inlet & Outlet  
150K Btu NG



### 339HC - High Capacity

1/4 Turn Straight  
ball valve  
3/4" Inlet & Outlet  
400K Btu NG

### 340

1/4 Turn Angle ball  
valve  
1/2" Inlet & Outlet  
150K Btu NG

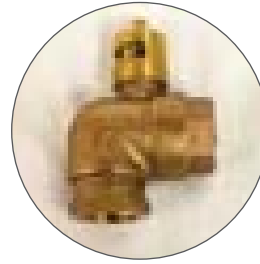

### 340HC - High Capacity

1/4 Turn Angle ball  
valve  
3/4" Inlet & Outlet  
400K Btu NG

### 228-LC

3/8 "flare x 1/2"  
FPT (110K Btu NG)



### 228

1/2" flare x 1/2" FPT  
(150K Btu NG)



### 226

1/2" x 1/2" FPT  
(150K Btu NG)



### 226-HC - High Capacity

3/4" x 3/4" FPK  
(270K Btu NG)



Model #	Description
301-SL	Angled Valve
338	Angled Valve
339	1/2" Straight Valve
340	1/2" Angled Valve
228-LC	3/8" Flare Ball Valve
228	1/2" Flare Ball Valve
226	1/2" Ball Valve
226-HC	3/4" Ball Valve
339HC	3/4" Straight Valve
340HC	3/4" Angled Valve

### 320

L-Shaped Stem  
Extension, 7" x 1/4"



### 321

Connection Collar  
for 320 L-Stem



## LOG LIGHTER BURNER KITS

### STAINLESS STEEL - NO VALVE

Includes - stainless steel burner tube,  
LP air mixer or NG orifice, connector and  
end cap, El. Can be connected together in  
sections.

Model #	Size in inches	Gas
SS17N	17"	NG
SS17P	17"	LP



### 671

PRIER Log Lighter 10" - Easy installation.  
- Cast Iron - 677 orifice  
- Multiple Inlets 672-17





# BURNERS AND PANS

## BURNER TUBES

Dual Burners are designed for indoor fireplace and are a great addition to the Stainless Steel Log Grates. Made with 304 stainless steel with the ends welded shut. To accompany the dual burners, we offer a burner pan in 304 stainless steel designed specifically for our dual burners, and suspends burner 3/4" above fireplace floor. Measures 18" x 8", ends are 2" high and allows for pilot assembly mounting. Fits all HPC dual burners.



Model #	Burner Size in inches
DSB-18 KIT	18x6
DSB-18LP KIT	18x6
DSB-24 KIT	24x6
DSB-24LP KIT	24x6
DSB-30 KIT	30x6
DSB-30LP KIT	30x6
DSB-36 KIT	36x6
DSB-36LP KIT	36x6
DSBP18	18x8x2 Pan



# STAINLESS STEEL FLEX LINES

Stainless steel flex lines are becoming more and more popular because they solve so many difficult installation problems and are so easy to use. Available bagged or un-bagged (standard size only for un-bagged) or with 1/2" On/Off valve already installed.

## FLEX LINE ONLY



## WITH ON/OFF VALVE



HPC offers Low Capacity, Standard Capacity, and Tranquil Whistle-Free Flex Lines—for High Capacity Flex Lines, please see the Outdoor Fire Effects section.

## LOW CAPACITY FLEX LINES

USD Products

All Low Capacity Flex Lines are 3/8"OD-1/4"ID, they come equipped with 1/2" female pipe threads on one end and 3/8" male pipe threads on the other.

Dormont

### FLEX LINE ONLY

Model #	Length
SSC-LC6	6"
SSC-LC12	12"
SSC-LC18	18"
SSC-LC24	24"
SSC-LC30	30"
SSC-LC36	36"
SSC-LC48	48"

### BLACK LOW CAPACITY

Model #	Length
SSCB-LC12	12"
SSCB-LC18	18"
SSCB-LC24	24"
SSCB-LC30	30"
SSCB-LC36	36"

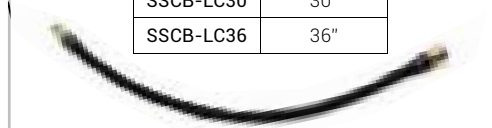

BLACK Flexible gas connectors are 3/8" OD-1/4"ID with 1/2" female pipe threads on one end and 3/8" male pipe threads on the other. Each black flexible gas connector is polymer coated and will resist blistering in the heat of the fireplace.



# STANDARD CAPACITY FLEX LINE

All Standard Capacity Flex Lines are 1/2" OD - 3/8"ID with 1/2" female pipe threads on one end and 3/8" male pipe threads on the other.

## FLEX LINE ONLY

Model #	Length
SSC6	6"
SSC12	12"
SSC18	18"
SSC24	24"
SSC30	30"
SSC36	36"
SSC48	48"

## INDIVIDUALLY BAGGED

Model #	Length
SSC12B	12"
SSC18B	18"
SSC24B	24"
SSC30B	30"

## BLACK STAINLESS

Model #	Length
SSCB12	12"
SSCB18	18"
SSCB24	24"
SSCB30	30"

# TRANQUIL WHISTLE-FREE FLEX LINES

HPC has been a long time supplier of reliable, maintenance-free flex lines. HPC's Tranquil Flex Line Series made from stainless steel, eliminates nuisance whistling. Sizes are available in low and standard capacity in 18", 24", and 30" lengths.

## LOW CAPACITY 3/8" O.D, 1/4" I.D.

Model #	Length
SSC-WLC18	18"
SSC-WLC24	24"
SSC-WLC30	30"

## STANDARD CAPACITY 1/2" O.D, 3/8 I.D.

Model #	Length
SSC-W12	12"
SSC-W18	18"
SSC-W24	24"
SSC-W30	30"

## STANDARD CAPACITY BLACK 1/2" O.D, 3/8 I.D.

Model #	Length
SSCB-W18	18"
SSCB-W24	24"
SSCB-W30	30"

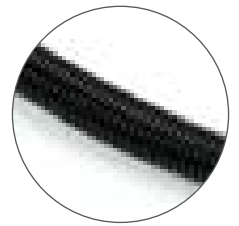

# HIGH CAPACITY FLEX LINES

All High Capacity Flex Lines are 5/8"OD – 1/2"ID, they come equipped with 1/2" female pipe threads on one end and 1/2" male pipe threads on the other.

Model #	Length	I/D
SSC-HC12	12"	1/2"
SSC-HC18	18"	1/2"
SSC-HC24	24"	1/2"
SSC-HC30	30"	1/2"
SSC-HHC24	24"	3/4"



## PLATINUM BRIGHT GLOWING EMBERS

### PUTTING THE GLOW INTO YOUR FIREPLACE



**Before Platinum Bright Embers**



**After Platinum Bright Embers**

#### Features and Benefits

- Visually Superior to Wool Embers
- Platinum coating facilitates more complete gas combustion creating a brighter ember and increased radiant heat output
- Constructed of catalytic grade ceramic
- Embers will not deteriorate when burned
- Reduces soot formed by fuel decomposition on conventional wool embers

Model #	Description
PB-5	5 grams of Platinum Bright Embers



# SPARK IGNITERS



## 690-AA

Mounts easily with 4 screws.  
Use with an external switch.  
Batteries easy to replace.  
AA battery  
Sealed battery Compartment  
Dual ignition outlets  
(Replaces #690)



## 691AA-HPC

Screw-in cap holds unit in place. Uses 1 AA battery. Sealed battery chamber. Easy Battery Replacement



## 130

Snap-in type  
One spark-per-push button



## 131

Electrode to use with 130, 691AA-HPC or 690-AA

## REGULATORS



**MAXITROL**

## 670

Maxitrol Regulator - Natural Gas  
1/2" x 1/2", set at 5.5" W.C. 4-8 adjustable.

## 670P

Maxitrol Regulator - LP Gas  
1/2" x 1/2", set at 10" W.C. 8-12 adjustable.

Model #	Gas	Description
690-AA	—	AA Spark Igniter
691 AA-HPC	—	AA Spark Igniter
130	—	Piezo Spark Generator
131	—	Spark Electrode
293	—	High Limit Switch 175°, normally closed
211	—	High Limit Switch 210°, normally closed
670	NG	Maxitrol Regulator
670P	LP	Maxitrol Regulator
73332	NG/LP	Universal Maxitrol Regulator
BSK	—	Temperature Switch

# FIREPLACE ENHANCEMENTS



## 842 VC5

Volcanic Cinders - A big 5lb. bag of real, black-colored, volcanic cinders.



## 845

Black Beauty Sand

## 841

White Silica Sand - Large 8lb. bag. Both look very nice in a fireplace.



## 840 GE5

Glowing Ember Material - darkest rock wool (5 oz. bag)



## 844 C4 KIT

Ceramic fiber coals - A nice sized bag of black ceramic fiber bits that look like coals when hot. (4 oz.)



## 125 VE8

Vermiculite - 8 oz bag of very course material.



## CERAMIC FIBER RIVER ROCK SERIES

FPR84MC Multi Color



FPR84BL Black

These imitation stones are light weight. Each set comes with a 84 piece assortment of large & small stones (large pieces—4 1/2", small pieces—2 1/2"). One set is 1/2 cu. ft. (15 lbs.)

## 857S & 857M - Black

Unique finish lava stone rolled smooth. Available in 1/2 cu ft. bags.



**Black**

Model #	Description
125 VE8	Vermiculite- 8oz
840 GE5	Glowing Embers- 5oz
841	White Silica Sand- 8lbs
842 VC5	Volcanic Cinders- 5lbs
843-WB5	Wood Bits
844 C4 Kit	Ceramic Fiber- 4oz
845	Black Sand- 8lbs
FPR84MC	Multi Color Ceramic River Rock
FPR84BL	Black Ceramic River Rock
857S	Rolled Lava Stone - Small 1-2" Black
857M	Rolled Lava Stone - Med. 2-4" Black
858S	Rolled Lava Stone - Small 1-2" Red
858M	Rolled Lava Stone - Med. 2-4" Red

# FITTINGS

## BRASS FITTINGS



Model #	Description	Tube (T)	Pipe (P)
400	90° Male Elbow	3/8"	3/8" MIP
401	90° Male Elbow	1/2"	3/8" MIP
402	90° Male Elbow	1/2"	1/2" MIP



405	90° F Elbow	3/8"	3/8" FIP
406	90° F Elbow	3/8"	1/2" FIP
407	90° F Elbow	1/2"	1/2" FIP
408	90° F Elbow	1/2"	3/8" FIP
451	90° F Elbow	3/4" MIP	15/16" FIP

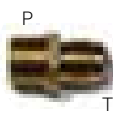

410	Male Connector	3/8"	3/8" MIP
411	Male Connector	1/2"	3/8" MIP
412	Male Connector	1/2"	1/2" MIP
462	Male Connector	3/8"	1/2" MIP



415	Full Union	1/2" Tube both ends	
416	Full Union	3/8" Tube both ends	
430	Reducing Union	3/8"-1/2" each end	



420	Adaptor	3/8"	3/8" FIP
421	Adaptor	3/8"	1/2" FIP
422	Adaptor	1/2"	3/8" FIP
423	Adaptor	1/2"	1/2" FIP



441	Adaptor- Pipe	3/8" FIP	3/8" MIP
442	Adaptor- Pipe	1/2" FIP	3/8" MIP
443	Adaptor- Pipe	1/2" FIP	1/2" MIP



450	Reducing Nipple	1/2" MIP	3/8" MIP
-----	-----------------	----------	----------



606	Flare Nut	3/8" Tube	
609	Flare Nut	1/2" Tube	



431	Compression Nut	1/4"	
432	Brass Sleeve	1/4"	
433	Male Breakaway Ferrule	1/4"	



425	1.5" Swivel Connector	3/8" flare both ends	
426	3.0" Swivel Connector	3/8" flare both ends	

## BLACK IRON FITTINGS

Model #	Description
500	1" Close Nipple 3/8" MPT
501	90° Elbow 3/8" FPT
502	90° Street EL 3/8" MPT x 3/8" FPT
503	Reducing Elbow 1/2" x 3/8" FPT
504	1 1/2" Nipple 3/8" MPT
505	Reducing Coupler 1/2" x 3/8" FPT
509	Coupler 3/8" FPT
510	3" Nipple 3/8" MPT
513	1/2" Cap
516	1/2" Close Nipple
524	Coupler 1/2" x 1/2" FPT
531	90° Street El 1/2" MPT x 1/2" FPT
532	1 1/2" Nipple 1/2" MPT

Model #	Description
533	2" Nipple 1/2" MPT
534	3" Nipple 1/2" MPT
535	4" Nipple 1/2" MPT
536	5" Nipple 1/2" MPT
537	6" Nipple 1/2" MPT
538	12" Nipple 1/2" MPT
539	18" Nipple 1/2" MPT
540	24" Nipple 1/2" MPT
547	30" Nipple
549	1/2" Elbow
551	3/8" FIP Cap
555	1/2" FIP Tee
557	1/2" FIP Cross





FIRE INSPIRED

**Inspired by safety.  
Innovated for your lifestyle.**